

Application Note

DA9061 / AtlasVI Power Connections

AN-PM-082

Abstract

This document describes the connectivity between the Dialog DA9061 Power Management Integrated Circuit (PMIC) and Qualcomm AtlasVI™ system processor.

DA9061 / AtlasVI Power Connections

Contents

Abstract	1
Contents	2
Figures	2
Tables	2
1 Terms and Definitions	3
2 References	3
3 Introduction	4
4 System Block Diagram	4
5 Timing Diagrams	6
5.1 Cold Boot	6
5.2 Power-Down.....	7
5.3 Power-Up	8
5.4 Software Initiated Power-Down.....	9
5.5 Watchdog Reset (No Freeze)	10
5.6 Watchdog Reset (With Freeze).....	11
5.7 Temperature Warning and Temperature Error	12
5.8 Temperature Power-On Reset.....	13
5.9 System Supply Under-Voltage	14
6 Software Driver	15
7 Development Support Tools and PMIC Configuration Files	15
8 Device Identification and Ordering	15
Revision History	16

Figures

Figure 1: DA9061 to AtlasVI Mapping	4
Figure 2: Timing Diagram for Cold Boot.....	6
Figure 3: Timing Diagram for Power-Down	7
Figure 4: Timing Diagram for Power-Up.....	8
Figure 5: Timing Diagram for a Software Initiated Power-Down	9
Figure 6: Timing Diagram for Watchdog Reset	10
Figure 7: Timing Diagram for Watchdog Reset Causing a Freeze	11
Figure 8: Timing Diagram for Temperature Warning and Temperature Error.....	12
Figure 9: Timing Diagram for Temperature Power-On Reset	13
Figure 10: Timing Diagram for System Supply Under-Voltage	14

Tables

Table 1: GPIO Mapping for AtlasVI	5
Table 2: Product Part Numbers	15

DA9061 / AtlasVI Power Connections

1 Terms and Definitions

GUI	Graphical User Interface
AtlasVI	Qualcomm SoC, formally known as CSR SiRFatlasVI™
SoC	System on a Chip
PMIC	Power Management Integrated Circuit

2 References

- [1] DA9061, Datasheet, Dialog Semiconductor
- [2] SiRFatlasVI, <http://www.csr.com/products/148/sirfatlasvi> [Accessed 14-Jul-2016]
- [3] DA9062, Datasheet, Dialog Semiconductor
- [4] The Linux Kernel Archives, <https://kernel.org/> [Accessed 13-Sep-2016]

DA9061 / AtlasVI Power Connections

3 Introduction

This document provides details of integrating the DA9061 with the AtlasVI SoC [2], suitable for low-end and mid-range infotainment applications. For high-end applications, integration of Dialog DA9062 [3] and Atlas7™ is recommended.

4 System Block Diagram

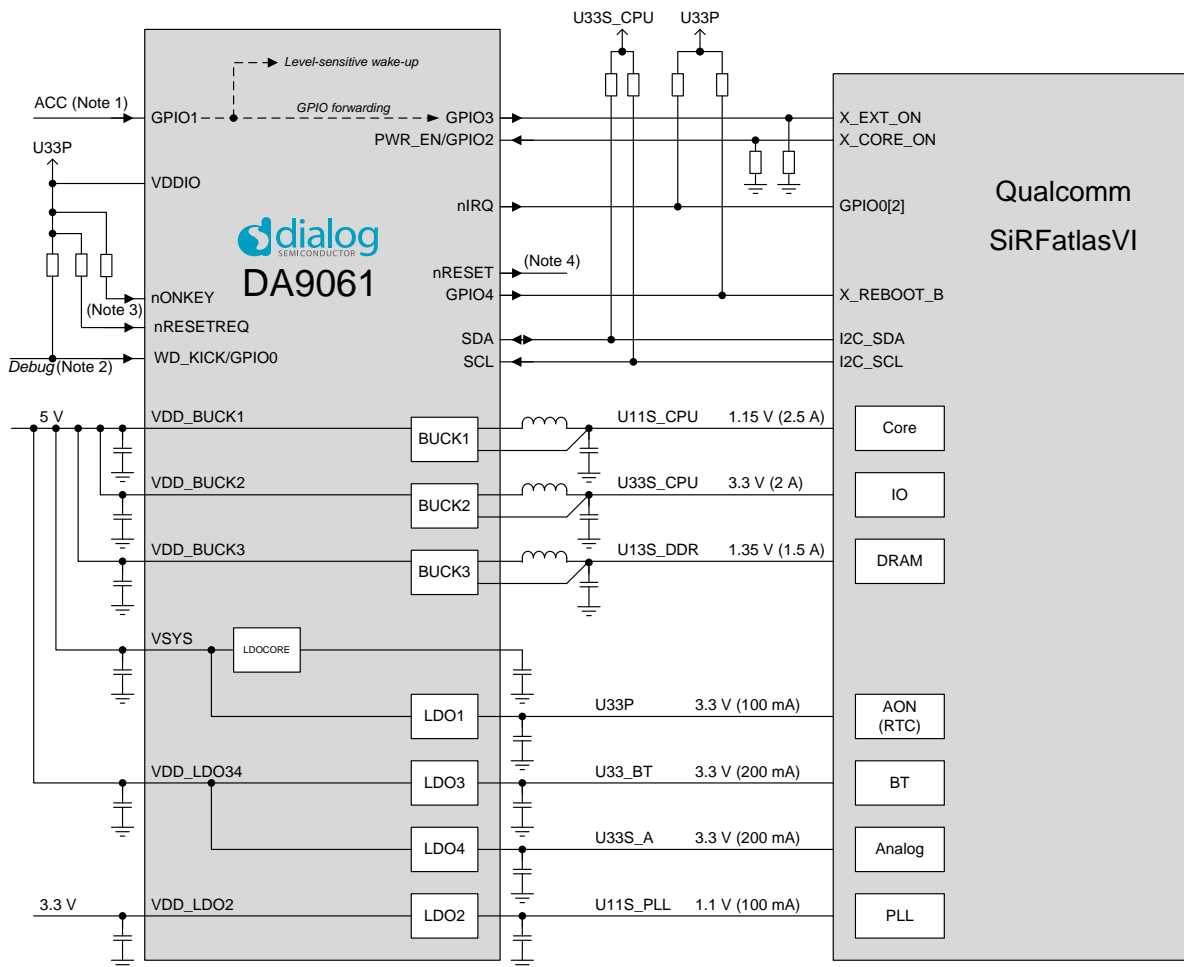

Figure 1: DA9061 to AtlasVI Mapping

- Note 1** The ACC GPIO1 signal is to be derived from the 12 V ACC (automotive) accessory line.
- Note 2** The WD_KICK/GPIO0 input requires a pulse every 2 s (as set by register control TWDSCALE). Alternatively, the input can be permanently asserted using the pull-up shown. This may be useful during application debugging.
- Note 3** nONKEY is not used. System start-up is initiated by ACC / GPIO1.
- Note 4** nRESET is not used.

DA9061 / AtlasVI Power Connections**Table 1: GPIO Mapping for AtlasVI**

GPIO	Function	Description
GPIO0	WD_KICK	Watchdog kick/disable
GPIO1	GPI	ACC in (derived from the 12 V ACC accessory line)
GPIO2	PWR_EN	Power enable
GPIO3	GPO push-pull (forwarded from GPIO1)	ACC out
GPIO4	GPO push-pull	Core reset for AtlasVI, controlled by the sequencer

DA9061 / AtlasVI Power Connections

5 Timing Diagrams

The numbered notes below each figure correspond to the numbered events within the figure.

5.1 Cold Boot

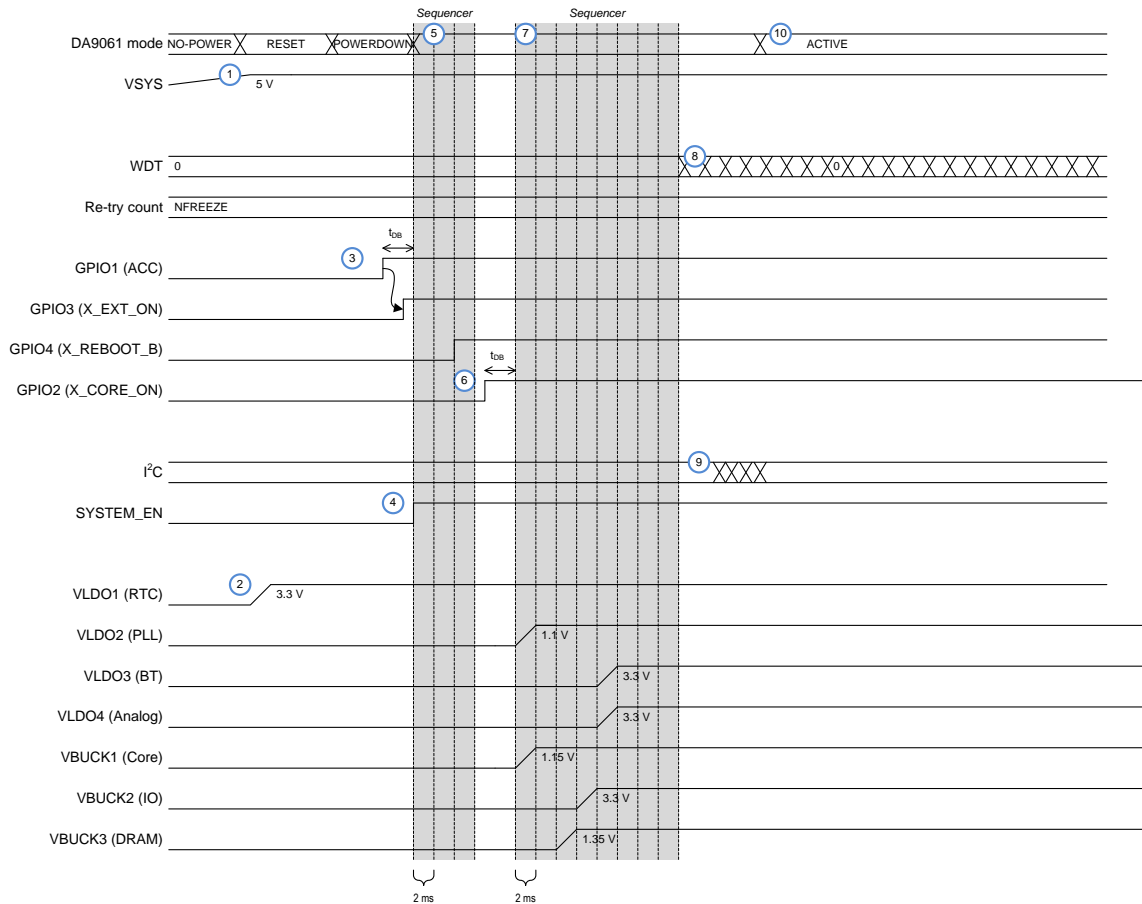

Figure 2: Timing Diagram for Cold Boot

1. The system supply rises above a threshold value after which the internal supplies of DA9061 are enabled and the device enters the RESET mode and then automatically proceeds to the POWERDOWN mode.
2. The always-on supply LDO1 is enabled in the RESET mode.
3. GPIO1 (ACC) is asserted (level-sensitive signal) which triggers a power-up sequence, and the signal is also forwarded to GPIO3 (X_EXT_ON). The delay between the rising edge of the GPIO1 (ACC) and the sequence starting is defined by the debouncing time t_{DB} .
4. A partial OTP read is executed at the beginning of the power-up sequence which asserts control SYSTEM_EN.
5. DA9061 executes the first part of the power-up sequence during which GPIO4 (X_REBOOT_B) is de-asserted.
6. AtlasVI asserts the X_CORE_ON signal which triggers the second part of the power-up sequence. The delay between the rising edge of the GPIO2/PWR_EN (X_CORE_ON) and the sequence starting is defined by the de-bouncing time t_{DB} .
7. DA9061 executes the second part of the power-up sequence during which the supplies are enabled in the programmed order. The time between the sequencer steps is 2 ms.
8. The watchdog starts running when the power-up sequence completes.
9. AtlasVI software performs the first watchdog kick through I²C.
10. DA9061 enters the ACTIVE mode.

DA9061 / AtlasVI Power Connections

5.2 Power-Down

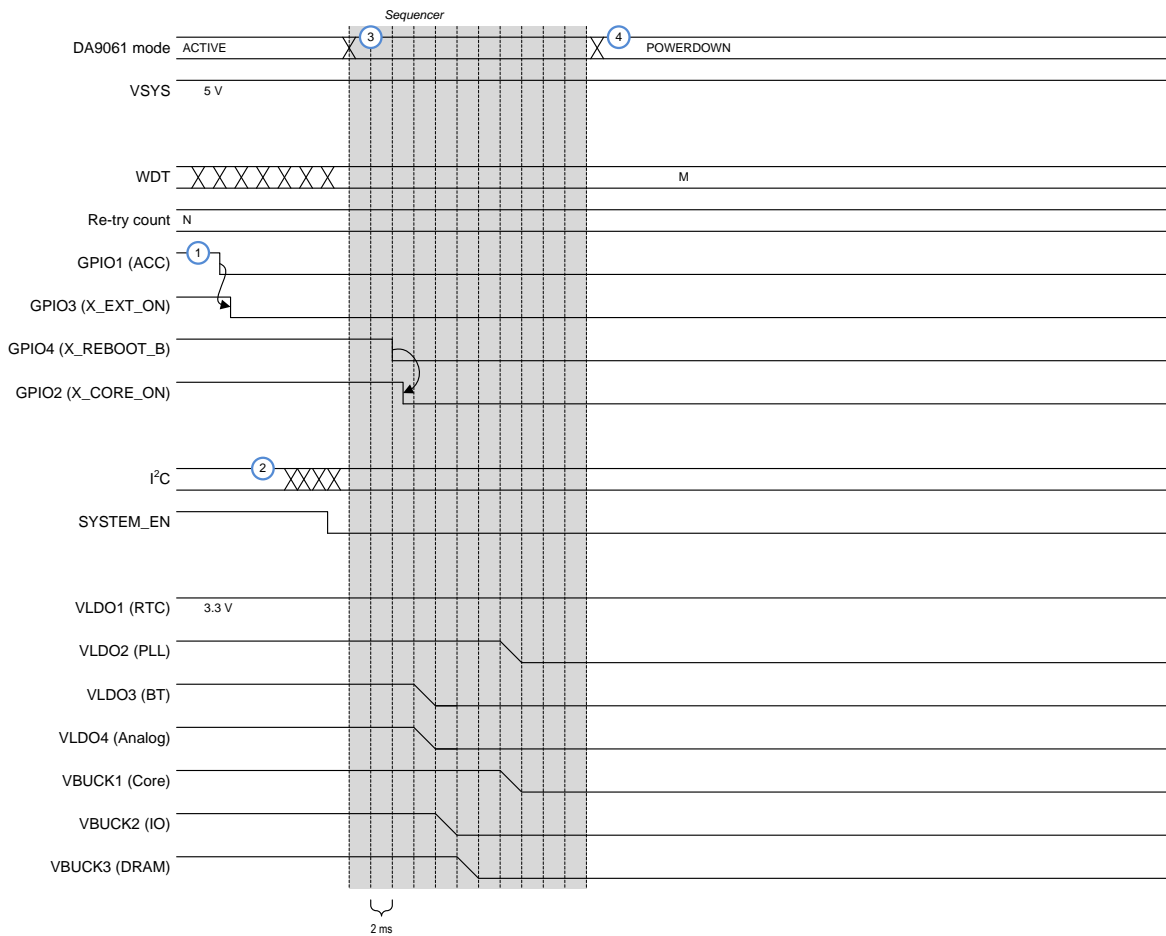

Figure 3: Timing Diagram for Power-Down

1. GPIO1 (ACC) is de-asserted and the signal is forwarded to GPIO3 (X_EXT_ON).
2. AtlasVI software sees the de-asserted X_EXT_ON and performs necessary preparations for power-down and then de-asserts control SYSTEM_EN through I²C.
3. DA9061 executes the power-down sequence during which GPIO4 (X_REBOOT_B) is asserted and supplies are disabled in the reverse order. X_CORE_ON is de-asserted asynchronously when GPIO4 (X_REBOOT_B) is asserted. The time between the sequencer steps is 2 ms, because the power-down was triggered by de-asserting control SYSTEM_EN, the sequencer proceeds directly to the POWERDOWN mode.
4. DA9061 completes the power-down sequence and enters the POWERDOWN mode. The watchdog is not counting in POWERDOWN mode.

DA9061 / AtlasVI Power Connections

5.3 Power-Up

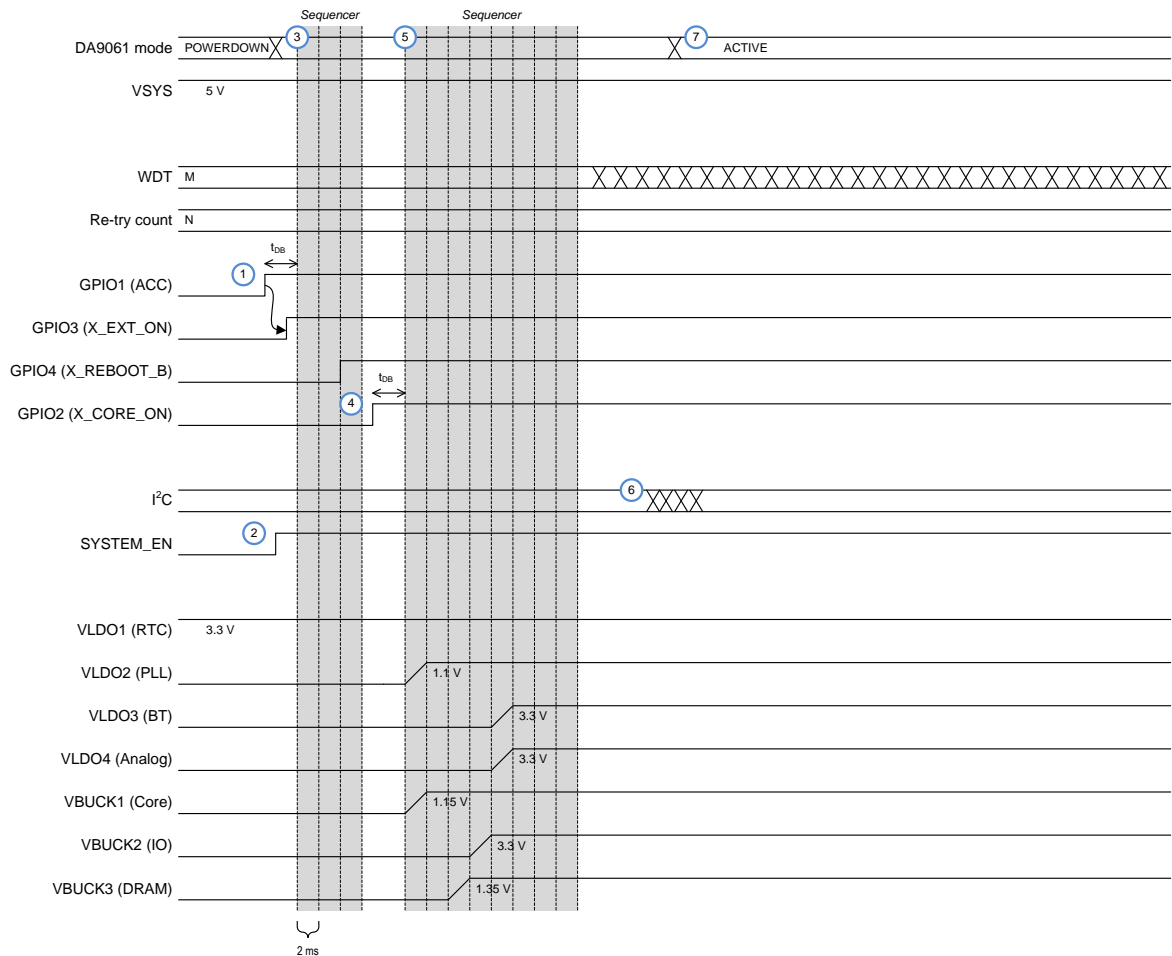

Figure 4: Timing Diagram for Power-Up

1. GPIO1 (ACC) is asserted (level-sensitive signal) which triggers a power-up sequence, and the signal is also forwarded to GPIO3 (X_EXT_ON). The delay between the rising edge of the GPIO1 (ACC) and the sequence starting is defined by the de-bouncing time t_{DB} .
2. A partial OTP read is executed at the beginning of the power-up sequence which asserts control SYSTEM_EN.
3. DA9061 executes the first part of the power-up sequence during which GPIO4 (X_REBOOT_B) is de-asserted.
4. AtlasVI asserts the X_CORE_ON signal which triggers the second part of the power-up sequence. The delay between the rising edge of the PWR_EN (X_CORE_ON) and the sequence starting is defined by the de-bouncing time t_{DB} .
5. DA9061 executes the second part of the power-up sequence during which the supplies are enabled in the programmed order. The timing between the sequencer steps is 2 ms.
6. AtlasVI software performs the first watchdog kick through I²C.
7. DA9061 enters the ACTIVE mode.

DA9061 / AtlasVI Power Connections

5.4 Software Initiated Power-Down

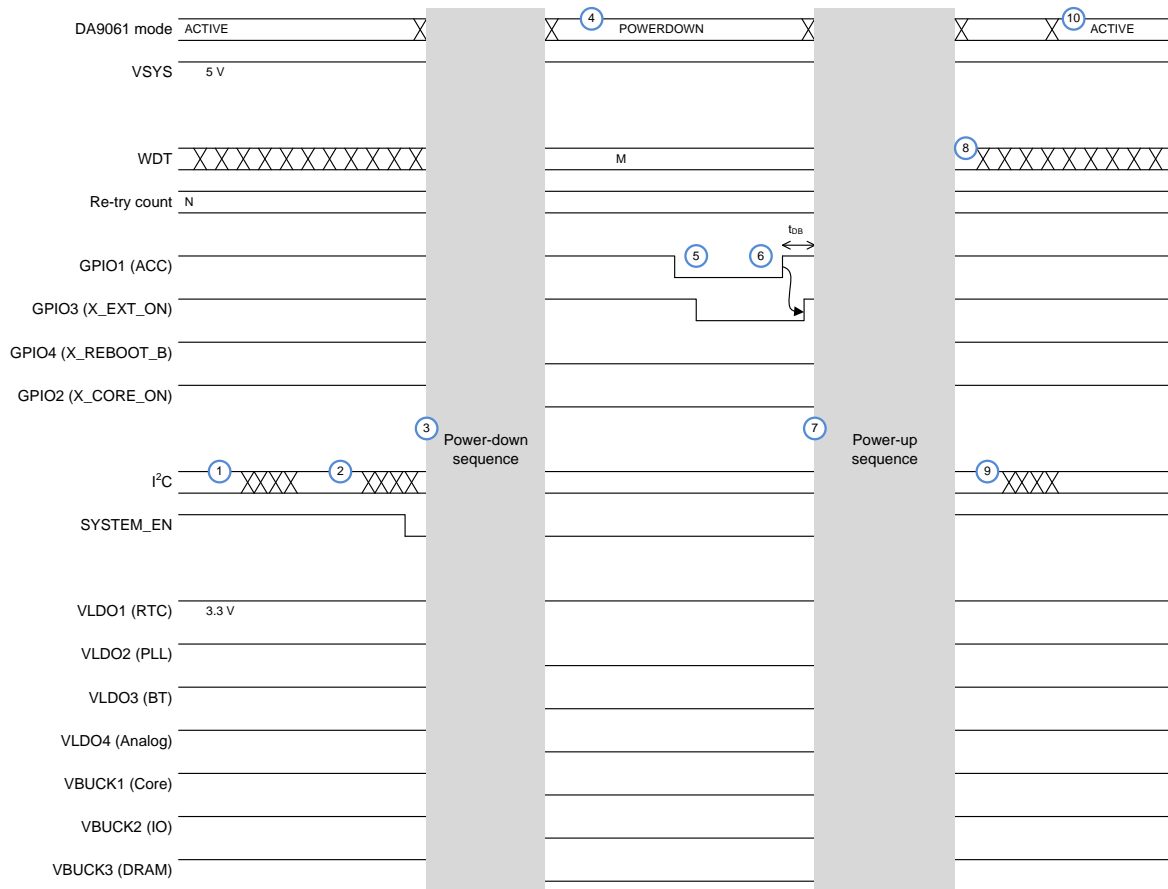

Figure 5: Timing Diagram for a Software Initiated Power-Down

1. AtlasVI software re-configures GPIO1 from level sensitive to edge sensitive.
2. AtlasVI software performs necessary preparations for a power-down and then de-asserts control SYSTEM_EN through I²C.
3. DA9061 executes the power-down sequence as described in Section 5.2.
4. DA9061 completes the power-down sequence and enters the POWERDOWN mode. The watchdog is not counting in POWERDOWN mode. Because GPIO1 (ACC) was re-configured as edge sensitive a power-up sequence is not triggered by the GPIO1 (ACC) level.
5. GPIO1 (ACC) is de-asserted.
6. GPIO1 (ACC) is asserted and the detected rising edge triggers a power-up sequence. The signal is also forwarded to GPIO3 (X_EXT_ON).
7. DA9061 executes the power-up sequence as described in Section 5.3. During the power-up sequence, an OTP read is executed that restores the GPIO1 (ACC) setting as level sensitive.
8. DA9061 completes the power-up sequence and the watchdog continues running.
9. AtlasVI software performs a watchdog kick through I²C.
10. DA9061 enters the ACTIVE mode.

DA9061 / AtlasVI Power Connections

5.5 Watchdog Reset (No Freeze)

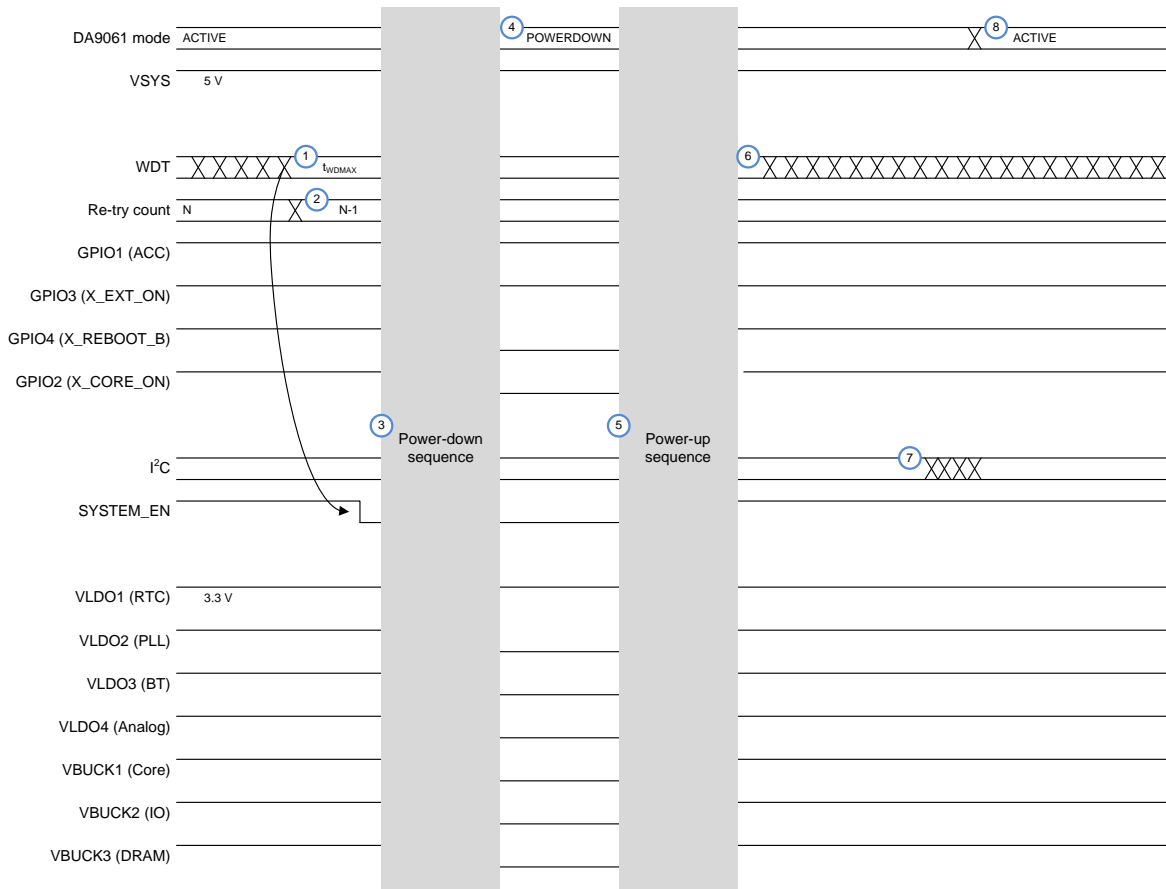

Figure 6: Timing Diagram for Watchdog Reset

1. The watchdog timer reaches its maximum value causing a watchdog error. This de-asserts control SYSTEM_EN which triggers a power-down sequence.
2. The re-try counter is decremented as a result of the watchdog error.
3. The sequencer executes the power-down sequence as described in Section 5.2
4. The power-down sequence is completed and DA9061 enters the POWERDOWN mode but because GPIO1 (ACC) remains asserted a new power-up sequence is immediately triggered.
5. DA9061 executes the power-up sequence as described in Section 5.3.
6. DA9061 completes the power-up sequence and the watchdog continues running.
7. AtlasVI software performs a watchdog kick through I²C.
8. DA9061 enters the ACTIVE mode.

DA9061 / AtlasVI Power Connections

5.6 Watchdog Reset (With Freeze)

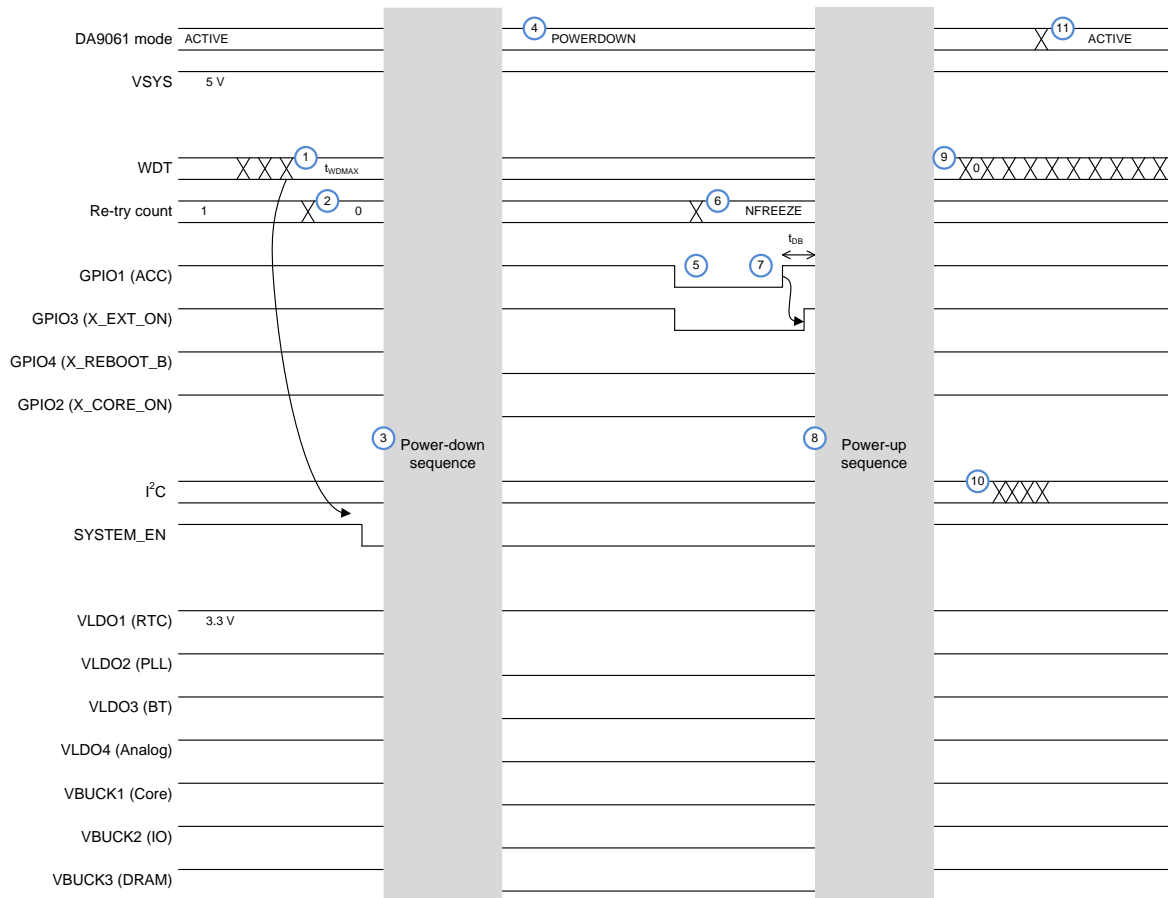

Figure 7: Timing Diagram for Watchdog Reset Causing a Freeze

1. The watchdog timer reaches its maximum value causing a watchdog error. This de-asserts control SYSTEM_EN which triggers a power-down sequence.
2. The re-try counter is decremented as a result of the watchdog error. This time, the re-try count reaches zero which causes the freeze function to be activated.
3. The sequencer executes the power-down sequence as described in Section 5.2.
4. The power-down sequence is completed and DA9061 enters the POWERDOWN mode. Because the freeze function is active, a power-up sequence is not triggered even though ACC remains asserted.
5. GPIO1 (ACC) is de-asserted.
6. As a result of the de-asserted level sensitive wakeup, the re-try counter is reset and the freeze function is de-activated.
7. GPIO1 (ACC) is re-asserted which triggers a power-up sequence, and the signal is also forwarded to GPIO3 (X_EXT_ON). The delay between the rising edge of the GPIO1 (ACC) and the sequence starting is defined by the de-bouncing time t_{DB} .
8. DA9061 executes the power-up sequence as described in Section 5.3.
9. DA9061 completes the power-up sequence and the watchdog continues running.
10. AtlasVI software performs a watchdog kick through I²C.
11. DA9061 enters the ACTIVE mode.

DA9061 / AtlasVI Power Connections

5.8 Temperature Power-On Reset

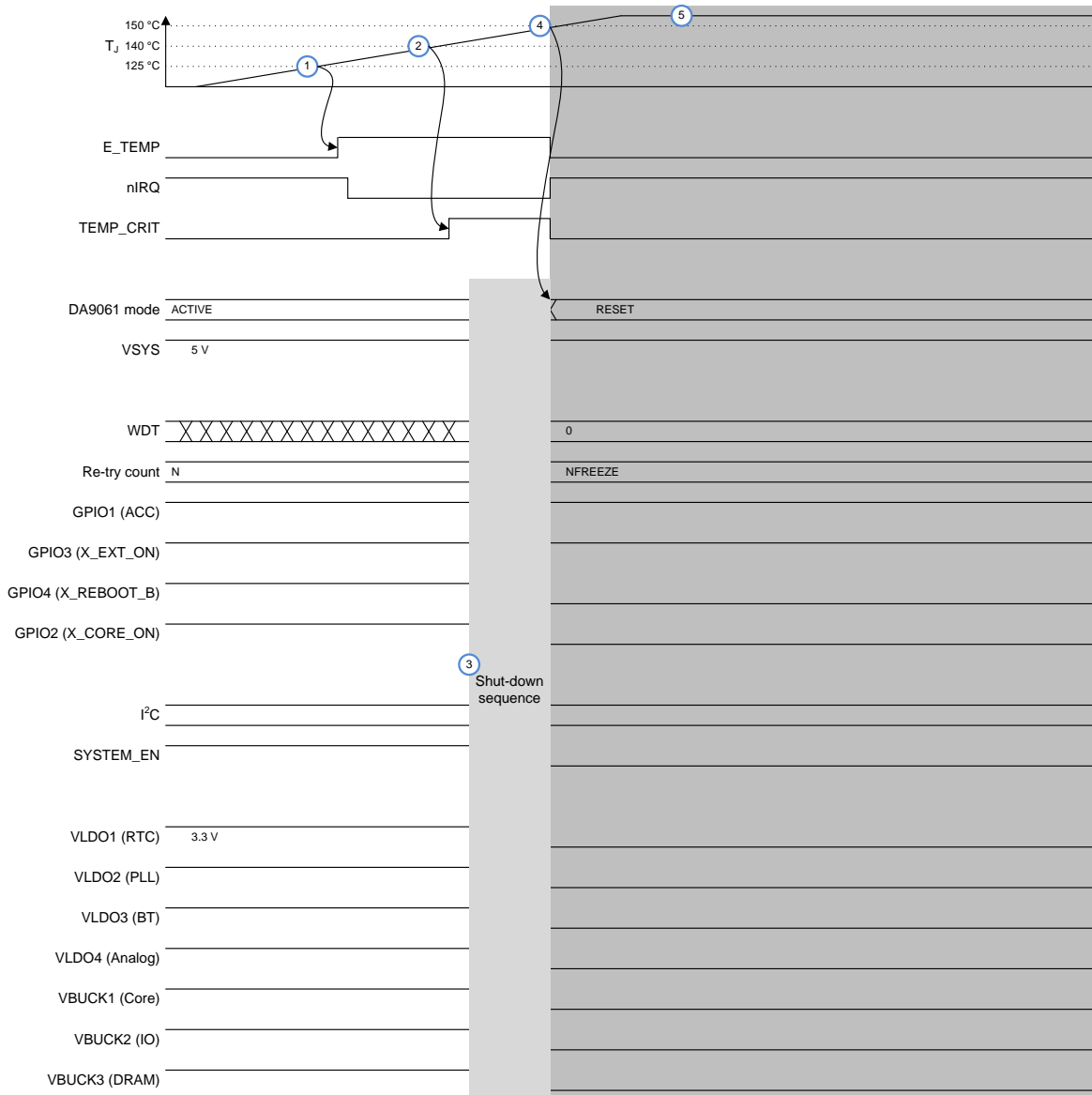

Figure 9: Timing Diagram for Temperature Power-On Reset

1. The die temperature exceeds T_{WARN} which causes the event E_TEMP (in register $EVENT_B$) to be asserted. The event, if not masked, asserts $nIRQ$.
2. The die temperature exceeds T_{CRIT} which causes the temperature error flag $TEMP_CRIT$ (in register $FAULT_LOG$) to be set, and a shut-down sequence is triggered.
3. DA9061 executes the shut-down sequence which is the same as the power-down sequence described in Section 5.2 but a shut-down sequence triggered by over-temperature proceeds straight to the RESET mode.
4. The die temperature exceeds T_{POR} which causes DA9061 to enter the RESET mode without any sequencing. Also the always-on LDO1 is disabled.
5. DA9061 stays in the RESET mode as long as the temperature stays above T_{CRIT} . After this a cold boot is executed as described in Section 5.1.

DA9061 / AtlasVI Power Connections

5.9 System Supply Under-Voltage

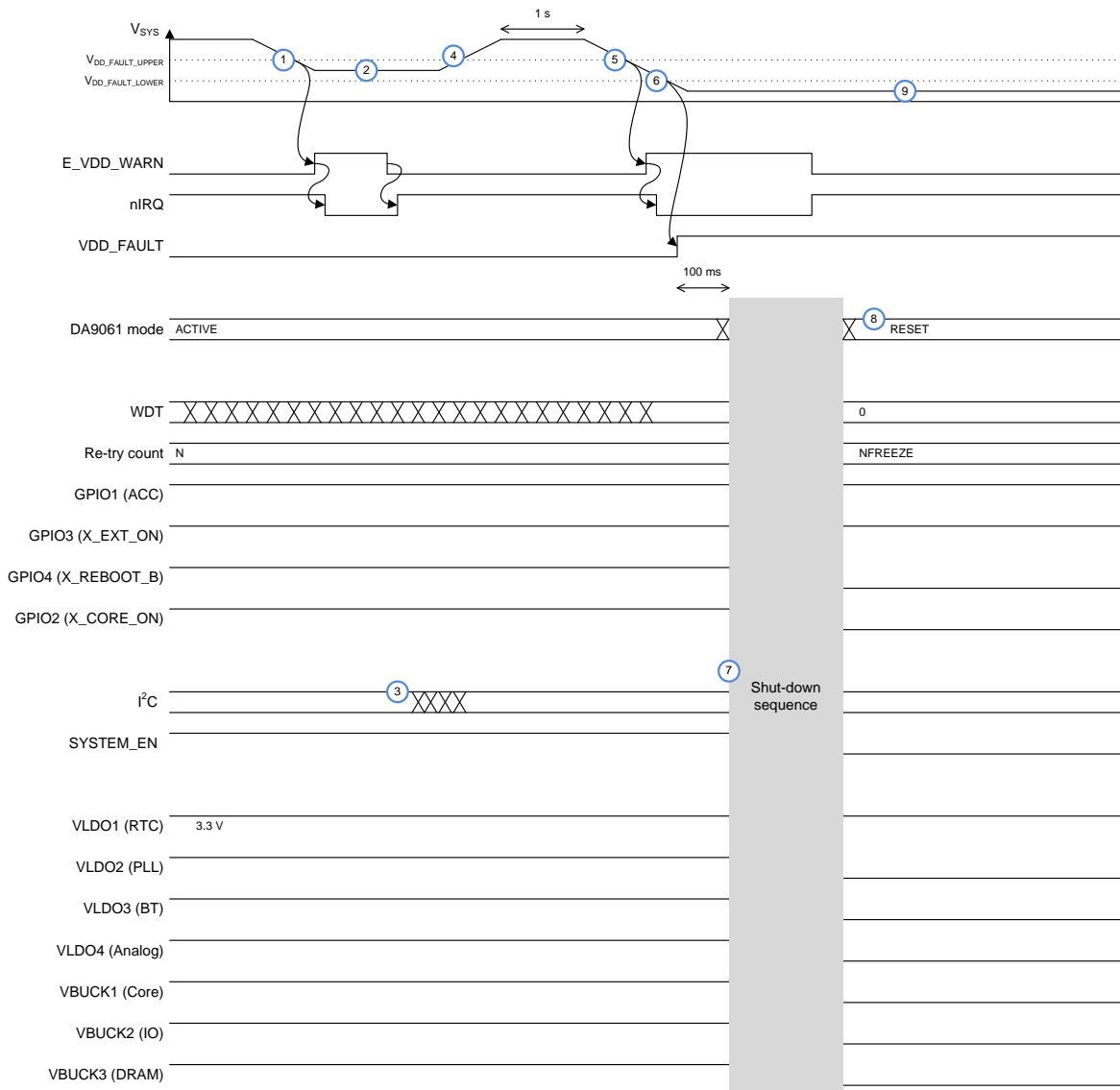

Figure 10: Timing Diagram for System Supply Under-Voltage

1. The system supply (V_{SYS}) drops below $V_{DD_FAULT_UPPER}$ which causes the event E_VDD_WARN (in register $EVENT_B$) to be asserted. The event, if not masked, asserts $nIRQ$.
2. AtlasVI software sees the system supply warning and reduces the activity of the platform. This should reduce the current draw of the platform and stabilize the system supply.
3. AtlasVI software clears the event E_VDD_WARN . If no other events are active, this de-asserts $nIRQ$.
4. The system supply recovers above the $V_{DD_FAULT_UPPER}$ threshold. After this, there is a 1 s debounce period for V_{SYS} . During this period the system supply comparators are not enabled and if V_{SYS} drops below $V_{DD_FAULT_UPPER}$ no event is generated.
5. V_{SYS} drops below $V_{DD_FAULT_UPPER}$ again which causes the event E_VDD_WARN to be asserted. The event, if not masked, asserts $nIRQ$.
6. V_{SYS} drops below $V_{DD_FAULT_LOWER}$ which causes the system supply error flag VDD_FAULT (in register $FAULT_LOG$) to be set, and a shut-down sequence is triggered.
7. DA9061 executes a shut-down sequence which the same as the power-down sequence described in Section 5.2 but a shut-down sequence triggered by a voltage error proceeds directly to the $RESET$ mode.

DA9061 / AtlasVI Power Connections

8. DA9061 completes the shut-down sequence and enters the RESET mode. The re-try count is reset but the system supply error flag is not.
9. DA9061 stays in RESET mode as long as the system supply stays below VDD_FAULT_LOWER. After this, the power-up sequence is executed in the same way as in the cold boot use case described in Section 5.1.

6 Software Driver

After the DA9061 has started the AtlasVI system, software can read and write to the PMIC via the I²C bus. This can be used for further PMIC configuration, such as the GPIOs, interrupt servicing, watchdog 'keep-alive' writes, and so on. Dialog drivers for Linux™ are available in the Linux kernel from <https://kernel.org/> [4] or, if interim assistance is required, from your Dialog Sales representative.

7 Development Support Tools and PMIC Configuration Files

To assist with hardware and software development, Dialog provides the following:

- DA9061 Evaluation Kit

This contains motherboard and daughterboard for hardware evaluation and software development. It also includes the SmartCanvas™ GUI software.

- SmartCanvas GUI

This is PC-driven software to provide easy access to a device under test (DUT). The GUI is used to exercise the DUT using the I²C interface. Control or measurement of analog and digital pins is supported. SmartCanvas supports the Dialog PMIC OTP configuration file (.ini file) format.

- OTP configuration .ini file DA9061-03_Atlas6_0v1_547A.ini

This file defines the configuration of the DA9061 at boot. The file is available from the Dialog Support website. The .ini file is opened using the SmartCanvas GUI.

- Linux software driver. See Section 6.

8 Device Identification and Ordering

Available parts are shown in Table 2. If the DA9061-03 proves unsuitable for your target AtlasVI design, please contact your Dialog sales representative to discuss custom variants. (Minimum order quantities apply for custom variants.)

Table 2: Product Part Numbers

Part Number	Description (Note 1)
DA9061-03AMx	Industrial grade
DA9061-03AMx-A	Automotive AEC-Q100 Grade 3

Note 1 See the DA9061 datasheet [1] for further information regarding part ordering. All parts are available in Tray (x = 1) or Tape & Reel (x = 2).

Revision History

Revision	Date	Description
1.0	15-Sep-2016	Initial version
2.0	18-Feb-2022	File was rebranded with new logo, copyright and disclaimer

DA9061 / AtlasVI Power Connections

Status Definitions

Status	Definition
DRAFT	The content of this document is under review and subject to formal approval, which may result in modifications or additions.
APPROVED or unmarked	The content of this document has been approved for publication.

RoHS Compliance

Dialog Semiconductor's suppliers certify that its products are in compliance with the requirements of Directive 2011/65/EU of the European Parliament on the restriction of the use of certain hazardous substances in electrical and electronic equipment. RoHS certificates from our suppliers are available on request.

IMPORTANT NOTICE AND DISCLAIMER

RENESAS ELECTRONICS CORPORATION AND ITS SUBSIDIARIES (“RENESAS”) PROVIDES TECHNICAL SPECIFICATIONS AND RELIABILITY DATA (INCLUDING DATASHEETS), DESIGN RESOURCES (INCLUDING REFERENCE DESIGNS), APPLICATION OR OTHER DESIGN ADVICE, WEB TOOLS, SAFETY INFORMATION, AND OTHER RESOURCES “AS IS” AND WITH ALL FAULTS, AND DISCLAIMS ALL WARRANTIES, EXPRESS OR IMPLIED, INCLUDING, WITHOUT LIMITATION, ANY IMPLIED WARRANTIES OF MERCHANTABILITY, FITNESS FOR A PARTICULAR PURPOSE, OR NON-INFRINGEMENT OF THIRD-PARTY INTELLECTUAL PROPERTY RIGHTS.

These resources are intended for developers who are designing with Renesas products. You are solely responsible for (1) selecting the appropriate products for your application, (2) designing, validating, and testing your application, and (3) ensuring your application meets applicable standards, and any other safety, security, or other requirements. These resources are subject to change without notice. Renesas grants you permission to use these resources only to develop an application that uses Renesas products. Other reproduction or use of these resources is strictly prohibited. No license is granted to any other Renesas intellectual property or to any third-party intellectual property. Renesas disclaims responsibility for, and you will fully indemnify Renesas and its representatives against, any claims, damages, costs, losses, or liabilities arising from your use of these resources. Renesas' products are provided only subject to Renesas' Terms and Conditions of Sale or other applicable terms agreed to in writing. No use of any Renesas resources expands or otherwise alters any applicable warranties or warranty disclaimers for these products.

(Disclaimer Rev.1.01)

Corporate Headquarters

TOYOSU FORESIA, 3-2-24 Toyosu,
Koto-ku, Tokyo 135-0061, Japan
www.renesas.com

Trademarks

Renesas and the Renesas logo are trademarks of Renesas Electronics Corporation. All trademarks and registered trademarks are the property of their respective owners.

Contact Information

For further information on a product, technology, the most up-to-date version of a document, or your nearest sales office, please visit www.renesas.com/contact-us/.