

Electric Corkscrew

SLG47105

This application note describes how to use the SLG475105 HVPAK to implement an electric corkscrew. The application note comes complete with design files, which can be found in the References section.

Contents

1. Introduction	2
2. HVPAK Design	3
2.1 Current Regulation	3
2.2 Voltage Regulation	4
2.3 Motor Control Logic	6
2.3.1. Description of Input Buttons and Microswitch Logic	6
2.3.2. Description Battery Level Detector and Charger Detector	8
2.3.3. Description Logic for LEDs	8
3. Conclusions	8
4. Revision History	9

References

For related documents and software, please visit:

<https://www.renesas.com/eu/en/products/programmable-mixed-signal-asic-ip-products/greenpak-programmable-mixed-signal-products/hvpak>

Download our free GreenPAK Designer software (Go Configure Software Hub) [1] to open the .gp file [2] and view the proposed circuit design. Use the GreenPAK development tools [3] to freeze the design into your own customized IC in a matter of minutes. Renesas Electronics provides a complete library of application notes [4] featuring design examples, as well as explanations of features and blocks within the Renesas IC.

[1] [GreenPAK Go Configure Software Hub](#), Software Download and User Guide, Renesas Electronics

[2] [AN-CM-369 Electric Corkscrew.hvp](#), HVPAK Design File, Renesas Electronics

[3] [GreenPAK Development Tools](#), GreenPAK Development Tools Webpage, Renesas Electronics

[4] [GreenPAK Application Notes](#), GreenPAK Application Notes Webpage, Renesas Electronics

Electric Corkscrew

1. Introduction

The art of wine appreciation and the joy of opening a bottle have long been intertwined with using a corkscrew. Over the years, advancements in technology have revolutionized this process, bringing about the advent of electric corkscrews. These innovative devices, powered by a motor, have streamlined the wine-opening experience, making it effortless, efficient, and enjoyable for wine enthusiasts and professionals alike. Furthermore, wine opening requires decent hand strength and finger dexterity, which may be troublesome for those with mobility concerns. For these people, using an electric corkscrew is the only way to open wine.



Figure 1. Electric Corkscrew View

Brushed DC motors are used in electric corkscrews. The motor driver plays a crucial role in them, providing the necessary torque, speed, and control required to perform the delicate task of removing the cork from the bottle. The Renesas IC SLG47105 (HVPK) combines mixed-signal logic and high-drive H-/Half-Bridges and proves to be an ideal choice for implementing the functionality of an electric corkscrew. Figure 2 illustrates a general schematic of the device based on the HVPK.

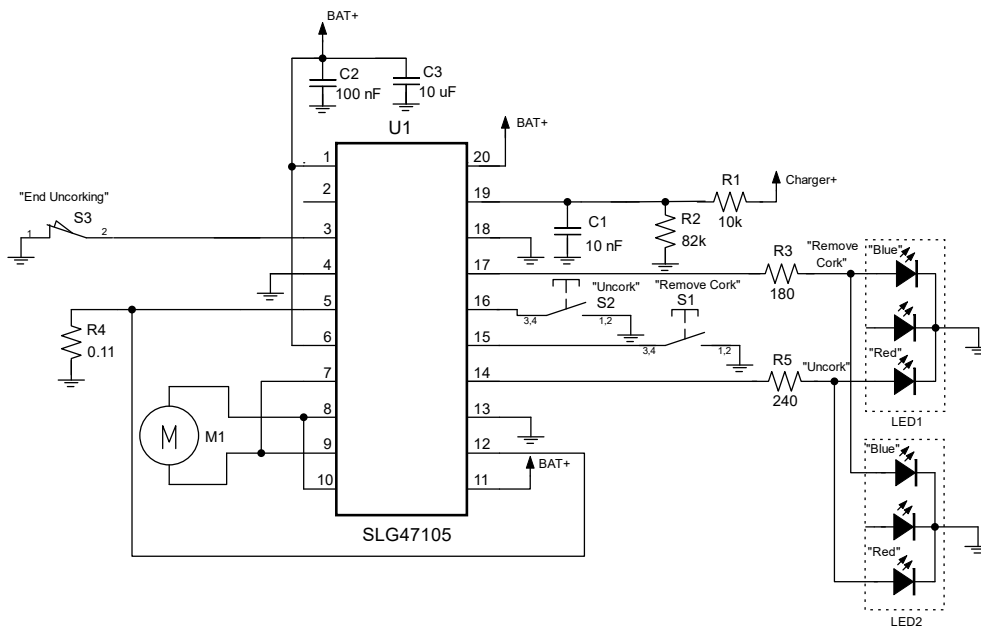

Figure 2. General Schematic of Electric Corkscrew Based on SLG47105

2. HVPAK Design

Figure 3 shows an internal design of the electric corkscrew in the GreenPAK Designer software from Go Configure Software Hub.

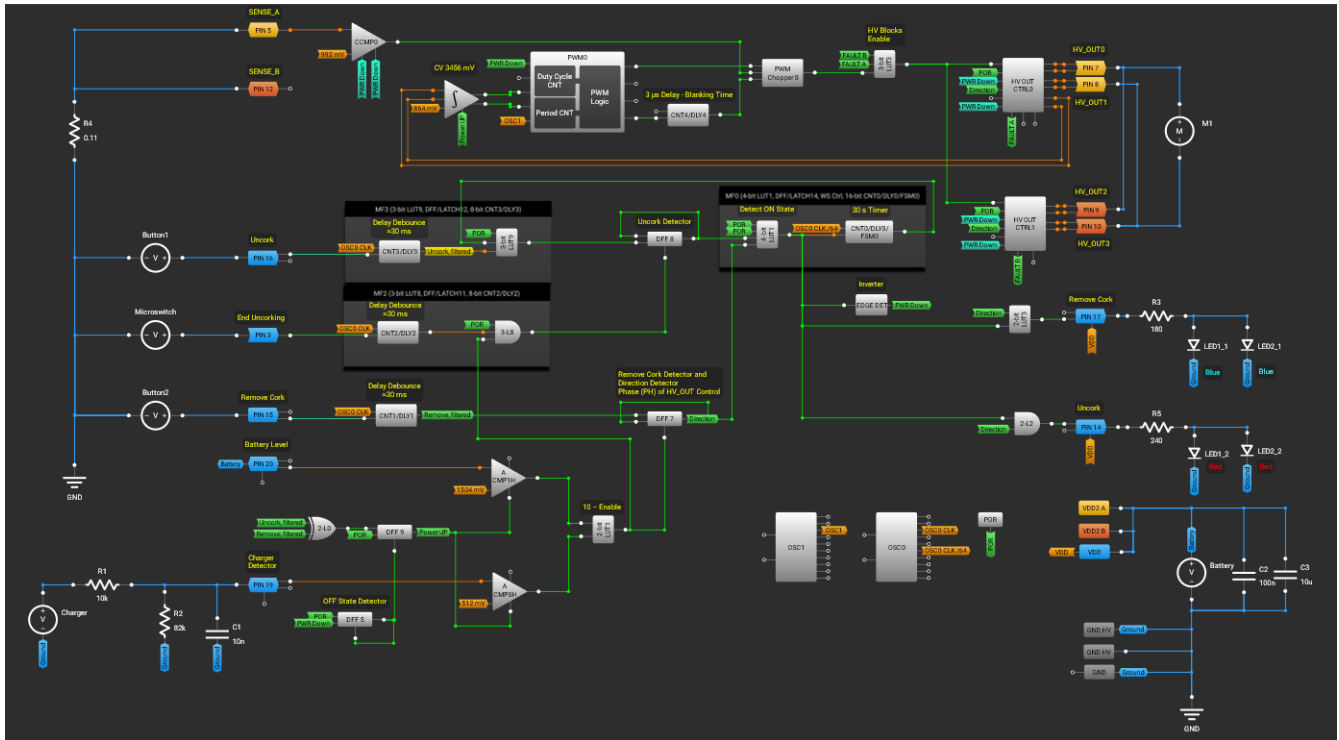

Figure 3. Go Configure Schematic of Electric Corkscrew

The main role in driving the motor is performed by high-drive pins 7, 8, 9, and 10 along with their corresponding control macrocells HV OUT Ctrl0 and HV Out Ctrl1. To increase the current rating, users have the option to connect the outputs in parallel, which was implemented in the corkscrew circuit.

Because the corkscrew needs to rotate in both directions, the macrocells HV OUT Ctrl0 and HV Out Ctrl1 are configured in Full-Bridge mode. By supplying a HIGH-level signal from the POR (Power-On Reset) to the Decay inputs of HV OUT Ctrl0 and HV Out Ctrl1, a Slow decay mode is activated. This mode allows for a gradual reduction in inductive current, resulting in a quick halt of the motor's movement.

The 3-bit LUT3 enables the operation of HV OUT Control blocks provided that signals FAULT A and FAULT B are LOW (indicating no fault events).

2.1 Current Regulation

In this design, a current control was used. The current control circuit is provided to regulate the system in the event of an overcurrent condition, such as an abnormal mechanical load on a DC motor. The current is sensed by an external sense resistor connected to the SENSE_A and SENSE_B pins. The resistor value is calculated using the formula:

$$I = \frac{V_{ref}}{R_{sense} \times Gain}$$

The current sense comparator (CCMP0) is used to convert the sense resistor current into a logic level, thus limiting the output current. In this case, R_{sense} was chosen to be equal to 0.11 Ω , V_{REF} was set to 992 mV, and the gain was set to 4, resulting in a limiting current of 2.2 A. This current comparator signal is utilized by the PWM Chopper to chop the PWM duty cycle. By using the current comparator with the PWM block, the output current can be dynamically adjusted. The operational principle of the PWM chopper is illustrated in Figure 4.

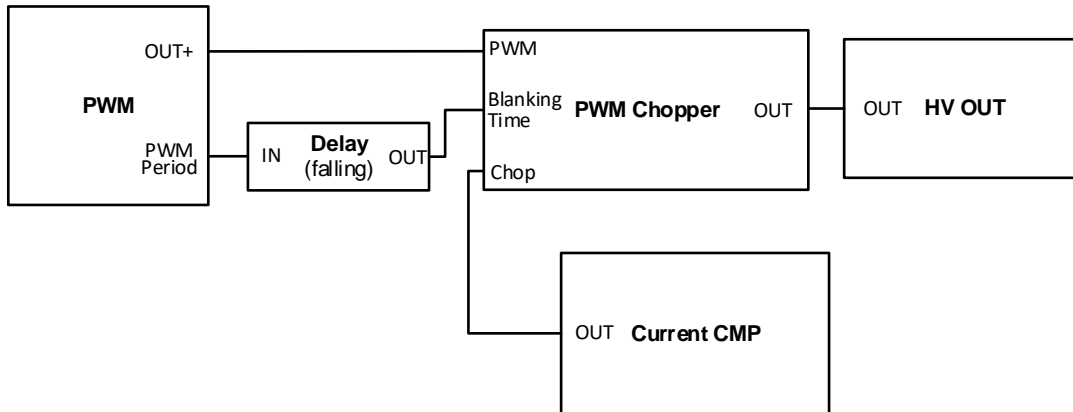

Figure 4. PWM Chopper Circuit Block Diagram

A delay allows ignoring the Current Comparator signal during the Blanking time, which occurs during the motor start period. Any active signal from the Current CMP after the Blanking time causes the PWM Duty Cycle to be chopped to the end of the current period. Figure 5 demonstrates the PWM chopping process in the electric corkscrew.

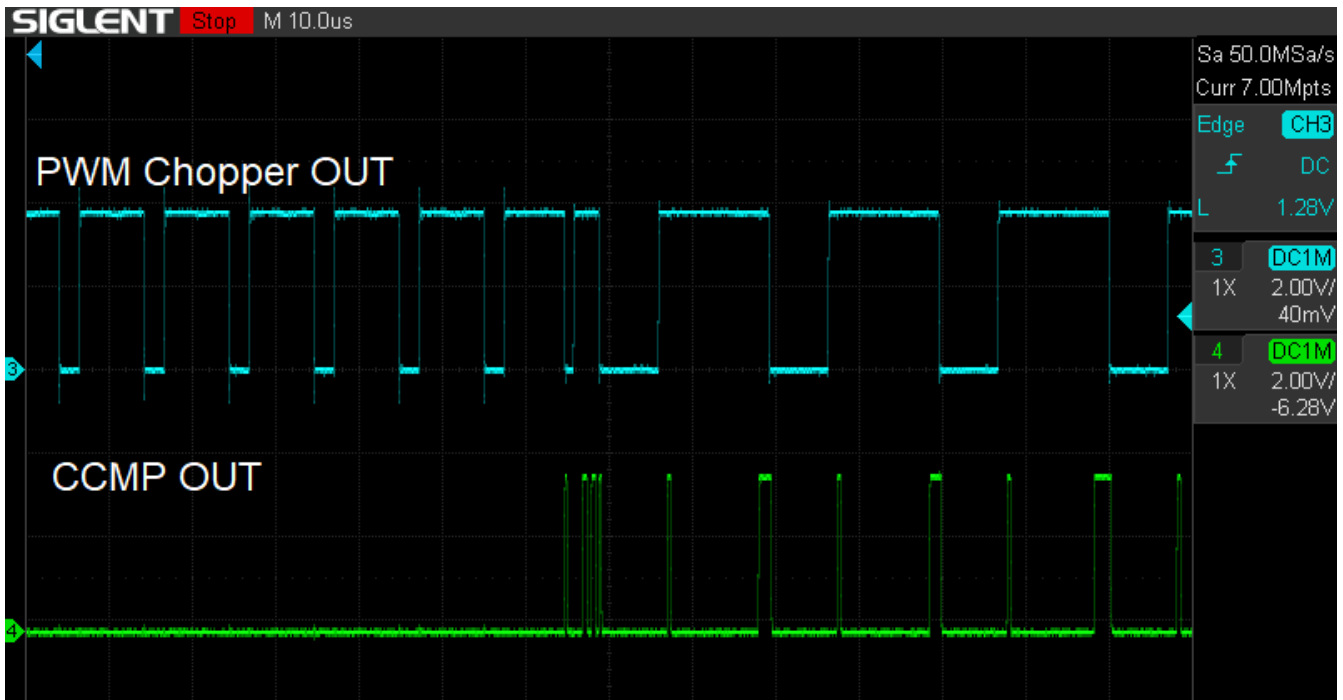

Figure 5. PWM Chopper Working Waveform

2.2 Voltage Regulation

Because the device is powered by a lithium-ion battery, the PWM voltage regulation is useful for this design. It allows maintaining a constant motor speed with a changeable power supply level. When the V_{DD} is decreasing (the battery discharging), it becomes possible to increase the PWM duty cycle.

For the voltage regulation, the Differential Amplifier with Integrator and Analog Comparator macrocell is used. This macrocell monitors the voltage difference between HV_GPO0_HD and HV_GPO1_HD pins of the Full Bridge and integrates it to get an average voltage value. If the average output voltage is lower than V_{REF} , the duty cycle of the PWM output needs to increase; if the average output value is higher than V_{REF} , the duty cycle needs to decrease; when the average output value is equal to the comparator threshold, the PWM duty cycle is kept by EQUAL output.

Figure 6, Figure 7, and Figure 8 show the voltage regulation process in the electric corkscrew.

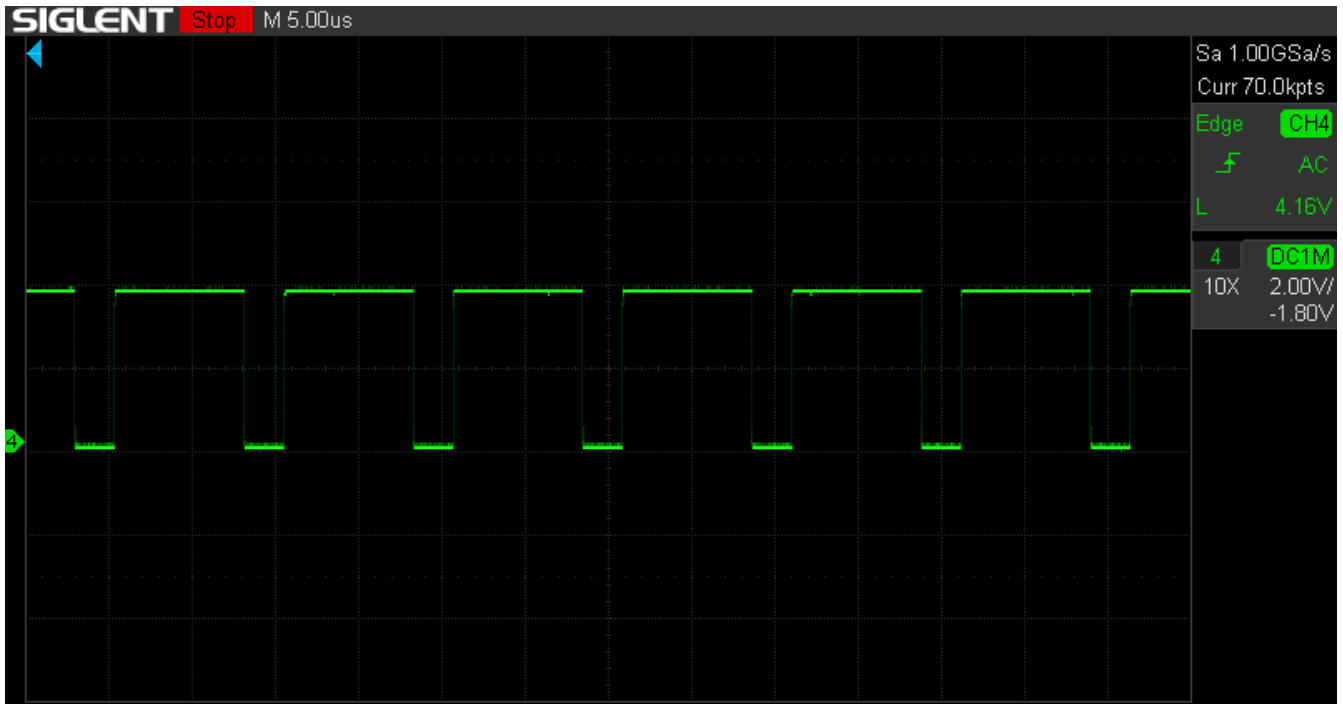

Figure 6. PWM Chopper OUT at $V_{DD} = 4.2$ V (Duty Cycle = 76 %)

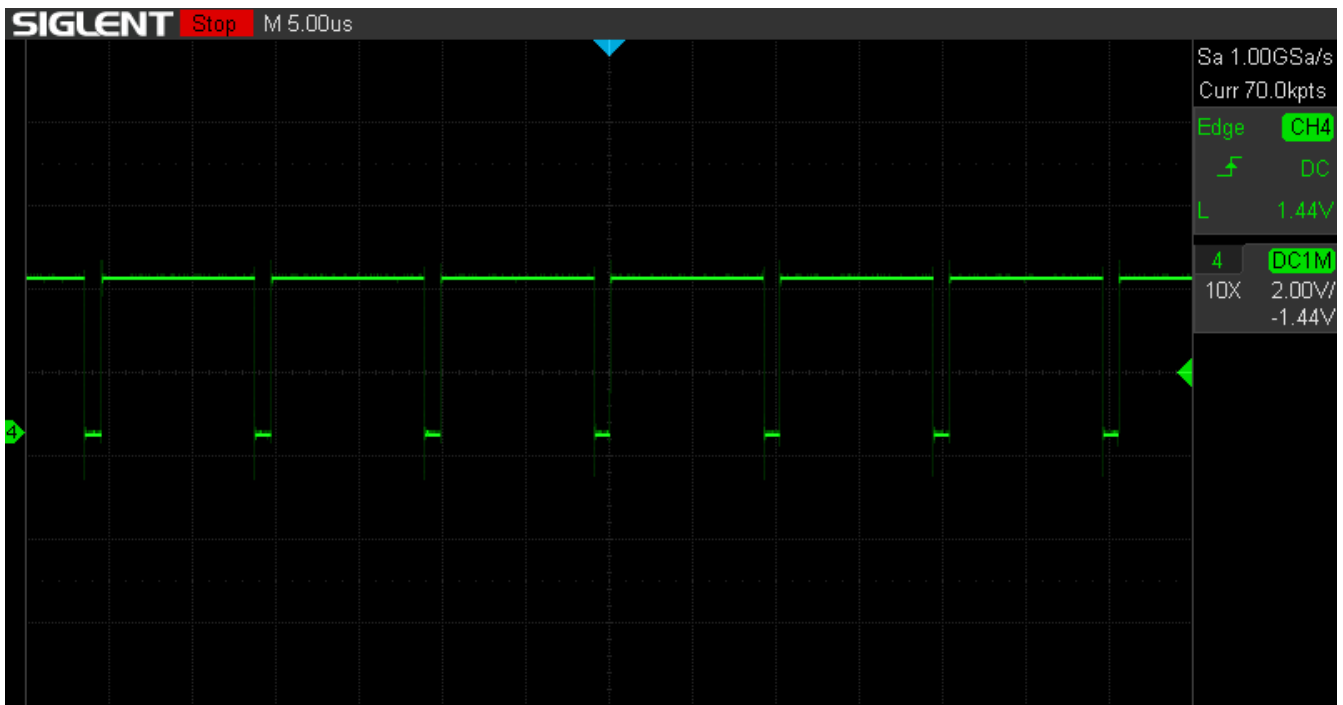

Figure 7. PWM Chopper OUT at $V_{DD} = 3.7$ V (Duty Cycle = 86 %)

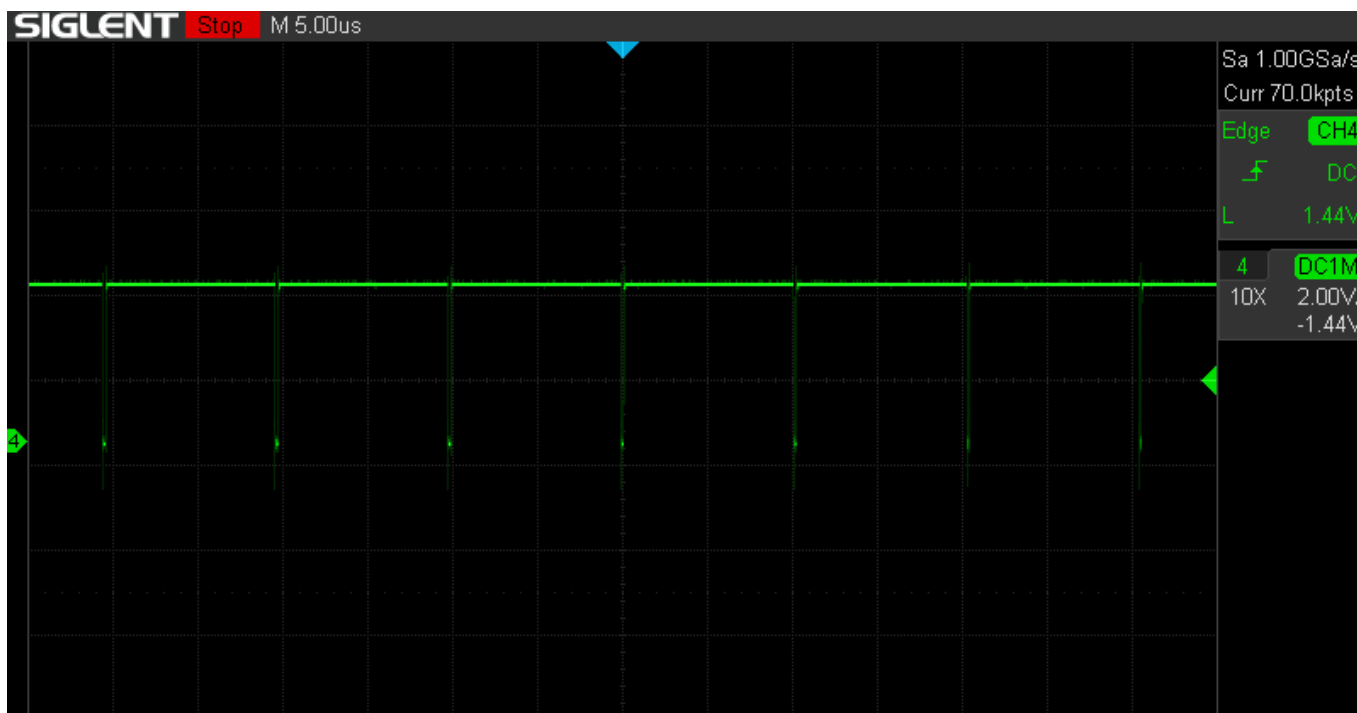

Figure 8. PWM Chopper OUT at $V_{DD} = 3.3\text{ V}$ (Duty Cycle = 97 %)

The integrator reference voltage was set to 864 mV, resulting in a threshold of 3.456 V. This threshold value guarantees a constant voltage of 3 V across the motor winding, regardless of the battery voltage.

2.3 Motor Control Logic

When the user presses the “Uncork” or “Remove Cork” button with a short LOW-level pulse, the DC motor (corkscrew) rotates in the corresponding direction: clockwise for “Uncork” and counterclockwise for “Remove Cork.” Pressing these buttons again stops the corkscrew.

When the corkscrew is activated, it runs until the 30-second timer (DLY0 macrocell) reaches 30 s. After this period, the corkscrew will stop. If the microswitch is activated during the “Uncork” (clockwise) rotation, the corkscrew stops immediately.

The main elements of the motor control logic are:

- Logic for input buttons and microswitch
- Battery level detector and charger detector
- Logic for LEDs.

2.3.1. Description of Input Buttons and Microswitch Logic

In sleep mode, the output of the 3-bit LUT9 remains LOW. However, when the “Uncork” button is pressed or the timer is triggered, the output transitions to a HIGH level. On the rising edge of this pulse, DFF8 toggles its state to the opposite, resulting in a LOW output. Subsequently, the output of the 4-bit LUT1 goes HIGH, and the PWR Down signal goes LOW after passing through the Inverted Edge Detector. To eliminate switch bouncing, a Delay macrocell DLY2 is used.

When the user presses the “Uncork” or “Remove Cork” button with a short LOW-level pulse, the falling edge of the pulse toggles DFF9 to the HIGH state, causing the Power UP signal to go HIGH. DFF9 switches power on for the ACMPs, which checks the battery level and charging state. If the battery level is above 3.0 V and the charging state is OFF, the rising edge of the LOW-level pulse changes the state of DFF8 (Uncork Detector) or DFF7 (Remove Cork Detector) accordingly. See the timing diagram in [Figure 9](#).

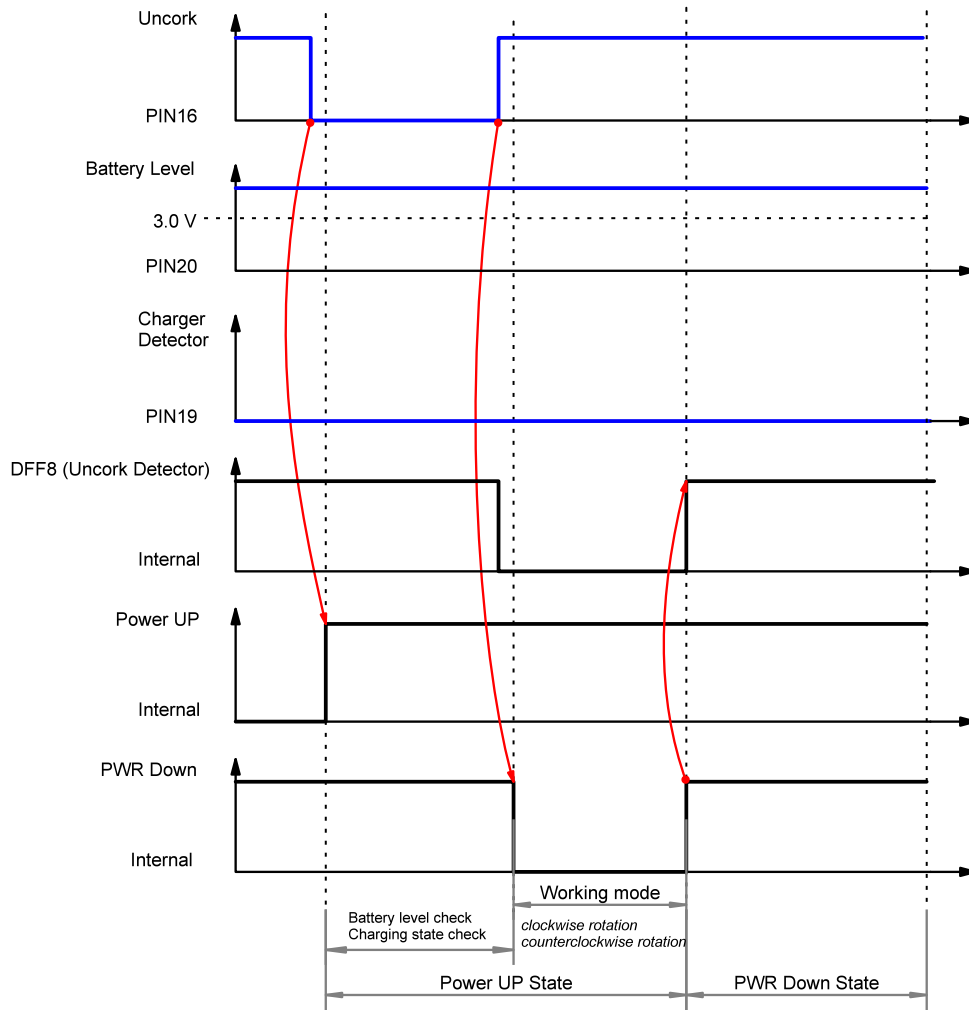

Figure 9. Input Buttons Logic Timing Diagram

When the user presses the “Uncork” button, DFF8 toggles its state to the opposite, resulting in a LOW-level output. To eliminate switch bouncing, a Delay macrocell DLY3 is used. Subsequently, the output of the 4-bit LUT1 goes HIGH, initiating the motor’s clockwise rotation. Additionally, the rising edge of the signal from the output of 4-bit LUT1 is delayed by DLY0 for 30 seconds. If the corkscrew is not turned off within this period, the delayed rising edge reaches the input of the 3-bit LUT9, causing its output to go HIGH. This change in state forces DFF8 to toggle, and the output of the 4-bit LUT1 goes LOW, resulting in the motor ceasing its operation.

A similar sequence of events occurs when the cork is unscrewed sufficiently to activate the microswitch (signaling the end of uncorking), which connects Pin 3 to GND. The 30-second timer ensures that the motor shuts off and the corkscrew enters sleep mode for both the uncorking and cork removal modes. This shutdown function conserves power and prevents overheating.

When the user presses the “Remove Cork” button, DFF7 also toggles its state, resulting in a LOW output. Subsequently, the output of the 4-bit LUT1 goes HIGH, initiating the motor’s counterclockwise rotation. Similarly, to eliminate this switch bouncing, the Delay macrocell DLY1 is used. Furthermore, to eliminate microswitch bouncing, DLY2 is employed.

The signal from the output of DFF7 is fed to the PH inputs of the HV OUT Control blocks, determining the direction of motor rotation based on the button pressed. Specifically, if the output of DFF7 is LOW, the motor rotates clockwise, and if it is HIGH, the motor rotates counterclockwise.

2.3.2. Description Battery Level Detector and Charger Detector

To ensure low energy consumption in sleep mode, the Differential Amplifier with Integrator and Analog Comparator macrocell, along with analog comparators ACMP0H and ACMP1H, are designed to exit sleep mode upon pressing any button. The signals from these buttons first pass through the 2-bit LUT0, which outputs a pulse for any change in its inputs. The DFF9 changes its state in response to this pulse. Subsequently, the signal is supplied to the power inputs of the comparators and the amplifier.

The ACMP1H detects a low battery level (about 3.0 V). ACMP0 along with an external resistive divider detects the presence of a connected charger. The threshold level for ACMP0H is approximately 0.5 V.

2.3.3. Description Logic for LEDs

Depending on which button is pressed and whether the corkscrew is in working mode, the 2-bit LUT2 and 2-bit LUT3 generate a HIGH signal for one of the LEDs. The red LED illuminates when the output of the 2-bit LUT2 is HIGH (indicating the active uncorking mode), while the blue LED lights up when the output of the 2-bit LUT3 is HIGH (indicating the active cork removal mode).

3. Conclusions

The SLG47105 is an incredibly versatile device that offers a wide range of mixed-signal functionalities combined with high-voltage capabilities, all packed into a compact and thermally efficient integrated circuit. This application note explores the utilization of the SLG47105 in implementing a corkscrew. With its abundance of digital and analog blocks, the SLG47105 can replace multiple ICs required for the corkscrew's operation, including the motor driver, logic components, and voltage monitor. Additionally, it provides features such as voltage and current control, along with advanced protection mechanisms against abnormal situations. Last but not least this device is cost-effective and energy-efficient, making it an excellent choice.

4. Revision History

Revision	Date	Description
1.00	Oct 10, 2023	Initial release.
1.01	Feb 4, 2025	Updated for design optimization

IMPORTANT NOTICE AND DISCLAIMER

RENESAS ELECTRONICS CORPORATION AND ITS SUBSIDIARIES (“RENESAS”) PROVIDES TECHNICAL SPECIFICATIONS AND RELIABILITY DATA (INCLUDING DATASHEETS), DESIGN RESOURCES (INCLUDING REFERENCE DESIGNS), APPLICATION OR OTHER DESIGN ADVICE, WEB TOOLS, SAFETY INFORMATION, AND OTHER RESOURCES “AS IS” AND WITH ALL FAULTS, AND DISCLAIMS ALL WARRANTIES, EXPRESS OR IMPLIED, INCLUDING, WITHOUT LIMITATION, ANY IMPLIED WARRANTIES OF MERCHANTABILITY, FITNESS FOR A PARTICULAR PURPOSE, OR NON-INFRINGEMENT OF THIRD-PARTY INTELLECTUAL PROPERTY RIGHTS.

These resources are intended for developers who are designing with Renesas products. You are solely responsible for (1) selecting the appropriate products for your application, (2) designing, validating, and testing your application, and (3) ensuring your application meets applicable standards, and any other safety, security, or other requirements. These resources are subject to change without notice. Renesas grants you permission to use these resources only to develop an application that uses Renesas products. Other reproduction or use of these resources is strictly prohibited. No license is granted to any other Renesas intellectual property or to any third-party intellectual property. Renesas disclaims responsibility for, and you will fully indemnify Renesas and its representatives against, any claims, damages, costs, losses, or liabilities arising from your use of these resources. Renesas' products are provided only subject to Renesas' Terms and Conditions of Sale or other applicable terms agreed to in writing. No use of any Renesas resources expands or otherwise alters any applicable warranties or warranty disclaimers for these products.

(Disclaimer Rev.1.01)

Corporate Headquarters

TOYOSU FORESIA, 3-2-24 Toyosu,
Koto-ku, Tokyo 135-0061, Japan
www.renesas.com

Trademarks

Renesas and the Renesas logo are trademarks of Renesas Electronics Corporation. All trademarks and registered trademarks are the property of their respective owners.

Contact Information

For further information on a product, technology, the most up-to-date version of a document, or your nearest sales office, please visit www.renesas.com/contact-us/.