

# F1102 Low IF Frequency and Lower DC Power Consumption

- April 23, 2014
- Task AT0053

Michael J. Virostko  
Principal Product Application Engineer



---

The Analog and Digital Company™



# Agenda

- Purpose
- Circuit Modifications
- Characterization
- Conclusion



# Purpose

- Customer's application requires a lower DC power consumption of the F1102 Dual Downconverting Mixer.
- Customer also requires that the output IF response work from 25 – 100 MHz.
- We will investigate various bias conditions by varying the bias resistors and then perform a full characterization for one part.



# Circuit Modifications

- IDT's evaluation board (F1150 EV Kit Rev 5) has IF Circuitry for a frequency range of 50 to 300 MHz.

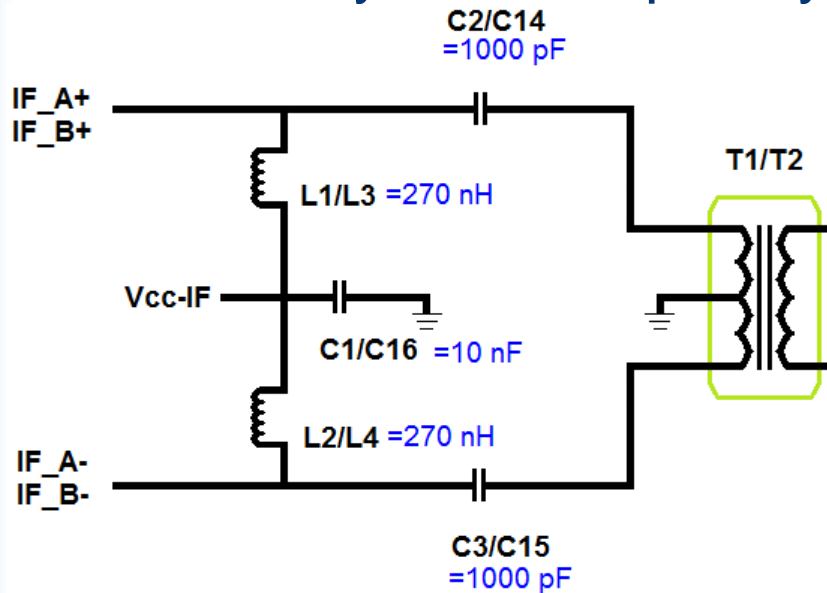

**Standard Evaluation Board IF Circuitry**

**Modified IF Circuitry for 10 MHz Operation**

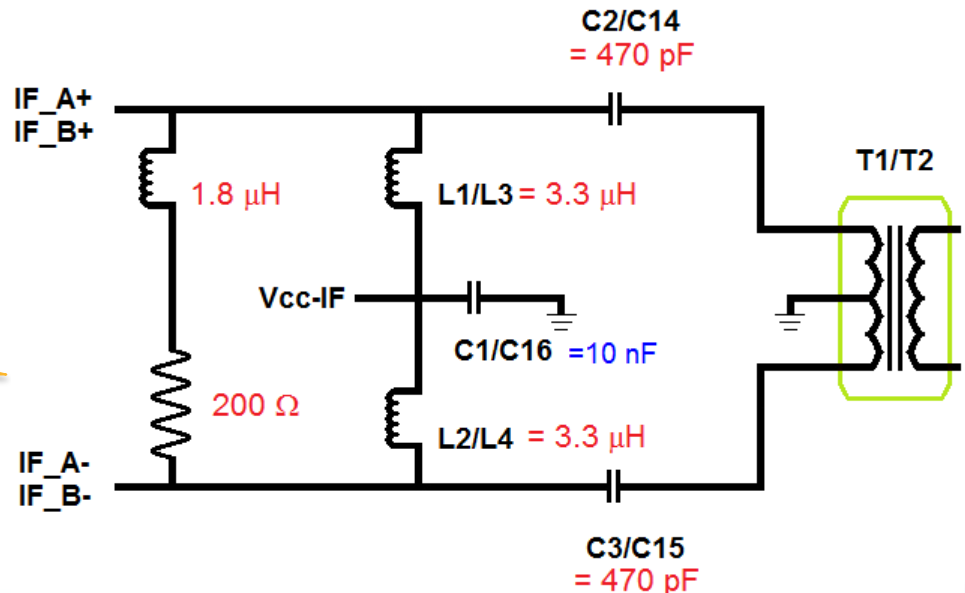

# Characterization – IF Return Loss - Standard

F1102 Standard Evaluation Board  
IF Port Return Loss

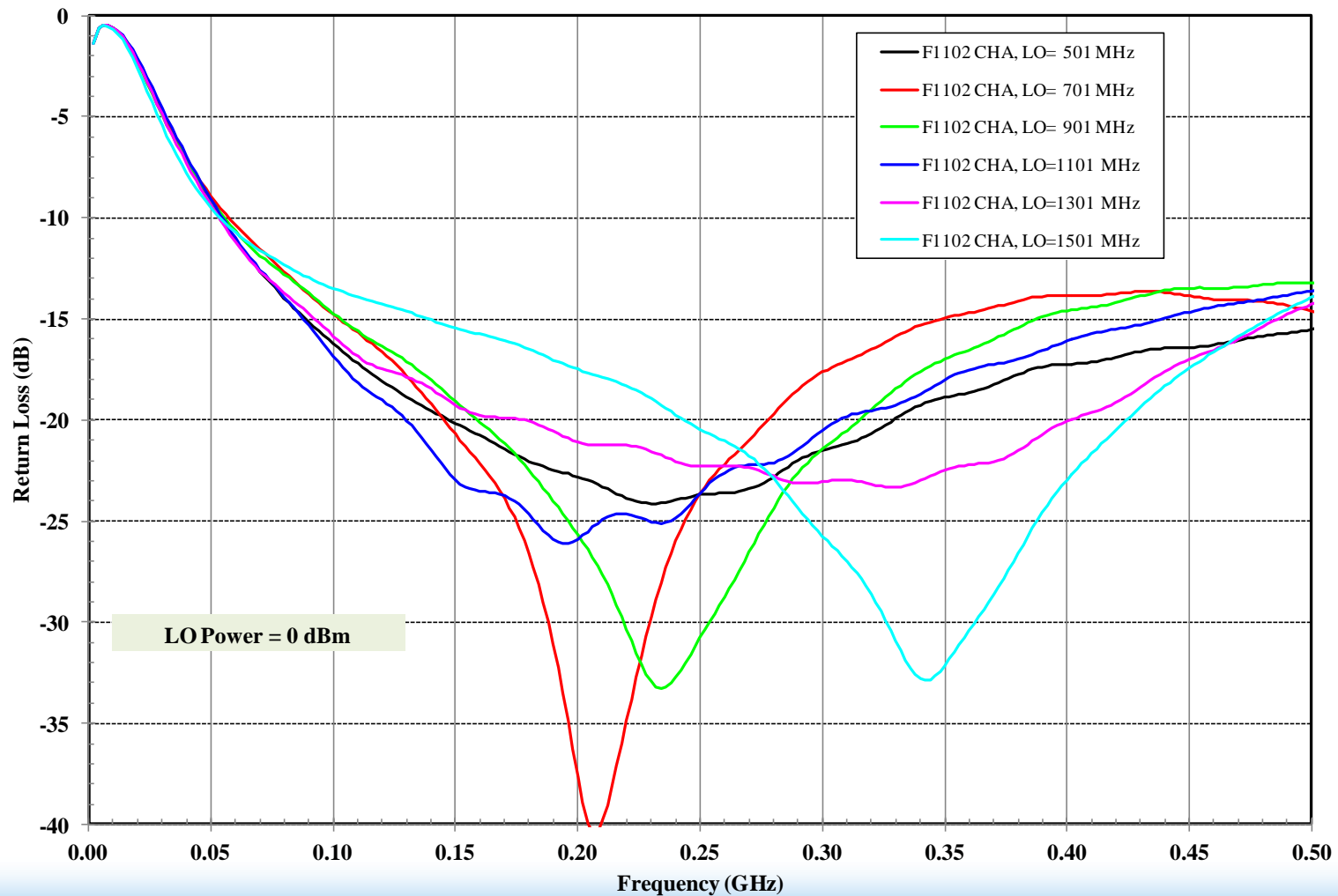

# Characterization – IF Return Loss – 10 MHz

F1102 IF Return Loss  
Low Frequency IF components

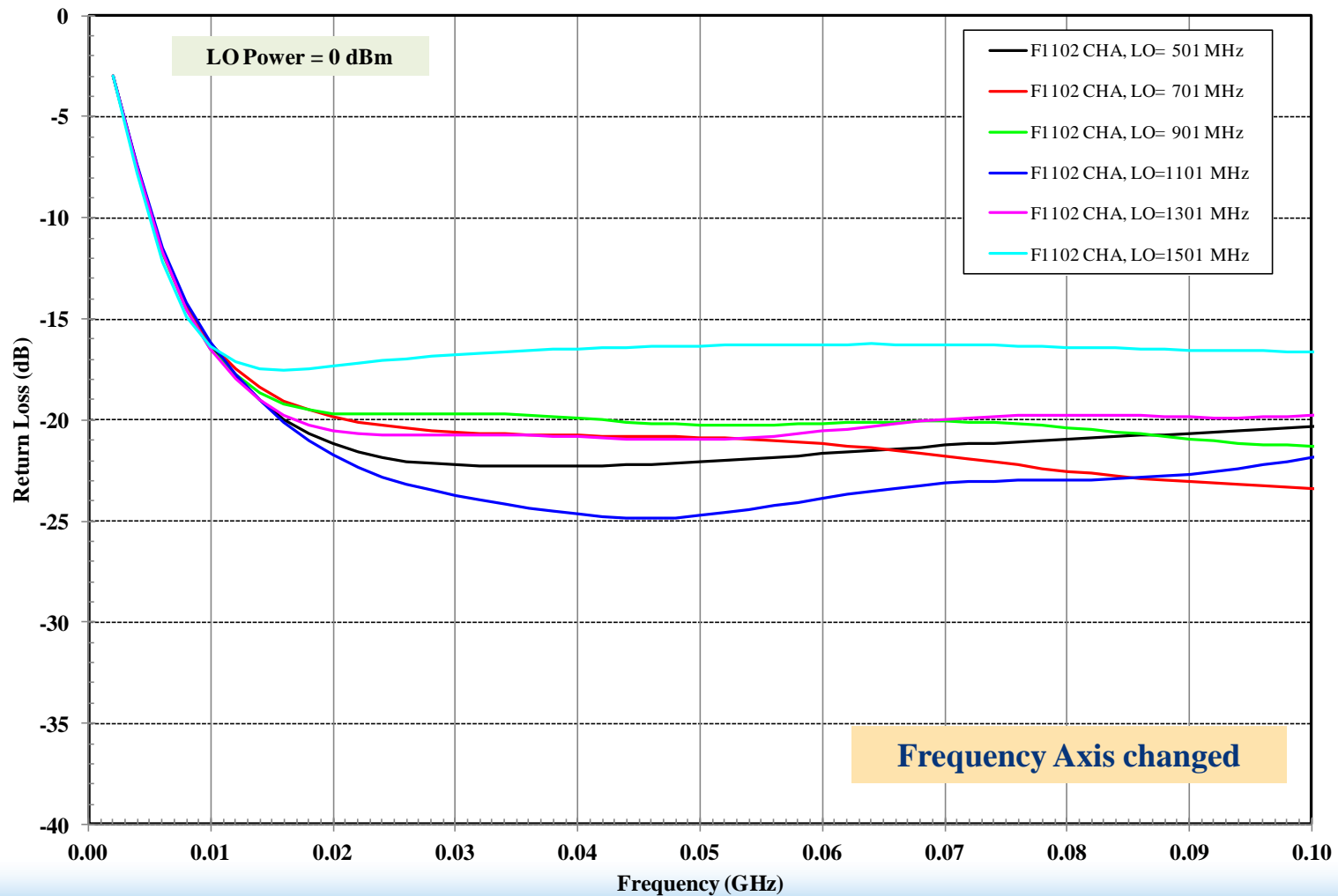

# Characterization – Measurement Parameters

- Data is collected at the end of the evaluation board
  - No loss correction is done
- Low Current mode was used for all measurements. The resistors used are:
  - IF\_BiasA = IF\_BiasB = 62 ohms
  - LO1\_Adj\_Bias = 180 ohms
  - LO2\_Adj\_Bias = 4100 ohms
    - Different from the standard low current mode
- RF frequency was 700 and 900 MHz
- LO swept for both high and low side injection
- IF swept

# Characterization – Measurement Parameters

- The Voltage applied to the IF circuit ( $V_{cc-IF}$ ) was changed from 5.0 to 3.3 V.
- $V_{cc-IF}$  must be turned on before  $V_{cc}$ .
- The current variation is in the 10's of  $\mu A$ . The nominal current is 104.4 mA for either applied voltage.
- DC Power is calculated for the entire device (both Channels).
- RF data was only collected on Channel A.





# Characterization – Gain, High Side LO

F1102 RF to IF Dual Downconverting Mixer  
Low Frequency IF Circuitry,  $V_{cc-IF} = +3.3\text{ V}$ ,  $V_{cc} = +5.0\text{ V}$   
RF Fixed Frequency, High Side LO Injection ( $RF < LO$ ),  $IF = LO - RF$

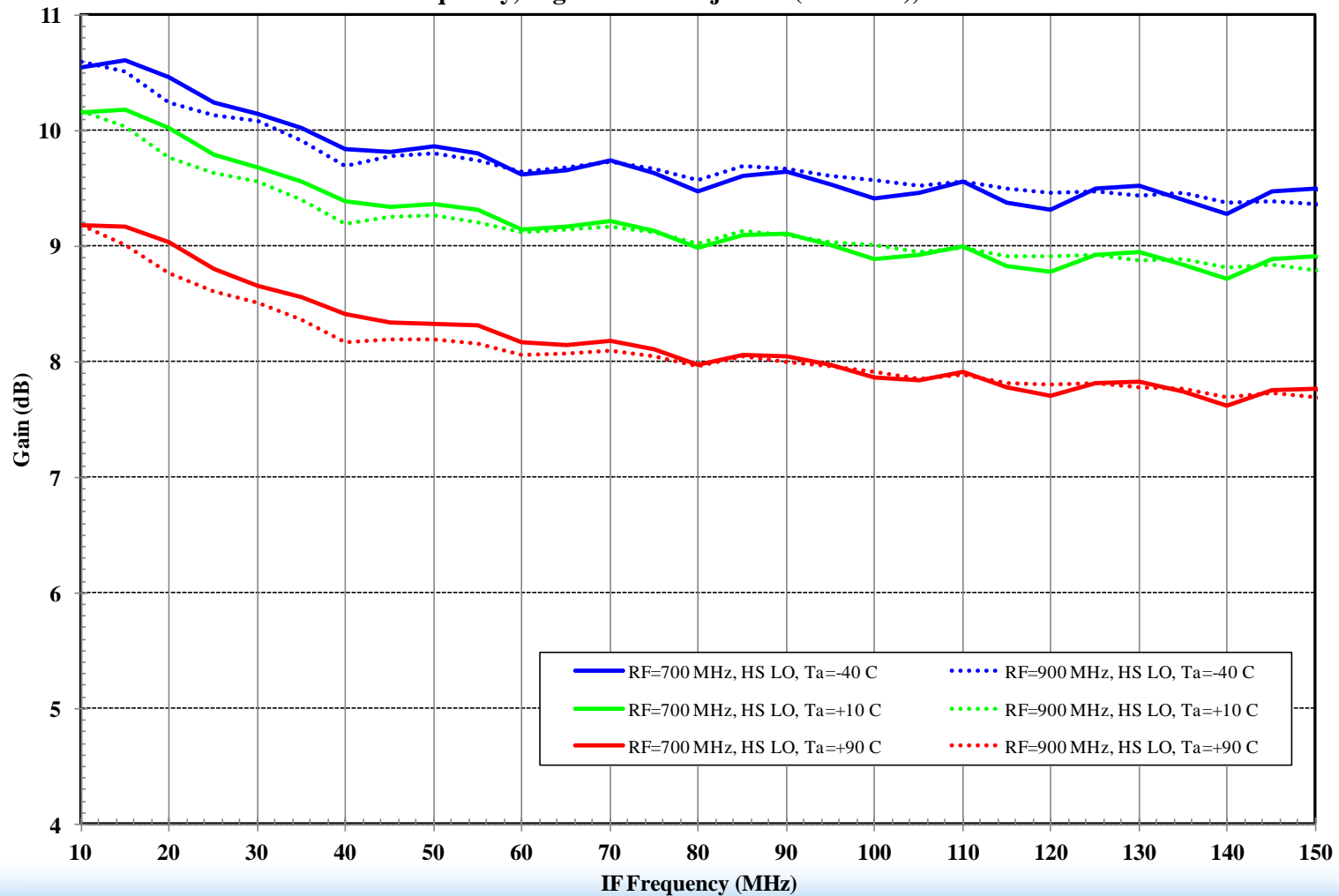

# Characterization – Gain, Low Side LO

F1102 RF to IF Dual Downconverting Mixer  
Low Frequency IF Circuitry,  $V_{cc-IF} = +3.3\text{ V}$ ,  $V_{cc} = +5.0\text{ V}$   
RF Fixed Frequency, Low Side LO Injection ( $RF > LO$ ),  $IF = RF - LO$

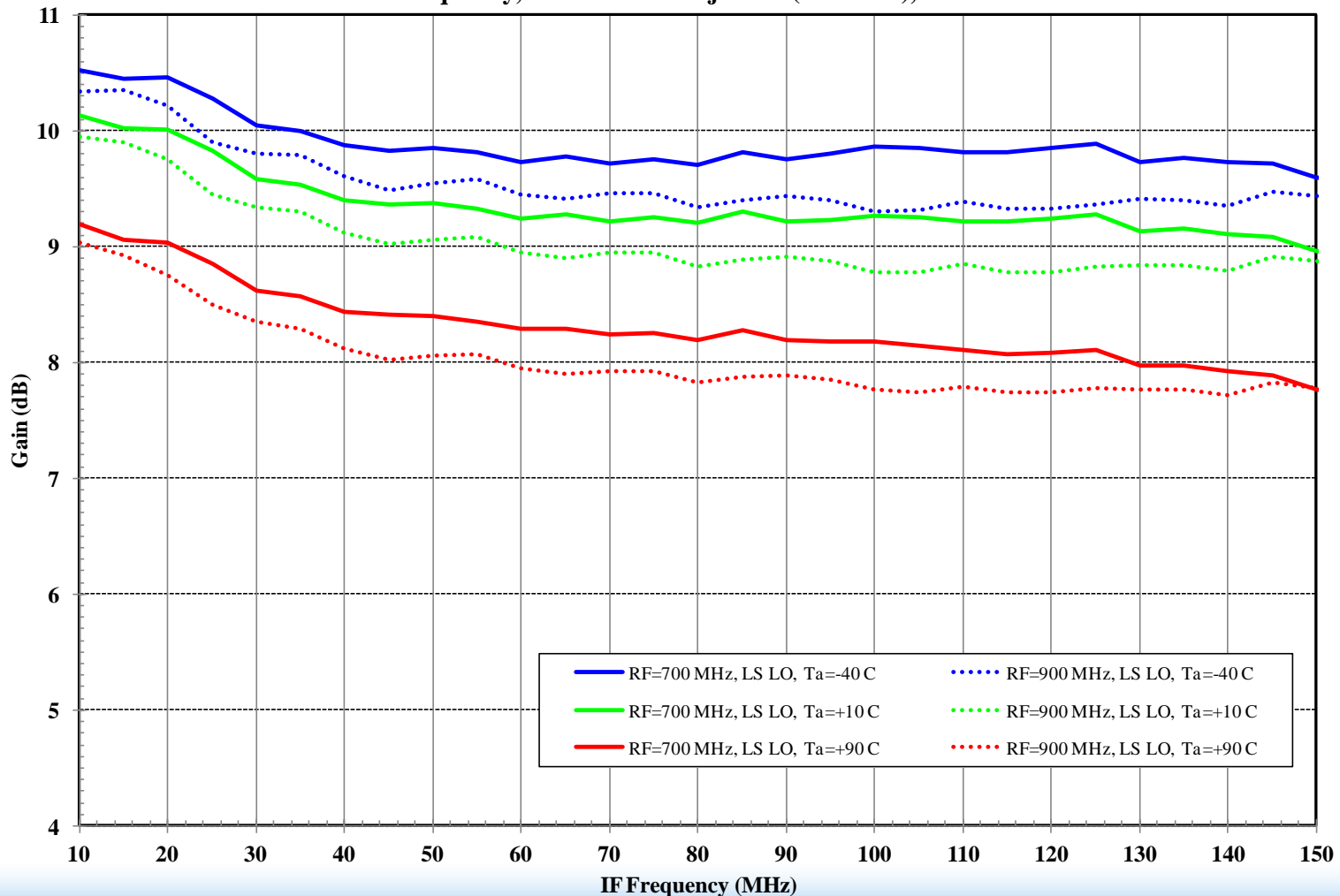

# Characterization – OIP3, High Side LO

F1102 RF to IF Dual Downconverting Mixer  
Low Frequency IF Circuitry,  $V_{cc-IF} = +3.3\text{ V}$ ,  $V_{cc} = +5.0\text{ V}$   
RF Fixed Frequency, High Side LO Injection ( $RF < LO$ ),  $IF = LO - RF$

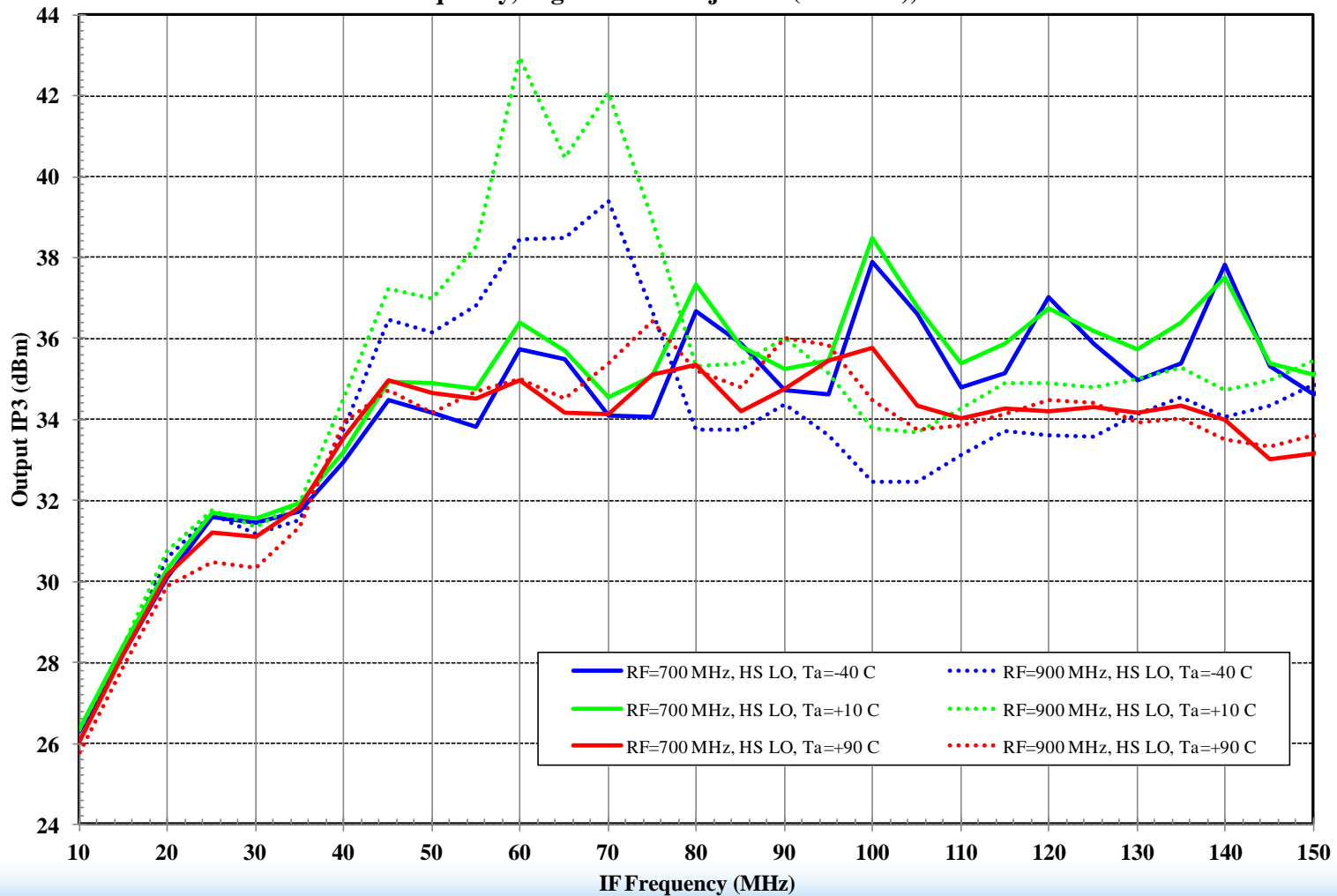

# Characterization – OIP3, Low Side LO

F1102 RF to IF Dual Downconverting Mixer  
Low Frequency IF Circuitry,  $V_{cc-IF} = +3.3\text{ V}$ ,  $V_{cc} = +5.0\text{ V}$   
RF Fixed Frequency, Low Side LO Injection ( $RF > LO$ ),  $IF = RF - LO$

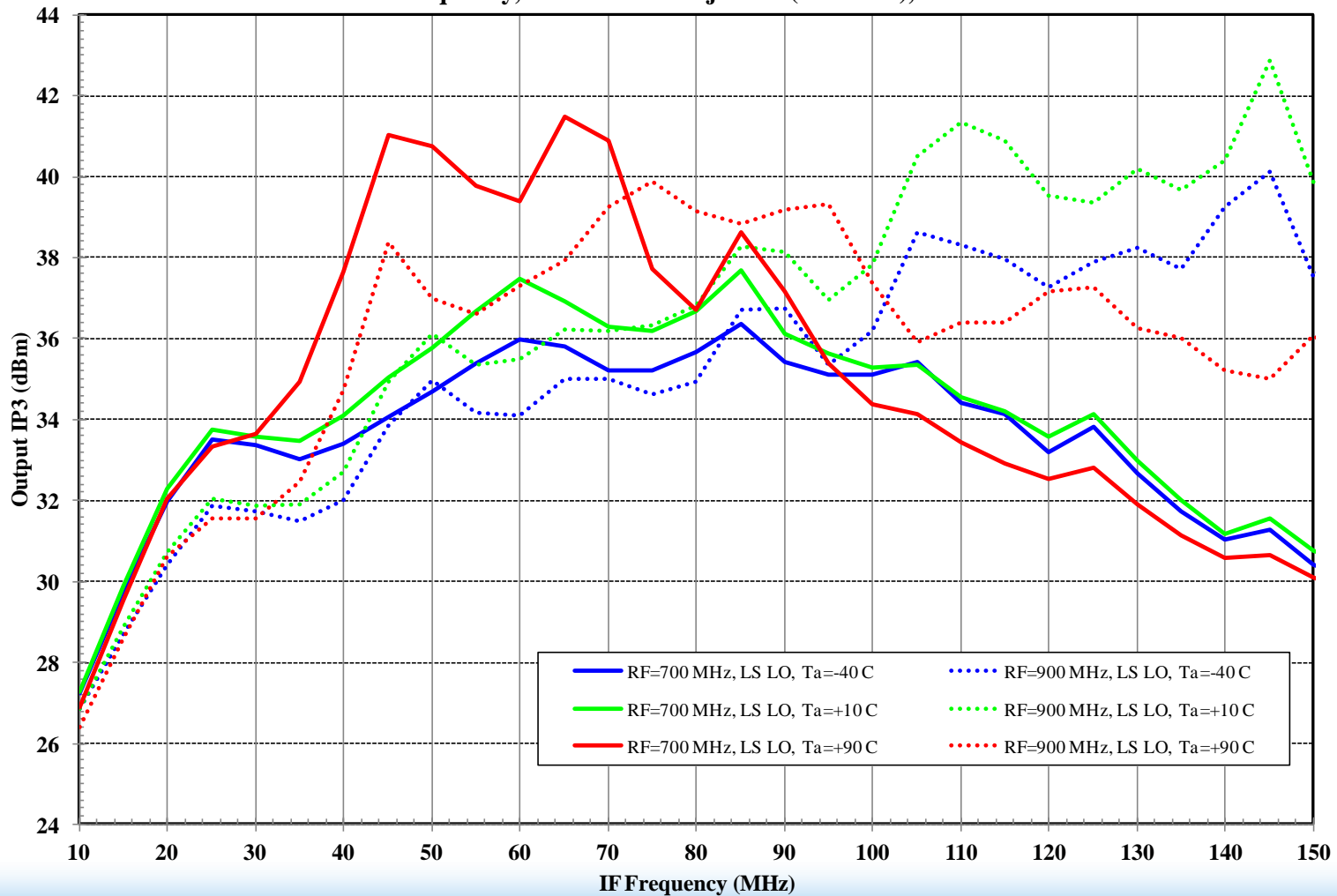

# Characterization – IIP3, High Side LO

F1102 RF to IF Dual Downconverting Mixer  
Low Frequency IF Circuitry,  $V_{cc-IF} = +3.3\text{ V}$ ,  $V_{cc} = +5.0\text{ V}$   
RF Fixed Frequency, High Side LO Injection ( $RF < LO$ ),  $IF = LO - RF$

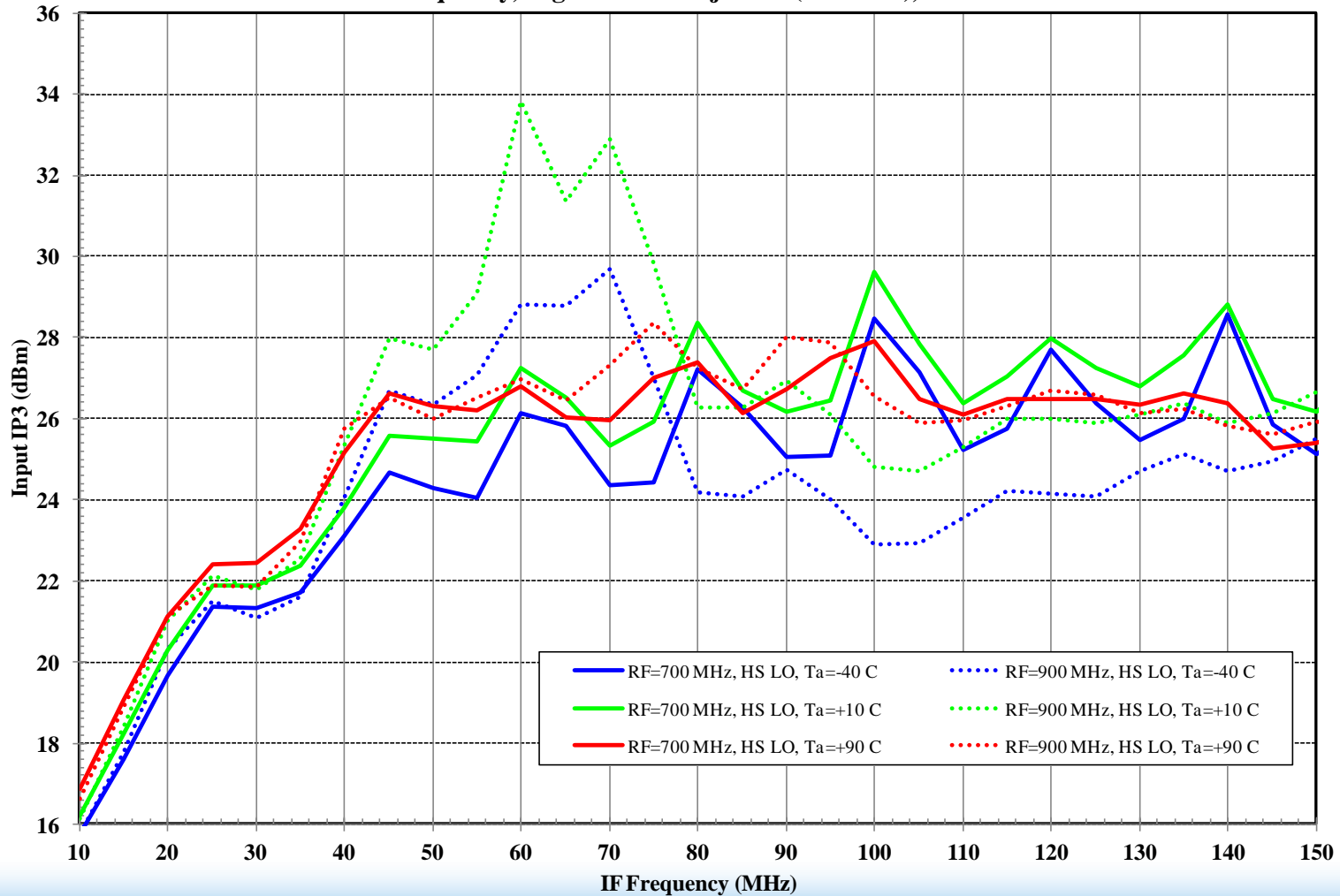

# Characterization – IIP3, Low Side LO

F1102 RF to IF Dual Downconverting Mixer  
Low Frequency IF Circuitry,  $V_{cc-IF} = +3.3\text{ V}$ ,  $V_{cc} = +5.0\text{ V}$   
RF Fixed Frequency, Low Side LO Injection ( $RF > LO$ ),  $IF = RF - LO$

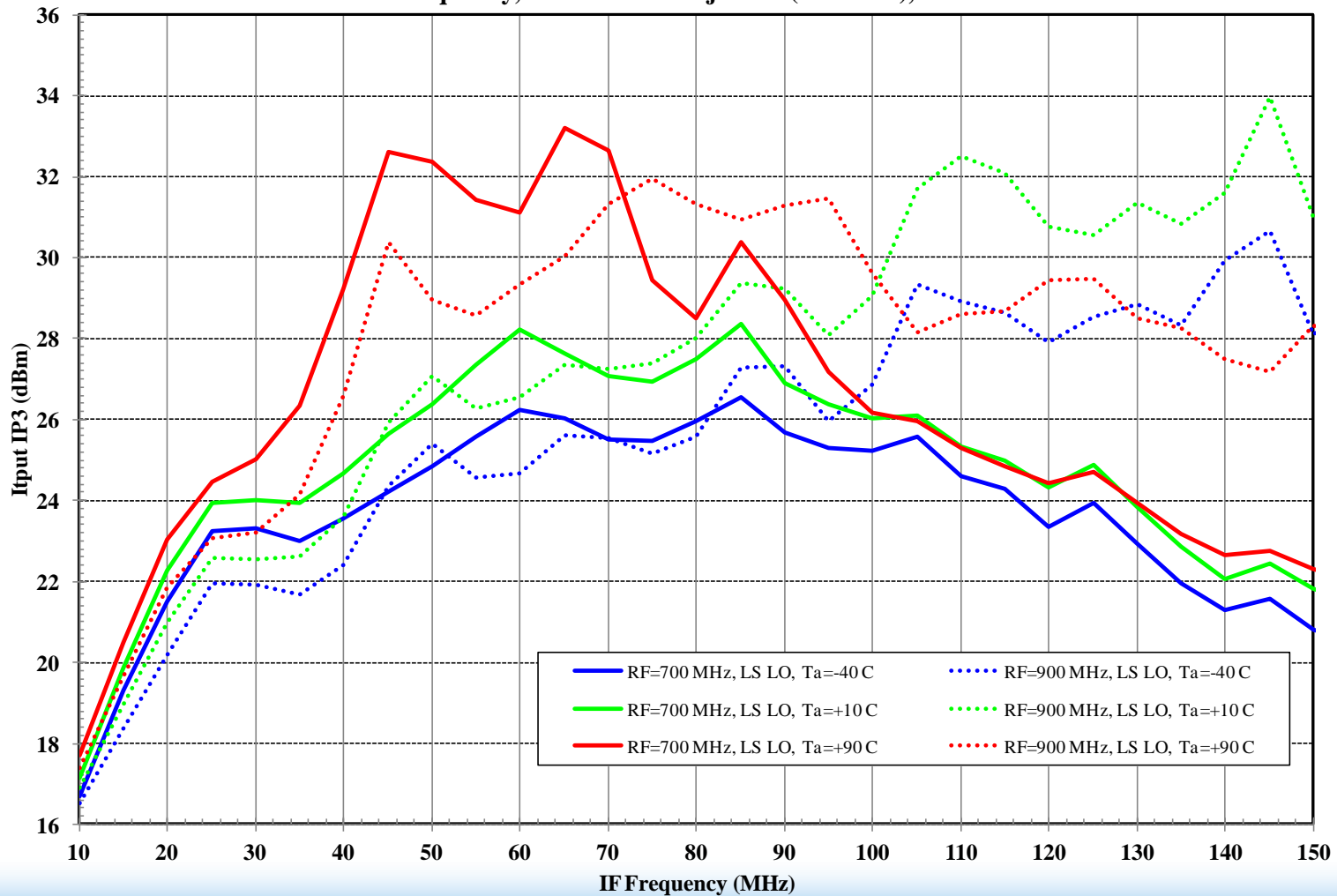

# Characterization – DC Power, High Side LO

F1102 RF to IF Dual Downconverting Mixer  
Low Frequency IF Circuitry,  $V_{cc-IF} = +3.3\text{ V}$ ,  $V_{cc} = +5.0\text{ V}$   
RF Fixed Frequency, High Side LO Injection ( $RF < LO$ ),  $IF = LO - RF$

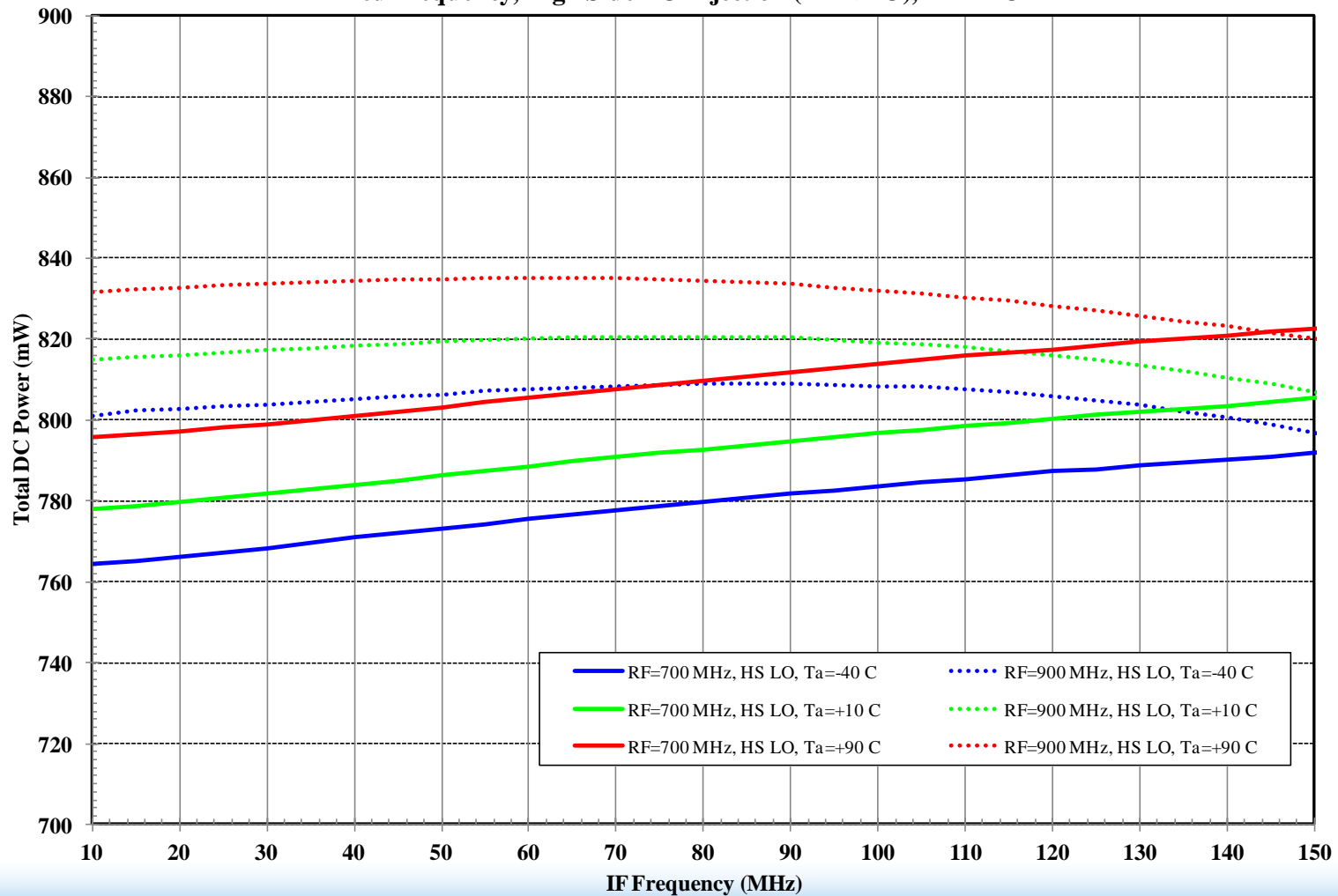

# Characterization – DC Power, Low Side LO

F1102 RF to IF Dual Downconverting Mixer  
Low Frequency IF Circuitry,  $V_{cc-IF} = +3.3\text{ V}$ ,  $V_{cc} = +5.0\text{ V}$   
RF Fixed Frequency, Low Side LO Injection ( $RF > LO$ ),  $IF = RF - LO$

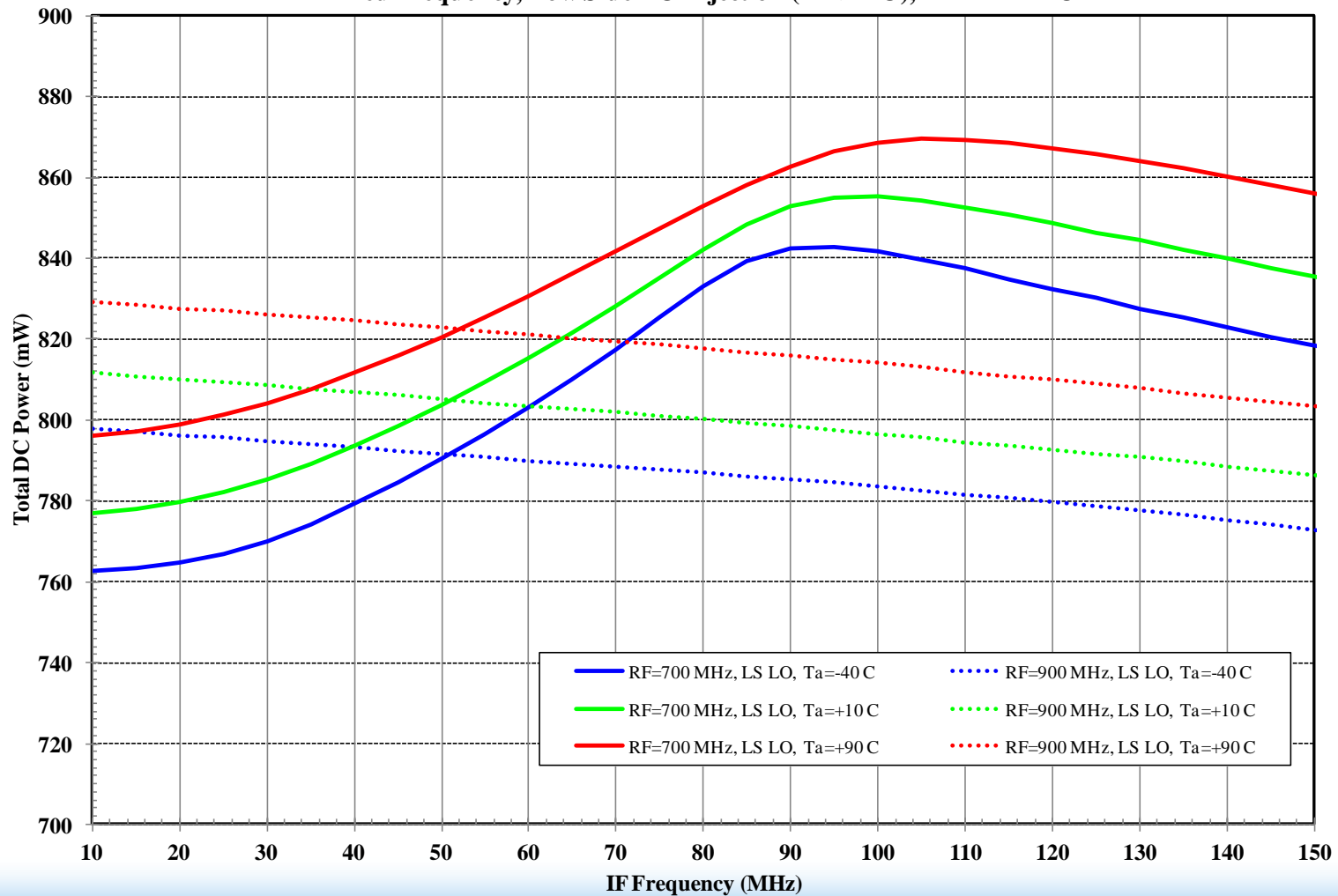



# Characterization – OP1dB, High Side LO

F1102 RF to IF Dual Downconverting Mixer  
Low Frequency IF Circuitry,  $V_{cc-IF} = +3.3\text{ V}$ ,  $V_{cc} = +5.0\text{ V}$   
RF Fixed Frequency, High Side LO Injection ( $RF < LO$ ),  $IF = LO - RF$

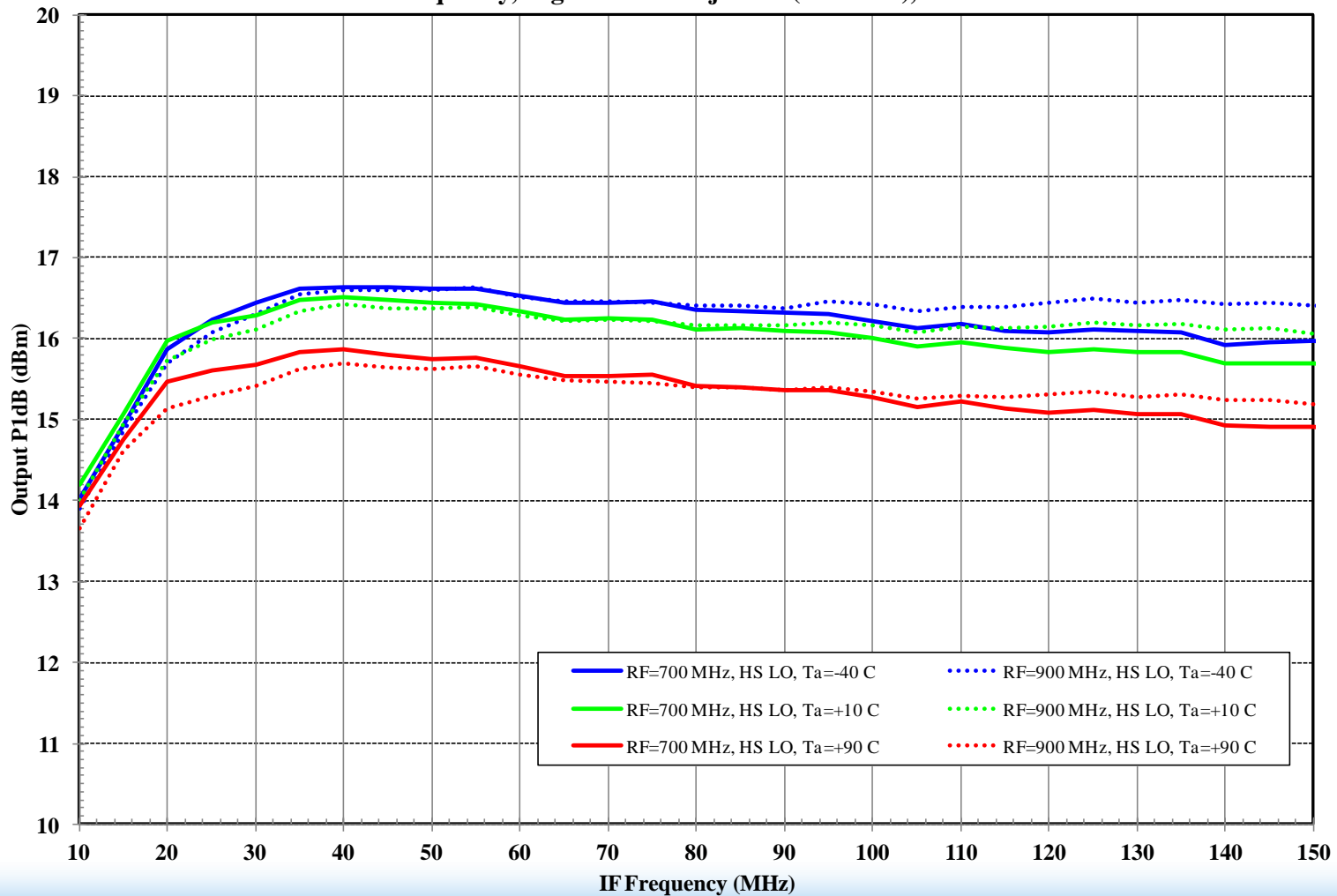

# Characterization – OP1dB, Low Side LO

F1102 RF to IF Dual Downconverting Mixer  
Low Frequency IF Circuitry,  $V_{cc-IF} = +3.3\text{ V}$ ,  $V_{cc} = +5.0\text{ V}$   
RF Fixed Frequency, Low Side LO Injection ( $RF > LO$ ),  $IF = RF - LO$

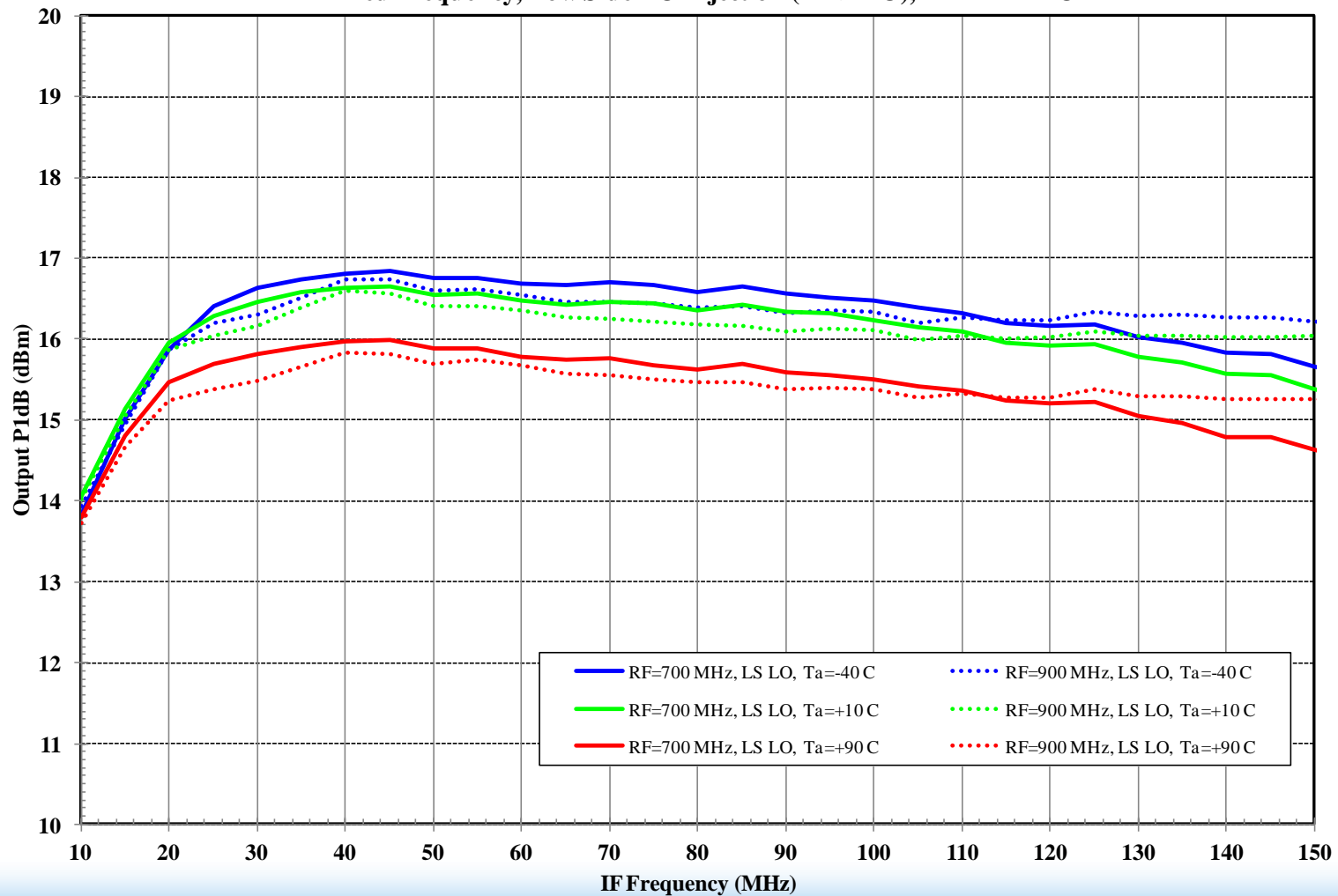

# Characterization – OIP2, High Side LO

F1102 RF to IF Dual Downconverting Mixer  
Low Frequency IF Circuitry,  $V_{cc-IF} = +3.3\text{ V}$ ,  $V_{cc} = +5.0\text{ V}$   
RF Fixed Frequency, High Side LO Injection ( $RF < LO$ ),  $IF = LO - RF$

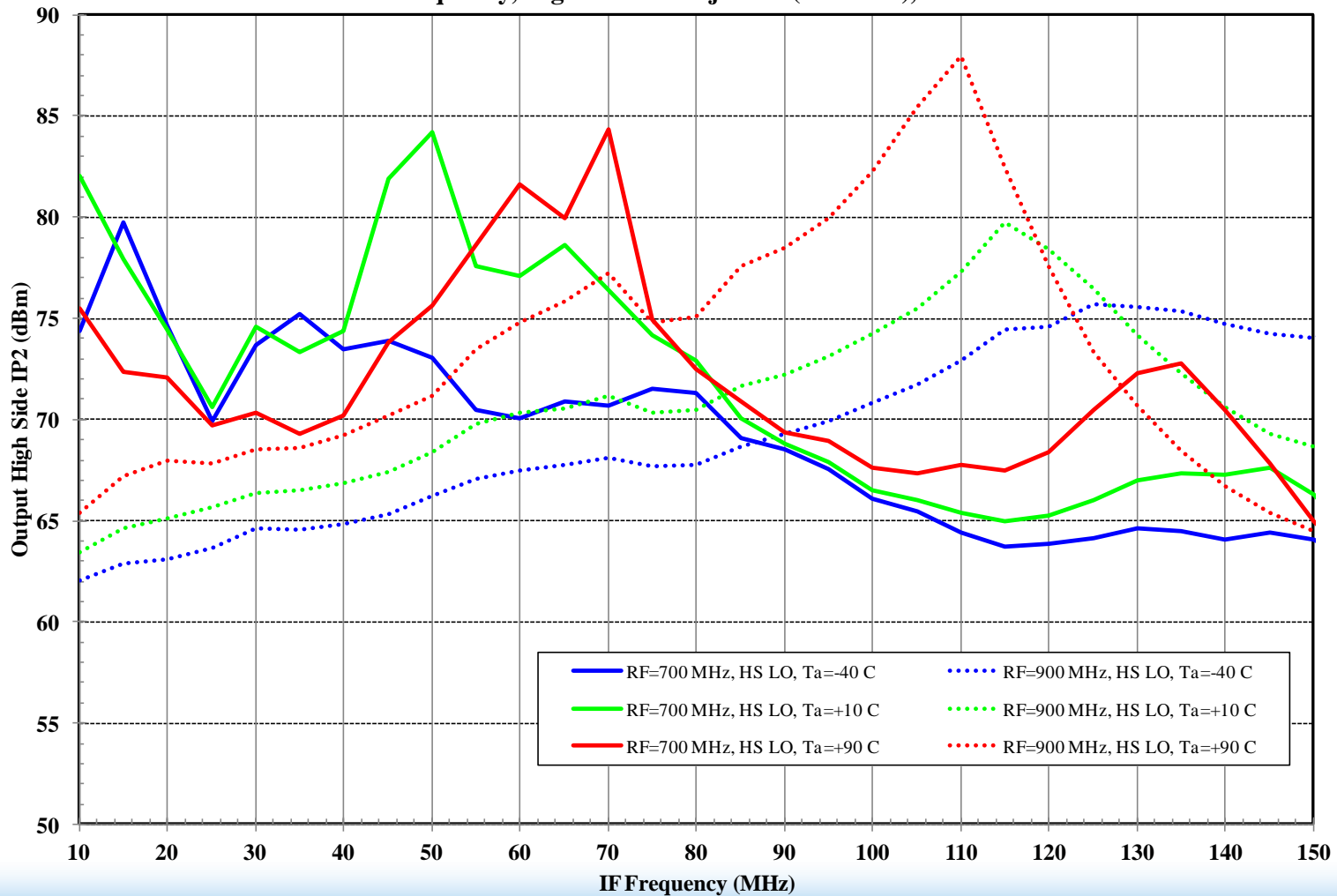

# Characterization – OIP2, Low Side LO

F1102 RF to IF Dual Downconverting Mixer  
Low Frequency IF Circuitry,  $V_{cc-IF} = +3.3\text{ V}$ ,  $V_{cc} = +5.0\text{ V}$   
RF Fixed Frequency, Low Side LO Injection ( $RF > LO$ ),  $IF = RF - LO$

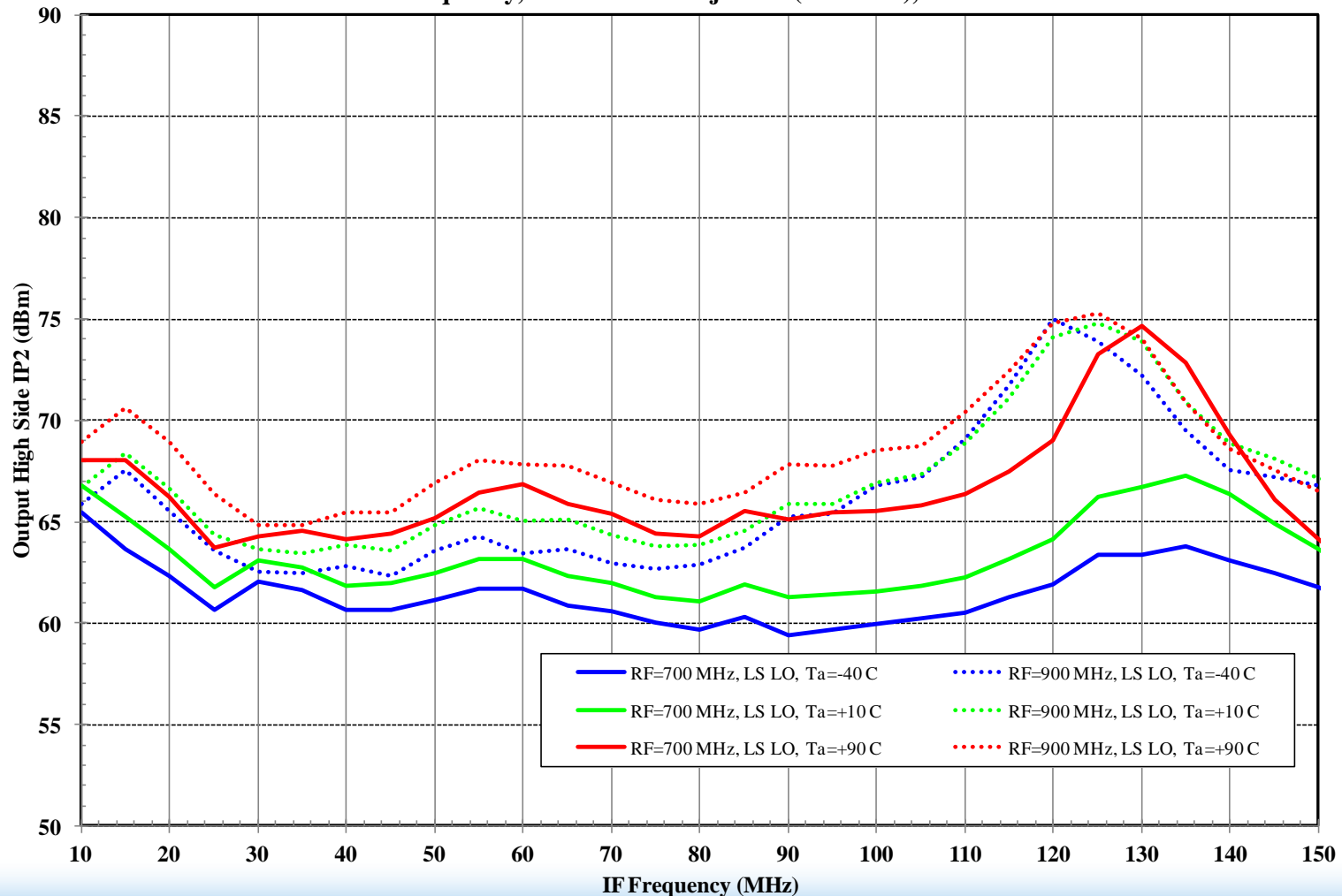

# Characterization – 2x2 Rejection, High Side LO

F1102 RF to IF Dual Downconverting Mixer  
Low Frequency IF Circuitry,  $V_{cc-IF} = +3.3\text{ V}$ ,  $V_{cc} = +5.0\text{ V}$   
RF Fixed Frequency, High Side LO Injection ( $RF < LO$ ),  $IF = LO - RF$

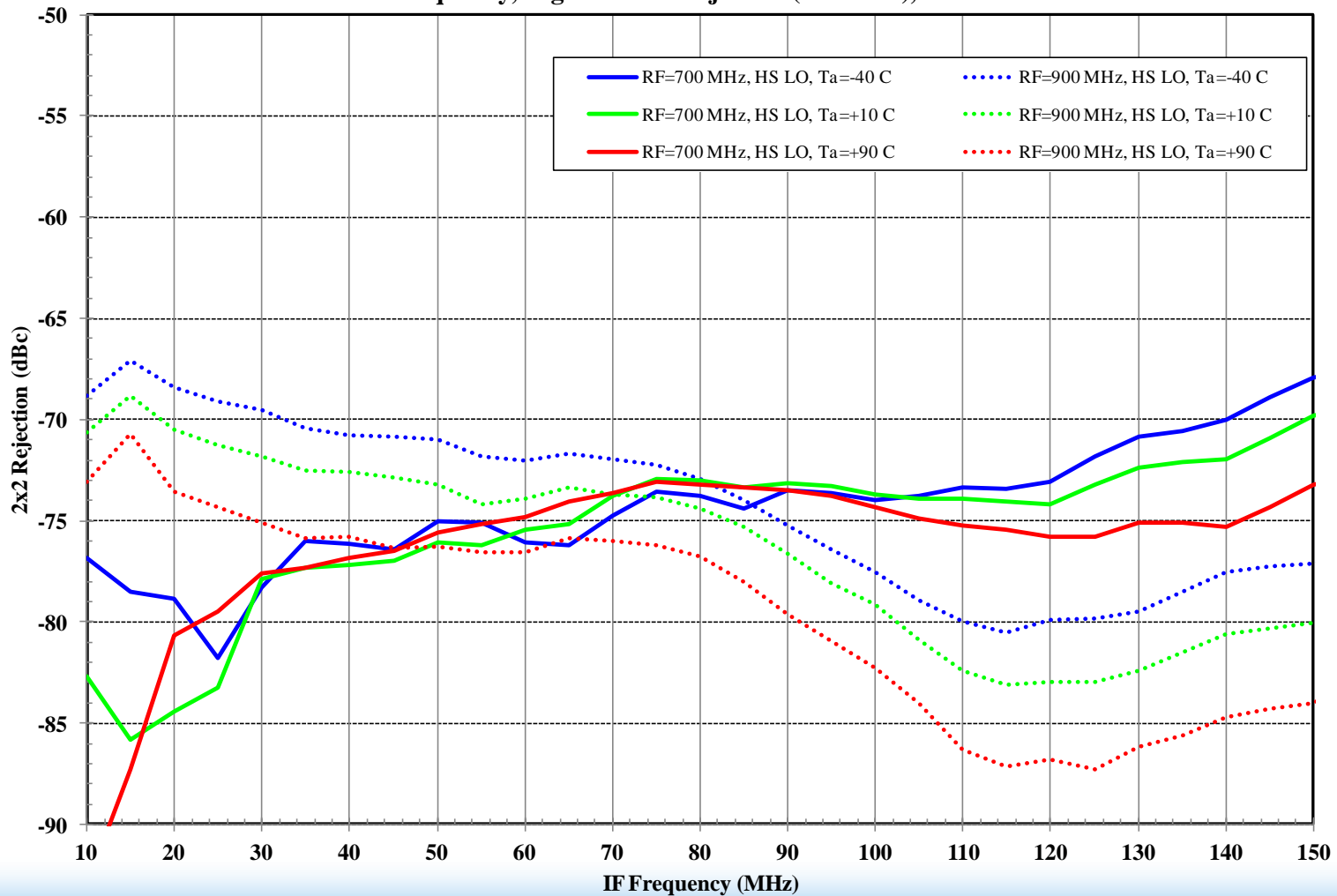

# Characterization – 2x2 Rejection, Low Side LO

F1102 RF to IF Dual Downconverting Mixer  
Low Frequency IF Circuitry,  $V_{cc-IF} = +3.3\text{ V}$ ,  $V_{cc} = +5.0\text{ V}$   
RF Fixed Frequency, Low Side LO Injection ( $RF > LO$ ),  $IF = RF - LO$

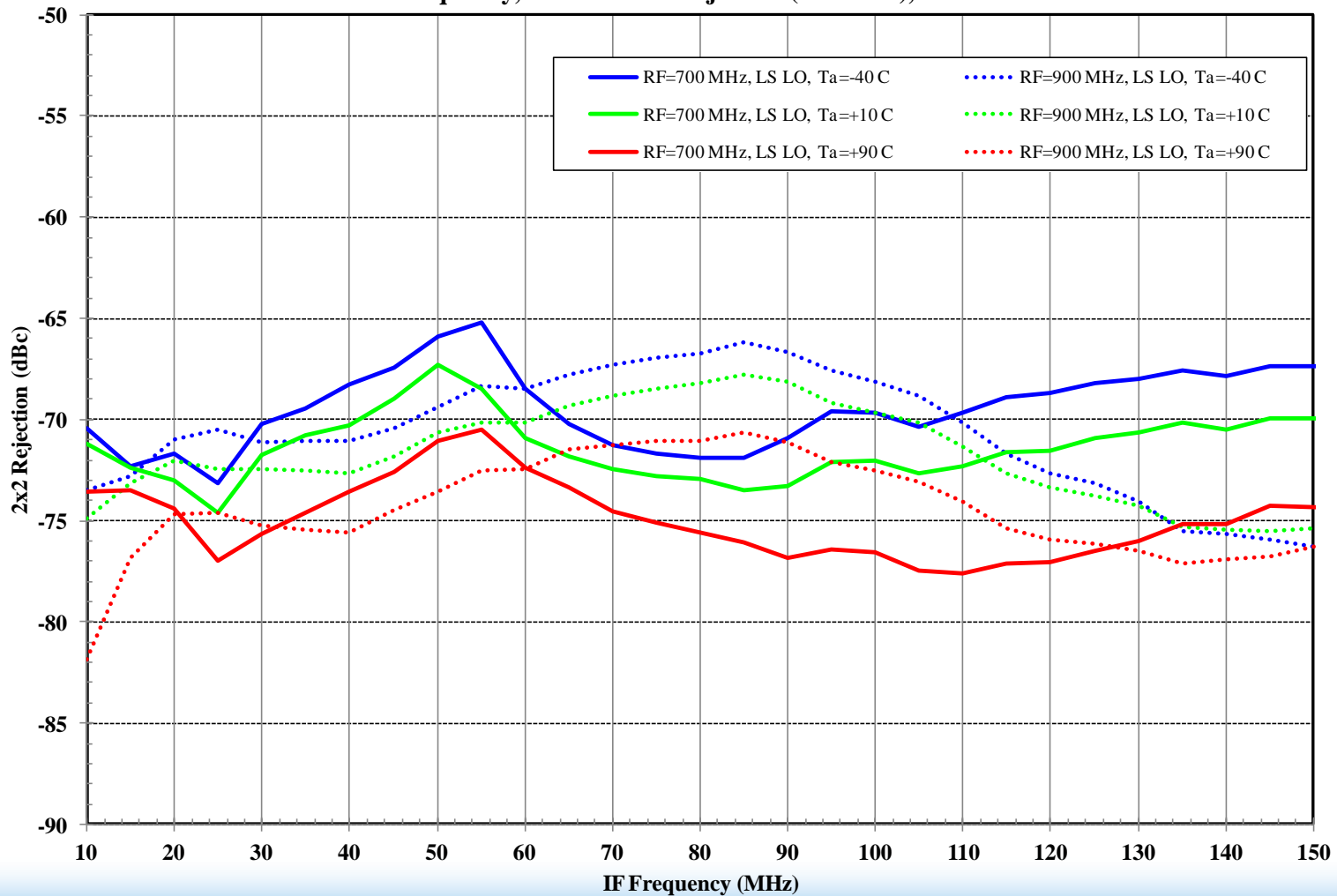

# Characterization – 3x3 Rejection, High Side LO

F1102 RF to IF Dual Downconverting Mixer  
Low Frequency IF Circuitry,  $V_{cc-IF} = +3.3\text{ V}$ ,  $V_{cc} = +5.0\text{ V}$   
RF Fixed Frequency, High Side LO Injection ( $RF < LO$ ),  $IF = LO - RF$

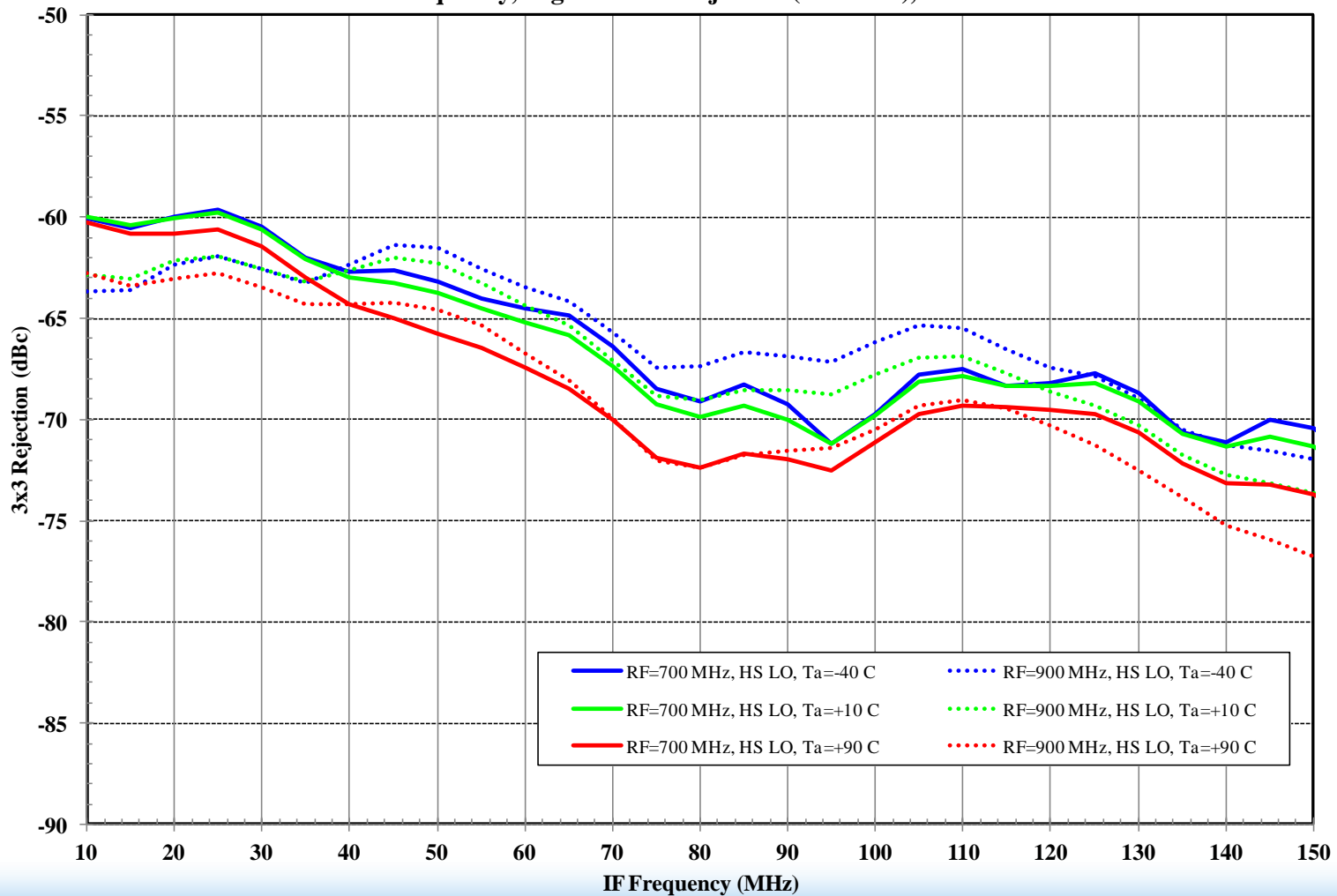

# Characterization – 3x3 Rejection, Low Side LO

F1102 RF to IF Dual Downconverting Mixer  
Low Frequency IF Circuitry,  $V_{cc-IF} = +3.3\text{ V}$ ,  $V_{cc} = +5.0\text{ V}$   
RF Fixed Frequency, Low Side LO Injection ( $RF > LO$ ),  $IF = RF - LO$

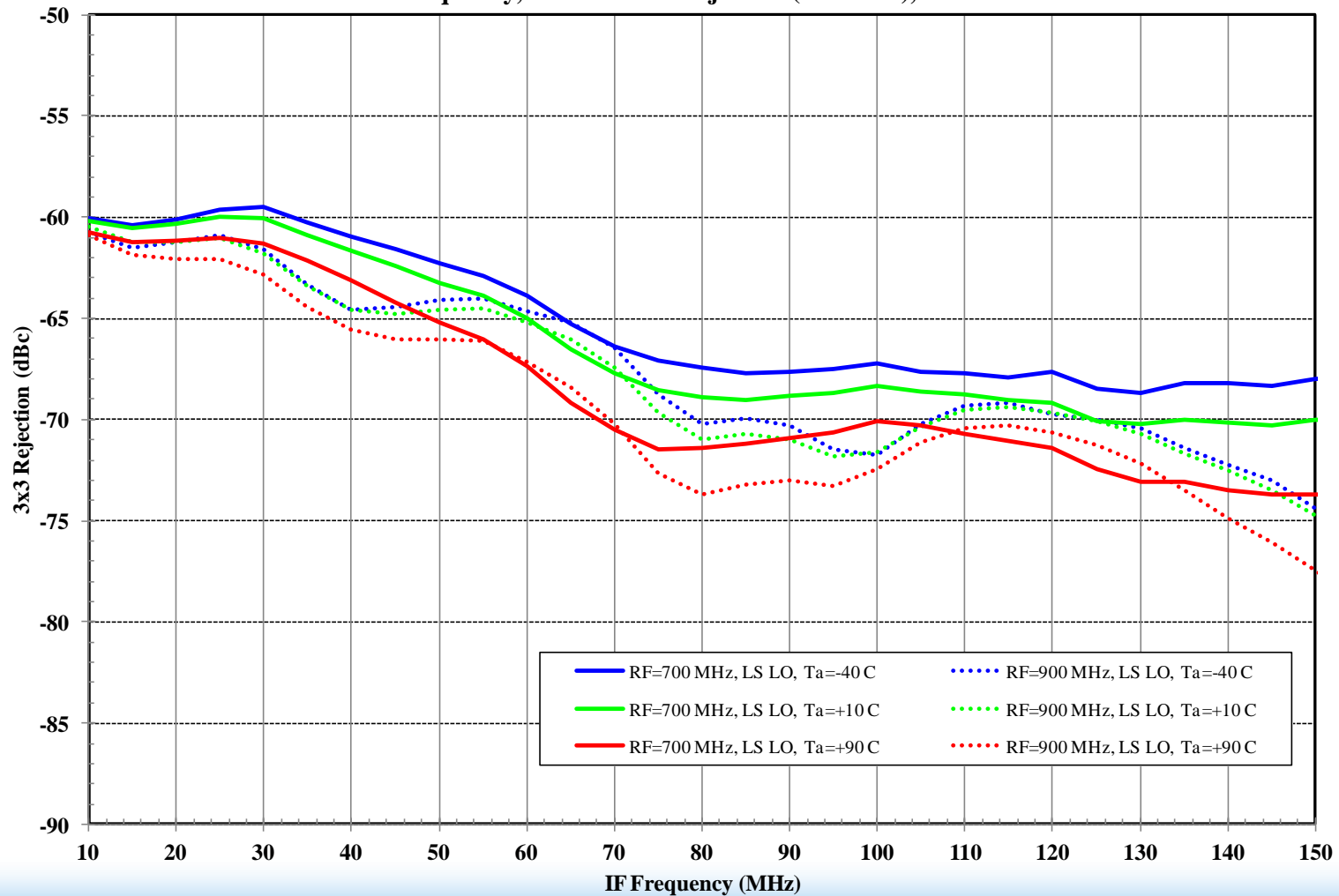



# Characterization – Comparison of Noise Figure, +25 C

**F1102 RF to IF Dual Downconverting Mixer**  
**Low Frequency IF Circuitry, RF Fixed Frequency, +25 C**  
**Standard Low Current Mode versus Optimized for Current**



# Characterization – Standard Measurement Parameters

- Standard Low Current mode was used for all measurements. The resistors used are:
  - IF\_BiasA = IF\_BiasB = 62 ohms
  - LO1\_Adj\_Bias = 180 ohms
  - LO2\_Adj\_Bias = 1900 ohms
- Everything else is the same.
- Selected Data is being presented



# Characterization – LC Gain, High Side LO

F1102 RF to IF Dual Downconverting Mixer  
Low Frequency IF Circuitry,  $V_{cc-IF}=V_{cc}=+5.0\text{ V}$   
RF Fixed Frequency, High Side LO Injection ( $RF < LO$ ),  $IF = LO - RF$

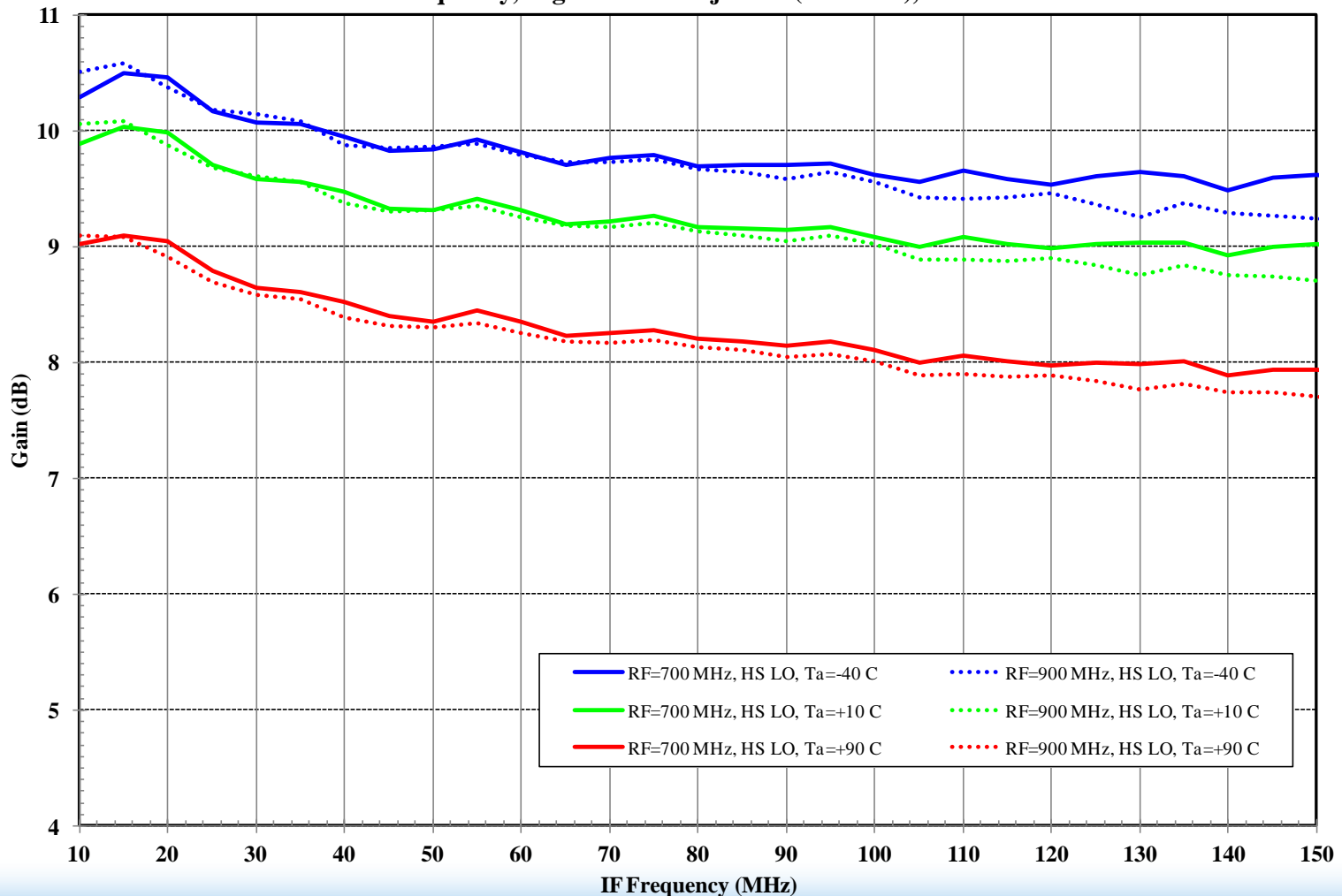

# Characterization – LC Gain, Low Side LO

F1102 RF to IF Dual Downconverting Mixer  
Low Frequency IF Circuitry,  $V_{cc-IF}=V_{cc} = +5.0\text{ V}$   
RF Fixed Frequency, Low Side LO Injection ( $RF > LO$ ),  $IF = RF - LO$

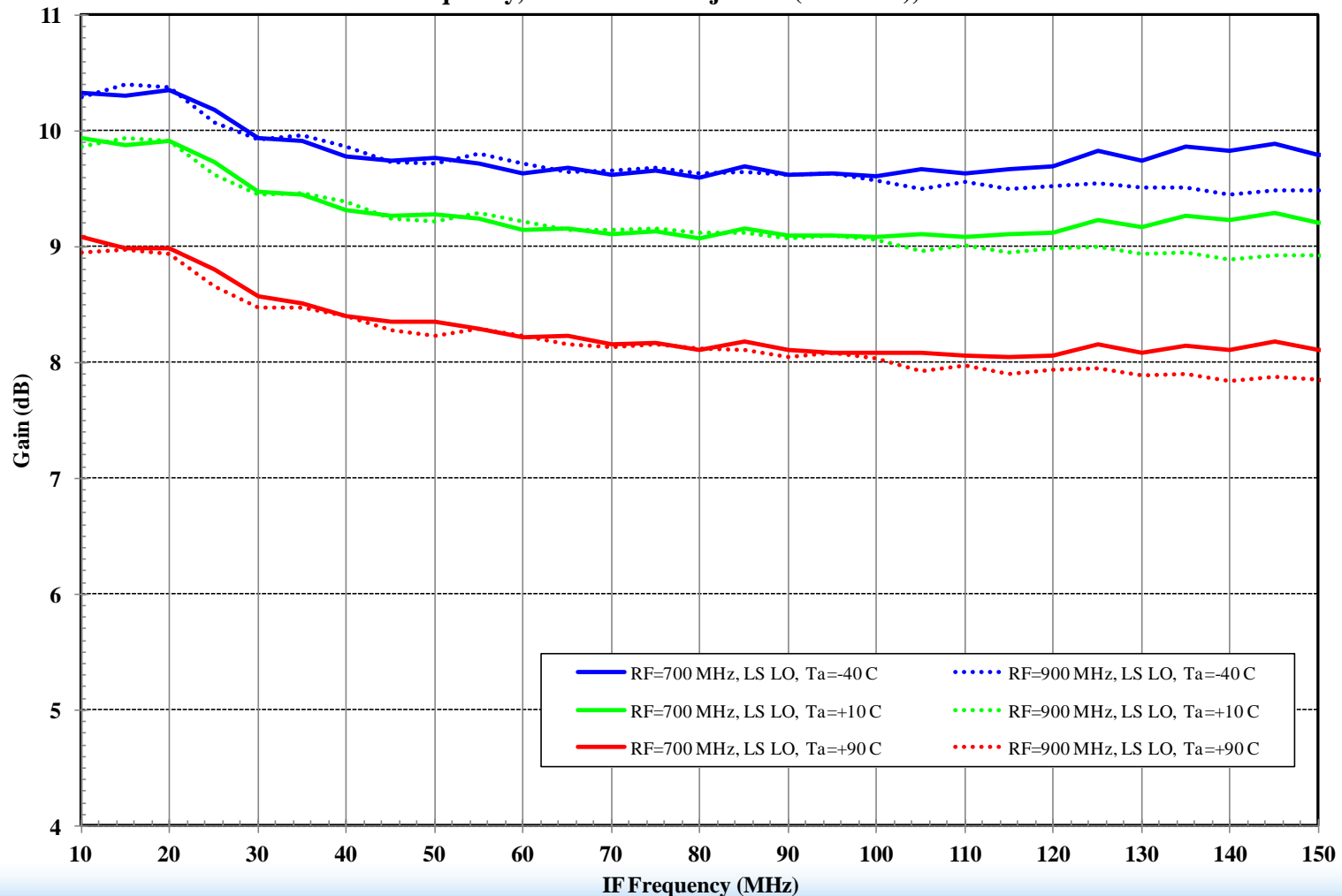

# Characterization – LC DC Power, High Side LO

F1102 RF to IF Dual Downconverting Mixer  
Low Frequency IF Circuitry,  $V_{cc-IF}=V_{cc} = +5.0\text{ V}$   
RF Fixed Frequency, High Side LO Injection ( $RF < LO$ ),  $IF = LO - RF$

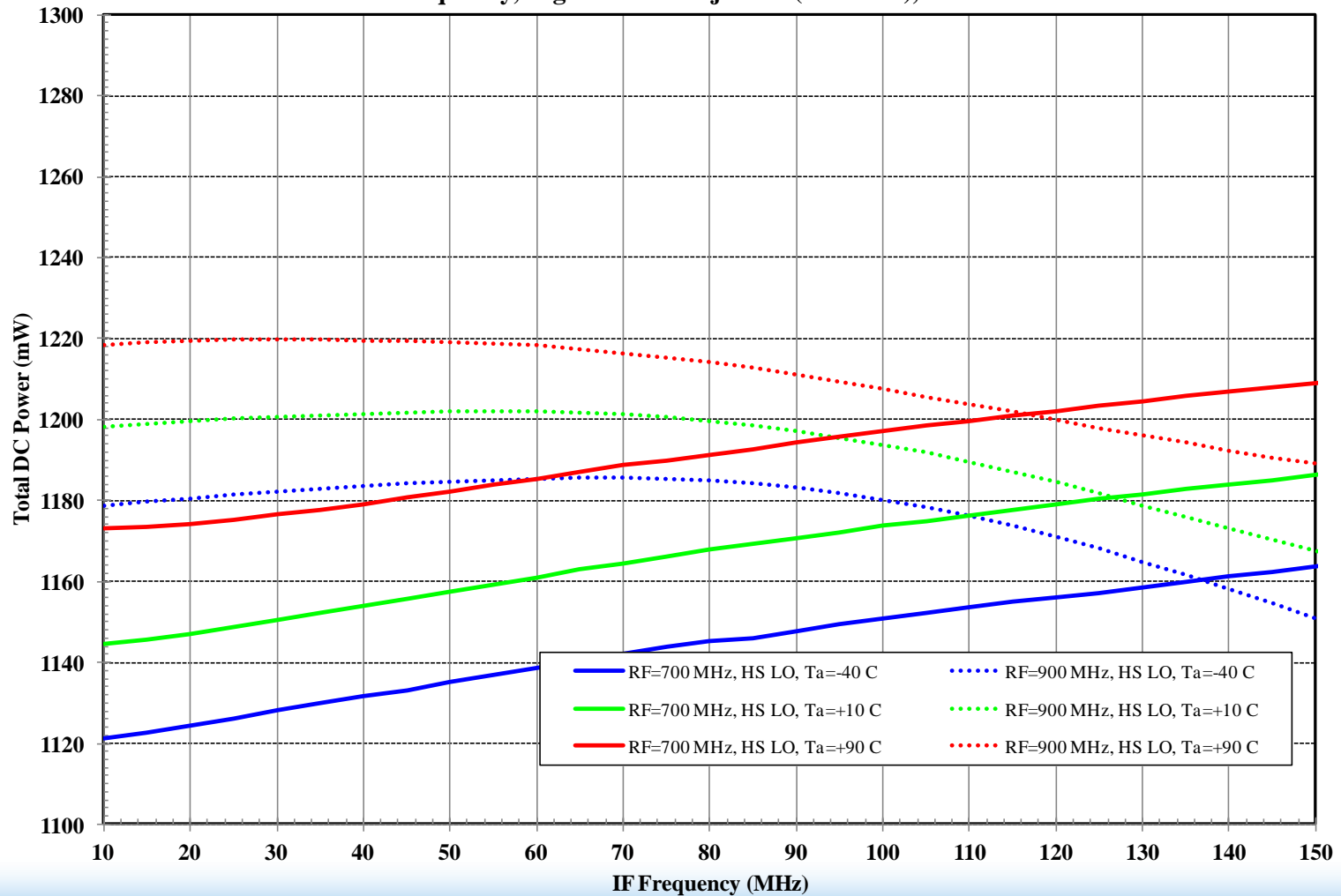

# Characterization – LC DC Power, LO Side LO

**F1102 RF to IF Dual Downconverting Mixer**  
**Low Frequency IF Circuitry,  $V_{cc-IF}=V_{cc} = +5.0\text{ V}$**   
**RF Fixed Frequency, Low Side LO Injection ( $RF > LO$ ),  $IF = RF - LO$**

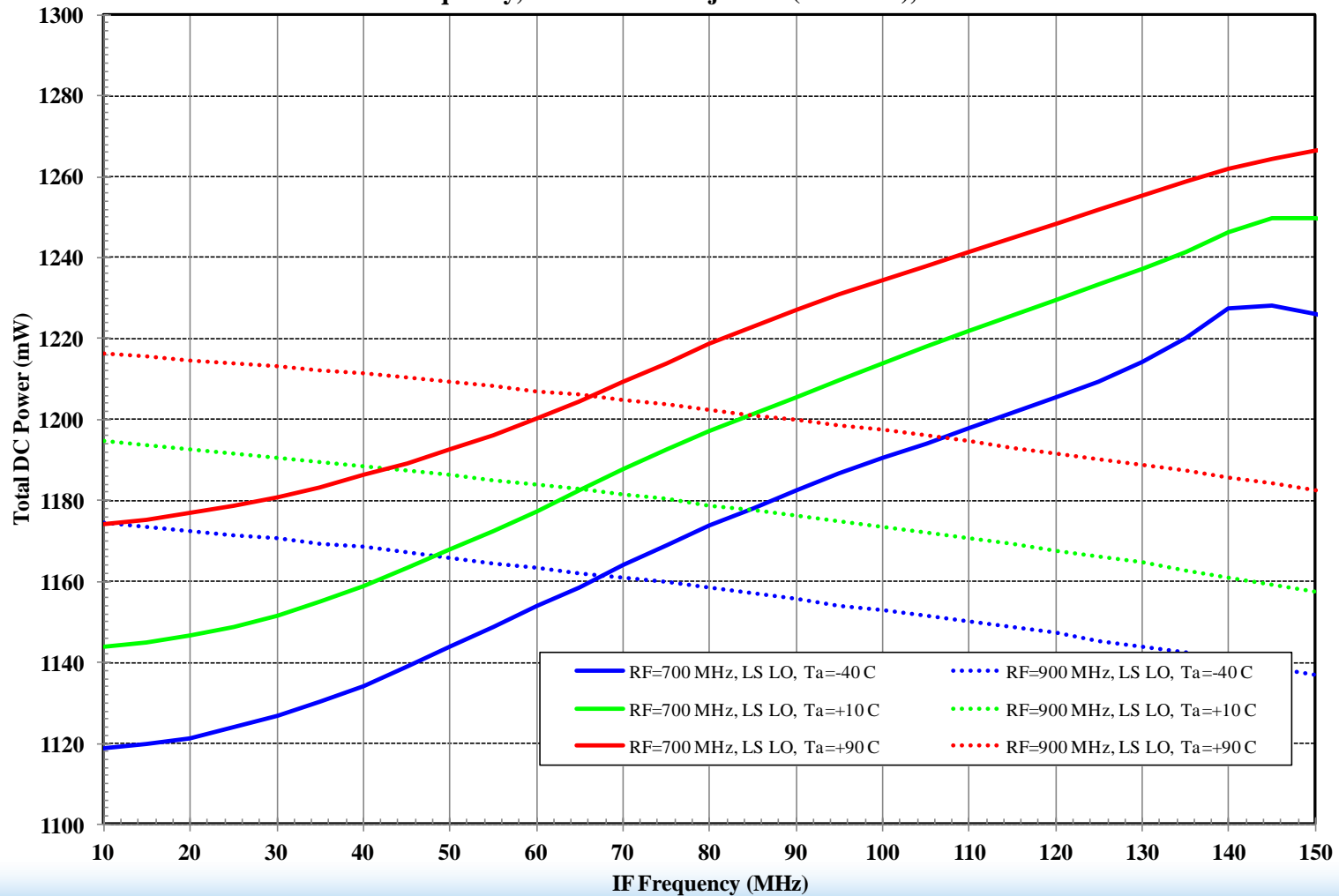

# Characterization – LC OP1dB, High Side LO

F1102 RF to IF Dual Downconverting Mixer  
Low Frequency IF Circuitry,  $V_{cc-IF}=V_{cc} = +5.0\text{ V}$   
RF Fixed Frequency, High Side LO Injection ( $RF < LO$ ),  $IF = LO - RF$

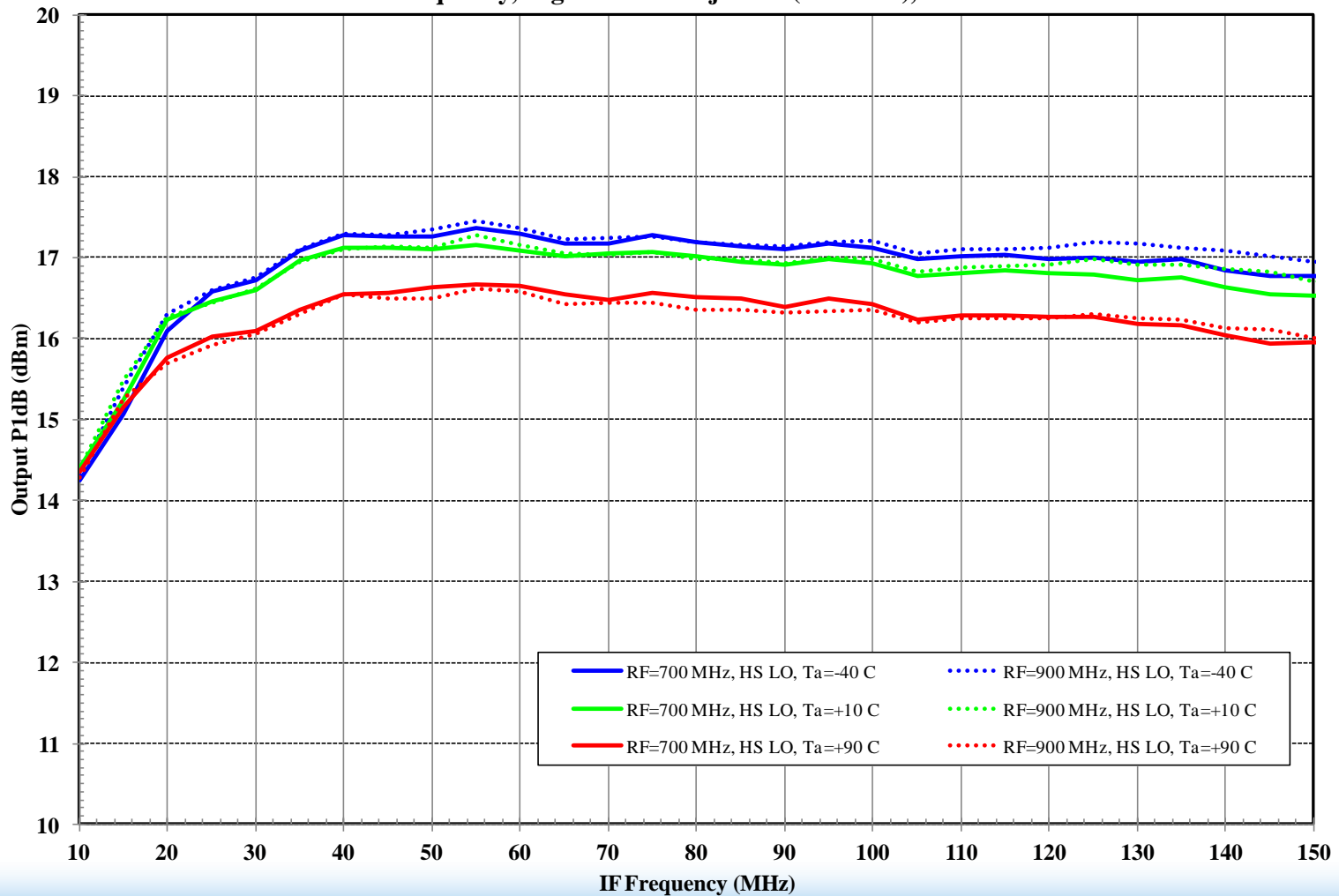

# Characterization – LC OP1dB, LO Side LO

F1102 RF to IF Dual Downconverting Mixer  
Low Frequency IF Circuitry,  $V_{cc-IF}=V_{cc}=+5.0\text{ V}$   
RF Fixed Frequency, Low Side LO Injection ( $RF > LO$ ),  $IF = RF - LO$

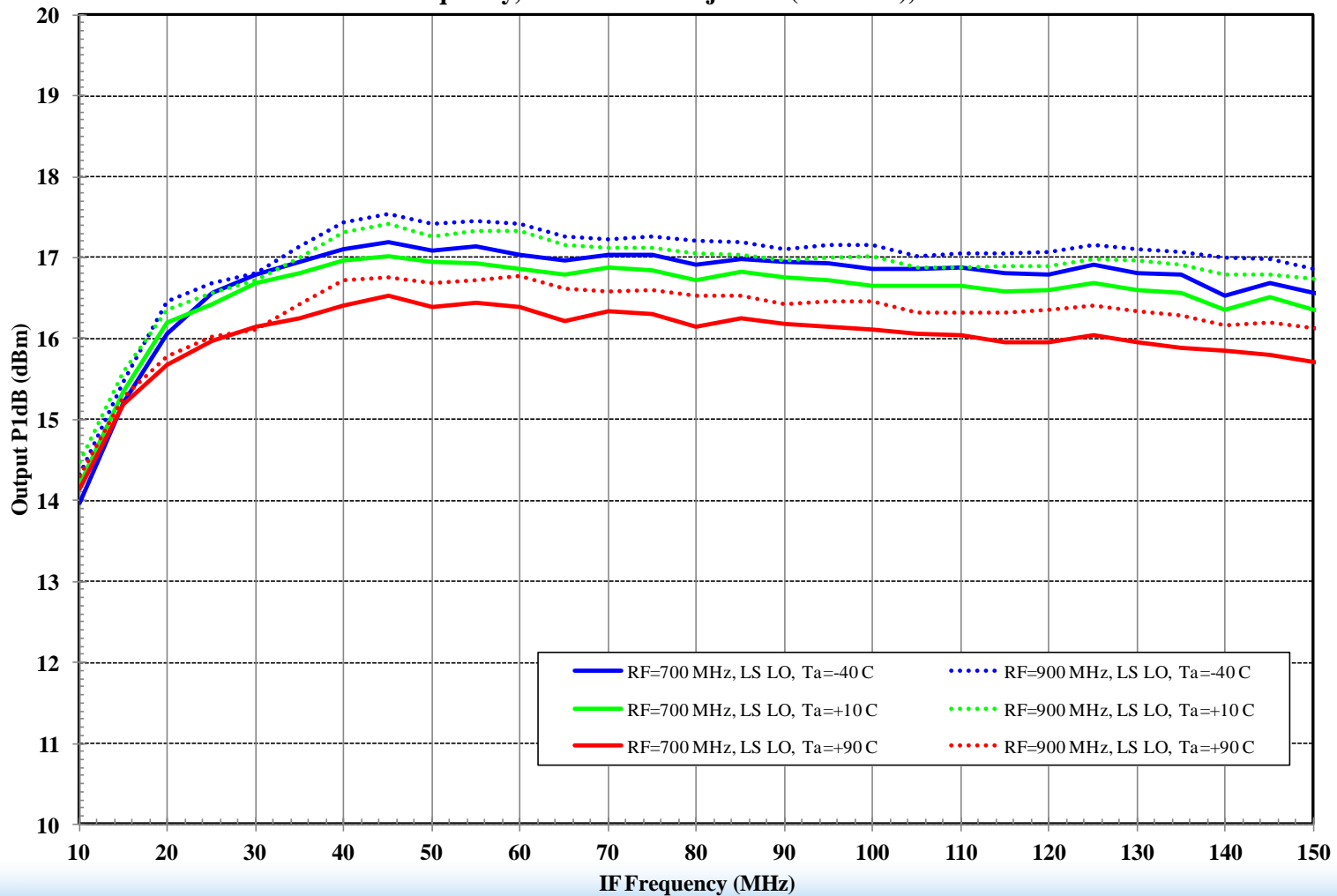



# Conclusion

- Less than 0.5 dB difference in gain.
  - DC Power has been reduced by 32 %  
(1280 mW to 880 mW).
  - Less than 1 dB loss in Output P1dB.
  - No significant difference for IP3.
  - No significant difference in the Noise Figure.
- 
- ***DC Power can be reduced with very little RF performance difference.***

