

Auto Sync Separator Circuit for EL1883 in HDTV application

**Introduction**

Originally, the EL1883 is designed to use in the NTSC, PAL and SECAM (Bi-level sync) applications. But with some external circuitries, it can also be used to separate most of the HDTV (Tri-level sync) signals automatically.

**Circuit Description**

Normally, the EL1883 uses a resistor  $R_{SET}$  to control the internal timing. It is a current source and the current is set by the value of  $R_{SET}$ . The resistor  $R_{SET}$  needs to be changed

for different line rate. With the following frequency to current conversion circuit, the EL1883 can detect most of the HDTV video signals automatically without changing  $R_{SET}$ . The composite sync is passed through an emitter follower Q1. The differentiator C2 and R5 generates a positive going voltage spike at the rise edge of the composite sync pulse. The voltage spike turns on Q2 and discharge C4. R1 is used to reduce the miller capacitor coupling effect on C4. R2, R3, C3 and C4 form a charge tank.

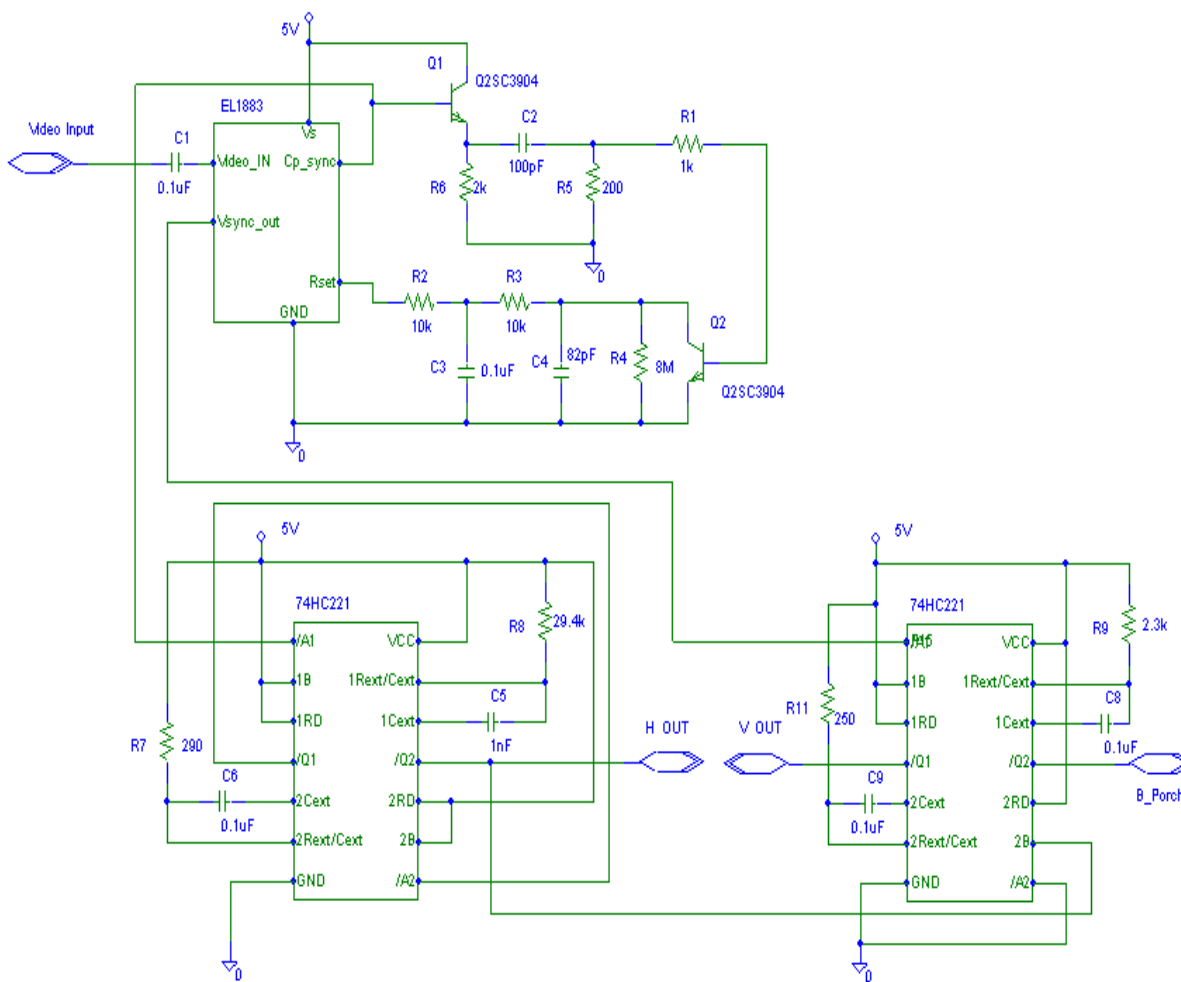

As the line rate increases, the discharge rate also increases. The average current sources out from R<sub>SET</sub> pin increases. R4 is a start up resistor.

Using the 74HC221, a dual non-retriggerable monostable multivibrator, can generate a true horizontal line, back porch pulse and vertical line.

### Horizontal Sync and Back porch generator

The composite sync is input to /A1 pin of the 74HC221. R8 and C5 set the pulse width at about 21μs to eliminate the half line pulse for the composite sync. The output of /Q1 is connected to /A2. R7 and C6 set the pulse width of the output horizontal sync to about 4μs. The Back porch pulse can be used for DC restored application and generated from the Horizontal Sync

### Performance Curves

CH1---Composite Video input  
CH2---Composite Video output  
CH3---Horizontal Sync output  
CH4---Vertical Sync output

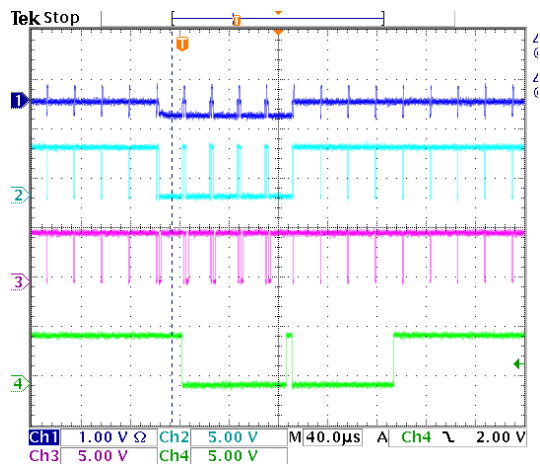

FIGURE 1. 720P50---OUTPUT FROM EL1883

output. R11 and C9 set the pulse width to be about 5μs for the Back Porch output.

### Vertical Sync generator

The Vertical Sync from EL1883 is connected to /A1 of the 74HC221. R9 and C8 set the output pulse width to about 180μs to eliminate the double pulse from the EL1883's Vertical Sync. The vertical pulse should have only the leading negative going edge used for timing as the trailing edge is a timer pulse and not hard synced to the video.

With the above circuit, it works for the following HDTV signals: 720P50~60, 1035I29~30, 1080I23~30 and 1080P23~30. It doesn't work for 1080P50~60.

CH1---Composite Video input  
CH2---Composite Video output  
CH3---Horizontal Sync output  
CH4---Vertical Sync output

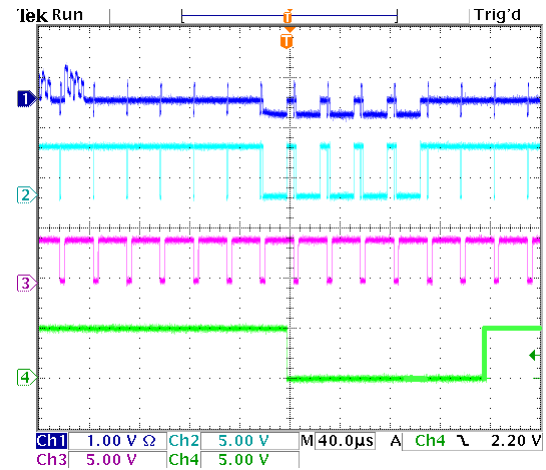

FIGURE 2. 720P50---OUTPUT AFTER THE 74HC221

Performance Curves (Continued)

CH1---Composite Video input  
CH2---Composite Video output  
CH3---Horizontal Sync output  
CH4---Vertical Sync output

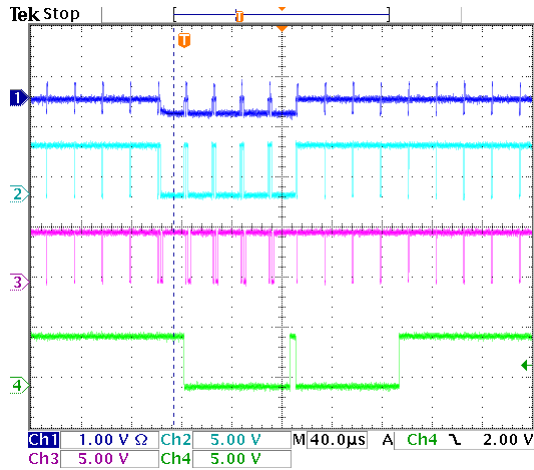

FIGURE 3. 720P59 AND 720P60---OUTPUT FROM EL1883

CH1---Composite Video input  
CH2---Composite Video output  
CH3---Horizontal Sync output  
CH4---Vertical Sync output

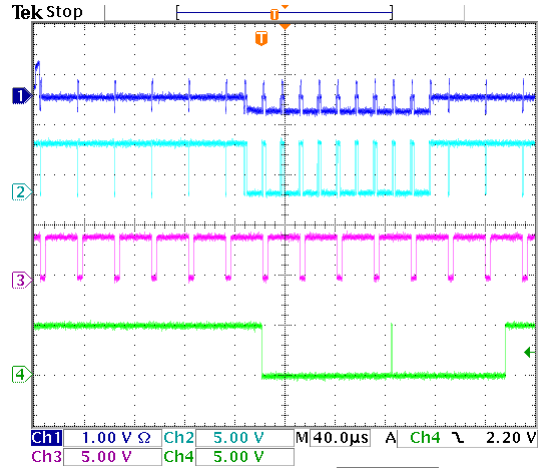

FIGURE 4. 1035I29---OUTPUT FROM EL1883

CH1---Composite Video input  
CH2---Composite Video output  
CH3---Horizontal Sync output  
CH4---Vertical Sync output

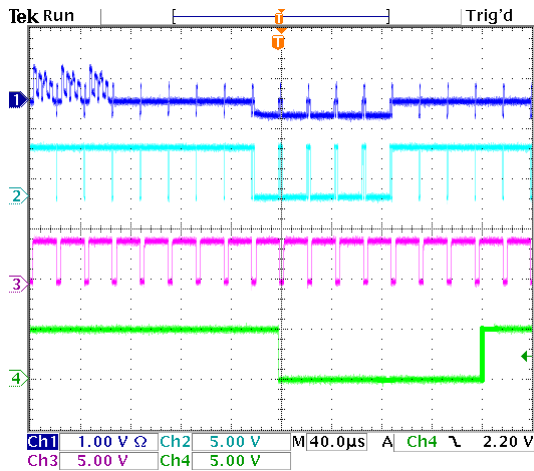

FIGURE 5. 720P59 AND 720P60---OUTPUT AFTER THE  
74HC221

CH1---Composite Video input  
CH2---Composite Video output  
CH3---Horizontal Sync output  
CH4---Vertical Sync output

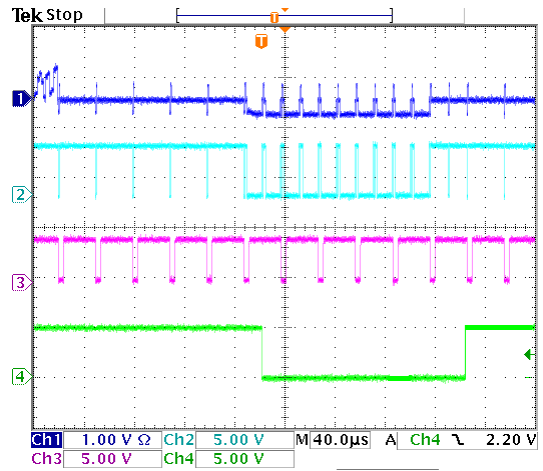

FIGURE 6. 1035I29---OUTPUT AFTER THE 74HC221

Performance Curves (Continued)

CH1---Composite Video input  
CH2---Composite Video output  
CH3---Horizontal Sync output  
CH4---Vertical Sync output

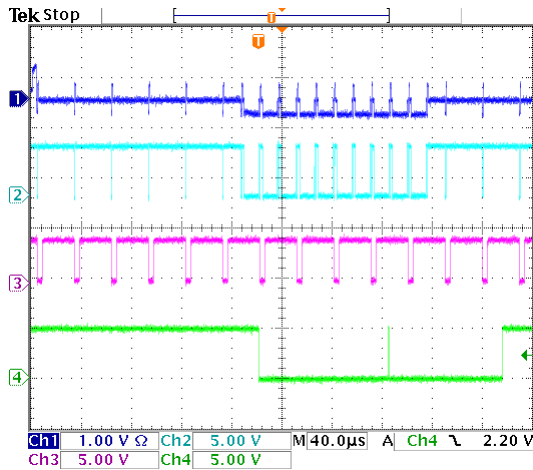

FIGURE 7. 1035I30---OUTPUT FROM EL1883

CH1---Composite Video input  
CH2---Composite Video output  
CH3---Horizontal Sync output  
CH4---Vertical Sync output

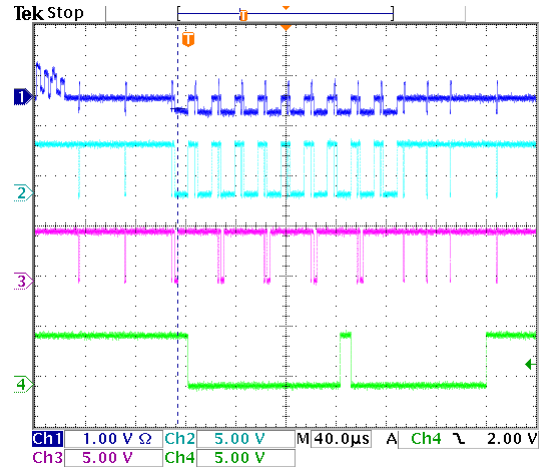

FIGURE 8. 1080I23 AND 1080I24---OUTPUT FROM EL1883

CH1---Composite Video input  
CH2---Composite Video output  
CH3---Horizontal Sync output  
CH4---Vertical Sync output

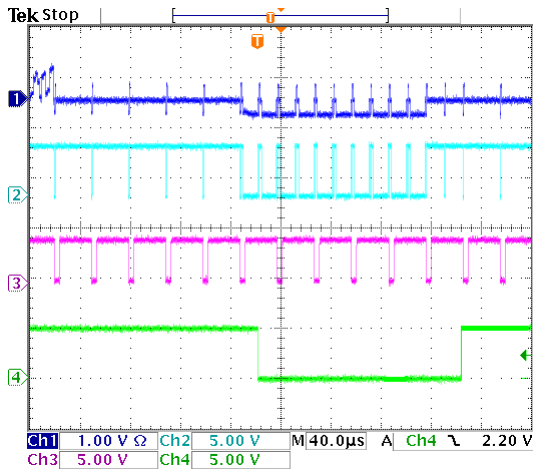

FIGURE 9. 1035I30---OUTPUT AFTER THE 74HC221

CH1---Composite Video input  
CH2---Composite Video output  
CH3---Horizontal Sync output  
CH4---Vertical Sync output

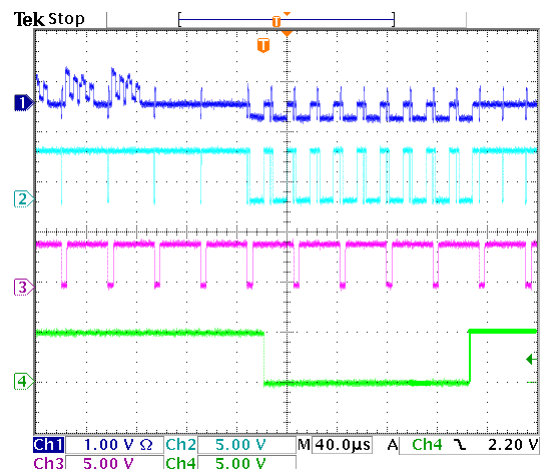

FIGURE 10. 1080I23 AND 1080I24---OUTPUT AFTER THE 74HC221

Performance Curves (Continued)

CH1---Composite Video input  
CH2---Composite Video output  
CH3---Horizontal Sync output  
CH4---Vertical Sync output

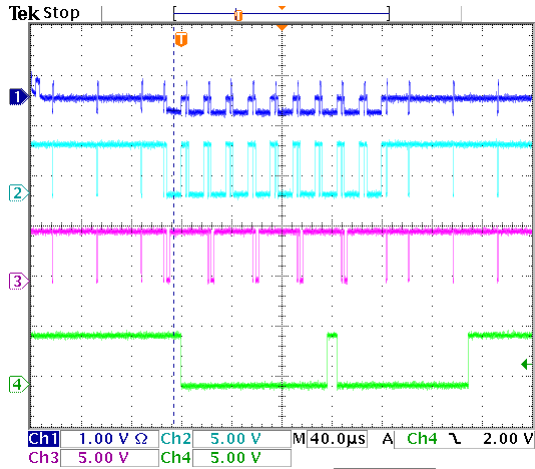

FIGURE 11. 1080I25 H28, V50---OUTPUT FROM EL1883

CH1---Composite Video input  
CH2---Composite Video output  
CH3---Horizontal Sync output  
CH4---Vertical Sync output

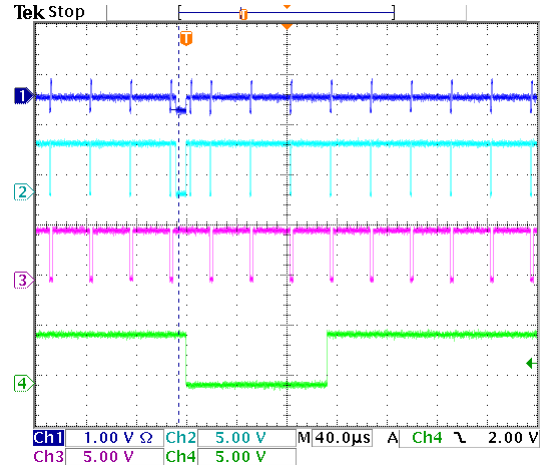

FIGURE 12. 1080I25 H31, V50---OUTPUT FROM EL1883

CH1---Composite Video input  
CH2---Composite Video output  
CH3---Horizontal Sync output  
CH4---Vertical Sync output

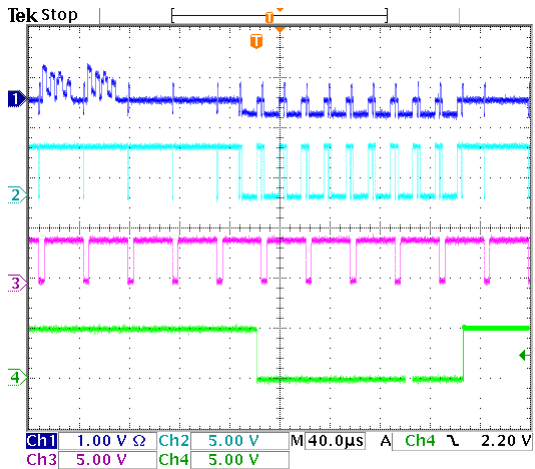

FIGURE 13. 1080I25 H28, V50---OUTPUT FROM 74HC221

CH1---Composite Video input  
CH2---Composite Video output  
CH3---Horizontal Sync output  
CH4---Vertical Sync output

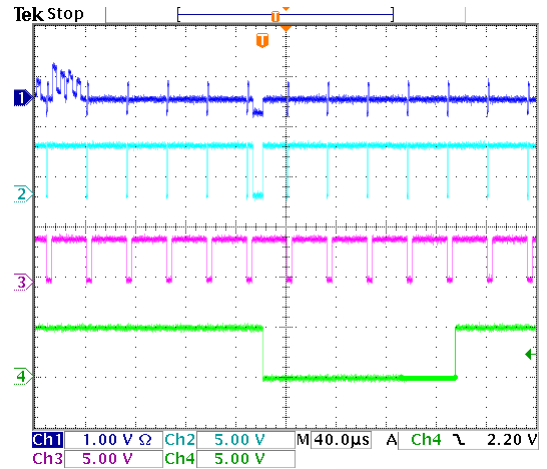

FIGURE 14. 1080I25 H31, V50---OUTPUT FROM 74HC221

Performance Curves (Continued)

CH1---Composite Video input  
CH2---Composite Video output  
CH3---Horizontal Sync output  
CH4---Vertical Sync output

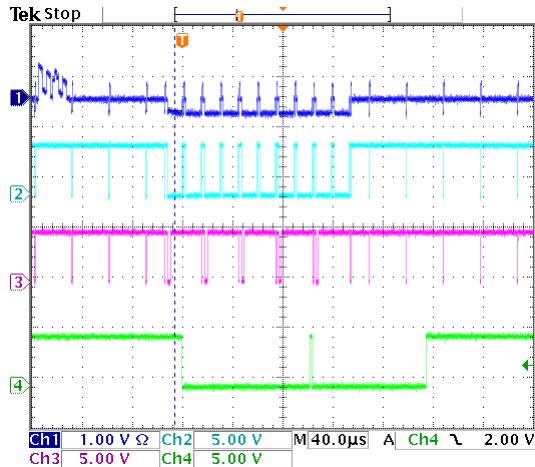

FIGURE 15. 1080I29 AND 1080I30---OUTPUT FROM EL1883

CH1---Composite Video input  
CH2---Composite Video output  
CH3---Horizontal Sync output  
CH4---Vertical Sync output

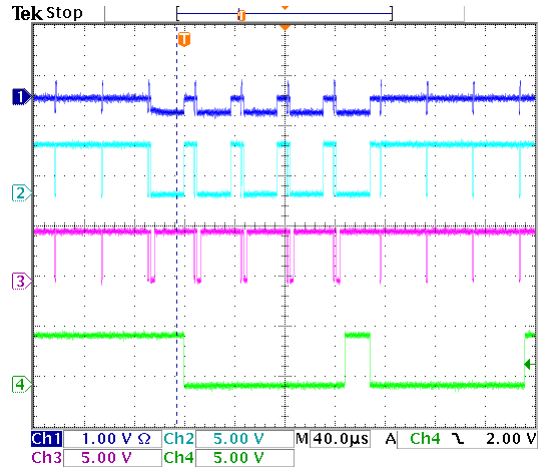

FIGURE 16. 1080P23 AND 1080P24---OUTPUT FROM EL1883

CH1---Composite Video input  
CH2---Composite Video output  
CH3---Horizontal Sync output  
CH4---Vertical Sync output

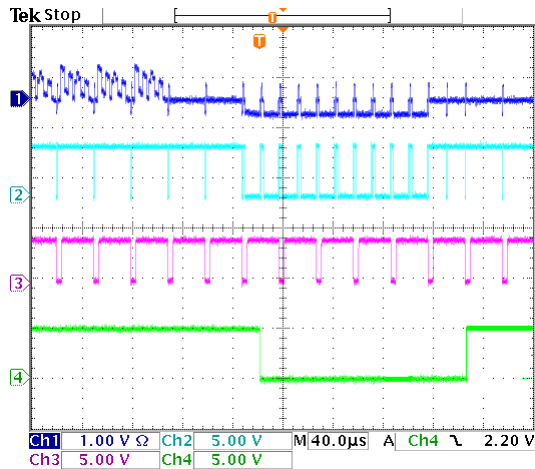

FIGURE 17. 1080I29 AND 1080I30---OUTPUT FROM 74HC221

CH1---Composite Video input  
CH2---Composite Video output  
CH3---Horizontal Sync output  
CH4---Vertical Sync output

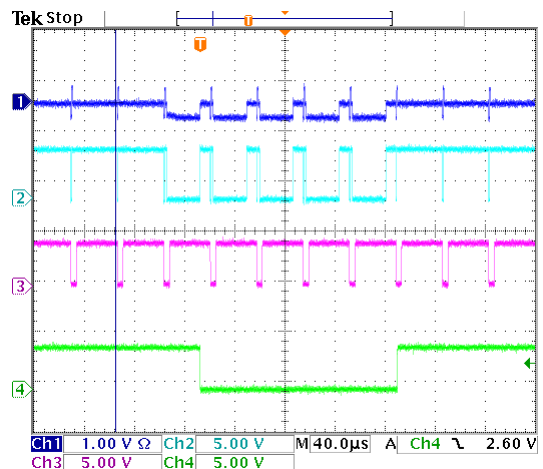

FIGURE 18. 1080P23 AND 1080P24---OUTPUT FROM 74HC221

Performance Curves (Continued)

CH1---Composite Video input  
CH2---Composite Video output  
CH3---Horizontal Sync output  
CH4---Vertical Sync output

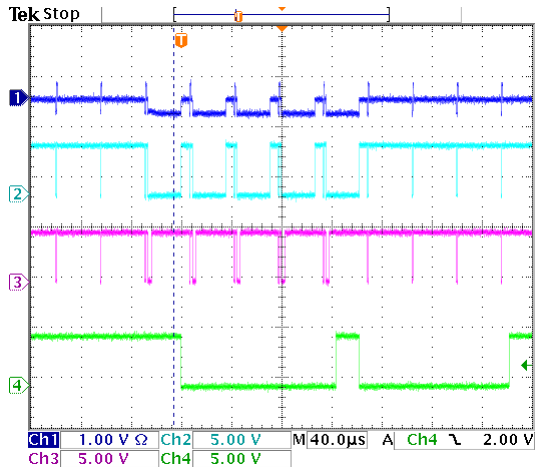

FIGURE 19. 1080P25---OUTPUT FROM EL1883

CH1---Composite Video input  
CH2---Composite Video output  
CH3---Horizontal Sync output  
CH4---Vertical Sync output

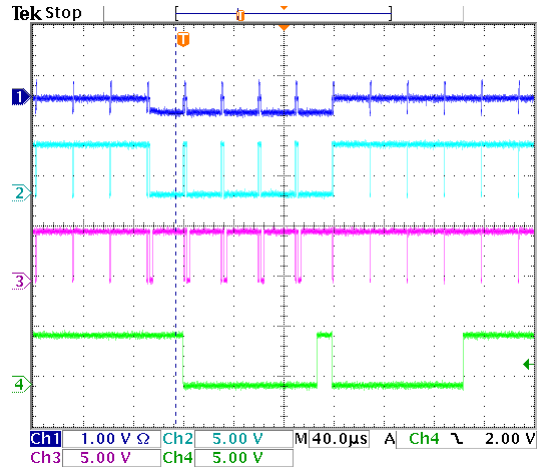

FIGURE 20. 1080P29 AND 1080P30---OUTPUT FROM EL1883

CH1---Composite Video input  
CH2---Composite Video output  
CH3---Horizontal Sync output  
CH4---Vertical Sync output

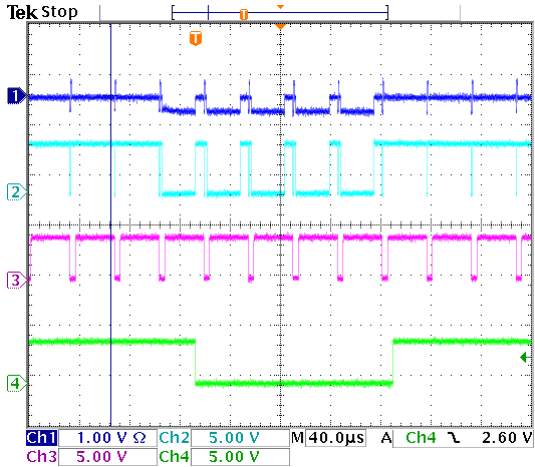

FIGURE 21. 1080P25 ---OUTPUT FROM 74HC221

CH1---Composite Video input  
CH2---Composite Video output  
CH3---Horizontal Sync output  
CH4---Vertical Sync output

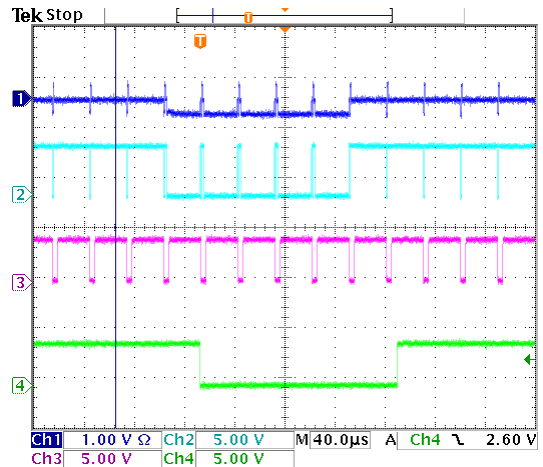

FIGURE 22. 1080P29 AND 1080P30---OUTPUT FROM 74HC221

## Notice

1. Descriptions of circuits, software and other related information in this document are provided only to illustrate the operation of semiconductor products and application examples. You are fully responsible for the incorporation or any other use of the circuits, software, and information in the design of your product or system. Renesas Electronics disclaims any and all liability for any losses and damages incurred by you or third parties arising from the use of these circuits, software, or information.
2. Renesas Electronics hereby expressly disclaims any warranties against and liability for infringement or any other claims involving patents, copyrights, or other intellectual property rights of third parties, by or arising from the use of Renesas Electronics products or technical information described in this document, including but not limited to, the product data, drawings, charts, programs, algorithms, and application examples.
3. No license, express, implied or otherwise, is granted hereby under any patents, copyrights or other intellectual property rights of Renesas Electronics or others.
4. You shall not alter, modify, copy, or reverse engineer any Renesas Electronics product, whether in whole or in part. Renesas Electronics disclaims any and all liability for any losses or damages incurred by you or third parties arising from such alteration, modification, copying or reverse engineering.
5. Renesas Electronics products are classified according to the following two quality grades: "Standard" and "High Quality". The intended applications for each Renesas Electronics product depends on the product's quality grade, as indicated below.  
"Standard": Computers; office equipment; communications equipment; test and measurement equipment; audio and visual equipment; home electronic appliances; machine tools; personal electronic equipment; industrial robots; etc.  
"High Quality": Transportation equipment (automobiles, trains, ships, etc.); traffic control (traffic lights); large-scale communication equipment; key financial terminal systems; safety control equipment; etc.  
Unless expressly designated as a high reliability product or a product for harsh environments in a Renesas Electronics data sheet or other Renesas Electronics document, Renesas Electronics products are not intended or authorized for use in products or systems that may pose a direct threat to human life or bodily injury (artificial life support devices or systems; surgical implantations; etc.), or may cause serious property damage (space system; undersea repeaters; nuclear power control systems; aircraft control systems; key plant systems; military equipment; etc.). Renesas Electronics disclaims any and all liability for any damages or losses incurred by you or any third parties arising from the use of any Renesas Electronics product that is inconsistent with any Renesas Electronics data sheet, user's manual or other Renesas Electronics document.
6. When using Renesas Electronics products, refer to the latest product information (data sheets, user's manuals, application notes, "General Notes for Handling and Using Semiconductor Devices" in the reliability handbook, etc.), and ensure that usage conditions are within the ranges specified by Renesas Electronics with respect to maximum ratings, operating power supply voltage range, heat dissipation characteristics, installation, etc. Renesas Electronics disclaims any and all liability for any malfunctions, failure or accident arising out of the use of Renesas Electronics products outside of such specified ranges.
7. Although Renesas Electronics endeavors to improve the quality and reliability of Renesas Electronics products, semiconductor products have specific characteristics, such as the occurrence of failure at a certain rate and malfunctions under certain use conditions. Unless designated as a high reliability product or a product for harsh environments in a Renesas Electronics data sheet or other Renesas Electronics document, Renesas Electronics products are not subject to radiation resistance design. You are responsible for implementing safety measures to guard against the possibility of bodily injury, injury or damage caused by fire, and/or danger to the public in the event of a failure or malfunction of Renesas Electronics products, such as safety design for hardware and software, including but not limited to redundancy, fire control and malfunction prevention, appropriate treatment for aging degradation or any other appropriate measures. Because the evaluation of microcomputer software alone is very difficult and impractical, you are responsible for evaluating the safety of the final products or systems manufactured by you.
8. Please contact a Renesas Electronics sales office for details as to environmental matters such as the environmental compatibility of each Renesas Electronics product. You are responsible for carefully and sufficiently investigating applicable laws and regulations that regulate the inclusion or use of controlled substances, including without limitation, the EU RoHS Directive, and using Renesas Electronics products in compliance with all these applicable laws and regulations. Renesas Electronics disclaims any and all liability for damages or losses occurring as a result of your noncompliance with applicable laws and regulations.
9. Renesas Electronics products and technologies shall not be used for or incorporated into any products or systems whose manufacture, use, or sale is prohibited under any applicable domestic or foreign laws or regulations. You shall comply with any applicable export control laws and regulations promulgated and administered by the governments of any countries asserting jurisdiction over the parties or transactions.
10. It is the responsibility of the buyer or distributor of Renesas Electronics products, or any other party who distributes, disposes of, or otherwise sells or transfers the product to a third party, to notify such third party in advance of the contents and conditions set forth in this document.
11. This document shall not be reprinted, reproduced or duplicated in any form, in whole or in part, without prior written consent of Renesas Electronics.
12. Please contact a Renesas Electronics sales office if you have any questions regarding the information contained in this document or Renesas Electronics products.  
(Note 1) "Renesas Electronics" as used in this document means Renesas Electronics Corporation and also includes its directly or indirectly controlled subsidiaries.  
(Note 2) "Renesas Electronics product(s)" means any product developed or manufactured by or for Renesas Electronics.

(Rev.4.0-1 November 2017)



### SALES OFFICES

Renesas Electronics Corporation

<http://www.renesas.com>

Refer to "<http://www.renesas.com/>" for the latest and detailed information.

**Renesas Electronics America Inc.**  
1001 Murphy Ranch Road, Milpitas, CA 95035, U.S.A.  
Tel: +1-408-432-8888, Fax: +1-408-434-5351

**Renesas Electronics Canada Limited**  
9251 Yonge Street, Suite 8309 Richmond Hill, Ontario Canada L4C 9T3  
Tel: +1-905-237-2004

**Renesas Electronics Europe Limited**  
Dukes Meadow, Millboard Road, Bourne End, Buckinghamshire, SL8 5FH, U.K  
Tel: +44-1628-651-700, Fax: +44-1628-651-804

**Renesas Electronics Europe GmbH**  
Arcadiastrasse 10, 40472 Düsseldorf, Germany  
Tel: +49-211-6503-0, Fax: +49-211-6503-1327

**Renesas Electronics (China) Co., Ltd.**  
Room 1709 Quantum Plaza, No.27 ZhichunLu, Haidian District, Beijing, 100191 P. R. China  
Tel: +86-10-8235-1155, Fax: +86-10-8235-7679

**Renesas Electronics (Shanghai) Co., Ltd.**  
Unit 301, Tower A, Central Towers, 555 Langao Road, Putuo District, Shanghai, 200333 P. R. China  
Tel: +86-21-2226-0888, Fax: +86-21-2226-0999

**Renesas Electronics Hong Kong Limited**  
Unit 1601-1611, 16/F., Tower 2, Grand Century Place, 193 Prince Edward Road West, Mongkok, Kowloon, Hong Kong  
Tel: +852-2265-6688, Fax: +852-2886-9022

**Renesas Electronics Taiwan Co., Ltd.**  
13F, No. 363, Fu Shing North Road, Taipei 10543, Taiwan  
Tel: +886-2-8175-9600, Fax: +886-2-8175-9670

**Renesas Electronics Singapore Pte. Ltd.**  
80 Bendemeer Road, Unit #06-02 Hyflux Innovation Centre, Singapore 339949  
Tel: +65-6213-0200, Fax: +65-6213-0300

**Renesas Electronics Malaysia Sdn.Bhd.**  
Unit 1207, Block B, Menara Amcorp, Amcorp Trade Centre, No. 18, Jln Persiaran Barat, 46050 Petaling Jaya, Selangor Darul Ehsan, Malaysia  
Tel: +60-3-7955-9390, Fax: +60-3-7955-9510

**Renesas Electronics India Pvt. Ltd.**  
No.777C, 100 Feet Road, HAL 2nd Stage, Indiranagar, Bangalore 560 038, India  
Tel: +91-80-67208700, Fax: +91-80-67208777

**Renesas Electronics Korea Co., Ltd.**  
17F, KAMCO Yangjae Tower, 262, Gangnam-daero, Gangnam-gu, Seoul, 06265 Korea  
Tel: +82-2-558-3737, Fax: +82-2-558-5338