

Description:

This document demonstrates how to use Intersil's ISL5416 3G Quad Programmable Down Converter for CDMA2000 and W-CDMA (UMTS) cellular applications.

The block diagrams in this application note show the data path through a single channel's filter blocks: the CIC, FIR1, FIR2 and resampler (if enabled). Not shown are the NCO and mixer blocks which precede the CIC filter. The configurations referenced in this application note make use of only channel 2 — channels 0, 1 and 3 may be copied from channel 2 to provide up to 4 receivers if desired. The inputs are set to bus C (eval board connector J3) and expect 2's complement format.

For standalone demonstration on the evaluation board (no external inputs or clocks), set the channel 2 input to the microprocessor test input register with the ENI bit enabled. This input appears to the mixer as a DC source, providing the NCO output as a sinusoidal source to the filter chain and allowing the filter chain to be swept (see tracing out a filter response below).

General procedure for loading and running a configuration:

1. Load the configuration files (main menu item 18). The configuration files for the examples in this application note are included with the ISL5416 Evaluation Board software in the configs directory.
2. Change the evaluation board port if needed (main menu item 1). These configurations assume the evaluation board is addressed as board # 0.
3. Initialize the board (main menu item 17).
4. Compute the register files (main menu item 10).
5. Download register files to ISL5416 (main menu item 12).
6. To display output data, select Run and Display mode (main menu item 13). Exit this mode by pressing "9".

Tracing out a filter response:

When a channel's input is set to the microprocessor test input register with ENI enabled, the channels sees a DC input and the mixer output is simply the NCO's sinusoidal outputs scaled by the DC value. A filter frequency response can be found by stepping the NCO frequency and measuring the output magnitude at each step. This is exactly what is done in the "Filter Sweep" option of the Data Collection and Display Menu (main menu item 11, then item 3). Details on doing this frequency sweep are provided in the evaluation board user's manual in the "Data Collection and Display Menu" section. The end result is a file called "sweep.imp"

containing frequency vs. output magnitude. A plot can be made in MATLAB using the following code:

```
a=fgetimp('sweep.imp');
plot(a(:,1), a(:,2)-max(a(:,2))); grid
```

The plots provided in the following pages were obtained in this manner. Function fgetimp is provided in the included MATLAB tools for modeling the ISL5416 CIC and FIR filter responses.

A more interactive tracing of the filters can be done in the Run and Display mode. In this mode, pressing the right and left arrow keys steps the carrier NCO frequency up and down. The real-time FFT displays the output spectrum, showing not only the magnitude of the frequency response at the input frequency but also the presence of noise and images. A procedure for obtaining a trace of the filter in Run and Display mode is as follows:

1. Load a configuration and enter Run and Display mode using the procedure provided on the left.
2. Step the NCO center frequency to 0 (DC) using the left and right arrow keys. When the frequency is close to DC, press the down arrow at least 8 times. This sets the NCO step size to the smallest step. Continue stepping the NCO frequency until it is approximately 0 (don't worry that the step size may not permit a frequency of exactly 0).
3. Press "1" to toggle the blue peak trace on (if not already enabled).
4. Press "4" to reset (zero) the peak trace.
5. Press "6" to toggle to AGC loop 2 ("AGC 2"). In all the examples included (and in all default configurations), the AGC loop gain 2 slew rates are set to 0 dB/output (AGC is disabled). This prevents the AGC from counteracting the effects of the filter.
6. Press and hold the right (or left) arrow key to decrease (increase) the frequency applied to the CIC's input. The peak trace will hold the filter's response. The span of the FFT display is $-(\text{output rate} / 2)$ to $(\text{output rate} / 2)$. The NCO frequency should be increased (or decreased) past the edge of the FFT display to see the effects of signals well into the stop band. While stepping the NCO frequency, look for noise or images which would indicate a problem in the configuration.

The figure below is a screen shot of Run and Display mode being used to trace out the filter response of the included cdma2k61.416 configuration (Configuration 1 below). The NCO frequency was stepped up from DC to about 5 MHz, showing the filter response to pass band and stop band signals. The span of the FFT below is -2.4576 MHz to 2.4576

MHz with DC in the center. The largest out-of-band image is about 58 dB below the pass band and occurred at around 595 kHz (the edge of the pass band). The input frequency may be stepped all the way up to $F_s/2$, where F_s is the A/D sample rate. Note that "Center Freq" below is the negative of the carrier NCO frequency.

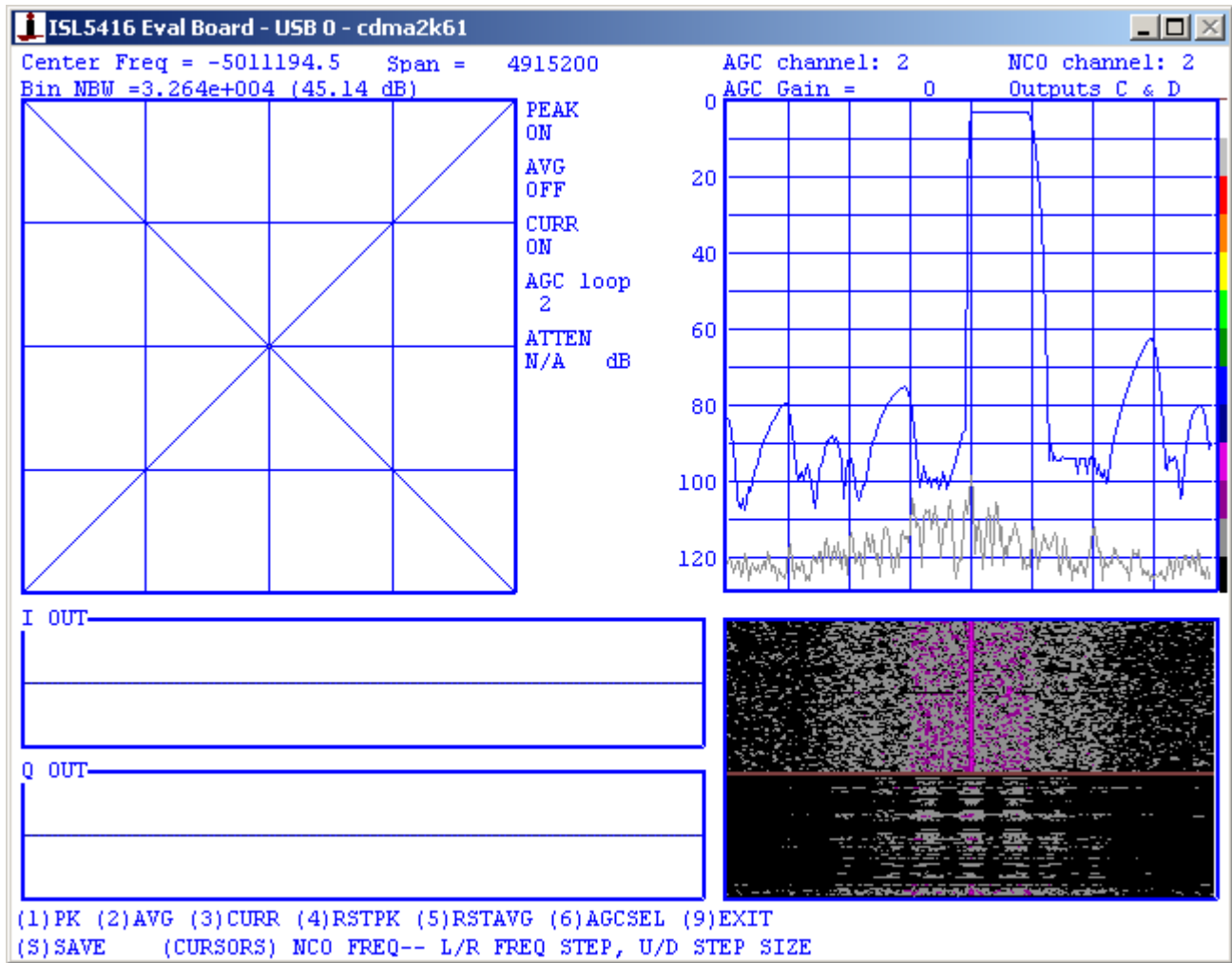

FIGURE 1. TRACING THE CDMA2K61 CONFIGURATION'S FILTER RESPONSE IN RUN AND DISPLAY MODE. THE NCO FREQUENCY WAS STEPPED FROM DC TO JUST OVER 5 MHz WITH THE PEAK TRACE ON.

Configuration 1 – CDMA2000-1xRTT

Configuration Filename: CDMA2K61.416

Input Rate: 61.44 (50x)

Output Rate: 4.9152 MSPS (4x)

Output Format: 24 bit I on time slot 0 with I(23:8) on COUT and I(7:0) on DOUT(15:8), likewise for Q on time slot 1.

The block diagram of the implementation is shown in Figure 2 below.

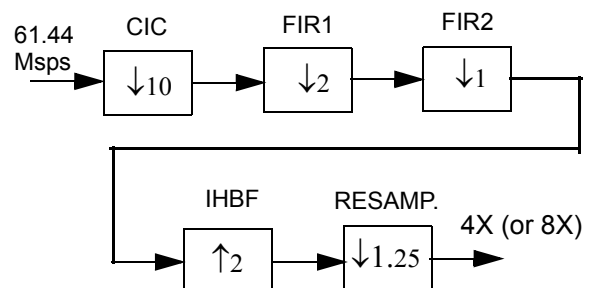

FIGURE 2. CONFIGURATION 1 FILTER BLOCK DIAGRAM

The chosen CIC decimation of 10 in this configuration yields a first alias level of about -94.8 dB with the 2-sided signal bandwidth taken as 1.25 MHz.

FIR1 is a 32-tap FIR filter, decimating by 2. Its role is to compensate for the CIC droop and do the “rough” filtering. Its frequency response is provided in Figure 3. FIR 2 is a 64-tap filter, decimating by 1. The output rate of the FIR2 is 3.072 Msps, or 2.5x. Therefore, the IHBF is enabled to increase the rate to 5x. The resampler is also enabled to achieve the final desired rate of 4.9152 Msps (4x). If required, the resampler can increase the final output rate to 8x or more.

PARALLEL OUTPUTS:

This configuration’s output is 24 bits of I data on time slot 0 with I(23:8) on COUT and I(7:0) on DOUT(15:8), and similarly for Q on time slot 1. Other parallel output options include:

- 16 bit I data on COUT and 16 bit Q data on DOUT during a single time slot
- 16-bit I data to the COUT bus on slot 0 and 16-bit Q data to COUT during slot 1 (multiplexing I and Q data onto a single 16 bit bus)
- 8 bit I on COUT(15:8) and 8 bit Q on COUT(7:0) (I and Q together on the same 16 bit bus and on the same time slot)

See the Output Routing Menu in the evaluation board software for details in configuring the parallel outputs.

SERIAL OUTPUTS:

The DOUT bus can be programmed to work as a serial output, providing 2 serial data outputs per channel.

The overall decimation of $50X / 4X = 12.5$ allows for a maximum of 12 bits per sample per serial output. This allows, for example, 12 bit I on SD1C and 12 bit Q on SD2C or 6 bit I followed by 6 bit Q on SD1C.

Note that the ISL5416 eval board software does not determine symbol or chip timing - it only plots the I and Q outputs, I vs. Q, and FFTs of 256 point captures. To obtain a constellation plot, the symbol timing on the ISL5217 upconverter can intentionally be offset by about 1 Hz so that the ISL5416 eval board slices at exactly the middle of the symbol once a second. The tightness of the constellation points can be used to judge the match between the transmit and receive filters. Further analysis may be done by capturing the output data to a file and importing it into an application such as Matlab. See the “Data Collection and Display Menu” section of the evaluation board user’s manual for more information on this.

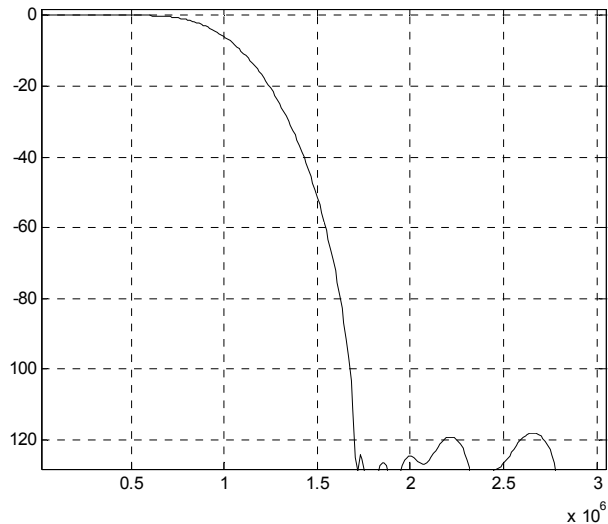

FIGURE 3. CONFIGURATION 1: FIR1 (32 TAPS)
FREQUENCY RESPONSE (dB VS. FREQUENCY)

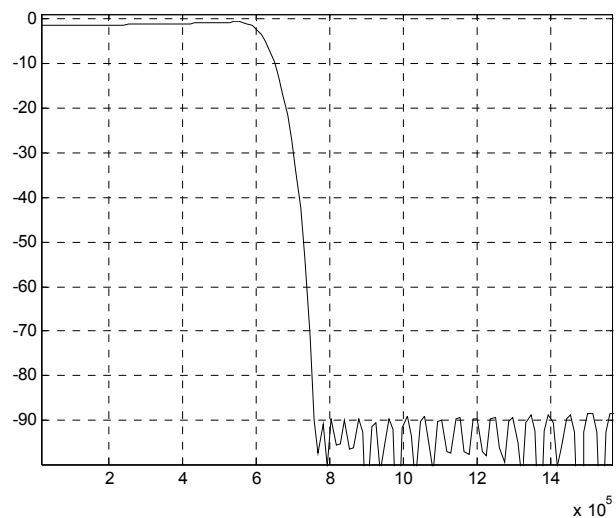

FIGURE 4. CONFIGURATION 1: FIR2 (64 TAPS)
FREQUENCY RESPONSE (dB VS. FREQUENCY)

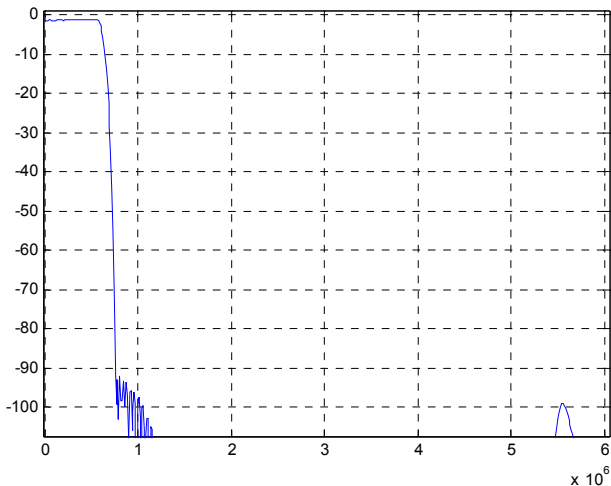

FIGURE 5. CONFIGURATION 1: COMBINED RESPONSE OF CIC, FIR1 AND FIR2 (dB VS. FREQUENCY).

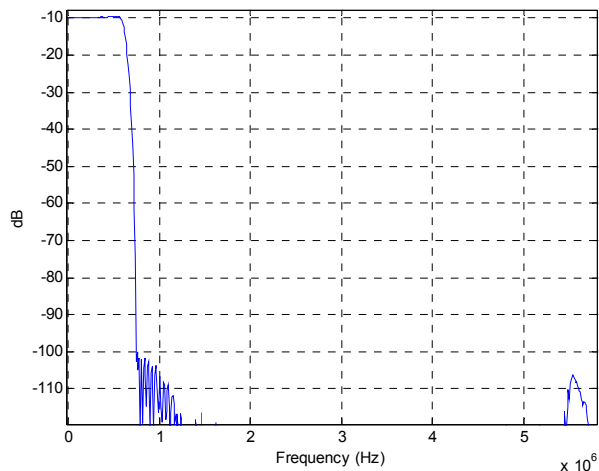

FIGURE 6. CONFIGURATION 1: SWEEP OF THE FILTER AS IMPLEMENTED ON THE ISL5416 EVAL BOARD (dB VS. FREQUENCY), DC TO 6 MHz.

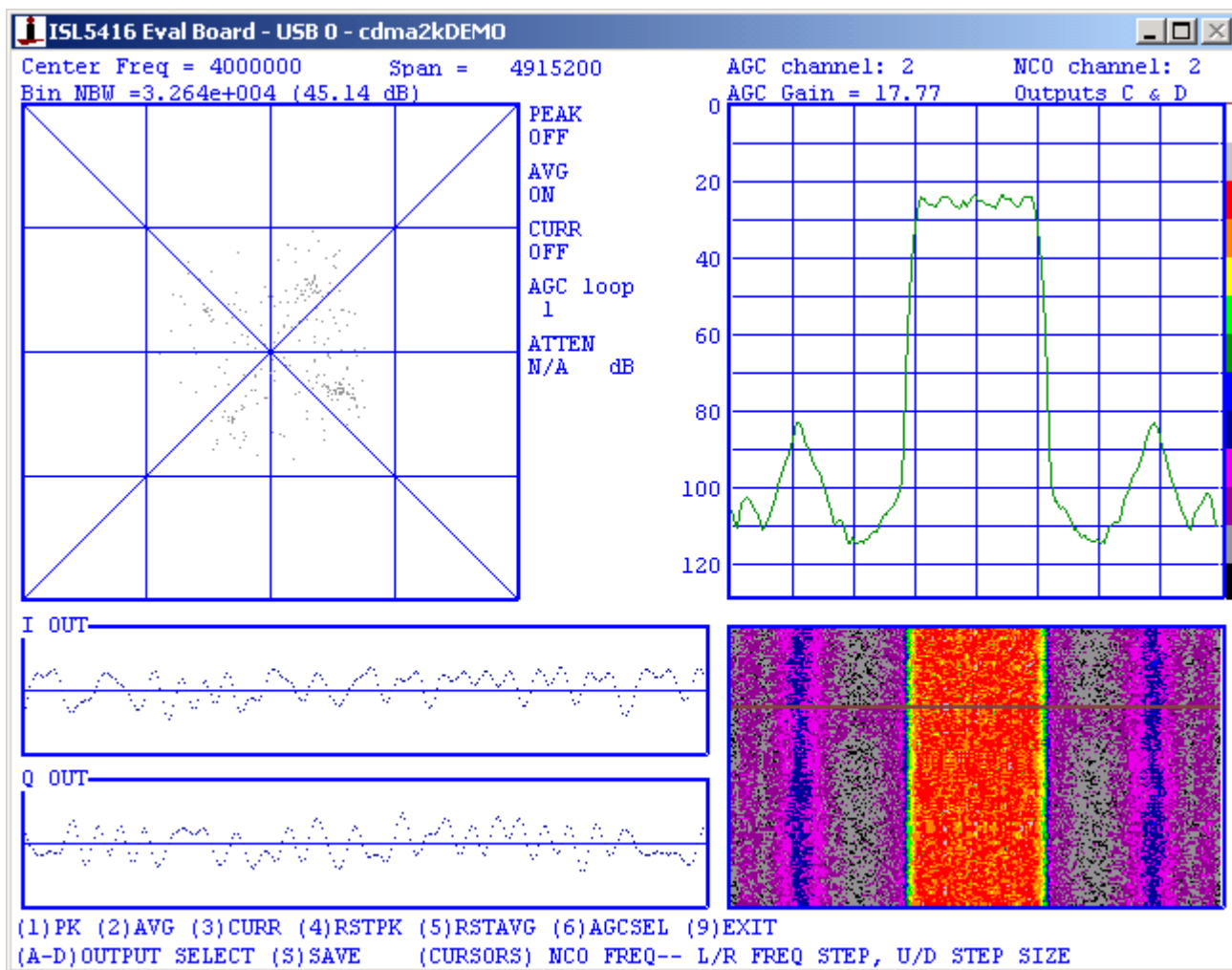

FIGURE 7. CONFIGURATION 1: ISL5416 EVAL BOARD SOFTWARE IN RUN AND DISPLAY MODE

Configuration 2 – CDMA2000-1xRTT

Configuration Filename: CDMA2K80.416

Input Rate: 80 Msps

Output Rate: 4.9152 MSPS (4x)

Output Format: 24 bit I on time slot 0 with I(23:8) on COUT and I(7:0) on DOUT(15:8), likewise for Q on time slot 1.

The block diagram of the implementation is shown in Figure 8 below.

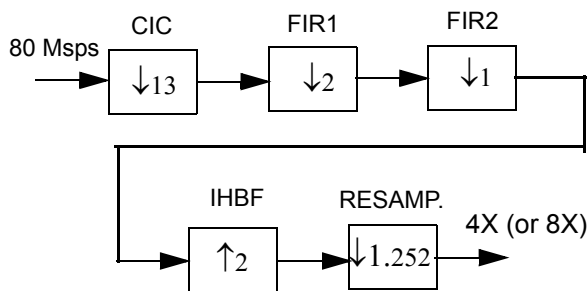

FIGURE 8. CONFIGURATION 2: FILTER BLOCK DIAGRAM

The chosen CIC decimation of 10 in this configuration yields a first alias level of about -95 dB with the 2-sided signal bandwidth taken as 1.25 MHz.

FIR1 and FIR2 use the same filter coefficients as Configuration 3. The only differences are the CIC decimation (10 for 61.44 MSPS and 13 for 80 MSPS to present FIR1 with a rate of about 6.144 MSPS) and the presence of the IHBF and resampler here to give an output rate of exactly 4.9152 MSPS (4X). If desired, the resampler can increase the final output rate to 8x or more.

The output format is the same as that of Configuration 1. Refer to Configuration 1 for examples of available parallel and serial output formats.

A filter sweep plot is shown in Figure 9. This is an actual plot of the ISL5416's output magnitude as the input frequency is swept from DC to 6MHz.

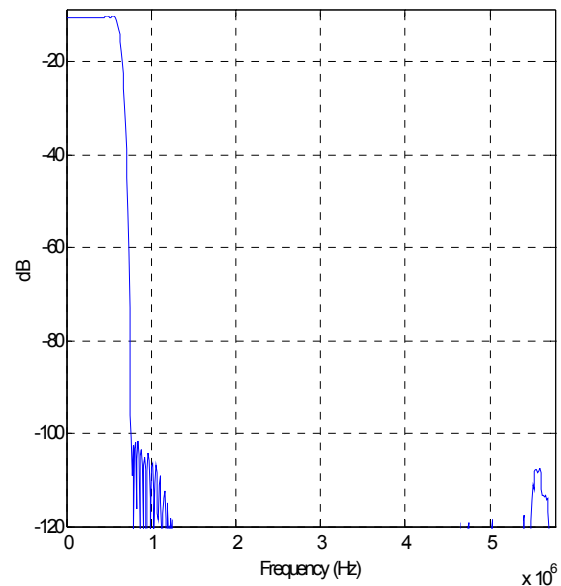

FIGURE 9. CONFIGURATION 2: SWEEP OF THE FILTER AS IMPLEMENTED ON THE ISL5416 EVAL BOARD (dB VS. FREQUENCY), DC TO 6 MHz.

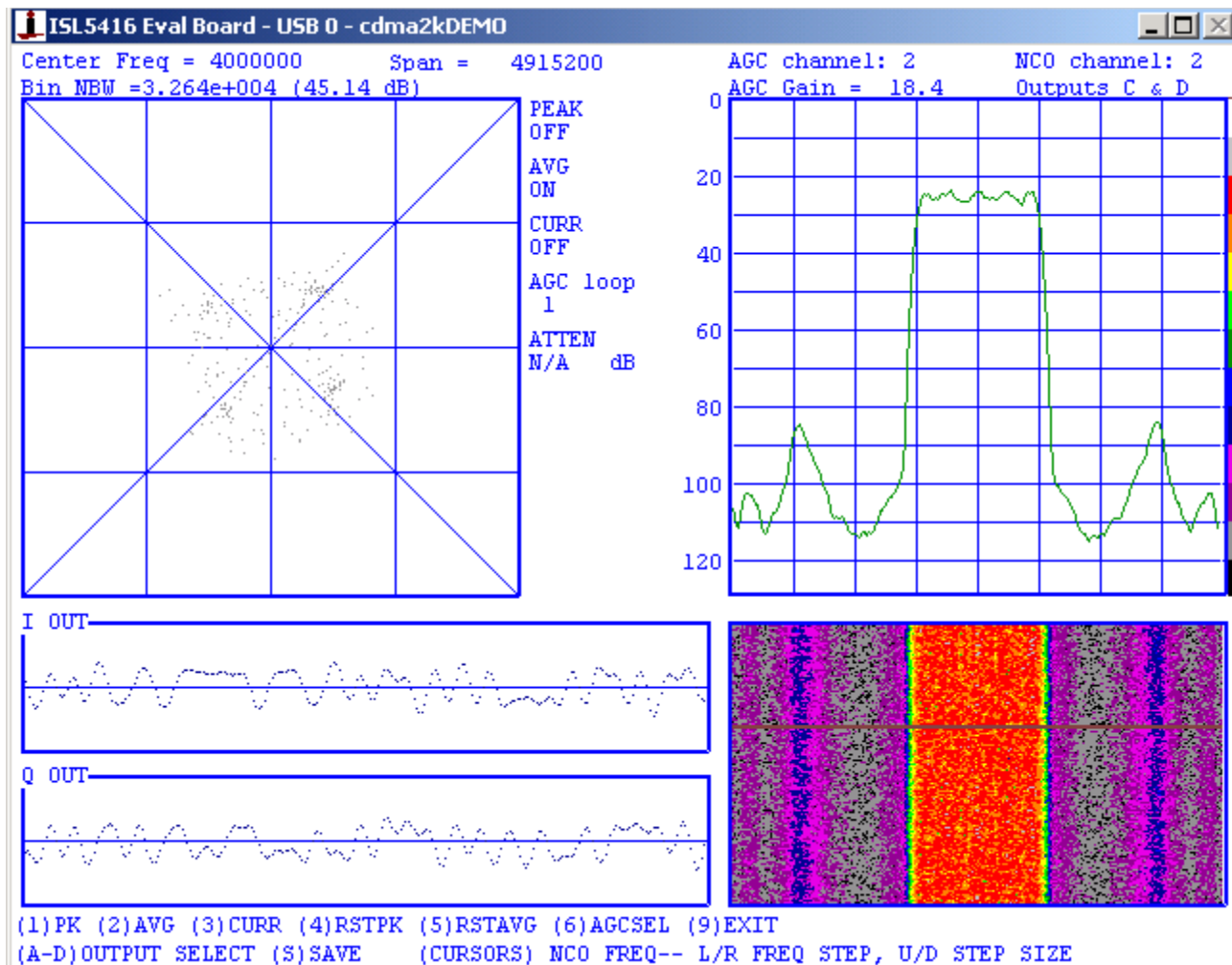

FIGURE 10. CONFIGURATION 2: ISL5416 EVAL BOARD SOFTWARE IN RUN AND DISPLAY MODE

Configuration 3 – W-CDMA (UMTS)

Configuration Filename: 3G6144.416

Input Rate: 61.44 Msps (16x)

Output Rate: 15.36 MSPS (4x)

Output Format: 24 bit I on time slot 0 with I(23:8) on COUT and I(7:0) on DOUT(15:8), likewise for Q on time slot 1.

The block diagram of the implementation is shown in Figure 11 below.

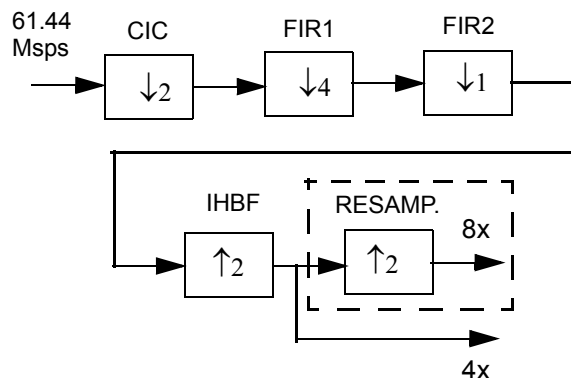

FIGURE 11. CONFIGURATION 3: FILTER BLOCK DIAGRAM

The chosen CIC decimation of 2 in this configuration yields a first alias level of -100 dB for a two-sided bandwidth of 3.84 MHz.

FIR1 is a 31-tap half band filter decimating by 4. It compensates for the CIC droop and provides filtering for the decimation by 4. Its frequency response is provided in Figure 12. FIR2 is a 64-tap RRC filter ($\alpha = 0.22$) decimating by 1. The output rate of FIR2 is 7.68 Msps. Therefore, the IHBF is enabled to increase the rate to 15.36 Msps (4x). The resampler could be enabled to achieve the rate of 30.72 Msps (8x) if desired.

The output format is the same as that of Configurations 1. Refer to Configuration 1 for examples of available parallel and serial output formats.

Figure 14 shows the composite response of the CIC, FIR1 and FIR2 filters as simulated in Matlab. A filter sweep is provided in Figure 15. This is an actual plot of the ISL5416's output magnitude as the input frequency is swept from DC to 15.36 MHz.

Figure 16 is a screen shot from the ISL5416 eval board software while receiving a W-CDMA (UMTS) signal from an ISL5217 quad programmable upconverter eval board. The four-point constellation is clearly visible in the I vs Q box, along with randomly scattered points from the mid-symbol samples. This plot was achieved by offsetting the ISL5217's symbol timing by about 0.1 Hz and capturing the screen when the symbol slicing was at the best position.

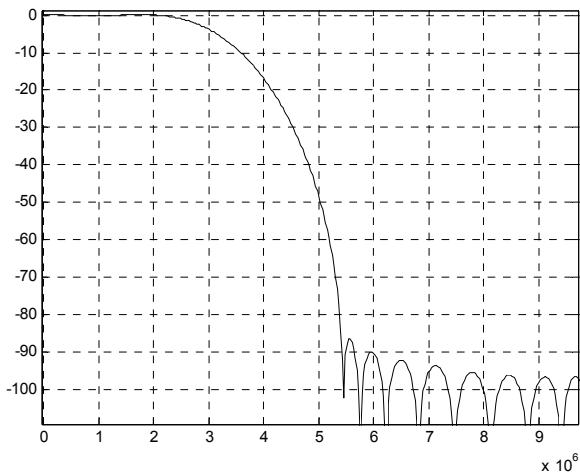

FIGURE 12. CONFIGURATION 3: FIR1 (31-TAP-HBF)
FREQUENCY RESPONSE (dB VS. FREQUENCY)

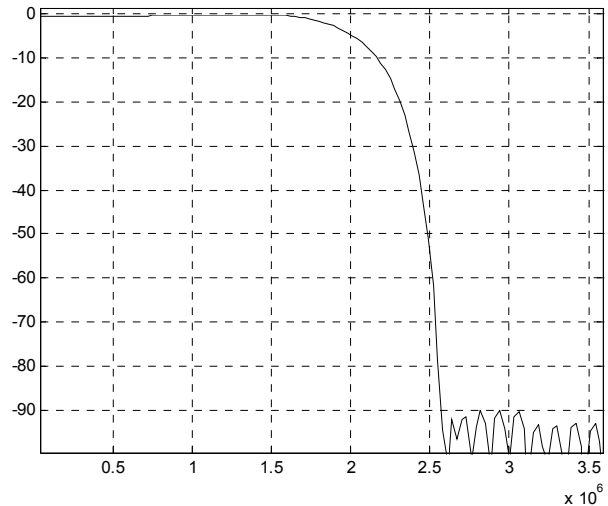

FIGURE 13. CONFIGURATION 3: FIR2 (64-TAP RRC)
FREQUENCY RESPONSE (dB VS. FREQUENCY).

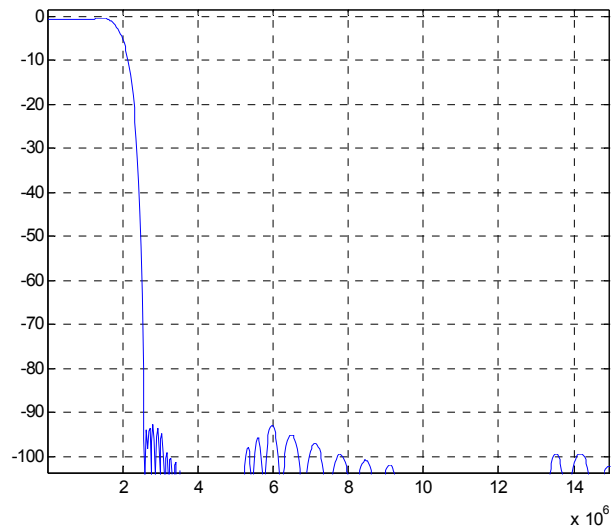

FIGURE 14. CONFIGURATION 3: COMBINED FREQUENCY
RESPONSE OF CIC, FIR1 AND FIR2 (dB VS. FREQUENCY)

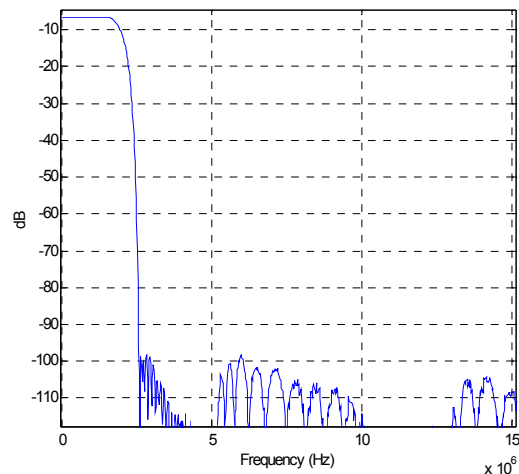

FIGURE 15. CONFIGURATION 3: FREQUENCY SWEEP OF THE
FILTERS AS IMPLEMENTED ON THE ISL5416

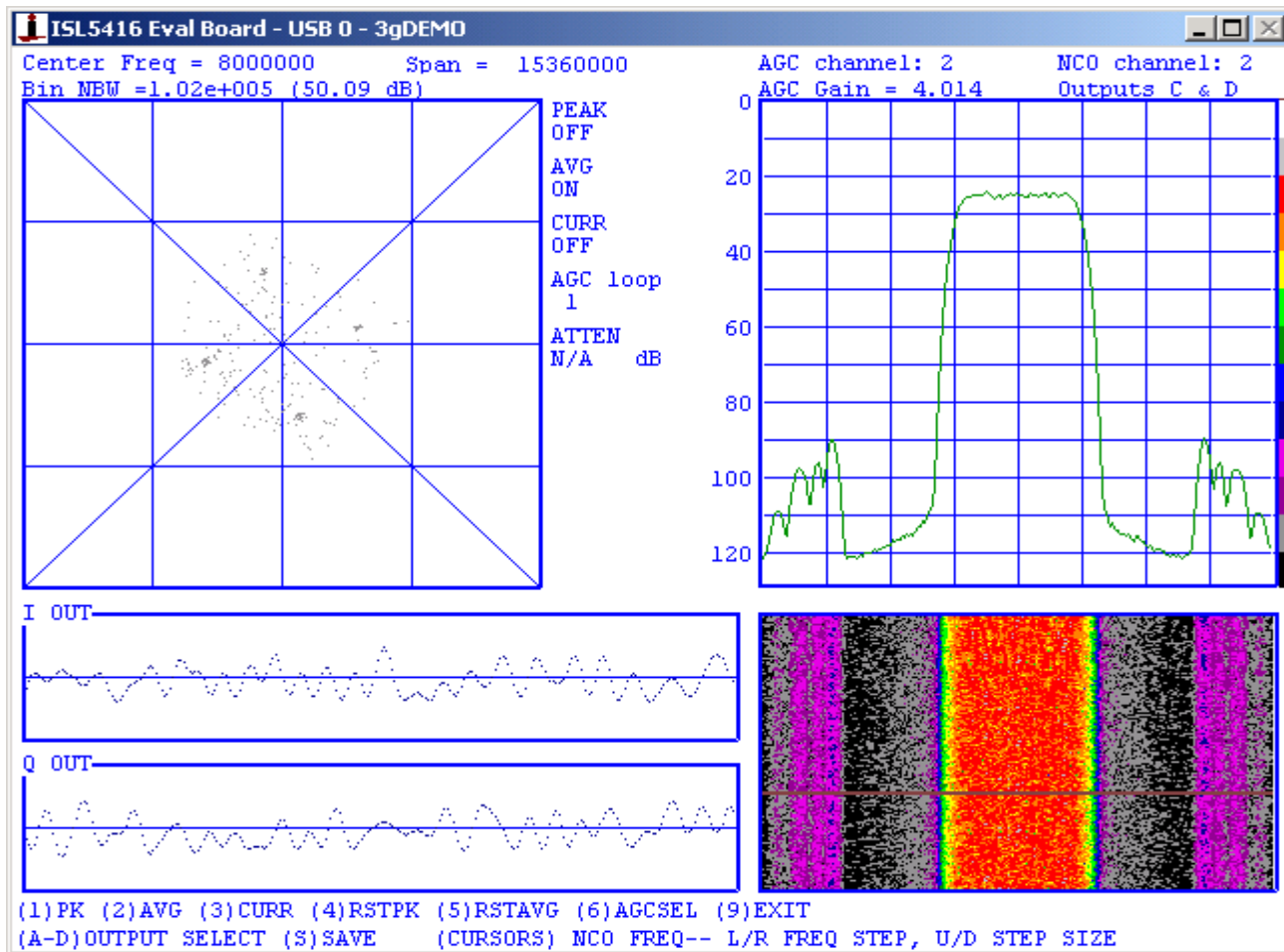

FIGURE 16. CONFIGURATION 3: EVAL BOARD SOFTWARE SCREEN SHOT

Notice

1. Descriptions of circuits, software and other related information in this document are provided only to illustrate the operation of semiconductor products and application examples. You are fully responsible for the incorporation or any other use of the circuits, software, and information in the design of your product or system. Renesas Electronics disclaims any and all liability for any losses and damages incurred by you or third parties arising from the use of these circuits, software, or information.
2. Renesas Electronics hereby expressly disclaims any warranties against and liability for infringement or any other claims involving patents, copyrights, or other intellectual property rights of third parties, by or arising from the use of Renesas Electronics products or technical information described in this document, including but not limited to, the product data, drawings, charts, programs, algorithms, and application examples.
3. No license, express, implied or otherwise, is granted hereby under any patents, copyrights or other intellectual property rights of Renesas Electronics or others.
4. You shall not alter, modify, copy, or reverse engineer any Renesas Electronics product, whether in whole or in part. Renesas Electronics disclaims any and all liability for any losses or damages incurred by you or third parties arising from such alteration, modification, copying or reverse engineering.
5. Renesas Electronics products are classified according to the following two quality grades: "Standard" and "High Quality". The intended applications for each Renesas Electronics product depends on the product's quality grade, as indicated below.
"Standard": Computers; office equipment; communications equipment; test and measurement equipment; audio and visual equipment; home electronic appliances; machine tools; personal electronic equipment; industrial robots; etc.
"High Quality": Transportation equipment (automobiles, trains, ships, etc.); traffic control (traffic lights); large-scale communication equipment; key financial terminal systems; safety control equipment; etc.
Unless expressly designated as a high reliability product or a product for harsh environments in a Renesas Electronics data sheet or other Renesas Electronics document, Renesas Electronics products are not intended or authorized for use in products or systems that may pose a direct threat to human life or bodily injury (artificial life support devices or systems; surgical implantations; etc.), or may cause serious property damage (space system; undersea repeaters; nuclear power control systems; aircraft control systems; key plant systems; military equipment; etc.). Renesas Electronics disclaims any and all liability for any damages or losses incurred by you or any third parties arising from the use of any Renesas Electronics product that is inconsistent with any Renesas Electronics data sheet, user's manual or other Renesas Electronics document.
6. When using Renesas Electronics products, refer to the latest product information (data sheets, user's manuals, application notes, "General Notes for Handling and Using Semiconductor Devices" in the reliability handbook, etc.), and ensure that usage conditions are within the ranges specified by Renesas Electronics with respect to maximum ratings, operating power supply voltage range, heat dissipation characteristics, installation, etc. Renesas Electronics disclaims any and all liability for any malfunctions, failure or accident arising out of the use of Renesas Electronics products outside of such specified ranges.
7. Although Renesas Electronics endeavors to improve the quality and reliability of Renesas Electronics products, semiconductor products have specific characteristics, such as the occurrence of failure at a certain rate and malfunctions under certain use conditions. Unless designated as a high reliability product or a product for harsh environments in a Renesas Electronics data sheet or other Renesas Electronics document, Renesas Electronics products are not subject to radiation resistance design. You are responsible for implementing safety measures to guard against the possibility of bodily injury, injury or damage caused by fire, and/or danger to the public in the event of a failure or malfunction of Renesas Electronics products, such as safety design for hardware and software, including but not limited to redundancy, fire control and malfunction prevention, appropriate treatment for aging degradation or any other appropriate measures. Because the evaluation of microcomputer software alone is very difficult and impractical, you are responsible for evaluating the safety of the final products or systems manufactured by you.
8. Please contact a Renesas Electronics sales office for details as to environmental matters such as the environmental compatibility of each Renesas Electronics product. You are responsible for carefully and sufficiently investigating applicable laws and regulations that regulate the inclusion or use of controlled substances, including without limitation, the EU RoHS Directive, and using Renesas Electronics products in compliance with all these applicable laws and regulations. Renesas Electronics disclaims any and all liability for damages or losses occurring as a result of your noncompliance with applicable laws and regulations.
9. Renesas Electronics products and technologies shall not be used for or incorporated into any products or systems whose manufacture, use, or sale is prohibited under any applicable domestic or foreign laws or regulations. You shall comply with any applicable export control laws and regulations promulgated and administered by the governments of any countries asserting jurisdiction over the parties or transactions.
10. It is the responsibility of the buyer or distributor of Renesas Electronics products, or any other party who distributes, disposes of, or otherwise sells or transfers the product to a third party, to notify such third party in advance of the contents and conditions set forth in this document.
11. This document shall not be reprinted, reproduced or duplicated in any form, in whole or in part, without prior written consent of Renesas Electronics.
12. Please contact a Renesas Electronics sales office if you have any questions regarding the information contained in this document or Renesas Electronics products.
(Note 1) "Renesas Electronics" as used in this document means Renesas Electronics Corporation and also includes its directly or indirectly controlled subsidiaries.
(Note 2) "Renesas Electronics product(s)" means any product developed or manufactured by or for Renesas Electronics.

(Rev.4.0-1 November 2017)



SALES OFFICES

Renesas Electronics Corporation

<http://www.renesas.com>

Refer to "<http://www.renesas.com/>" for the latest and detailed information.

Renesas Electronics America Inc.
1001 Murphy Ranch Road, Milpitas, CA 95035, U.S.A.
Tel: +1-408-432-8888, Fax: +1-408-434-5351

Renesas Electronics Canada Limited
9251 Yonge Street, Suite 8309 Richmond Hill, Ontario Canada L4C 9T3
Tel: +1-905-237-2004

Renesas Electronics Europe Limited
Dukes Meadow, Millboard Road, Bourne End, Buckinghamshire, SL8 5FH, U.K
Tel: +44-1628-651-700, Fax: +44-1628-651-804

Renesas Electronics Europe GmbH
Arcadiastrasse 10, 40472 Düsseldorf, Germany
Tel: +49-211-6503-0, Fax: +49-211-6503-1327

Renesas Electronics (China) Co., Ltd.
Room 1709 Quantum Plaza, No.27 ZhichunLu, Haidian District, Beijing, 100191 P. R. China
Tel: +86-10-8235-1155, Fax: +86-10-8235-7679

Renesas Electronics (Shanghai) Co., Ltd.
Unit 301, Tower A, Central Towers, 555 Langao Road, Putuo District, Shanghai, 200333 P. R. China
Tel: +86-21-2226-0888, Fax: +86-21-2226-0999

Renesas Electronics Hong Kong Limited
Unit 1601-1611, 16/F., Tower 2, Grand Century Place, 193 Prince Edward Road West, Mongkok, Kowloon, Hong Kong
Tel: +852-2265-6688, Fax: +852-2886-9022

Renesas Electronics Taiwan Co., Ltd.
13F, No. 363, Fu Shing North Road, Taipei 10543, Taiwan
Tel: +886-2-8175-9600, Fax: +886-2-8175-9670

Renesas Electronics Singapore Pte. Ltd.
80 Bendemeer Road, Unit #06-02 Hyflux Innovation Centre, Singapore 339949
Tel: +65-6213-0200, Fax: +65-6213-0300

Renesas Electronics Malaysia Sdn.Bhd.
Unit 1207, Block B, Menara Amcorp, Amcorp Trade Centre, No. 18, Jln Persiaran Barat, 46050 Petaling Jaya, Selangor Darul Ehsan, Malaysia
Tel: +60-3-7955-9390, Fax: +60-3-7955-9510

Renesas Electronics India Pvt. Ltd.
No.777C, 100 Feet Road, HAL 2nd Stage, Indiranagar, Bangalore 560 038, India
Tel: +91-80-67208700, Fax: +91-80-67208777

Renesas Electronics Korea Co., Ltd.
17F, KAMCO Yangjae Tower, 262, Gangnam-daero, Gangnam-gu, Seoul, 06265 Korea
Tel: +82-2-558-3737, Fax: +82-2-558-5338