

# IGBT · FRD

## AE5 IGBT and FRD ringing behavior benchmark

---

### About this document

This document will discuss the basics of ringing behavior and compare the ringing behavior benchmark of Renesas product AE5 IGBT and FRD with other competitors

### Target Device

IGBT & FRD: AE5

### Contents

1. Introduction.....	2
1.1 Overview.....	2
1.2 Ringing behavior.....	2
2. Renesas AE5 IGBT Solution.....	3
2.1 Advantage with internal gate resistance.....	3
2.2 Impact with Gate Resistor (R <sub>g</sub> ) .....	3
2.3 Renesas AE5 IGBT .....	4
3. Ringing behavior Benchmark Evaluation .....	6
3.1 Renesas product AE5 (IGBT+ FRD).....	6
3.2 Competitor A (IGBT + FRD) .....	7
3.3 Competitor B (IGBT + FRD) .....	7
3.4 Ringing behavior comparison.....	8
3.4.1 Condition A: VCC = 475V and IF = 5A.....	8
3.4.2 Condition B: VCC = 475V and IF = 50A.....	8
4. Conclusion.....	8
Revision History.....	9

## 1. Introduction

### 1.1 Overview

Ringing behavior on an IGBT (Insulated Gate Bipolar Transistor) refers to the phenomenon of unwanted oscillations or voltage spikes that occur during the switching transitions of the transistor. This occurs due to parasitic inductances (such as PCB traces, wires, etc.) and capacitances (both internal and external to the IGBT) in the circuit when switching the IGBT on or off. These parasitic elements cause the voltage to oscillate, leading to ringing.

There are several impacts when ringing behavior occurs. The oscillations can impose stress on the IGBT and surrounding components due to high-frequency voltage spikes and current oscillations. This can increase heat dissipation and potentially lead to reliability issues over time. Additionally, the high-frequency components can generate electromagnetic interference (EMI), which can affect nearby electronic devices and communications if not properly controlled.

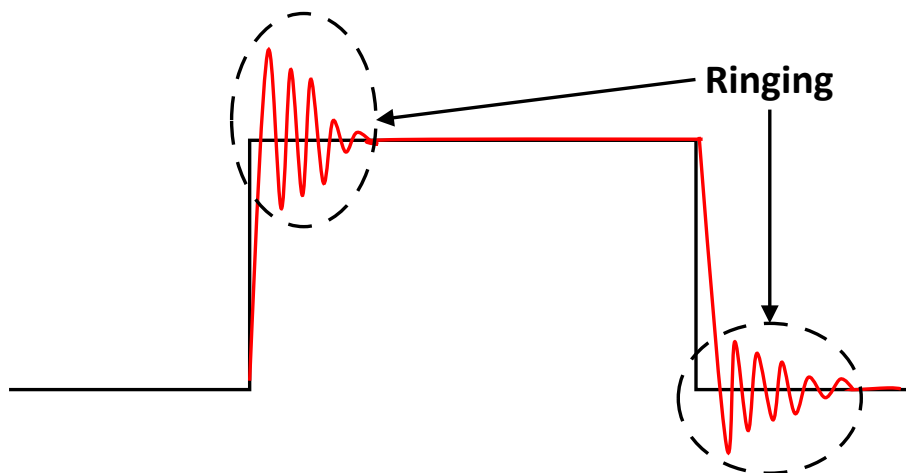

Figure 1-1 Ringing happen when switching transitions

### 1.2 Ringing behavior

Below is an illustration the recovery current produced by FRD recovery operation that generated a recovery surge at VGE. The Rg value need to be adjusted with consideration to the effect on loss.

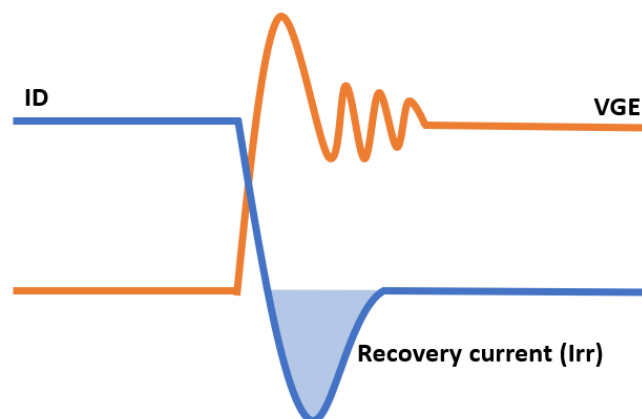

Figure 1-2 FRD waveform during the recovery operation

## 2. Renesas AE5 IGBT Solution

### 2.1 Advantage with internal gate resistance

Using an IGBT with a built-in gate resistor ( $r_g$ ) offers significant advantages in both cost efficiency and performance. One of the primary benefits is the elimination of the need for an external gate resistor ( $R_g$ ), which reduces design complexity and lowers overall system costs.

Additionally, integrating the gate resistor directly into the IGBT helps to enhance switching performance by better controlling surge voltage and reducing ringing noise during recovery operations. This built-in feature improves the balance and stability of switching processes, leading to more reliable and efficient operation of power electronic systems.

By streamlining design and boosting operational performance, IGBTs with built-in  $r_g$  provide a practical and effective solution for modern electronic applications.

### 2.2 Impact with Gate Resistor ( $R_g$ )

The gate resistor ( $R_g$ ) plays a crucial role in managing switching speed and affecting the characteristics of the product. The table below shows how the external  $R_g$  value can impact these characteristics and highlights the need to consider its effects on the entire system.

**Table 2-2 Impact of  $R_g$  on the key characteristic performance**

Rg Value	Switching Time	Switching Loss	Surge Voltage	Ringing Noise
Smaller Rg	Faster	Lower	Higher	More
Large Rg	Slower	Higher	Lower	Less & stable

The resistor  $R_g$  affects the gate current ( $I_g$ ) because the gate is charged or discharged during IGBT operation. If  $I_g$  is insufficient, it can directly impact the switching speed and increase losses. Therefore, to optimize IGBT switching performance, the circuit design should consider for both the chip built-in resistor  $r_g$  and the internal resistor  $R_S$  of the driver circuit.

$$I_{g(peak)} = \frac{V_{GE(on)} - V_{ge(off)}}{(R_S + R_g + r_g)_{min}}$$

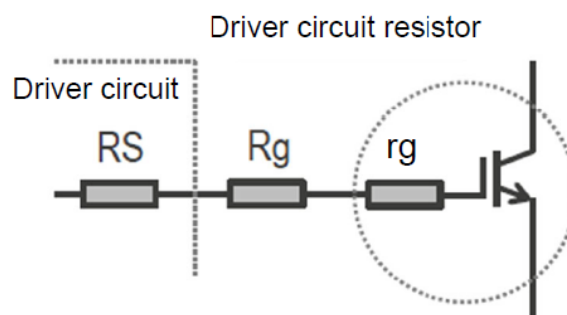

$r_g$  : IGBT chip built-in resistor  
 $R_g$  : Gate resistor  
 $R_S$  : Driver circuit internal resistor

**Figure 2-1 Gate Resistor**

### 2.3 Renesas AE5 IGBT

Renesas AE series IGBT is optimized for automotive applications, using a unique trench gate technology to achieve low saturation voltage while maintaining robustness and reducing switching losses. The latest of series product (AE5) has offers high-performance bare die products for power module designers. It improves electrical characteristics by reducing both conduction and switching losses by 10% and provides a 50% better  $V_{GE(th)}$  distribution compared to the older model.

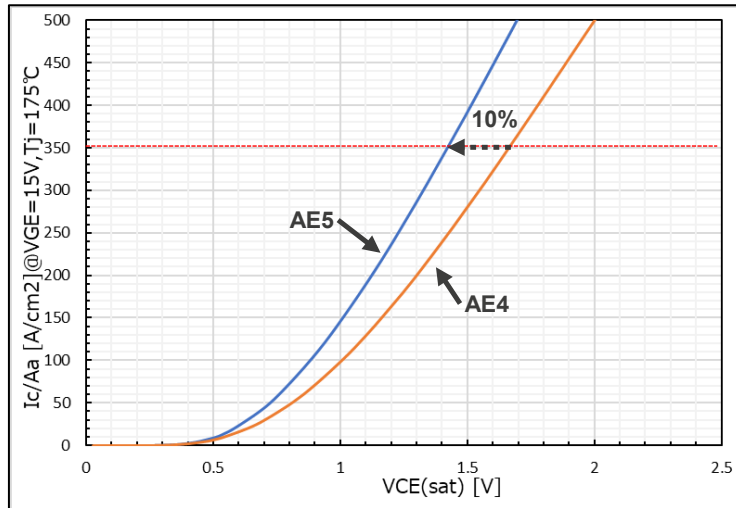

Figure 2-2 Output Characteristic

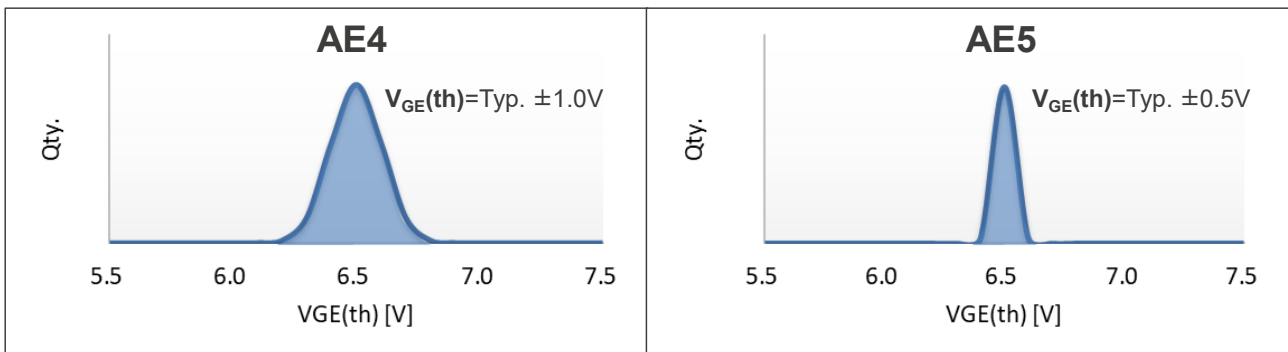
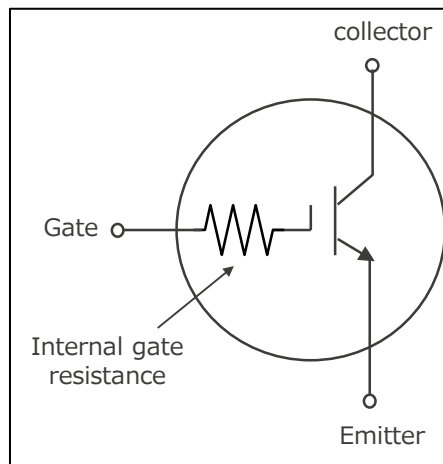

Figure 2-3  $V_{GE(th)}$  Distribution Comparison

Renesas offers a lineup of anti-ringing products in the AE series with featuring built-in gate resistor ( $r_g$ ), as shown in the figure below. This series includes several excellent features:

- 750V Trench & Field-Stop AE5 Technology
- Lower Collector-Emitter Saturation Voltage,  $V_{CE(sat)}$  of 1.35V typ.
- Low switching loss
- Easy paralleling by internal gate resistance ( $r_g$ ) and narrow  $V_{GE(th)}$  distribution
- AEC Q101(HTRB, HTGB) qualified



**Figure 2-4 The AE5 IGBT with built-in gate resistor**

### 3. Ringing behavior Benchmark Evaluation

In this section, Renesas has internally compare the ringing behavior performance of the Renesas AE5 IGBT with two other competitors' similar products available in the market. The measurements presented will highlight the advantages of the AE series. Below are the test conditions selected for the comparison.

**Table 3 Test condition for benchmark**

Test Item	Specification
VCC	400V, 475V, 530V
Forward Current (IF)	5A, 10A, 50A, 200A
Rg_on	2 Ω
Tj	25 °C

#### 3.1 Renesas product AE5 (IGBT+ FRD)

The measurements were taken according to the table below, and it was observed that there is no ringing in the waveform. The waveform shown below was captured under the test conditions of VCC at 530V and IC at 5A. There are no surges or ringing observed under any conditions.

**Table 3-1 Test result for AE5**

IF \ VCC	400V	475V	530V
5A	√	√	√
10A	√	√	√
50A	√	√	√
200A	√	√	√

Note: √ = No Ringing (Passed), × = Ringing (Failed)

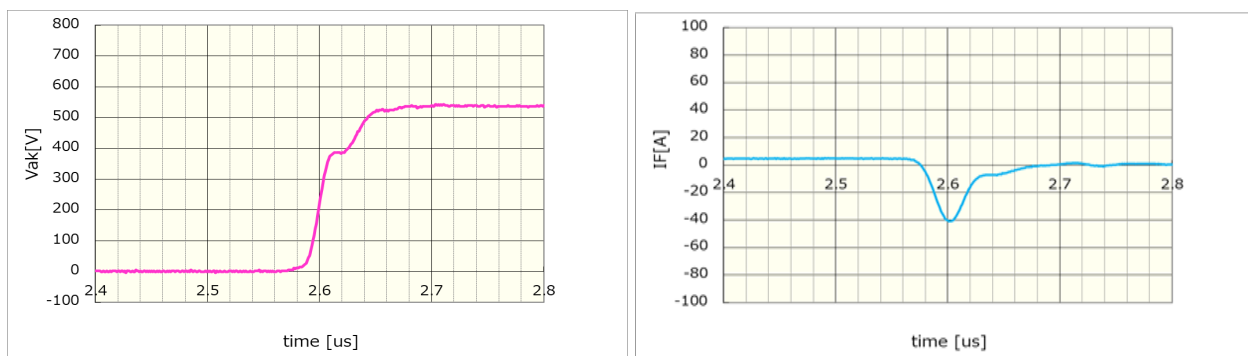

**Figure 3-1 FRD waveform during recovery operation for AE5**

### 3.2 Competitor A (IGBT + FRD)

The measurements were taken according to the table below, revealing that ringing occurred at 5A and 10A.

**Table 3-2 Test result for Competitor A**

IF \ VCC	400V	475V	530V
5A	x	x	x
10A	x	x	x
50A	√	√	√
200A	√	√	√

Note: √ = No Ringing (Passed), x = Ringing (Failed)

The waveform shown below was captured under the test conditions with VCC at 530V and IC at 5A. The surge level exceeds 200V, and ringing is occurring.

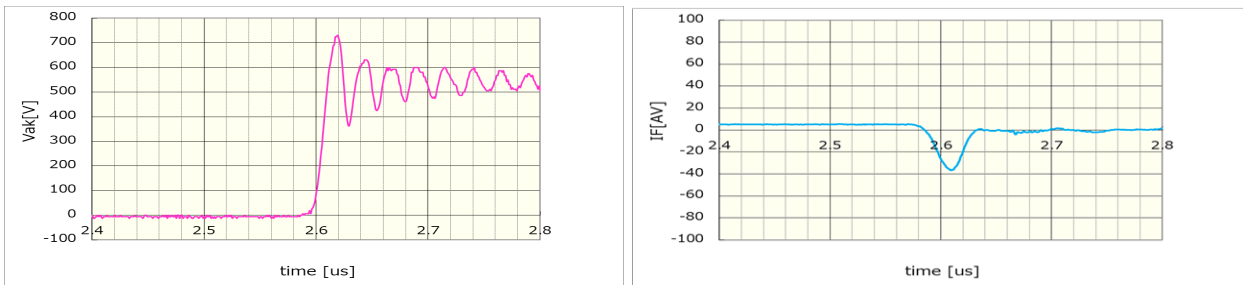

**Figure 3-2 FRD waveform during recovery operation for Competitor A**

### 3.3 Competitor B (IGBT + FRD)

The measurements were taken according to the table below, revealing that ringing occurred at 5A, 10A and 50A.

**Table 3-3 Test result for Competitor B**

IF \ VCC	400V	475V	530V
5A	x	x	x
10A	x	x	x
50A	x	x	x
200A	√	√	√

Note: √ = No Ringing (Passed), x = Ringing (Failed)

The waveform shown below was captured under the test conditions with VCC at 530V and IC at 5A. The surge level exceeds 150V, and ringing is occurring.

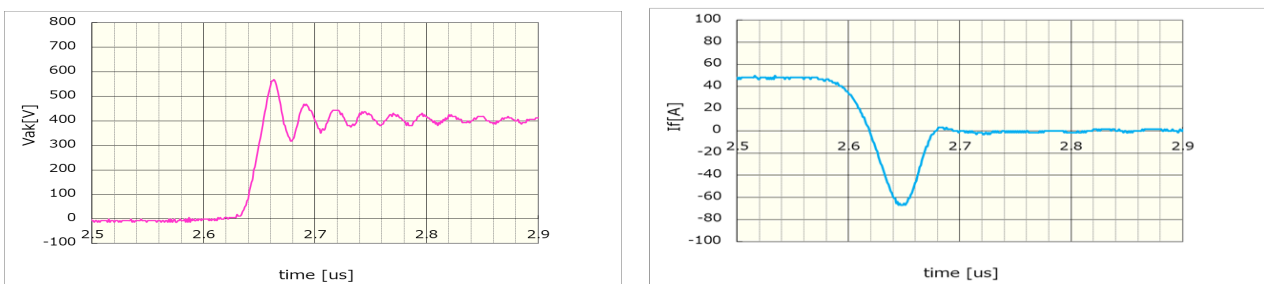

**Figure 3-3 FRD waveform during recovery operation for Competitor B**

### 3.4 Ringing behavior comparison

The comparison of the waveform during the recovery operation of three types of IGBT + FRD products under two different conditions

- Condition A:  $V_{CC} = 475V$  and  $I_F = 5A$
- Condition B:  $V_{CC} = 475V$  and  $I_F = 50A$

#### 3.4.1 Condition A: $V_{CC} = 475V$ and $I_F = 5A$

The waveform compares three products in terms of surge and ringing during recovery operation. Product Competitor A exhibits ringing at 5A, whereas the AE5 shows superior performance with no ringing compared to the other two products.

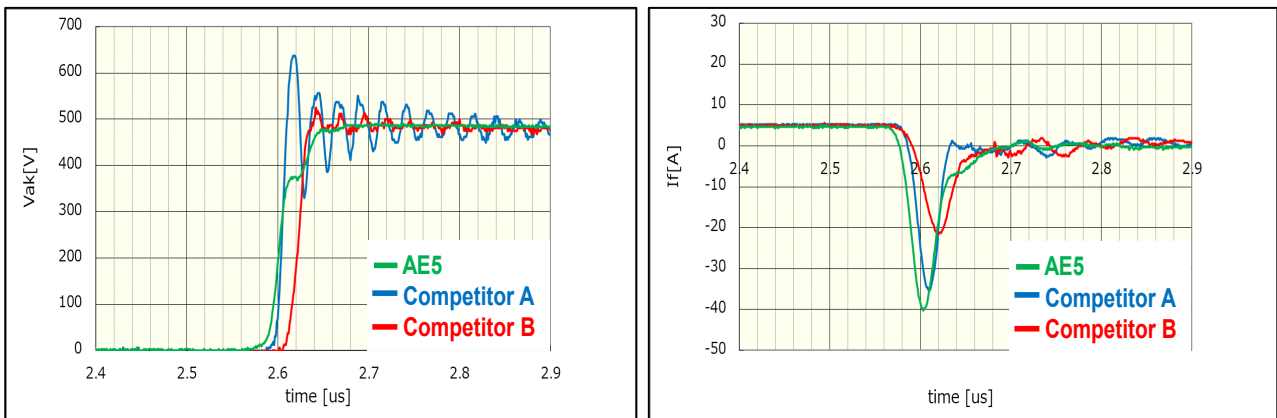

Figure 3-4 FRD waveform comparison during recovery operation

#### 3.4.2 Condition B: $V_{CC} = 475V$ and $I_F = 50A$

The waveform compares three products in terms of surge and ringing during recovery operation. Product Competitor B exhibits ringing at 50A, whereas the AE5 shows superior performance with no ringing compared to the other two products.

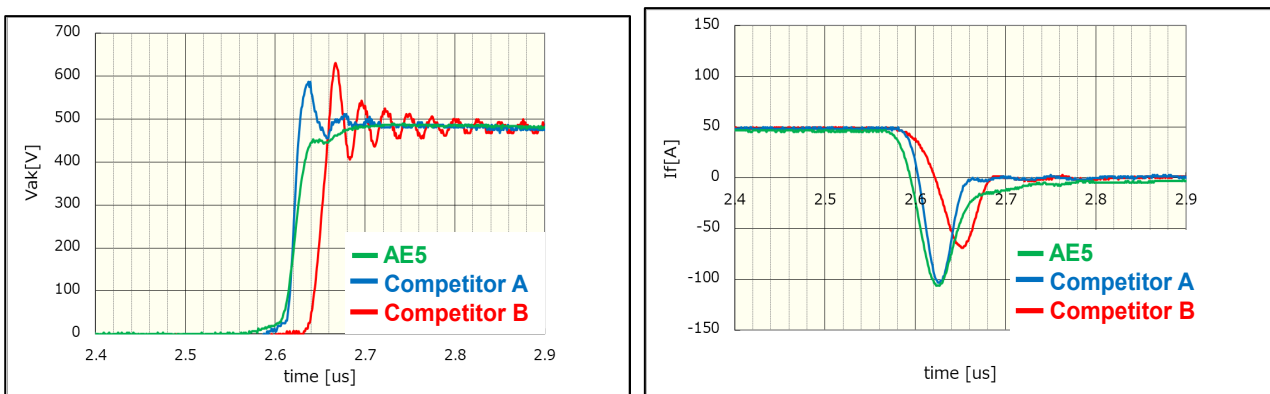

Figure 3-5 FRD waveform comparison during recovery operation

## 4. Conclusion

In conclusion, the ringing behavior of the IGBT affects product performance over time. Choosing a product with good ringing characteristics during surge recovery can improve durability and overall outcomes. Based on the measurements, the AE5 product demonstrates superior performance compared to the other two types.

**Revision History**

Rev.	Date	Description	
		Page	Summary
1.00	Aug.21.24	-	First edition

## Notice

1. Descriptions of circuits, software and other related information in this document are provided only to illustrate the operation of semiconductor products and application examples. You are fully responsible for the incorporation or any other use of the circuits, software, and information in the design of your product or system. Renesas Electronics disclaims any and all liability for any losses and damages incurred by you or third parties arising from the use of these circuits, software, or information.
2. Renesas Electronics hereby expressly disclaims any warranties against and liability for infringement or any other claims involving patents, copyrights, or other intellectual property rights of third parties, by or arising from the use of Renesas Electronics products or technical information described in this document, including but not limited to, the product data, drawings, charts, programs, algorithms, and application examples.
3. No license, express, implied or otherwise, is granted hereby under any patents, copyrights or other intellectual property rights of Renesas Electronics or others.
4. You shall be responsible for determining what licenses are required from any third parties, and obtaining such licenses for the lawful import, export, manufacture, sales, utilization, distribution or other disposal of any products incorporating Renesas Electronics products, if required.
5. You shall not alter, modify, copy, or reverse engineer any Renesas Electronics product, whether in whole or in part. Renesas Electronics disclaims any and all liability for any losses or damages incurred by you or third parties arising from such alteration, modification, copying or reverse engineering.
6. Renesas Electronics products are classified according to the following two quality grades: "Standard" and "High Quality". The intended applications for each Renesas Electronics product depends on the product's quality grade, as indicated below.
  - "Standard": Computers; office equipment; communications equipment; test and measurement equipment; audio and visual equipment; home electronic appliances; machine tools; personal electronic equipment; industrial robots; etc.
  - "High Quality": Transportation equipment (automobiles, trains, ships, etc.); traffic control (traffic lights); large-scale communication equipment; key financial terminal systems; safety control equipment; etc.Unless expressly designated as a high reliability product or a product for harsh environments in a Renesas Electronics data sheet or other Renesas Electronics document, Renesas Electronics products are not intended or authorized for use in products or systems that may pose a direct threat to human life or bodily injury (artificial life support devices or systems; surgical implantations; etc.), or may cause serious property damage (space system; undersea repeaters; nuclear power control systems; aircraft control systems; key plant systems; military equipment; etc.). Renesas Electronics disclaims any and all liability for any damages or losses incurred by you or any third parties arising from the use of any Renesas Electronics product that is inconsistent with any Renesas Electronics data sheet, user's manual or other Renesas Electronics document.
7. No semiconductor product is absolutely secure. Notwithstanding any security measures or features that may be implemented in Renesas Electronics hardware or software products, Renesas Electronics shall have absolutely no liability arising out of any vulnerability or security breach, including but not limited to any unauthorized access to or use of a Renesas Electronics product or a system that uses a Renesas Electronics product. RENESAS ELECTRONICS DOES NOT WARRANT OR GUARANTEE THAT RENESAS ELECTRONICS PRODUCTS, OR ANY SYSTEMS CREATED USING RENESAS ELECTRONICS PRODUCTS WILL BE INVULNERABLE OR FREE FROM CORRUPTION, ATTACK, VIRUSES, INTERFERENCE, HACKING, DATA LOSS OR THEFT, OR OTHER SECURITY INTRUSION ("Vulnerability Issues"). RENESAS ELECTRONICS DISCLAIMS ANY AND ALL RESPONSIBILITY OR LIABILITY ARISING FROM OR RELATED TO ANY VULNERABILITY ISSUES. FURTHERMORE, TO THE EXTENT PERMITTED BY APPLICABLE LAW, RENESAS ELECTRONICS DISCLAIMS ANY AND ALL WARRANTIES, EXPRESS OR IMPLIED, WITH RESPECT TO THIS DOCUMENT AND ANY RELATED OR ACCOMPANYING SOFTWARE OR HARDWARE, INCLUDING BUT NOT LIMITED TO THE IMPLIED WARRANTIES OF MERCHANTABILITY, OR FITNESS FOR A PARTICULAR PURPOSE.
8. When using Renesas Electronics products, refer to the latest product information (data sheets, user's manuals, application notes, "General Notes for Handling and Using Semiconductor Devices" in the reliability handbook, etc.), and ensure that usage conditions are within the ranges specified by Renesas Electronics with respect to maximum ratings, operating power supply voltage range, heat dissipation characteristics, installation, etc. Renesas Electronics disclaims any and all liability for any malfunctions, failure or accident arising out of the use of Renesas Electronics products outside of such specified ranges.
9. Although Renesas Electronics endeavors to improve the quality and reliability of Renesas Electronics products, semiconductor products have specific characteristics, such as the occurrence of failure at a certain rate and malfunctions under certain use conditions. Unless designated as a high reliability product or a product for harsh environments in a Renesas Electronics data sheet or other Renesas Electronics document, Renesas Electronics products are not subject to radiation resistance design. You are responsible for implementing safety measures to guard against the possibility of bodily injury, injury or damage caused by fire, and/or danger to the public in the event of a failure or malfunction of Renesas Electronics products, such as safety design for hardware and software, including but not limited to redundancy, fire control and malfunction prevention, appropriate treatment for aging degradation or any other appropriate measures. Because the evaluation of microcomputer software alone is very difficult and impractical, you are responsible for evaluating the safety of the final products or systems manufactured by you.
10. Please contact a Renesas Electronics sales office for details as to environmental matters such as the environmental compatibility of each Renesas Electronics product. You are responsible for carefully and sufficiently investigating applicable laws and regulations that regulate the inclusion or use of controlled substances, including without limitation, the EU RoHS Directive, and using Renesas Electronics products in compliance with all these applicable laws and regulations. Renesas Electronics disclaims any and all liability for damages or losses occurring as a result of your noncompliance with applicable laws and regulations.
11. Renesas Electronics products and technologies shall not be used for or incorporated into any products or systems whose manufacture, use, or sale is prohibited under any applicable domestic or foreign laws or regulations. You shall comply with any applicable export control laws and regulations promulgated and administered by the governments of any countries asserting jurisdiction over the parties or transactions.
12. It is the responsibility of the buyer or distributor of Renesas Electronics products, or any other party who distributes, disposes of, or otherwise sells or transfers the product to a third party, to notify such third party in advance of the contents and conditions set forth in this document.
13. This document shall not be reprinted, reproduced or duplicated in any form, in whole or in part, without prior written consent of Renesas Electronics.
14. Please contact a Renesas Electronics sales office if you have any questions regarding the information contained in this document or Renesas Electronics products.

(Note1) "Renesas Electronics" as used in this document means Renesas Electronics Corporation and also includes its directly or indirectly controlled subsidiaries.

(Note2) "Renesas Electronics product(s)" means any product developed or manufactured by or for Renesas Electronics.

(Rev.5.0-1 October 2020)

## Corporate Headquarters

TOYOSU FORESIA, 3-2-24 Toyosu,  
Koto-ku, Tokyo 135-0061, Japan  
[www.renesas.com](http://www.renesas.com)

## Trademarks

Renesas and the Renesas logo are trademarks of Renesas Electronics Corporation. All trademarks and registered trademarks are the property of their respective owners.

## Contact information

For further information on a product, technology, the most up-to-date version of a document, or your nearest sales office, please visit:  
[www.renesas.com/contact/](http://www.renesas.com/contact/).