

Abstract

This application note describes how to create a constant current RGB LED driver using the SLG46580V. By enabling and disabling the GreenPAK’s internal power switches, the designer can regulate the current flow through the individual LEDs of an RGB LED. This system is based on ACMP feedback that measures the voltage across current limiting resistors for each of the LEDs. The constant current levels can be adjusted through I2C for each LED.

Basic Idea and Circuit Layout

Figure 1 shows the circuit schematic for this design. The current regulation is achieved by monitoring R1, R2, and R3 with analog comparators (ACMPs) to enable and disable the GreenPAK’s internal power switches.

When enabled, these switches charge up the output capacitors which increases the voltage across them. Assuming the forward voltage drop of the LEDs stays constant, increasing the output capacitor voltage will increase the voltage across the resistor and, as a result, will increase the current through the LED.

When disabled, the charge stored on the output capacitors will be used to source the current through the LEDs. As current is drawn from the capacitors (C1, C2, and C3), their voltages will begin to drop and the current through the LEDs will decrease. When the voltage across the current limiting resistors falls below the acceptable threshold, the power switches are re-enabled.

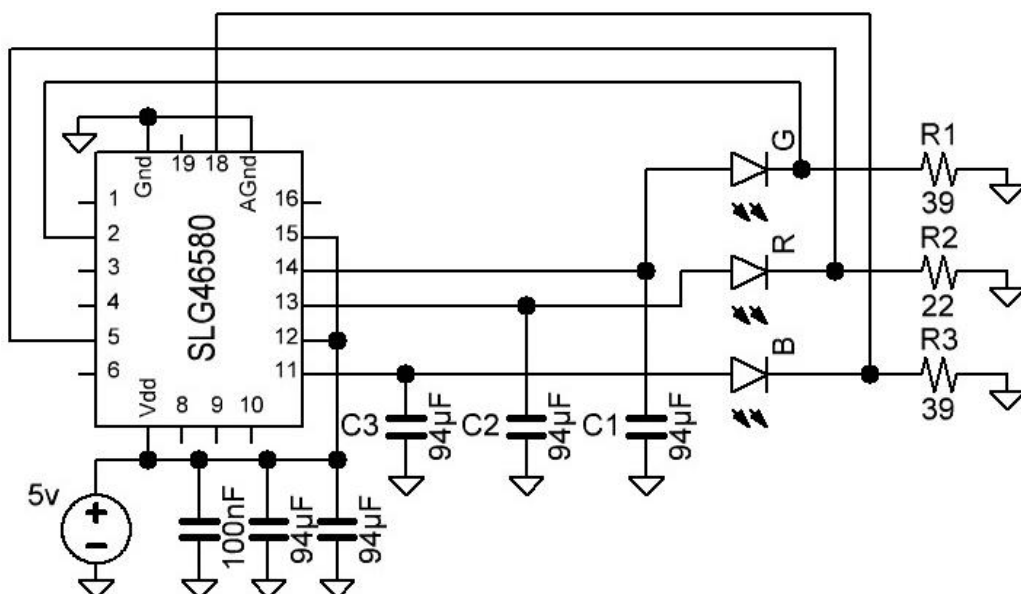

Figure 1: Constant Current RGB Driver Circuit Schematic

The enabling and disabling of the power switches makes up the feedback loop of this regulatory system. Since the power switch is periodically turning on and off, there will be a

ripple voltage present across the resistors as shown in Figure 2. The magnitude and frequency of this ripple voltage depends on the strength of the input voltage source, the current drawn by the LED, the capacitive load size, and the internal delays of the GreenPAK design.

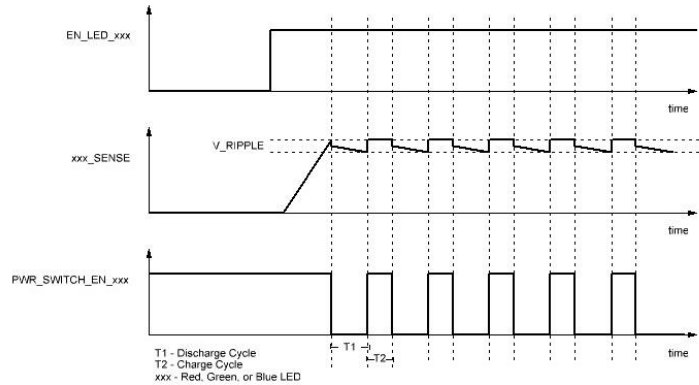

Figure 2: Constant Current Functional Waveform

By changing the ACMP’s IN- reference voltage, the constant current level can be changed. Table 1 shows the register values and respective current levels associated with each of the internal reference voltages.

Table 1: ACMP VREF Relation to LED Current

| Register Value | ACMP VREF (mV) | IBLUE/GREEN (mA) | IRED (mA) |
|----------------|----------------|------------------|-----------|
| 0x00 | 50 | 1.3 | 2.3 |
| 0x01 | 100 | 2.6 | 4.5 |
| 0x02 | 150 | 3.8 | 6.8 |
| 0x03 | 200 | 5.1 | 9.1 |
| 0x04 | 250 | 6.4 | 11.4 |
| 0x05 | 300 | 7.7 | 13.6 |
| 0x06 | 350 | 9.0 | 15.9 |
| 0x07 | 400 | 10.2 | 18.2 |
| 0x08 | 450 | 11.5 | 20.4 |
| 0x09 | 500 | 12.8 | 22.7 |
| 0x0A | 550 | 14.1 | 25.0 |
| 0x0B | 600 | 15.4 | 27.3 |
| 0x0C | 650 | 16.7 | 29.5 |
| 0x0D | 700 | 17.9 | 31.8 |
| 0x0E | 750 | 19.2 | 34.1 |
| 0x0F | 800 | 20.6 | 36.4 |
| 0x10 | 850 | 21.8 | 38.6 |
| 0x11 | 900 | 23.1 | 40.9 |
| 0x12 | 950 | 24.3 | 43.2 |
| 0x13 | 1000 | 25.6 | 45.4 |
| 0x14 | 1050 | 26.9 | 47.7 |
| 0x15 | 1100 | 28.2 | 50.0 |
| 0x16 | 1150 | 29.5 | 52.3 |
| 0x17 | 1200 | 30.8 | 54.5 |

GreenPAK Design

Figure 3 shows the SLG46580V GreenPAK design for this constant current RGB Driver. This figure shows the ACMP SENSE pins on the left-hand side which monitor the voltages across the current limiting resistors. When the SENSE pin voltages drop below the internal threshold

voltages, the power switches close. As the output capacitors are connected to 5V, the capacitor voltages increase quickly and cause a voltage jump on the SENSE pins. This voltage jump results in higher current flow through the LEDs. The delay blocks force the power switches to be disabled for an additional 1 μ s before allowing the power switches to turn on. This helps create a more accurate average current by accommodating for the increased current when the power switch is enabled. The 3-bit LUTs act as inverters when either their GPIO or I2C enables are set high; otherwise, these LUTs disable the power switches.

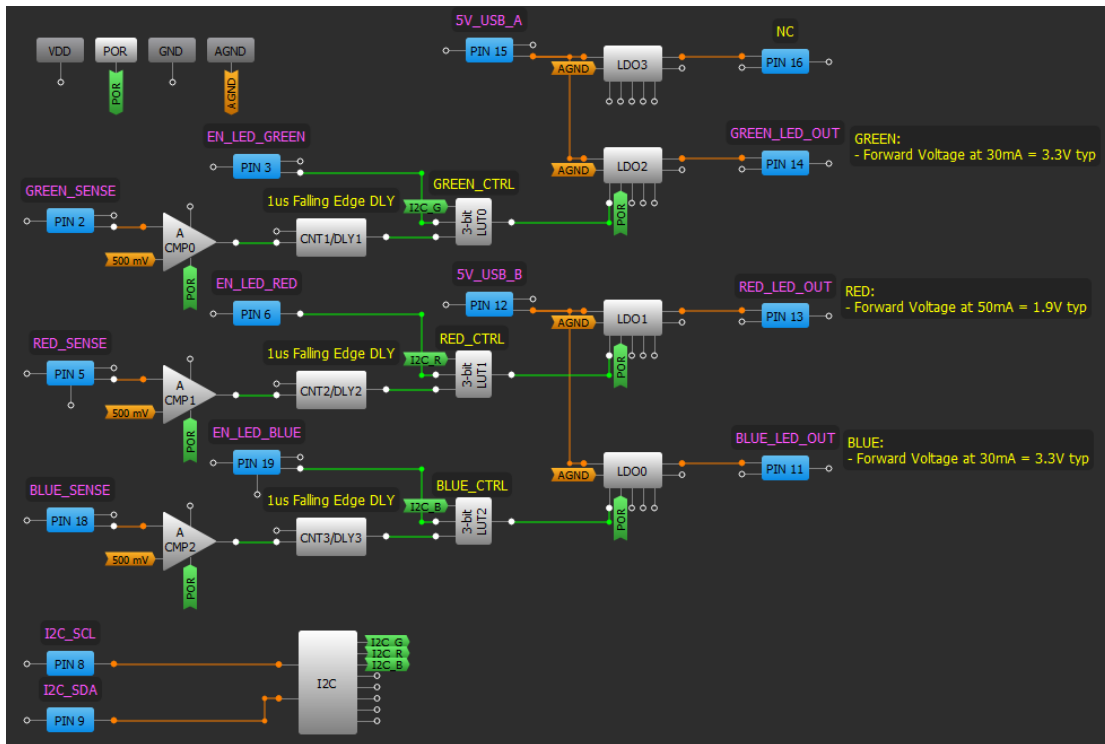

Figure 3: GreenPAK Constant Current RGB Driver Design

I2C Features

By using I2C, the user can alter the ACMP IN- reference voltages to change the constant current settings. In addition, the LEDs can be enabled using the I2C virtual inputs. Table 2 shows the register locations of these features.

Table 2: I2C Registers

| | ACMP0 | ACMP1 | ACMP2 | ACMP3 | I2C Virtual Input |
|----------|----------------|----------------|----------------|----------------|-------------------|
| Register | Reg<1628:1624> | Reg<1636:1632> | Reg<1644:1640> | Reg<1652:1648> | Reg<1959:1952:> |

For more I2C information, please check out [AN-1090](#) (Simple I2C IO Controllers with SLG46531V) and [AN-1091](#) (How to change a GreenPAK comparator’s threshold voltage using I2C). Please reference the SLG46580V datasheet for more register information.

Component Selection

RGB LED Selection:

I've selected a Kingbright RGB LED. (PN: AAAF5060QBFSURZGS) It is important to note that this LED isn't a common anode or a common cathode LED, but rather, it contains 3 individual red, green, and blue LEDs. Table 3 lists some of the important specifications for this LED.

Table 3: Kingbright RGB LED Specifications

| | Blue | Red | Green | Units |
|---------------------------------|----------|----------|-----------|-------|
| Material | InGaN | AlGaInP | InGaN | -- |
| DC Forward Current | 30 | 50 | 30 | mA |
| Peak Forward Current | 150 | 185 | 150 | mA |
| Forward Voltage (typ, max)* | 3.3, 4 | 1.9, 2.5 | 3.3, 4.1 | V |
| Dominant Wavelength* | 465 | 630 | 525 | nm |
| Luminous Intensity (min, typ)** | 280, 400 | 500, 800 | 500, 1000 | mcd |

Notes:

* - $I_F = 20\text{mA}$

** - $I_F = 30\text{mA}$ for Blue and Green, 50mA for Red

Since the average DC forward current of the Kingbright LED is 30 and 50 mA, we are well within the SLG46580V's 150mA power switch limitation. For this design, we are planning to run off a 5V supply. Given the typical 3.3V forward voltage of these LEDs, we have sufficient headroom for use in our ACMP feedback system as will be described in the current limiting resistor section.

Current Limiting Resistor Selection: (R1, R2, R3)

When selecting the resistors for the RGB LEDs, we must perform a couple simple calculations to estimate the proper size. First, we need to know that the maximum reference voltage of the SLG46580V's ACMP is 1.2V. Since the IN- reference voltages of the ACMPs are in 50mV increments, we want to select the largest resistor value to obtain the best current resolution whilst staying under the 1.2V limitation of the ACMP and the 5V power supply limit.

Equation 1 calculates the maximum current limiting resistor voltage to be 1.7V. Since the ACMP input reference is limited to a maximum of 1.2V without an input resistive divider, we should aim to have 1.2V across the current limiting resistors at the maximum current draw.

$$V_{CLRes} \leq V_{SUP} - V_{Forward} = 5V - 3.3V = 1.7V$$

$$\therefore V_{CLRes} = 1.2V$$

Equation 1: Maximum Current Limiting Resistor Voltage Calculation

Once we've selected the maximum current limiting resistor voltage, we can use Equation 2 to select the appropriate resistor value for both the 30mA and 50mA cases. Since 40Ω and 24Ω are not standard resistor values, we will select 39Ω and 22Ω respectively as shown in Figure 1.

$$R \leq \frac{V_{CLRes}}{I_{30}} = \frac{1.2V}{30\text{mA}} = 40\Omega \text{ (For Green and Blue LEDs)}$$

$$R \leq \frac{V_{CLRes}}{I_{50}} = \frac{1.2V}{50\text{mA}} = 24\Omega \text{ (For Red LEDs)}$$

Equation 2: Current Limiting Resistor Calculation

We could increase the range from 1.2V to 1.7V if we use a resistive divider on the ACMP inputs, but we would decrease the current resolution of the ACMP. For example, if we used an input divide by 2, the voltage change across the resistors would be in 100mV steps instead of 50mV steps. We would get 17 steps using the 1.7V limit with the input divide by 2, but we get 24 steps if we use 1.2V without an input divider.

Power Switch Output Capacitor Selection: (C1, C2, C3)

The output capacitor selection impacts a couple factors including the average current accuracy and the initial turn on time of the LEDs. If the power switch is closed, the input sources current to charge the output capacitor. As the output voltage exceeds the ACMP IN-reference, the power switch turns off and the output capacitor begins to source the charge for the LED until the output voltage drops below the ACMP's IN- reference. This charge cycle creates an output ripple voltage across the current limiting resistor that translates directly into current ripple.

Over time, this current ripple can be averaged to determine the brightness of the LED. The size of the capacitor impacts the accuracy of the averaged current.

For larger capacitors, the charge and discharge cycles in Figure 2 take longer. As a result, the ripple voltage is minimized and the average current matches closely with the ideal current calculations. With the increase in output capacitance, the initial turn on time of the LED is increased.

The capacitor's charge is much more fluid for smaller capacitors in that they charge and discharge more quickly. This results in voltage ripples that are larger than those measured with bigger capacitors. The average current differs significantly at low current levels because the charge and discharge cycles can be fast compared to the minimum 1 μ s delay times of the GreenPAK's DLY blocks. For smaller capacitors, the initial turn on time is quicker than that of larger capacitors.

Experimental Results

I tested this constant current LED driver design with four capacitive loads: 1 μ F, 10 μ F, 47 μ F, and 94 μ F. The next couple paragraphs will address the results with the Green LED inside the RGB LED package. The Red and Blue LEDs produced similar results, so I've skipped their waveforms for brevity's sake. Please see Appendix A for the raw data. I've also included the raw data using a 47 μ F input capacitor instead of a 94 μ F capacitor.

Figure 4 plots the constant current drive level through the green LED vs the ACMP reference voltages for various capacitive loads. The deviation from the calculated current level is caused by the voltage jump across the current sense resistor as the power switch is enabled. This design tries to counteract this behavior by keeping the power switch disabled for an additional 1 μ s.

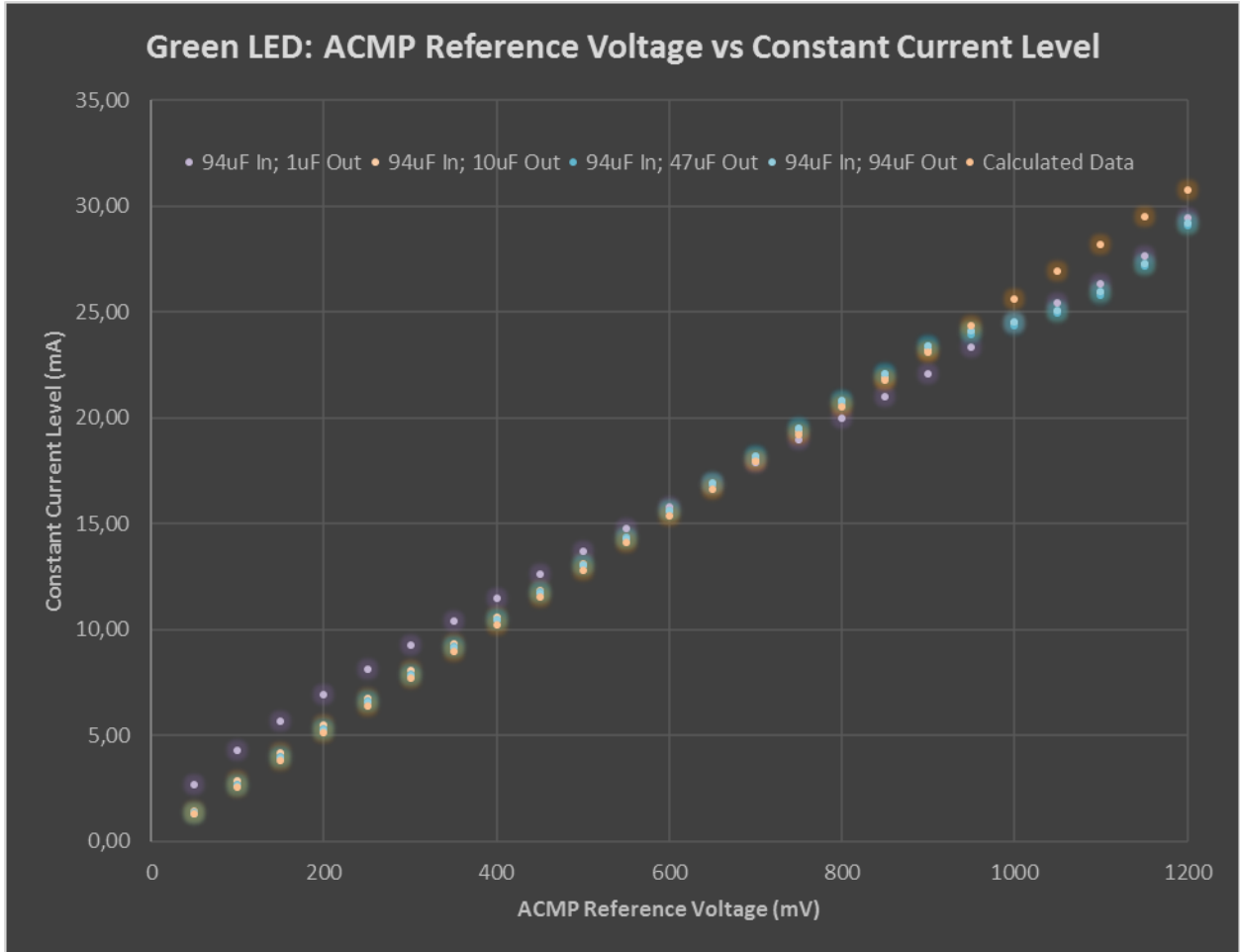

Figure 4: ACMP Reference Voltage vs Constant Current Level for Various Capacitive Loads (Green LED)

The percent error of the drive current can be used to see how far off the measured current levels are from the theoretical current levels. Equation 3 shows the calculation used to obtain the data in Figure 5.

$$Percent\ Error_{Current} = \frac{I_{Meas} - I_{True}}{I_{True}} * 100$$

Equation 3: Percent Error Equation

By looking at Figure 5, we can see that the 94µF capacitor performs more accurately than the other capacitive loads. Due to excessive charging at low current levels, the 1µF capacitor reaches 100% error. This may not be problematic for an application if the desired current levels do not need to be precise.

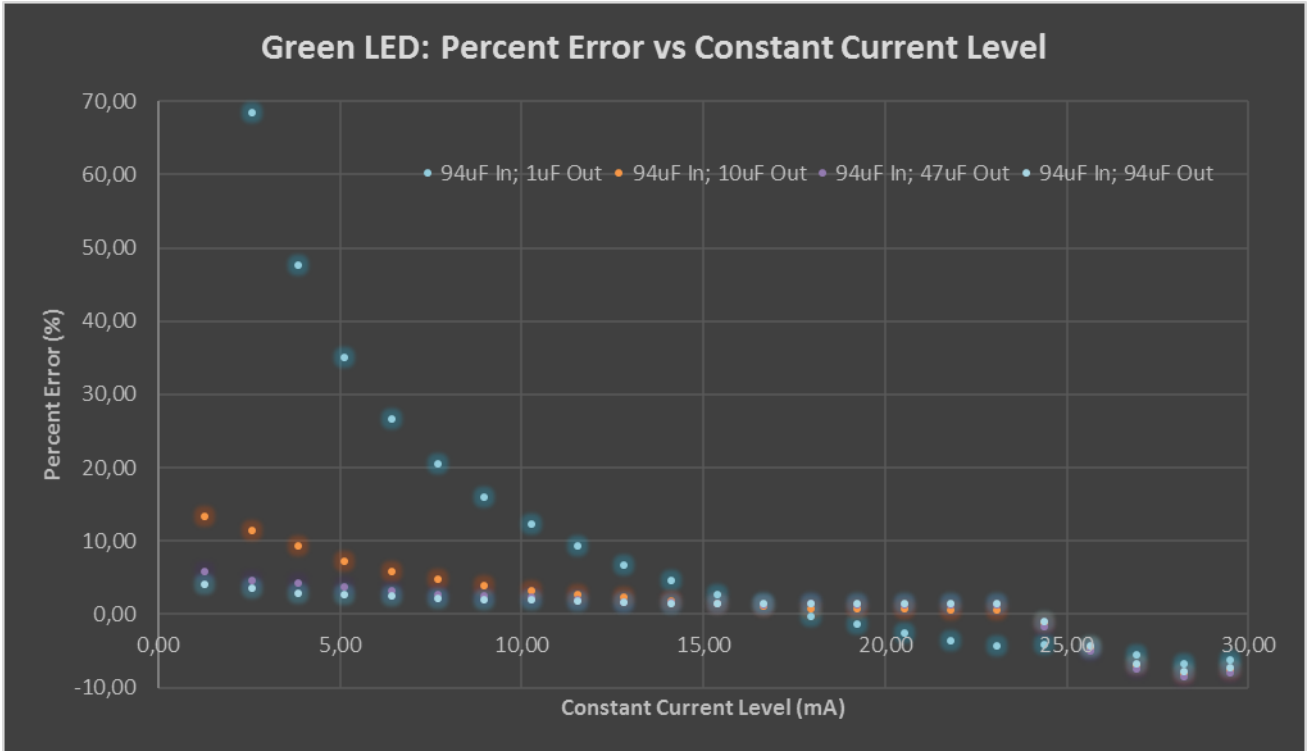

Figure 5: Percent Error vs Constant Current Level for Various Capacitive Loads (Green LED)

On the surface, selecting large output capacitors appears to be the best solution, but by selecting a large capacitance, the inrush current and the turn on time of the LEDs increase. The designer needs to pay attention to this inrush current as it can cause the input voltage rail to droop. The input voltage droop can be minimized by having a larger capacitor to pull charge from when the power switch is initially enabled. Note that the strength of your drive source will also impact the amount of input voltage droop. Weaker sources will experience more voltage droop than stronger sources.

For this design, there are two startup times to consider: partially and fully discharged. When the LED is disabled for a long time (10-20 seconds), the output capacitors discharge significantly by leaking through the LED. Fully discharged capacitors can take 10 μ s to 150 μ s to charge up before being able to supply 30mA of current as shown in Figure 6.

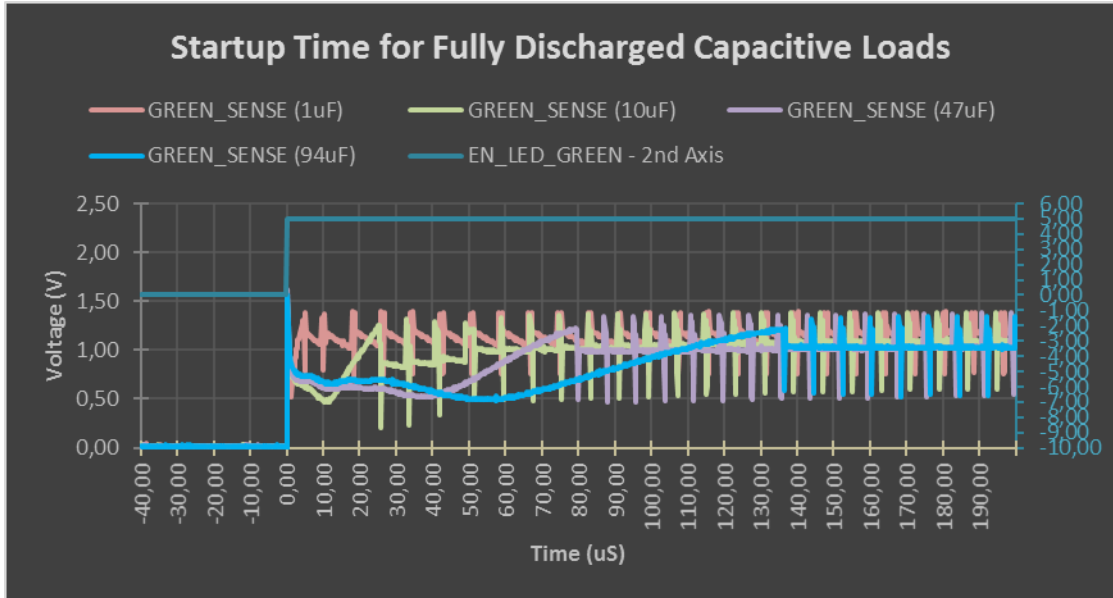

Figure 6: Startup Time for Fully Discharged Capacitive Loads (94µF Input Capacitors)

If the LEDs are being cycled at a quicker rate, the initial turn on times decrease for each of the capacitive loads. For partially discharged capacitive loads, the turn on time can range from 5µs to 50µs as seen in Figure 7.

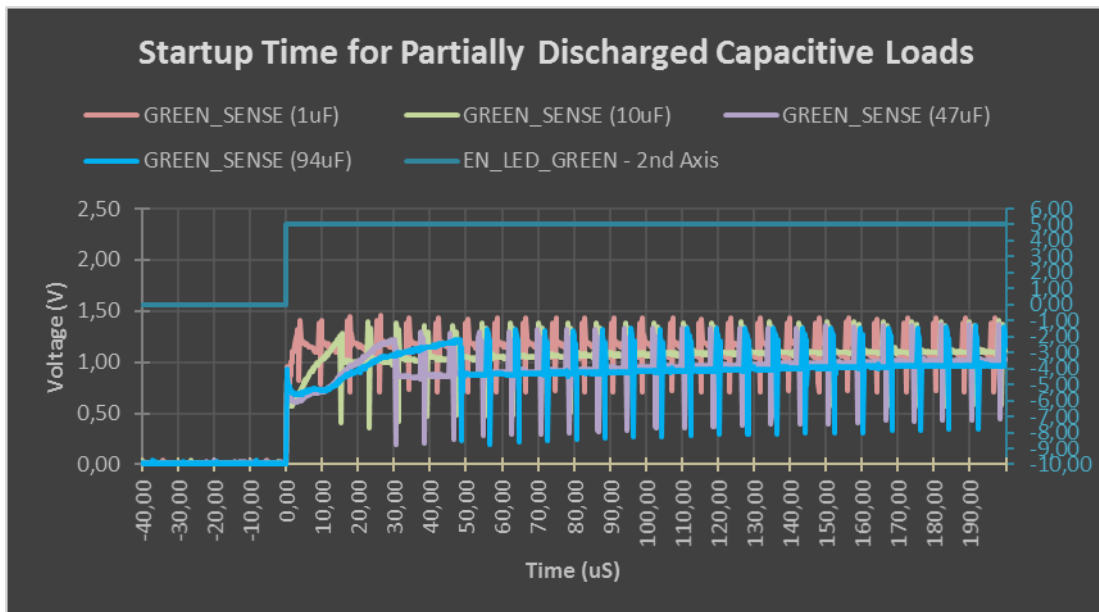

Figure 7: Startup Time for Partially Discharged Capacitive Loads (94µF Input Capacitors)

Figure 8 shows the steady-state, periodic behavior of this design for various loads. This figure shows the previously described voltage jump when the LDO is enabled or disabled and should match the functional waveform shown in Figure 2.

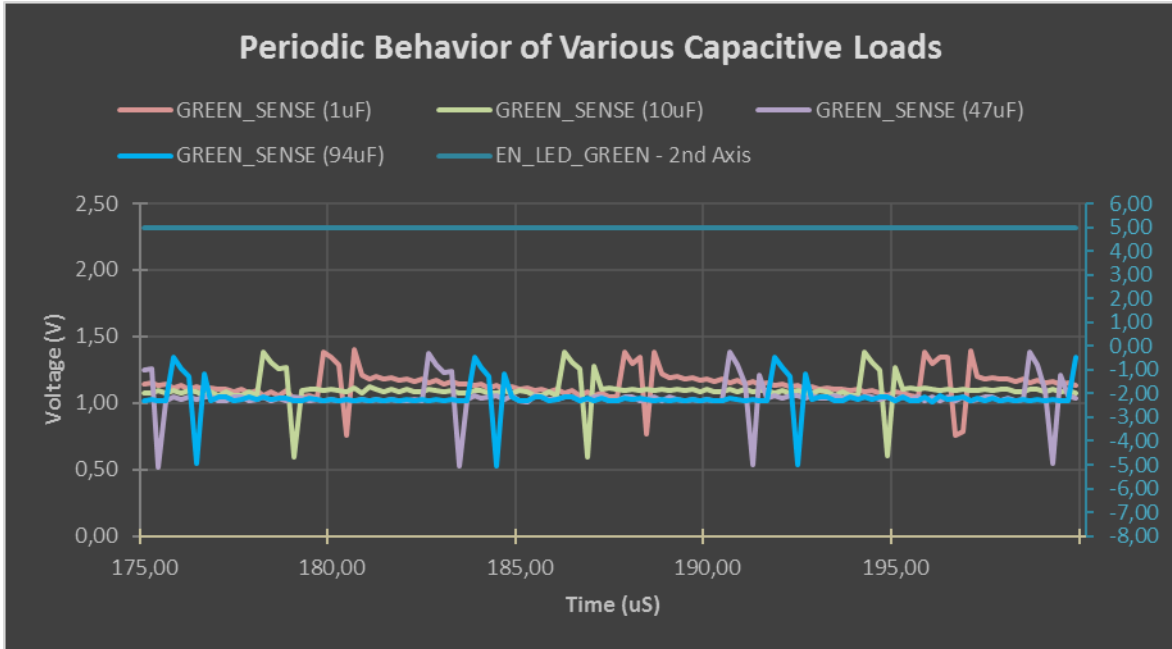

Figure 8: Periodic Behavior of the Various Capacitive Loads (94µF Input Capacitors)

The waveforms above show the performance of this design for applications with varying capacitive loads. The capacitive load size selection depends entirely on the application. For this application note, these results show that the startup time for the LED is about 140µs for a 94µF load capacitor. In addition, the actual current will not deviate more than ±5% from the calculated current levels.

Going Further

This design demonstrates the process of creating a constant current LED driver using the SLG46580V. If one wanted to expound upon this idea, the designer could use an I2C script to create various patterns and colors for the RGB LED.

This design could also be used with an external DAC to provide more reference voltage steps for the ACMP. This would create finer current control for the RGB LEDs.

This design can support constant current designs for LEDs with DC forward currents greater than the 30mA and 50mA examples used in this application note. Table 4 shows the available GreenPAK devices with the corresponding power switch quantity and maximum current limitation.

Table 4: Power Switch Availability

| GreenPAK | # of Power Switches | I _{MAX} Limitation per Switch |
|-----------|---------------------|--|
| SLG46580V | 4 | 150mA |
| SLG46582 | 2 | 300mA |
| SLG46583 | 1 | 600mA |

Conclusion

This constant current driver can be used in conjunction with a microcontroller to source current for LEDs in many different applications. By regulating the current flow through an external current limiting resistor, the designer can control the brightness of each of the LEDs in his or her circuit. The component selection process outlined in this application note will help create a constant current LED driver with the maximum number of current steps using the GreenPAK's internal reference voltages. By extending these principles, this design can become the foundation for creating a simple constant current LED driver for many applications.

Appendix A: Raw Measurement Data

Table 5: Raw Data for 47uF Input / 1uF Output Capacitor

| 1μF | | Green | | | Red | | | Blue | | | | | |
|------|------|------------|-------|---------|--------|------------|---------|-------|--------|------------|-------|-------|--------|
| | | Meas | Calc | % Error | Meas | Calc | % Error | Meas | Calc | % Error | | | |
| 0x00 | 50 | 0.10379247 | 2.66 | 1.28 | 107.58 | 0.11537794 | 5.24 | 2.27 | 130.76 | 0.12175323 | 3.12 | 1.28 | 143.51 |
| 0x01 | 100 | 0.16615782 | 4.26 | 2.56 | 66.16 | 0.17511562 | 7.96 | 4.55 | 75.12 | 0.1817855 | 4.66 | 2.56 | 81.79 |
| 0x02 | 150 | 0.21896942 | 5.61 | 3.85 | 45.98 | 0.22550583 | 10.25 | 6.82 | 50.34 | 0.23340979 | 5.98 | 3.85 | 55.61 |
| 0x03 | 200 | 0.26772105 | 6.86 | 5.13 | 33.86 | 0.2725134 | 12.39 | 9.09 | 36.26 | 0.28182527 | 7.23 | 5.13 | 40.91 |
| 0x04 | 250 | 0.3138484 | 8.05 | 6.41 | 25.54 | 0.31727374 | 14.42 | 11.36 | 26.91 | 0.32801675 | 8.41 | 6.41 | 31.21 |
| 0x05 | 300 | 0.35858112 | 9.19 | 7.69 | 19.53 | 0.36042987 | 16.38 | 13.64 | 20.14 | 0.37283955 | 9.56 | 7.69 | 24.28 |
| 0x06 | 350 | 0.40275658 | 10.33 | 8.97 | 15.07 | 0.40293702 | 18.32 | 15.91 | 15.12 | 0.4173867 | 10.70 | 8.97 | 19.25 |
| 0x07 | 400 | 0.44640148 | 11.45 | 10.26 | 11.60 | 0.44465317 | 20.21 | 18.18 | 11.16 | 0.46106654 | 11.82 | 10.26 | 15.27 |
| 0x08 | 450 | 0.48936079 | 12.55 | 11.54 | 8.75 | 0.48620648 | 22.10 | 20.45 | 8.05 | 0.50447927 | 12.94 | 11.54 | 12.11 |
| 0x09 | 500 | 0.53081713 | 13.61 | 12.82 | 6.16 | 0.52495704 | 23.86 | 22.73 | 4.99 | 0.54678054 | 14.02 | 12.82 | 9.36 |
| 0x0A | 550 | 0.57271651 | 14.69 | 14.10 | 4.13 | 0.56565032 | 25.71 | 25.00 | 2.85 | 0.58792907 | 15.08 | 14.10 | 6.90 |
| 0x0B | 600 | 0.61412511 | 15.75 | 15.38 | 2.35 | 0.60513991 | 27.51 | 27.27 | 0.86 | 0.6312687 | 16.19 | 15.38 | 5.21 |
| 0x0C | 650 | 0.65496818 | 16.79 | 16.67 | 0.76 | 0.64342316 | 29.25 | 29.55 | -1.01 | 0.67258659 | 17.25 | 16.67 | 3.47 |
| 0x0D | 700 | 0.69520097 | 17.83 | 17.95 | -0.69 | 0.68253692 | 31.02 | 31.82 | -2.49 | 0.71408606 | 18.31 | 17.95 | 2.01 |
| 0x0E | 750 | 0.7373418 | 18.91 | 19.23 | -1.69 | 0.72365938 | 32.89 | 34.09 | -3.51 | 0.75455878 | 19.35 | 19.23 | 0.61 |
| 0x0F | 800 | 0.77610465 | 19.90 | 20.51 | -2.99 | 0.76254207 | 34.66 | 36.36 | -4.68 | 0.79664259 | 20.43 | 20.51 | -0.42 |
| 0x10 | 850 | 0.81736643 | 20.96 | 21.79 | -3.84 | 0.79704787 | 36.23 | 38.64 | -6.23 | 0.83789071 | 21.48 | 21.79 | -1.42 |
| 0x11 | 900 | 0.85988201 | 22.05 | 23.08 | -4.46 | 0.85224812 | 38.74 | 40.91 | -5.31 | 0.87721843 | 22.49 | 23.08 | -2.53 |
| 0x12 | 950 | 0.90766286 | 23.27 | 24.36 | -4.46 | 0.89109791 | 40.50 | 43.18 | -6.20 | 0.91915932 | 23.57 | 24.36 | -3.25 |
| 0x13 | 1000 | 0.95431436 | 24.47 | 25.64 | -4.57 | 0.93842265 | 42.66 | 45.45 | -6.16 | 0.96359729 | 24.71 | 25.64 | -3.64 |
| 0x14 | 1050 | 0.97544291 | 25.01 | 26.92 | -7.10 | 0.9848529 | 44.77 | 47.73 | -6.20 | 1.00784423 | 25.84 | 26.92 | -4.01 |
| 0x15 | 1100 | 1.00983025 | 25.89 | 28.21 | -8.20 | 1.02724296 | 46.69 | 50.00 | -6.61 | 1.05466384 | 27.04 | 28.21 | -4.12 |
| 0x16 | 1150 | 1.06286018 | 27.25 | 29.49 | -7.58 | 1.06923613 | 48.60 | 52.27 | -7.02 | 1.10590202 | 28.36 | 29.49 | -3.83 |
| 0x17 | 1200 | 1.13698422 | 29.15 | 30.77 | -5.25 | 1.15238756 | 52.38 | 54.55 | -3.97 | 1.15924573 | 29.72 | 30.77 | -3.40 |

Table 6: Raw Data for 94uF Input / 1uF Output Capacitor

| 1μF | | Green | | | Red | | | Blue | | | | | |
|------|------|------------|-------|---------|--------|------------|---------|-------|--------|------------|-------|-------|--------|
| | | Meas | Calc | % Error | Meas | Calc | % Error | Meas | Calc | % Error | | | |
| 0x00 | 50 | 0.10544961 | 2.70 | 1.28 | 110.90 | 0.11658766 | 5.30 | 2.27 | 133.18 | 0.1219656 | 3.13 | 1.28 | 143.93 |
| 0x01 | 100 | 0.16841484 | 4.32 | 2.56 | 68.41 | 0.17639123 | 8.02 | 4.55 | 76.39 | 0.18184723 | 4.66 | 2.56 | 81.85 |
| 0x02 | 150 | 0.22148852 | 5.68 | 3.85 | 47.66 | 0.22719944 | 10.33 | 6.82 | 51.47 | 0.23398508 | 6.00 | 3.85 | 55.99 |
| 0x03 | 200 | 0.2702408 | 6.93 | 5.13 | 35.12 | 0.27413039 | 12.46 | 9.09 | 37.07 | 0.28203652 | 7.23 | 5.13 | 41.02 |
| 0x04 | 250 | 0.31681257 | 8.12 | 6.41 | 26.73 | 0.31912763 | 14.51 | 11.36 | 27.65 | 0.32829134 | 8.42 | 6.41 | 31.32 |
| 0x05 | 300 | 0.36179645 | 9.28 | 7.69 | 20.60 | 0.36242803 | 16.47 | 13.64 | 20.81 | 0.37359763 | 9.58 | 7.69 | 24.53 |
| 0x06 | 350 | 0.40594958 | 10.41 | 8.97 | 15.99 | 0.40480821 | 18.40 | 15.91 | 15.66 | 0.41828879 | 10.73 | 8.97 | 19.51 |
| 0x07 | 400 | 0.44921564 | 11.52 | 10.26 | 12.30 | 0.44608536 | 20.28 | 18.18 | 11.52 | 0.46164798 | 11.84 | 10.26 | 15.41 |
| 0x08 | 450 | 0.49196858 | 12.61 | 11.54 | 9.33 | 0.48733012 | 22.15 | 20.45 | 8.30 | 0.50514277 | 12.95 | 11.54 | 12.25 |
| 0x09 | 500 | 0.53404017 | 13.69 | 12.82 | 6.81 | 0.52701476 | 23.96 | 22.73 | 5.40 | 0.54771031 | 14.04 | 12.82 | 9.54 |
| 0x0A | 550 | 0.57546574 | 14.76 | 14.10 | 4.63 | 0.60427355 | 27.47 | 25.00 | 9.87 | 0.58997701 | 15.13 | 14.10 | 7.27 |
| 0x0B | 600 | 0.61666606 | 15.81 | 15.38 | 2.78 | 0.60719107 | 27.60 | 27.27 | 1.20 | 0.63178835 | 16.20 | 15.38 | 5.30 |
| 0x0C | 650 | 0.65797972 | 16.87 | 16.67 | 1.23 | 0.64528342 | 29.33 | 29.55 | -0.73 | 0.67298954 | 17.26 | 16.67 | 3.54 |
| 0x0D | 700 | 0.69866542 | 17.91 | 17.95 | -0.19 | 0.6833907 | 31.06 | 31.82 | -2.37 | 0.71545727 | 18.35 | 17.95 | 2.21 |
| 0x0E | 750 | 0.7402992 | 18.98 | 19.23 | -1.29 | 0.72499195 | 32.95 | 34.09 | -3.33 | 0.75650091 | 19.40 | 19.23 | 0.87 |
| 0x0F | 800 | 0.77923443 | 19.98 | 20.51 | -2.60 | 0.76366601 | 34.71 | 36.36 | -4.54 | 0.79802829 | 20.46 | 20.51 | -0.25 |
| 0x10 | 850 | 0.819662 | 21.02 | 21.79 | -3.57 | 0.79876461 | 36.31 | 38.64 | -6.03 | 0.83916501 | 21.52 | 21.79 | -1.27 |
| 0x11 | 900 | 0.86193967 | 22.10 | 23.08 | -4.23 | 0.85408488 | 38.82 | 40.91 | -5.10 | 0.87845455 | 22.52 | 23.08 | -2.39 |
| 0x12 | 950 | 0.9106347 | 23.35 | 24.36 | -4.14 | 0.88793466 | 40.36 | 43.18 | -6.53 | 0.92064209 | 23.61 | 24.36 | -3.09 |
| 0x13 | 1000 | 0.95426373 | 24.47 | 25.64 | -4.57 | 0.93464328 | 42.48 | 45.45 | -6.54 | 0.96424275 | 24.72 | 25.64 | -3.58 |
| 0x14 | 1050 | 0.99187168 | 25.43 | 26.92 | -5.54 | 0.98019999 | 44.55 | 47.73 | -6.65 | 1.00857849 | 25.86 | 26.92 | -3.94 |
| 0x15 | 1100 | 1.02673933 | 26.33 | 28.21 | -6.66 | 1.02636925 | 46.65 | 50.00 | -6.69 | 1.05540592 | 27.06 | 28.21 | -4.05 |
| 0x16 | 1150 | 1.07916886 | 27.67 | 29.49 | -6.16 | 1.07175653 | 48.72 | 52.27 | -6.80 | 1.10651142 | 28.37 | 29.49 | -3.78 |
| 0x17 | 1200 | 1.14910569 | 29.46 | 30.77 | -4.24 | 1.15607567 | 52.55 | 54.55 | -3.66 | 1.16008577 | 29.75 | 30.77 | -3.33 |

Table 7: Raw Data for 47uF Input / 10uF Output Capacitor

| 10μF | | Green | | | Red | | | Blue | | | | | |
|------|------|------------|-------|---------|-------|------------|---------|-------|-------|------------|-------|-------|-------|
| | | Meas | Calc | % Error | Meas | Calc | % Error | Meas | Calc | % Error | | | |
| 0x00 | 50 | 0.05696687 | 1.46 | 1.28 | 13.93 | 0.0608695 | 2.77 | 2.27 | 21.74 | 0.06364242 | 1.63 | 1.28 | 27.28 |
| 0x01 | 100 | 0.11190378 | 2.87 | 2.56 | 11.90 | 0.1167021 | 5.30 | 4.55 | 16.70 | 0.11729143 | 3.01 | 2.56 | 17.29 |
| 0x02 | 150 | 0.16386559 | 4.20 | 3.85 | 9.24 | 0.16933401 | 7.70 | 6.82 | 12.89 | 0.16829089 | 4.32 | 3.85 | 12.19 |
| 0x03 | 200 | 0.21452406 | 5.50 | 5.13 | 7.26 | 0.22096825 | 10.04 | 9.09 | 10.48 | 0.21900129 | 5.62 | 5.13 | 9.50 |
| 0x04 | 250 | 0.26469255 | 6.79 | 6.41 | 5.88 | 0.27264091 | 12.39 | 11.36 | 9.06 | 0.26849579 | 6.88 | 6.41 | 7.40 |
| 0x05 | 300 | 0.31427045 | 8.06 | 7.69 | 4.76 | 0.32385321 | 14.72 | 13.64 | 7.95 | 0.31903935 | 8.18 | 7.69 | 6.35 |
| 0x06 | 350 | 0.36356466 | 9.32 | 8.97 | 3.88 | 0.37505051 | 17.05 | 15.91 | 7.16 | 0.36874841 | 9.46 | 8.97 | 5.36 |
| 0x07 | 400 | 0.41306167 | 10.59 | 10.26 | 3.27 | 0.42597334 | 19.36 | 18.18 | 6.49 | 0.41871936 | 10.74 | 10.26 | 4.68 |
| 0x08 | 450 | 0.46215197 | 11.85 | 11.54 | 2.70 | 0.47648217 | 21.66 | 20.45 | 5.88 | 0.46798635 | 12.00 | 11.54 | 4.00 |
| 0x09 | 500 | 0.51098743 | 13.10 | 12.82 | 2.20 | 0.53380787 | 24.26 | 22.73 | 6.76 | 0.51768896 | 13.27 | 12.82 | 3.54 |
| 0x0A | 550 | 0.55960619 | 14.35 | 14.10 | 1.75 | 0.58261136 | 26.48 | 25.00 | 5.93 | 0.56683641 | 14.53 | 14.10 | 3.06 |
| 0x0B | 600 | 0.60814478 | 15.59 | 15.38 | 1.36 | 0.62860522 | 28.57 | 27.27 | 4.77 | 0.61631691 | 15.80 | 15.38 | 2.72 |
| 0x0C | 650 | 0.65656522 | 16.84 | 16.67 | 1.01 | 0.68043583 | 30.93 | 29.55 | 4.68 | 0.66513055 | 17.05 | 16.67 | 2.33 |
| 0x0D | 700 | 0.7053916 | 18.09 | 17.95 | 0.77 | 0.73217776 | 33.28 | 31.82 | 4.60 | 0.71416908 | 18.31 | 17.95 | 2.02 |
| 0x0E | 750 | 0.75526266 | 19.37 | 19.23 | 0.70 | 0.78485439 | 35.68 | 34.09 | 4.65 | 0.76372485 | 19.58 | 19.23 | 1.83 |
| 0x0F | 800 | 0.80548788 | 20.65 | 20.51 | 0.69 | 0.83361132 | 37.89 | 36.36 | 4.20 | 0.81248002 | 20.83 | 20.51 | 1.56 |
| 0x10 | 850 | 0.85543585 | 21.93 | 21.79 | 0.64 | 0.88269354 | 40.12 | 38.64 | 3.85 | 0.86449548 | 22.17 | 21.79 | 1.71 |
| 0x11 | 900 | 0.90548148 | 23.22 | 23.08 | 0.61 | 0.89966919 | 40.89 | 40.91 | -0.04 | 0.91472816 | 23.45 | 23.08 | 1.64 |
| 0x12 | 950 | 0.92975533 | 23.84 | 24.36 | -2.13 | 0.91862285 | 41.76 | 43.18 | -3.30 | 0.96463776 | 24.73 | 24.36 | 1.54 |
| 0x13 | 1000 | 0.94440475 | 24.22 | 25.64 | -5.56 | 0.94529897 | 42.97 | 45.45 | -5.47 | 1.01494303 | 26.02 | 25.64 | 1.49 |
| 0x14 | 1050 | 0.9652224 | 24.75 | 26.92 | -8.07 | 0.98863585 | 44.94 | 47.73 | -5.84 | 1.06544166 | 27.32 | 26.92 | 1.47 |
| 0x15 | 1100 | 0.99919215 | 25.62 | 28.21 | -9.16 | 1.05643345 | 48.02 | 50.00 | -3.96 | 1.11603657 | 28.62 | 28.21 | 1.46 |
| 0x16 | 1150 | 1.0515009 | 26.96 | 29.49 | -8.57 | 1.15793781 | 52.63 | 52.27 | 0.69 | 1.16646977 | 29.91 | 29.49 | 1.43 |
| 0x17 | 1200 | 1.12696417 | 28.90 | 30.77 | -6.09 | 1.25019887 | 56.83 | 54.55 | 4.18 | 1.21734881 | 31.21 | 30.77 | 1.45 |

Table 8: Raw Data for 94uF Input / 10uF Output Capacitor

| 10μF | | Green | | | Red | | | Blue | | | | | |
|------|------|------------|-------|---------|-------|------------|---------|-------|-------|------------|-------|-------|-------|
| | | Meas | Calc | % Error | Meas | Calc | % Error | Meas | Calc | % Error | | | |
| 0x00 | 50 | 0.05667659 | 1.45 | 1.28 | 13.35 | 0.06039193 | 2.75 | 2.27 | 20.78 | 0.0631777 | 1.62 | 1.28 | 26.36 |
| 0x01 | 100 | 0.1114737 | 2.86 | 2.56 | 11.47 | 0.11675404 | 5.31 | 4.55 | 16.75 | 0.11677163 | 2.99 | 2.56 | 16.77 |
| 0x02 | 150 | 0.16397112 | 4.20 | 3.85 | 9.31 | 0.16956418 | 7.71 | 6.82 | 13.04 | 0.16766698 | 4.30 | 3.85 | 11.78 |
| 0x03 | 200 | 0.21453605 | 5.50 | 5.13 | 7.27 | 0.22109595 | 10.05 | 9.09 | 10.55 | 0.21866362 | 5.61 | 5.13 | 9.33 |
| 0x04 | 250 | 0.26449718 | 6.78 | 6.41 | 5.80 | 0.27298962 | 12.41 | 11.36 | 9.20 | 0.2687388 | 6.89 | 6.41 | 7.50 |
| 0x05 | 300 | 0.31443697 | 8.06 | 7.69 | 4.81 | 0.3239341 | 14.72 | 13.64 | 7.98 | 0.31862643 | 8.17 | 7.69 | 6.21 |
| 0x06 | 350 | 0.36373456 | 9.33 | 8.97 | 3.92 | 0.37484507 | 17.04 | 15.91 | 7.10 | 0.36824002 | 9.44 | 8.97 | 5.21 |
| 0x07 | 400 | 0.41308802 | 10.59 | 10.26 | 3.27 | 0.4258419 | 19.36 | 18.18 | 6.46 | 0.41829517 | 10.73 | 10.26 | 4.57 |
| 0x08 | 450 | 0.46216109 | 11.85 | 11.54 | 2.70 | 0.47643272 | 21.66 | 20.45 | 5.87 | 0.46777219 | 11.99 | 11.54 | 3.95 |
| 0x09 | 500 | 0.51139605 | 13.11 | 12.82 | 2.28 | 0.53307068 | 24.23 | 22.73 | 6.61 | 0.51733506 | 13.27 | 12.82 | 3.47 |
| 0x0A | 550 | 0.56013487 | 14.36 | 14.10 | 1.84 | 0.58359091 | 26.53 | 25.00 | 6.11 | 0.56672071 | 14.53 | 14.10 | 3.04 |
| 0x0B | 600 | 0.60853462 | 15.60 | 15.38 | 1.42 | 0.62771951 | 28.53 | 27.27 | 4.62 | 0.61568856 | 15.79 | 15.38 | 2.61 |
| 0x0C | 650 | 0.65709471 | 16.85 | 16.67 | 1.09 | 0.68043057 | 30.93 | 29.55 | 4.68 | 0.66477022 | 17.05 | 16.67 | 2.27 |
| 0x0D | 700 | 0.70591019 | 18.10 | 17.95 | 0.84 | 0.73302461 | 33.32 | 31.82 | 4.72 | 0.71382589 | 18.30 | 17.95 | 1.98 |
| 0x0E | 750 | 0.75570922 | 19.38 | 19.23 | 0.76 | 0.78416394 | 35.64 | 34.09 | 4.56 | 0.76305229 | 19.57 | 19.23 | 1.74 |
| 0x0F | 800 | 0.80650331 | 20.68 | 20.51 | 0.81 | 0.83453021 | 37.93 | 36.36 | 4.32 | 0.81203826 | 20.82 | 20.51 | 1.50 |
| 0x10 | 850 | 0.85541153 | 21.93 | 21.79 | 0.64 | 0.88538484 | 40.24 | 38.64 | 4.16 | 0.86357862 | 22.14 | 21.79 | 1.60 |
| 0x11 | 900 | 0.90564218 | 23.22 | 23.08 | 0.63 | 0.9121895 | 41.46 | 40.91 | 1.35 | 0.91405471 | 23.44 | 23.08 | 1.56 |
| 0x12 | 950 | 0.93859806 | 24.07 | 24.36 | -1.20 | 0.93358964 | 42.44 | 43.18 | -1.73 | 0.96344014 | 24.70 | 24.36 | 1.41 |
| 0x13 | 1000 | 0.95464993 | 24.48 | 25.64 | -4.54 | 0.96179225 | 43.72 | 45.45 | -3.82 | 1.01358792 | 25.99 | 25.64 | 1.36 |
| 0x14 | 1050 | 0.97648599 | 25.04 | 26.92 | -7.00 | 1.00526445 | 45.69 | 47.73 | -4.26 | 1.06392257 | 27.28 | 26.92 | 1.33 |
| 0x15 | 1100 | 1.01062508 | 25.91 | 28.21 | -8.12 | 1.07413981 | 48.82 | 50.00 | -2.35 | 1.11461595 | 28.58 | 28.21 | 1.33 |
| 0x16 | 1150 | 1.06282538 | 27.25 | 29.49 | -7.58 | 1.17652837 | 53.48 | 52.27 | 2.31 | 1.16496896 | 29.87 | 29.49 | 1.30 |
| 0x17 | 1200 | 1.13744593 | 29.17 | 30.77 | -5.21 | 1.24881434 | 56.76 | 54.55 | 4.07 | 1.21599284 | 31.18 | 30.77 | 1.33 |

Table 9: Raw Data for 47uF Input / 47uF Output Capacitor

| 47μF | | Green | | | Red | | | Blue | | | | | |
|------|------|------------|-------|---------|-------|------------|---------|-------|-------|------------|-------|-------|-------|
| | | Meas | Calc | % Error | Meas | Calc | % Error | Meas | Calc | % Error | | | |
| 0x00 | 50 | 0.05284997 | 1.36 | 1.28 | 5.70 | 0.05572375 | 2.53 | 2.27 | 11.45 | 0.05597801 | 1.44 | 1.28 | 11.96 |
| 0x01 | 100 | 0.10446982 | 2.68 | 2.56 | 4.47 | 0.10880488 | 4.95 | 4.55 | 8.80 | 0.10849779 | 2.78 | 2.56 | 8.50 |
| 0x02 | 150 | 0.15602785 | 4.00 | 3.85 | 4.02 | 0.1627258 | 7.40 | 6.82 | 8.48 | 0.16003556 | 4.10 | 3.85 | 6.69 |
| 0x03 | 200 | 0.20705548 | 5.31 | 5.13 | 3.53 | 0.21487117 | 9.77 | 9.09 | 7.44 | 0.21083247 | 5.41 | 5.13 | 5.42 |
| 0x04 | 250 | 0.25767828 | 6.61 | 6.41 | 3.07 | 0.26757125 | 12.16 | 11.36 | 7.03 | 0.26153132 | 6.71 | 6.41 | 4.61 |
| 0x05 | 300 | 0.308024 | 7.90 | 7.69 | 2.67 | 0.31904542 | 14.50 | 13.64 | 6.35 | 0.312157 | 8.00 | 7.69 | 4.05 |
| 0x06 | 350 | 0.35835892 | 9.19 | 8.97 | 2.39 | 0.37227837 | 16.92 | 15.91 | 6.37 | 0.36272472 | 9.30 | 8.97 | 3.64 |
| 0x07 | 400 | 0.40828701 | 10.47 | 10.26 | 2.07 | 0.42390311 | 19.27 | 18.18 | 5.98 | 0.41316941 | 10.59 | 10.26 | 3.29 |
| 0x08 | 450 | 0.45843415 | 11.75 | 11.54 | 1.87 | 0.47591661 | 21.63 | 20.45 | 5.76 | 0.46369158 | 11.89 | 11.54 | 3.04 |
| 0x09 | 500 | 0.50819755 | 13.03 | 12.82 | 1.64 | 0.53043107 | 24.11 | 22.73 | 6.09 | 0.51395828 | 13.18 | 12.82 | 2.79 |
| 0x0A | 550 | 0.55824129 | 14.31 | 14.10 | 1.50 | 0.58225828 | 26.47 | 25.00 | 5.87 | 0.56444652 | 14.47 | 14.10 | 2.63 |
| 0x0B | 600 | 0.60809776 | 15.59 | 15.38 | 1.35 | 0.63292883 | 28.77 | 27.27 | 5.49 | 0.61435939 | 15.75 | 15.38 | 2.39 |
| 0x0C | 650 | 0.65889063 | 16.89 | 16.67 | 1.37 | 0.68554104 | 31.16 | 29.55 | 5.47 | 0.6645481 | 17.04 | 16.67 | 2.24 |
| 0x0D | 700 | 0.7096786 | 18.20 | 17.95 | 1.38 | 0.73836305 | 33.56 | 31.82 | 5.48 | 0.7146985 | 18.33 | 17.95 | 2.10 |
| 0x0E | 750 | 0.75915353 | 19.47 | 19.23 | 1.22 | 0.79074113 | 35.94 | 34.09 | 5.43 | 0.76616247 | 19.65 | 19.23 | 2.15 |
| 0x0F | 800 | 0.80958737 | 20.76 | 20.51 | 1.20 | 0.84278624 | 38.31 | 36.36 | 5.35 | 0.81768077 | 20.97 | 20.51 | 2.21 |
| 0x10 | 850 | 0.8598852 | 22.05 | 21.79 | 1.16 | 0.88893407 | 40.41 | 38.64 | 4.58 | 0.86730782 | 22.24 | 21.79 | 2.04 |
| 0x11 | 900 | 0.91044416 | 23.34 | 23.08 | 1.16 | 0.91066016 | 41.39 | 40.91 | 1.18 | 0.91824571 | 23.54 | 23.08 | 2.03 |
| 0x12 | 950 | 0.92981981 | 23.84 | 24.36 | -2.12 | 0.93188495 | 42.36 | 43.18 | -1.91 | 0.96880778 | 24.84 | 24.36 | 1.98 |
| 0x13 | 1000 | 0.94497926 | 24.23 | 25.64 | -5.50 | 0.9607309 | 43.67 | 45.45 | -3.93 | 1.01981203 | 26.15 | 25.64 | 1.98 |
| 0x14 | 1050 | 0.96604538 | 24.77 | 26.92 | -8.00 | 1.0042516 | 45.65 | 47.73 | -4.36 | 1.07105886 | 27.46 | 26.92 | 2.01 |
| 0x15 | 1100 | 1.00018289 | 25.65 | 28.21 | -9.07 | 1.07300547 | 48.77 | 50.00 | -2.45 | 1.12235726 | 28.78 | 28.21 | 2.03 |
| 0x16 | 1150 | 1.05221671 | 26.98 | 29.49 | -8.50 | 1.17405224 | 53.37 | 52.27 | 2.09 | 1.17247753 | 30.06 | 29.49 | 1.95 |
| 0x17 | 1200 | 1.12718062 | 28.90 | 30.77 | -6.07 | 1.26327698 | 57.42 | 54.55 | 5.27 | 1.22272863 | 31.35 | 30.77 | 1.89 |

Table 10: Raw Data for 94uF Input / 47uF Output Capacitor

| 47μF | | Green | | | Red | | | Blue | | | | | |
|------|------|------------|-------|---------|-------|------------|---------|-------|-------|------------|-------|-------|-------|
| | | Meas | Calc | % Error | Meas | Calc | % Error | Meas | Calc | % Error | | | |
| 0x00 | 50 | 0.05291514 | 1.36 | 1.28 | 5.83 | 0.05539243 | 2.52 | 2.27 | 10.78 | 0.05601921 | 1.44 | 1.28 | 12.04 |
| 0x01 | 100 | 0.10462567 | 2.68 | 2.56 | 4.63 | 0.10912348 | 4.96 | 4.55 | 9.12 | 0.10843575 | 2.78 | 2.56 | 8.44 |
| 0x02 | 150 | 0.1564698 | 4.01 | 3.85 | 4.31 | 0.1625579 | 7.39 | 6.82 | 8.37 | 0.15990617 | 4.10 | 3.85 | 6.60 |
| 0x03 | 200 | 0.20741859 | 5.32 | 5.13 | 3.71 | 0.21504034 | 9.77 | 9.09 | 7.52 | 0.21036629 | 5.39 | 5.13 | 5.18 |
| 0x04 | 250 | 0.25806276 | 6.62 | 6.41 | 3.23 | 0.26746106 | 12.16 | 11.36 | 6.98 | 0.26173763 | 6.71 | 6.41 | 4.70 |
| 0x05 | 300 | 0.30814908 | 7.90 | 7.69 | 2.72 | 0.31994793 | 14.54 | 13.64 | 6.65 | 0.31229453 | 8.01 | 7.69 | 4.10 |
| 0x06 | 350 | 0.35868465 | 9.20 | 8.97 | 2.48 | 0.37261995 | 16.94 | 15.91 | 6.46 | 0.36260267 | 9.30 | 8.97 | 3.60 |
| 0x07 | 400 | 0.40914515 | 10.49 | 10.26 | 2.29 | 0.42412714 | 19.28 | 18.18 | 6.03 | 0.41311657 | 10.59 | 10.26 | 3.28 |
| 0x08 | 450 | 0.45877138 | 11.76 | 11.54 | 1.95 | 0.47657509 | 21.66 | 20.45 | 5.91 | 0.46399478 | 11.90 | 11.54 | 3.11 |
| 0x09 | 500 | 0.50855585 | 13.04 | 12.82 | 1.71 | 0.53012237 | 24.10 | 22.73 | 6.02 | 0.51392322 | 13.18 | 12.82 | 2.78 |
| 0x0A | 550 | 0.55900969 | 14.33 | 14.10 | 1.64 | 0.5829086 | 26.50 | 25.00 | 5.98 | 0.56458547 | 14.48 | 14.10 | 2.65 |
| 0x0B | 600 | 0.60911462 | 15.62 | 15.38 | 1.52 | 0.63359852 | 28.80 | 27.27 | 5.60 | 0.61437464 | 15.75 | 15.38 | 2.40 |
| 0x0C | 650 | 0.65890609 | 16.90 | 16.67 | 1.37 | 0.68622949 | 31.19 | 29.55 | 5.57 | 0.66458817 | 17.04 | 16.67 | 2.24 |
| 0x0D | 700 | 0.71044378 | 18.22 | 17.95 | 1.49 | 0.73885477 | 33.58 | 31.82 | 5.55 | 0.71513022 | 18.34 | 17.95 | 2.16 |
| 0x0E | 750 | 0.76011529 | 19.49 | 19.23 | 1.35 | 0.79096045 | 35.95 | 34.09 | 5.46 | 0.76657382 | 19.66 | 19.23 | 2.21 |
| 0x0F | 800 | 0.81060667 | 20.78 | 20.51 | 1.33 | 0.84223802 | 38.28 | 36.36 | 5.28 | 0.81806824 | 20.98 | 20.51 | 2.26 |
| 0x10 | 850 | 0.86115742 | 22.08 | 21.79 | 1.31 | 0.8937373 | 40.62 | 38.64 | 5.15 | 0.86766599 | 22.25 | 21.79 | 2.08 |
| 0x11 | 900 | 0.91173149 | 23.38 | 23.08 | 1.30 | 0.92951703 | 42.25 | 40.91 | 3.28 | 0.91850303 | 23.55 | 23.08 | 2.06 |
| 0x12 | 950 | 0.93476316 | 23.97 | 24.36 | -1.60 | 0.95465707 | 43.39 | 43.18 | 0.49 | 0.96900081 | 24.85 | 24.36 | 2.00 |
| 0x13 | 1000 | 0.95066682 | 24.38 | 25.64 | -4.93 | 0.98530644 | 44.79 | 45.45 | -1.47 | 1.0201794 | 26.16 | 25.64 | 2.02 |
| 0x14 | 1050 | 0.97236449 | 24.93 | 26.92 | -7.39 | 1.03180084 | 46.90 | 47.73 | -1.73 | 1.07079682 | 27.46 | 26.92 | 1.98 |
| 0x15 | 1100 | 1.00661917 | 25.81 | 28.21 | -8.49 | 1.10290594 | 50.13 | 50.00 | 0.26 | 1.12191533 | 28.77 | 28.21 | 1.99 |
| 0x16 | 1150 | 1.05867592 | 27.15 | 29.49 | -7.94 | 1.20250549 | 54.66 | 52.27 | 4.57 | 1.17251081 | 30.06 | 29.49 | 1.96 |
| 0x17 | 1200 | 1.13346901 | 29.06 | 30.77 | -5.54 | 1.26252175 | 57.39 | 54.55 | 5.21 | 1.22278686 | 31.35 | 30.77 | 1.90 |

Table 11: Raw Data for 47uF Input / 94uF Output Capacitor

| 94μF | | Green | | | Red | | | Blue | | | | | |
|------|------|------------|-------|---------|-------|------------|---------|-------|-------|------------|-------|-------|------|
| | | Meas | Calc | % Error | Meas | Calc | % Error | Meas | Calc | % Error | | | |
| 0x00 | 50 | 0.05196736 | 1.33 | 1.28 | 3.93 | 0.05478907 | 2.49 | 2.27 | 9.58 | 0.05419975 | 1.39 | 1.28 | 8.40 |
| 0x01 | 100 | 0.103065 | 2.64 | 2.56 | 3.07 | 0.10768332 | 4.89 | 4.55 | 7.68 | 0.1058245 | 2.71 | 2.56 | 5.82 |
| 0x02 | 150 | 0.15412767 | 3.95 | 3.85 | 2.75 | 0.16099784 | 7.32 | 6.82 | 7.33 | 0.1572915 | 4.03 | 3.85 | 4.86 |
| 0x03 | 200 | 0.20490047 | 5.25 | 5.13 | 2.45 | 0.21394376 | 9.72 | 9.09 | 6.97 | 0.20848153 | 5.35 | 5.13 | 4.24 |
| 0x04 | 250 | 0.25549392 | 6.55 | 6.41 | 2.20 | 0.26762751 | 12.16 | 11.36 | 7.05 | 0.25987667 | 6.66 | 6.41 | 3.95 |
| 0x05 | 300 | 0.30603438 | 7.85 | 7.69 | 2.01 | 0.31921234 | 14.51 | 13.64 | 6.40 | 0.31047097 | 7.96 | 7.69 | 3.49 |
| 0x06 | 350 | 0.3565531 | 9.14 | 8.97 | 1.87 | 0.37237293 | 16.93 | 15.91 | 6.39 | 0.36143307 | 9.27 | 8.97 | 3.27 |
| 0x07 | 400 | 0.40703449 | 10.44 | 10.26 | 1.76 | 0.42561601 | 19.35 | 18.18 | 6.40 | 0.41235934 | 10.57 | 10.26 | 3.09 |
| 0x08 | 450 | 0.45719809 | 11.72 | 11.54 | 1.60 | 0.47891979 | 21.77 | 20.45 | 6.43 | 0.46312996 | 11.88 | 11.54 | 2.92 |
| 0x09 | 500 | 0.50785377 | 13.02 | 12.82 | 1.57 | 0.53177389 | 24.17 | 22.73 | 6.35 | 0.51383347 | 13.18 | 12.82 | 2.77 |
| 0x0A | 550 | 0.55790184 | 14.31 | 14.10 | 1.44 | 0.58490111 | 26.59 | 25.00 | 6.35 | 0.5641612 | 14.47 | 14.10 | 2.57 |
| 0x0B | 600 | 0.60806349 | 15.59 | 15.38 | 1.34 | 0.63761642 | 28.98 | 27.27 | 6.27 | 0.61527414 | 15.78 | 15.38 | 2.55 |
| 0x0C | 650 | 0.65926581 | 16.90 | 16.67 | 1.43 | 0.69060046 | 31.39 | 29.55 | 6.25 | 0.66692751 | 17.10 | 16.67 | 2.60 |
| 0x0D | 700 | 0.70934843 | 18.19 | 17.95 | 1.34 | 0.74316386 | 33.78 | 31.82 | 6.17 | 0.71791896 | 18.41 | 17.95 | 2.56 |
| 0x0E | 750 | 0.76007223 | 19.49 | 19.23 | 1.34 | 0.79570772 | 36.17 | 34.09 | 6.09 | 0.76877243 | 19.71 | 19.23 | 2.50 |
| 0x0F | 800 | 0.81059966 | 20.78 | 20.51 | 1.32 | 0.84789002 | 38.54 | 36.36 | 5.99 | 0.81975618 | 21.02 | 20.51 | 2.47 |
| 0x10 | 850 | 0.86228285 | 22.11 | 21.79 | 1.45 | 0.88138006 | 40.06 | 38.64 | 3.69 | 0.87071806 | 22.33 | 21.79 | 2.44 |
| 0x11 | 900 | 0.91005099 | 23.33 | 23.08 | 1.12 | 0.90063212 | 40.94 | 40.91 | 0.07 | 0.92183687 | 23.64 | 23.08 | 2.43 |
| 0x12 | 950 | 0.93013376 | 23.85 | 24.36 | -2.09 | 0.92022659 | 41.83 | 43.18 | -3.13 | 0.97296767 | 24.95 | 24.36 | 2.42 |
| 0x13 | 1000 | 0.94551178 | 24.24 | 25.64 | -5.45 | 0.94770514 | 43.08 | 45.45 | -5.23 | 1.02425197 | 26.26 | 25.64 | 2.43 |
| 0x14 | 1050 | 0.9666595 | 24.79 | 26.92 | -7.94 | 0.99105021 | 45.05 | 47.73 | -5.61 | 1.07558602 | 27.58 | 26.92 | 2.44 |
| 0x15 | 1100 | 1.00054072 | 25.65 | 28.21 | -9.04 | 1.05860334 | 48.12 | 50.00 | -3.76 | 1.12305367 | 28.80 | 28.21 | 2.10 |
| 0x16 | 1150 | 1.05244688 | 26.99 | 29.49 | -8.48 | 1.15948375 | 52.70 | 52.27 | 0.82 | 1.17836679 | 30.21 | 29.49 | 2.47 |
| 0x17 | 1200 | 1.12710175 | 28.90 | 30.77 | -6.07 | 1.27185882 | 57.81 | 54.55 | 5.99 | 1.22905678 | 31.51 | 30.77 | 2.42 |

Table 12: Raw Data for 94uF Input / 94uF Output Capacitor

| 94μF | | Green | | | Red | | | Blue | | | | | |
|------|------|------------|-------|---------|-------|------------|---------|-------|-------|------------|-------|-------|------|
| | | Meas | Calc | % Error | Meas | Calc | % Error | Meas | Calc | % Error | | | |
| 0x00 | 50 | 0.05200697 | 1.33 | 1.28 | 4.01 | 0.05436706 | 2.47 | 2.27 | 8.73 | 0.05426098 | 1.39 | 1.28 | 8.52 |
| 0x01 | 100 | 0.10356678 | 2.66 | 2.56 | 3.57 | 0.10741029 | 4.88 | 4.55 | 7.41 | 0.10632832 | 2.73 | 2.56 | 6.33 |
| 0x02 | 150 | 0.1542082 | 3.95 | 3.85 | 2.81 | 0.16045634 | 7.29 | 6.82 | 6.97 | 0.15769801 | 4.04 | 3.85 | 5.13 |
| 0x03 | 200 | 0.20524837 | 5.26 | 5.13 | 2.62 | 0.21290037 | 9.68 | 9.09 | 6.45 | 0.20863386 | 5.35 | 5.13 | 4.32 |
| 0x04 | 250 | 0.25610078 | 6.57 | 6.41 | 2.44 | 0.26618547 | 12.10 | 11.36 | 6.47 | 0.25931849 | 6.65 | 6.41 | 3.73 |
| 0x05 | 300 | 0.30645528 | 7.86 | 7.69 | 2.15 | 0.31828622 | 14.47 | 13.64 | 6.10 | 0.3099029 | 7.95 | 7.69 | 3.30 |
| 0x06 | 350 | 0.3572653 | 9.16 | 8.97 | 2.08 | 0.36985684 | 16.81 | 15.91 | 5.67 | 0.36067985 | 9.25 | 8.97 | 3.05 |
| 0x07 | 400 | 0.40774651 | 10.46 | 10.26 | 1.94 | 0.42234751 | 19.20 | 18.18 | 5.59 | 0.41182698 | 10.56 | 10.26 | 2.96 |
| 0x08 | 450 | 0.45800112 | 11.74 | 11.54 | 1.78 | 0.47483759 | 21.58 | 20.45 | 5.52 | 0.46222067 | 11.85 | 11.54 | 2.72 |
| 0x09 | 500 | 0.50869042 | 13.04 | 12.82 | 1.74 | 0.52873399 | 24.03 | 22.73 | 5.75 | 0.51296907 | 13.15 | 12.82 | 2.59 |
| 0x0A | 550 | 0.55827629 | 14.31 | 14.10 | 1.50 | 0.58164023 | 26.44 | 25.00 | 5.75 | 0.56320472 | 14.44 | 14.10 | 2.40 |
| 0x0B | 600 | 0.60854326 | 15.60 | 15.38 | 1.42 | 0.63388916 | 28.81 | 27.27 | 5.65 | 0.61428574 | 15.75 | 15.38 | 2.38 |
| 0x0C | 650 | 0.65988213 | 16.92 | 16.67 | 1.52 | 0.68597037 | 31.18 | 29.55 | 5.53 | 0.66513881 | 17.05 | 16.67 | 2.33 |
| 0x0D | 700 | 0.71048667 | 18.22 | 17.95 | 1.50 | 0.73909677 | 33.60 | 31.82 | 5.59 | 0.7169713 | 18.38 | 17.95 | 2.42 |
| 0x0E | 750 | 0.76074182 | 19.51 | 19.23 | 1.43 | 0.79136279 | 35.97 | 34.09 | 5.52 | 0.76812468 | 19.70 | 19.23 | 2.42 |
| 0x0F | 800 | 0.8112982 | 20.80 | 20.51 | 1.41 | 0.84310076 | 38.32 | 36.36 | 5.39 | 0.81840901 | 20.98 | 20.51 | 2.30 |
| 0x10 | 850 | 0.86227747 | 22.11 | 21.79 | 1.44 | 0.89487317 | 40.68 | 38.64 | 5.28 | 0.86932097 | 22.29 | 21.79 | 2.27 |
| 0x11 | 900 | 0.91322673 | 23.42 | 23.08 | 1.47 | 0.92747895 | 42.16 | 40.91 | 3.05 | 0.91998515 | 23.59 | 23.08 | 2.22 |
| 0x12 | 950 | 0.94056779 | 24.12 | 24.36 | -0.99 | 0.95254878 | 43.30 | 43.18 | 0.27 | 0.97092654 | 24.90 | 24.36 | 2.20 |
| 0x13 | 1000 | 0.95720689 | 24.54 | 25.64 | -4.28 | 0.98313275 | 44.69 | 45.45 | -1.69 | 1.02202162 | 26.21 | 25.64 | 2.20 |
| 0x14 | 1050 | 0.97886934 | 25.10 | 26.92 | -6.77 | 1.02896735 | 46.77 | 47.73 | -2.00 | 1.07298488 | 27.51 | 26.92 | 2.19 |
| 0x15 | 1100 | 1.01336698 | 25.98 | 28.21 | -7.88 | 1.0986225 | 49.94 | 50.00 | -0.13 | 1.12462839 | 28.84 | 28.21 | 2.24 |
| 0x16 | 1150 | 1.06548863 | 27.32 | 29.49 | -7.35 | 1.19693633 | 54.41 | 52.27 | 4.08 | 1.17503361 | 30.13 | 29.49 | 2.18 |
| 0x17 | 1200 | 1.14029463 | 29.24 | 30.77 | -4.98 | 1.26581559 | 57.54 | 54.55 | 5.48 | 1.22561547 | 31.43 | 30.77 | 2.13 |

Document History

Document Title: Name – AN-1209

Document Number: 001-00000

| Revision | Orig. of Change | Submission Date | Description of Change |
|-----------------|------------------------|------------------------|------------------------------|
| A | Craig Cary | 10/10/2017 | New application note. |
| | | | |

IMPORTANT NOTICE AND DISCLAIMER

RENESAS ELECTRONICS CORPORATION AND ITS SUBSIDIARIES (“RENESAS”) PROVIDES TECHNICAL SPECIFICATIONS AND RELIABILITY DATA (INCLUDING DATASHEETS), DESIGN RESOURCES (INCLUDING REFERENCE DESIGNS), APPLICATION OR OTHER DESIGN ADVICE, WEB TOOLS, SAFETY INFORMATION, AND OTHER RESOURCES “AS IS” AND WITH ALL FAULTS, AND DISCLAIMS ALL WARRANTIES, EXPRESS OR IMPLIED, INCLUDING, WITHOUT LIMITATION, ANY IMPLIED WARRANTIES OF MERCHANTABILITY, FITNESS FOR A PARTICULAR PURPOSE, OR NON-INFRINGEMENT OF THIRD-PARTY INTELLECTUAL PROPERTY RIGHTS.

These resources are intended for developers who are designing with Renesas products. You are solely responsible for (1) selecting the appropriate products for your application, (2) designing, validating, and testing your application, and (3) ensuring your application meets applicable standards, and any other safety, security, or other requirements. These resources are subject to change without notice. Renesas grants you permission to use these resources only to develop an application that uses Renesas products. Other reproduction or use of these resources is strictly prohibited. No license is granted to any other Renesas intellectual property or to any third-party intellectual property. Renesas disclaims responsibility for, and you will fully indemnify Renesas and its representatives against, any claims, damages, costs, losses, or liabilities arising from your use of these resources. Renesas' products are provided only subject to Renesas' Terms and Conditions of Sale or other applicable terms agreed to in writing. No use of any Renesas resources expands or otherwise alters any applicable warranties or warranty disclaimers for these products.

(Disclaimer Rev.1.01)

Corporate Headquarters

TOYOSU FORESIA, 3-2-24 Toyosu,
Koto-ku, Tokyo 135-0061, Japan
www.renesas.com

Trademarks

Renesas and the Renesas logo are trademarks of Renesas Electronics Corporation. All trademarks and registered trademarks are the property of their respective owners.

Contact Information

For further information on a product, technology, the most up-to-date version of a document, or your nearest sales office, please visit www.renesas.com/contact-us/.