

ISL35411DRZ-EVALZ

ISL35411 Evaluation Board

AN1572
Rev 1.00
June 22, 2016

Description

The ISL35411DRZ-EVALZ evaluation board is a versatile stand-alone printed circuit board developed to evaluate the performance of the Intersil [ISL35411](#) 11.1Gb/s driver.

Items provided with board:

- This application note
- Power cable
- Ten jumpers

Key Features

- ISL35411 IC
- Connection to external 3.3V power supply
- On-board voltage regulator that provides the 1.2V supply to the IC
- On-board de-emphasis level adjustment using provided jumpers
- SMA connectors to access differential inputs and outputs

References

- [ISL35411](#) Datasheet

Ordering Information

PART NUMBER	DESCRIPTION
ISL35411DRZ-EVALZ	ISL35411 evaluation board (power cable and four jumpers included)

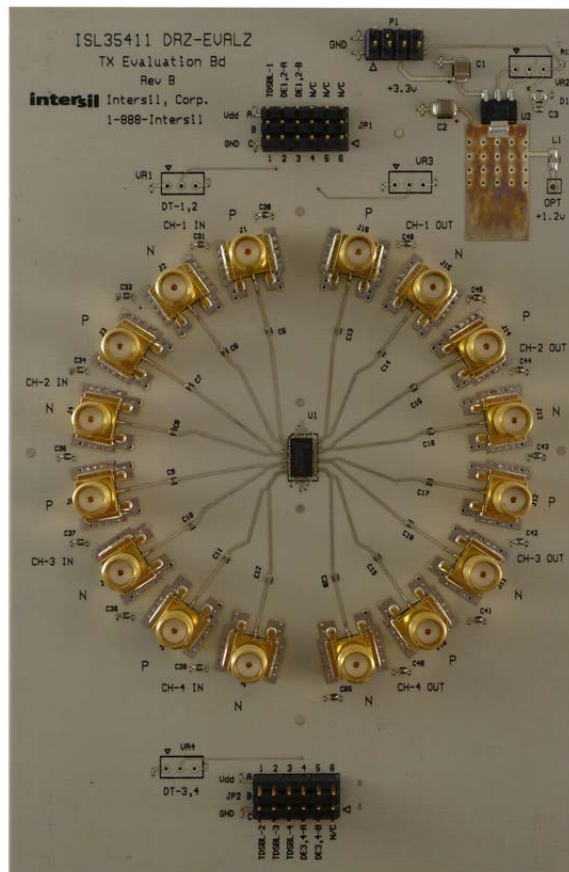

FIGURE 1. TOP OF BOARD

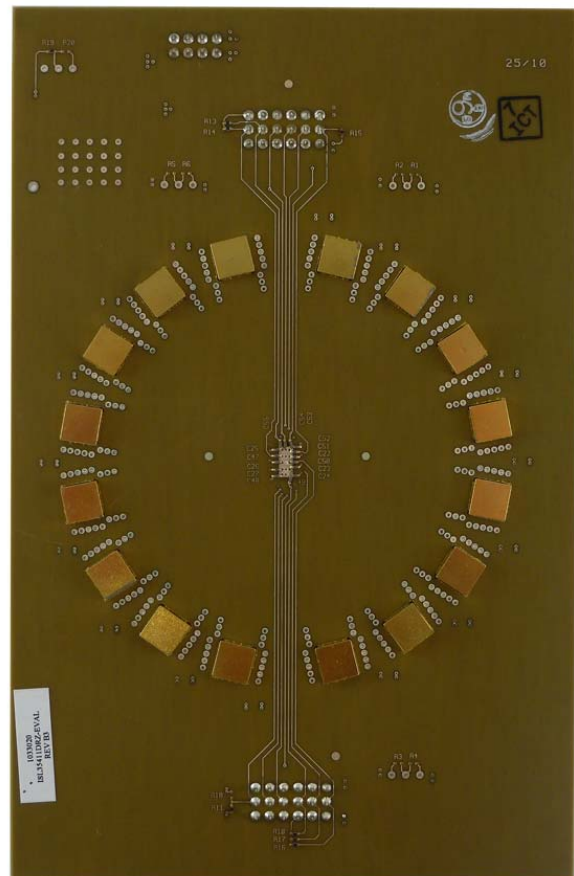

FIGURE 2. BOTTOM OF BOARD

Operation of the ISL35411DRZ-EVALZ Evaluation Board

This section describes how to setup your ISL35411DRZ-EVALZ evaluation board: making sure proper power is applied, connecting to the high-speed RF inputs and outputs and adjusting the output de-emphasis level for each channel. The board is shown in [Figure 3](#).

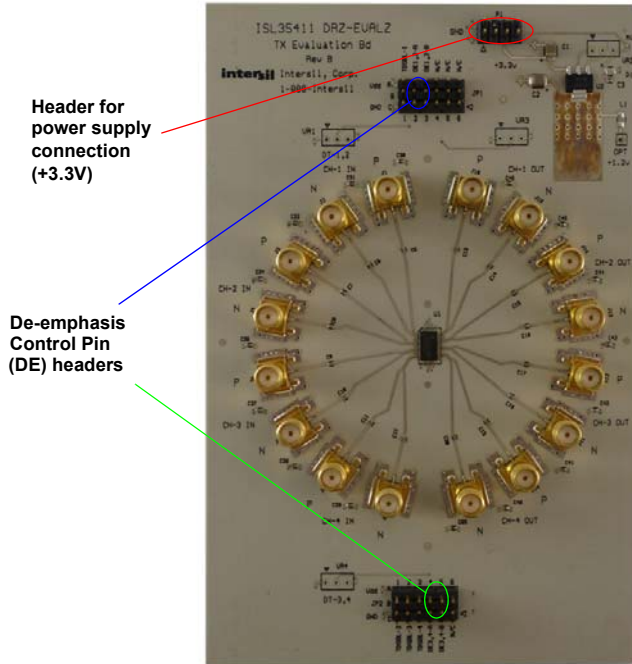

FIGURE 3. ISL35411DRZ-EVALZ EVALUATION BOARD

Power Supply

The board needs to be powered by an external +3.3V power supply via the power header located at the top of the board using the power cable provided. The red lead of the power cable should be connected to the +3.3V output of the external power supply while the black lead should be connected to the ground (-) terminal.

Typical current consumption of the board when the output de-emphasis level is set to 0dB (see [Table 1](#)) is 200mA when no input signals are applied; and 220mA when a signal is applied to any one of the four high-speed inputs. Total board current will be approximately 280mA if all four channels are active simultaneously with the output de-emphasis levels set to 0dB.

High-Speed Data I/O Interface Connectors

The ISL35411 Driver is intended to be used at the transmit end of lossy differential copper channels. The four channels of the ISL35411 make it well-suited for high-density applications with parallel channels. The ISL35411 is optimized for use in conjunction with the Intersil ISL36411 quad lane extender at the far end of the lossy channel.

The differential input(s) of the ISL35411 should be connected to a high-speed data stream source, such as a pattern generator. This connection should be made using the input SMA connectors labeled on the board. We recommend using phase (time-delay)-matched cables for each differential input to preserve the fidelity of the differential signal. The output SMA connectors provide access to the output differential signal(s) of the ISL35411 and can be connected with phase-matched cables to the channel to be driven. Make sure proper torque (5 in-lbs) is applied to the SMA connectors for reliable measurements and to prevent damage to the connectors.

The ISL35411DRZ-EVALZ evaluation board is designed to minimize parasitic board effects for transparent evaluation of the ISL35411's high-speed performance. Due to the extremely low-loss nature of the evaluation board's high-speed traces, all unused channels on the board should be terminated at the input and output SMA connections with 50Ω loads to minimize reflections, which can corrupt the performance of neighboring channels.

Output De-Emphasis Setting Control

The output driver of each channel on the ISL35411 is capable of providing seven different levels (0 to 6) of adjustable output de-emphasis. The available output de-emphasis levels range from 0dB (DE level = 0) to 4dB (DE level = 6). The de-emphasis levels of Channels 1 and 2 are controlled simultaneously by the de-emphasis control pin headers (DE) located at JP1 on the north-side of the board and highlighted in blue in [Figure 3](#). The de-emphasis levels of Channels 3 and 4 are controlled simultaneously by the de-emphasis control pin headers (DE) located at JP2 on the south-side of the board and highlighted in green in [Figure 3](#). Output de-emphasis levels are set by positioning jumpers on the appropriate header as illustrated in [Figure 4](#). For both sets of headers, DE-A and DE-B can each be set to one of three values (VDD, GND, or Floating). [Table 1](#) gives the jumper positions required to achieve various de-emphasis levels. As an example, [Figure 4](#) depicts the jumper positions that set the output de-emphasis level to 3dB (DE-A = GND and DE-B = VDD).

TABLE 1. JUMPER POSITIONS FOR OUTPUT DE-EMPHASIS SETTINGS

DE-A	DE-B	DE LEVEL	DE LEVEL (dB)
No jumper	No jumper	0	0
No jumper	Jumper to GND	1	0.6
No jumper	Jumper to VDD	2	1.1
Jumper to GND	No jumper	3	1.6
Jumper to GND	Jumper to GND	4	2.3
Jumper to GND	Jumper to VDD	5	3.0
Jumper to VDD	No jumper	6	4.0

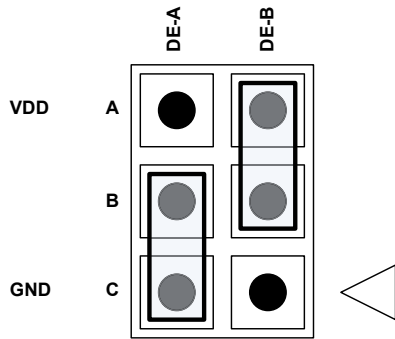

FIGURE 4. JUMPER CONFIGURATION FOR 3dB OUTPUT DE-EMPHASIS

Transmit Disable

The ISL35411 provides an independent transmit disable feature for each of its channels. With this feature, idle and/or unused channels on the ISL35411 can be made to enter a low power standby mode. Entry into this mode is controlled by each channel's respective TDSBL pin. The TDSBL-1 pin (for Channel 1) is located at header JP1 on the north-side of the board. The TDSBL pins for the remaining channels are located at header JP2 on the south-side of the board. By using a jumper to tie a given TDSBL pin to VDD (as shown in Figure 5), the corresponding channel on the ISL35411 is disabled. While disabled, all internal circuitry associated with the channel is powered down, and the channel is incapable of driving any high-speed signal applied to its input. If the TDSBL pin is left floating (no jumper installed), the respective channel is enabled and is capable of driving high-speed data.

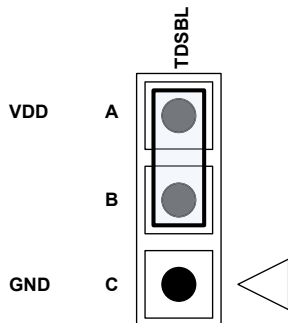

FIGURE 5. JUMPER INSTALLED FOR TRANSMIT DISABLE

Baseline Performance

The eye diagrams in Figure 6 show the typical high-speed performance of the ISL35411DRZ-EVALZ evaluation board. Figure 6A shows the output of a single channel at 10.3125Gb/s with no output de-emphasis (DE level = 0dB). Figure 6B shows the output of a single channel at 10.3125Gb/s with maximum output de-emphasis (DE level = 4dB). The output de-emphasis supplied by the ISL35411 can be used to precompensate the signal for subsequent frequency-dependent channel loss. Figure 6C shows the eye diagram of a waveform that has been transmitted from the output of the ISL35411 with maximum de-emphasis (DE level = 4dB) across a 22-inch long trace on an FR408 circuit board. The trace loss at 5GHz is approximately -8dB. The open eye diagram in Figure 6C illustrates the channel equalization capabilities of the ISL35411's output de-emphasis feature.

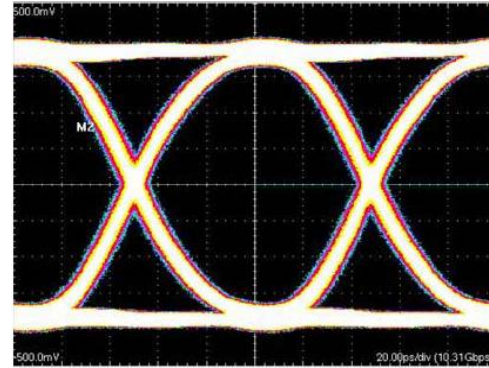

FIGURE 6A. 10.3125Gb/s EYE DIAGRAM AT ISL35411DRZ-EVALZ EVALUATION BOARD OUTPUT (OUTPUT LEVEL = 0dB)

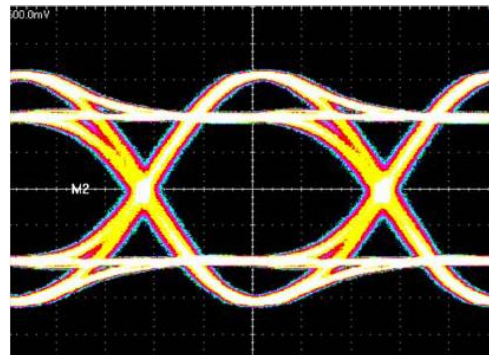

FIGURE 6B. 10.3125Gb/s EYE DIAGRAM AT ISL35411DRZ-EVALZ EVALUATION BOARD OUTPUT (OUTPUT LEVEL = 4dB)

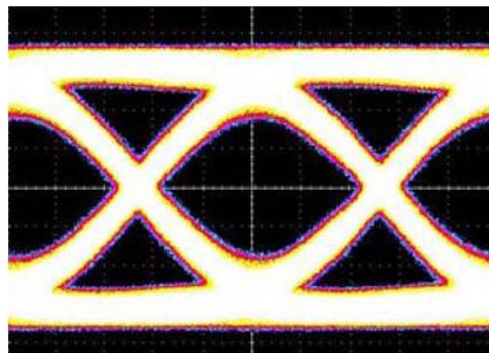

FIGURE 6C. 10.3125Gb/s EYE DIAGRAM AFTER TRANSMISSION FROM ISL35411 ACROSS 22-in. FR408 TRACE (OUTPUT DE-LEVEL = 4dB)

FIGURE 6. 10.3125Gb/s EYE DIAGRAM AFTER TRANSMISSION FROM ISL35411 ACROSS 22-in. FR408 TRACE (OUTPUT DE-LEVEL = 4dB)

ISL35411DRZ-EVALZ Evaluation Board Schematic

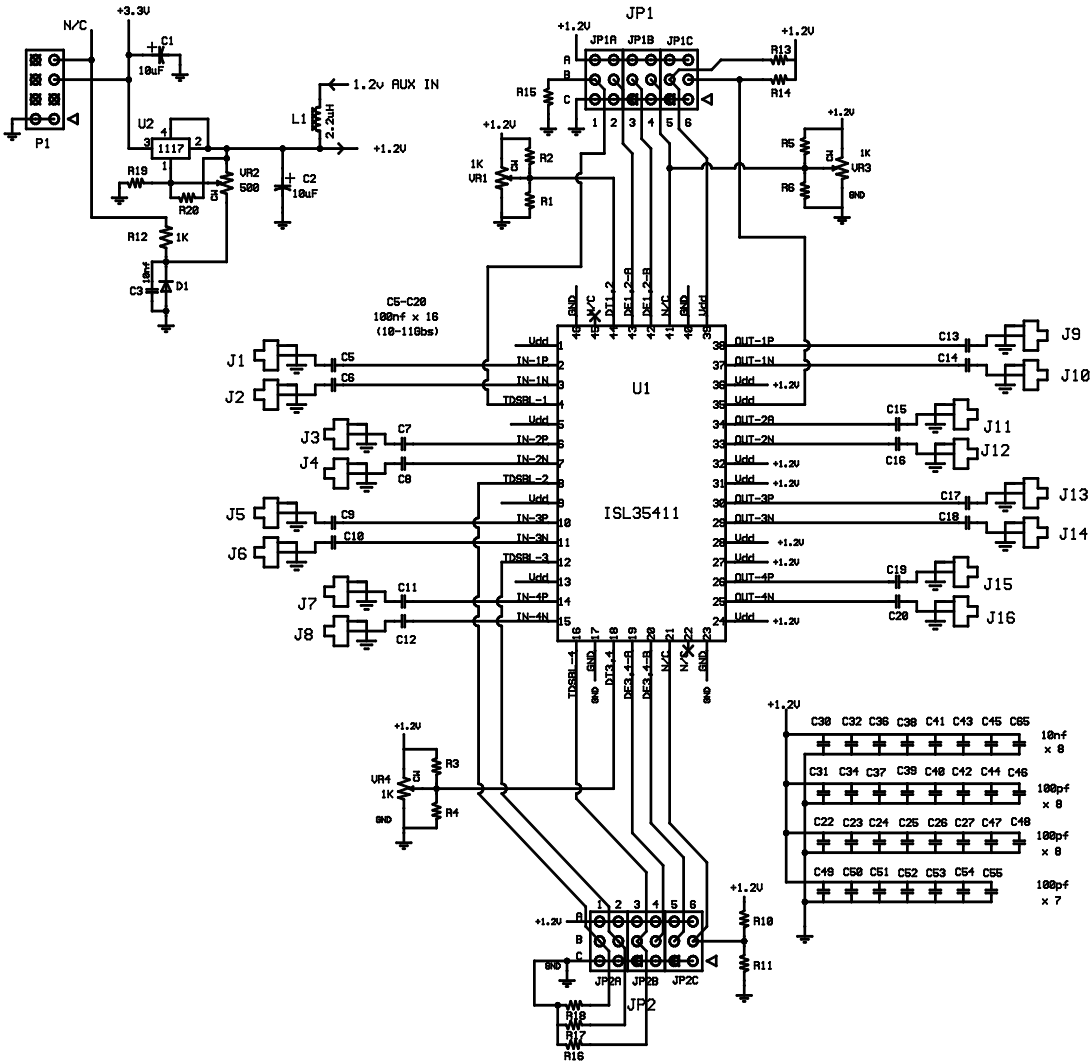

FIGURE 7. ISL35411DRZ-EVALZ SCHEMATIC

Notice

1. Descriptions of circuits, software and other related information in this document are provided only to illustrate the operation of semiconductor products and application examples. You are fully responsible for the incorporation or any other use of the circuits, software, and information in the design of your product or system. Renesas Electronics disclaims any and all liability for any losses and damages incurred by you or third parties arising from the use of these circuits, software, or information.
2. Renesas Electronics hereby expressly disclaims any warranties against and liability for infringement or any other claims involving patents, copyrights, or other intellectual property rights of third parties, by or arising from the use of Renesas Electronics products or technical information described in this document, including but not limited to, the product data, drawings, charts, programs, algorithms, and application examples.
3. No license, express, implied or otherwise, is granted hereby under any patents, copyrights or other intellectual property rights of Renesas Electronics or others.
4. You shall not alter, modify, copy, or reverse engineer any Renesas Electronics product, whether in whole or in part. Renesas Electronics disclaims any and all liability for any losses or damages incurred by you or third parties arising from such alteration, modification, copying or reverse engineering.
5. Renesas Electronics products are classified according to the following two quality grades: "Standard" and "High Quality". The intended applications for each Renesas Electronics product depends on the product's quality grade, as indicated below.
"Standard": Computers; office equipment; communications equipment; test and measurement equipment; audio and visual equipment; home electronic appliances; machine tools; personal electronic equipment; industrial robots; etc.
"High Quality": Transportation equipment (automobiles, trains, ships, etc.); traffic control (traffic lights); large-scale communication equipment; key financial terminal systems; safety control equipment; etc.
Unless expressly designated as a high reliability product or a product for harsh environments in a Renesas Electronics data sheet or other Renesas Electronics document, Renesas Electronics products are not intended or authorized for use in products or systems that may pose a direct threat to human life or bodily injury (artificial life support devices or systems; surgical implantations; etc.), or may cause serious property damage (space system; undersea repeaters; nuclear power control systems; aircraft control systems; key plant systems; military equipment; etc.). Renesas Electronics disclaims any and all liability for any damages or losses incurred by you or any third parties arising from the use of any Renesas Electronics product that is inconsistent with any Renesas Electronics data sheet, user's manual or other Renesas Electronics document.
6. When using Renesas Electronics products, refer to the latest product information (data sheets, user's manuals, application notes, "General Notes for Handling and Using Semiconductor Devices" in the reliability handbook, etc.), and ensure that usage conditions are within the ranges specified by Renesas Electronics with respect to maximum ratings, operating power supply voltage range, heat dissipation characteristics, installation, etc. Renesas Electronics disclaims any and all liability for any malfunctions, failure or accident arising out of the use of Renesas Electronics products outside of such specified ranges.
7. Although Renesas Electronics endeavors to improve the quality and reliability of Renesas Electronics products, semiconductor products have specific characteristics, such as the occurrence of failure at a certain rate and malfunctions under certain use conditions. Unless designated as a high reliability product or a product for harsh environments in a Renesas Electronics data sheet or other Renesas Electronics document, Renesas Electronics products are not subject to radiation resistance design. You are responsible for implementing safety measures to guard against the possibility of bodily injury, injury or damage caused by fire, and/or danger to the public in the event of a failure or malfunction of Renesas Electronics products, such as safety design for hardware and software, including but not limited to redundancy, fire control and malfunction prevention, appropriate treatment for aging degradation or any other appropriate measures. Because the evaluation of microcomputer software alone is very difficult and impractical, you are responsible for evaluating the safety of the final products or systems manufactured by you.
8. Please contact a Renesas Electronics sales office for details as to environmental matters such as the environmental compatibility of each Renesas Electronics product. You are responsible for carefully and sufficiently investigating applicable laws and regulations that regulate the inclusion or use of controlled substances, including without limitation, the EU RoHS Directive, and using Renesas Electronics products in compliance with all these applicable laws and regulations. Renesas Electronics disclaims any and all liability for damages or losses occurring as a result of your noncompliance with applicable laws and regulations.
9. Renesas Electronics products and technologies shall not be used for or incorporated into any products or systems whose manufacture, use, or sale is prohibited under any applicable domestic or foreign laws or regulations. You shall comply with any applicable export control laws and regulations promulgated and administered by the governments of any countries asserting jurisdiction over the parties or transactions.
10. It is the responsibility of the buyer or distributor of Renesas Electronics products, or any other party who distributes, disposes of, or otherwise sells or transfers the product to a third party, to notify such third party in advance of the contents and conditions set forth in this document.
11. This document shall not be reprinted, reproduced or duplicated in any form, in whole or in part, without prior written consent of Renesas Electronics.
12. Please contact a Renesas Electronics sales office if you have any questions regarding the information contained in this document or Renesas Electronics products.
(Note 1) "Renesas Electronics" as used in this document means Renesas Electronics Corporation and also includes its directly or indirectly controlled subsidiaries.
(Note 2) "Renesas Electronics product(s)" means any product developed or manufactured by or for Renesas Electronics.

(Rev.4.0-1 November 2017)



SALES OFFICES

Renesas Electronics Corporation

<http://www.renesas.com>

Refer to "<http://www.renesas.com/>" for the latest and detailed information.

Renesas Electronics America Inc.
1001 Murphy Ranch Road, Milpitas, CA 95035, U.S.A.
Tel: +1-408-432-8888, Fax: +1-408-434-5351

Renesas Electronics Canada Limited
9251 Yonge Street, Suite 8309 Richmond Hill, Ontario Canada L4C 9T3
Tel: +1-905-237-2004

Renesas Electronics Europe Limited
Dukes Meadow, Millboard Road, Bourne End, Buckinghamshire, SL8 5FH, U.K
Tel: +44-1628-651-700, Fax: +44-1628-651-804

Renesas Electronics Europe GmbH
Arcadiastrasse 10, 40472 Düsseldorf, Germany
Tel: +49-211-6503-0, Fax: +49-211-6503-1327

Renesas Electronics (China) Co., Ltd.
Room 1709 Quantum Plaza, No.27 ZhichunLu, Haidian District, Beijing, 100191 P. R. China
Tel: +86-10-8235-1155, Fax: +86-10-8235-7679

Renesas Electronics (Shanghai) Co., Ltd.
Unit 301, Tower A, Central Towers, 555 Langao Road, Putuo District, Shanghai, 200333 P. R. China
Tel: +86-21-2226-0888, Fax: +86-21-2226-0999

Renesas Electronics Hong Kong Limited
Unit 1601-1611, 16/F., Tower 2, Grand Century Place, 193 Prince Edward Road West, Mongkok, Kowloon, Hong Kong
Tel: +852-2265-6688, Fax: +852-2886-9022

Renesas Electronics Taiwan Co., Ltd.
13F, No. 363, Fu Shing North Road, Taipei 10543, Taiwan
Tel: +886-2-8175-9600, Fax: +886-2-8175-9670

Renesas Electronics Singapore Pte. Ltd.
80 Bendemeer Road, Unit #06-02 Hyflux Innovation Centre, Singapore 339949
Tel: +65-6213-0200, Fax: +65-6213-0300

Renesas Electronics Malaysia Sdn.Bhd.
Unit 1207, Block B, Menara Amcorp, Amcorp Trade Centre, No. 18, Jln Persiaran Barat, 46050 Petaling Jaya, Selangor Darul Ehsan, Malaysia
Tel: +60-3-7955-9390, Fax: +60-3-7955-9510

Renesas Electronics India Pvt. Ltd.
No.777C, 100 Feet Road, HAL 2nd Stage, Indiranagar, Bangalore 560 038, India
Tel: +91-80-67208700, Fax: +91-80-67208777

Renesas Electronics Korea Co., Ltd.
17F, KAMCO Yangjae Tower, 262, Gangnam-daero, Gangnam-gu, Seoul, 06265 Korea
Tel: +82-2-558-3737, Fax: +82-2-558-5338