

ISL71610M

Radiation Tolerant Passive-Input Digital Isolator

Description

The **ISL71610M** is a passive-input digital signal isolator with a CMOS output. It has a similar interface but with better performance and higher package density than optocouplers.

The ISL71610M is manufactured with Giant Magnetoresistive (GMR) technology for small size, high speed, and low power. A ceramic/polymer composite barrier provides excellent isolation and an unlimited barrier life. A series external resistor sets the input coil current and a capacitor in parallel with the current-limiting resistor provides improved dynamic performance. This versatile component can be used to replace a variety of optocouplers, functioning over a wide range of data rates, edge speeds, and power supply levels. The device output is compatible with 3.3V and 5V supplies, allowing an interface to controllers without additional level shifting. With the coil energized with a minimum of $\pm 8\text{mA}$ (bidirectional current) the ISL71610M is suitable for single ended and differential drive applications.

The ISL71610M is offered in an 8 Ld 5mmx4mm SOIC package and is fully specified across the military ambient temperature range of -55°C to $+125^{\circ}\text{C}$.

Applications

- Isolated power
- CAN bus/device net
- Differential line receiver
- Optocoupler replacement
- SPI interface
- RS-485, RS-422, or RS-232

Features

- Qualified to Renesas Rad Tolerant Screening and QCI Flow ([R34TB0004EU](#))
- Barrier Voltage Endurance
 - 2.5kVRMS, for 1 minute, 600Vrms continuous (VDE V 0884-10 certified: file 5022321-4880-0001),
 - 1.5kV_{DC} continuous
 - 500V_{DC} at 43MeV•cm²/mg SEDR
- UL 1577 recognized: file reference E483309
- Up to 100 Mbps data rate
- Flexible inputs with very wide input voltage range (resistor limited current through coil)
- Bipolar current input failsafe output
- No carrier or clock for low EMI emissions and susceptibility
- 3V to 5.5V signaling operation
- Passes NASA low outgassing specifications
- NiPdAu-Ag leadframes (Pb-free, Sn-free)
- Full military temperature range operation
 - T_A = -55°C to $+125^{\circ}\text{C}$
 - T_J = -55°C to $+150^{\circ}\text{C}$
- TID Radiation Lot Acceptance Testing (RLAT) (LDR: $<0.01\text{rad}(\text{Si})/\text{s}$)
 - ISL71610M30BZ: 30krad(Si)
 - ISL71610M50BZ: 50krad(Si)
- SEE Characterization
 - No DSEE for V_{DD} = 7V at 43MeV•cm²/mg

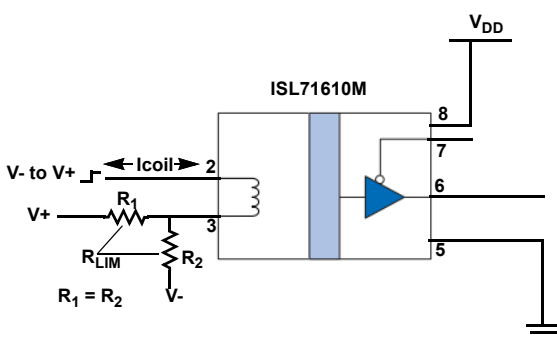

Figure 1. Single-Ended Configuration

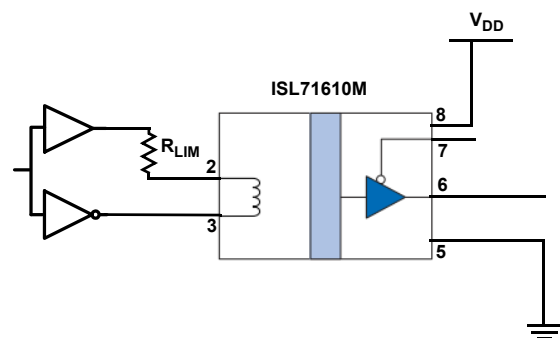

Figure 2. Differential Configuration

Contents

1. Overview	3
1.1 Functional Block Diagram	3
2. Pin Information	4
2.1 Pin Assignments	4
2.2 Pin Descriptions	4
3. Specifications	5
3.1 Absolute Maximum Ratings	5
3.2 Recommended Operating Conditions	5
3.3 Thermal Information	5
3.4 Outgas Testing	5
3.5 Insulation Specifications	6
3.6 Safety and Approvals	6
3.7 Electrical Specifications	6
4. Typical Performance Curves	9
5. Device Information	13
5.1 Coil Polarity	13
5.2 Input Resistor Selection	13
5.3 Single-Ended or Differential Input	13
5.4 Non-Inverting and Inverting Configurations	13
5.5 Boost Capacitor	13
5.6 Dynamic Power Consumption	14
5.7 Power Supply Decoupling	14
5.8 Maintaining Creepage	14
5.9 Electromagnetic Compatibility and Magnetic Field Immunity	14
5.9.1 Orientation of the Device with Respect to the Field Direction	14
5.9.2 Differential Signaling and Boost Capacitors	14
5.10 Data Rate and Magnetic Field Immunity	14
6. Radiation Tolerance	14
6.1 Total Ionizing Dose (TID) Testing	15
6.1.1 Results	15
6.1.2 Conclusion	17
6.2 Single Event Effects Testing	18
6.2.1 SEE Test Facility	18
6.2.2 Scope of the ISL71610M SEE Testing	18
6.2.3 Testing Set Up	18
6.2.4 Isolation Barrier SEDR Testing	18
6.2.5 DSEE (SEB and SEL) Testing	18
6.2.6 SET Testing	18
6.2.7 Summary	23
7. Package Outline Drawing	24
8. Ordering Information	25
9. Revision History	25

1. Overview

1.1 Functional Block Diagram

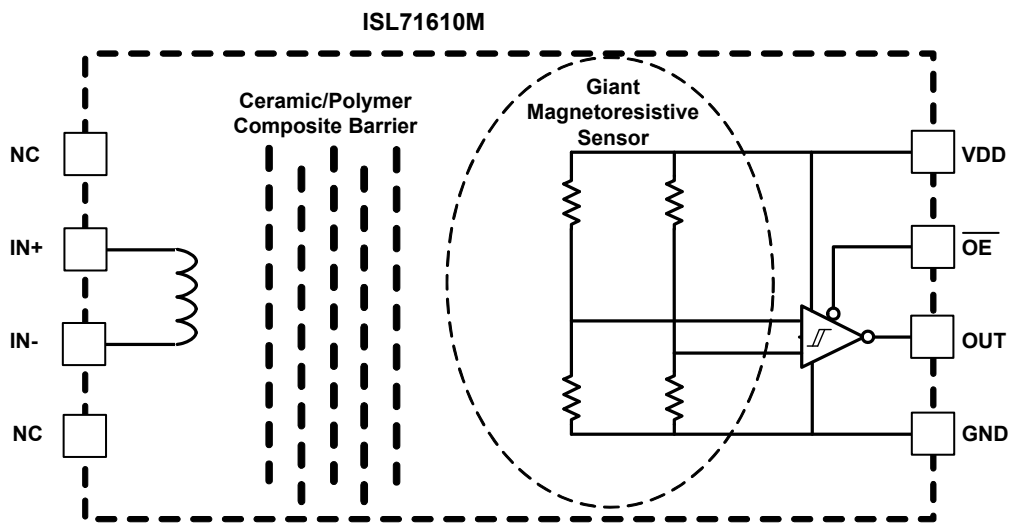

Ground the NC pins to prevent ion charge build-up on floating metal

Figure 3. Block Diagram

2. Pin Information

2.1 Pin Assignments

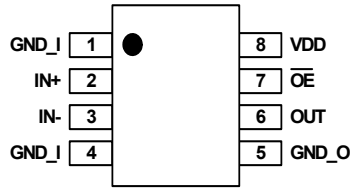
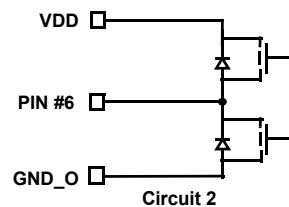
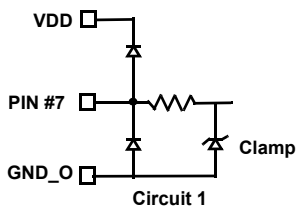

Figure 4. Pin Assignments - Top View

2.2 Pin Descriptions

Pin Number	Pin Name	ESD Circuit	Description
1, 4	GND_I	N/A	No internal connection. Use for input shielding, connect to input side ground
2	IN+	N/A	Coil connection. The voltage applied to IN+ is more negative than IN- to cause the voltage of OUT to switch to V_{OL} (logic low).
3	IN-	N/A	Coil connection. The voltage applied to IN- is more positive than IN+ to cause the voltage of OUT to switch to V_{OL} (logic low).
5	GND_O	N/A	Ground return for VDD
6	OUT	2	Data output. The OUT pin logic high is the zero input current state.
7	OE	1	Output enable, active low. Internally pulled low with 100k Ω to enable the output when this pin is not connected.
8	VDD	N/A	Receiver supply voltage



3. Specifications

3.1 Absolute Maximum Ratings

Caution: Do not operate at or near the maximum ratings listed for extended periods of time. Exposure to such conditions can adversely impact product reliability and result in failures not covered by warranty.

Parameter	Minimum	Maximum	Unit
VDD	GND - 0.3	GND + 7	V
IN+, IN-	-25	25	mA
OUT, \overline{OE}	GND - 0.3	V _{DD} + 1.5	V
OUT, \overline{OE}	-10	10	mA
Voltage Difference Across the Package (Pins 1, 2, 3, 4 to Pins 5, 6, 7, 8)	-	500	V
Power Dissipation	-	675	mW
Junction Temperature	-55	+150	°C
Storage Temperature	-65	+150	°C
Human Body Model (Tested per AEC-Q100-002)	-	1.2	kV
Charged Device Model (Tested per AEC-Q100-011)	-	1.5	kV
Latch-up (Tested per JESD-78E; Class 2, Level A) at +125°C	-	100	mA

3.2 Recommended Operating Conditions

Parameter	Minimum	Maximum	Unit
Ambient Temperature	-55	+125	°C
VDD	3	5.5	V
OUT, \overline{OE}	0	V _{DD}	V
OUT	-4	4	mA
Maximum Coil Current	-20	20	mA
Minimum Coil Current to Ensure Correct Output	-8	8	mA

3.3 Thermal Information

Parameter	Package	Symbol	Conditions	Typical Value	Unit
Thermal Resistance	NSOIC Package M8.15G	θ_{JA} ^[1]	Junction to ambient	60	°C/W
		θ_{JC}	Junction to case top	73	°C/W
		θ_{JC}	Junction to case bottom	40	°C/W
		Ψ_{JT} ^[2]	Junction to top	10	°C/W

1. θ_{JA} is measured with the component soldered to double-sided board; free air.

2. For Ψ_{JT} characterization parameter, the package top temperature is measured at the top center of the mounted package. See [TB379](#).

3.4 Outgas Testing

Specification (Tested per ASTM E595, 1.5)	Value	Unit
Total Mass Lost ^[1]	0.06	%
Collected Volatile Condensable Material ^[1]	<0.01	%
Water Vapor Recovered	0.03	%

1. Outgassing results meet NASA requirements of total mass loss <1% and collected volatile condensable material of <0.1%.

3.5 Insulation Specifications

Parameter	Symbol	Test Conditions	Min	Typ	Max	Unit
Creepage Distance (external)	-	IPC-2221B	2.54	-	-	mm
Total Barrier Thickness (internal)	-	-	12	13	-	μm
Leakage Current	-	240V _{RMS} , 60Hz	-	200	-	nA
Barrier Resistance	R _{IO}	500V _{DC}	-	>100	-	TΩ
Barrier Capacitance	C _{IO}	1MHz	-	7	-	pF
Comparative Tracking Index	CTI	Per IEC:60112	>175	-	-	V
AC High Voltage Endurance (Maximum Barrier Voltage for Indefinite Life)	V _{IOAC}	+125°C ambient	600	-	-	V _{RMS}
DC High Voltage Endurance (Maximum Barrier Voltage for Indefinite Life)	V _{IODC}	+125°C ambient	1500	-	-	V
Barrier Life	-	100°C, 1000 VRMS, 60% Confidence Level activation energy	-	44000	-	Years

3.6 Safety and Approvals

VDE V 0884-10 (VDE V 0884-11 pending) (Basic Isolation; VDE File Number 5022321-4880-0001)

- Working voltage (V_{IOORM}): 600V_{RMS} (848V_{PK}); basic insulation; pollution degree 2
- Isolation voltage (V_{ISO}): 2500V_{RMS}
- Transient overvoltage (V_{IO TM}): 4000V_{PK}
- Surge rating: 4000V
- Each part tested at 1590V_{PK} for 1s, 5pC partial discharge limit
- Samples tested at 4000V_{PK} for 60s; then 1358V_{PK} for 10s with 5pC partial discharge limit

Safety-Limiting Values	Symbol	Value	Unit
Safety Rating Ambient Temperature	T _S	+180	°C
Safety Rating Power	P _S	270	mW
Supply Current Safety Rating (Total of Supplies)	I _S	54	mA

UL 1577 (Component Recognition Program File Number E483309)

- Each part tested at 3000V_{RMS} (4240V_{PK}) for 1s; each lot sample tested at 2500V_{RMS} (3530V_{PK}) for 1min

3.7 Electrical Specifications

Unless otherwise noted, V_{DD} = 3V - 5.5V; OUT and \overline{OE} are open, VDD is bypassed to GND with a 47nF X7R capacitor; T_A = T_J = +25°C. Limits apply across the operating temperature range, -55°C to +125°C, unless otherwise stated.

Parameter	Symbol	Test Conditions	Min ^[1]	Typ	Max ^[1]	Unit
Input Specifications						
Coil Input Resistance	R _{COIL}	T = 25°C	47	85	112	Ω
Coil Input Resistance	R _{COIL}	T = -55°C	31	60	-	Ω
Coil Input Resistance ^[2]	R _{COIL}	T = 125°C	-	115	138	Ω
Coil Resistance Temperature Coefficient	TC R _{COIL}	-	-	0.2	0.25	Ω/K
Coil Inductance	L _{COIL}	-	-	9	-	nH
DC High Input Threshold (5V)	I _{INH-DC}	Single-ended circuit, V _{DD} = 4.5V - 5.5V	0.5	1	-	mA
DC Low Input Threshold (5V)	I _{INL-DC}	Single-ended circuit, V _{DD} = 4.5V - 5.5V	-	3.5	8	mA
Differential High Input Threshold	I _{INH-DIFF}	Differential circuit, V _{DD} = 3V - 5.5V, C _{BOOST} = 0pF, symmetric reversing input	0.5	1	-	mA

ISL71610M Datasheet

Unless otherwise noted, $V_{DD} = 3V - 5.5V$; OUT and \overline{OE} are open, VDD is bypassed to GND with a 47nF X7R capacitor; $T_A = T_J = +25^\circ C$. Limits apply across the operating temperature range, $-55^\circ C$ to $+125^\circ C$, unless otherwise stated. (Cont.)

Parameter	Symbol	Test Conditions	Min ^[1]	Typ	Max ^[1]	Unit
Differential Low Input Threshold	$I_{INL-DIFF}$	Differential circuit, $V_{DD} = 3V - 5.5V$, $C_{BOOST} = 0pF$, symmetric reversing input	-	3.5	8	mA
Failsafe High Input Current (5V)	$I_{FS-HIGH}$	Single-ended circuit, $V_{DD} = 4.5V - 5.5V$	-25	-	0.5	mA
Failsafe Low Input Current (5V)	I_{FS-LOW}	Single-ended circuit, $V_{DD} = 4.5V - 5.5V$	5	-	25	mA
Input Signal Rise and Fall Times	t_{IR}, t_{IF}	-	-	-	1	μs
Common-Mode Transient Immunity	$ CM_H , CM_L $	$V_{TRANSIENT} = 300V_{PEAK}$	15	20	-	kV/ μs
5V Electrical Specifications ($V_{DD} = 4.5V - 5.5V$; $T = -55^\circ C$ to $+125^\circ C$ unless otherwise stated)						
5V Quiescent Supply Current ^[2]	I_{DDQ}	IN+ = IN- = open	-	2	3	mA
Logic High Output Voltage	V_{OH}	$V_{DD} = 5V$, OUT = 20 μA	4.9	5	-	V
		$V_{DD} = 5V$, OUT = 4mA	4.0	4.8	-	V
Logic High Output Drive Current ^[2]	I_{OH}	$V_{OUT} = 4V$	-	-10	-7	mA
Logic Low Output Voltage	V_{OL}	$V_{DD} = 5V$, OUT = -20 μA	-	0	0.1	V
		$V_{DD} = 5V$, OUT = -4mA	-	0.2	0.8	V
Logic Low Output Drive Current ^[2]	I_{OL}	$V_{OUT} = 0.8V$	7	10	-	mA
Output Disable	V_{OE}	$V_{DD} = 5V$	-	2.5	-	V
5 V Switching Specifications ($V_{DD} = 4.5V - 5.5V$; $T = -55^\circ C$ to $+125^\circ C$ unless otherwise stated)						
Data Rate	-	Single-ended circuit, $t_{IR} = t_{IF} = 3ns$, $C_{BOOST} = 16pF$, $R_{OUT} = 1k\Omega$, $C_{OUT} = 16pF$	-	-	100	Mbps
Minimum Pulse-Width	PW	Single-ended circuit, $t_{IR} = t_{IF} = 3ns$, $C_{BOOST} = 16pF$, $R_{OUT} = 1k\Omega$, $C_{OUT} = 16pF$	10	-	-	ns
Propagation Delay Input to Output (High-to-Low) ^[2]	t_{PHL}	Single-ended circuit, $t_{IR} = t_{IF} = 3ns$, $C_{BOOST} = 16pF$, $R_{OUT} = 1k\Omega$, $C_{OUT} = 16pF$	-	8	15	ns
Propagation Delay Input to Output (Low-to-High) ^[2]	t_{PLH}	Single-ended circuit, $t_{IR} = t_{IF} = 3ns$, $C_{BOOST} = 16pF$, $R_{OUT} = 1k\Omega$, $C_{OUT} = 16pF$	-	8	15	ns
Average Propagation Delay Drift	t_{PDD}	Single-ended circuit, $t_{IR} = t_{IF} = 3ns$, $C_{BOOST} = 16pF$, $R_{OUT} = 1k\Omega$, $C_{OUT} = 16pF$	-	10	-	ps/ $^\circ C$
Pulse Width Distortion $ t_{PHL} - t_{PLH} $ ^[2]	PWD	Single-ended circuit, $t_{IR} = t_{IF} = 3ns$, $C_{BOOST} = 16pF$, $R_{OUT} = 1k\Omega$, $C_{OUT} = 16pF$	-	3	6	ns
Pulse Jitter	t_J	Single-ended circuit, $t_{IR} = t_{IF} = 3ns$, $C_{BOOST} = 16pF$, $R_{OUT} = 1k\Omega$, $C_{OUT} = 16pF$	-	100	-	ps
Propagation Delay Skew	t_{PSK}	Single-ended circuit, $t_{IR} = t_{IF} = 3ns$, $C_{BOOST} = 16pF$, $R_{OUT} = 1k\Omega$, $C_{OUT} = 16pF$	-2	-	2	ns
Propagation Delay Enable to Output (High-to-High Impedance)	t_{PHZ}	$C_L = 15pF$	-	3	7	ns
Propagation Delay Enable to Output (Low-to-High Impedance)	t_{PLZ}	$C_L = 15pF$	-	3	7	ns
Propagation Delay Enable to Output (High Impedance-to-High)	t_{PZH}	$C_L = 15pF$	-	3	7	ns
Propagation Delay Enable to Output (High Impedance-to-Low)	t_{PZL}	$C_L = 15pF$	-	3	7	ns
Output Rise Time (10–90%)	t_R	Single-ended circuit, $t_{IR} = t_{IF} = 3ns$, $C_{BOOST} = 16pF$, $R_{OUT} = 1k\Omega$, $C_{OUT} = 16pF$	-	2	4	ns
Output Fall Time (10–90%)	t_F	Single-ended circuit, $t_{IR} = t_{IF} = 3ns$, $C_{BOOST} = 16pF$, $R_{OUT} = 1k\Omega$, $C_{OUT} = 16pF$	-	2	4	ns

Unless otherwise noted, $V_{DD} = 3V - 5.5V$; OUT and \overline{OE} are open, VDD is bypassed to GND with a 47nF X7R capacitor; $T_A = T_J = +25^\circ C$. Limits apply across the operating temperature range, $-55^\circ C$ to $+125^\circ C$, unless otherwise stated. (Cont.)

Parameter	Symbol	Test Conditions	Min ^[1]	Typ	Max ^[1]	Unit
3.3V Electrical Specifications ($V_{DD} = 3V - 3.6V$; $T = -55^\circ C - 125^\circ C$ unless otherwise stated)						
3.3V Quiescent Supply Current	I_{DDQ}	IN+ = IN- = open	-	1.3	2	mA
Logic High Output Voltage	V_{OH}	$V_{DD} = 3.3V$, OUT = 20 μ A	3.2	3.3	-	V
Logic High Output Voltage	V_{OH}	$V_{DD} = 3.3V$, OUT = 4mA	3.0	3.1	-	V
Logic High Output Drive Current ^[2]	I_{OH}	$V_{OUT} = 3.3V$	-	-10	-7	mA
Logic Low Output Voltage	V_{OL}	$V_{DD} = 3.3V$, OUT = -20 μ A	-	0	0.1	V
Logic Low Output Voltage	V_{OL}	$V_{DD} = 3.3V$, OUT = -4mA	-	0.2	0.8	V
Logic Low Output Drive Current ^[2]	I_{OL}	$V_{OUT} = 0.8V$	7	10	-	mA
Output Disable	V_{OE}	$V_{DD} = 3.3V$	-	1.5	-	V
3.3V Switching Specifications ($V_{DD} = 3V - 3.6V$; $T = -55^\circ C - 125^\circ C$ unless otherwise stated)						
Data Rate	-	Single-ended circuit, $t_{IR} = t_{IF} = 3ns$, $C_{BOOST} = 16pF$, $R_{OUT} = 1k\Omega$, $C_{OUT} = 16pF$	-	-	100	Mbps
Minimum Pulse Width	PW	Single-ended circuit, $t_{IR} = t_{IF} = 3ns$, $C_{BOOST} = 16pF$, $R_{OUT} = 1k\Omega$, $C_{OUT} = 16pF$	10	-	-	ns
Propagation Delay Input to Output (High-to-Low) ^[2]	t_{PHL}	Single-ended circuit, $t_{IR} = t_{IF} = 3ns$, $C_{BOOST} = 16pF$, $R_{OUT} = 1k\Omega$, $C_{OUT} = 16pF$	-	12	18	ns
Propagation Delay Input to Output (Low-to-High) ^[2]	t_{PLH}	Single-ended circuit, $t_{IR} = t_{IF} = 3ns$, $C_{BOOST} = 16pF$, $R_{OUT} = 1k\Omega$, $C_{OUT} = 16pF$	-	12	18	ns
Average Propagation Delay Drift	t_{PDD}	Single-ended circuit, $t_{IR} = t_{IF} = 3ns$, $C_{BOOST} = 16pF$, $R_{OUT} = 1k\Omega$, $C_{OUT} = 16pF$	-	10	-	ps/ $^\circ C$
Pulse Width Distortion $ t_{PHL} - t_{PLH} $ ^[2]	PWD	Single-ended circuit, $t_{IR} = t_{IF} = 3ns$, $C_{BOOST} = 16pF$, $R_{OUT} = 1k\Omega$, $C_{OUT} = 16pF$	-	3	6	ns
Propagation Delay Skew	t_{PSK}	Single-ended circuit, $t_{IR} = t_{IF} = 3ns$, $C_{BOOST} = 16pF$, $R_{OUT} = 1k\Omega$, $C_{OUT} = 16pF$	-2	-	2	ns
Propagation Delay Enable to Output (High-to-High Impedance)	t_{PHZ}	$C_L = 15pF$	-	3	7	ns
Propagation Delay Enable to Output (Low-to-High Impedance)	t_{PLZ}	$C_L = 15pF$	-	3	7	ns
Propagation Delay Enable to Output (High Impedance-to-High)	t_{PZH}	$C_L = 15pF$	-	3	7	ns
Propagation Delay Enable to Output (High Impedance-to-Low)	t_{PZL}	$C_L = 15pF$	-	3	7	ns
Output Rise Time (10–90%)	t_R	Single-ended circuit, $t_{IR} = t_{IF} = 3ns$, $C_{BOOST} = 16pF$, $R_{OUT} = 1k\Omega$, $C_{OUT} = 16pF$	-	3	5	ns
Output Fall Time (10–90%)	t_F	Single-ended circuit, $t_{IR} = t_{IF} = 3ns$, $C_{BOOST} = 16pF$, $R_{OUT} = 1k\Omega$, $C_{OUT} = 16pF$	-	3	5	ns

1. Compliance to datasheet limits is assured by one or more methods: production test, characterization, and/or design.
2. Parameter tested in production.

4. Typical Performance Curves

$V_{DD} = 5V$, $T_A = +25^\circ C$, unless otherwise specified.

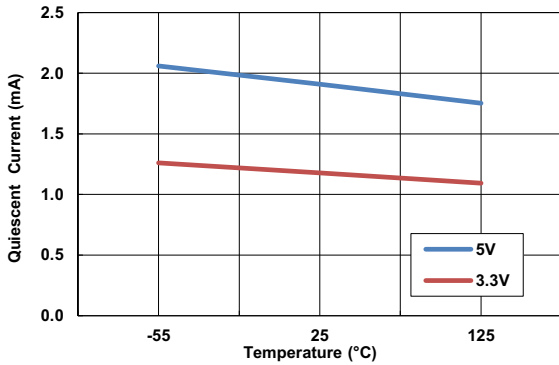

Figure 5. Quiescent Current vs Temperature, Voltage

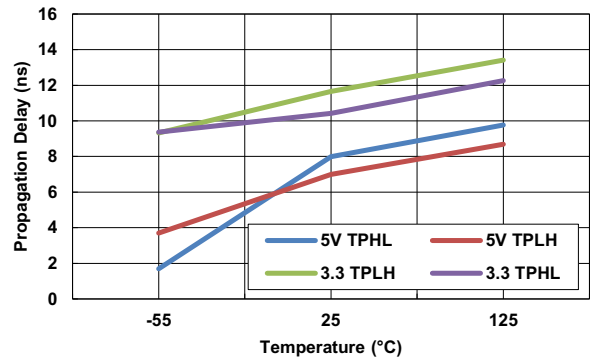

Figure 6. Propagation Delay vs Temperature, Voltage

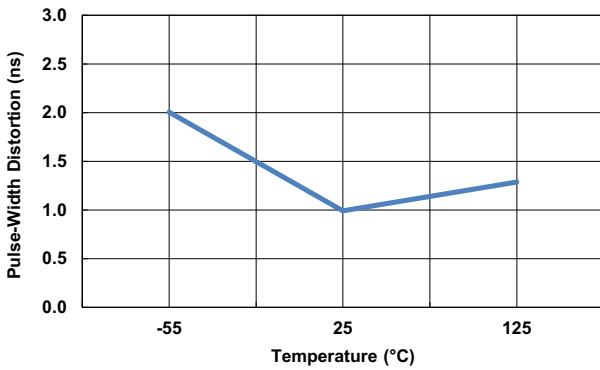

Figure 7. Pulse-Width Distortion vs Temperature

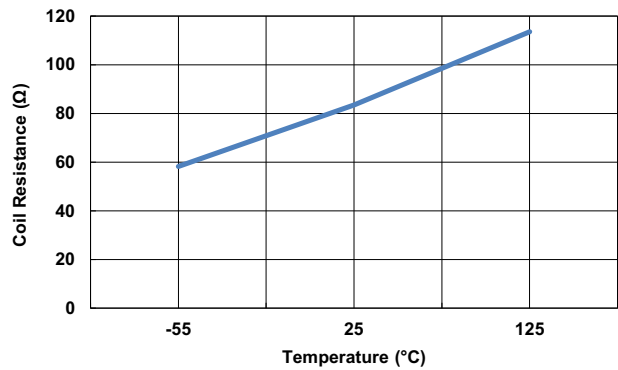

Figure 8. Coil Resistance vs Temperature

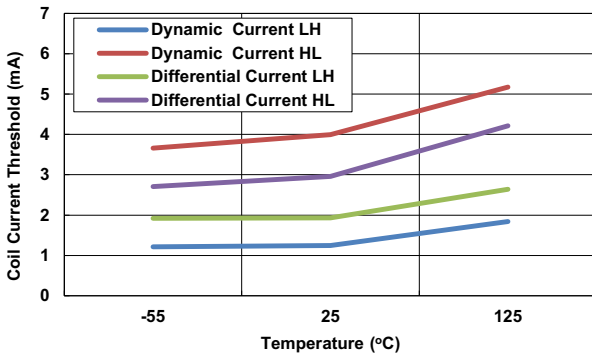

Figure 9. Coil Current Threshold vs Temperature, Voltage

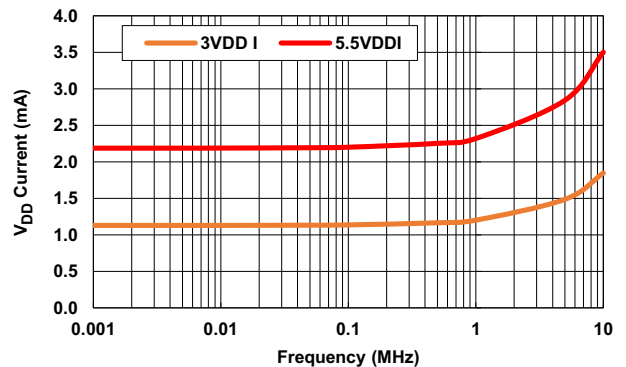

Figure 10. V_{DD} Current vs Frequency, Voltage, 0 load, 50% Duty Cycle

$V_{DD} = 5V$, $T_A = +25^\circ C$, unless otherwise specified. (Cont.)

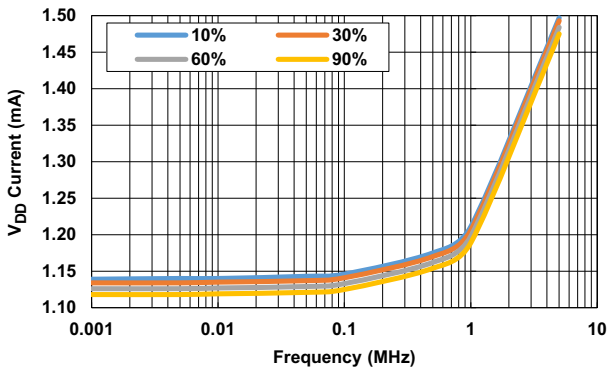

Figure 11. 3V V_{DD} Current vs Frequency, Duty Cycle, 0 load

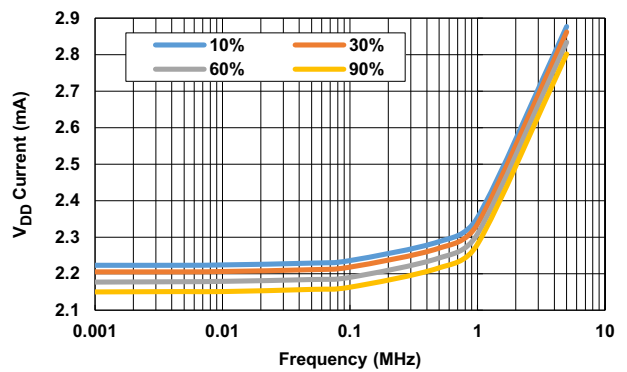

Figure 12. 5.5V V_{DD} Current vs Frequency, Duty Cycle, 0 load

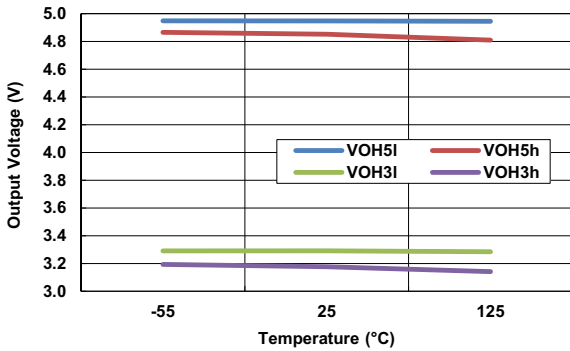

Figure 13. Output High Voltage for 5V and 3.3V with I_{OUT} of $20\mu A$ and 4mA vs Temperature, Voltage

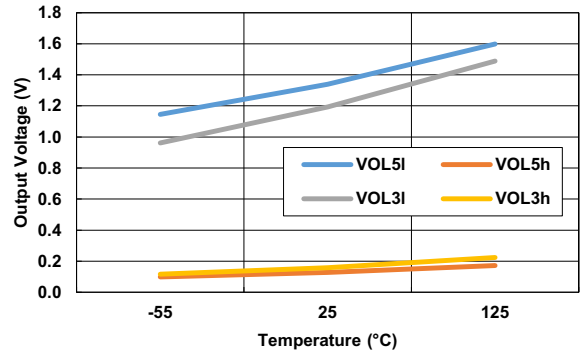

Figure 14. Output Low Voltage for 5V and 3.3V with I_{OUT} of $20\mu A$ and 4mA vs Temperature, Voltage

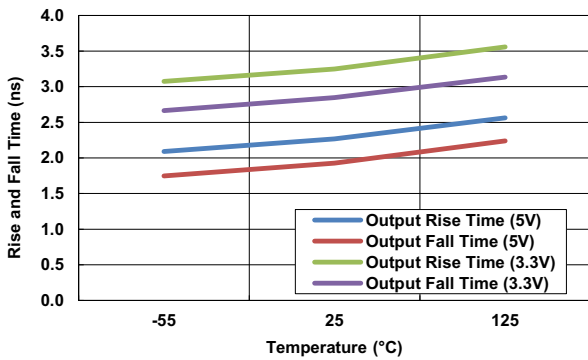

Figure 15. Rise and Fall Time vs Voltage, Temperature

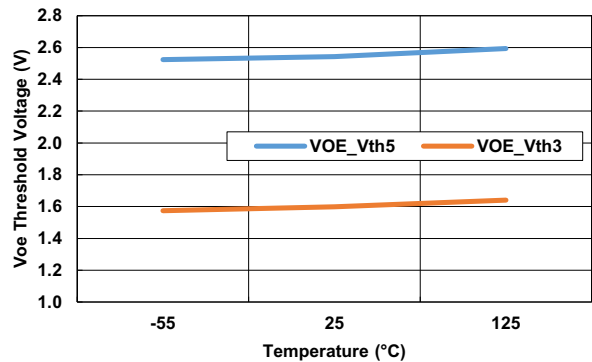

Figure 16. Output Enable Threshold vs Temperature, Voltage

$V_{DD} = 5V$, $T_A = +25^\circ C$, unless otherwise specified. (Cont.)

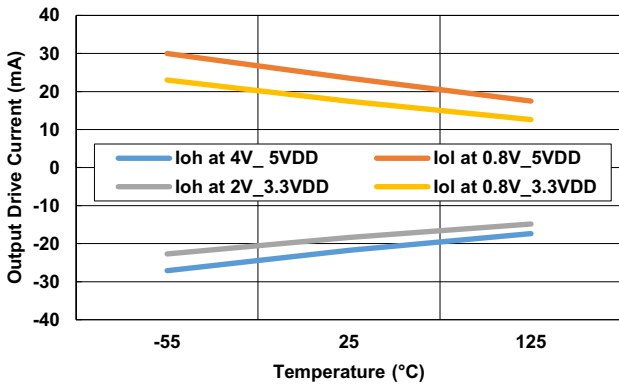

Figure 17. Output Drive Current Capability vs Temperature, Voltage

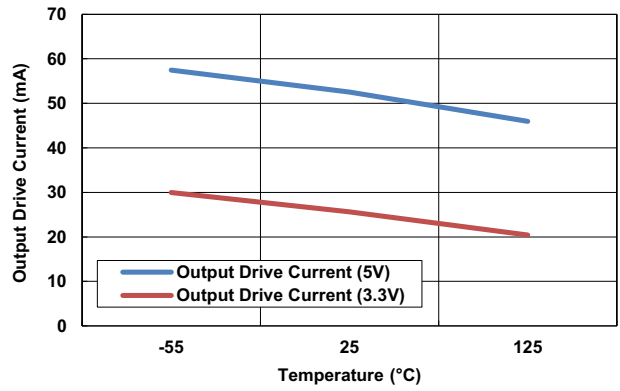

Figure 18. Shorted Output Drive Current Capability vs Temperature, Voltage

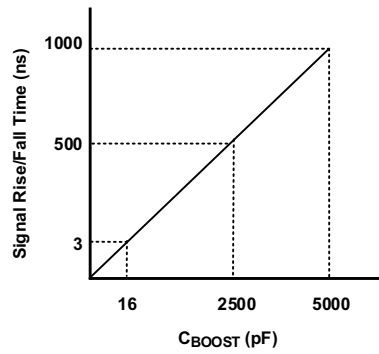

Figure 19. Boost Capacitor (C_{BOOST}) Selector Guide

$V_{DD} = 5V$, $T_A = +25^{\circ}C$, unless otherwise specified. VRlimit trace shows the timing of the coil current through the current limiting resistor and coil as a voltage across the resistor and coil, coil current rise/fall time $\sim 20ns$, V_{OUT} rise/fall time $\sim 10ns$.

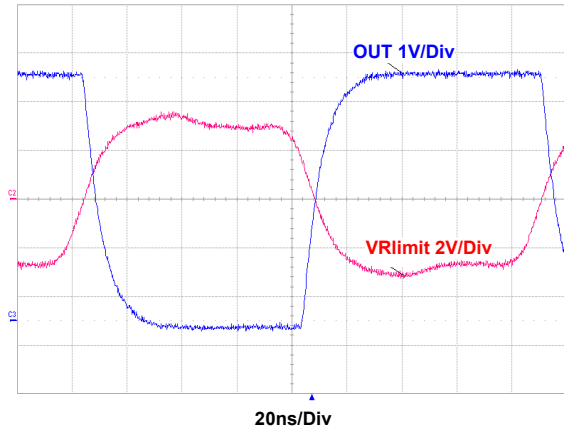

Figure 20. Switching, Coil Current $\sim \pm 8mA$, $C_{BOOST} = 15pF$, $C_{OUT} = 15pF$, $V_{DD} = 5V$

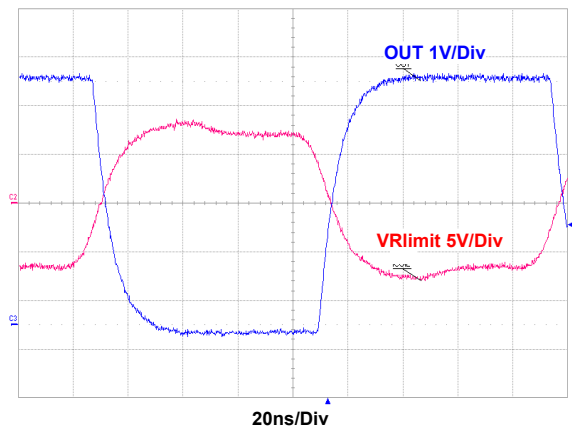

Figure 21. Switching, Coil Current $\sim \pm 18mA$, $C_{BOOST} = 15pF$, $C_{OUT} = 15pF$, $V_{DD} = 5V$

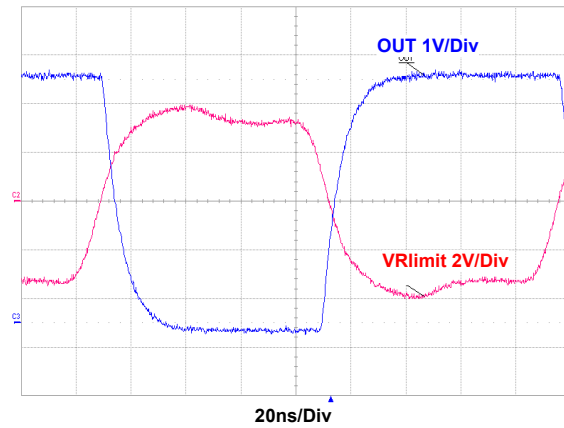

Figure 22. Switching, Coil Current $\sim \pm 8mA$, $C_{BOOST} = 5pF$, $C_{OUT} = 15pF$, $V_{DD} = 5V$

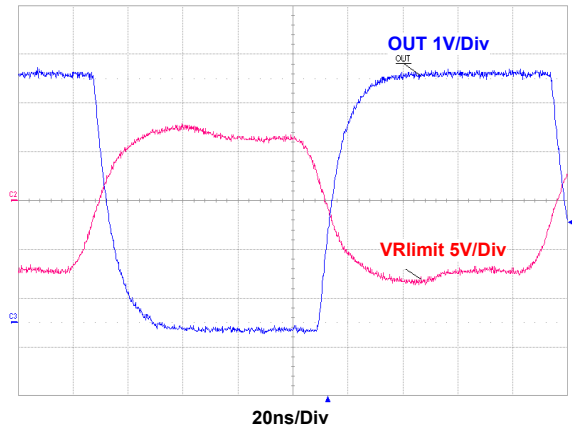

Figure 23. Switching, Coil Current $\sim \pm 18mA$, $C_{BOOST} = 5pF$, $C_{OUT} = 15pF$, $V_{DD} = 5V$

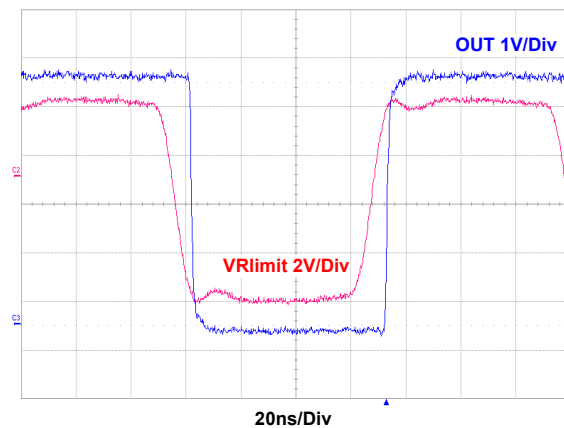

Figure 24. Non Inverting Configuration, Switching Coil Current $\sim \pm 10mA$, $C_{BOOST} = 5pF$, $C_{OUT} = 15pF$, $V_{DD} = 5V$

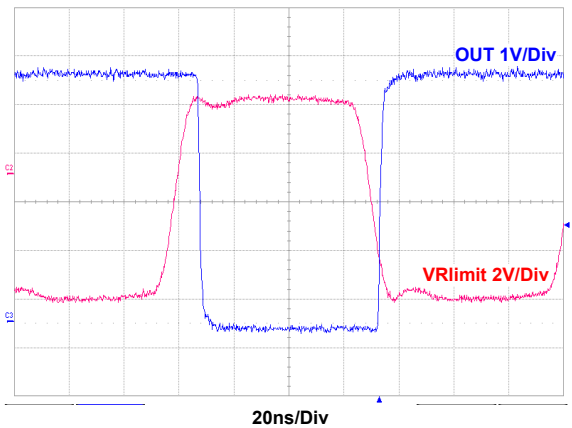

Figure 25. Inverting Configuration, Switching, Coil Current $\sim \pm 10mA$, $C_{BOOST} = 5pF$, $C_{OUT} = 15pF$, $V_{DD} = 5V$

5. Device Information

The ISL71610M isolator is a passive input current mode device. Changes in current flow into the input coil result in logic state changes at the output.

5.1 Coil Polarity

The ISL71610M switches to logic low if current flows from the IN- pin to the IN+ pin. Note that the designations "IN-" and "IN+" refer to logic levels, not current flow. Positive current values means conventional current flows into the IN- input. To ensure an output state in an ion environment the coil must be energized in either direction and must not be in a zero current condition. [Figure 20](#) through [Figure 25](#) illustrate the bidirectional current drive waveforms.

5.2 Input Resistor Selection

A series resistor sets the coil input current. There is no limit to the input voltage amplitude because there are no semiconductor input structures. The minimum current amplitude for an assured output state across the voltage range is $\pm 8\text{mA}$. A "boost capacitor" creates current reversals at edge transitions, reducing the input logic low threshold current to the differential level of 5mA. For a 25°C 8mA coil current, a typical resistor value for 3.3V signaling is 324 Ω and a typical value for 5V signaling is 511 Ω based on an 85 Ω coil resistance. These values are approximate and should be adjusted for temperature or other application specifics. Consult the coil resistance specification and temperature coefficient graph for further information and guidance. If the expected temperature range is large, 1% tolerance resistors may provide additional design margin.

5.3 Single-Ended or Differential Input

The ISL71610M can be run with single-ended or differential inputs. In differential mode, the current naturally flows through the coil in both directions without a boost capacitor, although the capacitor can still be used for increased external field immunity or improved pulse-width distortion. Due to SEE testing results, the single-ended mode of operation should be implemented with $\pm 8\text{mA}$ min of coil current as shown in [Figure 1](#). Using a ground referenced single-ended configuration where there is 0 coil current can result in output state changes, see [Figure 38](#).

An advantage over optocouplers and other high-speed couplers in differential mode is that no reverse bias protection for the input structure is required for a differential signal.

One of the more common applications is for an isolated differential line receiver. For example, RS-485 can drive an ISL71610M directly for a fraction of the cost of an isolated RS-485 node.

5.4 Non-Inverting and Inverting Configurations

ISL71610M can be configured in non-inverting and inverting configurations, each is defined by the direction of current flow through the coil. In the non-inverting configuration current flows through the coil from the IN- side to the IN+ side. The +IN is at a higher voltage potential than the -IN.

5.5 Boost Capacitor

The boost capacitor in parallel with the current-limiting resistor boosts the instantaneous coil current at the signal transition. This ensures switching and reduces propagation delay and reduces pulse-width distortion.

Select the value of the boost capacitor based on the rise and fall times of the signal driving the inputs. The instantaneous boost capacitor current is proportional to input edge speeds ($C \cdot dV/dt$). Select a capacitor value based on the rise and fall times of the input signal to be isolated that provides approximately 20mA of additional "boost" current. For high-speed logic signals ($t_R, t_F < 10\text{ns}$), a 16pF capacitor is recommended. The capacitor value is generally not critical; if in doubt, choose a higher value. See [Figure 19](#).

5.6 Dynamic Power Consumption

Power consumption is proportional to duty cycle, not data rate. The use of NRZ coding minimizes power dissipation because no additional power is consumed when the output is in the high state. In differential mode, where the logic high condition may still require a current to be forced through the coil, power consumption is higher than a typical NRZ single-ended configuration. See [Figure 10](#) through [Figure 12](#) for typical power consumption performance.

5.7 Power Supply Decoupling

A 47nF low-ESR ceramic capacitor is recommended to decouple the power supply. Place the capacitor as close as possible to the VDD pin.

5.8 Maintaining Creepage

Creepage distances are often critical in isolated circuits. Standard pad libraries often extend under the package, compromising creepage and clearance. Similarly, ground planes, if used, should be spaced to avoid compromising clearance.

5.9 Electromagnetic Compatibility and Magnetic Field Immunity

Because the ISL71610M is completely static, it has the lowest emitted noise of any non-optical isolators. The ISL71610M operates by imposing a magnetic field on a GMR sensor, which translates the change in field into a change in logic state. A magnetic shield and a Wheatstone Bridge configuration provide good immunity to external magnetic fields. Immunity to external magnetic fields can be enhanced by proper orientation of the device with respect to the field direction, the use of differential signaling, and boost capacitors.

5.9.1 Orientation of the Device with Respect to the Field Direction

An applied field into the pin edges of the package is the worst case for magnetic immunity. In this case, the external field is in the same direction as the applied internal field. In one direction it tends to help switching; in the other it hinders switching. This can cause unpredictable operation.

An applied field into the pin-less edges of the package has considerably less effect and results in higher magnetic immunity.

5.9.2 Differential Signaling and Boost Capacitors

Regardless of orientation, driving the coil differentially improves magnetic immunity. This is because the logic high state is driven by an applied field instead of zero field, as is the case with single-ended operation. The higher the coil current, the higher the internal field and the higher the immunity to external fields. Optimal magnetic immunity is achieved by adding the boost capacitor.

5.10 Data Rate and Magnetic Field Immunity

It is easier to disrupt an isolated DC signal with an external magnetic field than it is to disrupt an isolated AC signal. Similarly, a DC magnetic field has a greater effect on the device than an AC magnetic field of the same effective magnitude. For example, signals with pulses longer than 100 μ s are more susceptible to magnetic fields than shorter pulse widths.

6. Radiation Tolerance

The ISL71610M isolator is a radiation tolerant device for commercial space applications, Low Earth Orbits (LEO) applications, high altitude avionics, launch vehicles, and other harsh environments. This device's response to Total Ionizing Dose (TID) radiation effects, and Single Event Effects (SEE) has been measured, characterized, and reported in the proceeding sections. The TID performance of the ISL71610MBZ is not guaranteed through radiation acceptance testing. The ISL71610M30BZ is radiation lot acceptance tested (RLAT) to 30krd (Si), and the ISL71610M50BZ is radiation lot acceptance tested to 50krad (Si).

6.1 Total Ionizing Dose (TID) Testing

Total dose testing of the ISL71610MBZ proceeded in accordance with the guidelines of MIL-STD-883 Test Method 1019. The experimental matrix consisted of 32 samples irradiated at a 5.5V bias, as shown in [Table 1](#), and 16 samples irradiated with all pins grounded (unbiased). Three control units were used. The bias configuration is shown in [Figure 35](#). Samples of the ISL71610MBZ were packaged in the production 8 Ld plastic NSOIC, Package Outline Drawing (POD) M8.15G. The samples were screened to datasheet limits at +125°C temperature only before irradiation.

Total dose irradiations were performed using a Hopewell Designs N40 panoramic vault-type low dose rate ⁶⁰Co irradiator located in the Renesas Palm Bay, Florida facility. The dose rate was < 10mrad(Si)/s. PbAl spectrum hardening filters were used to shield the test board and devices under test against low energy secondary gamma radiation.

Down-points for the testing were 0krad(Si), 10krad(Si), 20krad(Si), 30krad(Si), 40krad(Si) and 50krad(Si). All electrical testing was performed outside the irradiator using production Automated Test Equipment (ATE) with data logging of all parameters at each down-point. All down-point electrical testing was performed at +25°C temperature.

6.1.1 Results

[Table 1](#) summarizes the attributes data.

Table 1. Total Dose Test Attributes Data

Bias	Sample Size	Down Point	Bin 1 ^[1]	Rejects
Figure 35	32	Pre-rad	32	-
		10krad(Si)	32	0
		20krad(Si)	32	0
		30krad(Si)	32	0
		40krad(Si)	32	0
		50krad(Si)	32	0
Grounded	16	Pre-rad	16	-
		10krad(Si)	16	0
		20krad(Si)	16	0
		30krad(Si)	16	0
		40krad(Si)	16	0
		50krad(Si)	16	0

1. Bin 1 indicates a device that passes all datasheet specification limits.

The plots in [Figure 26](#) through [Figure 34](#) show data for key parameters at all down points. The plots show the average as a function of total dose for each of the irradiation conditions; we chose to use the average because of the relatively large sample sizes. All parts showed excellent stability over irradiation.

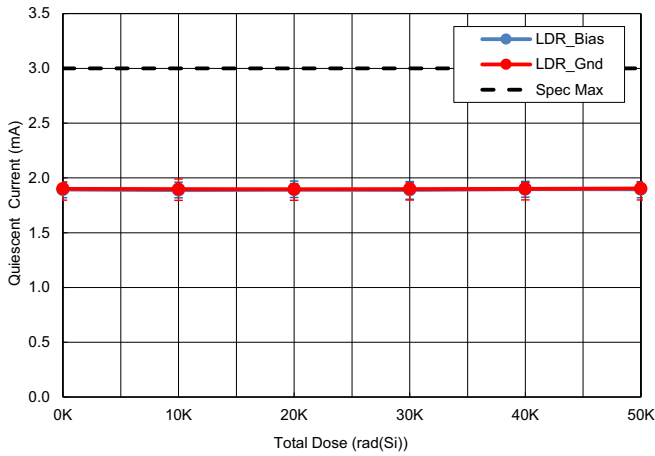

Figure 26. 5V Quiescent Supply Current vs TID

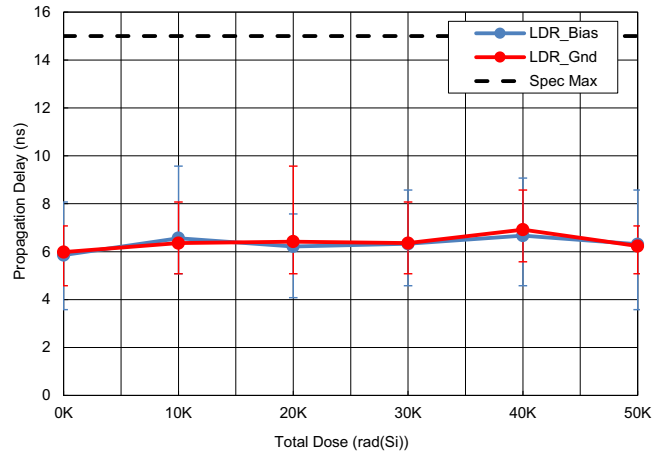

Figure 27. Propagation Delay High-to-Low vs TID

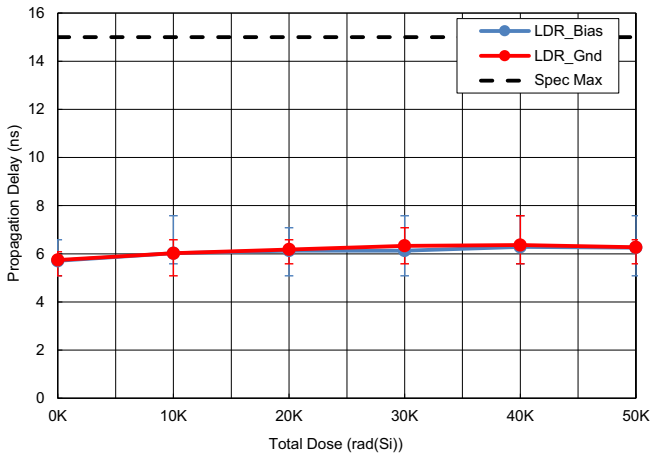

Figure 28. Propagation Delay Low-to-High vs TID

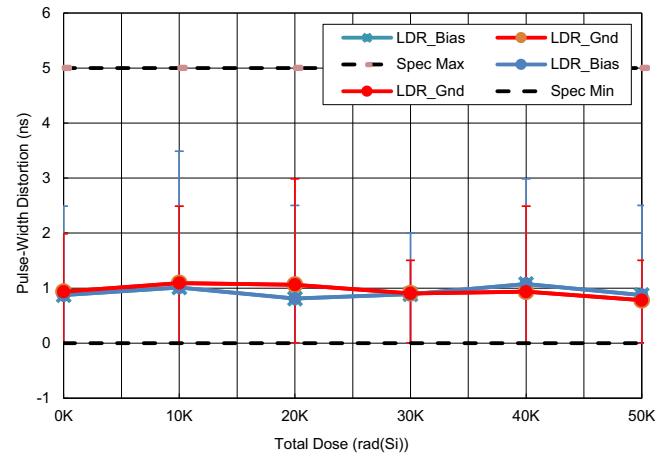

Figure 29. Pulse-Width Distortion vs TID

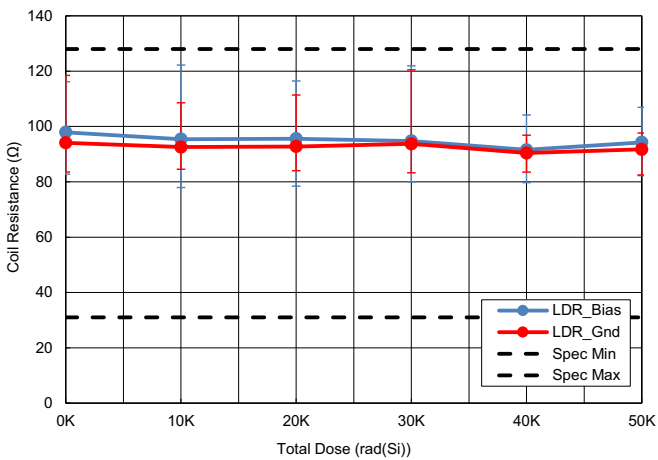

Figure 30. Coil Resistance vs TID

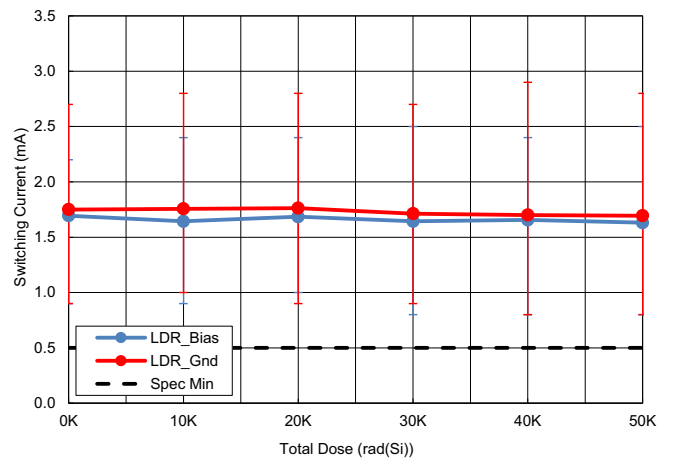

Figure 31. 3V Low-to-High Switching Current vs TID

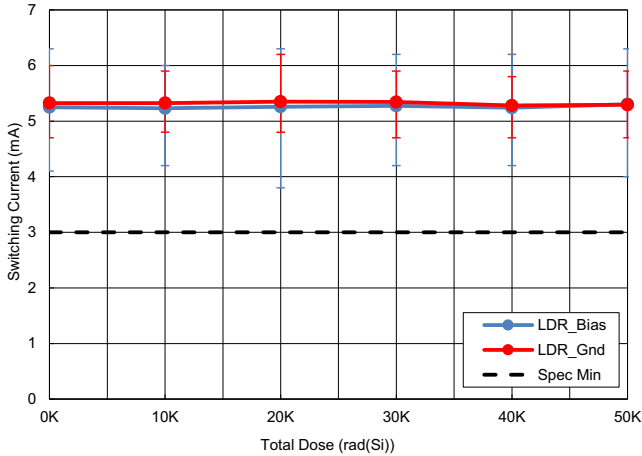

Figure 32. 3V High-to-Low Switching Current vs TID

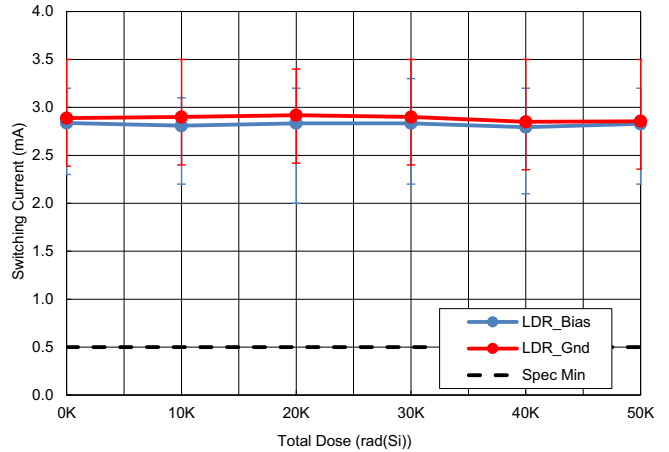

Figure 33. 5V Low-to-High Switching Current vs TID

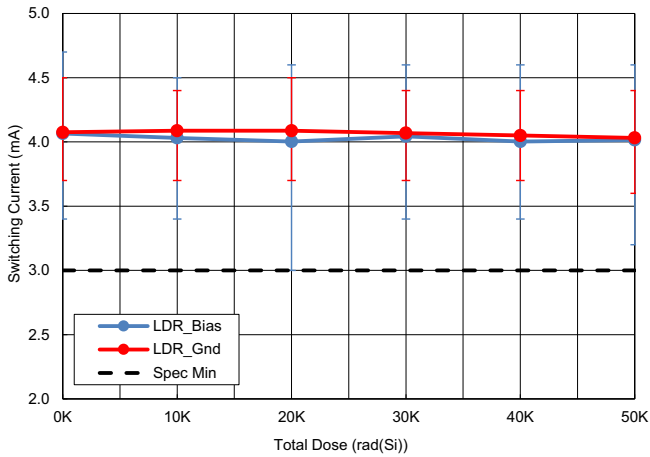

Figure 34. 5V High-to-Low Switching Current vs TID

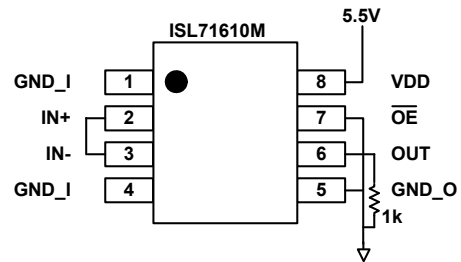

Figure 35. TID Biased Configuration

6.1.2 Conclusion

ATE characterization testing showed no rejects to the datasheet limits at all down points. No differences between biased and unbiased irradiation were noted and the part is not considered bias sensitive. Table 2 shows the average of some of these key parameters with respect to total dose in tabular form.

Table 2. Response of Selected Key Parameters vs TID

Parameter	Bias	0krad(Si)	10krad(Si)	20krad(Si)	30krad(Si)	40krad(Si)	50krad(Si)	Unit
5V Quiescent Supply Current	Biased	1.893105	1.888049	1.892899	1.890288	1.89723	1.896396	mA
	Grounded	1.9003	1.897326	1.896655	1.898356	1.900895	1.90328	
Propagation Delay Input to Output (High-to-Low)	Biased	5.858396	6.560396	6.217196	6.326396	6.669596	6.310796	ns
	Grounded	5.983196	6.357596	6.419997	6.357596	6.919195	6.232796	
Propagation Delay Input to Output (Low-to-High)	Biased	5.709593	6.021594	6.130794	6.130744	6.286794	6.255595	ns
	Grounded	5.740793	6.021295	6.177396	6.333395	6.364596	6.271196	
Pulse-Width Distortion	Biased	0.8736	1.011751	0.811188	0.889199	1.075501	0.8745	ns
	Grounded	0.935999	1.0911	1.0617	0.904802	0.9351	0.781802	
Coil Resistance	Biased	97.8870	95.4354	95.5908	94.7388	91.5808	94.2767	Ω
	Grounded	94.0883	92.5607	92.7636	93.7211	91.4286	91.7139	

6.2 Single Event Effects Testing

The intense heavy ion environment encountered in space applications can cause a variety of Single Event Effects (SEE). SEE can lead to system-level performance issues including disruption, degradation, and destruction. For predictable and reliable space system operation, individual electronic components should be characterized to determine their SEE response. The following is a summary of the SEE testing of the ISL71610M.

6.2.1 SEE Test Facility

Testing was performed at the Texas A&M University (TAMU) Cyclotron Institute heavy ion facility. This facility is coupled to a K500 superconducting cyclotron, which is capable of generating a wide range of test particles with the various energy, flux, and fluence level needed for advanced radiation testing.

6.2.2 Scope of the ISL71610M SEE Testing

The ISL71610M is a single channel, passive input, digital isolator with a CMOS compatible output packaged in an 8 Ld NSOIC package. The testing described here was undertaken for a preliminary evaluation of the ISL71610M for use in space applications. Both destructive Single Event Dielectric Rupture (SEDR) of the barrier isolation and non-destructive Single Event Transients (SET) were tested. In addition, destructive Single Event Burnout (SEB) and Single Event Latch-Up (SEL) of the CMOS circuitry were tested.

6.2.3 Testing Set Up

The plastic packages were opened chemically to expose the die surface so that SEE testing could be accomplished. Care had to be observed to ensure that the plastic was opened but that the isolation barrier was not compromised. This took a bit of trial and error, but a process to open the parts was found. When opened, the barrier isolation was degraded by free air breakdown to about 750VDC.

Four parts were mounted close together on boards for simultaneous irradiation. For the barrier SEDR testing the pins on either side of the barrier were all shorted together (1-4 on one side and 5-8 on the other side) so that a high voltage could be applied across the isolation barrier. For SEB and SEL testing the parts were powered with various voltages while irradiating. For both forms of destructive SEE the parts were heated to +125°C. For the SET testing the parts were at +25°C and biased with either 3.0V or 5.5V supplies with static inputs of both states tested.

6.2.4 Isolation Barrier SEDR Testing

The ISL71610M barrier isolation SEDR was tested by biasing the four parts with 200V to 500V in 50V increments while irradiating with normal incidence silver (Ag) for a surface LET of 43MeV·cm²/mg to a fluence of 1x10⁷ ion/cm² at each of the seven voltages. The four parts were heated to +125°C for the testing. The leakage current across the barrier of each part was measured before and after each irradiation to assess the change. The leakages all measured below 75nA both before and after irradiation. No leakage changed by more than 50% as a result of the irradiation being observed. The isolation barrier is rated to 500V over the entire operational envelope.

6.2.5 DSEE (SEB and SEL) Testing

For this testing the isolation barrier voltage was set to 0V and the four parts were powered with supply voltages of 5.5V, 6.0V, 6.5V, and 7.0V.

The parts were heated to +125°C during the testing. Before and after each irradiation to 1x10⁷ ion/cm² with normal incidence silver for silver (Ag) for a surface LET of 43MeV·cm²/mg the supply currents and the output voltages were measured at a V_{DD} of 5.0V at both input states to exercise both output conditions. During irradiation the input had a 500kHz signal applied (0-5mA) and none of the monitored values changed significantly (more than 1%) during the irradiations establishing 7V as the maximum V_{DD} voltage.

6.2.6 SET Testing

The ISL71610M was tested for qualification of Single Events Transients (SET) on October 16, 2018. The testing was done at TAMU's Cyclotron Institute. The SET test plan was constructed based on results from preliminary

testing of the NVE IL610, which is the same base part. The results of most interest for the preliminary testing (June 2017 and December 2017) were the two forms of observed SET for the IL610 at the LET level of $43\text{MeV}\cdot\text{cm}^2/\text{mg}$. The first form was a spike SET where the output had a transition toward the opposite state for a very short time, less than 50ns, (Figure 36 and Figure 37). The second type of SET previously observed was a state change SET. Figure 38 shows where the output transitioned to the opposite state and stayed there until another event triggered it back again.

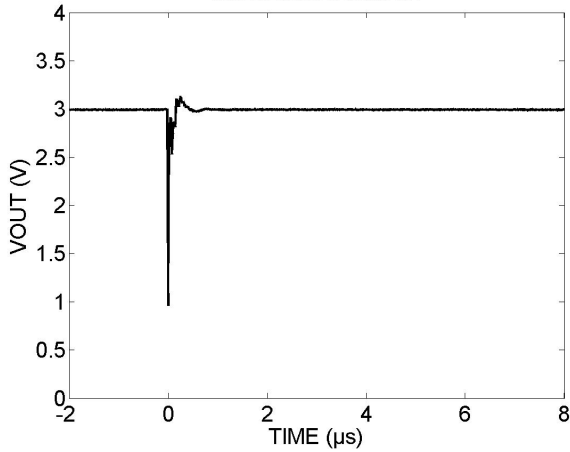

Figure 36. 0mA in Coil, Output High, $V_{DD} = 3.0\text{V}$

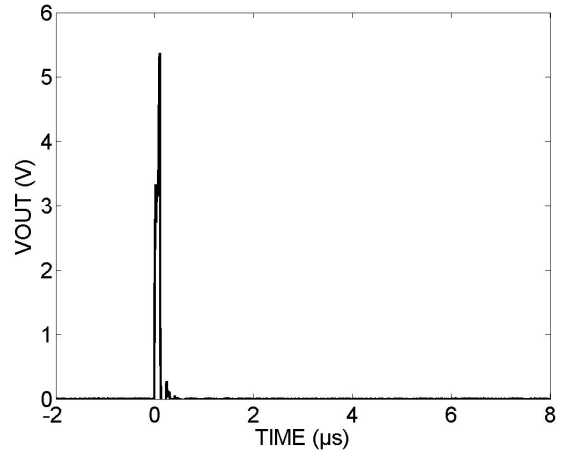

Figure 37. 5mA Through Coil, Output Low, $V_{DD} = 5.5\text{V}$

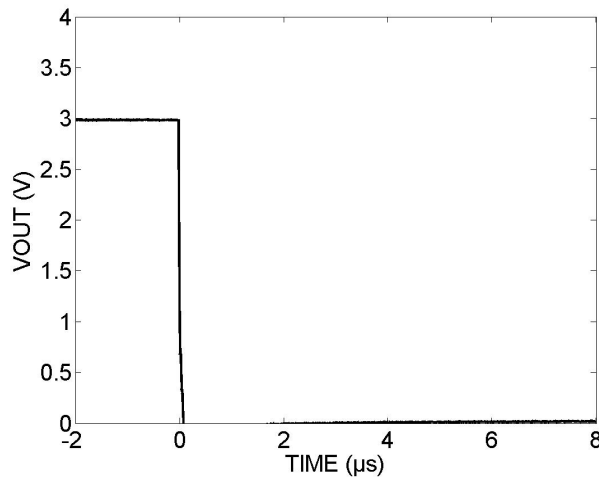

Figure 38. 0mA in Coil, Output Latched Low, $V_{DD} = 3.0\text{V}$

The state change events were always when the coil current was 0A and the V_{DD} was at 3.00V. The pertinent SET counts from the previous testing appear in Table 3.

Table 3. SET Type Counts for Previous Testing of the ISL71610M Done in June 2017 and December 2017

Date	V_{DD} (V)	IN- (mA)	Spike SET Counts by DUT					State Change SET by DUT				
			1	2	3	4	Total	1	2	3	4	Total
6-17	3.0	0	11	5	10	0	26	0	19	0	32	51
	3.0	5	1	0	0	0	1	0	0	0	0	0
	5.5	5	10	0	18	0	28	0	0	0	0	0
	5.5	0	0	0	0	0	0	0	0	0	0	0

Table 3. SET Type Counts for Previous Testing of the ISL71610M Done in June 2017 and December 2017 (Cont.)

Date	V _{DD} (V)	I _N (mA)	Spike SET Counts by DUT					State Change SET by DUT				
			1	2	3	4	Total	1	2	3	4	Total
12-17	3.0	0	0	14	0	9	23	20	0	22	0	42
	3.0	5	0	8	0	0	8	0	0	0	0	0
	5.5	5	0	6	0	0	6	0	0	0	0	0
	5.5	0	6	5	13	0	24	0	0	0	0	0

In addition to the specific conditions associated with the state changes, it should be noted that only four of the eight units tested exhibited the state change SETs. Another important observation is that the parts that exhibited the state change events did not exhibit any state changes when a current was applied to the input. Although the current was always a positive current (to give a low output) it was inferred that a negative current (to give a high output) would also be immune to the state changes.

For the October 2018 SET testing the ISL71610M parts were tested four at a time (all within the beam diameter). Each output was buffered and monitored by an oscilloscope that stored a trace whenever triggered. The triggers were set according to the nominal output. When the nominal output was a logic low (GND), the trigger was set for any transition through 0.8V. When the nominal output was logic high (V_{DD}) the trigger was set for any transition through 2.0V. The supply voltage, V_{DD}, was set to either 3.00V or 4.25V. These represent the lowest voltages anticipated for supplies of a 3.3V nominal and for a 5.0V nominal (including use with the ISL70040SEH low side GaN FET driver). The coil current covered the cases of ±8mA and 0mA to test for the state change events. The ISL71610M SET count summary appears in Table 4.

Table 4. SET Count Summary

LET, Species (MeV·cm ² /mg)	I _{IN} (mA)	Trigger (V)	V _{DD} (V)	Spike SET counts in 1x10 ⁷ ions/cm ²				Totals
				DUT5	DUT6	DUT7	DUT8	
43 Silver	0	2.0	3.00	13	10	15	19	57
			4.25	8	1	7	17	33
			3.00	0	1	0	3	4
	-8	0.8	3.00	6	8	7	15	36
			4.25	6	11	5	12	34
			3.00	10	5	11	7	33
20 Copper	0	2.0	3.00	11	6	7	4	28
			4.25	3	5	2	5	15
			3.00	0	0	0	0	0
	-8	0.8	3.00	3	4	4	4	15
			4.25	6	3	12	5	26
			3.00	5	5	6	2	18
8.5 Argon	0	2.0	3.00	3	4	4	2	13
			4.25	0	0	0	0	0
			3.00	0	0	0	0	0
	-8	0.8	3.00	0	0	1	0	1
			4.25	1	1	4	2	8
			3.00	0	0	0	0	0

The four ISL71610M units tested October 2018 did not exhibit the state change events. With no assignable cause available it must be assumed that it was only chance that no units exhibited the state change SET seen previously. In addition, it was impossible to test if negative coil current would stop the state change SET. Neither was it possible to determine if the state change SET was stopped at a V_{DD} of 4.25V. Previous testing proved that

it was not an issue at V_{DD} of 5.5V. The net ratio of parts exhibiting the state change events is reduced by these results to four out of twelve units.

Previous testing of the ISL71610M revealed a chance of a state change under a zero current drive condition. All the previous testing represented in Table 3 and Table 4 leads to a total of 93 state change events in $1.2 \times 10^8 \text{ion/cm}^2$ for a nominal cross-section of $7.75 \times 10^{-7} \text{cm}^2$.

New testing was performed in November of 2019 to better characterize the risk of these state change events. A total of sixteen units were irradiated with three ion species (Au, Ag, Kr for 86, 43, 28MeV $\cdot\text{cm}^2/\text{mg}$) to $1 \times 10^7 \text{ion/cm}^2$ each test at two supply voltages (3.00V and 4.25V). The input coil was shorted in all cases leaving the coil current at zero, and the temperature was at 25°C. The output was monitored for both instantaneous spike SET and state change SET. The results of this testing are summarized in Table 5.

Table 5. November 2019 SET Testing Summary

DUT	Au - 3.0V		Au - 4.5V		Ag - 3.0V		Ag - 4.5V		Kr - 3.0V		Kr - 4.5V	
	Spike	Change	Spike	Change	Spike	Change	Spike	Change	Spike	Change	Spike	Change
1	21	0	18	0	22	0	8	0	9	0	3	0
2	16	0	5	0	12	0	3	0	10	0	3	0
3	21	0	13	0	10	0	13	0	8	0	5	0
4	20	1	22	0	16	0	5	0	8	0	7	0
5	18	0	3	0	7	0	1	0	12	0	0	0
6	12	0	11	0	9	0	10	0	11	0	7	0
7	20	0	11	0	12	0	7	0	8	0	6	0
8	20	0	19	0	8	0	7	0	10	0	3	0
9	21	0	5	0	15	0	8	0	9	0	8	0
10	16	0	10	0	8	0	9	0	15	0	3	0
11	21	0	10	0	9	0	3	0	8	0	14	0
12	27	0	7	0	14	0	1	0	12	0	0	0
13	13	0	0	0	11	0	0	0	6	0	0	0
14	8	0	6	0	13	0	8	0	15	0	10	0
15	19	0	7	0	9	0	7	0	6	0	4	0
16	15	0	11	0	10	0	2	0	3	0	6	0
Totals	288	1	158	0	185	0	92	0	150	0	79	0

This most recent testing yielded only one state change SET in $1.6 \times 10^8 \text{ion/cm}^2$ distributed over sixteen units operating at 3.00V supply and zero input current with irradiation of normal incidence gold for 86MeV $\cdot\text{cm}^2/\text{mg}$. No state change SET was encountered for testing at higher supply voltage (4.25V) or with lower LET ions (43 and 28MeV $\cdot\text{cm}^2/\text{mg}$). Combining this data with the earlier data leads to 94 state change SET in $2.8 \times 10^8 \text{ion/cm}^2$ and leads to a cross-section of $3.35 \times 10^{-7} \text{cm}^2$. This represents extremely low jeopardy of an event, even if assuming jeopardy extends down to LET of 28MeV $\cdot\text{cm}^2/\text{mg}$.

The captured SET traces for the case of 43MeV $\cdot\text{cm}^2/\text{mg}$ were post processed with a MATLAB® routine to find the duration of the triggering SET. These results were plotted in a form similar to a probability plot and are presented in Figure 39. The longest SET observed was under 39ns, for the case of a high output with a zero current into the coil. For a given V_{DD} the case of a -8mA coil current yielded shorter SET durations as compared to the case with zero current, even though both resulted in nominally high outputs. Durations were the output SET time below 2.0V for a high output, and the duration above 0.8V for a low output.

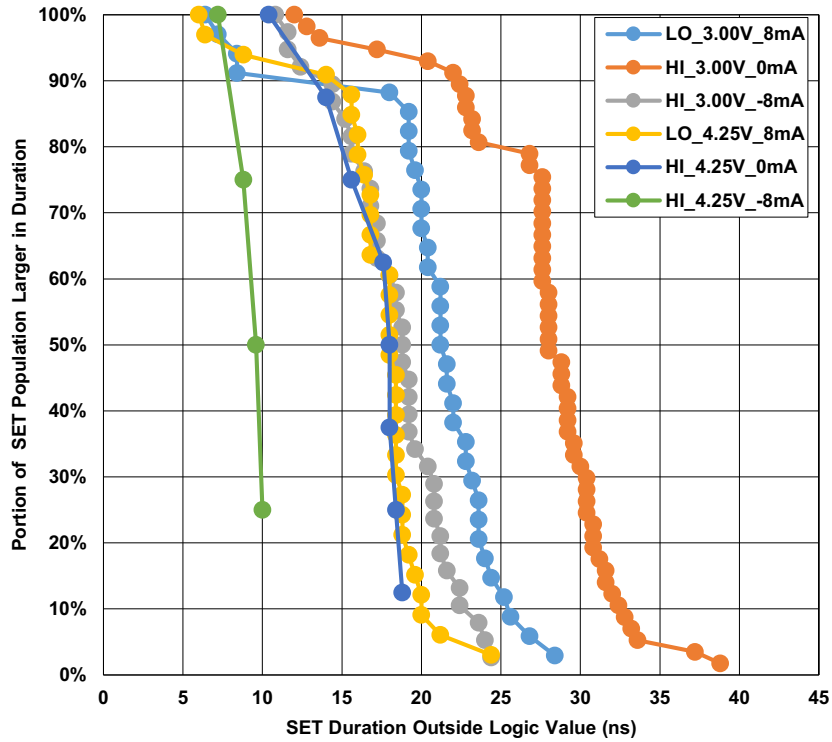

Figure 39. Plot of Cumulative SET Population Portion that is Greater than an Indicated SET Duration

The longest SET transient captured for the ISL71610M at $43\text{MeV}\cdot\text{cm}^2/\text{mg}$ is presented in Figure 40. The twenty foot coaxial cable used to connect the oscilloscope to the buffer on the DUT induced considerable ringing that appears in Figure 40. No filtering was applied at the receiving end so as not to spread the initial events. The initial event in the figure is the sharp spike down that persists below 2.0V for 38.8ns. The smallest duration events barely reached the 2.0V or 0.8 trigger levels and persisted for as little as 6ns.

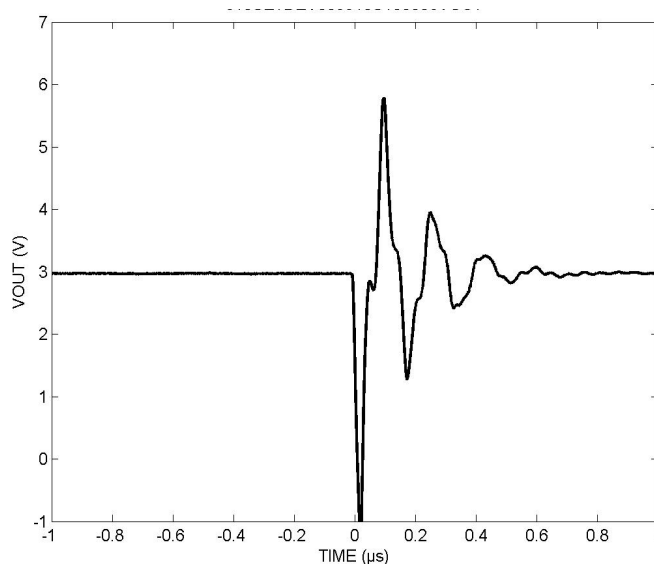

Figure 40. The SET of Extracted Duration of 38.8ns below 2.0V in the First Impulse

6.2.7 Summary

The ISL71610M common barrier isolation was immune to SEDR with normal incidence Ag for an LET of 43MeV•cm²/mg to a fluence of 1x10⁷ion/cm² at an isolation voltage of 500V.

The ISL71610M circuitry was immune to SEL and SEB with normal incidence Ag for an LET of 43MeV•cm²/mg to a fluence of 1x10⁷ ion/cm² at a supply voltage of 7.0V.

The ISL71610M had static SET cross sections of at or below 1.8x10⁻⁶cm² when exposed to normal incidence Ag with an LET of 43MeV•cm²/mg.

The SET results indicate that the preferred operating conditions are: energize the coil to reduce the incidence of an output state change. The higher V_{DD} supply appears to correlate with lower numbers of transients and no output state changes. The SET results also point to a system design consideration in that the system must be able to survive 40ns wide transients that violate the high and low input threshold voltages of the device they are attached to.

7. Package Outline Drawing

For the most recent package outline drawing, see [M8.15G](#).

M8.15G

8 Lead Narrow Body Small Outline Plastic Package

Rev 2, 10/18

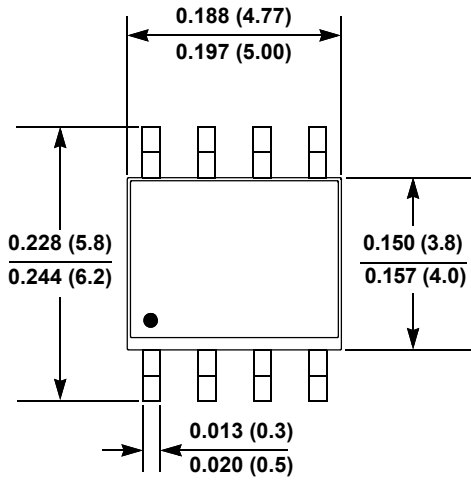

Top View

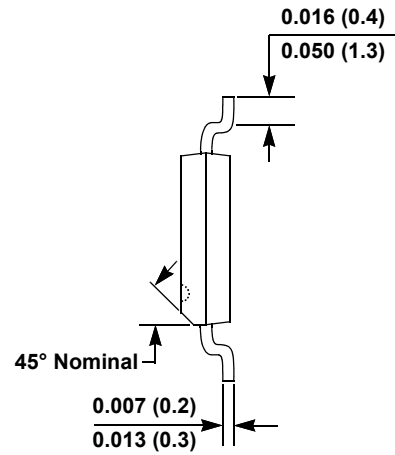

Side View

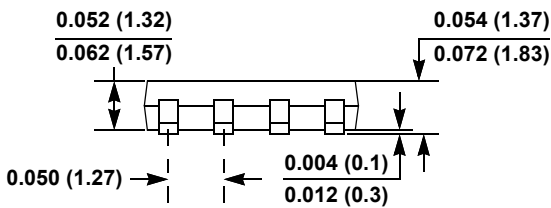

End View

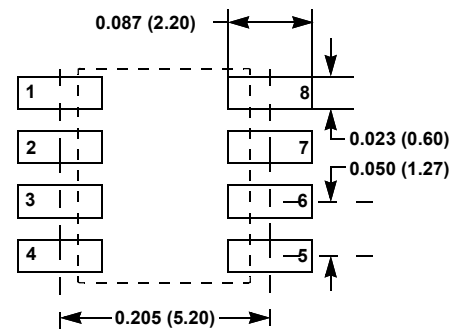

Typical Recommended Land Pattern

Notes:

1. Dimensions in inches (mm); scale = approximately 5X.
2. Pin spacing is a BASIC dimension; tolerances do not accumulate.

8. Ordering Information

Part Number ^[1]	Part Marking	Radiation Lot Acceptance Testing	Package Description (RoHS Compliant)	Package Drawing	MSL Rating ^[2]	Carrier Type ^[3]	Temperature Range
ISL71610MBZ	71610 MBZ	N/A	8 Ld NSOIC	M8.15G	1	Tube	-55 to +125°C
ISL71610MBZ-T						Reel, 2.5k	
ISL71610MBZ-T7A						Reel, 250	
ISL71610M30BZ	71610 MBZ	30krad(Si)	8 Ld NSOIC	M8.15G	1	Tube	-55 to +125°C
ISL71610M30BZ-T						Reel, 2.5k	
ISL71610M30BZ-T7A						Reel, 250	
ISL71610M50BZ	71610 MBZ	50krad(Si)	8 Ld NSOIC	M8.15G	1	Tube	-55 to +125°C
ISL71610M50BZ-T						Reel, 2.5k	
ISL71610M50BZ-T7A						Reel, 250	
ISL71610-710EV1Z	Evaluation Board						

- These Pb-free plastic packaged products employ special Pb-free material sets; molding compounds/die attach materials and NiPdAu-Ag plate-e4 termination finish, which is RoHS compliant and compatible with both SnPb and Pb-free soldering operations. Pb-free products are MSL classified at Pb-free peak reflow temperatures that meet or exceed the Pb-free requirements of IPC/JEDEC J STD-020.
- For more information about MSL, see [TB363](#).
- Refer to [TB347](#) for details about reel specifications.

9. Revision History

Rev.	Date	Description
2.02	Apr 15, 2025	Updated to the latest template. Updated Features bullets. Added ISL71610M30BZ and ISL71610M50BZ part information throughout document.
2.01	Nov 11, 2022	Added Figures 13, 15, and 16. Removed Related Literature section.
2.00	Dec 17, 2020	Replaced Figure 4. Updated Figure 9 title.
1.00	Mar 5, 2020	Edited 1st paragraph along with Figures 1 and 2 on page 1 for clarity. Added Theta JC top and bottom thermal values. Updated SEE testing results on pages 22 - 23.
0.00	Nov 8, 2018	Initial Release

IMPORTANT NOTICE AND DISCLAIMER

RENESAS ELECTRONICS CORPORATION AND ITS SUBSIDIARIES (“RENESAS”) PROVIDES TECHNICAL SPECIFICATIONS AND RELIABILITY DATA (INCLUDING DATASHEETS), DESIGN RESOURCES (INCLUDING REFERENCE DESIGNS), APPLICATION OR OTHER DESIGN ADVICE, WEB TOOLS, SAFETY INFORMATION, AND OTHER RESOURCES “AS IS” AND WITH ALL FAULTS, AND DISCLAIMS ALL WARRANTIES, EXPRESS OR IMPLIED, INCLUDING, WITHOUT LIMITATION, ANY IMPLIED WARRANTIES OF MERCHANTABILITY, FITNESS FOR A PARTICULAR PURPOSE, OR NON-INFRINGEMENT OF THIRD-PARTY INTELLECTUAL PROPERTY RIGHTS.

These resources are intended for developers who are designing with Renesas products. You are solely responsible for (1) selecting the appropriate products for your application, (2) designing, validating, and testing your application, and (3) ensuring your application meets applicable standards, and any other safety, security, or other requirements. These resources are subject to change without notice. Renesas grants you permission to use these resources only to develop an application that uses Renesas products. Other reproduction or use of these resources is strictly prohibited. No license is granted to any other Renesas intellectual property or to any third-party intellectual property. Renesas disclaims responsibility for, and you will fully indemnify Renesas and its representatives against, any claims, damages, costs, losses, or liabilities arising from your use of these resources. Renesas' products are provided only subject to Renesas' Terms and Conditions of Sale or other applicable terms agreed to in writing. No use of any Renesas resources expands or otherwise alters any applicable warranties or warranty disclaimers for these products.

(Disclaimer Rev.1.01)

Corporate Headquarters

TOYOSU FORESIA, 3-2-24 Toyosu,
Koto-ku, Tokyo 135-0061, Japan
www.renesas.com

Trademarks

Renesas and the Renesas logo are trademarks of Renesas Electronics Corporation. All trademarks and registered trademarks are the property of their respective owners.

Contact Information

For further information on a product, technology, the most up-to-date version of a document, or your nearest sales office, please visit www.renesas.com/contact-us/.