

ISL70219ASEH

40V Radiation Hardened and SET Enhanced, Precision Low-Power Operational Amplifier

FN8459
Rev.3.00
Jan 10, 2020

The [ISL70219ASEH](#) is a very high precision amplifier featuring the perfect combination of low noise vs power consumption. The ISL70219ASEH's low offset voltage, low I_{BIAS} current, and low temperature drift make it the ideal choice for applications requiring both high DC accuracy and AC performance. The combination of high precision, low noise, low power, and a small footprint provides outstanding value and flexibility relative to similar competitive parts.

Applications for these amplifiers include precision active filters, medical and analytical instrumentation, precision power supply controls, and industrial controls.

The ISL70219ASEH is offered in a 10 Ld hermetic ceramic flatpack. The device is packaged in industry standard pin configurations and operates across the extended temperature range from -55°C to +125°C.

Related Literature

For a full list of related documents, visit our website

- [ISL70219ASEH](#) device page

Applications

- Precision instrumentation
- Spectral analysis equipment
- Active filter blocks, thermocouples, and RTD reference buffers
- Data acquisition and power supply control

Features

- Electrically screened to DLA SMD# [5962-14226](#)
- Low input offset voltage. $\pm 110\mu\text{V}$, maximum
- Superb offset temperature coefficient. . . $1\mu\text{V}/^\circ\text{C}$, maximum
- Input bias current $\pm 15\text{nA}$, maximum
- Input bias current TC $\pm 5\text{pA}/^\circ\text{C}$, maximum
- Low current consumption **440 μA**
- Voltage noise $8\text{nV}/\sqrt{\text{Hz}}$
- Wide supply range 4.5V to 36V
- Operating temperature range. -55°C to +125°C
- Radiation acceptance testing
 - HDR (50 to 300rad(Si)/s) 300krad(Si)
 - LDR (10mrad(Si)/s) 50krad(Si)
- SEE hardness (see SEE report for details)
 - SEB LET_{TH} (V_S = ±18V) 86.4MeV • cm²/mg
 - SET recovery time ≤10 μs at 60MeV • cm²/m
 - SEL immune (SOI process)

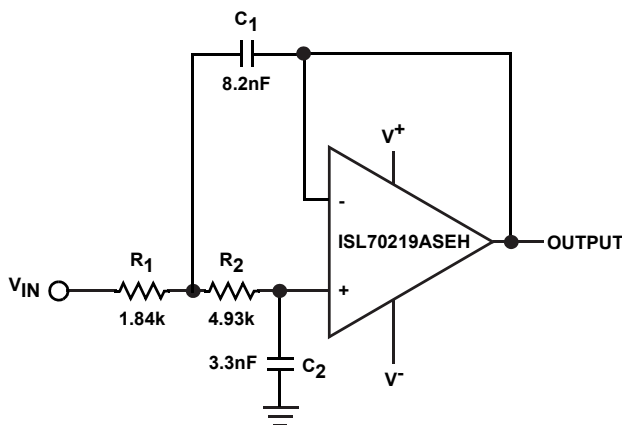

FIGURE 1. TYPICAL APPLICATION: SALLEN-KEY LOW PASS FILTER (F_C = 10kHz)

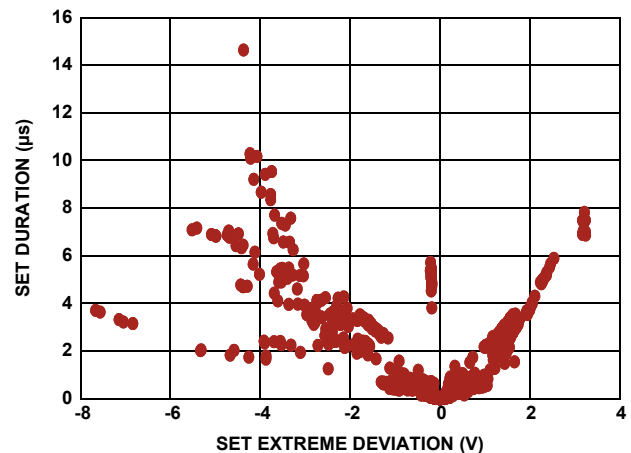
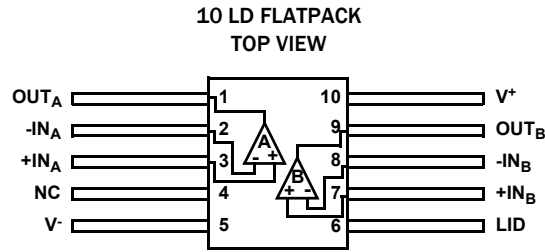

FIGURE 2. SET DEVIATION vs DURATION FOR LET = 60MeV • cm²/mg (V_S = ±18V)

Pin Configuration



Pin Descriptions

| PIN NUMBER | PIN NAME | EQUIVALENT ESD CIRCUIT | DESCRIPTION |
|------------|------------------|------------------------|--------------------------------|
| 1 | OUT _A | Circuit 2 | Amplifier A output |
| 2 | -IN _A | Circuit 1 | Amplifier A inverting input |
| 3 | +IN _A | Circuit 1 | Amplifier A noninverting input |
| 10 | V ⁺ | Circuit 3 | Positive power supply |
| 7 | +IN _B | Circuit 1 | Amplifier B noninverting input |
| 8 | -IN _B | Circuit 1 | Amplifier B inverting input |
| 9 | OUT _B | Circuit 2 | Amplifier B output |
| 5 | V ⁻ | Circuit 3 | Negative power supply |
| 4 | NC | - | No connect |
| 6 | LID | NA | Unbiased, tied to package lid |

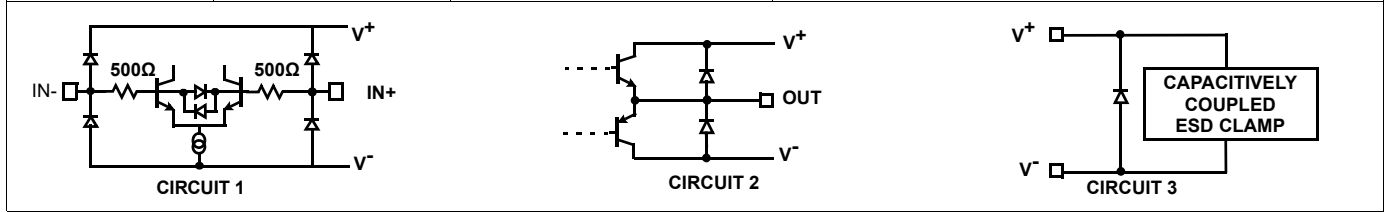

Ordering Information

| ORDERING/SMD NUMBER (Note 2) | PART NUMBER (Note 1) | RADIATION HARDNESS (Total Ionizing Dose) | TEMP RANGE (°C) | PACKAGE (RoHS COMPLIANT) | PKG. DWG. # |
|---|---|--|--------------------|-----------------------------|----------------|
| 5962F1422602VYC | ISL70219ASEHVF | HDR to 300krad(Si), LDR to 50krad(Si) | -55 to +125 | 10 Ld Flatpack | K10.A |
| 5962F1422602V9A | ISL70219ASEHVX (Note 3) | | -55 to +125 | Die | |
| N/A | ISL70219ASEHF/PROTO (Note 4) | N/A | -55 to +125 | 10 Ld Flatpack | K10.A |
| N/A | ISL70219ASEHVX/SAMPLE (Notes 3, 4) | | -55 to +125 | Die | |
| N/A | ISL70219ASEHEV1Z (Note 5) | | Evaluation Board | | |
| | | | | | |

NOTES:

- These Pb-free Hermetic packaged products employ 100% Au plate - e4 termination finish, which is RoHS compliant and compatible with both SnPb and Pb-free soldering operations.
- Specifications for Rad Hard QML devices are controlled by the Defense Logistics Agency Land and Maritime (DLA). The SMD numbers listed must be used when ordering.
- Die product tested at $T_A = +25^\circ\text{C}$. The wafer probe test includes functional and parametric testing sufficient to make the die capable of meeting the electrical performance outlined in Electrical Specifications tables starting on [page 4](#).
- The /PROTO and /SAMPLE are not rated or certified for Total Ionizing Dose (TID) or Single Event Effect (SEE) immunity. These parts are intended for engineering evaluation purposes only. The /PROTO parts meet the electrical limits and conditions across temperature specified in the DLA SMD and are in the same form and fit as the qualified device. The /SAMPLE parts are capable of meeting the electrical limits and conditions specified in the DLA SMD. The /SAMPLE parts do not receive 100% screening across temperature to the DLA SMD electrical limits. These part types do not come with a Certificate of Conformance because they are not DLA qualified devices.
- Evaluation board uses the /PROTO parts. The /PROTO parts are not rated or certified for Total Ionizing Dose (TID) or Single Event Effect (SEE) immunity.

Absolute Maximum Ratings

| | |
|--|--|
| Maximum Supply Voltage | 42V |
| Maximum Supply Voltage (Note 8) | 36V |
| Maximum Differential Input Current | 20mA |
| Maximum Differential Input Voltage | 20V |
| Min/Max Input Voltage | V ⁻ - 0.5V to V ⁺ + 0.5V |
| Max/Min Input Current for Input Voltage >V ⁺ or <V ⁻ | ±20mA |
| Output Short-Circuit Duration (1 output at a time) | Indefinite |
| ESD Rating | |
| Human Body Model (Tested per MIL-PRF-883 3015.7) | 2kV |
| Machine Model (Tested per EIA/JESD22-A115-A) | 200V |
| Charged Device Model (Tested per JESD22-C101D) | 750V |

Thermal Information

| | | |
|-------------------------------------|----------------------|----------------------|
| Thermal Resistance (Typical) | θ_{JA} (°C/W) | θ_{JC} (°C/W) |
| 10 Ld Flatpack Package (Notes 6, 7) | 40 | 8 |
| Storage Temperature Range | -65°C to +150°C | |

Recommended Operating Conditions

| | |
|--|-----------------|
| Ambient Operating Temperature Range | -55°C to +125°C |
| Maximum Operating Junction Temperature | +150°C |
| Single Supply Voltage | 4.5V to 36.0V |
| Split Rail Supply Voltage | ±2.25V to ±18V |

CAUTION: Do not operate at or near the maximum ratings listed for extended periods of time. Exposure to such conditions can adversely impact product reliability and result in failures not covered by warranty.

NOTES:

- θ_{JA} is measured in free air with the component mounted on a high-effective thermal conductivity test board with direct attach features. See [IB379](#) for details.
- For θ_{JC} , the case temperature location is the center of the package underside.
- Tested in a heavy ion environment at LET = 86.4MeV • cm²/mg at +125°C (TC) for SEB. Refer to [Single Event Effects Test Report](#) for more information.

Electrical Specifications ±18.0V $V_S = \pm 18.0V$, $V_{CM} = V_O = 0V$, $R_L = \text{Open}$, $T_A = +25^\circ\text{C}$, unless otherwise noted. **Boldface limits apply across the operating temperature range, -55°C to +125°C; over a total ionizing dose of 300krad(SI) with exposure at a high dose rate of 50ad(SI)/s to 300rad(SI)/s or over a total ionizing dose of 50krad(SI) with exposure at a low dose rate of <10mrad(SI)/s, unless otherwise noted.**

| PARAMETER | SYMBOL | TEST CONDITIONS | MIN (Note 9) | TYP | MAX (Note 9) | UNIT |
|--|------------|---|-----------------|-------|-----------------|-------|
| Input Offset Voltage | V_{OS} | | - | 10 | 85 | μV |
| | | | - | - | 110 | μV |
| Offset Voltage Drift | TCV_{OS} | (Note 10) | - | 0.1 | 1 | μV/°C |
| Input Bias Current | I_B | $T_A = +25^\circ\text{C}$ | -2.50 | 0.08 | 2.50 | nA |
| | | $T_A = -55^\circ\text{C}, +125^\circ\text{C}$ | -5 | - | 5 | nA |
| | | $T_A = +25^\circ\text{C}$, post HDR/LDR Rad | -15 | - | 15 | nA |
| Input Bias Current Temperature Coefficient | TCI_B | (Note 10) | -5 | 1 | 5 | pA/°C |
| Input Offset Current | I_{OS} | $T_A = +25^\circ\text{C}$ | -2.5 | 0.08 | 2.5 | nA |
| | | $T_A = -55^\circ\text{C}, +125^\circ\text{C}$ | -3 | - | 3 | nA |
| | | $T_A = +25^\circ\text{C}$, post HDR/LDR Rad | -10 | - | 10 | nA |
| Input Offset Current Temperature Coefficient | TCI_{OS} | (Note 10) | -3 | 0.42 | 3 | pA/°C |
| Input Voltage Range | V_{CM} | Guaranteed by CMRR test | -16 | - | 16 | V |
| Common-Mode Rejection Ratio | CMRR | $V_{CM} = -16V$ to +16V | 120 | 145 | - | dB |
| | | | 120 | - | - | dB |
| Power Supply Rejection Ratio | PSRR | $V_S = \pm 2.25V$ to ±20V | 120 | 145 | - | dB |
| | | | 120 | - | - | dB |
| Open-Loop Gain | A_{VOL} | $V_O = -16V$ to +16V, $R_L = 10k\Omega$ to ground | 3000 | 14000 | - | V/mV |
| Output Voltage High | V_{OH} | $R_L = 10k\Omega$ to ground | 16.5 | 16.7 | - | V |
| | | | 16.2 | - | - | V |
| | | $R_L = 2k\Omega$ to ground | 16.3 | 16.5 | - | V |
| | | | 16.0 | - | - | V |

Electrical Specifications ±18.0V $V_S = \pm 18.0V$, $V_{CM} = V_O = 0V$, $R_L = \text{Open}$, $T_A = +25^\circ\text{C}$, unless otherwise noted. **Boldface limits apply across the operating temperature range, -55°C to $+125^\circ\text{C}$; over a total ionizing dose of 300krad(Si) with exposure at a high dose rate of 50ad(Si)/s to 300rad(Si)/s or over a total ionizing dose of 50krad(Si) with exposure at a low dose rate of $<10\text{mrad(Si)/s}$, unless otherwise noted. (Continued)**

| PARAMETER | SYMBOL | TEST CONDITIONS | MIN (Note 9) | TYP | MAX (Note 9) | UNIT |
|--|-------------------------------|--|------------------------------|-------|----------------------------|------------------------------|
| Output Voltage Low | V_{OL} | $R_L = 10\text{k}\Omega$ to ground | - | -16.7 | -16.5 | V |
| | | | - | - | -16.2 | V |
| | | $R_L = 2\text{k}\Omega$ to ground | - | -16.5 | -16.3 | V |
| | | | - | - | -16.0 | V |
| Supply Current/Amplifier | I_S | | - | 0.490 | 0.725 | mA |
| | | | - | - | 0.85 | mA |
| Output Short-Circuit Current | I_{SC} | Sourcing: $V_{IN} = 0V$, $V_{OUT} = -16V$ (Note 10) | - | 41 | - | mA |
| | | Sinking: $V_{IN} = 0V$, $V_{OUT} = +16V$ (Note 10) | - | -42 | - | mA |
| Supply Voltage Range | V_{SUPPLY} | Guaranteed by PSRR | ± 2.25 | - | ± 20 | V |
| AC SPECIFICATIONS | | | | | | |
| Gain Bandwidth Product | GBWP | $A_V = 1\text{k}$, $R_L = 2\text{k}\Omega$ (Note 10) | - | 1.5 | - | MHz |
| Voltage Noise V_{P-P} | $e_{nV_{P-P}}$ | 0.1Hz to 10Hz (Note 10) | - | 0.25 | - | μV_{P-P} |
| Voltage Noise Density | e_n | $f = 10\text{Hz}$ (Note 10) | - | 10 | - | $\text{nV}/\sqrt{\text{Hz}}$ |
| Voltage Noise Density | e_n | $f = 100\text{Hz}$ (Note 10) | - | 8.2 | - | $\text{nV}/\sqrt{\text{Hz}}$ |
| Voltage Noise Density | e_n | $f = 1\text{kHz}$ (Note 10) | - | 8 | - | $\text{nV}/\sqrt{\text{Hz}}$ |
| Voltage Noise Density | e_n | $f = 10\text{kHz}$ (Note 10) | - | 8 | - | $\text{nV}/\sqrt{\text{Hz}}$ |
| Current Noise Density | i_n | $f = 1\text{kHz}$ (Note 10) | - | 0.1 | - | $\text{pA}/\sqrt{\text{Hz}}$ |
| TRANSIENT RESPONSE | | | | | | |
| Slew Rate, V_{OUT} 20% to 80% | SR | $A_V = 1$, $R_L = 2\text{k}\Omega$, $V_O = 4V_{P-P}$ | 0.3 | 0.5 | - | $\text{V}/\mu\text{s}$ |
| | | | 0.2 | - | - | $\text{V}/\mu\text{s}$ |
| Rise Time 10% to 90% of V_{OUT} | t_r , t_f Small Signal | $A_V = 1$, $V_{OUT} = 50\text{mV}_{P-P}$, $R_L = 10\text{k}\Omega$ to V_{CM} | - | 130 | 450 | ns |
| | | | - | - | 625 | ns |
| Fall Time 90% to 10% of V_{OUT} | | $A_V = 1$, $V_{OUT} = 50\text{mV}_{P-P}$, $R_L = 10\text{k}\Omega$ to V_{CM} | - | 130 | 600 | ns |
| | | | - | - | 700 | ns |
| Settling Time to 0.1% 10V Step; 10% to V_{OUT} | t_s | $A_V = -1$, $V_{OUT} = 10V_{P-P}$, $R_L = 5\text{k}\Omega$ to V_{CM} (Note 10) | - | 21 | - | μs |
| Settling Time to 0.01% 10V Step; 10% to V_{OUT} | | $A_V = -1$, $V_{OUT} = 10V_{P-P}$, $R_L = 5\text{k}\Omega$ to V_{CM} (Note 10) | - | 24 | - | μs |
| Settling Time to 0.1% 4V Step; 10% to V_{OUT} | | $A_V = -1$, $V_{OUT} = 4V_{P-P}$, $R_L = 5\text{k}\Omega$ to V_{CM} (Note 10) | - | 13 | - | μs |
| Settling Time to 0.01% 4V Step; 10% to V_{OUT} | | $A_V = -1$, $V_{OUT} = 4V_{P-P}$, $R_L = 5\text{k}\Omega$ to V_{CM} (Note 10) | - | 18 | - | μs |
| Output Positive Overload Recovery Time | t_{OL} | $A_V = -100$, $V_{IN} = 0.2V_{P-P}$, $R_L = 2\text{k}\Omega$ to V_{CM} (Note 10) | - | 5.6 | - | μs |
| Output Negative Overload Recovery Time | | $A_V = -100$, $V_{IN} = 0.2V_{P-P}$, $R_L = 2\text{k}\Omega$ to V_{CM} (Note 10) | - | 10.6 | - | μs |
| Positive Overshoot | OS+ | $A_V = 1$, $V_{OUT} = 10V_{P-P}$, $R_f = 0\Omega$ $R_L = 2\text{k}\Omega$ to V_{CM} | - | 15 | - | % |
| | | | - | - | 33 | % |
| Negative Overshoot | OS- | $A_V = 1$, $V_{OUT} = 10V_{P-P}$, $R_f = 0\Omega$ $R_L = 2\text{k}\Omega$ to V_{CM} | - | 15 | - | % |
| | | | - | - | 33 | % |

Electrical Specifications $\pm 5.0V$ $V_S = \pm 5.0V$, $V_{CM} = V_O = 0V$, $R_L = \text{Open}$, $T_A = +25^\circ\text{C}$, unless otherwise noted. **Boldface limits apply across the operating temperature range, -55°C to $+125^\circ\text{C}$; over a total ionizing dose of 300krad(Si) with exposure at a high dose rate of 50rad(Si)/s to 300rad(Si)/s or over a total ionizing dose of 50krad(Si) with exposure at a low dose rate of $<10\text{mrad(Si)/s}$, unless otherwise noted.**

| PARAMETER | SYMBOL | TEST CONDITIONS | MIN (Note 9) | TYP | MAX (Note 9) | UNIT |
|--|----------------|--|-----------------|-------|-----------------|------------------------------|
| Input Offset Voltage | V_{OS} | | - | 10 | 150 | μV |
| | | | - | - | 250 | μV |
| Offset Voltage Drift | TCV_{OS} | (Note 10) | - | 0.1 | 1 | $\mu\text{V}/^\circ\text{C}$ |
| Input Bias Current | I_B | $T_A = +25^\circ\text{C}$ | -2.50 | 0.08 | 2.50 | nA |
| | | $T_A = -55^\circ\text{C}, +125^\circ\text{C}$ | -5 | - | 5 | nA |
| | | $T_A = +25^\circ\text{C}$, post HDR/LDR Rad | -15 | - | 15 | nA |
| Input Bias Current Temperature Coefficient | TCI_B | (Note 10) | -5 | 1 | 5 | $\text{pA}/^\circ\text{C}$ |
| Input Offset Current | I_{OS} | $T_A = +25^\circ\text{C}$ | -2.5 | 0.3 | 2.5 | nA |
| | | $T_A = -55^\circ\text{C}, +125^\circ\text{C}$ | -3 | - | 3 | nA |
| | | $T_A = +25^\circ\text{C}$, post HDR/LDR Rad | -10 | - | 10 | nA |
| Input Offset Current Temperature Coefficient | TCI_{OS} | (Note 10) | -3 | 0.42 | 3 | $\text{pA}/^\circ\text{C}$ |
| Input Voltage Range | V_{CM} | Guaranteed by CMRR test | -3 | | 3 | V |
| Common-Mode Rejection Ratio | CMRR | $V_{CM} = -3V$ to $+3V$ | 120 | 145 | - | dB |
| | | | 120 | | - | dB |
| Power Supply Rejection Ratio | PSRR | $V_S = \pm 2.25V$ to $\pm 5V$ | 120 | 145 | - | dB |
| | | | 120 | | - | dB |
| Open-Loop Gain | A_{VOL} | $V_O = -3.0V$ to $+3.0V$ $R_L = 10\text{k}\Omega$ to ground | 3000 | 14000 | - | V/mV |
| Output Voltage High | V_{OH} | $R_L = 10\text{k}\Omega$ to ground | 3.5 | 3.7 | - | V |
| | | | 3.2 | | - | V |
| | | $R_L = 2\text{k}\Omega$ to ground | 3.30 | 3.55 | - | V |
| | | | 3.0 | | - | V |
| Output Voltage Low | V_{OL} | $R_L = 10\text{k}\Omega$ to ground | - | -3.7 | -3.5 | V |
| | | | - | | -3.2 | V |
| | | $R_L = 2\text{k}\Omega$ to ground | - | -3.55 | -3.30 | V |
| | | | - | | -3.0 | V |
| Supply Current/Amplifier | I_S | | - | 0.470 | 0.675 | mA |
| | | | - | | 0.8 | mA |
| AC SPECIFICATIONS | | | | | | |
| Gain Bandwidth Product | GBWP | $A_V = 1\text{k}$, $R_L = 2\text{k}\Omega$ (Note 10) | - | 1.5 | - | MHz |
| Voltage Noise V_{P-P} | $e_{nV_{P-P}}$ | 0.1Hz to 10Hz (Note 10) | - | 0.25 | - | μV_{P-P} |
| Voltage Noise Density | e_n | $f = 10\text{Hz}$ (Note 10) | - | 12 | - | $\text{nV}/\sqrt{\text{Hz}}$ |
| Voltage Noise Density | e_n | $f = 100\text{Hz}$ (Note 10) | - | 8.6 | - | $\text{nV}/\sqrt{\text{Hz}}$ |
| Voltage Noise Density | e_n | $f = 1\text{kHz}$ (Note 10) | - | 8 | - | $\text{nV}/\sqrt{\text{Hz}}$ |
| Voltage Noise Density | e_n | $f = 10\text{kHz}$ (Note 10) | - | 8 | - | $\text{nV}/\sqrt{\text{Hz}}$ |
| Current Noise Density | i_n | $f = 1\text{kHz}$ (Note 10) | - | 0.1 | - | $\text{pA}/\sqrt{\text{Hz}}$ |

Electrical Specifications $\pm 5.0V$ $V_S = \pm 5.0V$, $V_{CM} = V_O = 0V$, $R_L = \text{Open}$, $T_A = +25^\circ C$, unless otherwise noted. **Boldface limits apply across the operating temperature range, $-55^\circ C$ to $+125^\circ C$; over a total ionizing dose of 300krad(SI) with exposure at a high dose rate of 50rad(SI)/s to 300rad(SI)/s or over a total ionizing dose of 50krad(SI) with exposure at a low dose rate of $<10\text{mrad(SI)/s}$, unless otherwise noted. (Continued)**

| PARAMETER | SYMBOL | TEST CONDITIONS | MIN (Note 9) | TYP | MAX (Note 9) | UNIT |
|---|-------------------------------|---|-----------------|-----|-----------------|------------|
| TRANSIENT RESPONSE | | | | | | |
| Slew Rate, V_{OUT} 20% to 80% | SR | $A_V = 1$, $R_L = 2k\Omega$, $V_O = 4V_{P-P}$ (Note 10) | - | 0.5 | - | V/ μs |
| Rise Time 10% to 90% of V_{OUT} | t_r , t_f Small Signal | $A_V = 1$, $V_{OUT} = 50mV_{P-P}$, $R_L = 10k\Omega$ to V_{CM} (Note 10) | - | 130 | - | ns |
| Fall Time 90% to 10% of V_{OUT} | | $A_V = 1$, $V_{OUT} = 50mV_{P-P}$, $R_L = 10k\Omega$ to V_{CM} (Note 10) | - | 130 | - | ns |
| Settling Time to 0.1% 4V Step; 10% to V_{OUT} | t_s | $A_V = -1$, $V_{OUT} = 4V_{P-P}$, $R_L = 5k\Omega$ to V_{CM} (Note 10) | - | 12 | - | μs |
| Settling Time to 0.01% 4V Step; 10% to V_{OUT} | | $A_V = -1$, $V_{OUT} = 4V_{P-P}$, $R_L = 5k\Omega$ to V_{CM} (Note 10) | - | 19 | - | μs |
| Output Positive Overload Recovery Time | t_{OL} | $A_V = -100$, $V_{IN} = 0.2V_{P-P}$, $R_L = 2k\Omega$ to V_{CM} (Note 10) | - | 7 | - | μs |
| Output Negative Overload Recovery Time | | $A_V = -100$, $V_{IN} = 0.2V_{P-P}$, $R_L = 2k\Omega$ to V_{CM} (Note 10) | - | 5.8 | - | μs |
| Positive Overshoot | OS+ | $A_V = 1$, $V_{OUT} = 10V_{P-P}$, $R_f = 0\Omega$ $R_L = 2k\Omega$ to V_{CM} (V) | - | 15 | - | % |
| Negative Overshoot | OS- | $A_V = 1$, $V_{OUT} = 10V_{P-P}$, $R_f = 0\Omega$ $R_L = 2k\Omega$ to V_{CM} (Note 10) | - | 15 | - | % |

Electrical Specifications $\pm 2.25V$ $V_S = \pm 2.25V$, $V_{CM} = V_O = 0V$, $R_L = \text{Open}$, $T_A = +25^\circ C$, unless otherwise noted. **Boldface limits apply across the operating temperature range, $-55^\circ C$ to $+125^\circ C$; over a total ionizing dose of 300krad(SI) with exposure at a high dose rate of 50rad(SI)/s to 300rad(SI)/s or over a total ionizing dose of 50krad(SI) with exposure at a low dose rate of $<10\text{mrad(SI)/s}$, unless otherwise noted.**

| PARAMETER | SYMBOL | TEST CONDITIONS | MIN (Note 9) | TYP | MAX (Note 9) | UNIT |
|---|------------|--|-----------------|------|-----------------|------------------|
| Input Offset Voltage | V_{OS} | | - | 10 | 150 | μV |
| | | | - | | 250 | μV |
| Offset Voltage Drift | TCV_{OS} | (Note 10) | - | 0.1 | 1 | $\mu V/^\circ C$ |
| Input Bias Current | I_B | $T_A = +25^\circ C$ | -2.50 | 0.18 | 2.50 | nA |
| | | $T_A = -55^\circ C$, $+125^\circ C$ | -5 | - | 5 | nA |
| | | $T_A = +25^\circ C$, post HDR/LDR Rad | -15 | - | 15 | nA |
| Input Bias Current Temperature Coefficient | TCI_B | (Note 10) | -5 | 1 | 5 | $pA/^\circ C$ |
| Input Offset Current | I_{OS} | $T_A = +25^\circ C$ | -2.5 | 0.3 | 2.5 | nA |
| | | $T_A = -55^\circ C$, $+125^\circ C$ | -3 | - | 3 | nA |
| | | $T_A = +25^\circ C$, post HDR/LDR Rad | -10 | - | 10 | nA |
| Input Offset Current Temperature Coefficient | TCI_{OS} | (Note 10) | -3 | 0.42 | 3 | $pA/^\circ C$ |
| Input Voltage Range | V_{CM} | Guaranteed by CMRR Test | -0.25 | - | 0.25 | V |
| Common-Mode Rejection Ratio | CMRR | $V_{CM} = -0.25V$ to $+0.25V$ | 90 | 110 | - | dB |
| | | | 90 | - | - | dB |

Electrical Specifications $\pm 2.25V$ $V_S = \pm 2.25V$, $V_{CM} = V_O = 0V$, $R_L = \text{Open}$, $T_A = +25^\circ C$, unless otherwise noted. **Boldface limits apply across the operating temperature range, $-55^\circ C$ to $+125^\circ C$; over a total ionizing dose of 300krad(Si) with exposure at a high dose rate of 50rad(Si)/s to 300rad(Si)/s or over a total ionizing dose of 50krad(Si) with exposure at a low dose rate of $<10\text{mrad(Si)/s}$, unless otherwise noted. (Continued)**

| PARAMETER | SYMBOL | TEST CONDITIONS | MIN (Note 9) | TYP | MAX (Note 9) | UNIT |
|---------------------|----------|-----------------------------|-----------------|-------|-----------------|------|
| Output Voltage High | V_{OH} | $R_L = 10k\Omega$ to ground | 0.80 | 1.03 | - | V |
| | | | 0.5 | - | - | V |
| | | $R_L = 2k\Omega$ to ground | 0.75 | 0.98 | - | V |
| | | | 0.45 | - | - | V |
| Output Voltage High | V_{OL} | $R_L = 10k\Omega$ to ground | - | -1.03 | -0.80 | V |
| | | | - | - | -0.5 | V |
| | | $R_L = 2k\Omega$ to ground | - | -0.98 | -0.75 | V |
| | | | - | - | -0.45 | V |

NOTES:

9. Compliance to datasheet limits is assured by one or more methods: production test, characterization, and/or design.
10. Guaranteed by characterization, not tested.

Typical Performance Curves Unless otherwise specified, $V_S \pm 18V$, $V_{CM} = 0$, $V_O = 0V$, $T_A = +25^\circ C$.

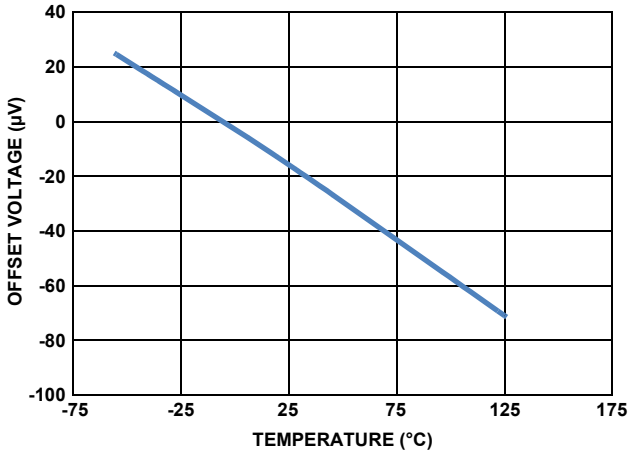

FIGURE 3. V_{OS} vs TEMPERATURE ($\pm 18V$)

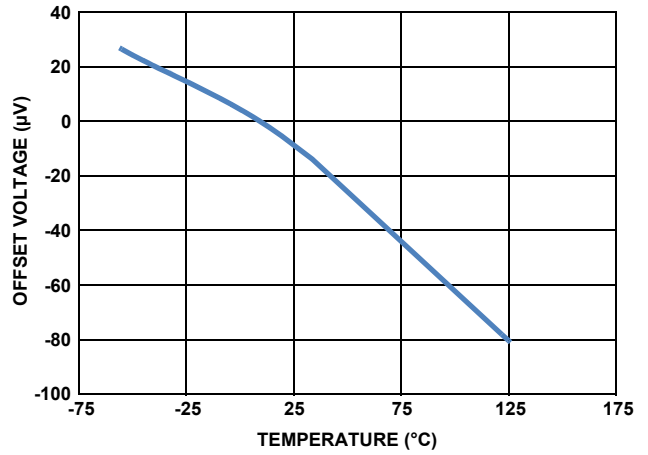

FIGURE 4. V_{OS} vs TEMPERATURE ($\pm 5V$)

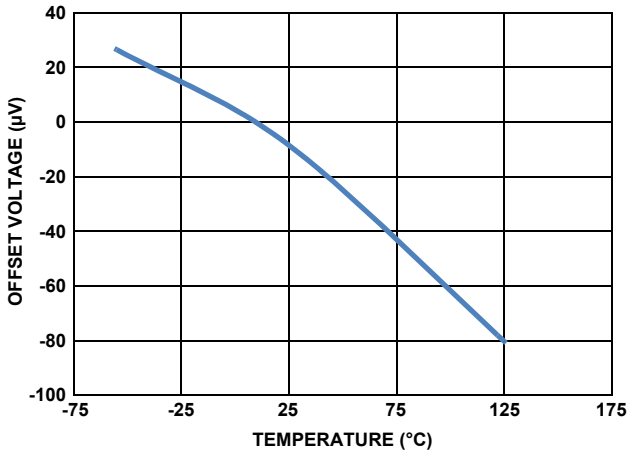

FIGURE 5. V_{OS} vs TEMPERATURE ($\pm 2.5V$)

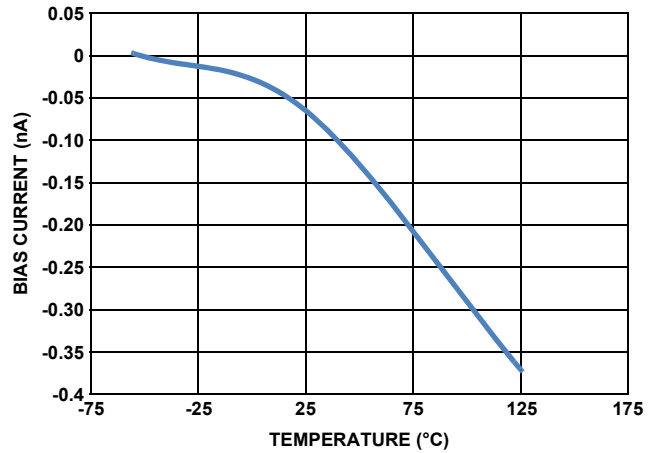

FIGURE 6. I_{BIAS} vs TEMPERATURE

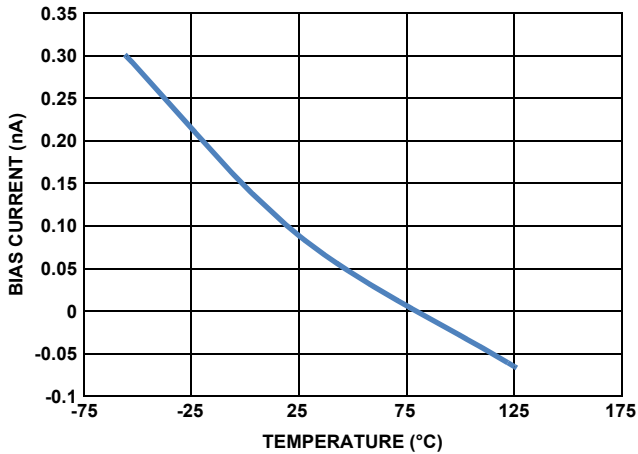

FIGURE 7. I_{BIAS} vs TEMPERATURE ($\pm 5V$)

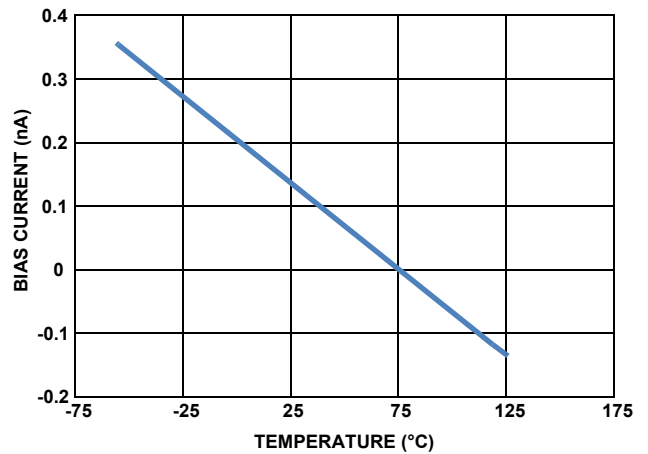

FIGURE 8. I_{BIAS} vs TEMPERATURE ($\pm 2.5V$)

Typical Performance Curves

Unless otherwise specified, $V_S \pm 18V$, $V_{CM} = 0$, $V_O = 0V$, $T_A = +25^\circ C$. (Continued)

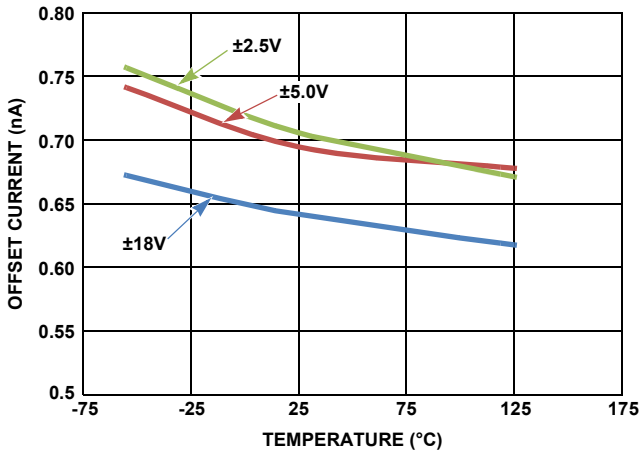

FIGURE 9. OFFSET CURRENT vs TEMPERATURE

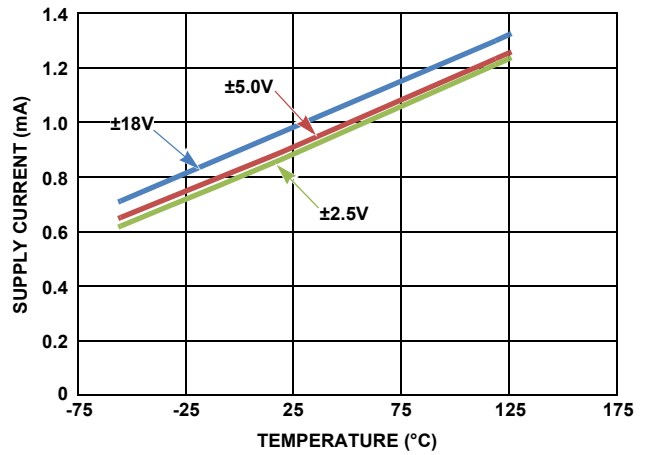

FIGURE 10. SUPPLY CURRENT vs TEMPERATURE

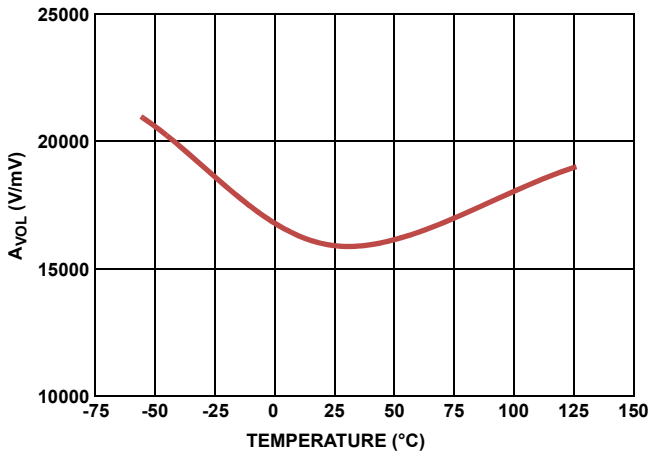

FIGURE 11. A_{VOL} vs TEMPERATURE ($V_O = \pm 13V$)

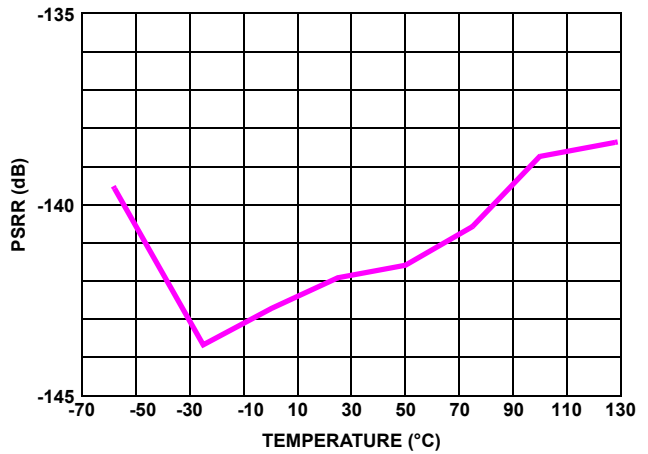

FIGURE 12. PSRR vs TEMPERATURE ($\pm 2.25V$ TO $\pm 20V$)

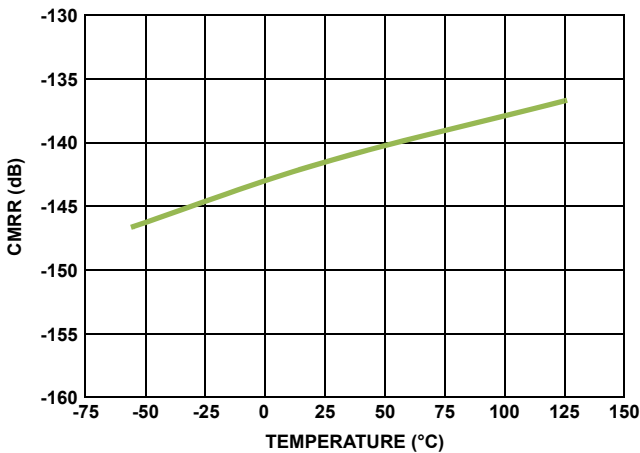

FIGURE 13. CMRR vs TEMPERATURE

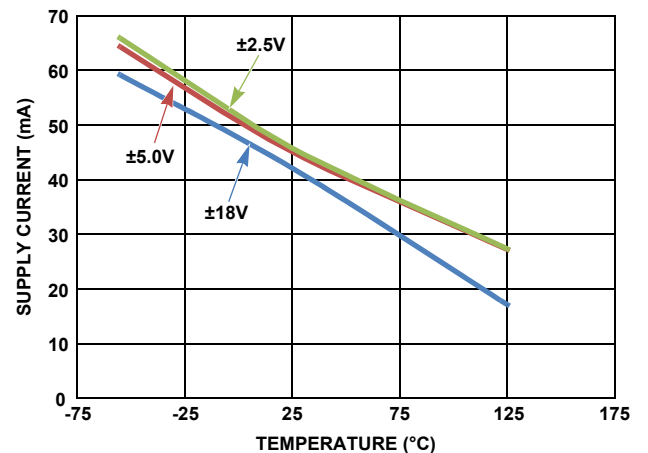

FIGURE 14. I_{SC} vs TEMPERATURE

Typical Performance Curves

Unless otherwise specified, $V_S \pm 18V$, $V_{CM} = 0$, $V_O = 0V$, $T_A = +25^\circ C$. (Continued)

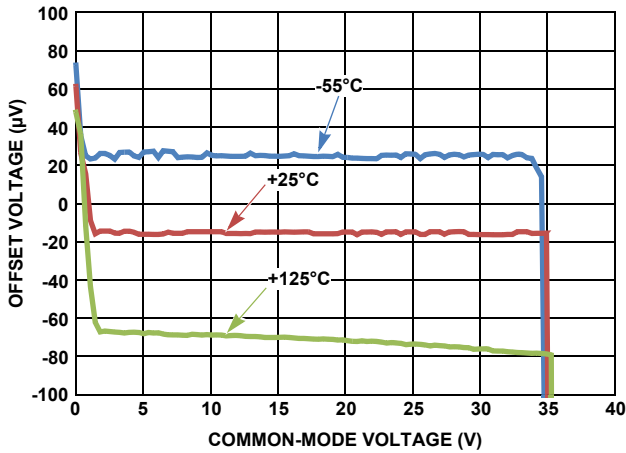

FIGURE 15. V_{OS} vs V_{CM} ($\pm 18V$)

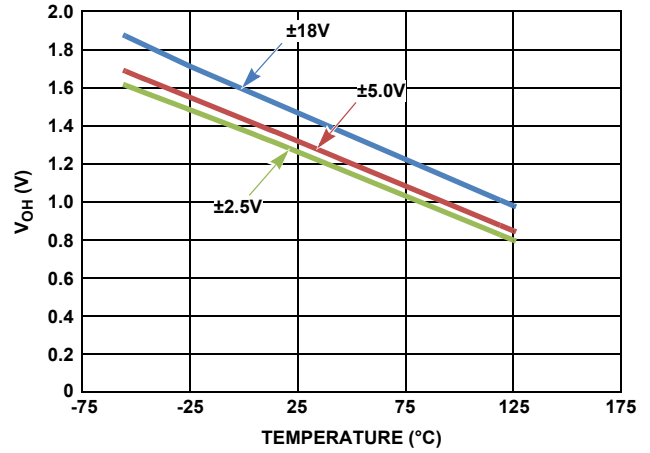

FIGURE 16. V_{OH} vs TEMPERATURE ($R_L = 2k$)

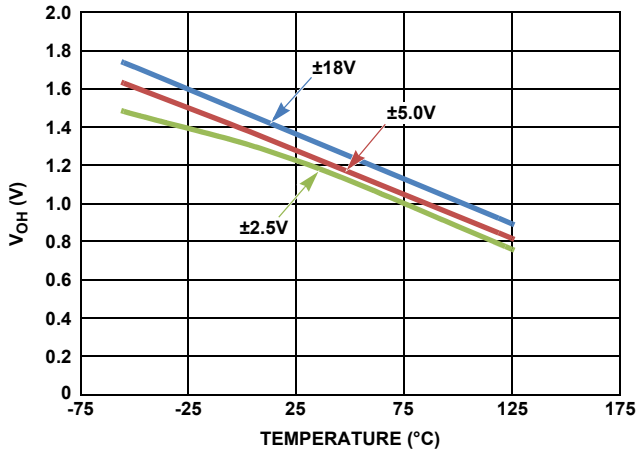

FIGURE 17. V_{OH} vs TEMPERATURE ($R_L = 5k$)

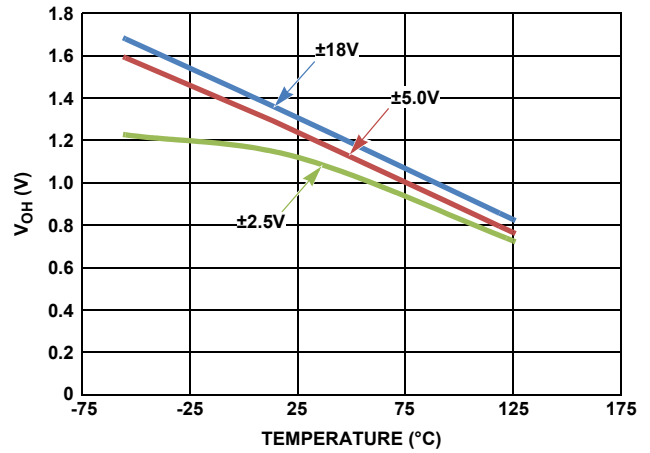

FIGURE 18. V_{OH} vs TEMPERATURE ($R_L = 10k$)

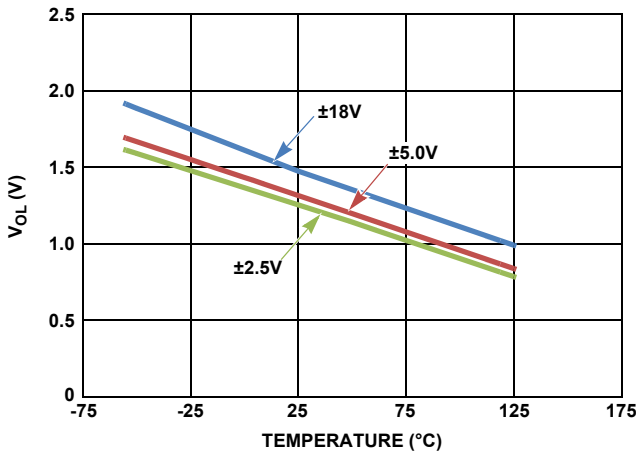

FIGURE 19. V_{OL} vs TEMPERATURE ($R_L = 2k$)

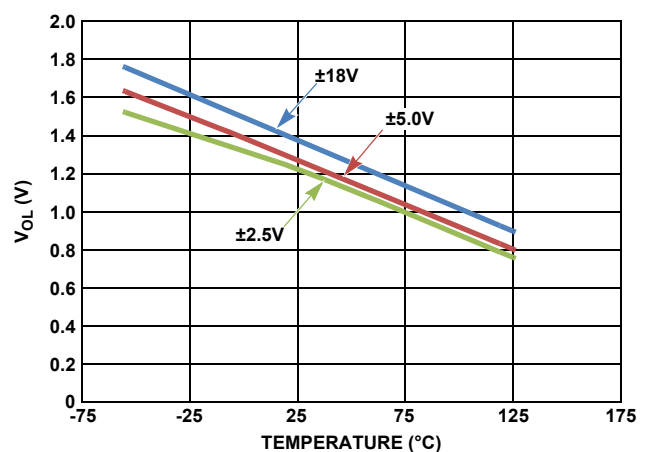

FIGURE 20. V_{OL} vs TEMPERATURE ($R_L = 5k$)

Typical Performance Curves

Unless otherwise specified, $V_S \pm 18V$, $V_{CM} = 0$, $V_O = 0V$, $T_A = +25^\circ C$. (Continued)

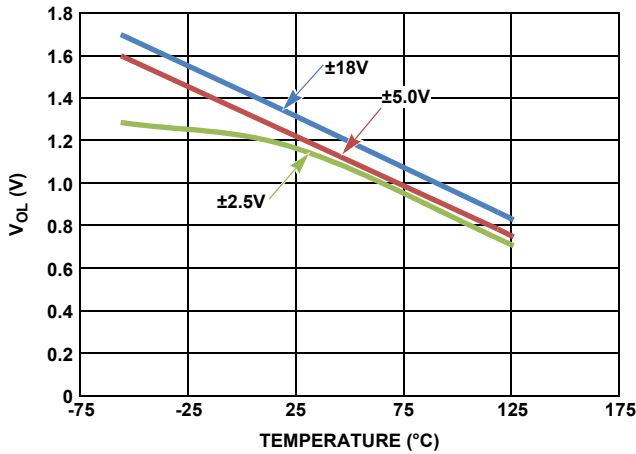

FIGURE 21. V_{OL} vs TEMPERATURE ($R_L = 10k$)

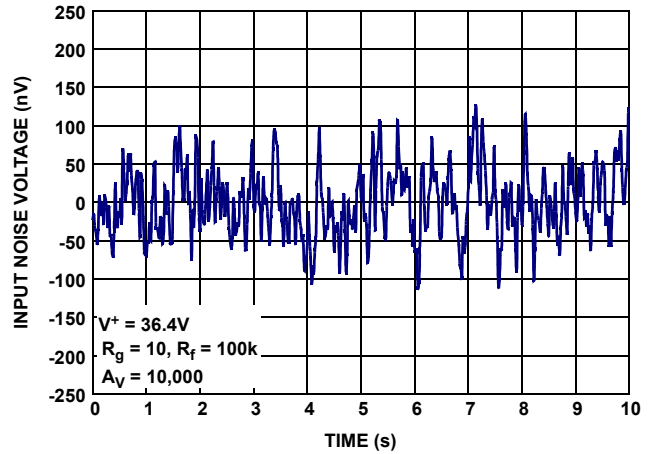

FIGURE 22. INPUT NOISE VOLTAGE (0.1Hz TO 10Hz)

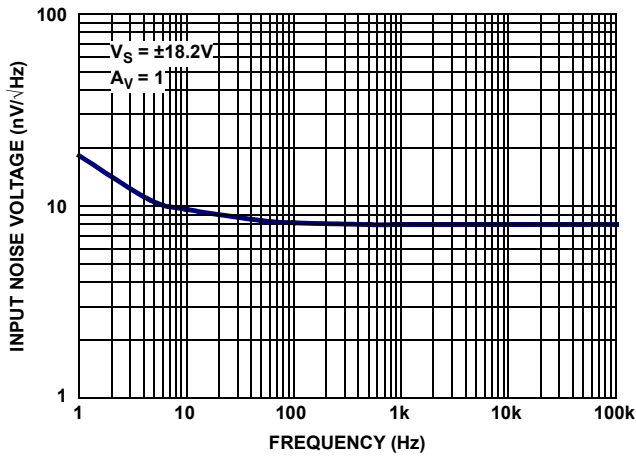

FIGURE 23. INPUT NOISE VOLTAGE SPECTRAL DENSITY

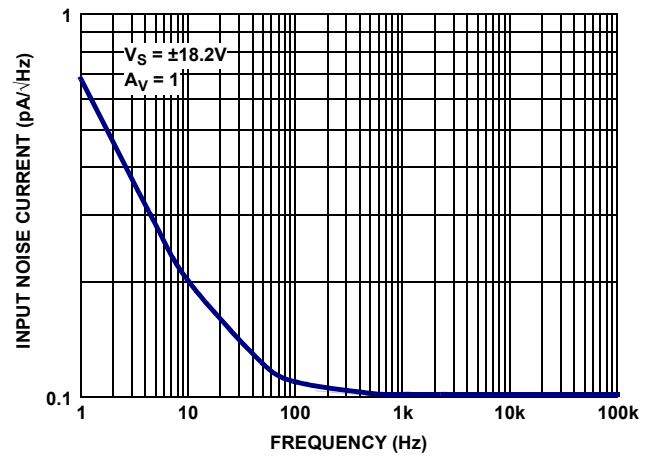

FIGURE 24. INPUT NOISE CURRENT SPECTRAL DENSITY

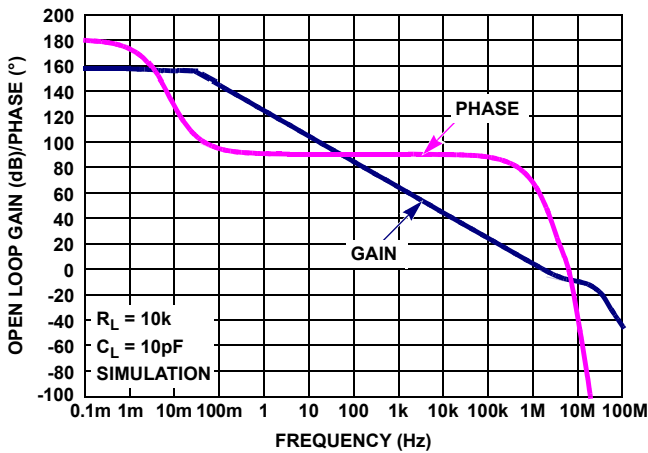

FIGURE 25. OPEN-LOOP GAIN, PHASE vs FREQUENCY ($R_L = 10k\Omega$, $C_L = 10pF$)

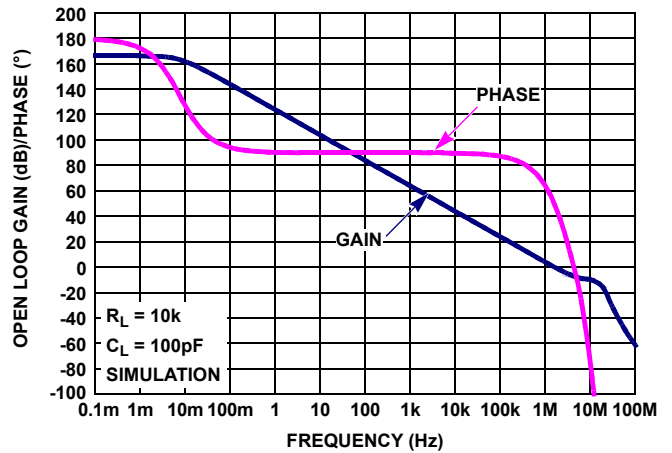

FIGURE 26. OPEN LOOP FREQUENCY RESPONSE ($R_L = 10k\Omega$, $C_L = 100pF$)

Typical Performance Curves

Unless otherwise specified, $V_S \pm 18V$, $V_{CM} = 0$, $V_O = 0V$, $T_A = +25^\circ C$. (Continued)

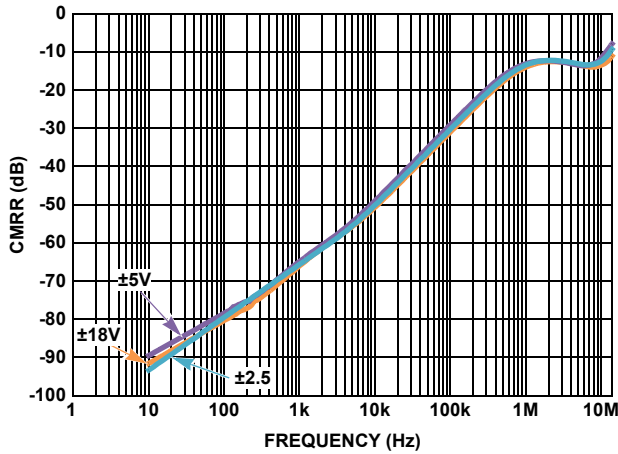

FIGURE 27. CMRR vs SUPPLY VOLTAGE (+25°C)

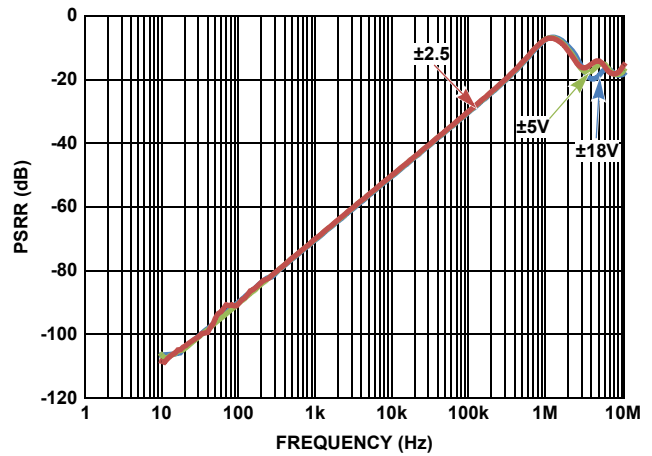

FIGURE 28. PSRR vs SUPPLY VOLTAGE (+25°C)

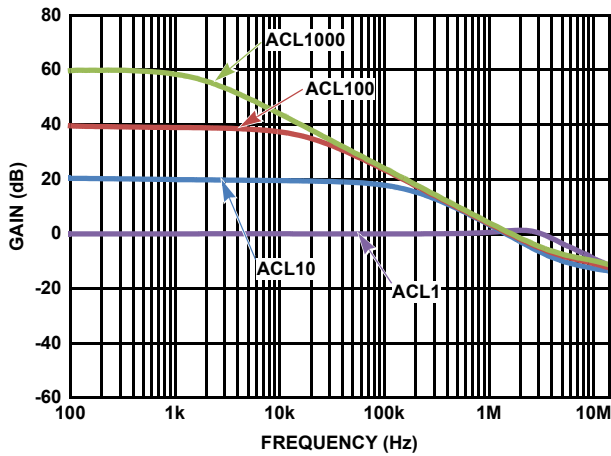

FIGURE 29. FREQUENCY RESPONSE vs ACL ($\pm 2.5V$)

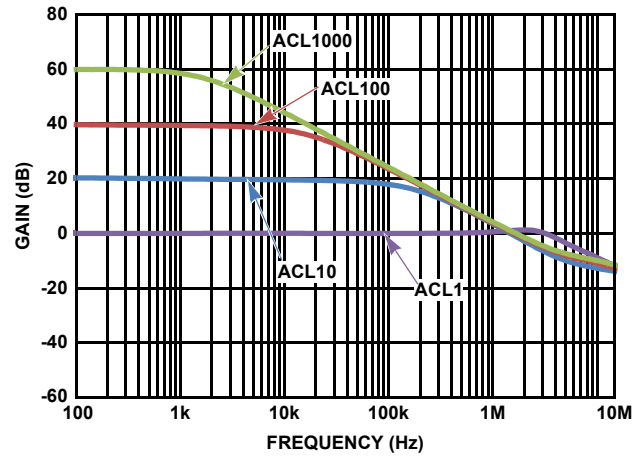

FIGURE 30. FREQUENCY RESPONSE vs ACL ($\pm 5.0V$)

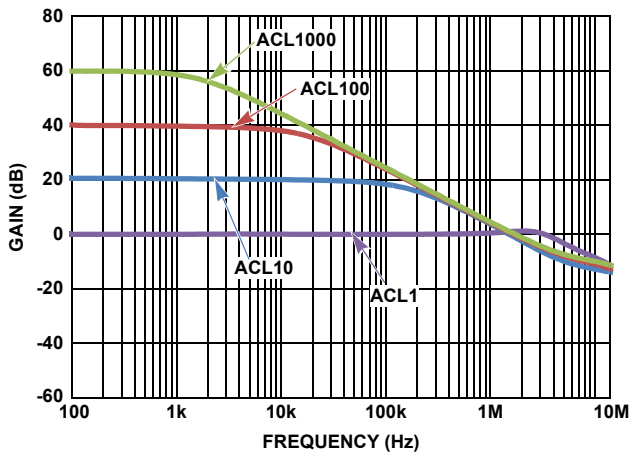

FIGURE 31. FREQUENCY RESPONSE vs ACL ($\pm 18.0V$)

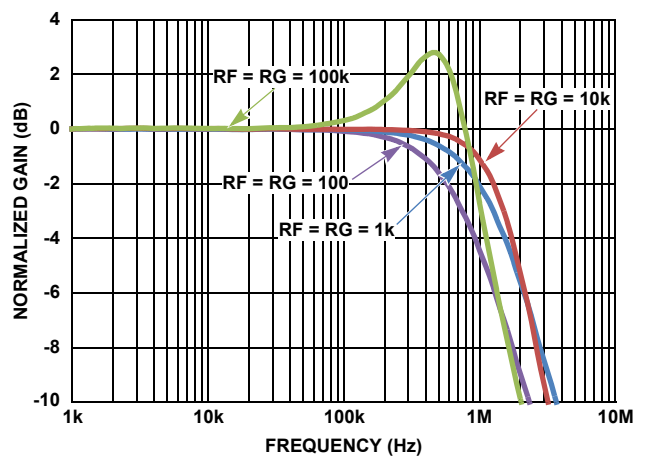

FIGURE 32. FREQUENCY RESPONSE vs FEEDBACK RESISTANCE ($\pm 2.5V$)

Typical Performance Curves

Unless otherwise specified, $V_S \pm 18V$, $V_{CM} = 0$, $V_O = 0V$, $T_A = +25^\circ C$. (Continued)

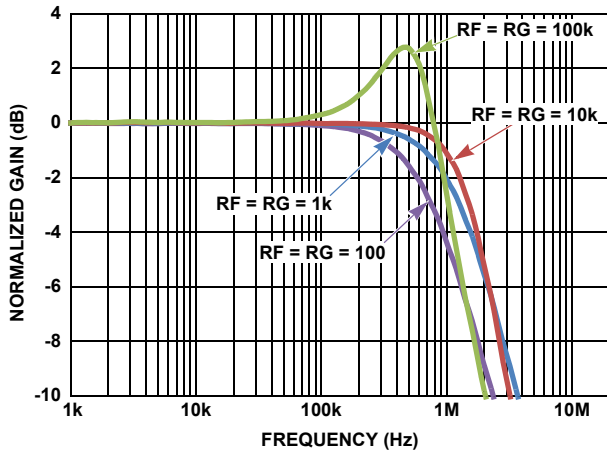

FIGURE 33. FREQUENCY RESPONSE vs FEEDBACK RESISTANCE ($\pm 5.0V$)

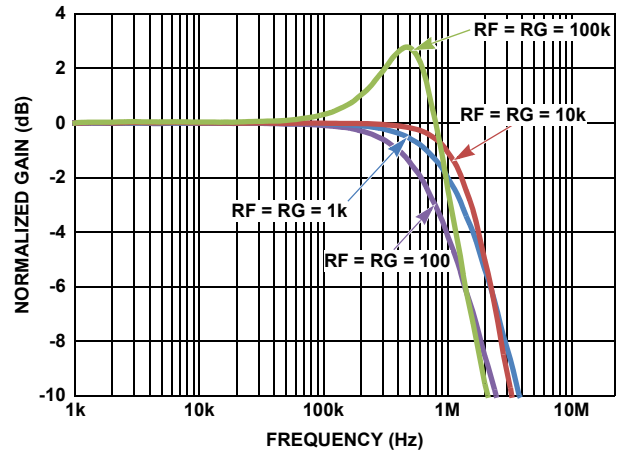

FIGURE 34. FREQUENCY RESPONSE vs FEEDBACK RESISTANCE ($\pm 18.0V$)

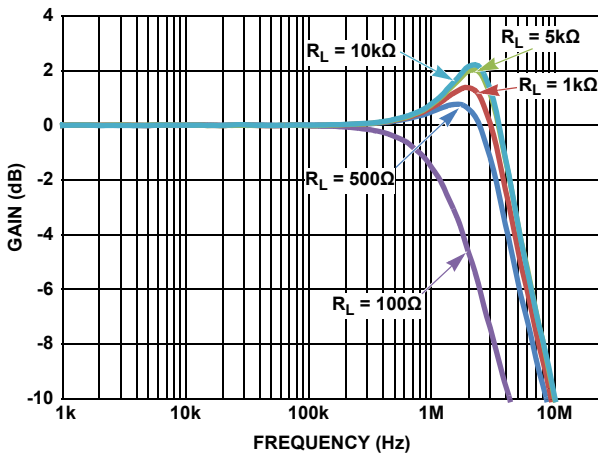

FIGURE 35. FREQUENCY RESPONSE vs R_L ($\pm 2.5V$)

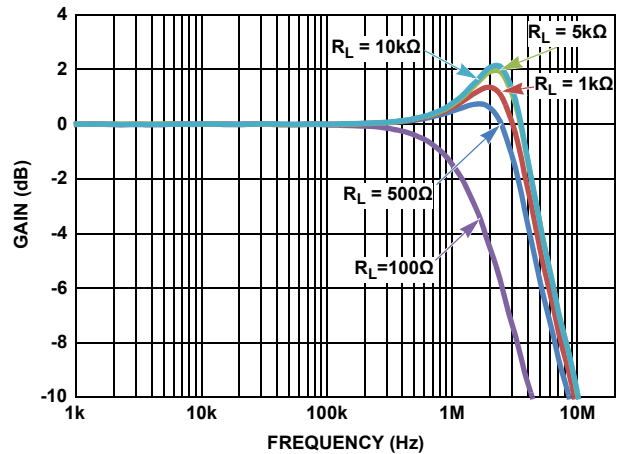

FIGURE 36. FREQUENCY RESPONSE vs R_L ($\pm 5.0V$)

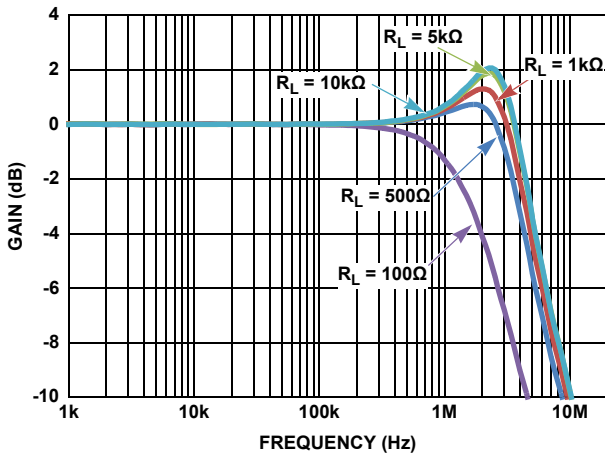

FIGURE 37. FREQUENCY RESPONSE vs R_L ($\pm 18.0V$)

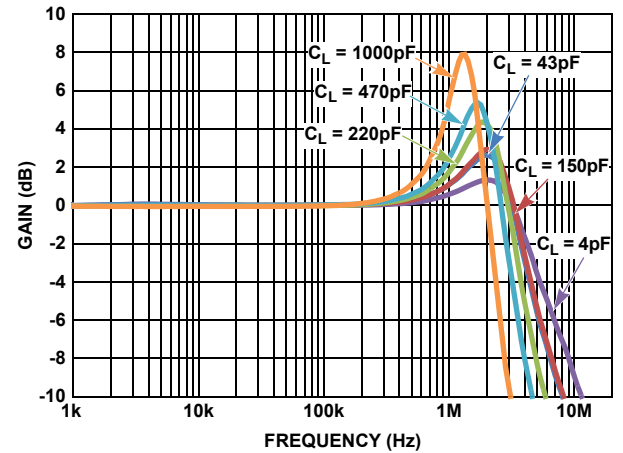

FIGURE 38. FREQUENCY RESPONSE vs C_L ($\pm 2.5V$)

Typical Performance Curves

Unless otherwise specified, $V_S \pm 18V$, $V_{CM} = 0$, $V_O = 0V$, $T_A = +25^\circ C$. (Continued)

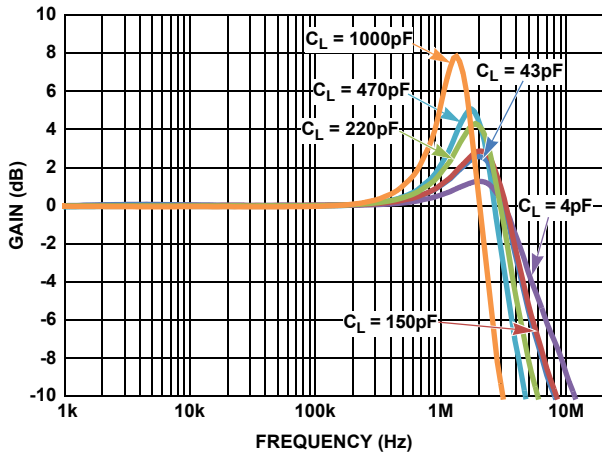

FIGURE 39. FREQUENCY RESPONSE vs C_L ($\pm 5.0V$)

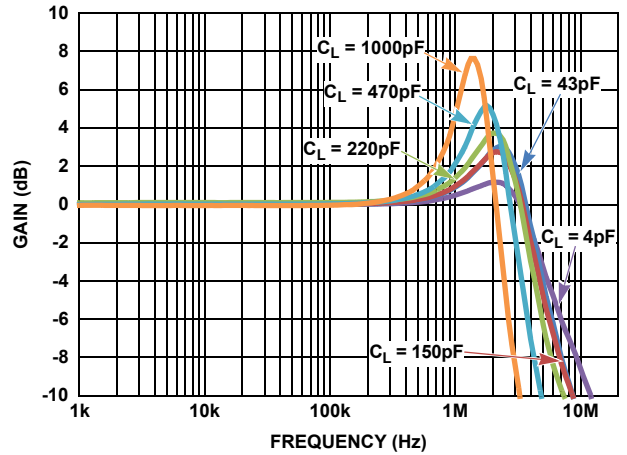

FIGURE 40. FREQUENCY RESPONSE vs C_L ($\pm 18.0V$)

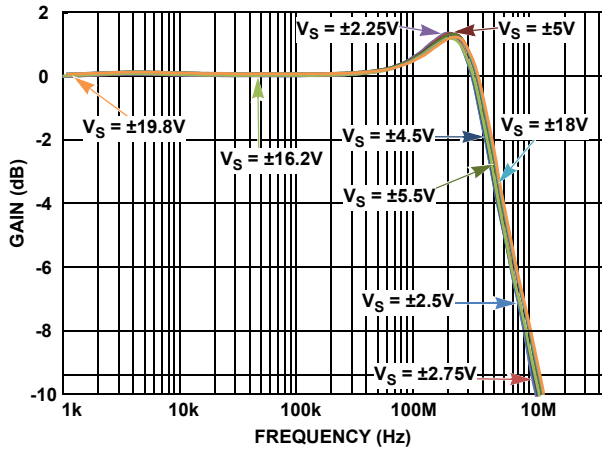

FIGURE 41. FREQUENCY RESPONSE vs SUPPLY VOLTAGE ($+25^\circ C$)

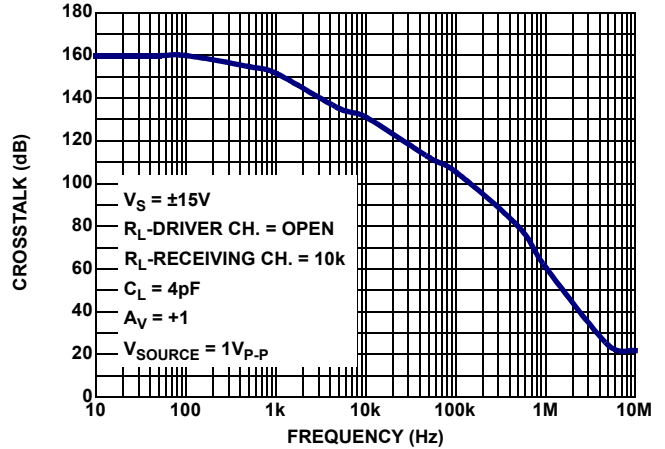

FIGURE 42. CROSSTALK ($+25^\circ C$)

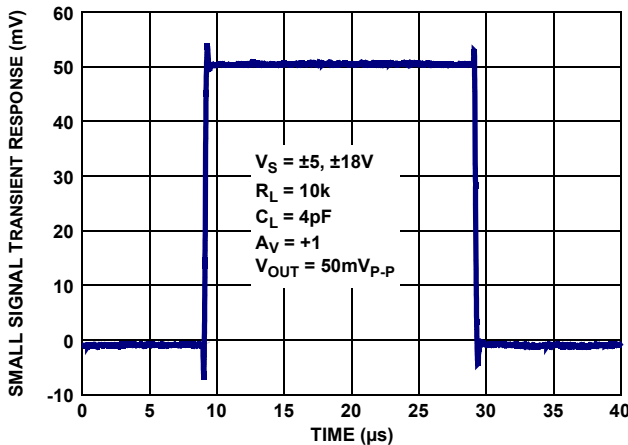

FIGURE 43. SMALL SIGNAL TRANSIENT RESPONSE ($+25^\circ C$)

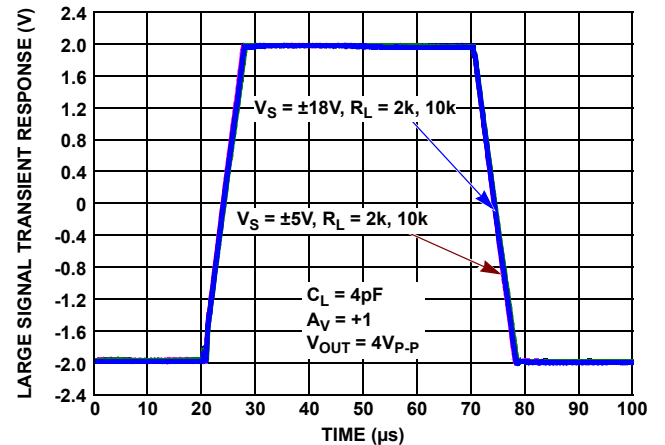

FIGURE 44. LARGE SIGNAL TRANSIENT RESPONSE ($+25^\circ C$)

Typical Performance Curves

Unless otherwise specified, $V_S \pm 18V$, $V_{CM} = 0$, $V_O = 0V$, $T_A = +25^\circ C$. (Continued)

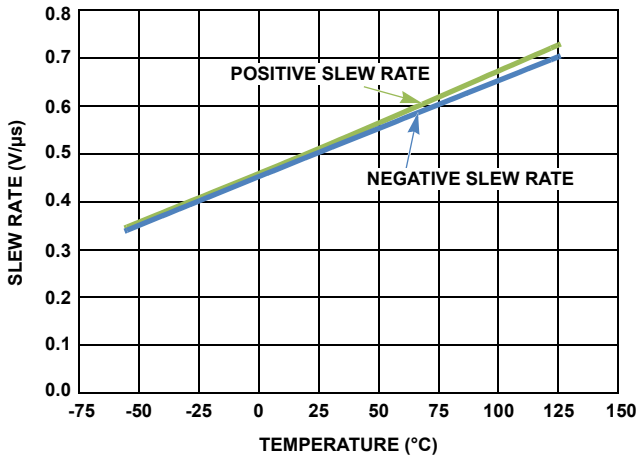

FIGURE 45. SLEW RATE vs TEMPERATURE $V_S = \pm 2.5$

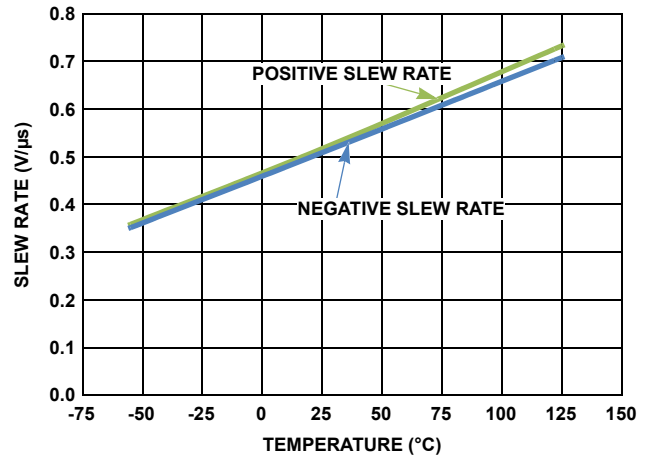

FIGURE 46. SLEW RATE vs TEMPERATURE $V_S = \pm 5V$

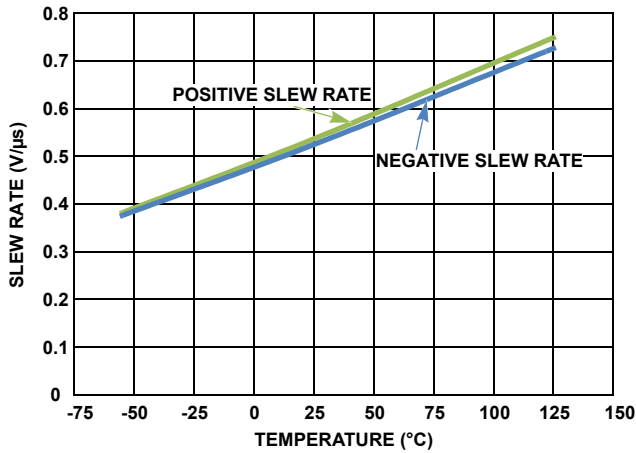

FIGURE 47. SLEW RATE vs TEMPERATURE $V_S = \pm 18V$

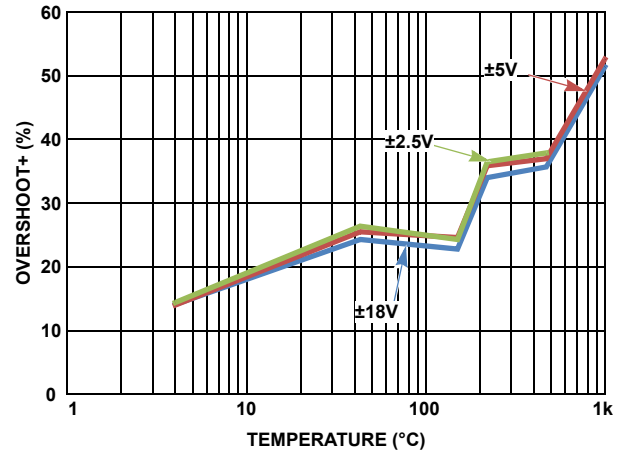

FIGURE 48. OVERSHOOT+ vs CAPACITANCE

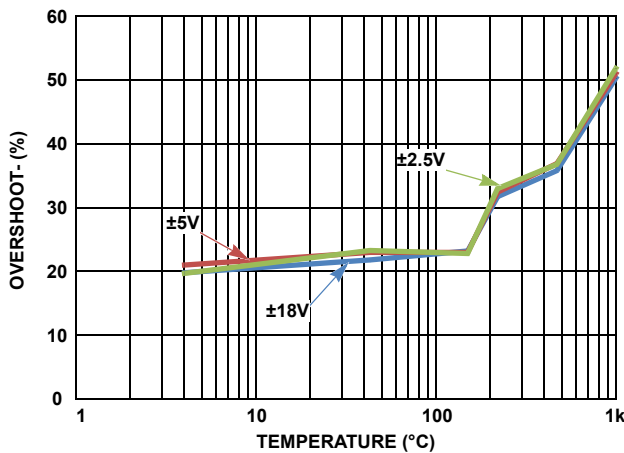

FIGURE 49. OVERSHOOT- vs CAPACITANCE

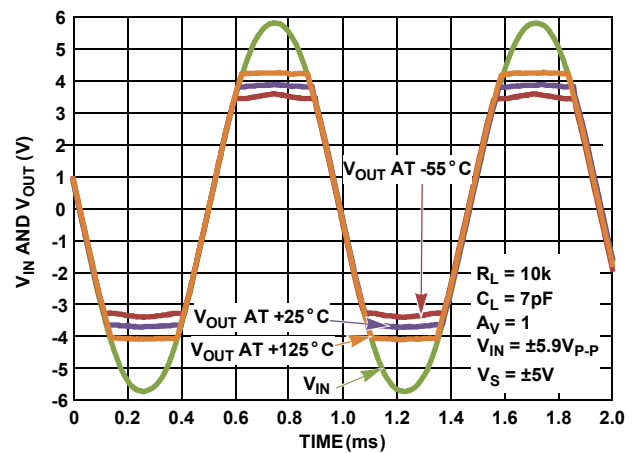

FIGURE 50. OUTPUT OVERDRIVE RESPONSE vs TEMPERATURE

Typical Performance Curves

Unless otherwise specified, $V_S \pm 18V$, $V_{CM} = 0$, $V_O = 0V$, $T_A = +25^\circ C$. (Continued)

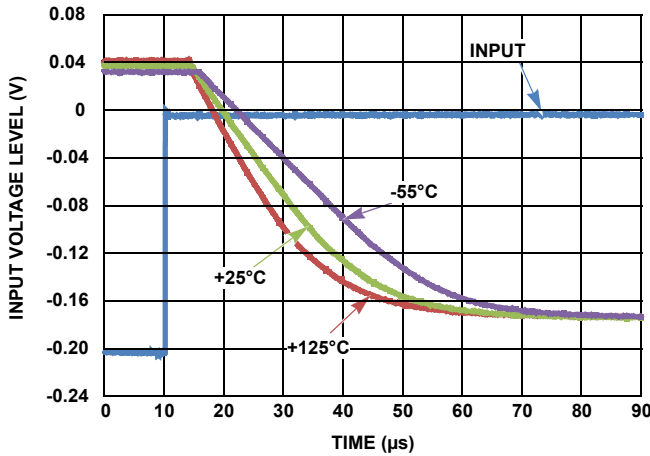

FIGURE 51. ±18V POSITIVE SATURATION RECOVERY TIME (+25°C)

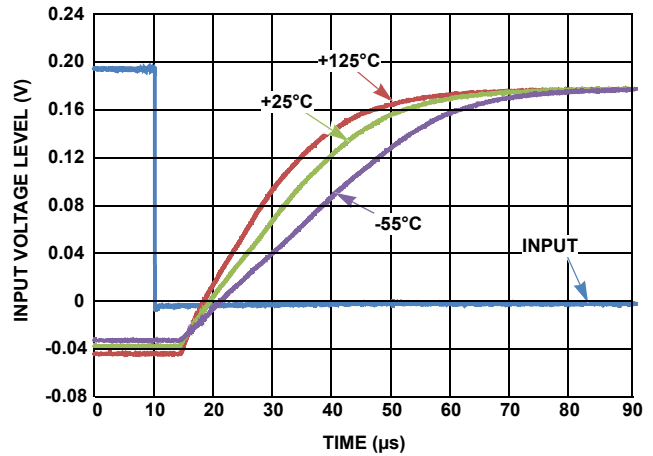

FIGURE 52. ±18V NEGATIVE SATURATION RECOVERY TIME (+25°C)

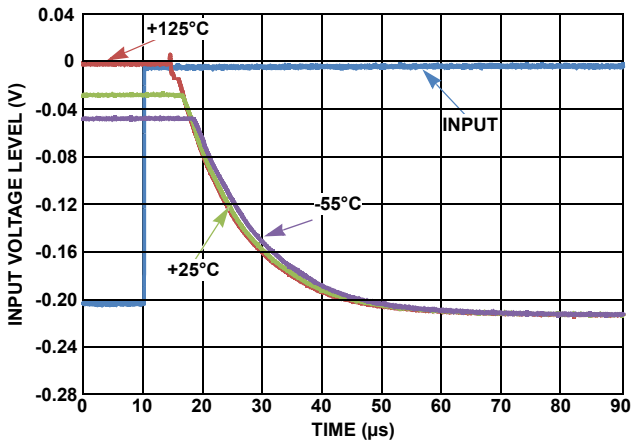

FIGURE 53. ±5V POSITIVE SATURATION RECOVERY TIME (+25°C)

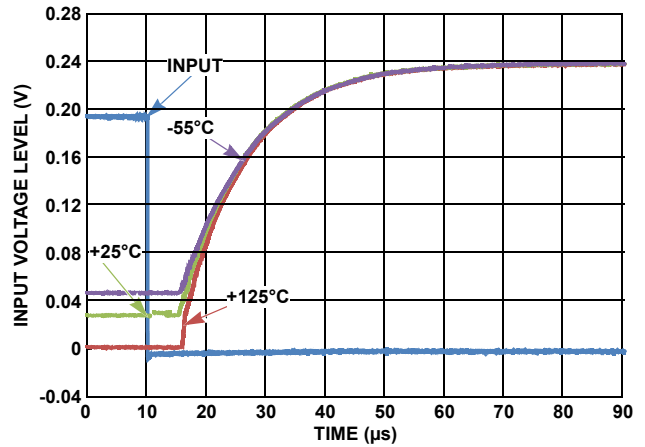

FIGURE 54. ±5V NEGATIVE SATURATION RECOVERY TIME (+25°C)

Post High Dose Rate Radiation Characteristics

Unless otherwise specified, $V_S \pm 19.8V$, $V_{CM} = 0$, $V_O = 0V$, $T_A = +25^\circ C$. This data is typical mean test data post radiation exposure at a high dose rate of 50rad(Si)/s to 300rad(Si)/s. This data is intended to show typical parameter shifts due to high dose rate radiation. These are not limits nor are they guaranteed.

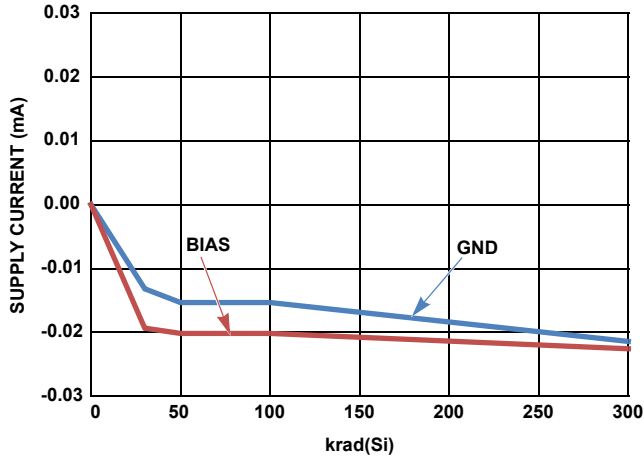

FIGURE 55. SUPPLY CURRENT SHIFT vs HDR RADIATION

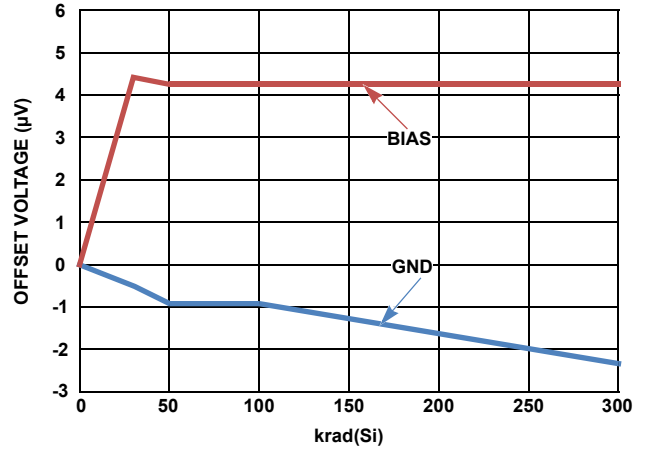

FIGURE 56. OFFSET VOLTAGE SHIFT vs HDR RADIATION

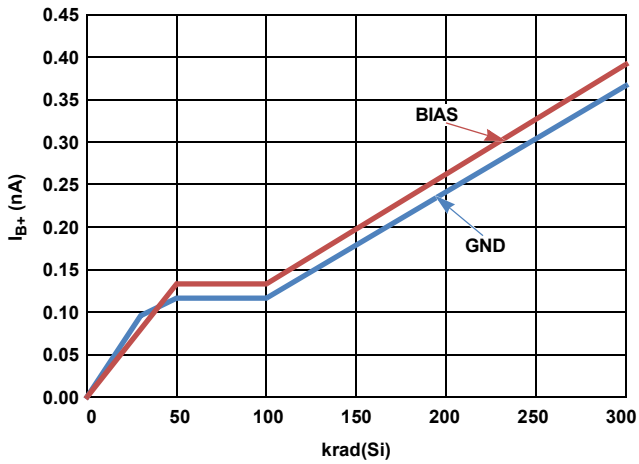

FIGURE 57. POSITIVE INPUT BIAS CURRENT SHIFT vs HDR RADIATION

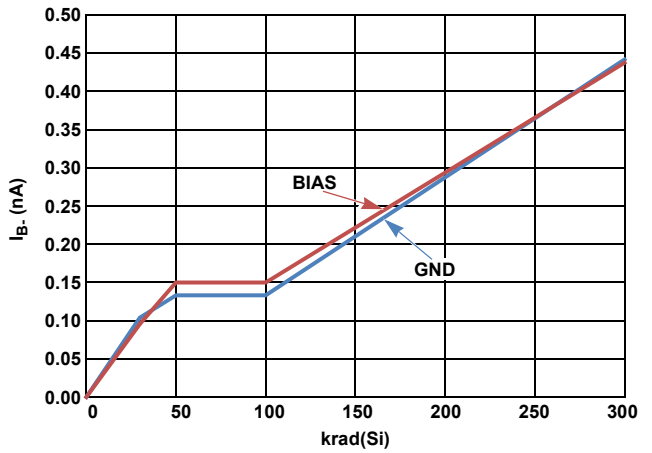

FIGURE 58. NEGATIVE INPUT BIAS CURRENT SHIFT vs HDR RADIATION

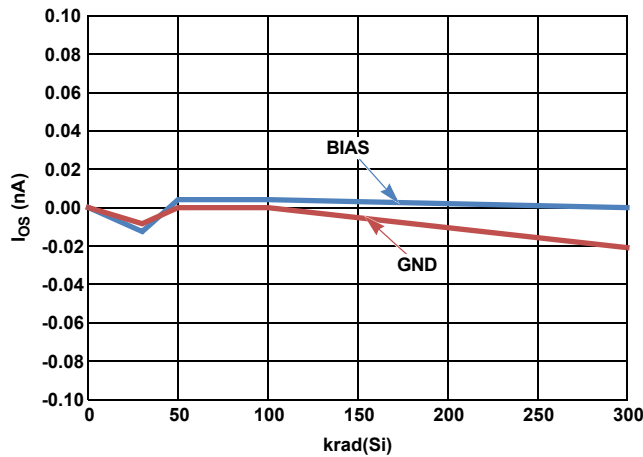

FIGURE 59. INPUT OFFSET CURRENT SHIFT vs HDR RADIATION

Post Low Dose Rate Radiation Characteristics Unless otherwise specified, $V_S \pm 19.8V$, $V_{CM} = 0$, $V_O = 0V$, $T_A = +25^\circ C$. This data is typical mean test data post radiation exposure at a low dose rate of $<10\text{mrad(Si)}/s$. This data is intended to show typical parameter shifts due to low dose rate radiation. These are not limits nor are they guaranteed.

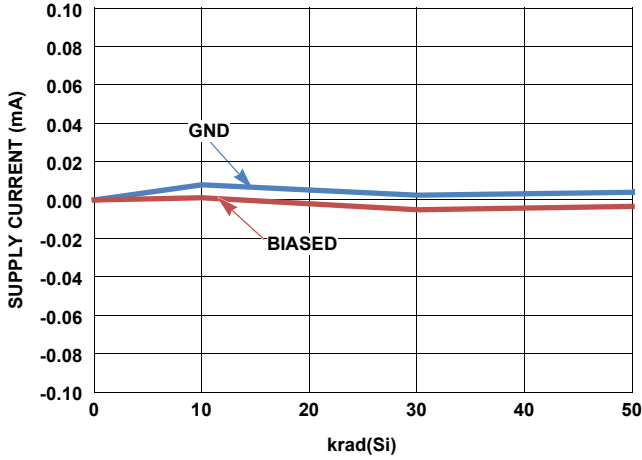

FIGURE 60. SUPPLY CURRENT SHIFT vs LDR RADIATION

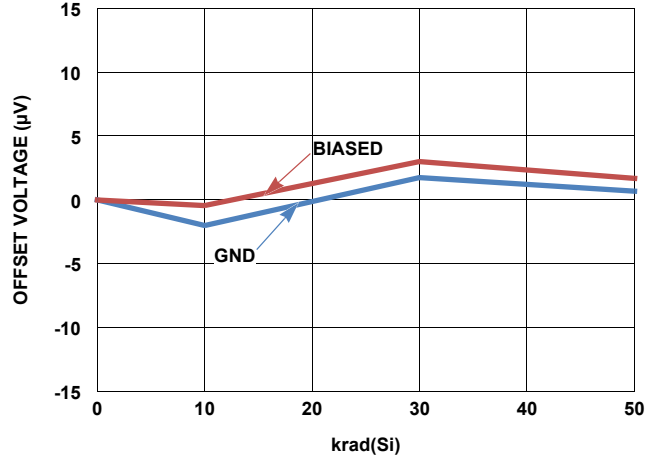

FIGURE 61. OFFSET VOLTAGE SHIFT vs LDR RADIATION

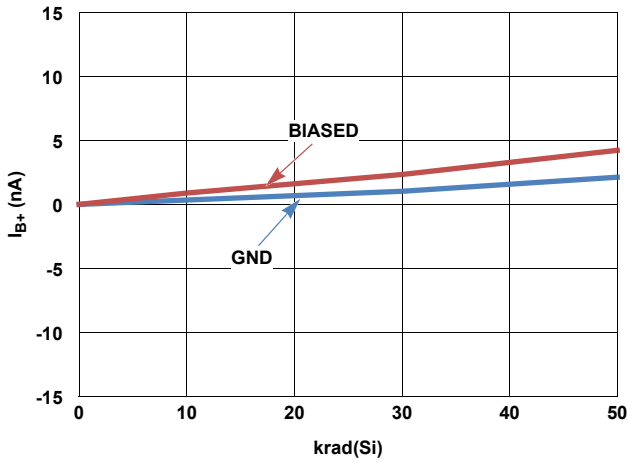

FIGURE 62. POSITIVE INPUT BIAS CURRENT SHIFT vs LDR RADIATION

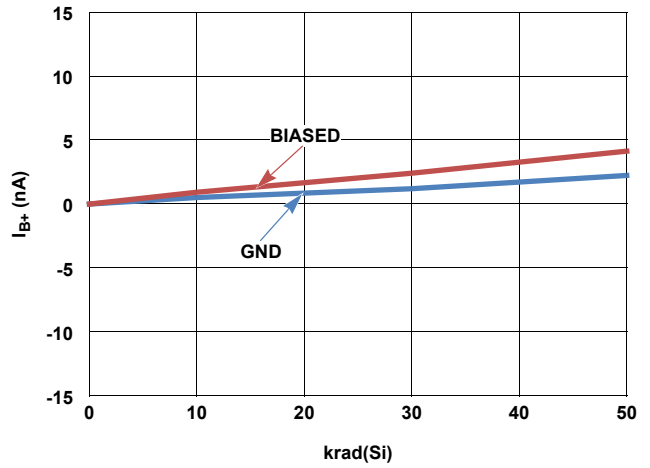

FIGURE 63. NEGATIVE INPUT BIAS CURRENT SHIFT vs LDR RADIATION

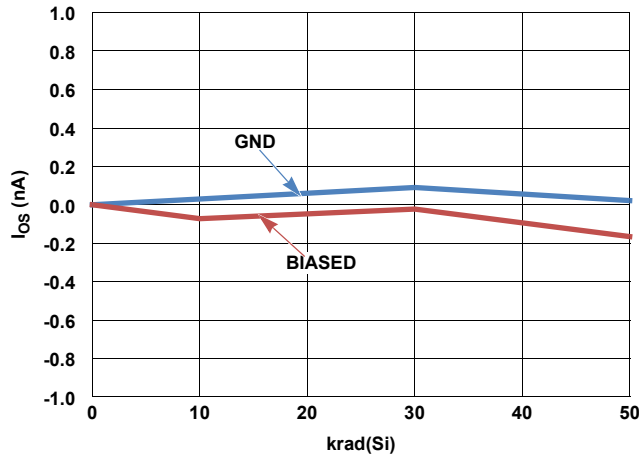

FIGURE 64. INPUT OFFSET CURRENT SHIFT vs LDR RADIATION

Applications Information

Functional Description

The ISL70219ASEH is a dual, low noise precision operational amplifier (op amp). This device is fabricated in a new precision 40V complementary bipolar DI process. A super-beta NPN input stage with input bias current cancellation provides low input bias current (180pA typical), low input offset voltage (13 μ V typical), low input noise voltage (8nV/ $\sqrt{\text{Hz}}$), and low 1/f noise corner frequency (\sim 8Hz). This amplifier also features a high open-loop gain (14kV/mV) for excellent CMRR (145dB) and THD+N performance (0.0005% at 3.5V_{RMS}, 1kHz into 2k Ω). A complementary bipolar output stage enables high capacitive load drive without external compensation.

Operating Voltage Range

The device is designed to operate across the 4.5V (\pm 2.25V) to 40V (\pm 20V) voltage range and is fully characterized at 10V (\pm 5V) and 36V (\pm 18V). The Power Supply Rejection Ratio (PSRR) typically exceeds 140dB across the full operating voltage range and 120dB minimum across the -55 $^{\circ}$ C to +125 $^{\circ}$ C temperature range. The worst case common-mode input voltage range over-temperature is 2V to each rail. With \pm 18V supplies, Common-Mode Rejection Ratio (CMRR) performance is typically >130dB over-temperature. The minimum CMRR performance across the -55 $^{\circ}$ C to +125 $^{\circ}$ C temperature range is >120dB for power supply voltages from \pm 5V (10V) to \pm 18V (36V).

Input Performance

The super-beta NPN input pair provides excellent frequency response while maintaining high input precision. High NPN beta (>1000) reduces input bias current while maintaining good frequency response, low input bias current, and low noise. Input bias cancellation circuits provide additional bias current reduction to <5nA, and excellent temperature stabilization. [Figures 6 through 8](#) show the high degree of bias current stability at \pm 5V and \pm 18V supplies that is maintained across the -55 $^{\circ}$ C to +125 $^{\circ}$ C temperature range. The low bias current TC also produces very low input offset current TC, which reduces DC input offset errors in precision, high impedance amplifiers.

The +25 $^{\circ}$ C maximum input offset voltage (V_{OS}) is 85 μ V at \pm 18V supplies. The input offset voltage temperature coefficient (V_{OSTC}) is a maximum of \pm 1.0 μ V/ $^{\circ}$ C. The V_{OS} temperature behavior is smooth ([Figures 3 through 5 on page 9](#)), maintaining constant TC across the entire temperature range.

Input ESD Diode Protection

The input terminals (IN+ and IN-) have internal ESD protection diodes to the positive and negative supply rails, series connected 500 Ω current limiting resistors, and an anti-parallel diode pair across the inputs ([Figure 65](#)).

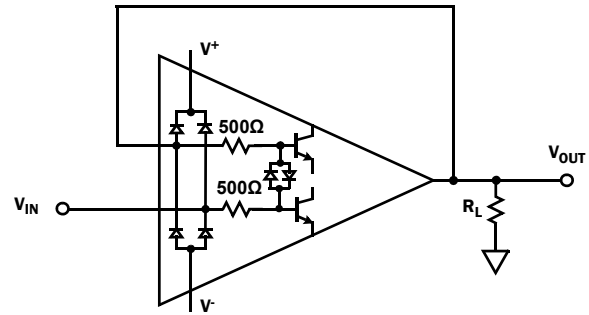

FIGURE 65. INPUT ESD DIODE CURRENT LIMITING - UNITY GAIN

The series resistors limit the high feed-through currents that can occur in pulse applications when the input dV/dt exceeds the 0.5V/ μ s slew rate of the amplifier. Without the series resistors, the input can forward-bias the anti-parallel diodes, causing current to flow to the output and resulting in severe distortion and possible diode failure.

[Figure 36 on page 14](#) provides an example of distortion free large signal response using a 4V_{P,P} input pulse with an input rise time of <1ns. The series resistors enable the input differential voltage to be equal to the maximum power supply voltage (40V) without damage.

In applications in which one or both amplifier input terminals are at risk of exposure to high voltages beyond the power supply rails, current limiting resistors may be needed at the input terminal to limit the current through the power supply ESD diodes to 20mA maximum.

Output Current Limiting

The output current is internally limited to approximately \pm 45mA at +25 $^{\circ}$ C and can withstand a short circuit to either rail as long as the power dissipation limits are not exceeded. This applies to only one amplifier at a time for the dual op amp. Continuous operation under these conditions can degrade long term reliability. [Figure 14 on page 10](#) shows the current limit variation with temperature.

Output Phase Reversal

Output phase reversal is a change of polarity in the amplifier transfer function when the input voltage exceeds the supply voltage. The ISL70219ASEH is immune to output phase reversal, even when the input voltage is 1V beyond the supplies.

Power Dissipation

It is possible to exceed the +150°C maximum junction temperature under certain load and power supply conditions. It is therefore important to calculate the maximum junction temperature (T_{JMAX}) for all applications to determine if power supply voltages, load conditions, or package type need to be modified to remain in the safe operating area. These parameters are related using [Equation 1](#):

$$T_{JMAX} = T_{MAX} + \theta_{JA} \times PD_{MAXTOTAL} \quad (EQ. 1)$$

where:

- $PD_{MAXTOTAL}$ is the sum of the maximum power dissipation of each amplifier in the package (PD_{MAX})
- PD_{MAX} for each amplifier can be calculated using [Equation 2](#):

$$PD_{MAX} = V_S \times I_{qMAX} + (V_S - V_{OUTMAX}) \times \frac{V_{OUTMAX}}{R_L} \quad (EQ. 2)$$

where:

- T_{MAX} = Maximum ambient temperature
- θ_{JA} = Thermal resistance of the package
- PD_{MAX} = Maximum power dissipation of one amplifier
- V_S = Total supply voltage
- I_{qMAX} = Maximum quiescent supply current of one amplifier
- V_{OUTMAX} = Maximum output voltage swing of the application

TABLE 1. ISL70219ASEH DIE LAYOUT X-Y COORDINATES

| PAD NAME | PAD NUMBER | X (μm) | Y (μm) | dX (μm) | dY (μm) | BOND WIRES PER PAD |
|----------|------------|--------|--------|---------|---------|--------------------|
| OUTB | 1 | 2195.0 | 1418.0 | 70 | 70 | 1 |
| V+ | 2 | 2195.0 | 2510.0 | 70 | 70 | 1 |
| OUTA | 3 | 709.0 | 2727.0 | 70 | 70 | 1 |
| -INA | 4 | 339.0 | 2727.0 | 70 | 70 | 1 |
| +INA | 5 | 114.0 | 2510.0 | 70 | 70 | 1 |
| V- | 6 | 114.0 | 336.0 | 70 | 70 | 1 |
| +INB | 7 | 2195.0 | 336.0 | 70 | 70 | 1 |
| -INB | 8 | 1970.0 | 110.0 | 70 | 70 | 1 |

NOTE:

- Origin of coordinates is the bottom left corner of the die.

Die Characteristics

Die Dimensions

2406µm x 2935µm (95 mils x 116 mils)
 Thickness: 483µm ± 25µm (19 mils ±1 mil)

Interface Materials

GLASSIVATION

Type: Silicon Nitride/Silicon Dioxide Sandwich
 Thickness: 15kÅ

TOP METALLIZATION

Type: AlCu (99.5%/0.5%)
 Thickness: 30kÅ

BACKSIDE FINISH

Silicon

PROCESS

PR40 (DI)

Assembly Related Information

SUBSTRATE POTENTIAL

Floating

Additional Information

WORST CASE CURRENT DENSITY

< 2 x 10⁵ A/cm²

TRANSISTOR COUNT

466

Weight of Packaged Device

0.3958 grams (typical)

Lid Characteristics

Finish: Gold

Potential: Unbiased, tied to package Pin 6

Case Isolation to Any Lead: 20 x 10⁹Ω (minimum)

Metallization Mask Layout

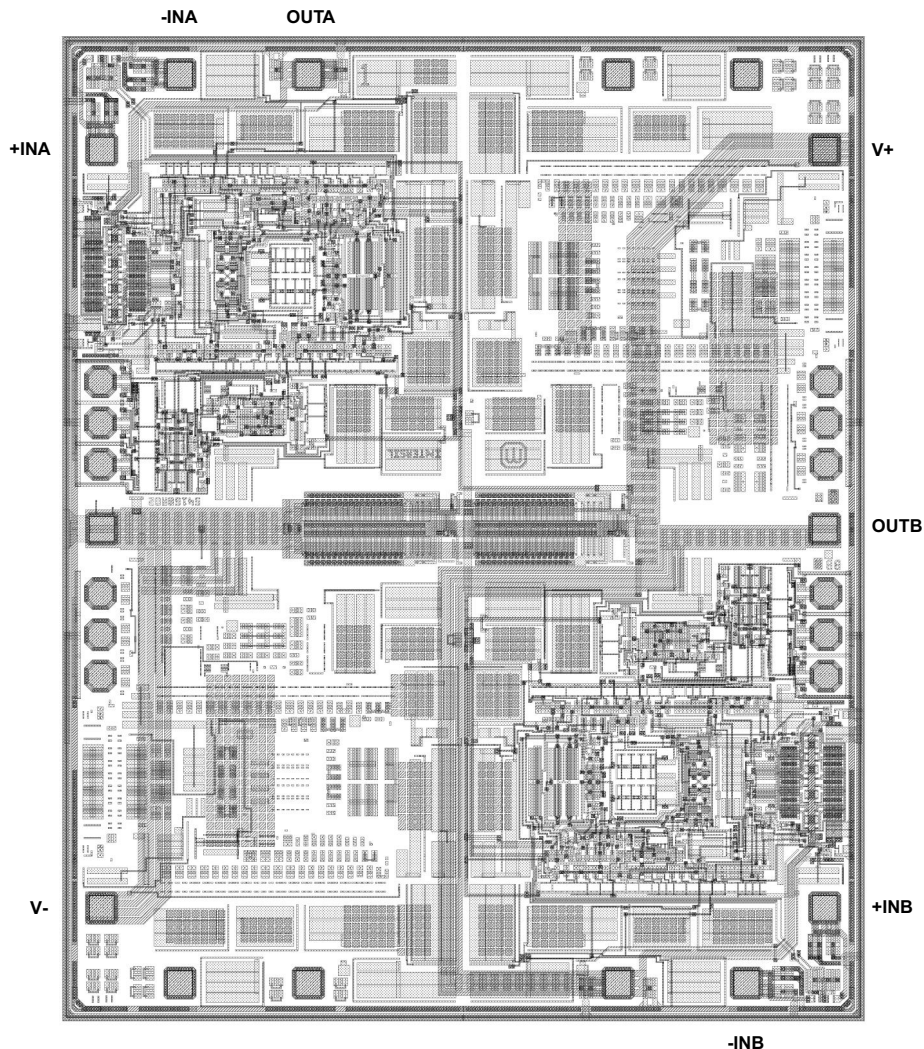

Revision History The revision history provided is for informational purposes only and is believed to be accurate, but not warranted. Please visit our website to make sure that you have the latest revision.

| DATE | REVISION | CHANGE |
|--------------|----------|---|
| Jan 10, 2020 | FN8459.3 | Updated links throughout. Removed E-pad pin description. Added Note 3 and updated Note 4. Updated Figures 60 through 64 on page 19. Updated disclaimer. |
| Jun 11, 2018 | FN8459.2 | Removed references to ISL70419ASEH pins in Pin Description section on page 2. Added Notes 3 and 4 to Ordering Information on page 3. Removed About Intersil section and updated disclaimer. |
| Nov 11, 2016 | FN8459.1 | Removed references to ISL70419ASEH. Updated Related Literature section. |
| Oct 27, 2014 | FN8459.0 | Initial Release. |

Package Outline Drawing

For the most recent package outline drawing, see [K10.A](#).

K10.A MIL-STD-1835 CDFP3-F10 (F-4A, CONFIGURATION B)
10 LEAD CERAMIC METAL SEAL FLATPACK PACKAGE

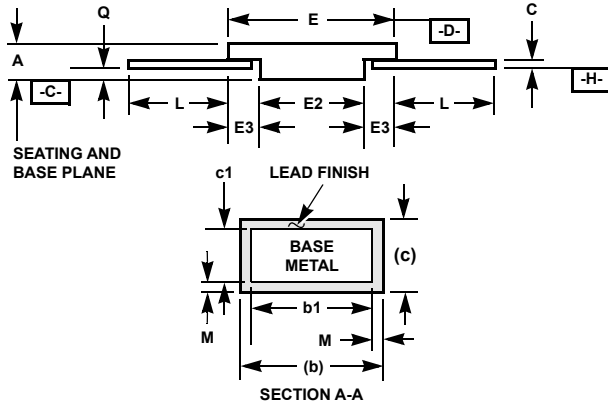
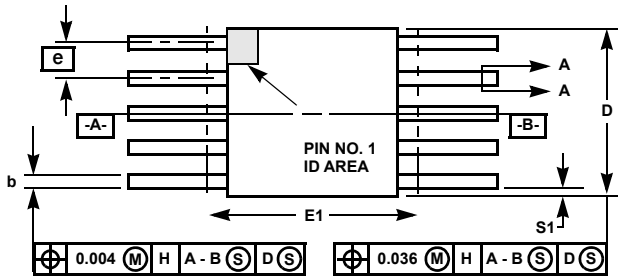

| SYMBOL | INCHES | | MILLIMETERS | | NOTES |
|--------|-----------|--------|-------------|------|-------|
| | MIN | MAX | MIN | MAX | |
| A | 0.045 | 0.115 | 1.14 | 2.92 | - |
| b | 0.015 | 0.022 | 0.38 | 0.56 | - |
| b1 | 0.015 | 0.019 | 0.38 | 0.48 | - |
| c | 0.004 | 0.009 | 0.10 | 0.23 | - |
| c1 | 0.004 | 0.006 | 0.10 | 0.15 | - |
| D | - | 0.290 | - | 7.37 | 3 |
| E | 0.240 | 0.260 | 6.10 | 6.60 | - |
| E1 | - | 0.280 | - | 7.11 | 3 |
| E2 | 0.125 | - | 3.18 | - | - |
| E3 | 0.030 | - | 0.76 | - | 7 |
| e | 0.050 BSC | | 1.27 BSC | | - |
| k | 0.008 | 0.015 | 0.20 | 0.38 | 2 |
| L | 0.250 | 0.370 | 6.35 | 9.40 | - |
| Q | 0.026 | 0.045 | 0.66 | 1.14 | 8 |
| S1 | 0.005 | - | 0.13 | - | 6 |
| M | - | 0.0015 | - | 0.04 | - |
| N | 10 | | 10 | | - |

Rev. 0 3/07

NOTES:

1. Index area: A notch or a pin one identification mark shall be located adjacent to pin one and shall be located within the shaded area shown. The manufacturer's identification shall not be used as a pin one identification mark. Alternately, a tab (dimension k) may be used to identify pin one.
2. If a pin one identification mark is used in addition to a tab, the limits of dimension k do not apply.
3. This dimension allows for off-center lid, meniscus, and glass over-run.
4. Dimensions b1 and c1 apply to lead base metal only. Dimension M applies to lead plating and finish thickness. The maximum limits of lead dimensions b and c or M shall be measured at the centroid of the finished lead surfaces, when solder dip or tin plate lead finish is applied.
5. N is the maximum number of terminal positions.
6. Measure dimension S1 at all four corners.
7. For bottom-brazed lead packages, no organic or polymeric materials shall be molded to the bottom of the package to cover the leads.
8. Dimension Q shall be measured at the point of exit (beyond the meniscus) of the lead from the body. Dimension Q minimum shall be reduced by 0.0015 inch (0.038mm) maximum when solder dip lead finish is applied.
9. Dimensioning and tolerancing per ANSI Y14.5M - 1982.
10. Controlling dimension: INCH.

Notice

1. Descriptions of circuits, software and other related information in this document are provided only to illustrate the operation of semiconductor products and application examples. You are fully responsible for the incorporation or any other use of the circuits, software, and information in the design of your product or system. Renesas Electronics disclaims any and all liability for any losses and damages incurred by you or third parties arising from the use of these circuits, software, or information.
 2. Renesas Electronics hereby expressly disclaims any warranties against and liability for infringement or any other claims involving patents, copyrights, or other intellectual property rights of third parties, by or arising from the use of Renesas Electronics products or technical information described in this document, including but not limited to, the product data, drawings, charts, programs, algorithms, and application examples.
 3. No license, express, implied or otherwise, is granted hereby under any patents, copyrights or other intellectual property rights of Renesas Electronics or others.
 4. You shall not alter, modify, copy, or reverse engineer any Renesas Electronics product, whether in whole or in part. Renesas Electronics disclaims any and all liability for any losses or damages incurred by you or third parties arising from such alteration, modification, copying or reverse engineering.
 5. Renesas Electronics products are classified according to the following two quality grades: "Standard" and "High Quality". The intended applications for each Renesas Electronics product depends on the product's quality grade, as indicated below.
 - "Standard": Computers; office equipment; communications equipment; test and measurement equipment; audio and visual equipment; home electronic appliances; machine tools; personal electronic equipment; industrial robots; etc.
 - "High Quality": Transportation equipment (automobiles, trains, ships, etc.); traffic control (traffic lights); large-scale communication equipment; key financial terminal systems; safety control equipment; etc.Unless expressly designated as a high reliability product or a product for harsh environments in a Renesas Electronics data sheet or other Renesas Electronics document, Renesas Electronics products are not intended or authorized for use in products or systems that may pose a direct threat to human life or bodily injury (artificial life support devices or systems; surgical implantations; etc.), or may cause serious property damage (space system; undersea repeaters; nuclear power control systems; aircraft control systems; key plant systems; military equipment; etc.). Renesas Electronics disclaims any and all liability for any damages or losses incurred by you or any third parties arising from the use of any Renesas Electronics product that is inconsistent with any Renesas Electronics data sheet, user's manual or other Renesas Electronics document.
 6. When using Renesas Electronics products, refer to the latest product information (data sheets, user's manuals, application notes, "General Notes for Handling and Using Semiconductor Devices" in the reliability handbook, etc.), and ensure that usage conditions are within the ranges specified by Renesas Electronics with respect to maximum ratings, operating power supply voltage range, heat dissipation characteristics, installation, etc. Renesas Electronics disclaims any and all liability for any malfunctions, failure or accident arising out of the use of Renesas Electronics products outside of such specified ranges.
 7. Although Renesas Electronics endeavors to improve the quality and reliability of Renesas Electronics products, semiconductor products have specific characteristics, such as the occurrence of failure at a certain rate and malfunctions under certain use conditions. Unless designated as a high reliability product or a product for harsh environments in a Renesas Electronics data sheet or other Renesas Electronics document, Renesas Electronics products are not subject to radiation resistance design. You are responsible for implementing safety measures to guard against the possibility of bodily injury, injury or damage caused by fire, and/or danger to the public in the event of a failure or malfunction of Renesas Electronics products, such as safety design for hardware and software, including but not limited to redundancy, fire control and malfunction prevention, appropriate treatment for aging degradation or any other appropriate measures. Because the evaluation of microcomputer software alone is very difficult and impractical, you are responsible for evaluating the safety of the final products or systems manufactured by you.
 8. Please contact a Renesas Electronics sales office for details as to environmental matters such as the environmental compatibility of each Renesas Electronics product. You are responsible for carefully and sufficiently investigating applicable laws and regulations that regulate the inclusion or use of controlled substances, including without limitation, the EU RoHS Directive, and using Renesas Electronics products in compliance with all these applicable laws and regulations. Renesas Electronics disclaims any and all liability for damages or losses occurring as a result of your noncompliance with applicable laws and regulations.
 9. Renesas Electronics products and technologies shall not be used for or incorporated into any products or systems whose manufacture, use, or sale is prohibited under any applicable domestic or foreign laws or regulations. You shall comply with any applicable export control laws and regulations promulgated and administered by the governments of any countries asserting jurisdiction over the parties or transactions.
 10. It is the responsibility of the buyer or distributor of Renesas Electronics products, or any other party who distributes, disposes of, or otherwise sells or transfers the product to a third party, to notify such third party in advance of the contents and conditions set forth in this document.
 11. This document shall not be reprinted, reproduced or duplicated in any form, in whole or in part, without prior written consent of Renesas Electronics.
 12. Please contact a Renesas Electronics sales office if you have any questions regarding the information contained in this document or Renesas Electronics products.
- (Note1) "Renesas Electronics" as used in this document means Renesas Electronics Corporation and also includes its directly or indirectly controlled subsidiaries.
- (Note2) "Renesas Electronics product(s)" means any product developed or manufactured by or for Renesas Electronics.

(Rev.4.0-1 November 2017)

Corporate Headquarters

TOYOSU FORESIA, 3-2-24 Toyosu,
Koto-ku, Tokyo 135-0061, Japan
www.renesas.com

Contact Information

For further information on a product, technology, the most up-to-date version of a document, or your nearest sales office, please visit:
www.renesas.com/contact/

Trademarks

Renesas and the Renesas logo are trademarks of Renesas Electronics Corporation. All trademarks and registered trademarks are the property of their respective owners.