



Total dose testing of the ISL706ARH radiation hardened microprocessor supervisory circuit

Nick van Vonno
Intersil Corporation

Revision 1
February 2012

Table of Contents

- 1. Introduction**
- 2. Reference Documents**
- 3. Part Description**
- 4. Test Description**
 - 4.1 Irradiation facility**
 - 4.2 Test fixturing**
 - 4.3 Characterization equipment and procedures**
 - 4.4 Experimental Matrix**
 - 4.5 Downpoints**
- 5 Results**
 - 5.1 Results and conclusions**
 - 5.2 Variables data**
- 6 Appendices**
 - 6.1 Reported parameters**
- 7 Document revision history**

1. Introduction

This document reports the results of a low and high dose rate total dose test of the ISL706ARH microprocessor supervisory circuit. The test was conducted in order to determine the sensitivity of the part to the total dose environment and to determine if dose rate and bias sensitivity exist.

Intersil markets six versions of the ISL706*RH (ISL706A/B/C) with the differences being limited to the operation of the reset pin (active high, active low, and active low open drain output). These are minor functional difference and the total dose data for the ISL706ARH applies to the other versions. The base ISL706*RH is acceptance tested on a wafer by wafer basis to 100 krad(Si) at high dose rate, as defined in MIL-STD-883 test method 1019 (50 – 300 rad(Si)/s). The ISL706*EH is acceptance tested on a wafer by wafer basis to 100 krad(Si) at high dose rate, as defined in MIL-STD-883 test method 1019 (50 – 300 rad(Si)/s), and to 50 krad(Si) at low dose rate, also as defined in method 1019 (0.01 rad(Si)/s maximum). The ISL706*RH and ISL706*EH are identical parts.

These total dose test results are intended to apply to the following devices:

ISL706ARH and ISL706AEH - Reset pin is an active high

ISL706BRH and ISL706BEH - Reset pin is an active low

ISL706CRH and ISL706CEH - Reset pin is an active low open drain output

2. Reference Documents

MIL-STD-883H test method 1019.8

ISL706ARH data sheet

DLA Standard Microcircuit Drawing (SMD) 5962-11213

3: Part Description

The ISL706ARH is a radiation hardened 3.3V supervisory circuit that reduces the complexity required to monitor supply voltages in microprocessor systems. The device significantly improves accuracy and reliability relative to discrete solutions. Each IC provides four key functions:

1. A reset output during power-up, power-down, and brownout conditions.
2. An independent watchdog output that goes low if the watchdog input has not been toggled within 1.6s.
3. A precision threshold detector for monitoring a power supply other than VDD.
4. An active-low manual-reset input.

The ISL706ARH has been specifically designed and manufactured to provide reliable performance in harsh radiation environments. It is total dose hardened to 100krad(Si) at high dose rate and offers guaranteed performance over the full -55°C to +125°C military temperature range.

Specifications for radiation hardened QML devices are controlled by the Defense Logistics Agency (Land and Maritime) in Columbus, OH (DLA). The SMD number must be used when ordering. Detailed electrical specifications for the ISL706ARH are contained in SMD 5962-11213. A link is provided on the Intersil Web site for downloading this document.

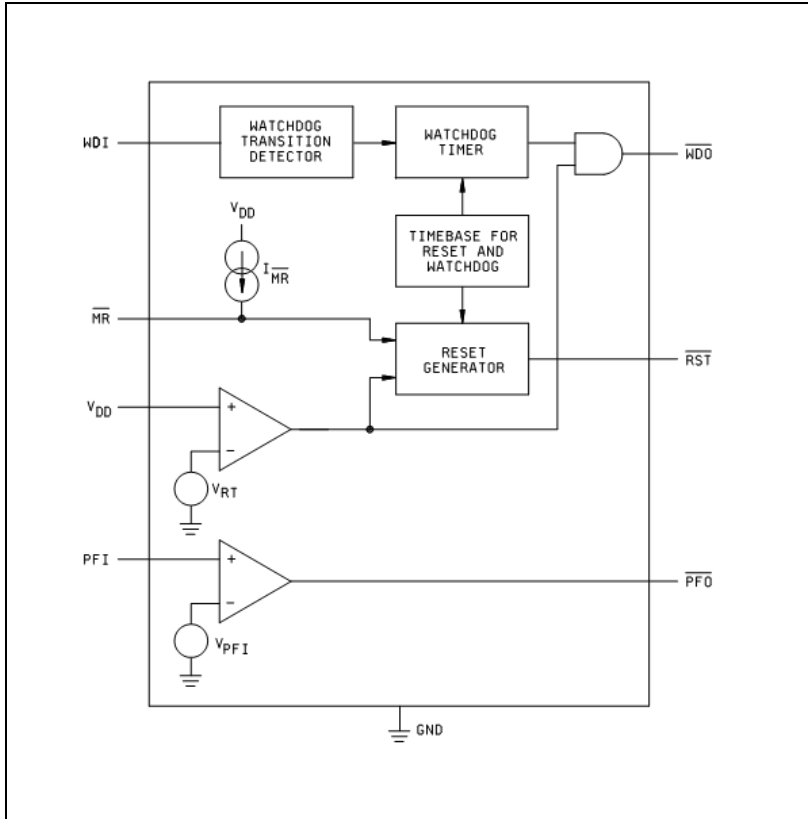

Figure 1: ISL706ARH block diagram.

4: Test Description

4.1 Irradiation Facilities

High dose rate testing of the ISL706ARH was performed using a Gammacell 220 ^{60}Co irradiator located in the Palm Bay, Florida Intersil facility. Low dose rate testing was performed using a J. L. Shepherd model 484 ^{60}Co irradiator in the same facility. The high dose rate irradiations were done at 85rad(Si)/s and the low dose rate work was performed at 0.010rad(Si)/s, both per MIL-STD-883 Method 1019.

4.2 Test Fixturing

Figure 2 shows the electrical configuration used for biased irradiation in conformance with Standard Microcircuit Drawing (SMD) 5962-11213.

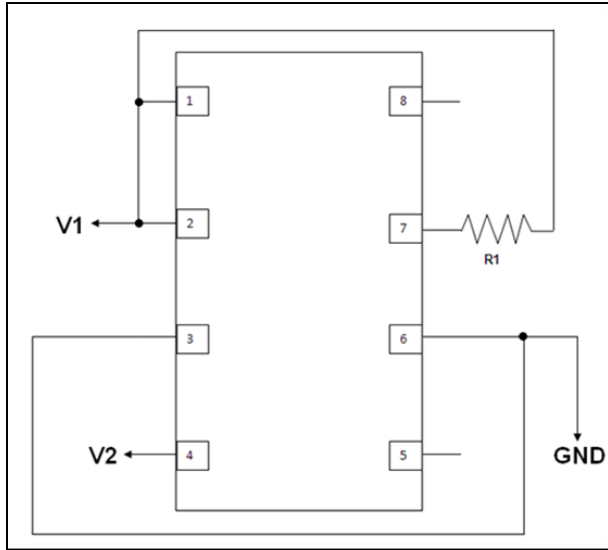

NOTES:

V1 = 3.6 V \pm 5%

V2 = 0.8 V \pm 5%

R1 =OPEN for this device

Figure 2: Irradiation bias configuration for the ISL706ARH per Standard Microcircuit Drawing (SMD) 5962-11213.

4.3 Characterization equipment and procedures

All electrical testing was performed outside the irradiator using the production automated test equipment (ATE) with datalogging at each downpoint. Downpoint electrical testing was performed at room temperature.

4.4 Experimental matrix

Total dose irradiations proceeded in accordance with the guidelines of MIL-STD-883 Test Method 1019. The experimental matrix consisted of eight samples irradiated at high dose rate with all pins grounded, eight samples irradiated at high dose rate under bias, eight samples irradiated at low dose rate with all pins grounded and eight samples irradiated at low dose rate under bias. Four control units were used.

Samples of the ISL706ARH die were drawn from production lot WMA4H and were packaged in the standard hermetic 8-pin solder-sealed flatpack (CDFP4-F8) production package. Samples were processed through the standard burnin cycle before irradiation, as required by MIL-STD-883, and were screened to the SMD 5962-11213 limits at room, low and high temperatures prior to the test.

4.5 Downpoints

Downpoints for the tests were zero, 10krad(Si), 25krad(Si), 50krad(Si), 100krad(Si) and 150krad(Si) for the high and low dose rate tests.

5: Results

5.1 Results and conclusions

Testing at both dose rates to 150krad(Si) of the ISL706ARH is complete. All samples showed excellent stability and remained within the SMD limits at all downpoints, and no dose rate sensitivity or bias sensitivity was observed in any parameter. The control units indicated good repeatability of the ATE hardware, fixturing and software at all downpoints. The part is not considered low dose rate or bias sensitive.

A rebound test after the high dose rate irradiation was not performed, as the P6 process has been characterized for this effect using the ISL75051SRH as a test vehicle. The process was shown to display no rebound effects after a post-irradiation anneal under bias at +100°C for 168 hours. These conditions are as specified in MIL-STD-883. A similar anneal of the samples was performed after the low dose rate irradiation for informational purposes only; no rebound was observed.

5.2 Variables data

The plots in Figures 3 through 24 show data at all downpoints. The plots show the median of key parameters as a function of total dose for each of the four irradiation conditions, as well as the control unit data and the applicable SMD limits. We chose to plot the median for these parameters due to the relatively small sample sizes involved.

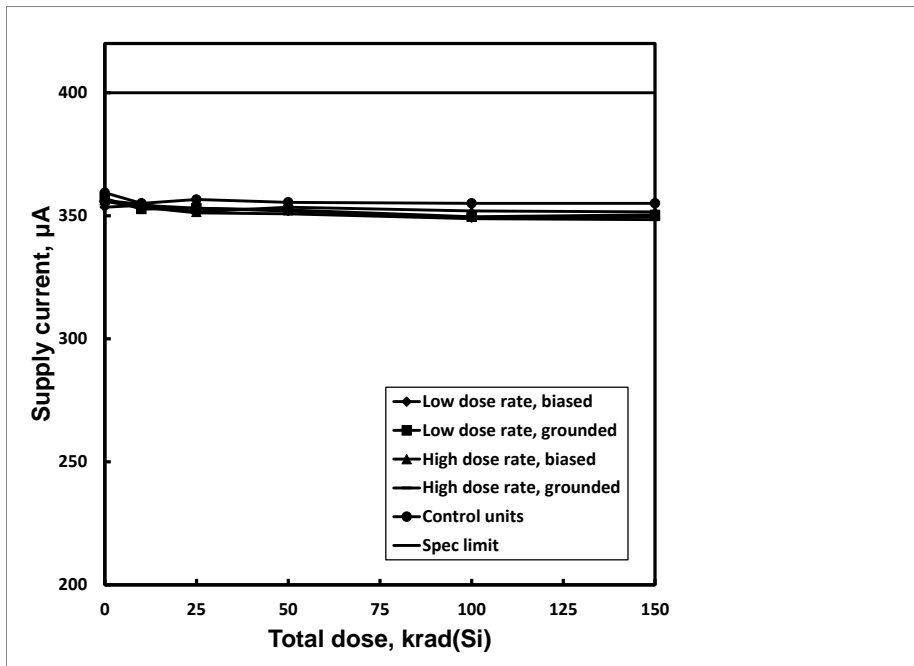

Figure 3: ISL706ARH power supply current as a function of total dose irradiation at low and high dose rate for the unbiased (all pins grounded) and the biased (per Figure 2) cases. The low dose rate was 0.01rad(Si)/s and the high dose rate 85rad(Si)/s. Sample size for each cell was 8, and 4 control units were used. The post-irradiation SMD limit is 400.0µA maximum.

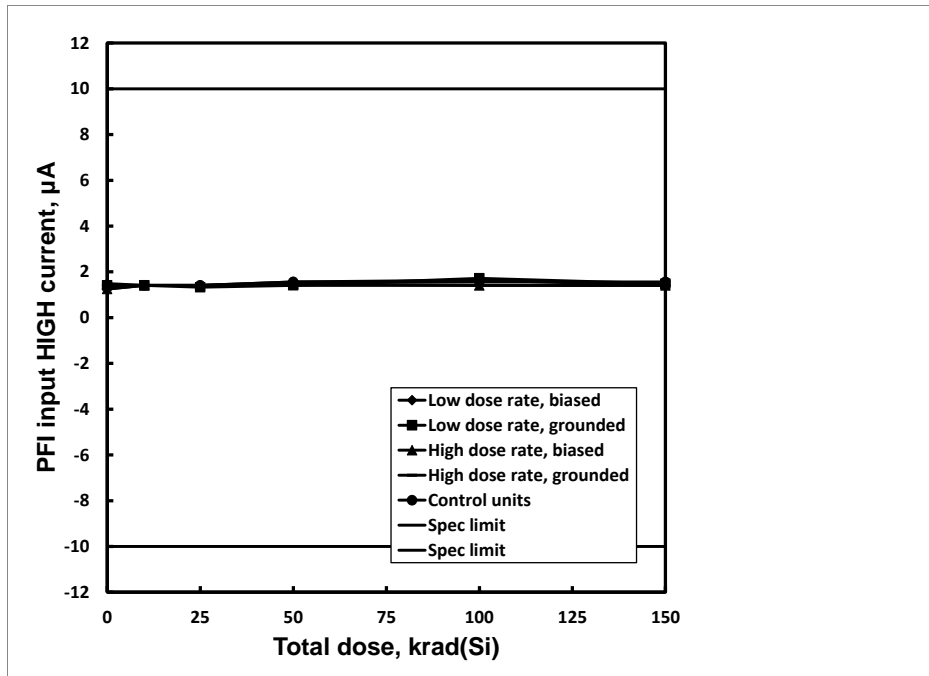

Figure 4: ISL706ARH power fail input (PFI) input high current as a function of total dose irradiation at low and high dose rate for the unbiased (all pins grounded) and the biased (per Figure 2) cases. The low dose rate was 0.01rad(Si)/s and the high dose rate 85rad(Si)/s. Sample size for each cell was 8, and 4 control units were used. The post-irradiation SMD limits are -10.0µA to 10.0µA.

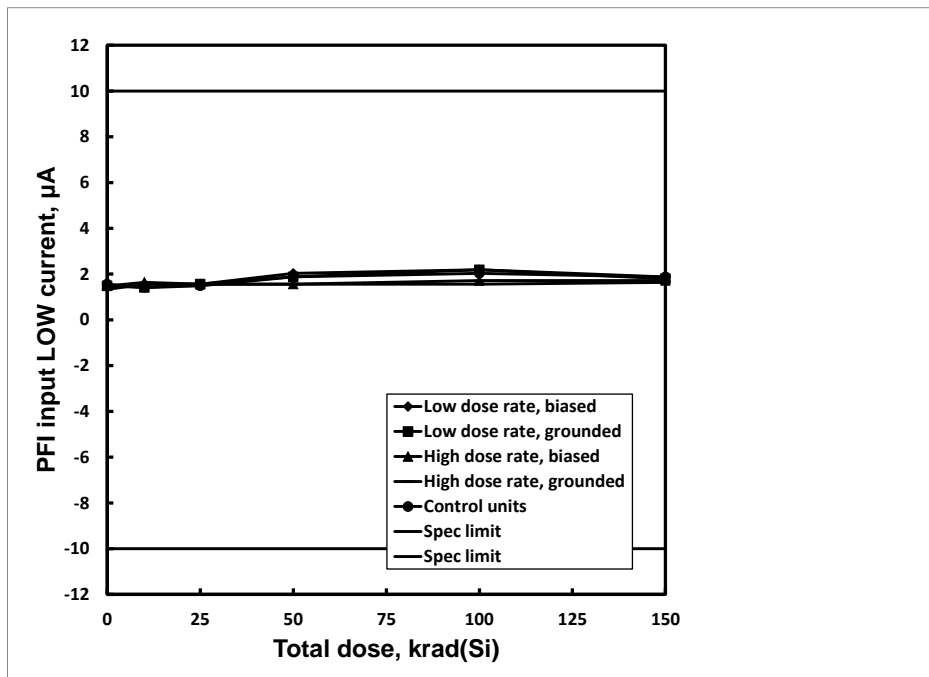

Figure 5: ISL706ARH power fail input (PFI) input low current as a function of total dose irradiation at low and high dose rate for the unbiased (all pins grounded) and the biased (per Figure 2) cases. The low dose rate was 0.01rad(Si)/s and the high dose rate 85rad(Si)/s. Sample size for each cell was 8, and 4 control units were used. The post-irradiation SMD limits are -10.0µA to 10.0µA.

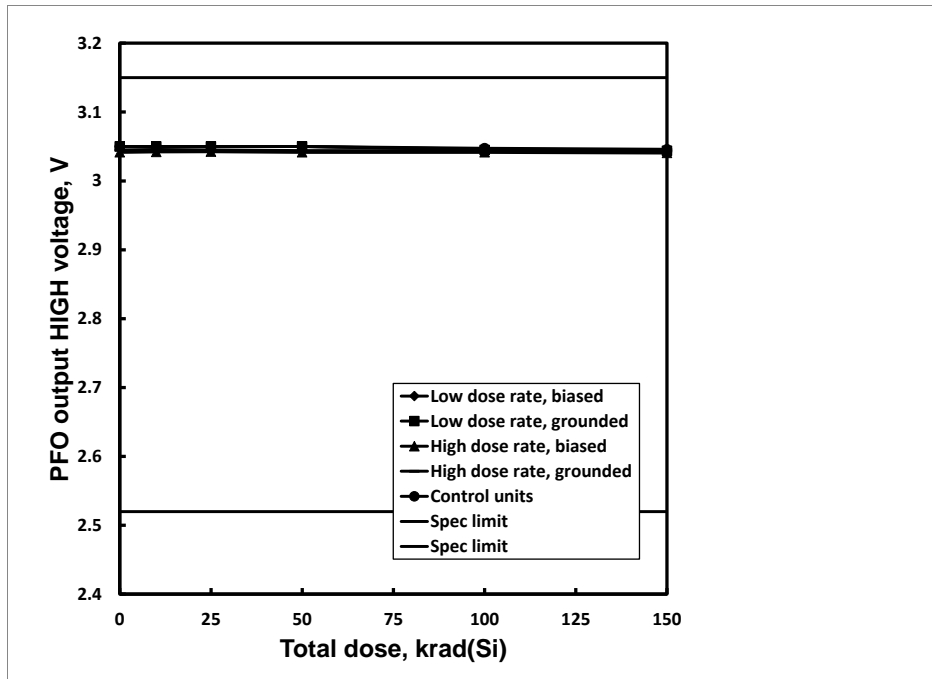

Figure 6: ISL706ARH power fail output (PFO) output high voltage as a function of total dose irradiation at low and high dose rate for the unbiased (all pins grounded) and the biased (per Figure 2) cases. The low dose rate was 0.01rad(Si)/s and the high dose rate 85rad(Si)/s. Sample size for each cell was 8, and 4 control units were used. The post-irradiation SMD limits are 2.52V to 3.15V.

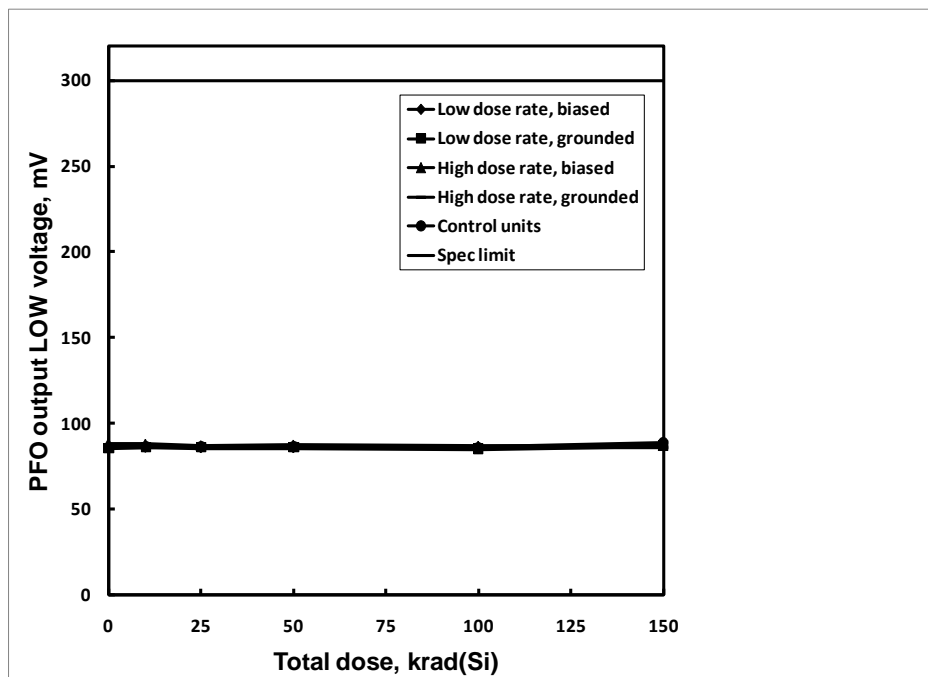

Figure 7: ISL706ARH power fail output (PFO) output low voltage as a function of total dose irradiation at low and high dose rate for the unbiased (all pins grounded) and the biased (per Figure 2) cases. The low dose rate was 0.01rad(Si)/s and the high dose rate 85rad(Si)/s. Sample size for each cell was 8, and 4 control units were used. The post-irradiation SMD limit is 300.0mV maximum.

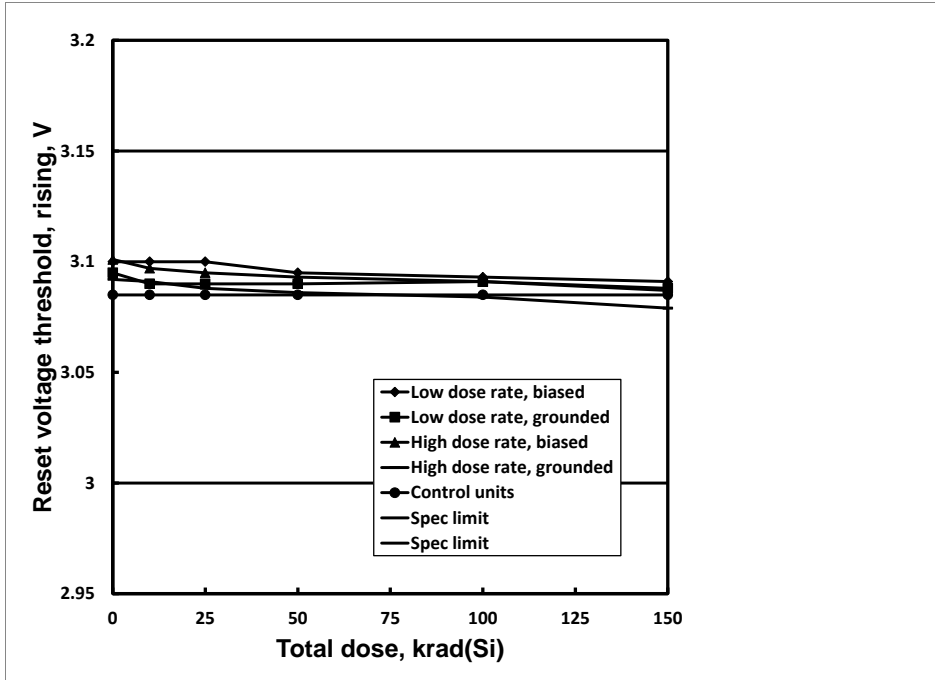

Figure 8: ISL706ARH reset threshold voltage, rising, as a function of total dose irradiation at low and high dose rate for the unbiased (all pins grounded) and the biased (per Figure 2) cases. The low dose rate was 0.01rad(Si)/s and the high dose rate 85rad(Si)/s. Sample size for each cell was 8, and 4 control units were used. The post-irradiation SMD limits are 3.00V to 3.15V.

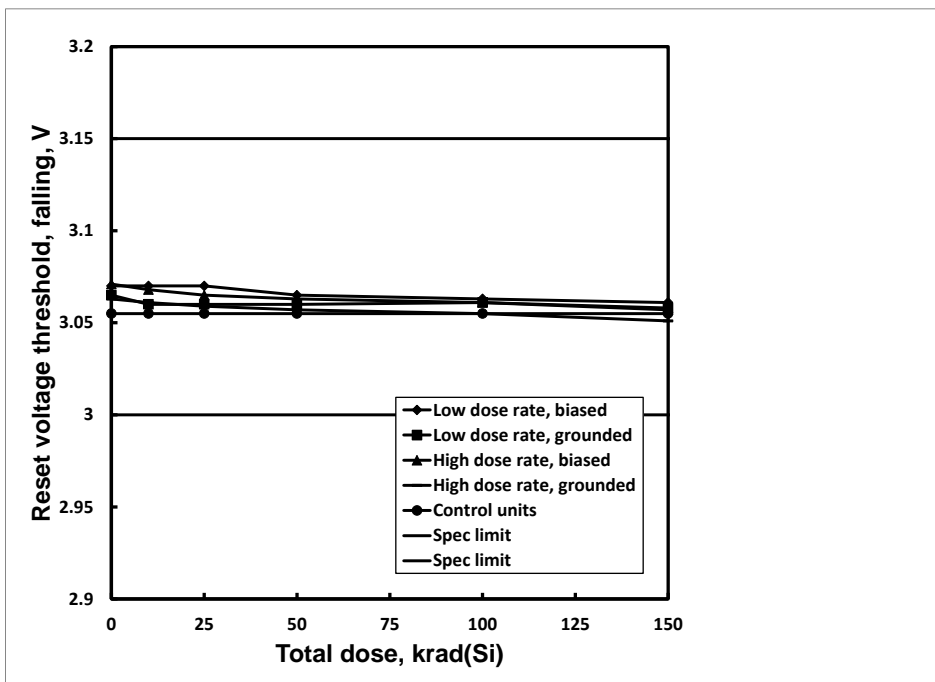

Figure 9: ISL706ARH reset threshold voltage, falling, as a function of total dose irradiation at low and high dose rate for the unbiased (all pins grounded) and the biased (per Figure 2) cases. The low dose rate was 0.01rad(Si)/s and the high dose rate 85rad(Si)/s. Sample size for each cell was 8, and 4 control units were used. The post-irradiation SMD limits are 3.00V to 3.15V.

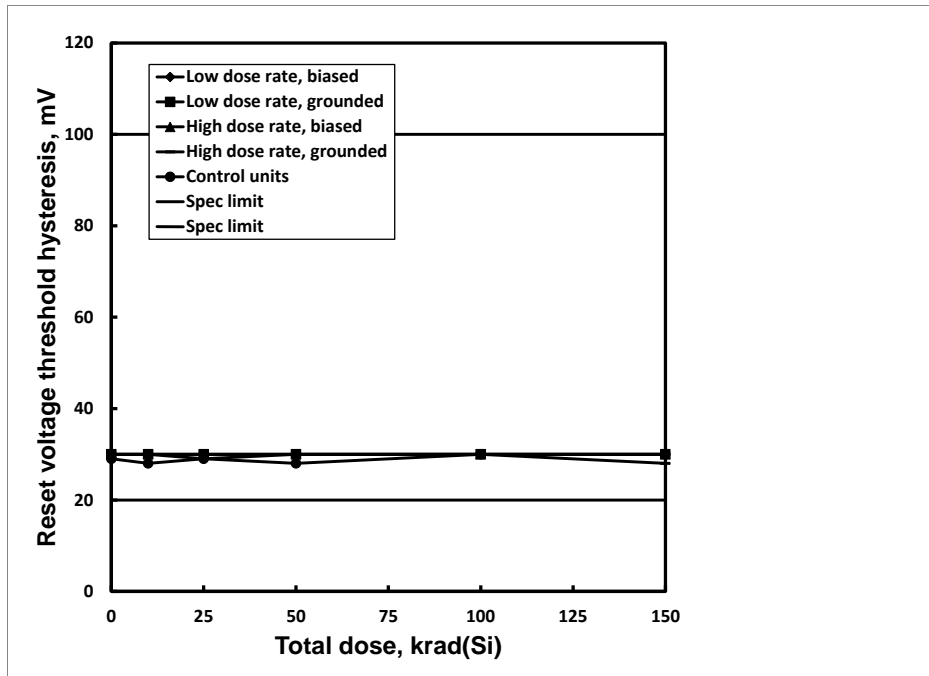

Figure 10: ISL706ARH reset threshold voltage hysteresis as a function of total dose irradiation at low and high dose rate for the unbiased (all pins grounded) and the biased (per Figure 2) cases. The low dose rate was 0.01rad(Si)/s and the high dose rate 85rad(Si)/s. Sample size for each cell was 8, and 4 control units were used. The post-irradiation SMD limits are 20.0mV to 100.0mV.

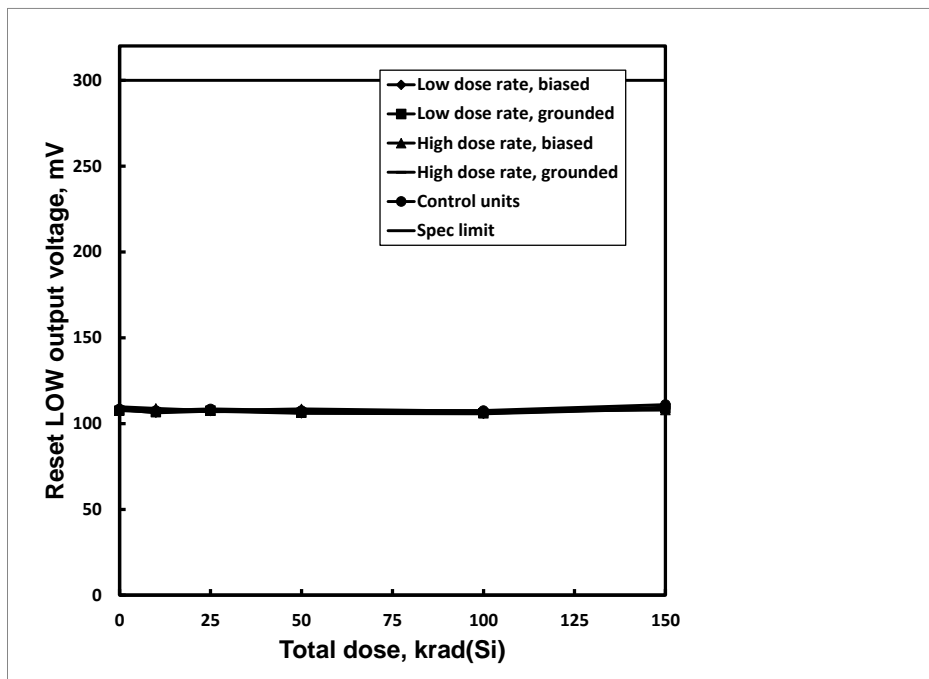

Figure 11: ISL706ARH reset low output voltage as a function of total dose irradiation at low and high dose rate for the unbiased (all pins grounded) and the biased (per Figure 2) cases. The low dose rate was 0.01rad(Si)/s and the high dose rate 85rad(Si)/s. Sample size for each cell was 8, and 4 control units were used. The post-irradiation SMD limit is 300.0mV maximum.

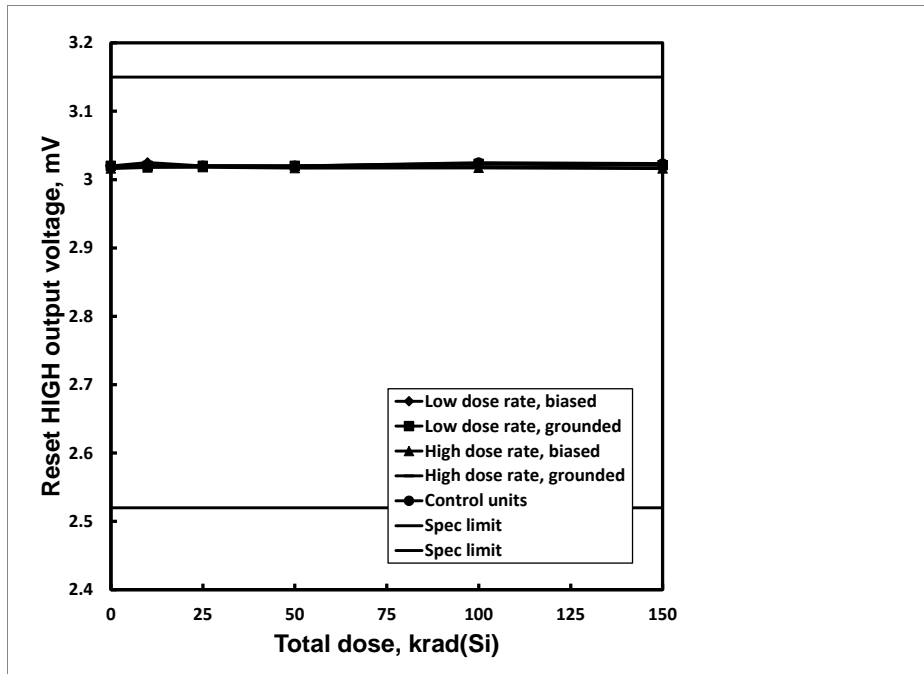

Figure 12: ISL706ARH reset high output voltage as a function of total dose irradiation at low and high dose rate for the unbiased (all pins grounded) and the biased (per Figure 2) cases. The low dose rate was 0.01rad(Si)/s and the high dose rate 85rad(Si)/s. Sample size for each cell was 8, and 4 control units were used. The post-irradiation SMD limits are 2.52V to 3.15V.

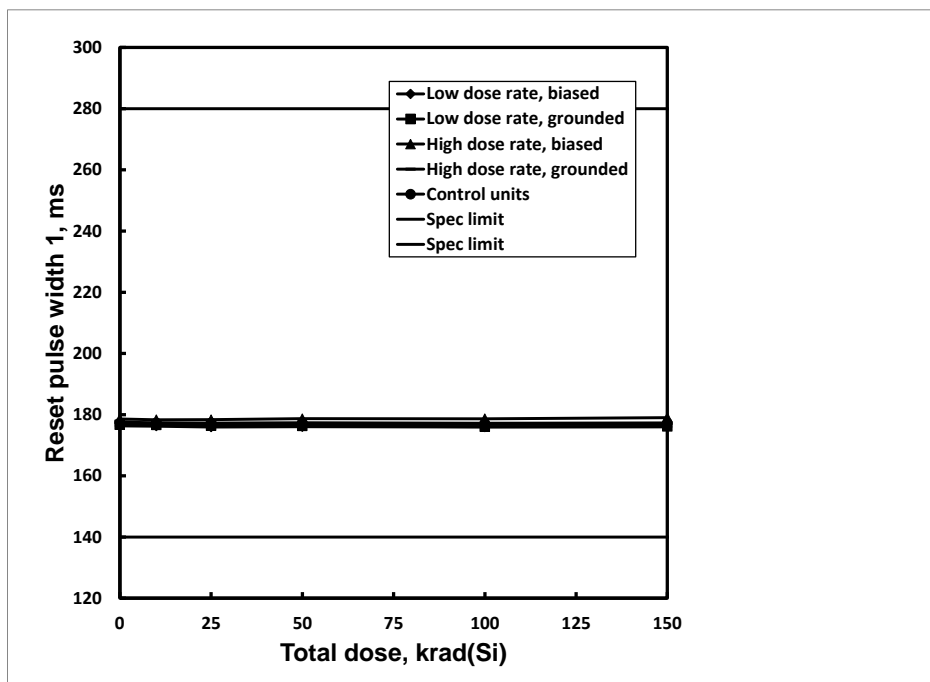

Figure 13: ISL706ARH reset pulse width 1 as a function of total dose irradiation at low and high dose rate for the unbiased (all pins grounded) and the biased (per Figure 2) cases. The low dose rate was 0.01rad(Si)/s and the high dose rate 85rad(Si)/s. Sample size for each cell was 8, and 4 control units were used. The post-irradiation SMD limits are 140.0ms to 280.0ms.

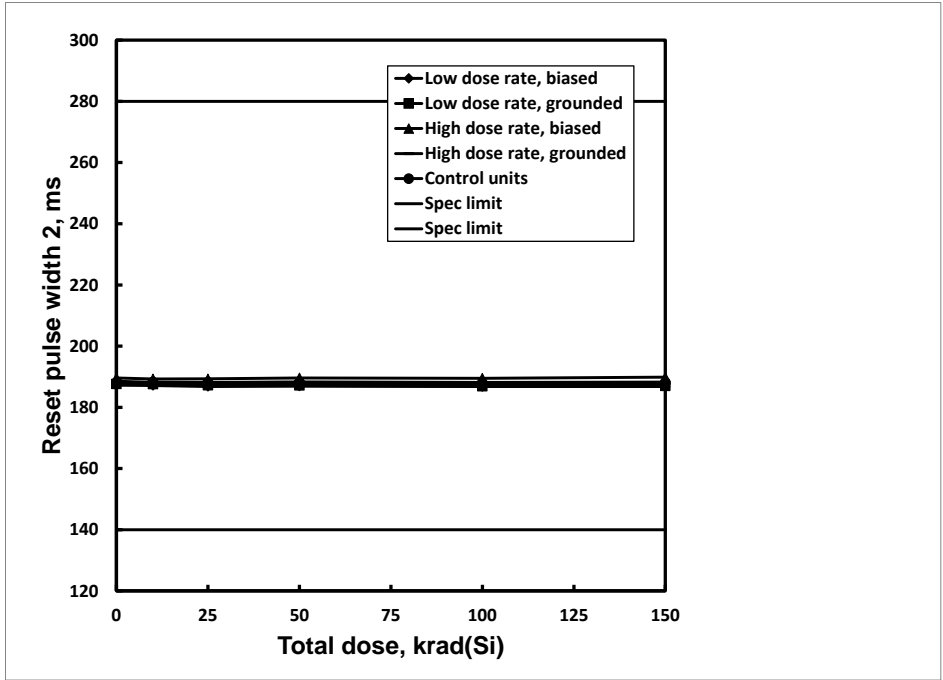

Figure 14: ISL706ARH reset pulse width 2 as a function of total dose irradiation at low and high dose rate for the unbiased (all pins grounded) and the biased (per Figure 2) cases. The low dose rate was 0.01rad(Si)/s and the high dose rate 85rad(Si)/s. Sample size for each cell was 8, and 4 control units were used. The post-irradiation SMD limits are 140.0ms to 280.0ms.

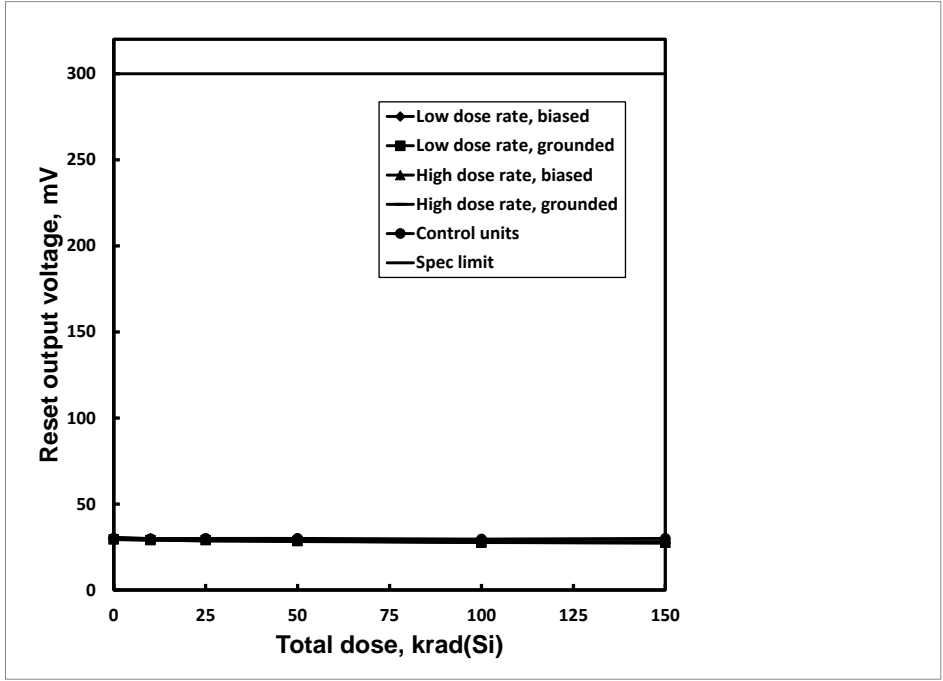

Figure 15: ISL706ARH reset output voltage as a function of total dose irradiation at low and high dose rate for the unbiased (all pins grounded) and the biased (per Figure 2) cases. The low dose rate was 0.01rad(Si)/s and the high dose rate 85rad(Si)/s. Sample size for each cell was 8, and 4 control units were used. The post-irradiation SMD limit is 300.0mV maximum.

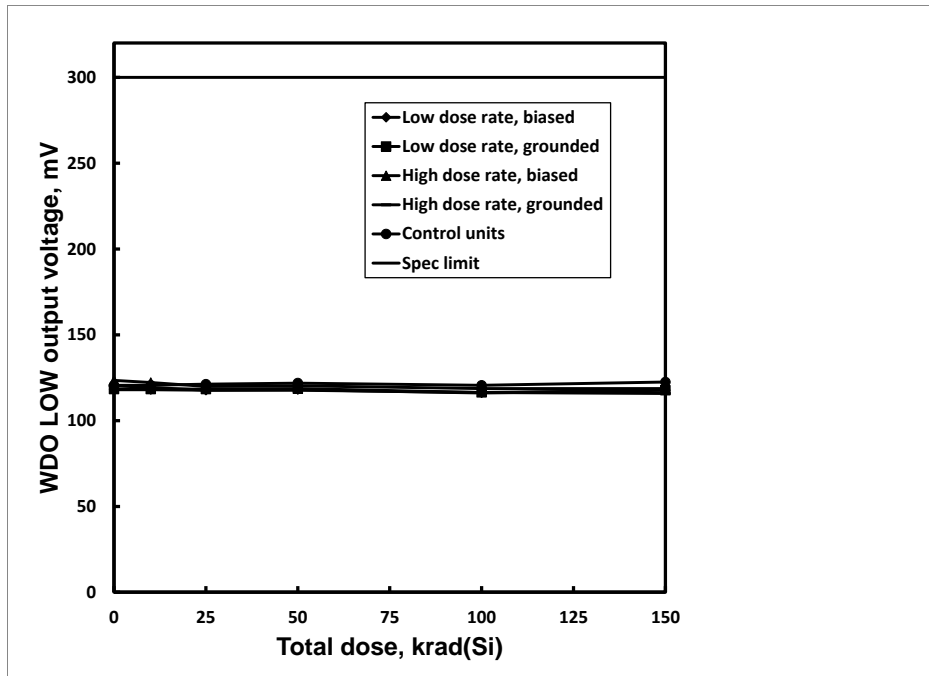

Figure 16: ISL706ARH watchdog output (WDO) low voltage as a function of total dose irradiation at low and high dose rate for the unbiased (all pins grounded) and the biased (per Figure 2) cases. The low dose rate was 0.01rad(Si)/s and the high dose rate 85rad(Si)/s. Sample size for each cell was 8, and 4 control units were used. The post-irradiation SMD limit is 300.0mV maximum.

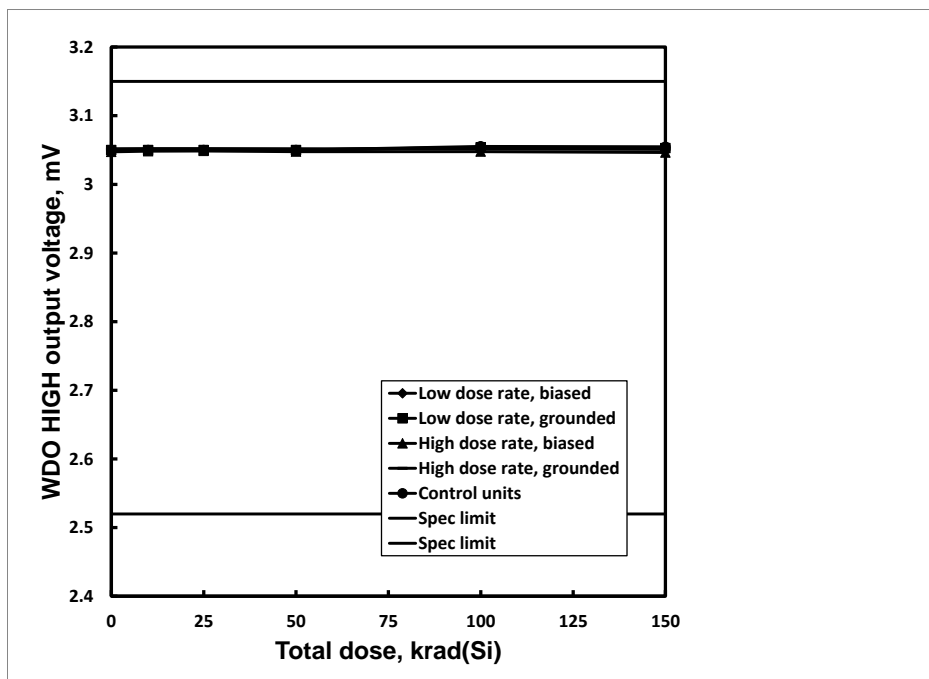

Figure 17: ISL706ARH watchdog output (WDO) high voltage as a function of total dose irradiation at low and high dose rate for the unbiased (all pins grounded) and the biased (per Figure 2) cases. The low dose rate was 0.01rad(Si)/s and the high dose rate 85rad(Si)/s. Sample size for each cell was 8, and 4 control units were used. The post-irradiation SMD limits are 2.52V to 3.15V.

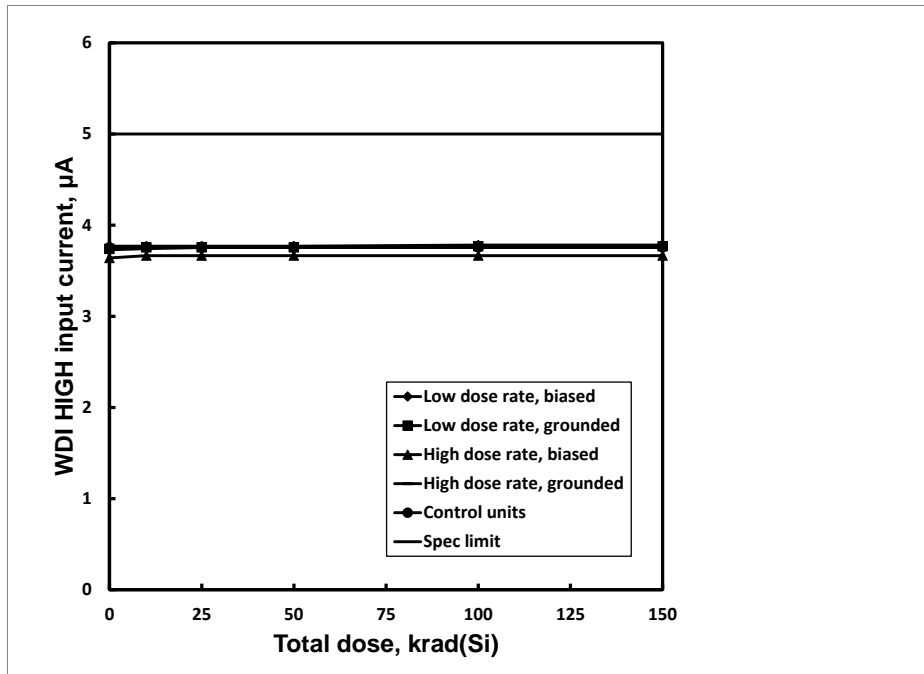

Figure 18: ISL706ARH watchdog input (WDI) input high current as a function of total dose irradiation at low and high dose rate for the unbiased (all pins grounded) and the biased (per Figure 2) cases. The low dose rate was 0.01rad(Si)/s and the high dose rate 85rad(Si)/s. Sample size for each cell was 8, and 4 control units were used. The post-irradiation SMD limit is 5.0µA maximum.

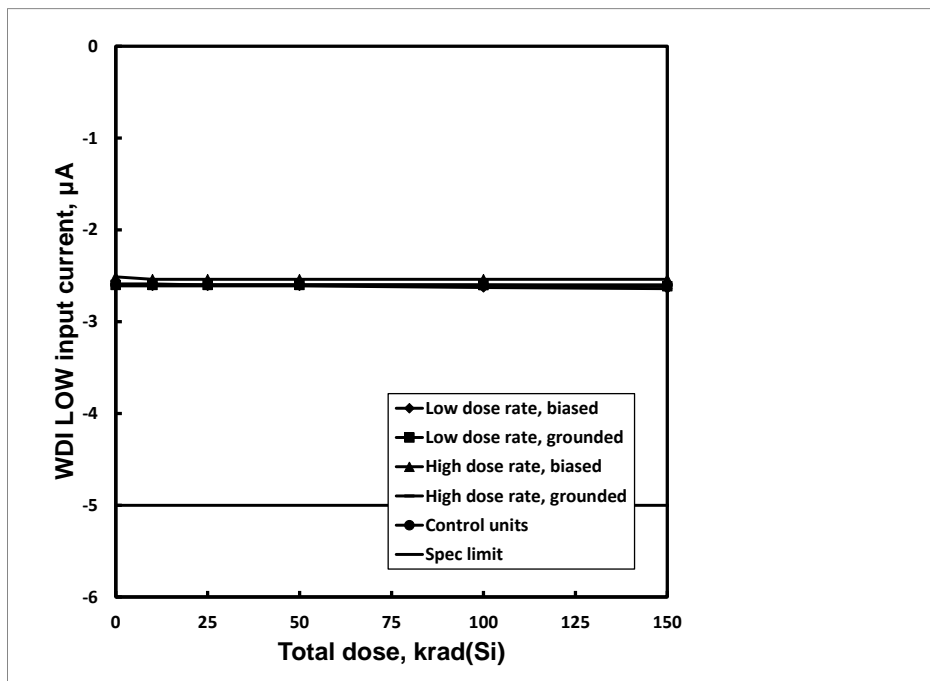

Figure 19: ISL706ARH watchdog input (WDI) input low current as a function of total dose irradiation at low and high dose rate for the unbiased (all pins grounded) and the biased (per Figure 2) cases. The low dose rate was 0.01rad(Si)/s and the high dose rate 85rad(Si)/s. Sample size for each cell was 8, and 4 control units were used. The post-irradiation SMD limit is -5.0µA maximum.

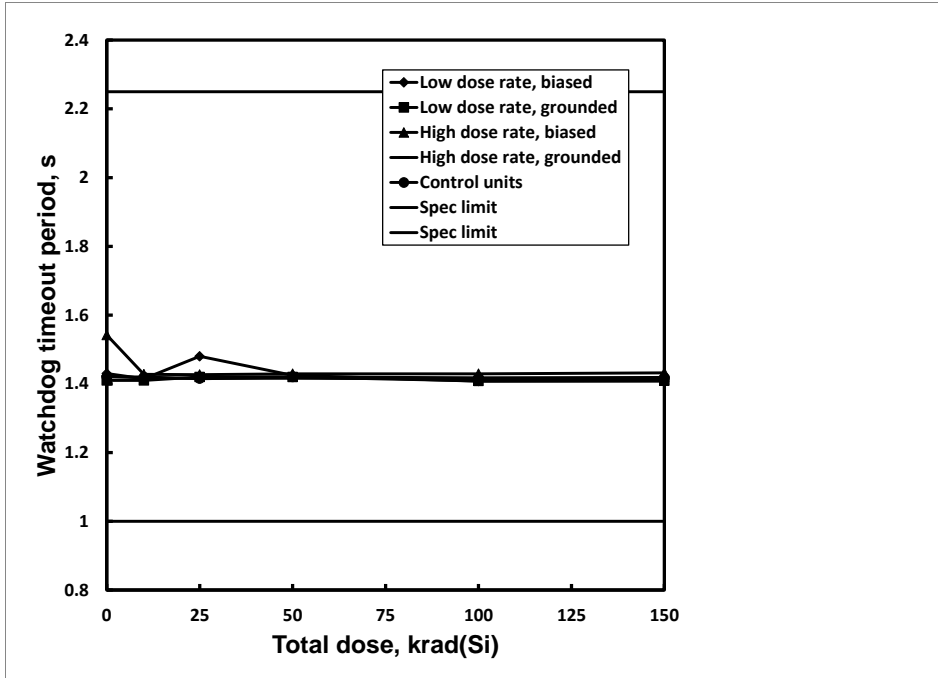

Figure 20: ISL706ARH watchdog timeout period as a function of total dose irradiation at low and high dose rate for the unbiased (all pins grounded) and the biased (per Figure 2) cases. The low dose rate was 0.01rad(Si)/s and the high dose rate 85rad(Si)/s. Sample size for each cell was 8, and 4 control units were used. The post-irradiation SMD limits are 1.00s to 2.25s.

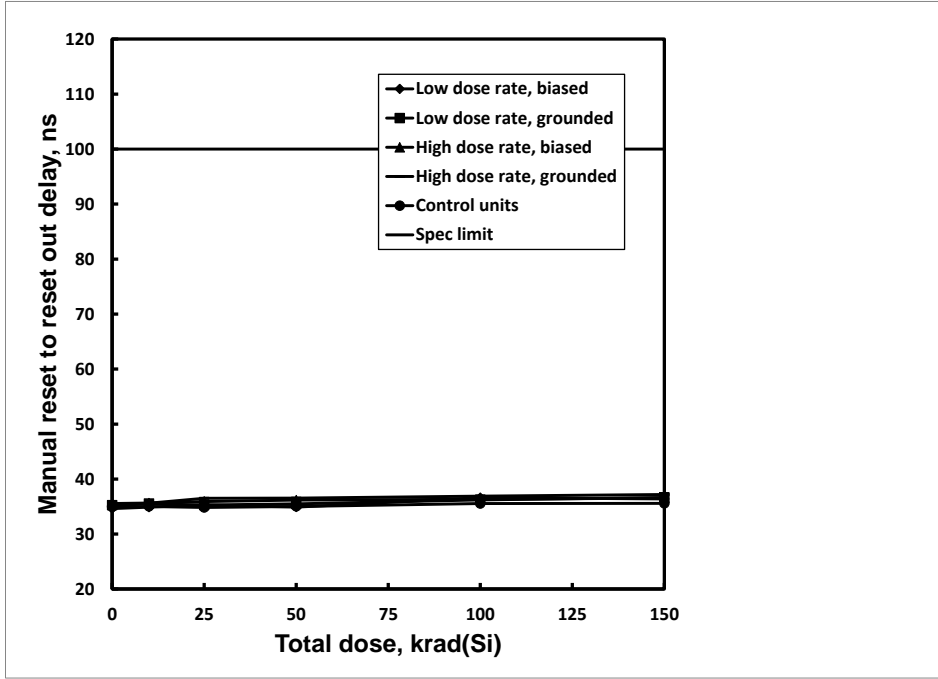

Figure 21: ISL706ARH manual reset to reset out delay as a function of total dose irradiation at low and high dose rate for the unbiased (all pins grounded) and the biased (per Figure 2) cases. The low dose rate was 0.01rad(Si)/s and the high dose rate 85rad(Si)/s. Sample size for each cell was 8, and 4 control units were used. The post-irradiation SMD limit is 100.0ns maximum.

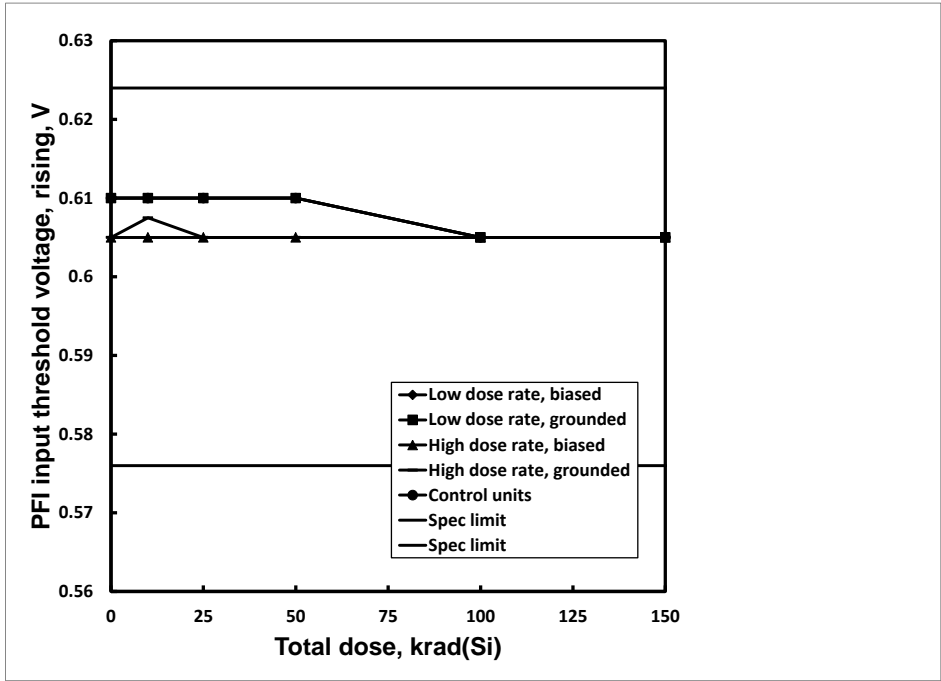

Figure 22: ISL706ARH power fail input (PFI) threshold voltage, rising, as a function of total dose irradiation at low and high dose rate for the unbiased (all pins grounded) and the biased (per Figure 2) cases. The low dose rate was 0.01rad(Si)/s and the high dose rate 85rad(Si)/s. Sample size for each cell was 8, and 4 control units were used. The post-irradiation SMD limits are 0.576V to 0.624V.

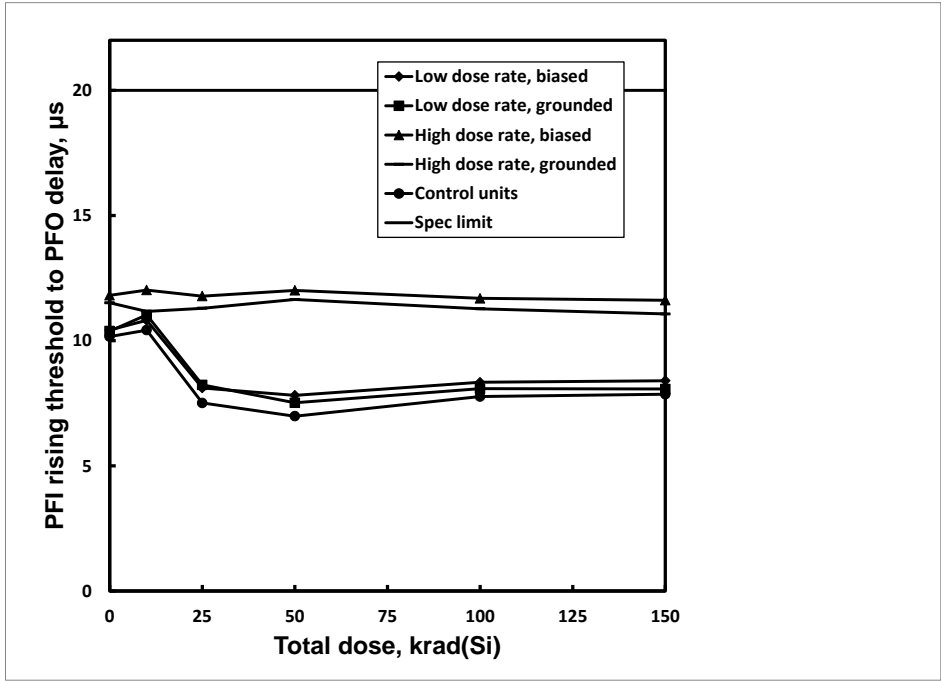

Figure 23: ISL706ARH power fail input (PFI) rising threshold voltage to PFO delay as a function of total dose irradiation at low and high dose rate for the unbiased (all pins grounded) and the biased (per Figure 2) cases. The low dose rate was 0.01rad(Si)/s and the high dose rate 85rad(Si)/s. Sample size for each cell was 8, and 4 control units were used. The post-irradiation SMD limit is 20.0µs maximum.

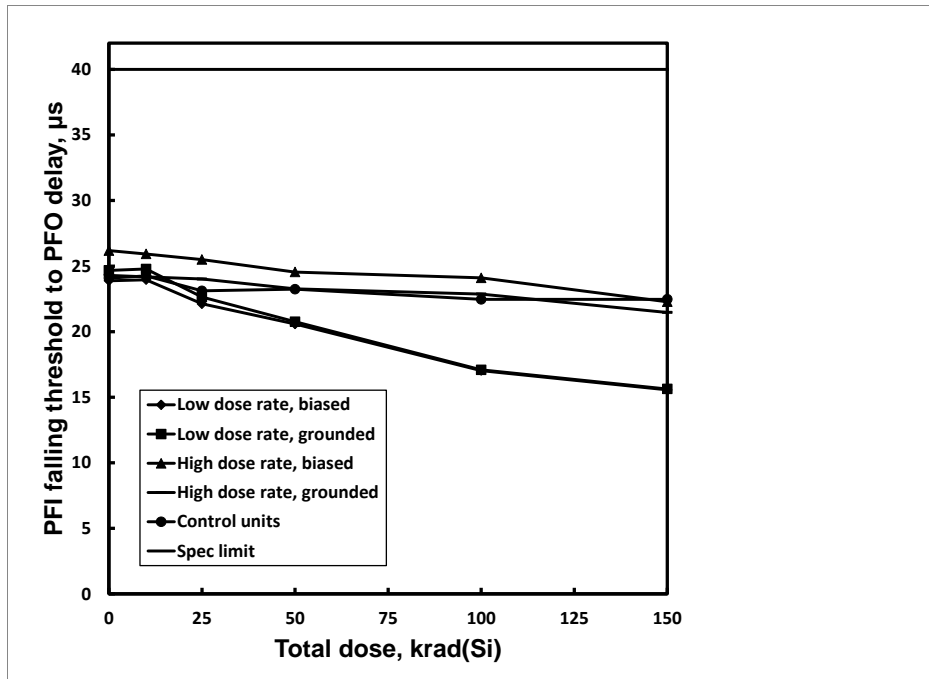

Figure 24: ISL706ARH power fail input (PFI) falling threshold voltage to PFO delay as a function of total dose irradiation at low and high dose rate for the unbiased (all pins grounded) and the biased (per Figure 2) cases. The low dose rate was 0.01rad(Si)/s and the high dose rate 85rad(Si)/s. Sample size for each cell was 8, and 4 control units were used. The post-irradiation SMD limit is 40.0µs maximum.

6: Appendices

6.1: Reported parameters.

Figure	Parameter	Limit, low	Limit, high	Units	Notes
3	Power supply current	-	400.0	µA	
4	Power fail input (PFI) input high current	-10.0	10.0	µA	
5	Power fail input (PFI) input low current	-10.0	10.0	µA	
6	Power fail output (PFO) output high voltage	2.52	3.15	V	
7	Power fail output (PFO) output low voltage	-	300.0	mV	
8	Reset threshold voltage, rising	3.00	3.15	V	
9	Reset threshold voltage, falling	3.00	3.15	V	
10	Reset threshold voltage hysteresis	20.0	-	mV	
11	Reset low output voltage	-	300.0	mV	
12	Reset high output voltage	2.52	3.15	V	
13	Reset pulse width 1	140.0	280.0	ms	
14	Reset pulse width 2	140.0	280.0	ms	
15	Reset output voltage	-	300.0	mV	
16	Watchdog output (WDO) low voltage		300.0	mV	
17	Watchdog output (WDO) high voltage	2.52	3.15	V	
18	Watchdog input (WDI) input high current	-	5.0	µA	
19	Watchdog input (WDI) input low current	-	-5.0	µA	

20	Watchdog timeout period	1.0	2.25	s	
21	Manual reset to reset out delay	-	100.0	ns	
22	Power fail input (PFI) threshold voltage, rising	0.576	0.624	V	
23	PFI rising threshold voltage to PFO delay	-	20.0	μs	
24	PFI falling threshold voltage to PFO delay	-	40.0	μs	

Note 1: Limits are taken from Standard Microcircuit Drawing (SMD) 5962-11213.

7: Document revision history

Revision	Date	Pages	Comments
0	January 2012	All	Original issue
1	February 2012	2	Add ISL706B/C text