

**Abstract:**

This document provides a brief introduction to low dose rate effects including discussion of Intersil's approach to testing and qualification issues. We then report results of baseline 100krad(Si) low dose rate testing of the Intersil HS9-139RH quad comparator.

**Table of Contents:**

Abstract

1: Introduction: What is Low Dose Rate Sensitivity?

2: Low Dose Rate Testing Strategy at Intersil

3: Low Dose Rate Testing of the Intersil HS9-139RH Quad Comparator

4: Conclusion

5: References

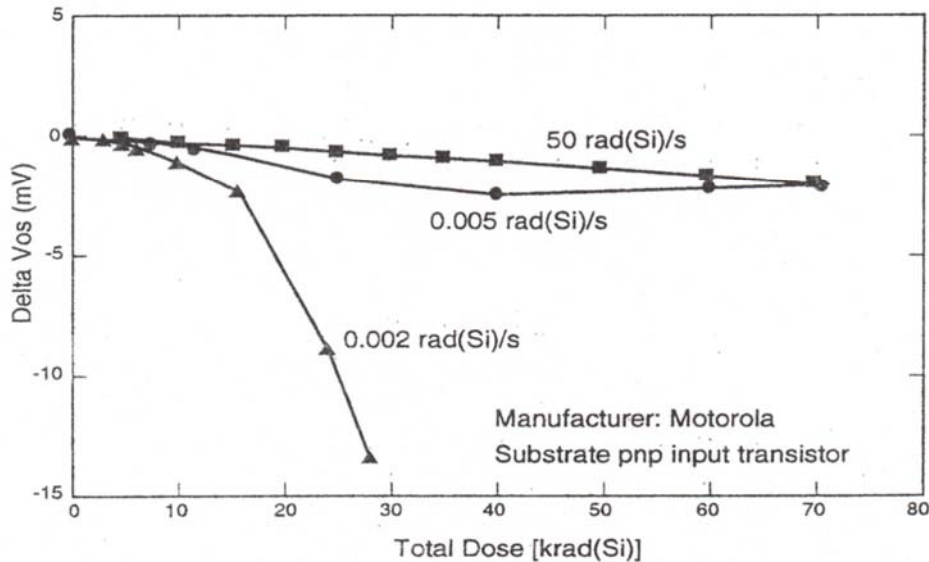
**1: Introduction: What is Low Dose Rate Sensitivity?**

Low dose rate effects have been a topic of considerable research interest for the last eight years. The first section of this report will supply a brief technical introduction to the topic.

Total ionizing dose testing of semiconductor components has historically been performed at 'qualification' dose rates in the 50 – 300rad(Si)/s range as specified in MIL-STD-883. At 50rad(Si)/s, the low end of the dose rate specification range, a lot qualification test to a 300krad(Si) total dose specification takes a maximum of 1.67 hours, enabling the test to be carried out in less than a day. Intersil has historically performed total dose qualification testing of their hardened parts on a wafer by wafer basis, using Gammacell 220<sup>™</sup> irradiators; the dose rate of our current Gammacell is approximately 130rad(Si)/s, and the 300krad(Si) test takes 38 minutes.

In the 1992 – 1993 time frame, researchers at Mission Research and Aerospace Corporation noted a surprising dose rate dependence in the total dose response of bipolar analog integrated circuits. Devices such as the industry-standard LM139 comparator showed severe degradation of such parameters as input bias current and input offset voltage when irradiated at very low dose rates. This enhanced low dose rate sensitivity (ELDRS) was subsequently observed in a broad range of bipolar and BiCMOS parts, but has not been seen in MOS parts (except in a very few unconfirmed cases in discrete MOS devices). In MOS parts the effects of low dose rate are opposite to those observed in bipolars; the damage anneals out at a constant rate, so lower dose rate testing causes less degradation, which is a much more intuitive result. Figure 1

shows a well-known if somewhat extreme sample response curve [1] for a bipolar operational amplifier.



**Figure 1:** *Where is the bottom?* Degradation of the input bias current of the Motorola LM328 operational amplifier at three dose rates [1]. Note that the input offset voltage as a function of total dose shows excellent stability at the 50rad(Si)/s and .005rad(Si)/s dose rates, but degrades rapidly at the very low .002rad(Si)/s dose rate.

Following the initial findings in 1992, low dose rate sensitivity developed into one of the premier research topics in the radiation effects community, as evidenced by a large number of journal papers. Compendia of low dose rate results for a broad range of commercially available parts are particularly useful; these compendia [2] and other papers on the subject can be found in the IEEE Radiation Effects Data Workshop Record, which is published yearly and contains papers presented at the Workshop. The December issue of the IEEE Transactions on Nuclear Science serves as the proceedings of the IEEE Nuclear and Space Radiation Effects Conference (NSREC) and is another excellent source of technical information on low dose rate effects.

There has been significant work on identifying a basic mechanism that explains this effect, with mixed success. The theories relate to trapping and detrapping rates in the IC's dielectric thin film layers. A detailed discussion of the basic mechanisms of ELDRS is outside the scope of this document. Note that the initial work suggested that the worst-case condition in all cases was zero bias during irradiation; this conclusion has subsequently been disproved. Intersil testing of the HS1825ASRH pulse width modulator has shown bias sensitivity, in disagreement with the early claims made in the literature, and showed distinctive failure signatures for each of the bias configurations used. The requirement for biased irradiation requires fixture design and construction and further complicates testing procedures. Clearly, many different bias configurations are possible; Intersil's approach to managing this problem has been to use the same bias configurations for both low and high dose rate testing. To this end, we use the irradiation bias circuit specified in the applicable SMD. This approach enables comparison of results for both dose rate ranges.

ELDRS has proven to be a somewhat unpredictable and poorly repeatable effect. There are well-documented large variations within processes and across similar

processes built in different fabrication facilities. Packaging, especially in plastic, seems to play a role as well, as do heat treats incurred during burnin.

Due to the very low dose rates used, low dose rate tests take an inordinately long time, at least when viewed in the context of normal qualification tests. The numbers are inescapable: a simple 100krad(Si) qualification test at a dose rate of .01rad(Si)/s takes 116 days, or nearly four months, not including pre- and post-irradiation characterization testing. Clearly, this is not a practical procedure in any for-profit organization, and a substantial amount of research has gone into the development of accelerated test methods. Harris Corporation and Intersil researchers have developed [3] an accelerated ELDRS test that has shown reasonable correlation to true low dose rate testing at the part level, while internal Intersil tests (these at the transistor level) have shown good correlation. The method tests the parts at a moderate dose rate of about 10rad(Si)/s and at a temperature of 100°C, which reduces the 100krad(Si) test time to about three hours. User acceptance of such options will be a key factor in determining participation in this market by IC vendors. For the present, though, accelerated testing is used as a diagnostic for low dose rate sensitivity only.

Again due to the low dose rates needed, current Gammacell 220™ sources are not readily usable. The dose rates of these <sup>60</sup>Co sources cannot conveniently be reduced to the 5rad(Si)/s required by the current MIL-STD-883 Method 1019.7 accelerated test option, let alone to the .01rad(Si)/s true low dose rate requirement. The Gammacell interior is very cramped, and they can accommodate only a few samples in a small fixture. Low dose rate sources are available from J. L. Shepherd and Associates (San Fernando, CA), and Intersil uses a Model 484 irradiator from this vendor.

Intersil uses dielectrically isolated (DI) fabrication processes for its hardened analog parts. This positively eliminates latchup, either electrically or single-event caused, and also enables the use of a vertical PNP bipolar transistor of greatly enhanced electrical performance as compared to lateral devices. Intersil expected these DI parts to show reduced sensitivity to low dose rate due to the vertical PNP structures used. The basis of this claim was the known softness of the lateral PNP transistors encountered in nearly all commercial JI processes. Radiation tests performed in the context of routine device modeling work had shown our vertical devices to be much harder than laterals at qualification dose rates in the 50 – 300rad(Si)/s range, and it was expected that the low dose rate response of the vertical PNP device would track its response at high dose rate.

Workers outside and inside Intersil have verified this assumption. In 1999 researchers at NAVSEA/Crane published a paper [5] reporting positive results for the HS9-139RH quad comparator, which was found to be within its post-radiation parametric limits after 300krad(Si) at .01rad(Si)/s. Additionally, baseline 100krad(Si) low dose rate test of the HS9-139RH quad comparator at Intersil is complete, and the balance of this document will provide detailed results of this test.

## **2: Low Dose Rate Testing Strategy at Intersil**

The long test times encountered make conventional wafer-by-wafer qualification testing at low dose rate an impractical proposition, and Intersil does not plan to support this approach. In Intersil's approach, the standard MIL-STD-883 Method 1019.7 high dose rate qualification testing will be supplemented by baseline low dose rate characterization testing on a part-by-part basis.

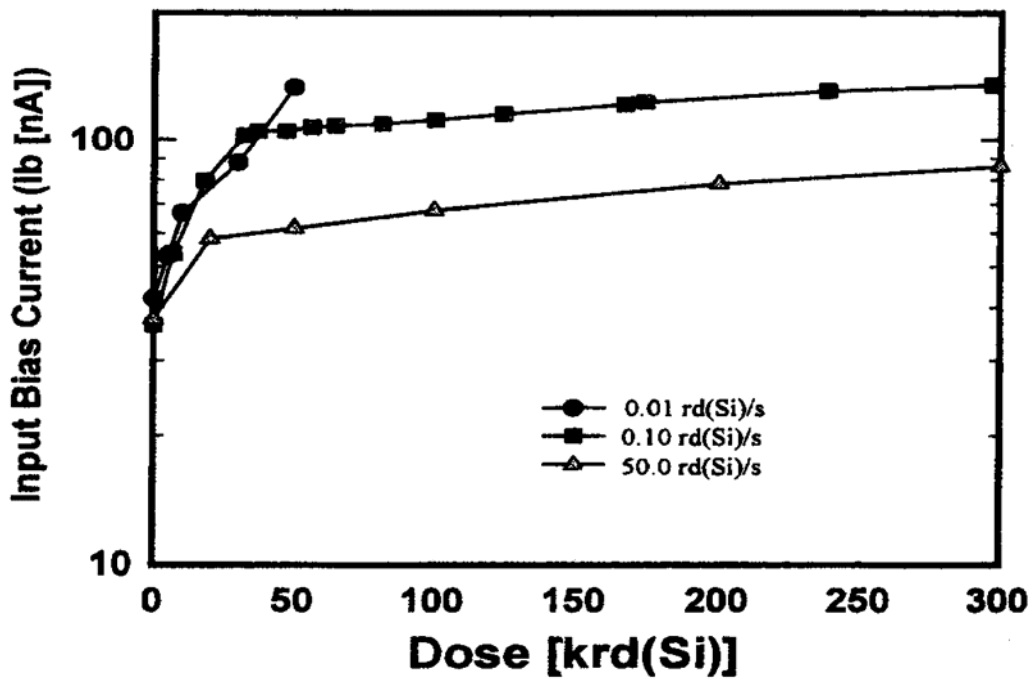
To this end Intersil has procured a J. L. Shepherd and Associates model 484 low dose rate  $^{60}\text{Co}$  irradiator. This equipment is capable of dose rates of  $.01\text{rad}(\text{Si})/\text{s}$  and is now on line in Intersil's Palm Bay, Florida facility. Appropriate fixturing to perform these tests in accordance with the requirements of MIL-STD-883 Method 1019.7 has been constructed and installed. All testing is performed under bias. The fixturing uses the same test boards as the Intersil high dose rate Gammacell 220 <sup>TM</sup> facility; the test configuration and bias voltages are the same as well, insuring a valid comparison between the results of low and high dose rate testing. During irradiation the devices under test are enclosed in a PbAl box, as specified by MIL-STD-883 Method 1019.7. in order to filter out low-energy photons caused by backscattering effects. We use Far West Technology, Inc. (Goleta, CA) model FWT-70 Opti-Chromic radiochromic dosimeters to monitor accumulated dose. Test samples are taken from burned-in production part inventory, as burnin and its attendant heat treats have been shown [4] to play a role in low dose rate response.

### **3: Low Dose Rate Testing of the Intersil HS9-139RH Quad Comparator**

The radiation hardened HS9-139RH consists of four independent single or dual supply voltage comparators on a single monolithic substrate. The common mode input voltage range includes ground, even when operated from a single supply, and the low supply current makes these comparators suitable for low power applications. The HS9-139RH was designed to directly interface with TTL and CMOS logic levels.

The HS9-139RH is fabricated on the Intersil dielectrically isolated Radiation Hardened Silicon Gate (RSG) process, which provides immunity to single-event latchup and the capability of highly reliable performance in the total dose radiation environment. Standard Microcircuit Drawings (SMD) for radiation-hardened QML devices are controlled by the Defense Supply Center in Columbus, OH (DSCC). Detailed electrical specifications for the HS9-139RH are contained in SMD 5962-98613. The Intersil Web site provides a "hot-link" for downloading the data sheet and SMD for this part.

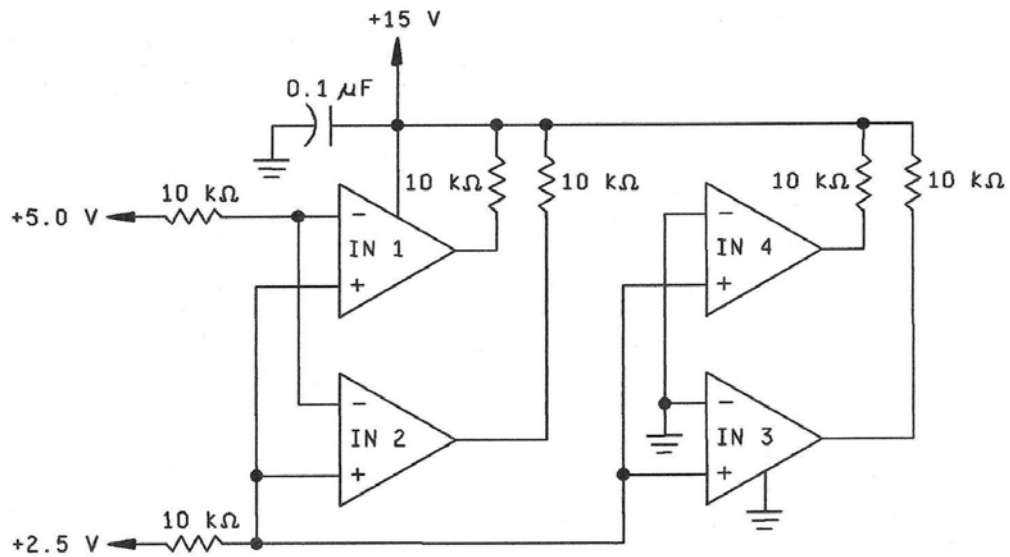
The first published data on the Intersil HS9-139RH in the low dose rate environment appeared in 1999 [5]. In a collaborative paper with Intersil, Navy researchers reported results of low dose rate testing at  $10\text{mrad}(\text{Si})/\text{s}$  and  $100\text{mrad}(\text{Si})/\text{s}$ , with a control group irradiated at  $50\text{rad}(\text{Si})/\text{s}$ . The paper also reports results of an accelerated low dose rate test at  $10\text{rad}(\text{Si})/\text{s}$  at an ambient temperature of  $100^\circ\text{C}$ . The HS9-139RH showed some degradation after  $300\text{krad}(\text{Si})$  at low dose rate, but the devices remained within their post-radiation and temperature specification limits to a total dose of  $300\text{krad}(\text{Si})$ . In Figure 2 we show plots [5] of input bias current for dose rates of  $50\text{rad}(\text{Si})/\text{s}$ ,  $.1\text{rad}(\text{Si})/\text{s}$  and  $.01\text{rad}(\text{Si})/\text{s}$ . This response is consistent with gain degradation of the PNP transistors used in the input differential pair.



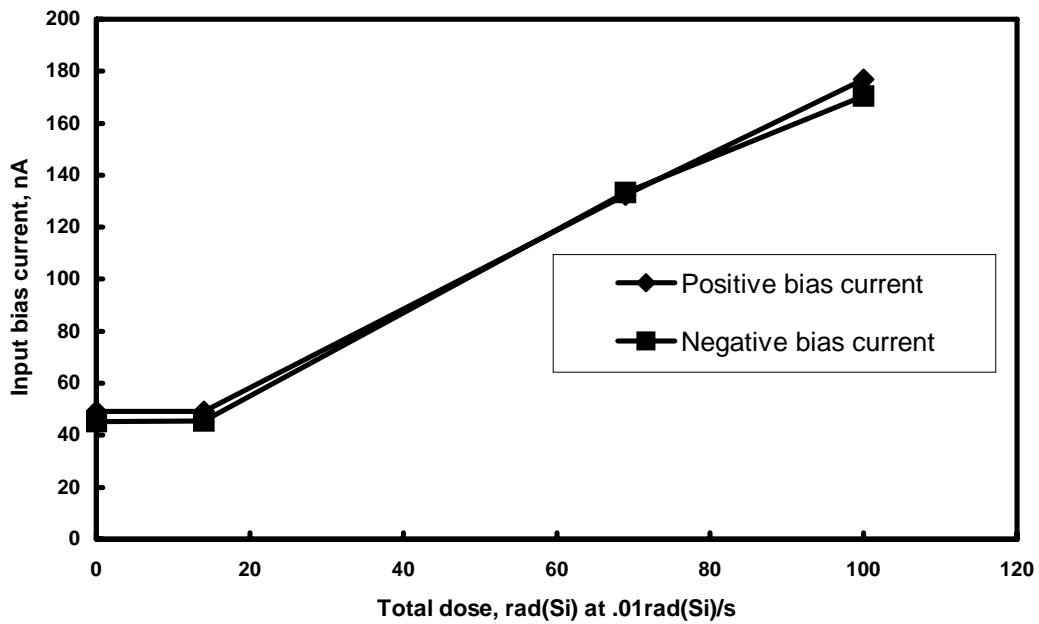
**Figure 2:** HS9-139RH input bias current as a function of total dose [5], for dose rates of 50rad(Si)/s, .1rad(Si)/s and .01rad(Si)/s. The maximum post-radiation bias current specification is 1uA.

A baseline 100krad(Si) low dose rate test of the Intersil HS9-139RH quad comparator is complete. This test had intermediate down points of 14krad(Si) and 69krad(Si). Samples were irradiated at a dose rate of 10 millirad(Si)/s. This test used the J. L. Shepherd and Associates model 484 low dose rate irradiator installed at the Intersil Palm Bay, Florida facility. The sample size for this test was 18, and the parts were irradiated per MIL-STD-883 Method 1019 using the irradiation bias configuration specified in SMD 5962-98613 (see Figure 3, below). This irradiation bias is used to permit a more direct comparison between low and high dose rate results. Note also that the 'all pins grounded' configuration is not always worst case, and Intersil researchers have reported biased irradiation to be in fact worst-case for some RSG parts. Downpoint testing is performed using the standard automated test equipment (ATE) procedure used for production testing.

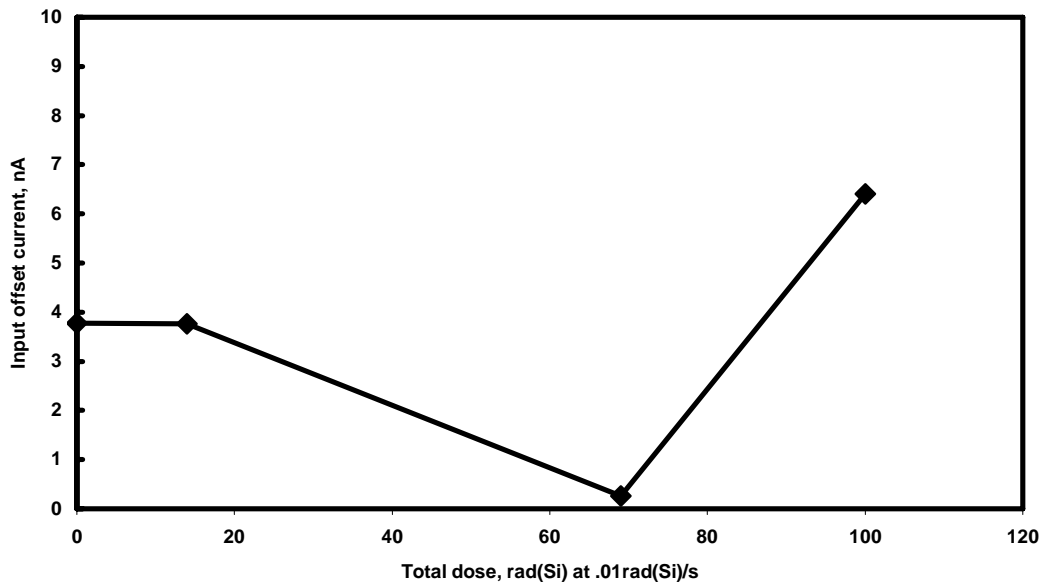
The pre-irradiation, 14krad(Si), 69krad(Si) and 100krad(Si) results are summarized in Figures 4 – 9, below.



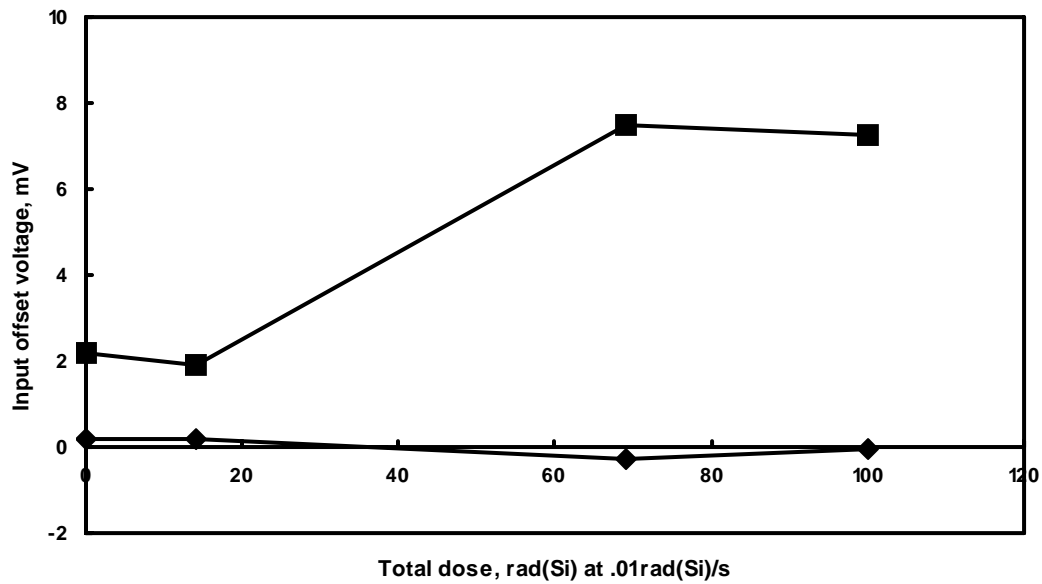
**Figure 3:** HS9-139RH irradiation bias configuration per SMD 5962-98613



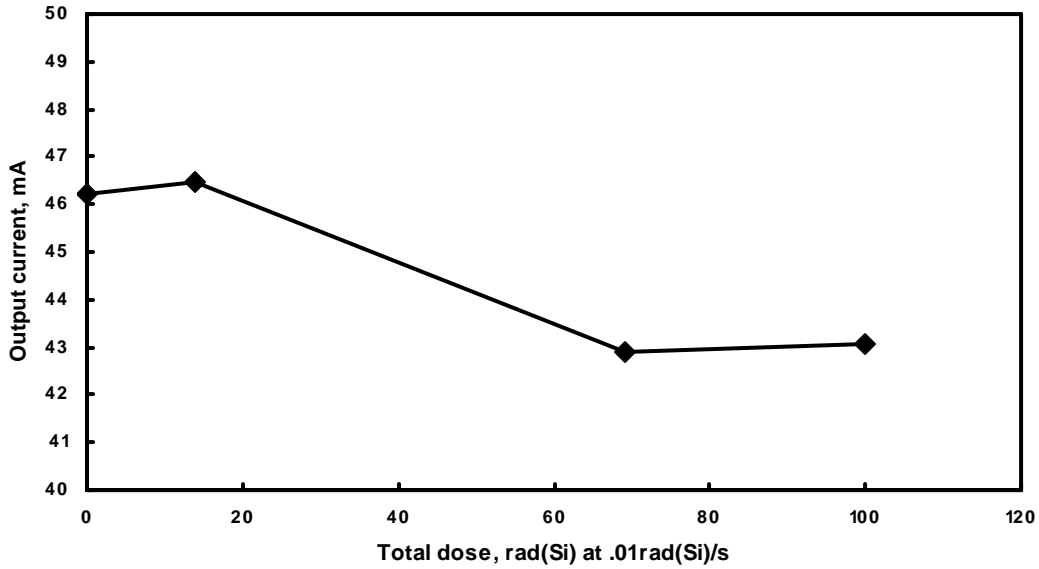
**Figure 4:** HS9-139RH average input bias current, positive and negative (inverting/noninverting) inputs, as a function of total dose. Sample size is 18 parts. The maximum post-radiation input bias current specification is 1uA.



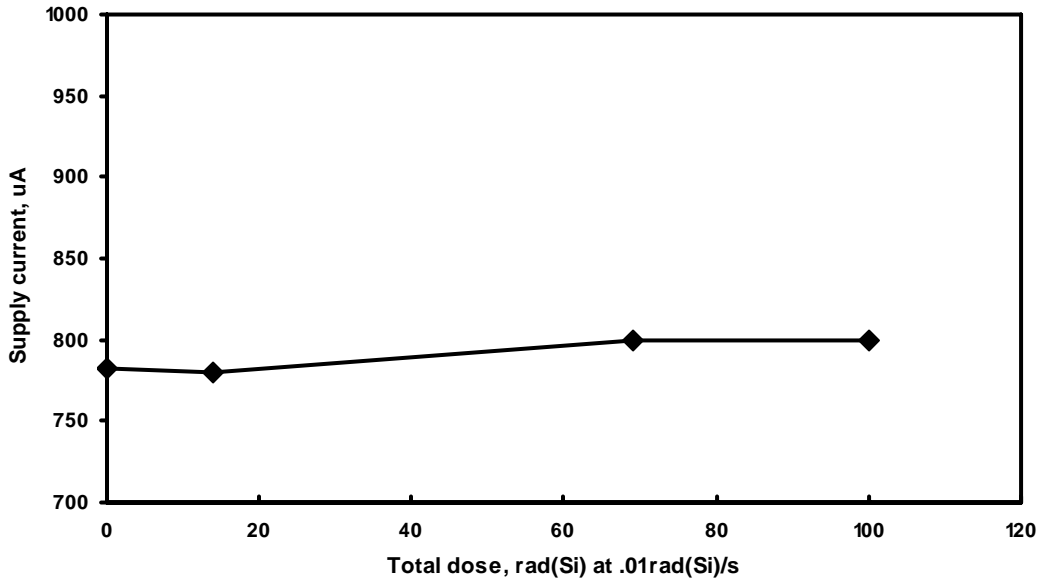
**Figure 5:** HS9-139RH average input offset current as a function of total dose. Sample size is 18 parts. The maximum post-radiation input offset current specification is 600nA.



**Figure 6:** HS9-139RH average input offset voltage as a function of total dose. Sample size is 18 parts. The maximum post-radiation input offset voltage specification is 8mV.

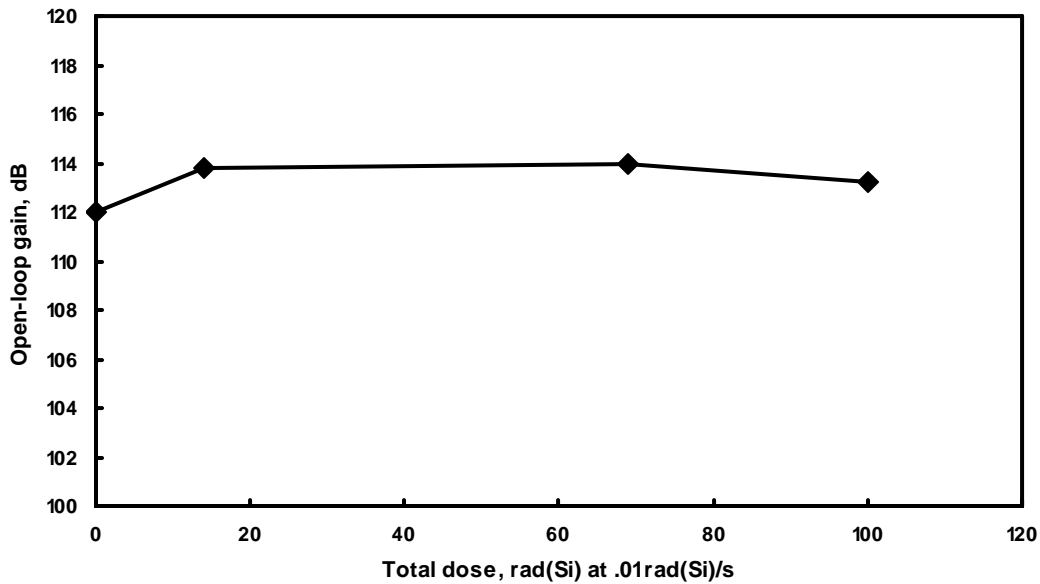


**Figure 7:** HS9-139RH average output drive current as a function of total dose. Sample size is 18 parts. The minimum post-radiation output drive current specification is 6mA.



**Figure 8:** HS9-139RH average quiescent power supply current as a function of total dose. Sample size is 18 parts. The maximum post-radiation power supply current specification is 3mA.





**Figure 9:** HS9-139RH average open-loop gain as a function of total dose. Sample size is 18 parts. The minimum post-radiation open-loop gain specification is 88dB (25V/mV).

The HS9-139RH is built in the Intersil RSG process, which has been shown to have moderate ELDRS sensitivity. The data shows a gradual increase of input bias current, which is consistent with low-current beta degradation of the PNP input devices, but remains well within the 1uA post-radiation specification. The input offset current is very stable. The input offset voltage average value remained nearly constant, but the range of this parameter increased although no parts failed the 8mV post-radiation limit. Output drive current, power supply current and open-loop gain showed little change. We conclude that the HS9-139RH shows only moderate dose rate sensitivity up to a level of 100krad(Si).

#### 4: Conclusion

This document provides technical background, test conditions, data and conclusions of a low dose rate test of the HS9-139RH performed at Intersil Corporation. The HS9-139RH showed only moderate dose rate sensitivity after 100krad(Si) low dose rate irradiation.

#### 5: References

- [1] A.H. Johnston, C.I. Lee and B. G. Rax, 'Enhanced Damage in Bipolar Devices at Low Dose Rates: Effects at Very Low Dose Rates', *IEEE Transactions on Nuclear Science*, December 2002.
- [2] R. L. Pease, S. S. McClure, A. H. Johnston, J. Gorelick, T. L. Turflinger, M. Gehlhausen, J. Krieg, T. Carriere and M. R. Shaneyfelt, 'An Update Data Compendium

of Enhanced Low Dose Sensitive (ELDRS) Bipolar Linear Circuits', *IEEE 2001 Radiation Effects Data Workshop Record, July 2001.*

[3] W. Abare, F. Brueggeman, R. L. Pease, J. Krieg and M. Simons, 'Comparative Analysis of Low Dose Rate, Accelerated and Standard Cobalt-60 Radiation Response Data for a Low-Dropout Voltage Regulator and a Voltage Reference', *IEEE 2002 Radiation Effects Data Workshop Record, July 2001.*

[4] M. R. Shaneyfelt et al., 'Elimination of Enhanced Low-Dose-Rate Sensitivity and Thermal Stress Effects in Linear Bipolar Devices', *IEEE Transactions on Nuclear Science, December 2002.*

[5] J. F. Krieg, J. L. Titus, D. Emily, M. Gehlhausen, J. W. Swonger and D. C. Platteter, 'Enhanced Low Dose Rate Sensitivity (ELDRS) in a Voltage Comparator which only Utilizes Complementary Vertical NPN and PNP Transistors', *IEEE Transactions on Nuclear Science, December 1999.*

**Document generated 30 April 2006**

**Nick van Vonno**

**Intersil Corporation**