



Total dose testing of the IS-2100ARH high frequency half bridge driver

**Nick van Vonno
Intersil Corporation**

Revision 0
June 2011

Table of Contents

- 1. Introduction**
- 2. Reference Documents**
- 3. Part Description**
- 4. Test Description**
 - 4.1 Irradiation facility**
 - 4.2 Test fixturing**
 - 4.3 Characterization equipment and procedures**
 - 4.4 Experimental Matrix**
 - 4.5 Downpoints**
- 5 Results**
 - 5.1 Test results**
 - 5.2 Variables data**
- 6 Discussion**
- 7 Conclusion**
- 8 Appendices**
- 9 Document revision history**

1. Introduction

This report reports the results of a low and high dose rate total dose test of the IS-2100ARH high frequency half bridge N-channel MOSFET driver. The test was conducted in order to determine the sensitivity of the part to the total dose environment and to determine if dose rate and bias sensitivity exist.

2. Reference Documents

MIL-STD-883G test method 1019.7

IS-2100ARH data sheet

DSCC Standard Microcircuit Drawing (SMD) 5962-99536

3: Part Description

The IS-2100ARH is a radiation hardened, high frequency, 130V half bridge N-channel MOSFET driver IC, which is functionally similar to industry standard 2100 types. The low side and high side gate drivers are independently controlled. This gives the user maximum flexibility in dead-time selection and driver protocol. In addition, the device features on-chip error detection and correction circuitry, which monitors the state of the high-side latch and compares it to the HIN signal. If they disagree, a set or reset pulse is generated to correct the high-side latch. This feature protects the high-side latch from single event upset (SEU) in the high-energy ion environment.

Specifications for radiation hardened MIL-PRF-38535 (QML) devices are controlled by Standard Microcircuit Drawings (SMD) as issued by the Defense Logistics Agency (DLA) Land and Maritime in Columbus, OH. Detailed electrical specifications for the IS-2100ARH are contained in SMD 5962-99536, which must be used when ordering. A "hotlink" is provided on the Intersil website for downloading this document.

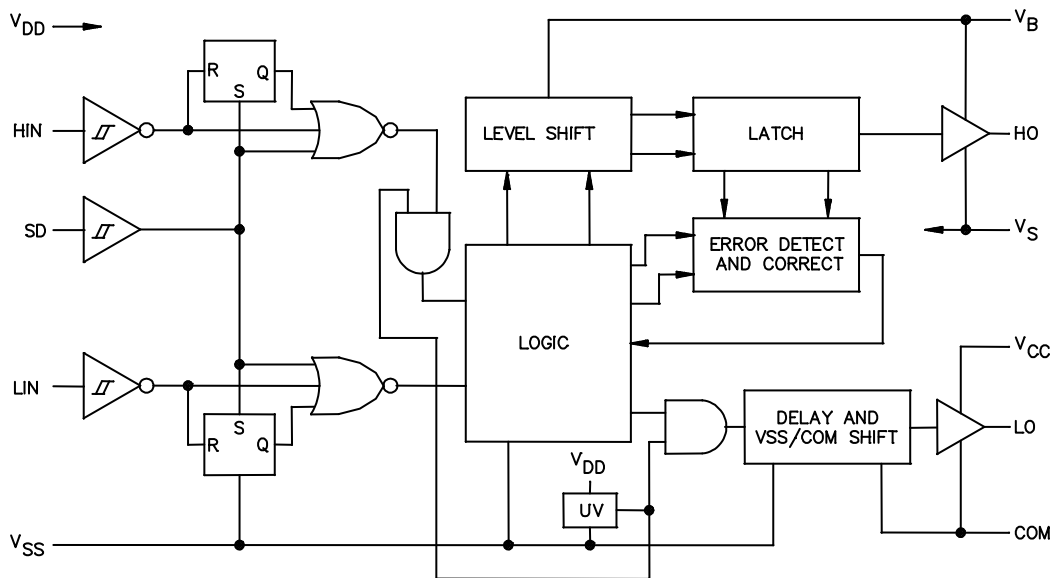

Figure 1: IS-2100ARH block diagram.

4: Test Description

4.1 Irradiation Facilities

High dose rate testing was performed using a Gammacell 220 ^{60}Co irradiator located in the Palm Bay, Florida Intersil facility. Low dose rate testing was performed on a subcontract basis at White Sands Missile Range (WSMR) Survivability, Vulnerability and Assessment Directorate (SVAD), White Sands, NM, using a vault-type ^{60}Co irradiator. The high dose rate irradiations were done at 55rad(Si)/s and the low dose rate work was performed at 0.010rad(Si)/s, both per MIL-STD-883 Method 1019.7. Dosimetry for both tests was performed using Far West Technology radiochromic dosimeters and readout equipment.

4.2 Test Fixturing

Figure 2 shows the configuration used for biased irradiation in conformance with Standard Microcircuit Drawing (SMD) 5962-99536.

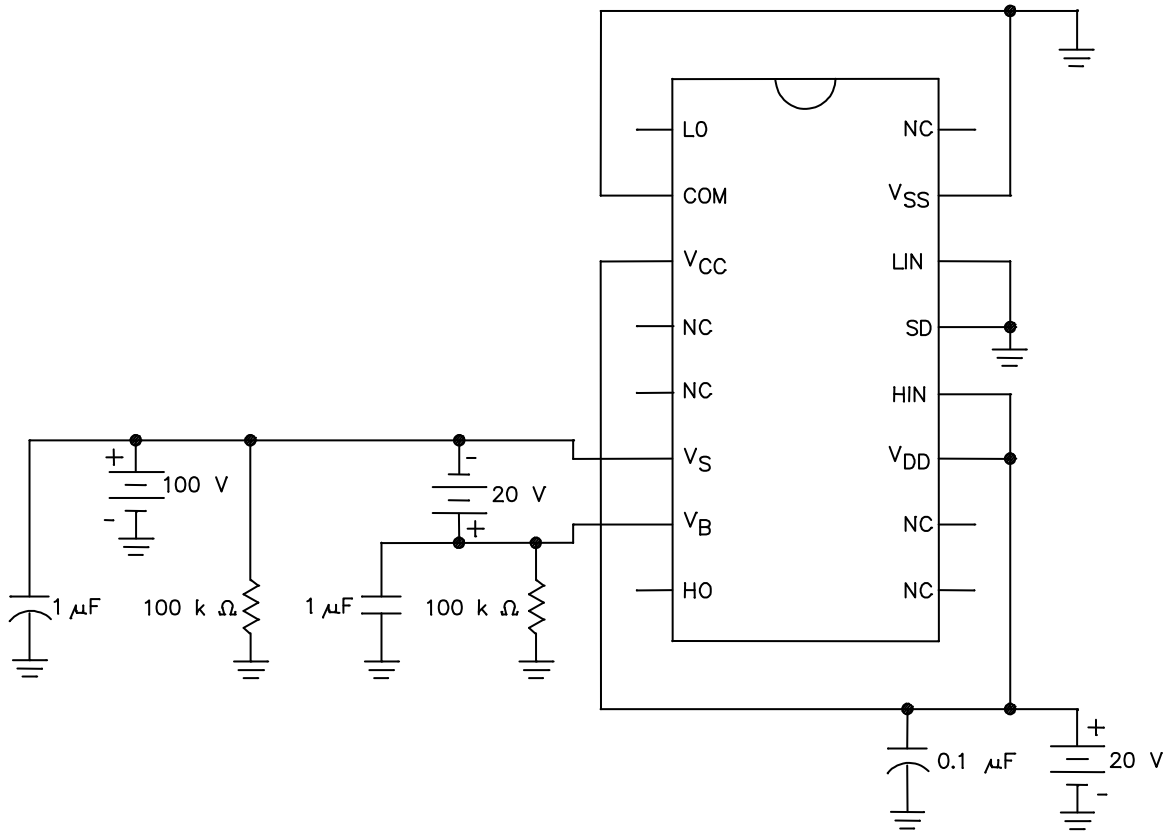

Figure 2: Irradiation bias configuration for the IS-2100ARH per Standard Microcircuit Drawing (SMD) 5962-99536.

4.3 Characterization equipment and procedures

All electrical testing was performed outside the irradiator using the production automated test equipment (ATE) with datalogging at each downpoint. Downpoint electrical testing was performed at room temperature. Performing low dose rate testing at a remote site introduces some challenges, and shipping was performed in a foam container with a frozen Gelpack™ along with a strip chart temperature recorder in order to remain well within the temperature limits imposed by MIL-STD-883 Test Method 1019.7. Close coordination between the two organizations is required, and support by WSMR is gratefully acknowledged.

4.4 Experimental matrix

Total dose irradiation proceeded in accordance with the guidelines of MIL-STD-883 Test Method 1019.7. The experimental matrix consisted of five samples irradiated at high dose rate with all pins grounded, five samples irradiated at high dose rate under bias, five samples irradiated at low dose rate with all pins grounded and five samples irradiated at low dose rate under bias. One control unit was used.

Samples of the IS-2100ARH die were drawn from production lot DC834A, date code X0802ABCL, and were packaged in the standard hermetic 16-pin solder-sealed flatpack (CDFP4-F16) production package. Samples were processed through the standard burnin cycle before irradiation, as required by MIL-STD-883, and were screened to the SMD 5962-99536 limits at room, low and high temperatures prior to the test.

4.5 Downpoints

Planned downpoints for the tests were 0, 10, 25, 50, 100 and 150krad(Si) for the high and low dose rate tests. The biased low dose rate samples were run successfully to 50krad(Si) but all five were found to have failed catastrophically at the 100krad(Si) downpoint. Failure analysis of these devices was performed and determined the failures as being caused by electrical overstress.

5: Results

5.1 Test results

We report results of a total dose test of the IS-2100ARH half bridge N-channel MOSFET driver. Parts were tested at low and high dose rate under biased and unbiased conditions as outlined in MIL-STD-883 Test Method 1019.7. Five samples each were irradiated at low and high dose rate under biased and unbiased conditions. The biased low dose rate samples were run successfully to 50krad(Si) but were found to have failed catastrophically at the 100krad(Si) downpoint. Failure analysis of these devices was performed and determined the failures as being caused by electrical overstress. The three other experimental cells were successfully run to 150krad(Si) without any problems.

All low dose rate samples passed the SMD criteria at the 50krad(Si) downpoint. All high dose rate samples passed the SMD rad criteria through 150krad(Si). The part was found to display no discernible dose rate sensitivity or bias sensitivity, with very stable performance out to the maximum total dose level for each cell. Nonetheless the part must be considered low dose rate sensitive as the biased low dose rate test effectively proceeded to 50krad(Si) while the other three tests were run out to 150krad(Si). The demonstration of true low dose rate insensitivity for both bias conditions will require a biased low dose rate test to the 150krad(Si) level.

5.2 Variables data

The plots in Figures 3 through 39 show data at all downpoints, with the biased low dose rate data truncated at 50krad(Si). The plots show the median of key parameters as a function of total dose for each of the four irradiation conditions. We chose to plot the median for these parameters due to the relatively small sample sizes. Also shown are the SMD parametric limits and ATE limits; the ATE limits are test equipment related and are not specified in the SMD.

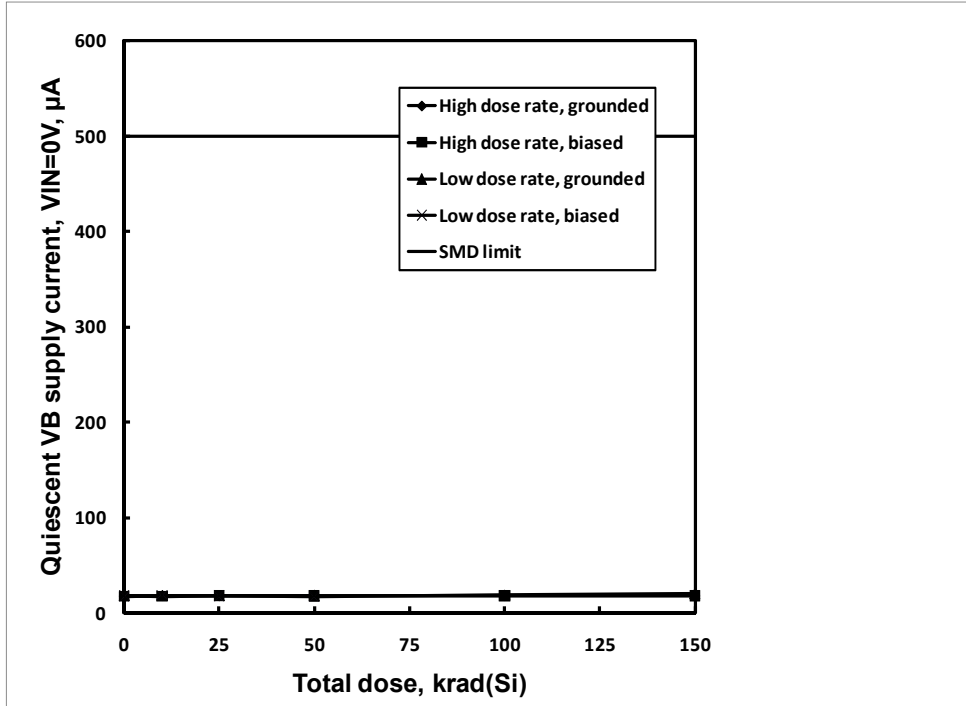

Figure 3: IS-2100ARH median quiescent VB supply current, VIN = 0V, as a function of total dose irradiation at low and high dose rate for the unbiased (all pins grounded) and the biased (per Figure 2) cases. The low dose rate was 0.01rad(Si)/s and the high dose rate 50rad(Si)/s. Sample size for each cell was 5. The SMD limit is 500µA maximum.

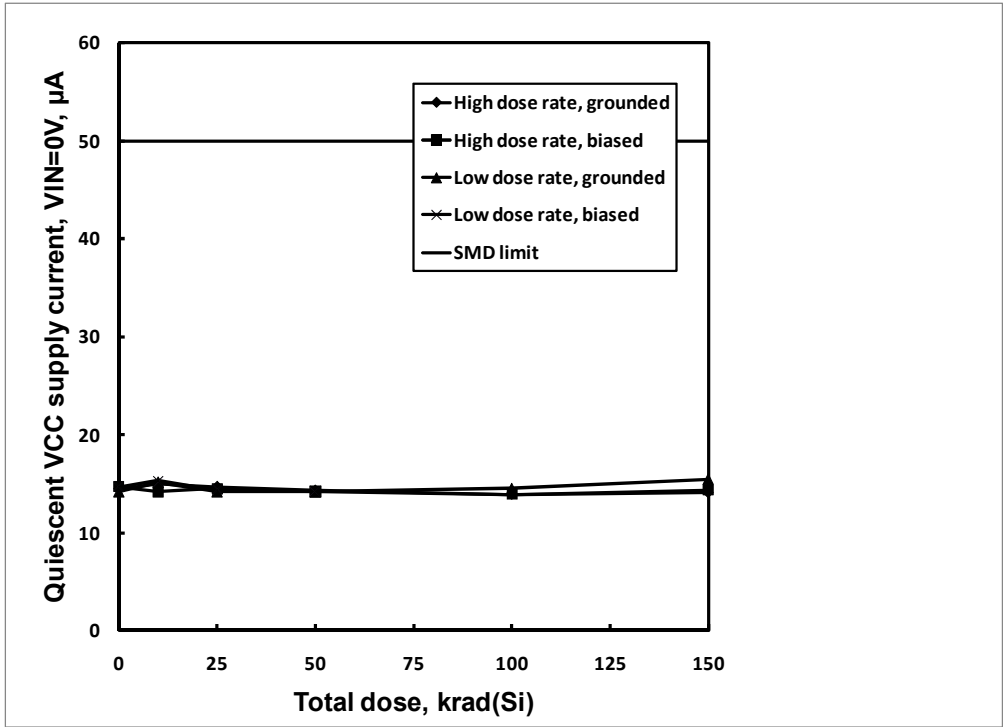

Figure 4: IS-2100ARH median quiescent VCC supply current, VIN = 0V, as a function of total dose irradiation at low and high dose rate for the unbiased (all pins grounded) and the biased (per Figure 2) cases. The low dose rate was 0.01rad(Si)/s and the high dose rate 55rad(Si)/s. Sample size for each cell was 5. The SMD limit is 50µA maximum.

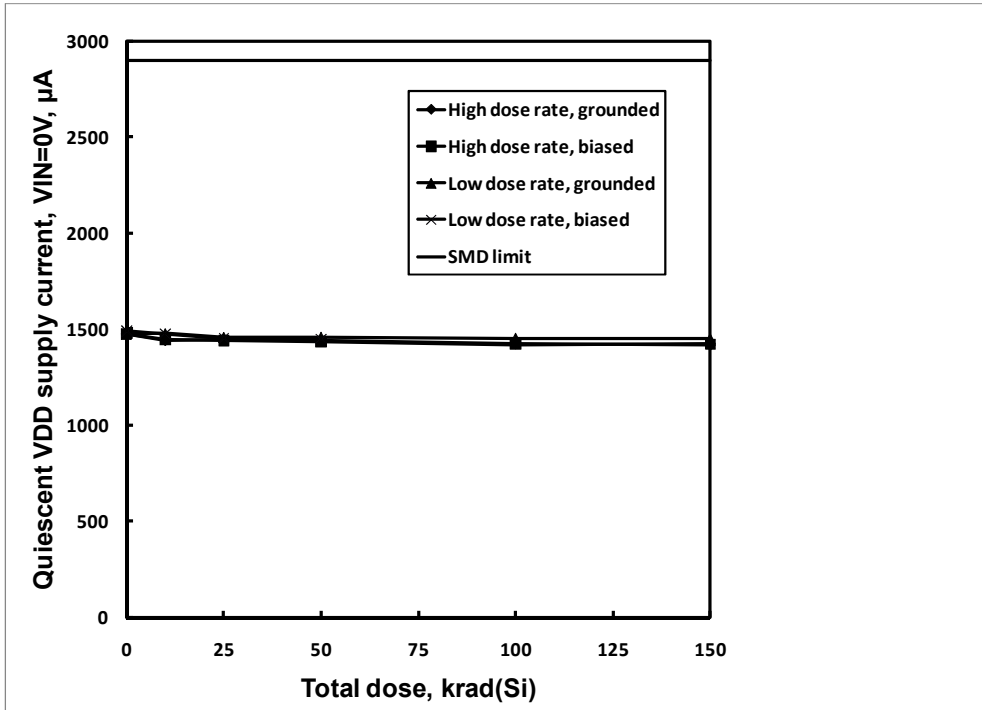

Figure 5: IS-2100ARH median quiescent VDD supply current, VIN = 0V, as a function of total dose irradiation at low and high dose rate for the unbiased and biased cases. The SMD limit is 2900µA maximum.

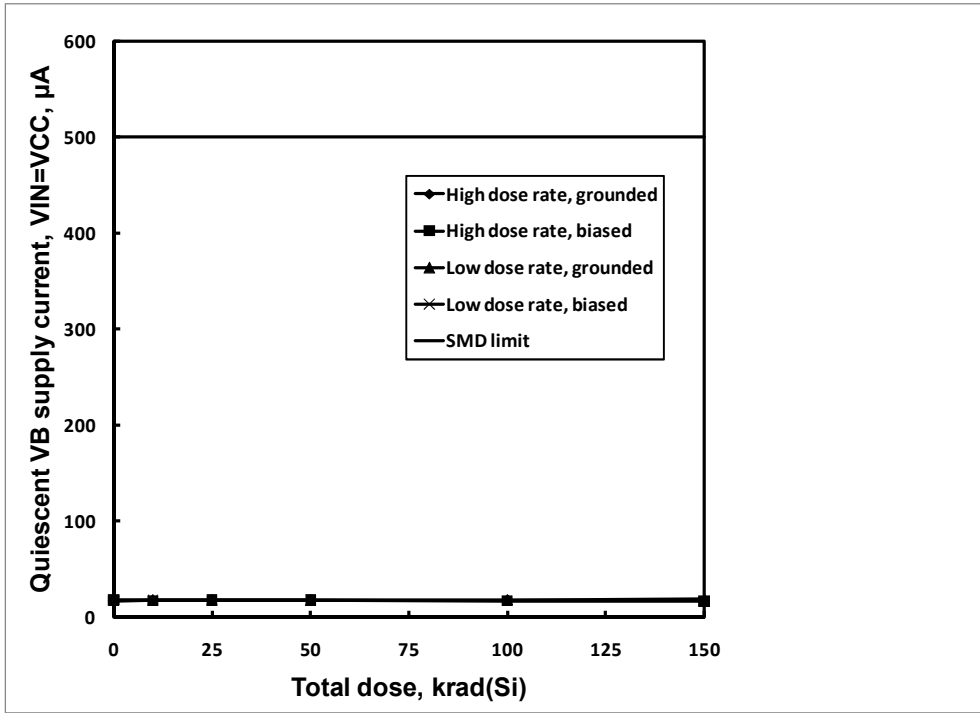

Figure 6: IS-2100ARH median quiescent VB supply current, VIN = VCC, as a function of total dose irradiation at low and high dose rate for the unbiased and biased cases. The SMD limit is 500µA maximum.

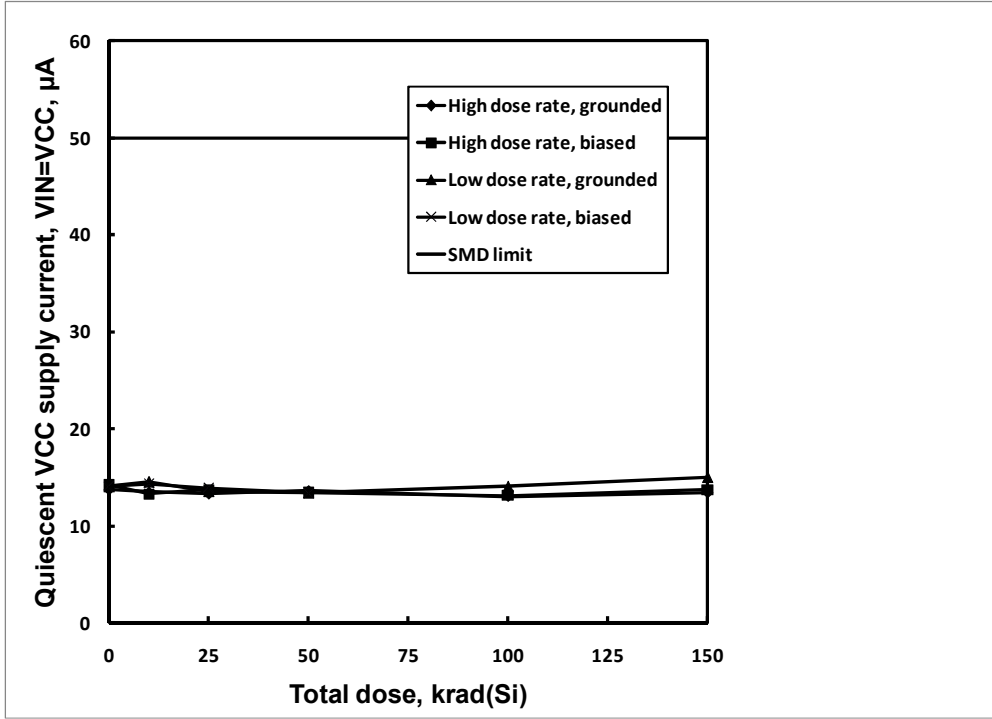

Figure 7: IS-2100ARH median quiescent VCC supply current, VIN = VCC, as a function of total dose irradiation at low and high dose rate for the unbiased and biased cases. The SMD limit is 50µA maximum.

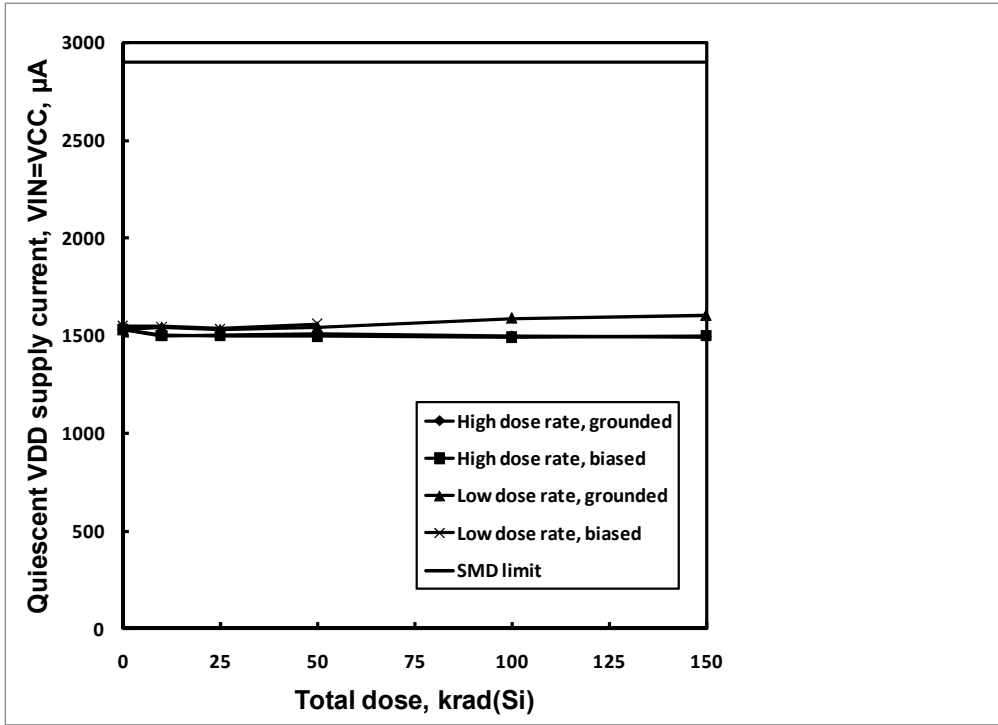

Figure 8: IS-2100ARH median quiescent VDD supply current, $V_{IN} = V_{CC}$, as a function of total dose irradiation at low and high dose rate for the unbiased and biased cases. The SMD limit is 2900µA maximum.

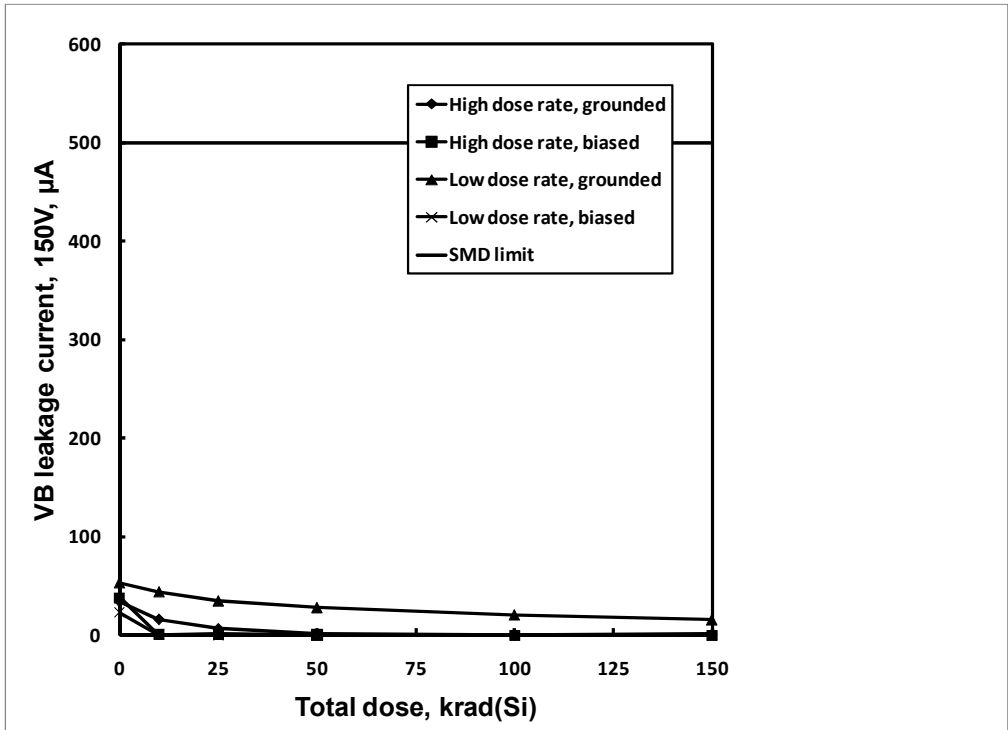

Figure 9: IS-2100ARH median VB supply leakage current at 150V as a function of total dose irradiation at low and high dose rate for the unbiased and biased cases. The SMD limit is 500µA maximum.

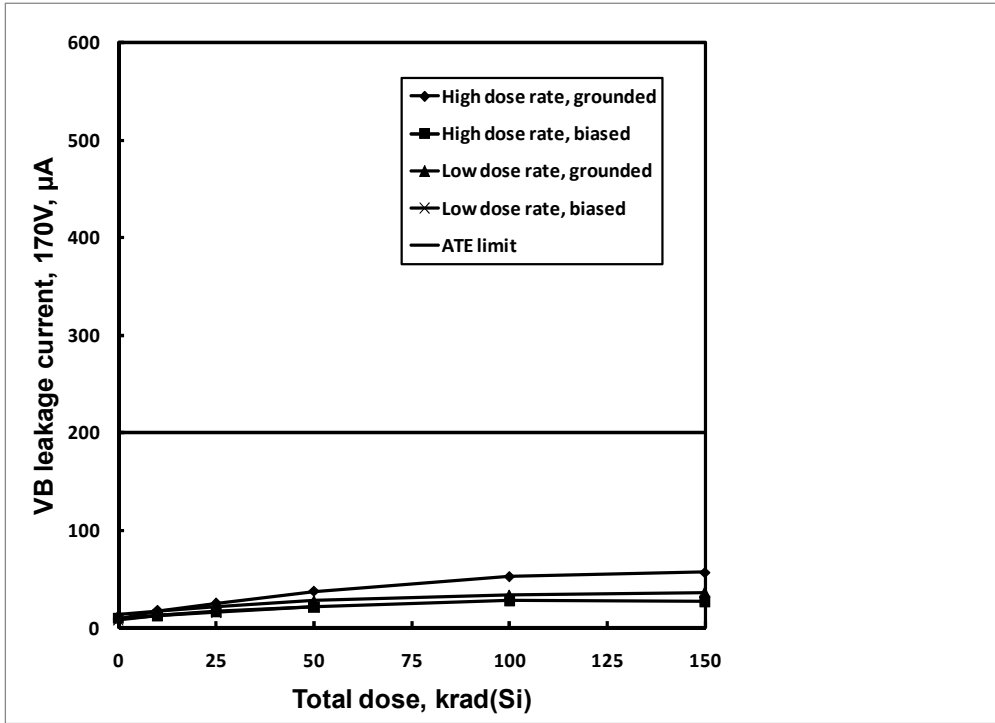

Figure 10: IS-2100ARH median VB supply leakage current at 170V as a function of total dose irradiation at low and high dose rate for the unbiased and biased cases. This informational parameter is not specified in the SMD but has a 200µA maximum limit.

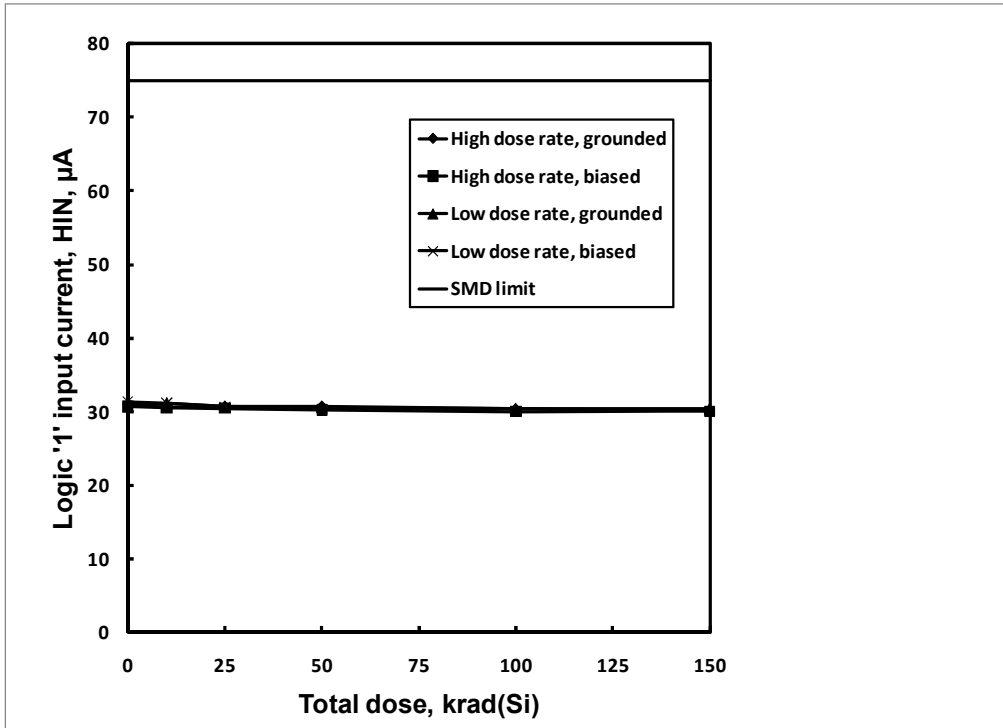

Figure 11: IS-2100ARH median HIN logic '1' input current as a function of total dose irradiation at low and high dose rate for the unbiased and biased cases. The SMD limit is 75µA maximum.

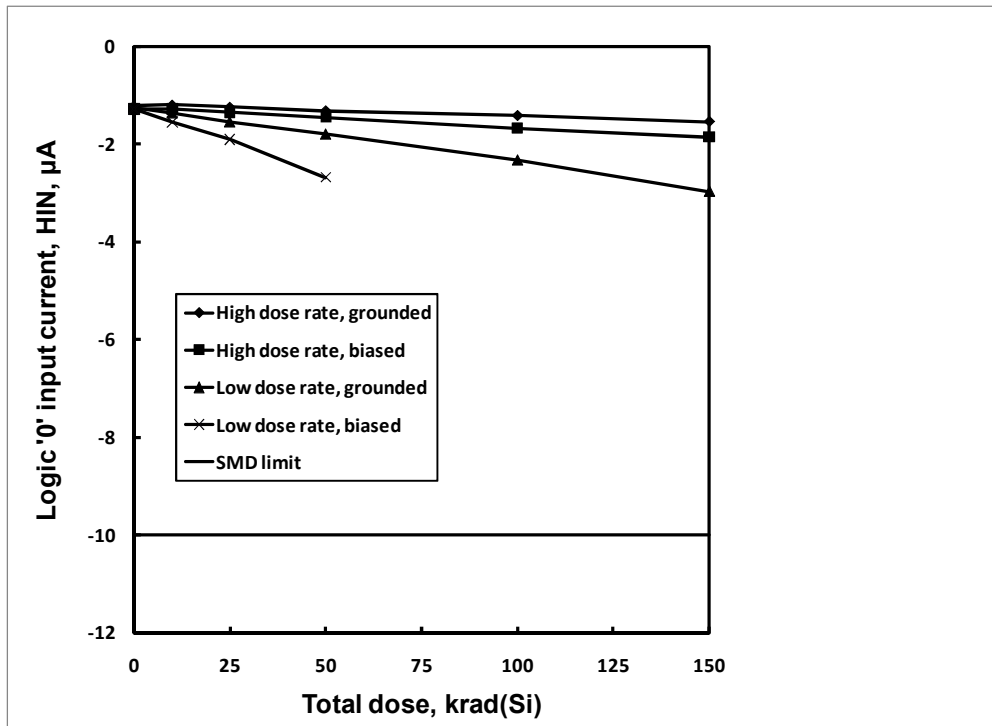

Figure 12: IS-2100ARH median HIN logic '0' input current as a function of total dose irradiation at low and high dose rate for the unbiased and biased cases. The SMD limit is $-10\mu\text{A}$ maximum.

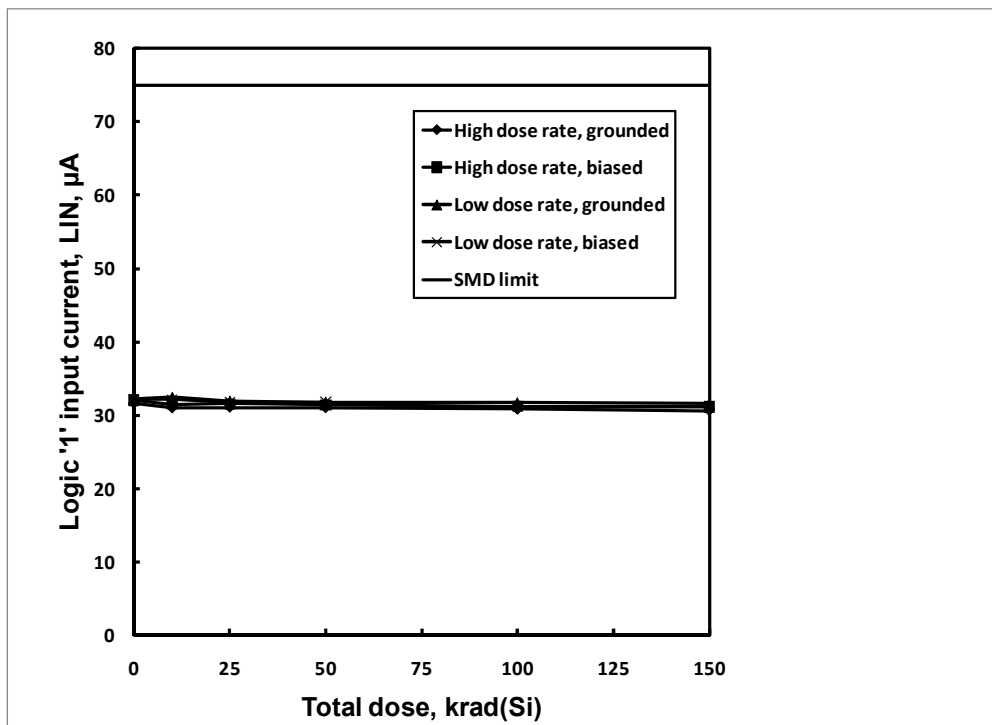

Figure 13: IS-2100ARH median LIN logic '1' input current as a function of total dose irradiation at low and high dose rate for the unbiased and biased cases. The SMD limit is $75\mu\text{A}$ maximum.

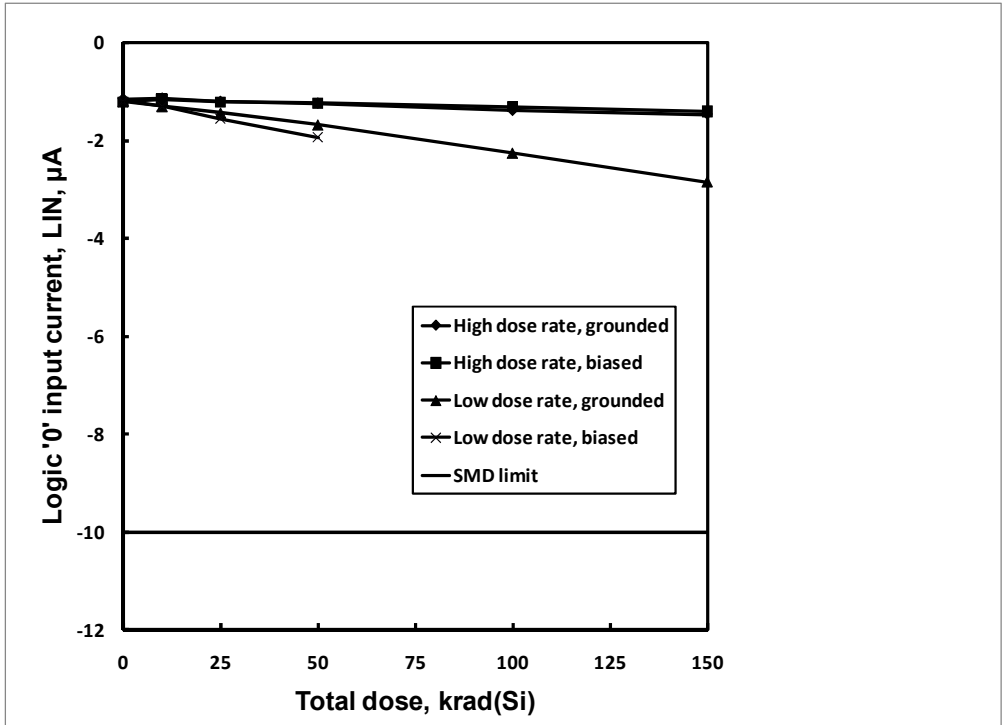

Figure 14: IS-2100ARH median LIN logic '0' input current as a function of total dose irradiation at low and high dose rate for the unbiased and biased cases. The SMD limit is -10µA maximum.

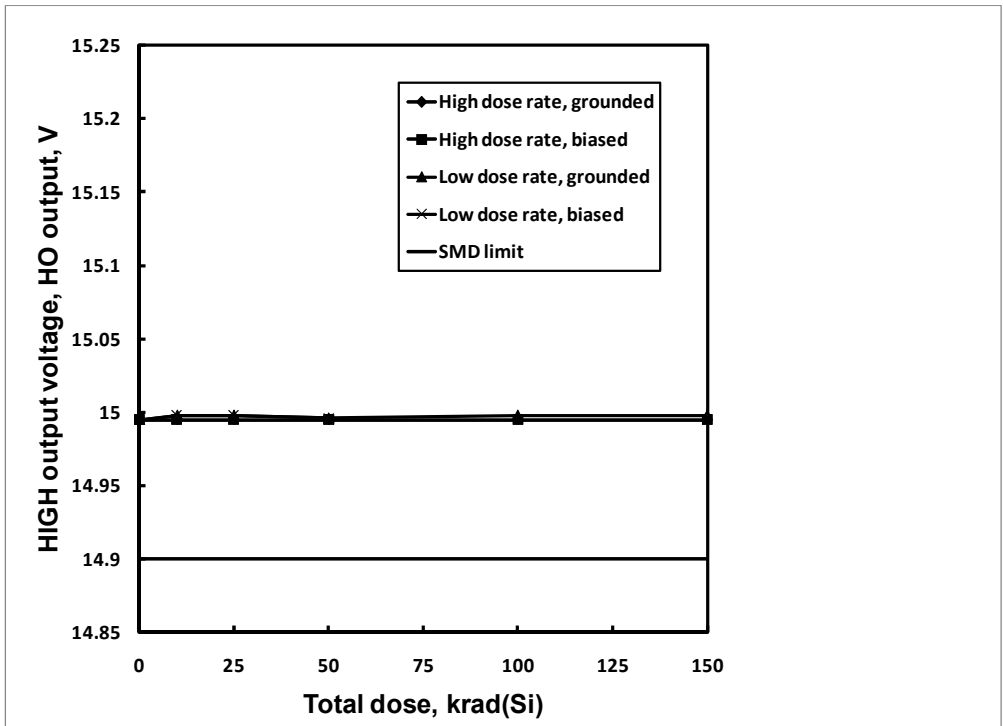

Figure 15: IS-2100ARH median HIGH level output voltage, HO output, as a function of total dose irradiation at low and high dose rate for the unbiased and biased cases. The SMD limit is 14.9V minimum.

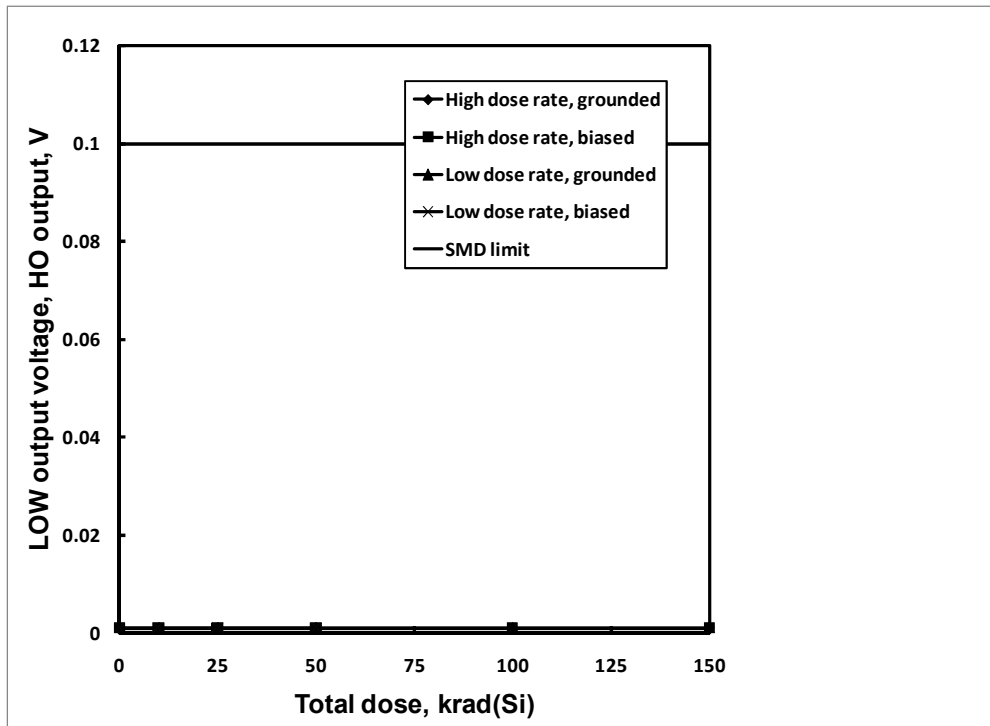

Figure 16: IS-2100ARH median LOW level output voltage, HO output, as a function of total dose irradiation at low and high dose rate for the unbiased and biased cases. The SMD limit is 0.1V maximum.

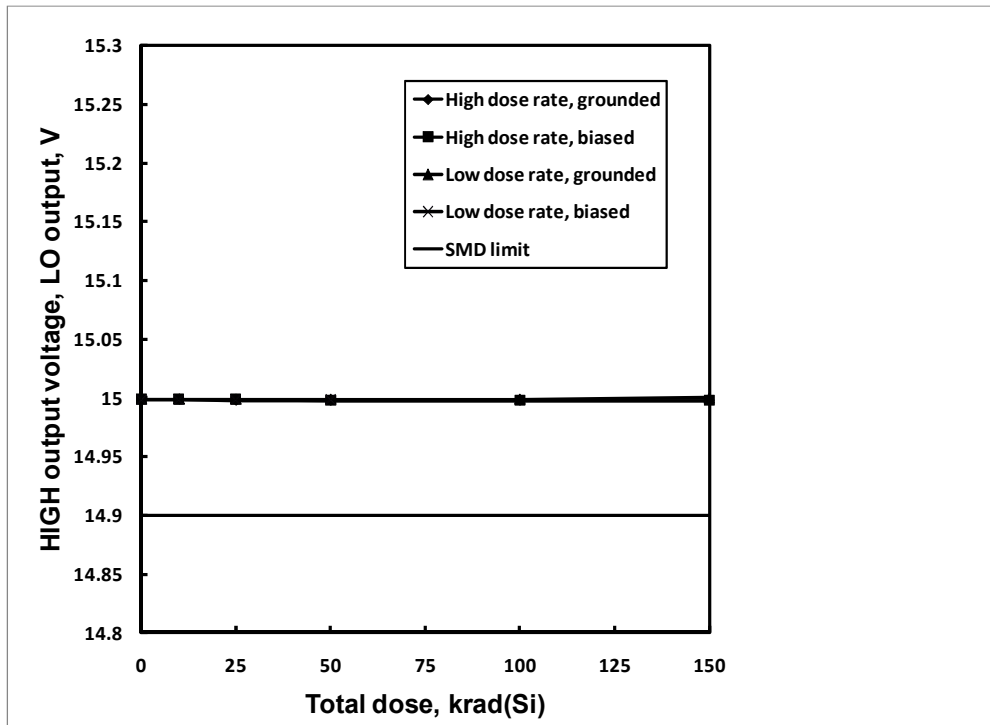

Figure 17: IS-2100ARH median HIGH level output voltage, LO output, as a function of total dose irradiation at low and high dose rate for the unbiased and biased cases. The SMD limit is 14.9V minimum.

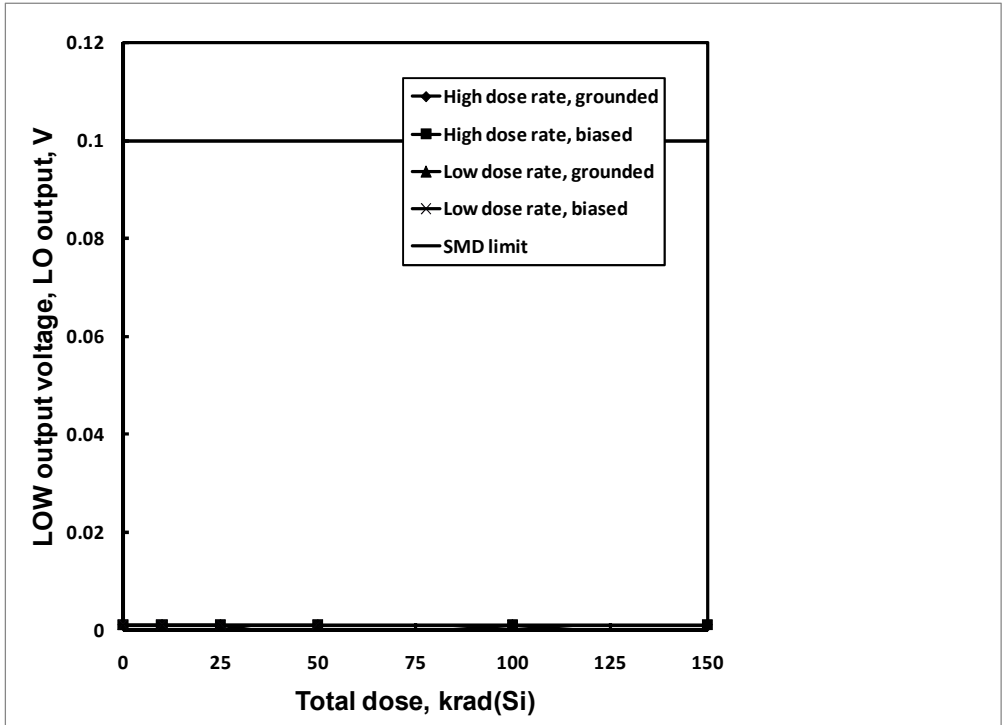

Figure 18: IS-2100ARH median LOW level output voltage, LO output, as a function of total dose irradiation at low and high dose rate for the unbiased and biased cases. The SMD limit is 0.1V maximum.

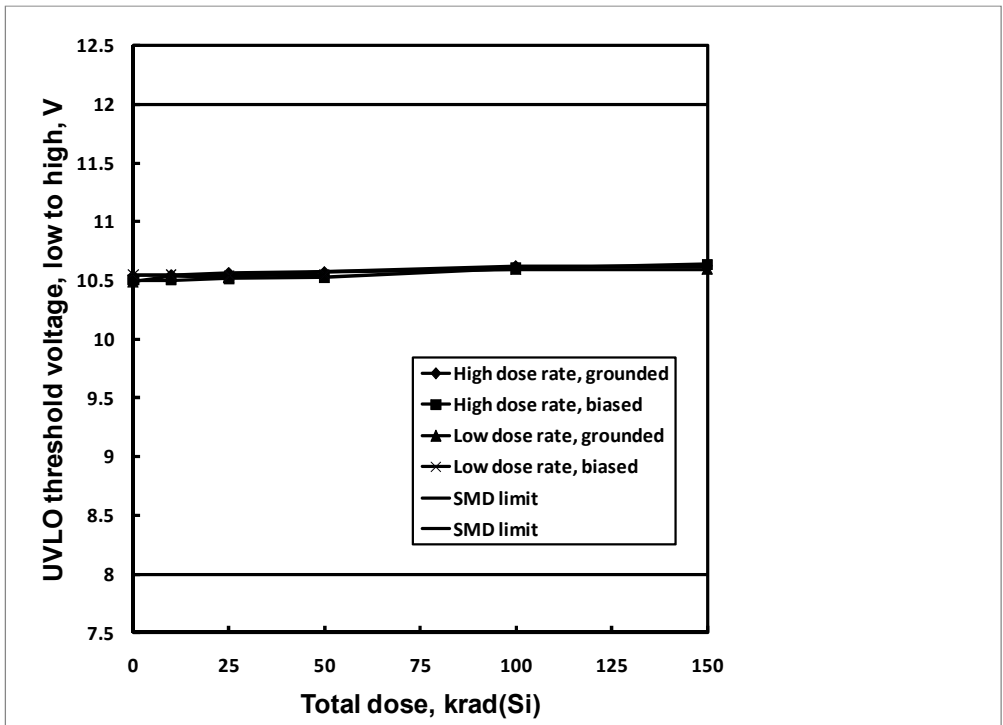

Figure 19: IS-2100ARH median undervoltage lockout threshold voltage, LOW to HIGH, as a function of total dose irradiation at low and high dose rate for the unbiased and biased cases. The SMD limits are 8.0V to 12.0V.

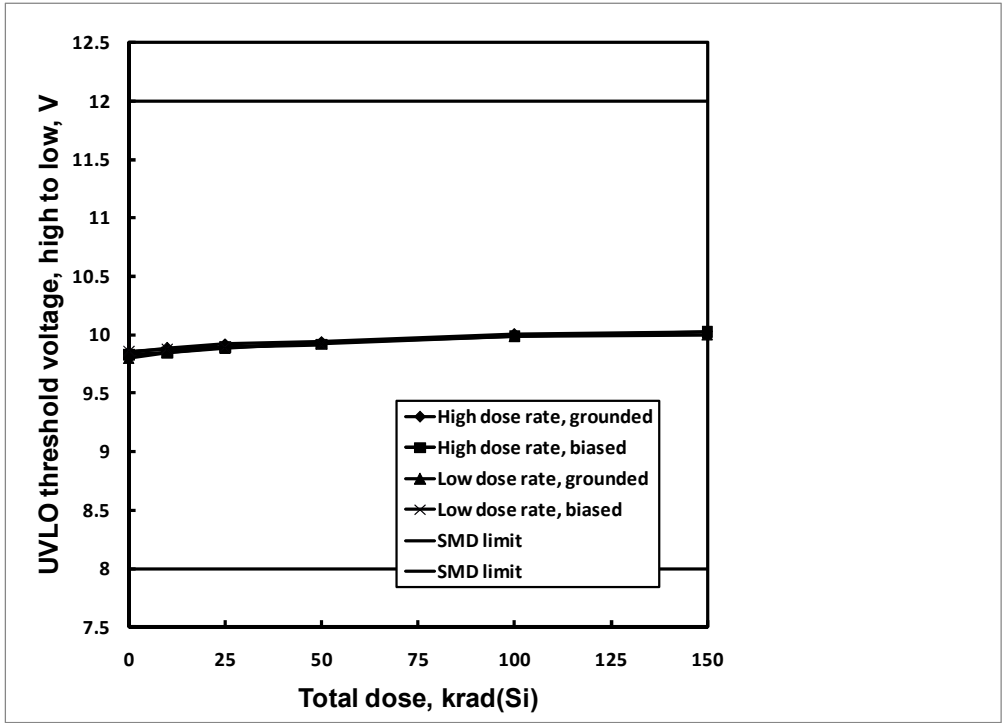

Figure 20: IS-2100ARH median undervoltage lockout threshold voltage, HIGH to LOW, as a function of total dose irradiation at low and high dose rate for the unbiased and biased cases. The SMD limits are 8.0V to 12.0V.

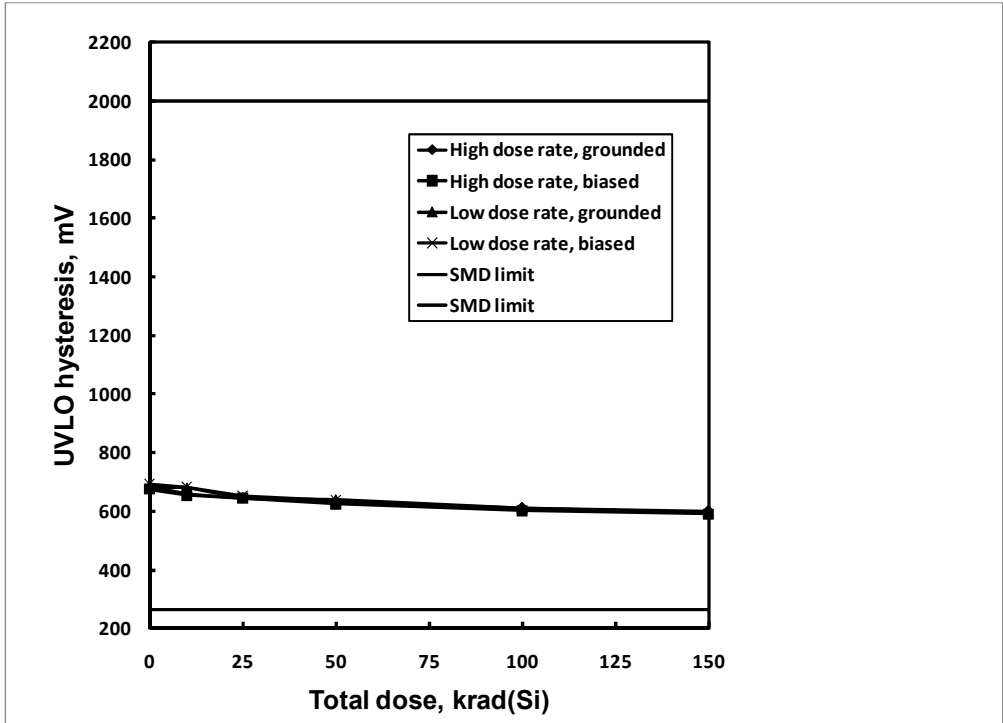

Figure 21: IS-2100ARH median undervoltage lockout threshold voltage hysteresis as a function of total dose irradiation at low and high dose rate for the unbiased and biased cases. The SMD limits are 250mV to 2000mV.

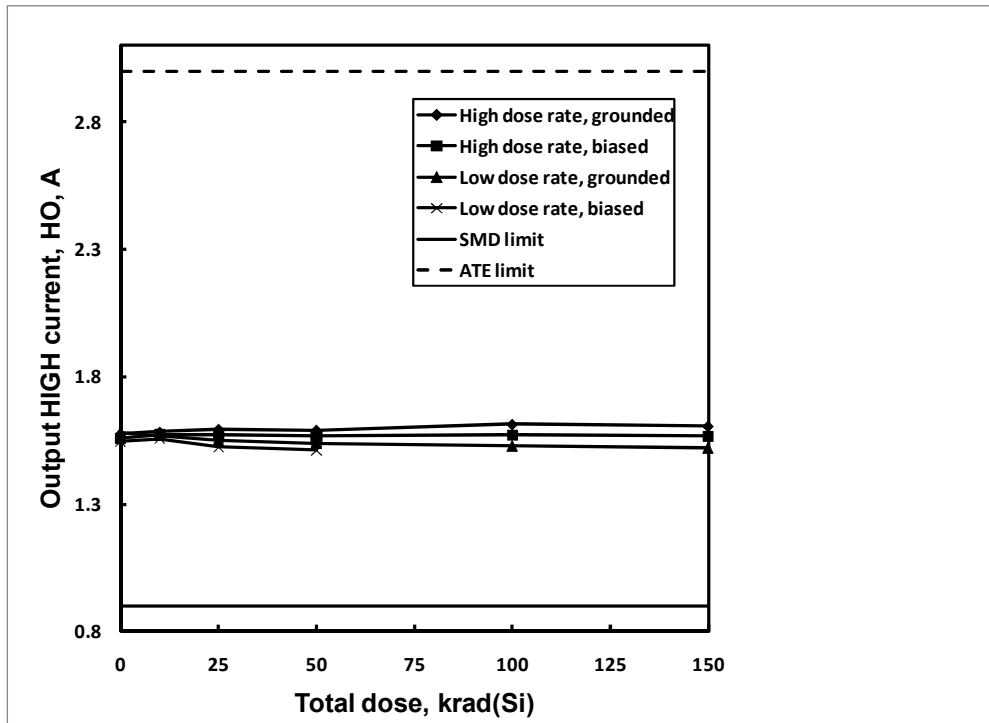

Figure 22: IS-2100ARH median HO output pulsed HIGH current as a function of total dose irradiation at low and high dose rate for the unbiased and biased cases. The SMD limit is 900mA minimum.

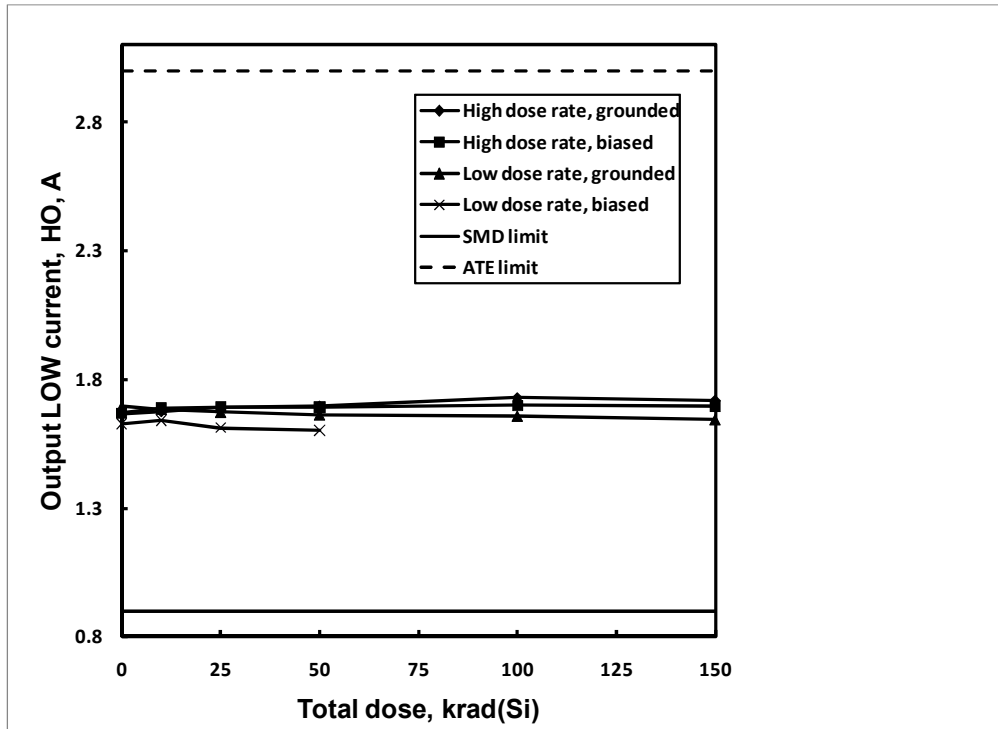

Figure 23: IS-2100ARH median HO output pulsed LOW current as a function of total dose irradiation at low and high dose rate for the unbiased and biased cases. The SMD limit is 900mA minimum.

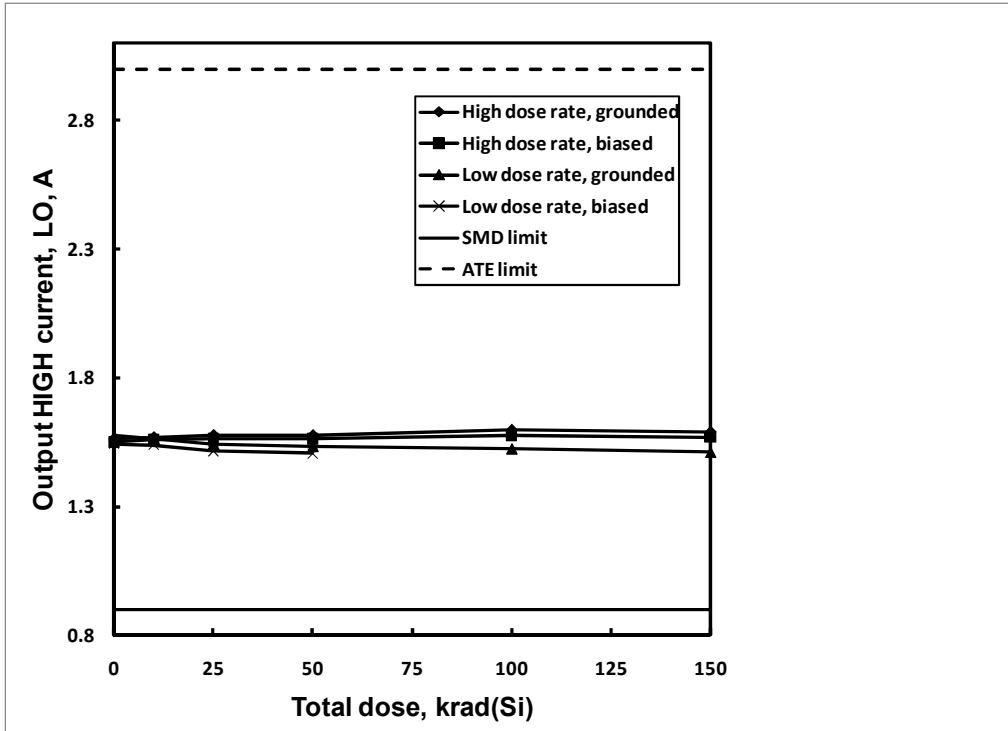

Figure 24: IS-2100ARH median LO output pulsed HIGH current as a function of total dose irradiation at low and high dose rate for the unbiased and biased cases. The SMD limit is 900mA minimum.

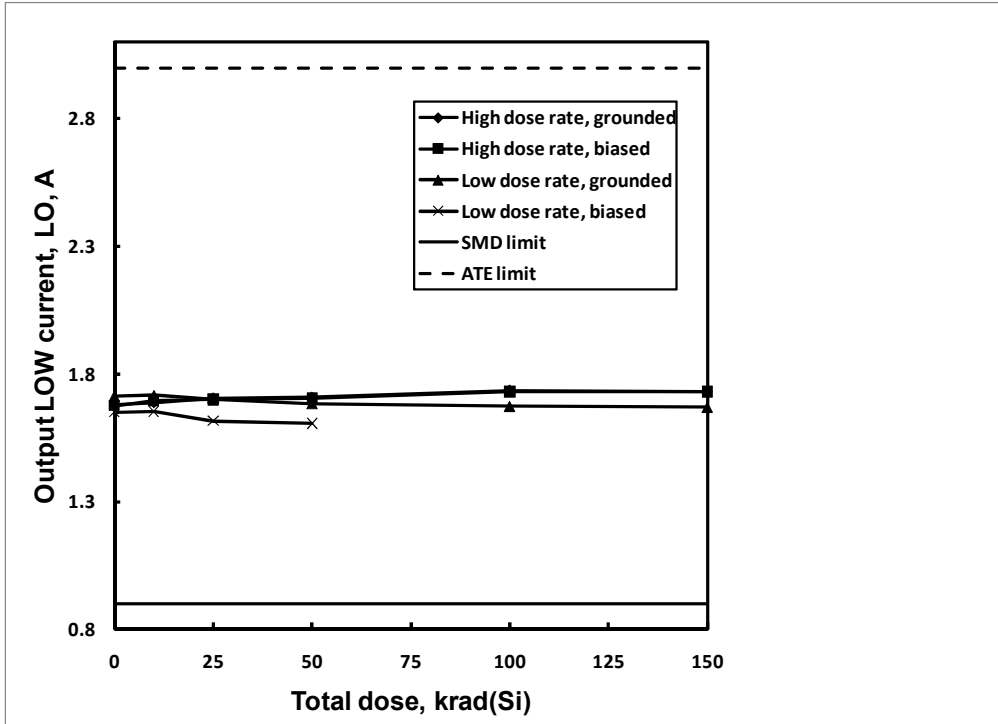

Figure 25: IS-2100ARH median LO output pulsed LOW current as a function of total dose irradiation at low and high dose rate for the unbiased and biased cases. The SMD limit is 900mA minimum.

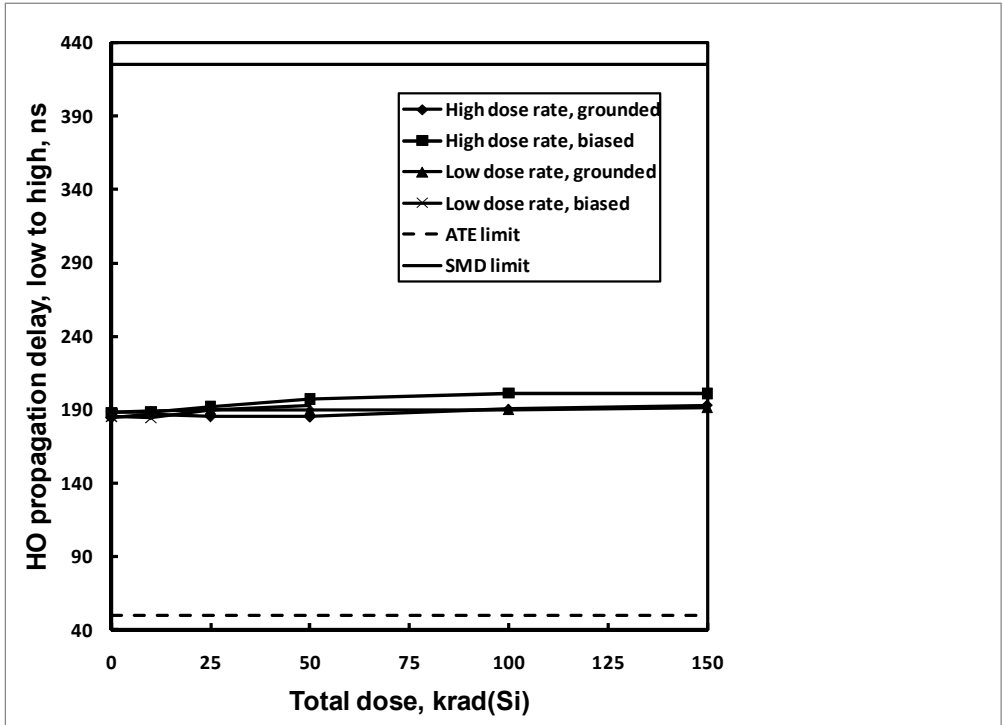

Figure 26: IS-2100ARH median HO turn-on propagation delay as a function of total dose irradiation at low and high dose rate for the unbiased and biased cases. The SMD limit is 425ns maximum.

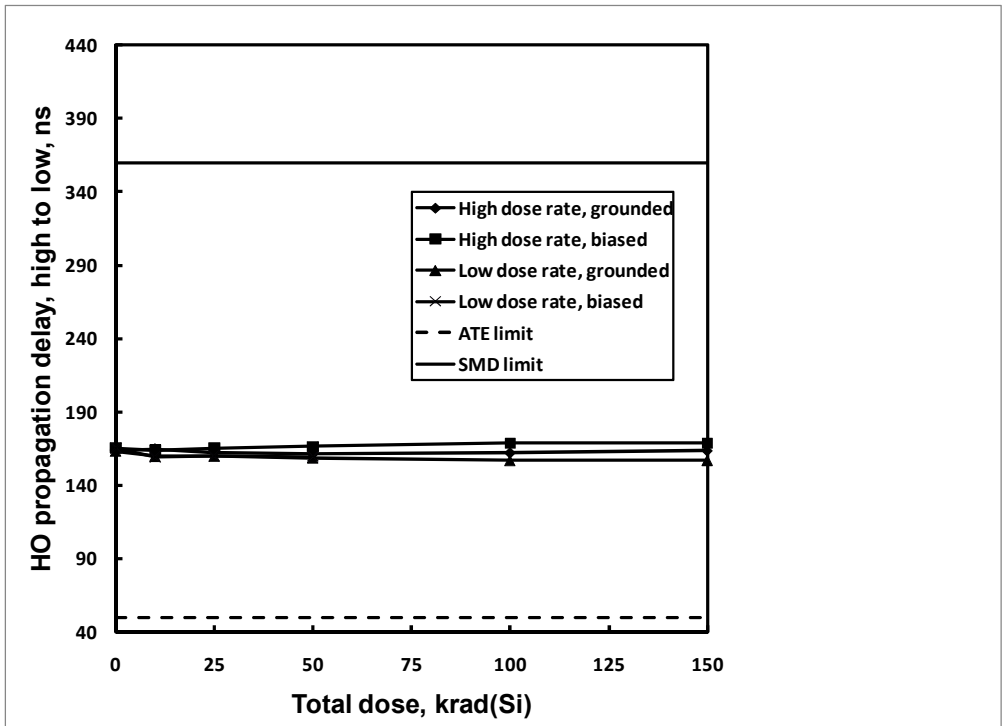

Figure 27: IS-2100ARH median HO turn-off propagation delay as a function of total dose irradiation at low and high dose rate for the unbiased and biased cases. The SMD limit is 360ns maximum.

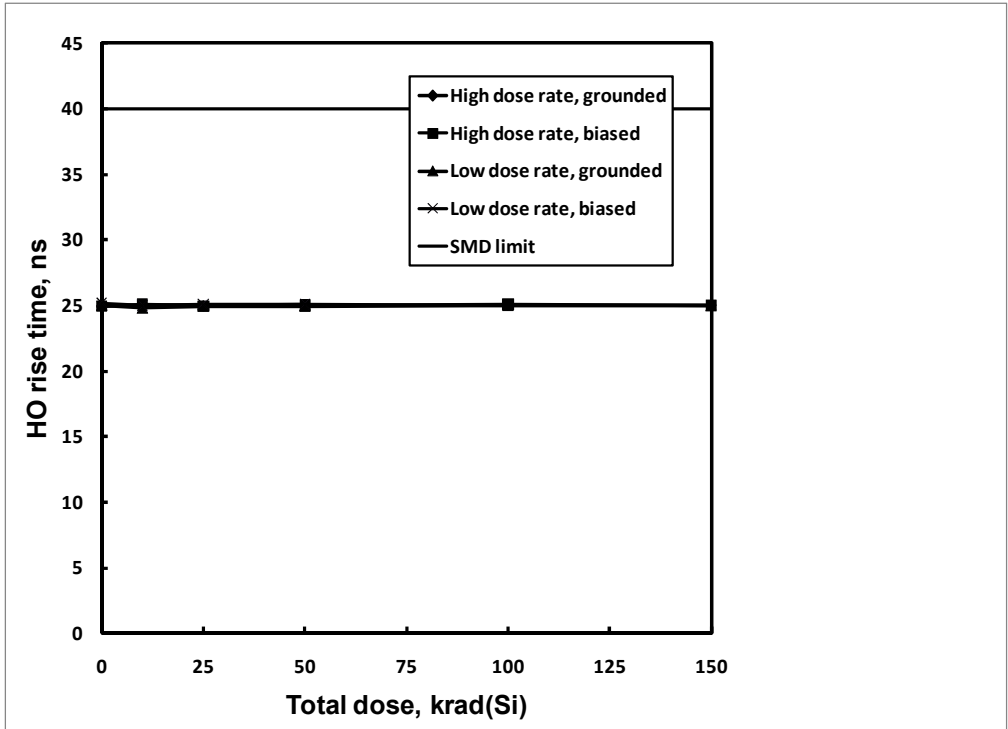

Figure 28: IS-2100ARH median HO rise time as a function of total dose irradiation at low and high dose rate for the unbiased and biased cases. The SMD limit is 40ns maximum.

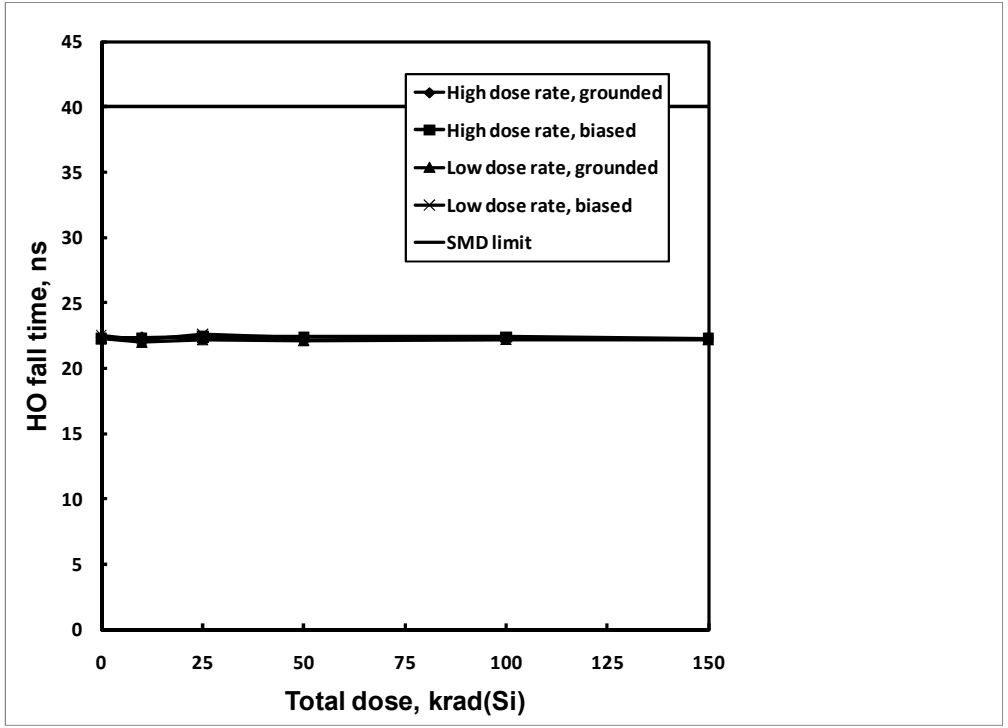

Figure 29: IS-2100ARH median HO fall time as a function of total dose irradiation at low and high dose rate for the unbiased and biased cases. The SMD limit is 40ns maximum.

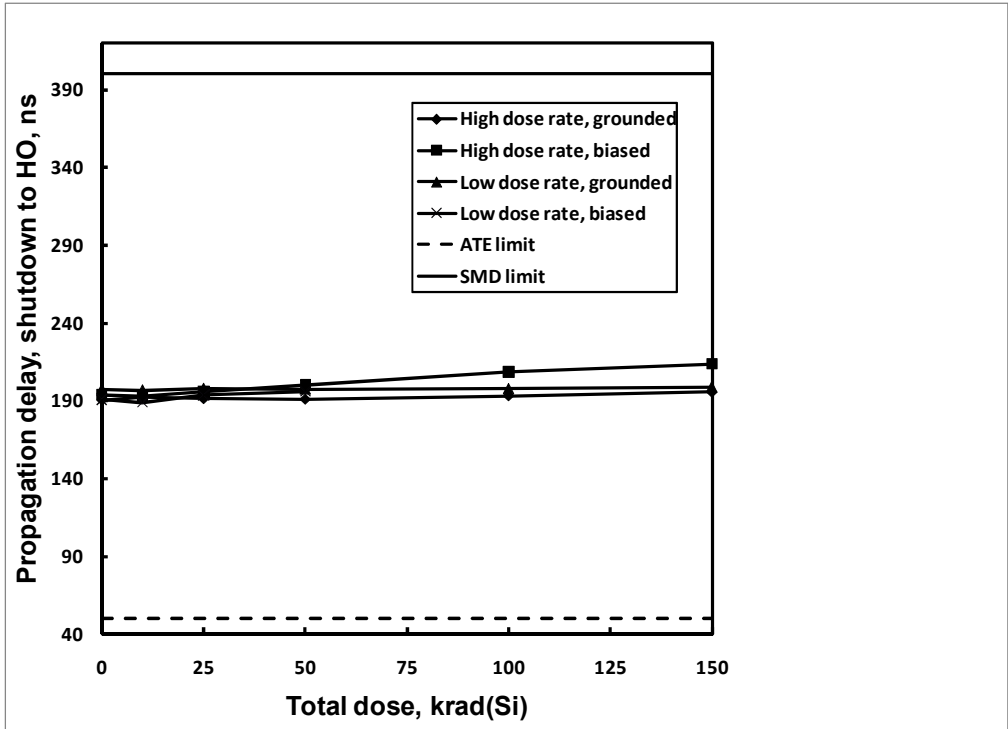

Figure 30: IS-2100ARH median shutdown to HO propagation delay as a function of total dose irradiation at low and high dose rate for the unbiased and biased cases. The SMD limit is 400ns maximum.

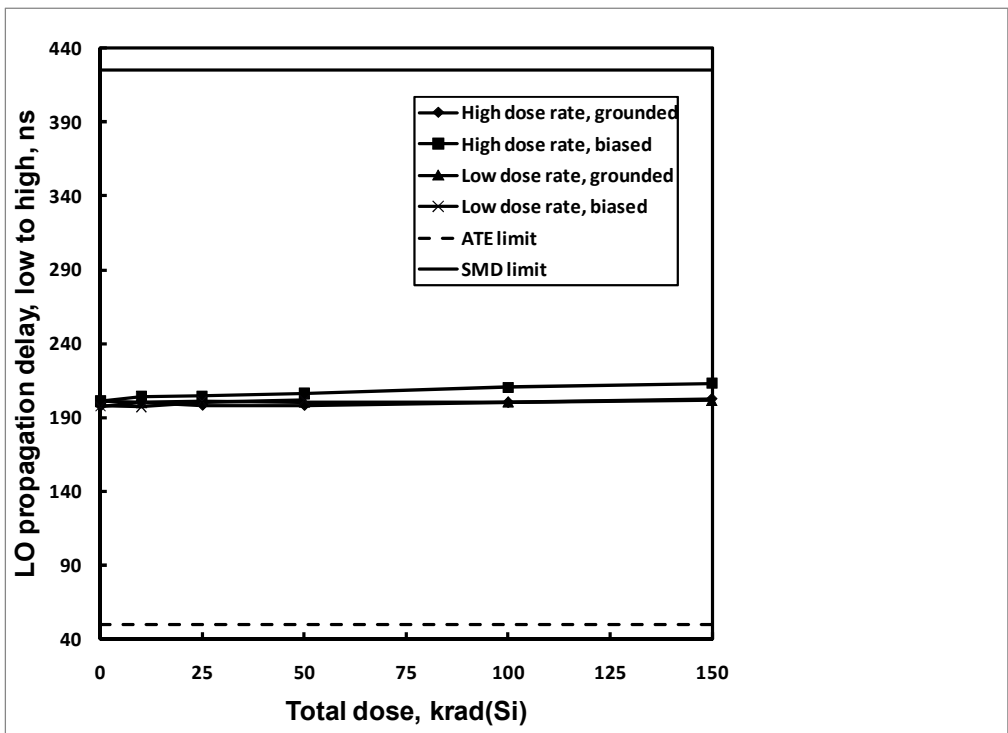

Figure 31: IS-2100ARH median LO turn-on propagation delay as a function of total dose irradiation at low and high dose rate for the unbiased and biased cases. The SMD limit is 425ns maximum.

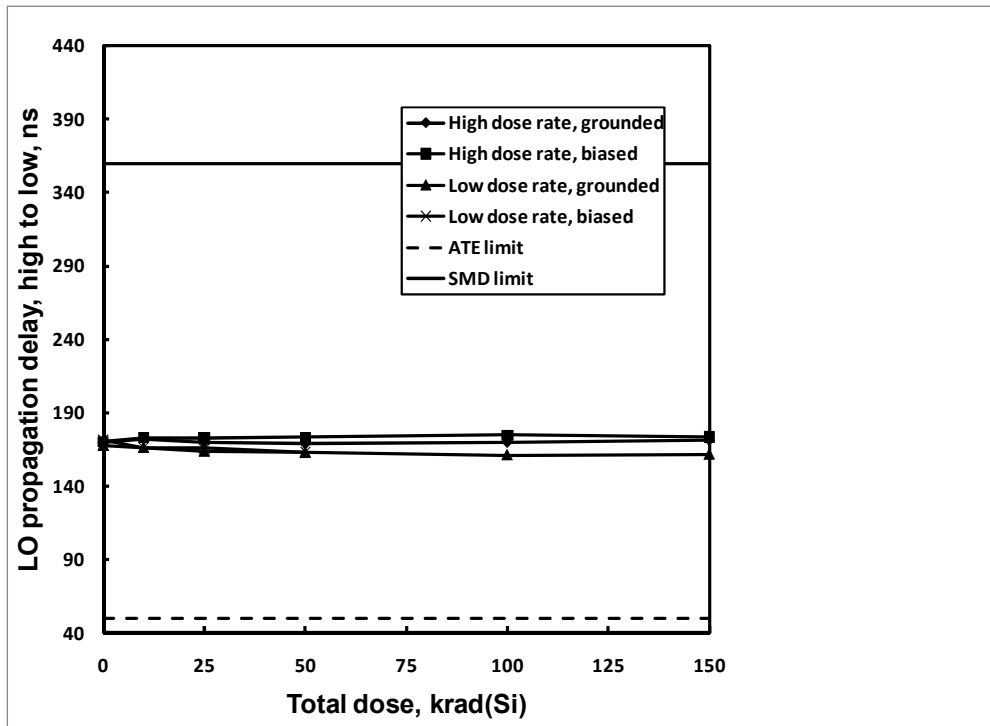

Figure 32: IS-2100ARH median LO turn-off propagation delay as a function of total dose irradiation at low and high dose rate for the unbiased and biased cases. The SMD limit is 360ns maximum.

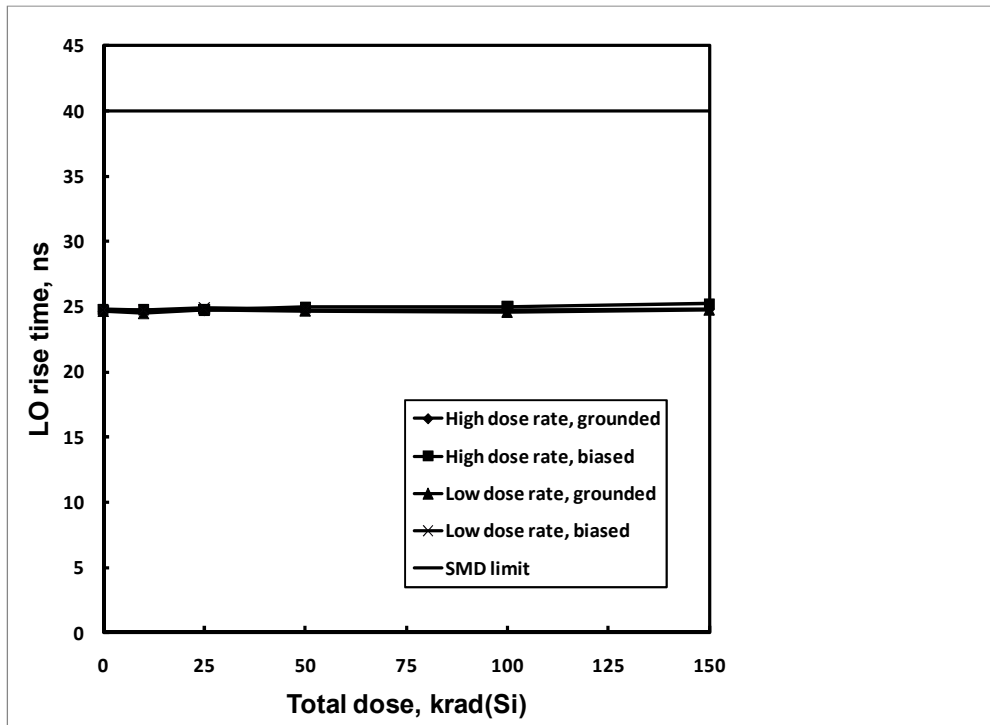

Figure 33: IS-2100ARH median LO rise time as a function of total dose irradiation at low and high dose rate for the unbiased and biased cases. The SMD limit is 40ns maximum.

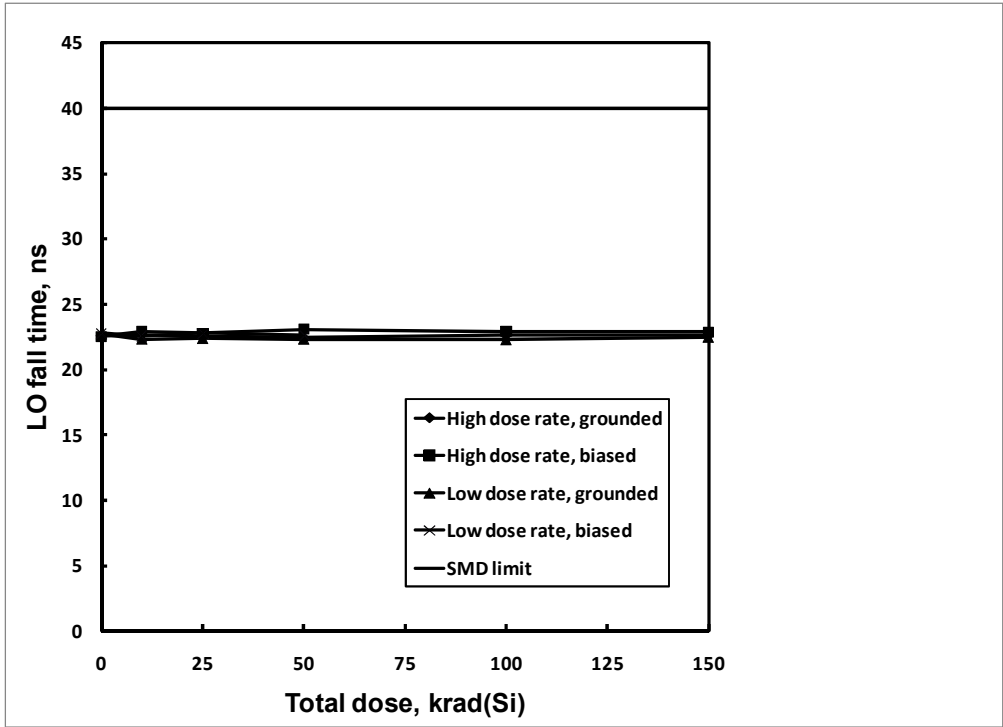

Figure 34: IS-2100ARH median LO fall time as a function of total dose irradiation at low and high dose rate for the unbiased and biased cases. The SMD limit is 40ns maximum.

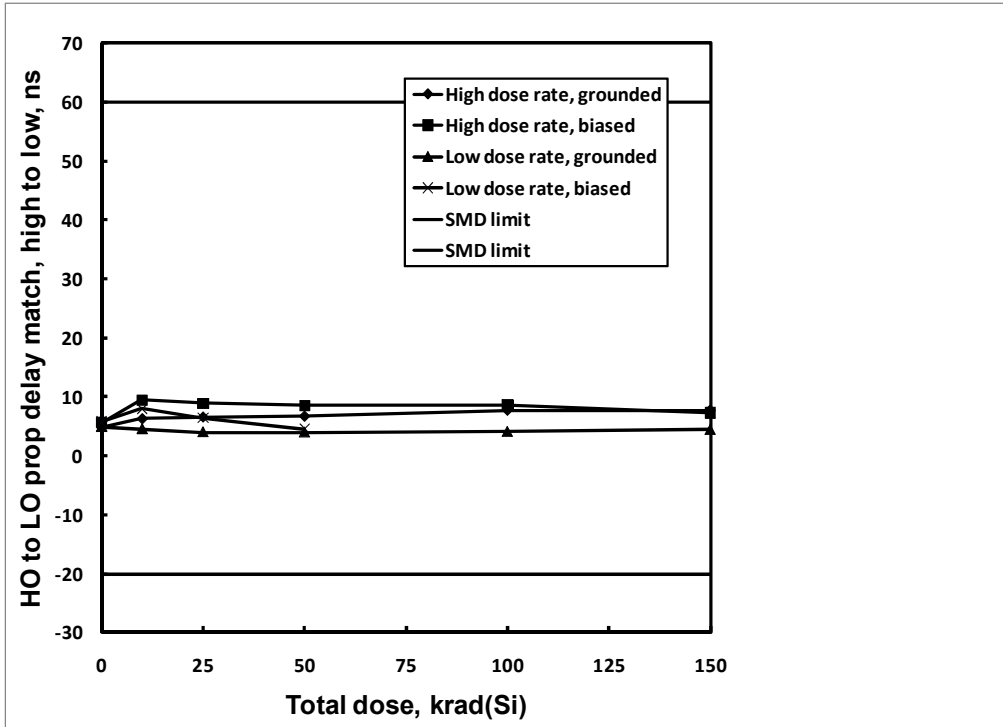

Figure 35: IS-2100ARH median HO to LO propagation delay match, HIGH to LOW, as a function of total dose irradiation at low and high dose rate for the unbiased and biased cases. The SMD limits are -20ns to 60ns.

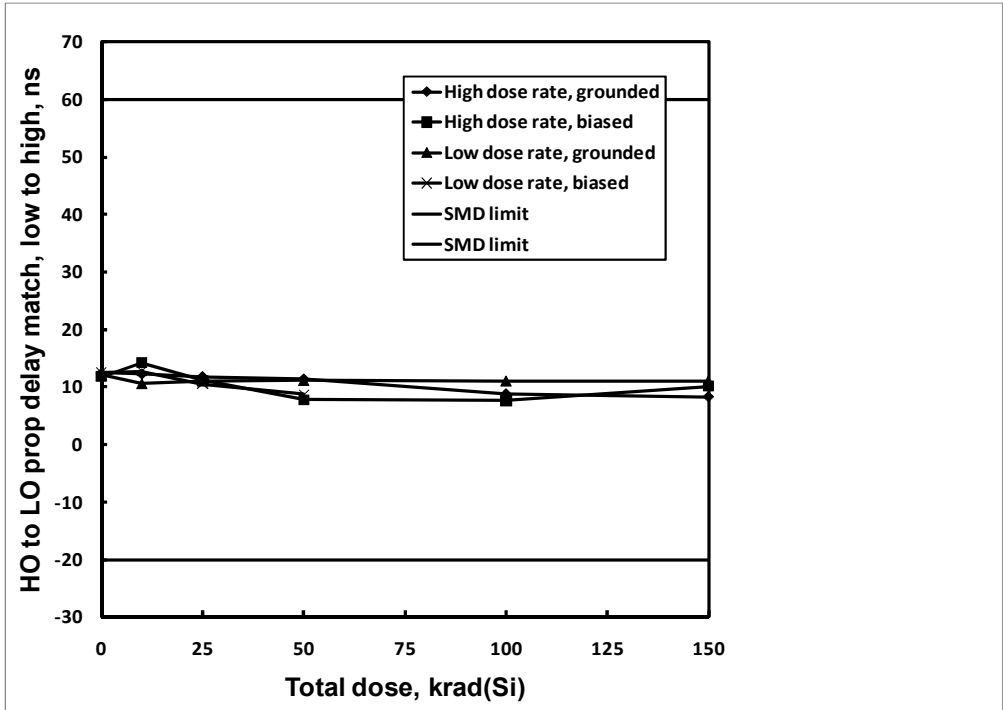

Figure 36: IS-2100ARH median HO to LO propagation delay match, LOW to HIGH, as a function of total dose irradiation at low and high dose rate for the unbiased and biased cases. The SMD limits are -20ns to 60ns.

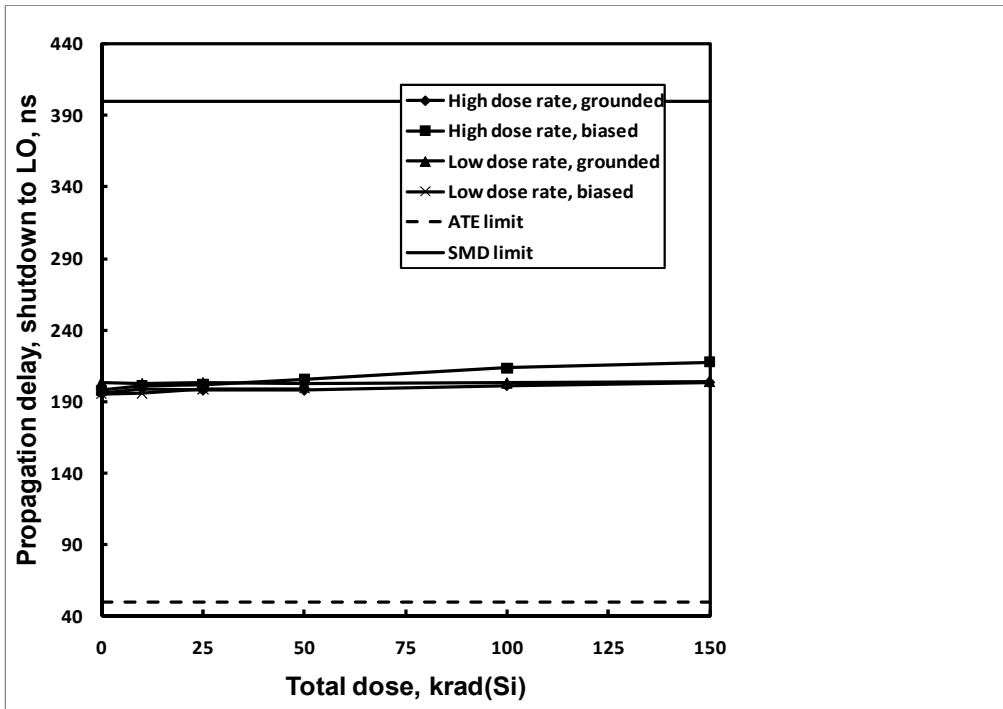

Figure 37: IS-2100ARH median shutdown to LO propagation delay as a function of total dose irradiation at low and high dose rate for the unbiased and biased cases. The SMD limit is 400ns maximum.

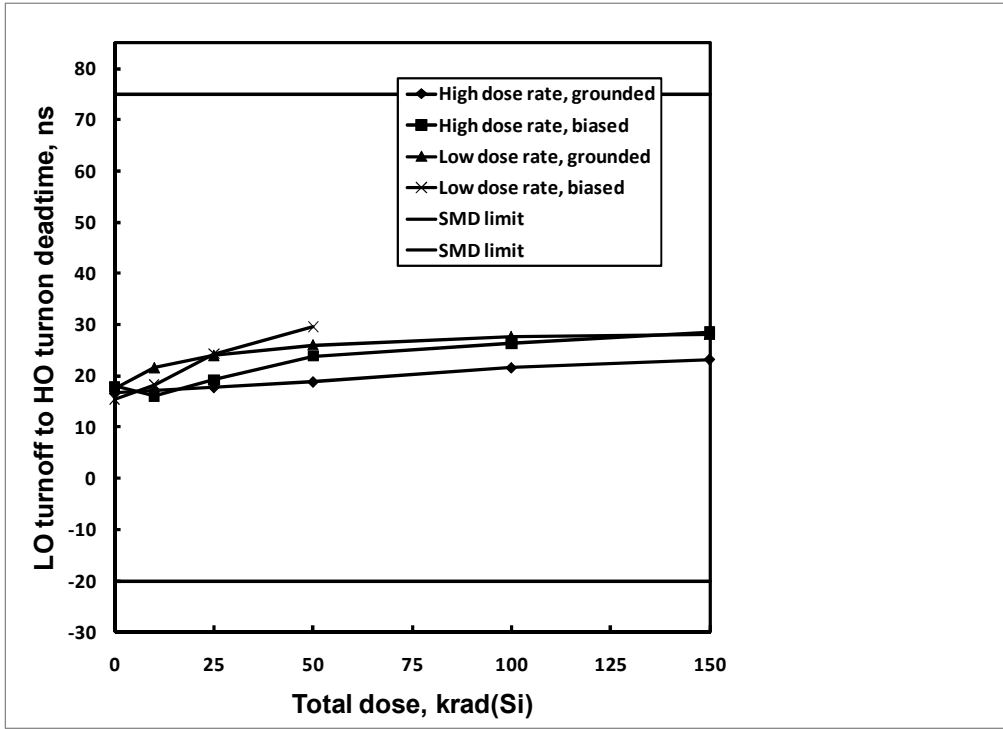

Figure 38: IS-2100ARH median LO turnoff to HO turnon deadtime as a function of total dose irradiation at low and high dose rate for the unbiased and biased cases. The SMD limits are -20ns to 75ns.

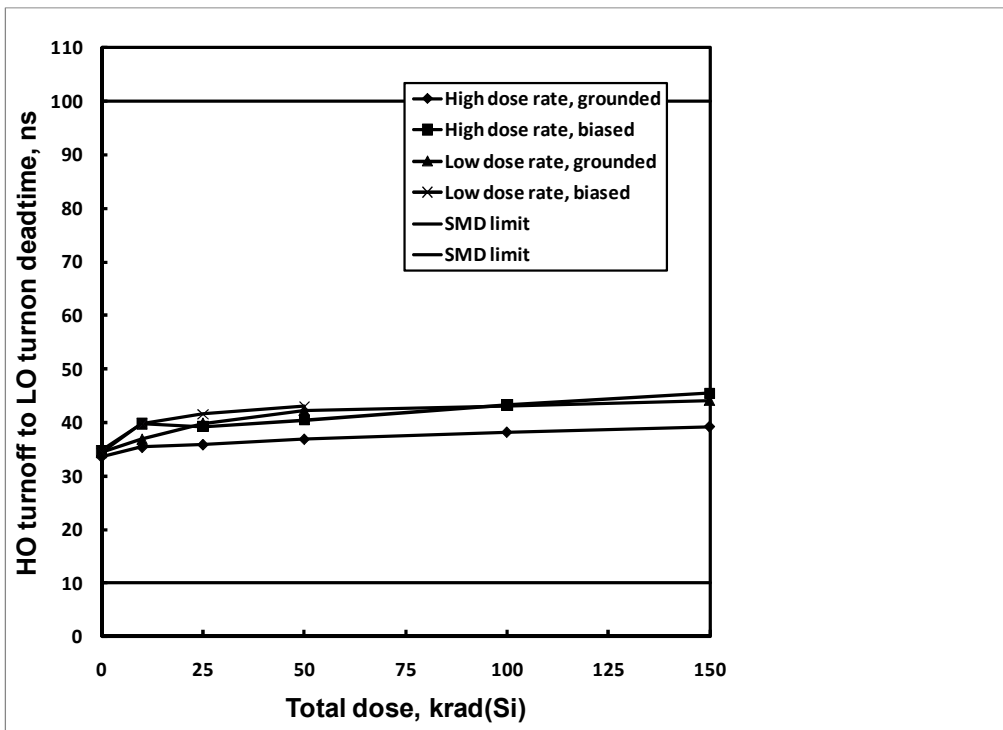

Figure 39: IS-2100ARH median HO turnoff to LO turnon deadtime as a function of total dose irradiation at low and high dose rate for the unbiased and biased cases. The SMD limits are 10ns to 100ns.

6: Conclusion

This document reports the results of a total dose test of the IS-2100ARH half bridge N-channel MOSFET driver. Parts were tested at low and high dose rate under biased and unbiased conditions as outlined in the MIL-STD-883 Test Method 1019.7 diagnostic protocol. Five samples each were irradiated at low and high dose rate under biased and unbiased conditions. The biased low dose rate samples were run successfully to 50krad(Si) but were found to have failed catastrophically at the 100krad(Si) downpoint. Failure analysis of these devices was performed and determined the failures as being caused by electrical overstress. The three other experimental cells were successfully run to 150krad(Si) with no problems.

All samples passed the SMD criteria through their respective maximum total dose exposure, which was 50krad(Si) for the biased low dose rate samples and 150krad(Si) for all other samples. The samples displayed excellent stability for all key parameters, and Figs. 3 through 39 report the results. The part was found to display no discernible dose rate or bias sensitivity, with highly stable performance out to the maximum total dose level. Nonetheless the part must be considered low dose rate sensitive as the biased low dose rate test proceeded to 50krad(Si) while the other cells were run out to the planned 150krad(Si). The demonstration of true low dose rate insensitivity will require completion of a biased low dose rate test to the 150krad(Si) level.

7: Appendices

7.1: Reported parameters by figure number.

Figure	Parameter	Limit, low	Limit, high	Units	Notes
3	IQB		500	μA	VIN = 0
4	IQCC		50	μA	VIN = 0
5	IQDD		2900	μA	VIN = 0
6	IQB		500	μA	VIN = VCC
7	IQCC		50	μA	VIN = VCC
8	IQDD		2900	μA	VIN = VCC
9	ILK		500	μA	150V
10	ILK		200	μA	170V
11	+IIN		75	μA	HIN
12	-IIN		-10	μA	HIN
13	+IIN		75	μA	LIN
14	-IIN		-10	μA	LIN
15	VOH		.1	V	HO
16	VOL		.1	V	HO
17	VOH		.1	V	LO
18	VOL		.1	V	LO
19	Undervoltage lockout threshold	8.0	12.0	V	LOW to HIGH
20	Undervoltage lockout threshold	8.0	12.0	V	HIGH to LOW
21	UVLO hysteresis	250	2000	mV	
22	HO output pulsed HIGH current	0.9		A	
23	HO output pulsed LOW current	0.9		A	
24	LO output pulsed HIGH current	0.9		A	
25	LO output pulsed LOW current	0.9		A	
26	HO turnon propagation delay		425	ns	
27	HO turnoff propagation delay		360	ns	
28	HO rise time		40	ns	
29	HO fall time		40	ns	
30	SD to HO propagation delay		400	ns	
31	LO turnon propagation delay		425	ns	
32	LO turnon propagation delay		360	ns	
33	LO rise time		40	ns	
34	LO fall time		40	ns	
35	HO to LO propagation delay match, HIGH to LOW		60	ns	
36	HO to LO propagation delay match, LOW to HIGH		60	ns	
37	SD to LO propagation delay		400	ns	
38	LO turnoff to HO turnon deadtime	-20	75	ns	
39	HO turnoff to LO turnon deadtime	10	100	ns	

Note 1: Limits are taken from Standard Microcircuit Drawing (SMD) 5962-99536.

8: Document revision history

Revision	Date	Pages	Comments
0	June 2011	All	Original issue