

ISL8270MEVAL1Z

Evaluation Board

AN1926
Rev 1.00
August 15, 2014

The ISL8270M is a 25A step-down DC/DC power supply module with integrated digital PWM controller, synchronous power switches, an inductor and passives. Only bulk input and output capacitors are needed to finish the design. The 25A of continuous output current can be delivered without a need of airflow or a heatsink. The ISL8270M uses ChargeMode™ control architecture, which responds to a transient load within a single switching cycle.

The ISL8270MEVAL1Z evaluation board is a 3in x 4.5in 4-layer FR4 board with 2 oz. copper in all layers. This evaluation board comes with a placeholder for pin-strap resistors to adjust output voltage, switching frequency, input undervoltage (UVLO) protection threshold, and device PMBus address. More configuration such as soft-start and fault limits can be easily programmed or changed via PMBus compliant serial bus interface.

ZLUSBEVAL3Z (USB to PMBus™ adapter) is provided with this evaluation kit, which connects the evaluation board to a PC to activate the PMBus communication interface. The PMBus command set is accessed by using the PowerNavigator™ evaluation software from a PC running Microsoft Windows.

References

[ISL8270M](#) datasheet

Ordering Information

PART NUMBER	DESCRIPTION
ISL8270MEVAL1Z	ISL8270M Kit (EVB, ZLUSBEVAL3Z Adapter, USB Cable)

Key Features

- V_{IN} range of 4.5V to 14V, V_{OUT} adjustable from 0.6V to 5V
- Programmable V_{OUT} , margining, UV/OV, I_{OUT} limit, soft-start/stop, sequencing, and external synchronization
- Monitor: V_{IN} , V_{OUT} , I_{OUT} , temperature, duty cycle, switching frequency and faults
- ChargeMode™ control tunable with PMBus
- Mechanical switch for enable and power-good LED indicator

Recommended Equipment

- DC power supply with minimum 15V/20A sourcing capacity
- Electronic load capable of sinking current up to 25A
- Digital multimeters (DMMs)
- Oscilloscope with higher than 100MHz bandwidth

Functional Description

The ISL8270MEVAL1Z provides all circuitry required to evaluate the features of the ISL8270M. A majority of the features of the ISL8270M, such as compensation-free ChargeMode™ control, soft-start delay and ramp times, supply sequencing, and voltage margining are available on this evaluation board. For sequencing evaluation, the board can be connected to any Intersil digital module evaluation board that supports the Digital-DC™ (DDC) bus.

Figure 1 shows a board image of the ISL8270MEVAL1Z evaluation board.

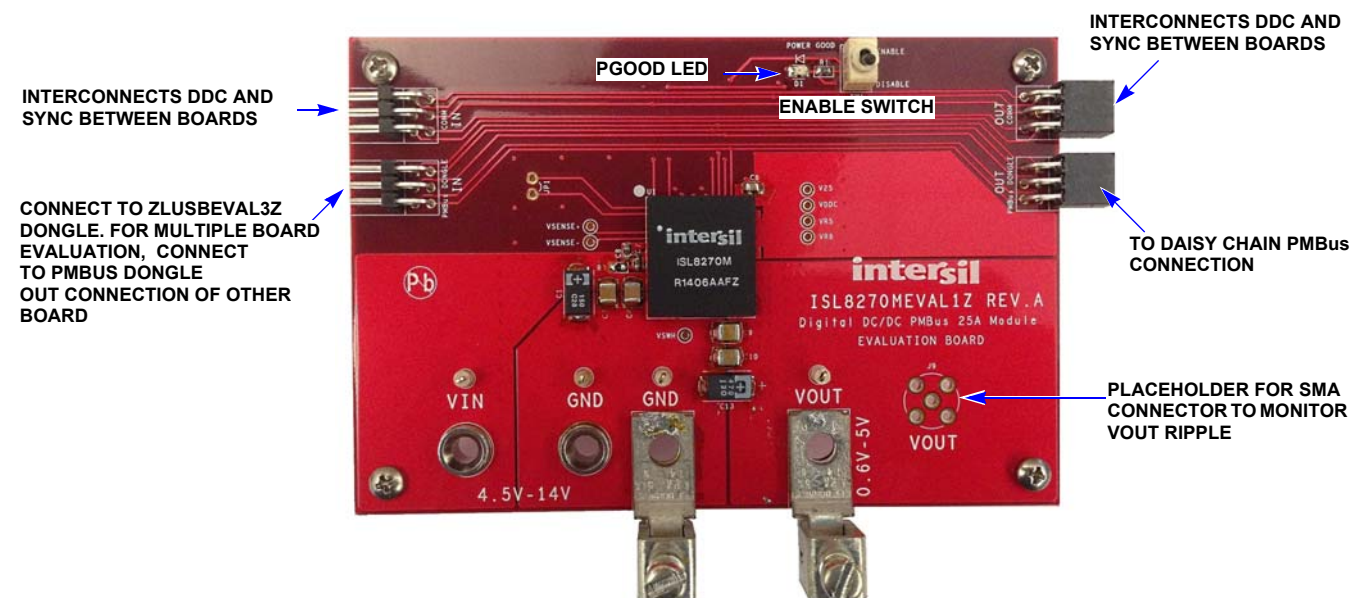

FIGURE 1. ISL8270MEVAL1Z EVALUATION BOARD IMAGE

Operation

PMBus Operation

The ISL8270M utilizes the PMBus protocol. The PMBus functionality can be controlled via ZLUSBEVAL3Z dongle from a PC running the PowerNavigator™ evaluation software in a Windows XP or Windows 7 operating systems.

Install the evaluation software from the following Intersil website: www.intersil.com/powernavigator

For board operation, connect the included ZLUSBEVAL3Z dongle to the 6-pin male connector labeled as “PMBus DONGLE IN”. Connect the desired load and an appropriate power supply to the input and connect the included USB cable to the PC running the PowerNavigator™ evaluation software. Place the ENABLE switches in “DISABLE” before turning on the power.

The evaluation software allows modification of all ISL8270M PMBus parameters. The ISL8270M device on the board has been pre-configured as described in this document, but the user may modify the operating parameters through the evaluation software or by loading a predefined set-up from a configuration file. A sample “[Configuration File](#)” on page 5 is provided and can be copied to a notepad editor to make desired changes.

The ENABLE switch can then be moved to “ENABLE” and the ISL8270MEVAL1Z board can be tested. Alternately, the PMBus ON_OFF_CONFIG and OPERATION commands may be used from the PowerNavigator™ GUI.

Quick Start Guide

Pin-Strap Option

The ISL8270MEVAL1Z can be configured in pin-strap mode with standard 1% 0603 resistors. PMBus interface is not required to evaluate ISL8270M in pin-strap mode. Output voltage (V_{OUT}), switching frequency (F_{SW}), input under-voltage protection (UVLO) threshold and device PMBus address can be changed by populating recommended resistors at placeholders provided in the evaluation board. By default, the evaluation board is programmed to regulate at $V_{OUT} = 1.2V$, $F_{SW} = 533kHz$, $UVLO = 4.5V$, and PMBus address = 28h. Follow these steps to evaluate ISL8270M in pin-strap mode.

1. Set ENABLE switch to “DISABLE”.
2. Connect Load to VOUT lug connectors (J7 and J8).
3. Connect power supply to VIN connectors (J3 and J4). Make sure power supply is not enabled when making connection.
4. Turn power supply on.
5. Set ENABLE switch to “ENABLE”.
6. Measure 1.2V VOUT at probe points (TP10 and TP11).
7. Observe switching frequency of 533kHz at probe point labeled VSWH (TP1).
8. To change VOUT, disconnect board from the setup and populated 1% standard 0603 resistor at R6 placeholder location on bottom layer. Refer to the “Output Voltage Resistor Settings” table in the [ISL8270M](#) datasheet for recommended values. By default, VOUT_MAX is set 110% of V_{OUT} set by pin-strap resistor.
9. To change switching frequency, disconnect board from the set up and populated 1% standard 0603 resistor at R2 placeholder location on bottom layer. Refer to the “Switching Frequency Resistor Settings” table in the [ISL8270M](#) datasheet for recommended values.
10. To change UVLO, disconnect board from the set up and populated 1% standard 0603 resistor at R7 placeholder location on bottom layer. Refer to the “UVLO Resistor Settings” table in the [ISL8270M](#) datasheet for recommended values.

PMBus Option

ISL8270MEVAL1Z can be evaluated for all features using the provided ZLUSBEVAL3Z dongle and PowerNavigator™ evaluation software. Follow these steps to evaluate ISL8270M with PMBus option.

1. Install PowerNavigator™ software.
2. Set ENABLE switch to “DISABLE”.
3. Connect Load to VOUT lug connectors (J7 and J8).
4. Connect power supply to VIN connectors (J3 and J4). Make sure power supply is not enabled when making connection.
5. Turn power supply on.
6. Connect ZLUSBEVAL3Z dongle (USB to PMBus™ adapter) to ISL8270MEVAL1Z board to the 6-pin male connector labeled as “PMBus DONGLE IN”.
7. Connect supplied USB cable from computer to USB to ZLUSBEVAL3Z dongle.
8. Launch PowerNavigator™ software.
9. Set ENABLE switch to “ENABLE”.
10. Monitor and configure the ISL8270MEVAL1Z board using PMBus commands in the evaluation software.
11. PowerNavigator™ tutorial videos are available at Intersil website. www.intersil.com/powernavigator
12. For sequencing via Digital-DC™ Bus (DDC) or to evaluate multiple Intersil digital power products using a single ZLUSBEVAL3Z dongle, ISL8270M can be daisy chained with other digital power evaluation boards. PMBus address can be changed by placing a 1% standard 0603 resistor at the R4 placeholder location on the bottom layer. Refer to the “SMBus Address Resistor Selection” table in the [ISL8270M](#) datasheet for recommended values.

Thermal Considerations and Current Derating

Board layout is very critical in order to make the module operate safely and deliver maximum allowable power. To work in the high temperature environments and carry large currents, the board layout needs to be carefully designed to maximize thermal performance. To achieve this, select enough trace width, copper weight and the proper connectors.

This evaluation board is designed for running 25A at room temperature without additional cooling systems needed. However, if the output voltage is increased or the board is operated at elevated temperatures, then the available current is derated. Refer to the derated current curves in the [ISL8270M](#) datasheet to determine the maximum output current the evaluation board can supply. θ_{JA} is measured by inserting thermocouple inside the module to measure peak junction temperature.

ISL8270MEVAL1Z Board Schematic

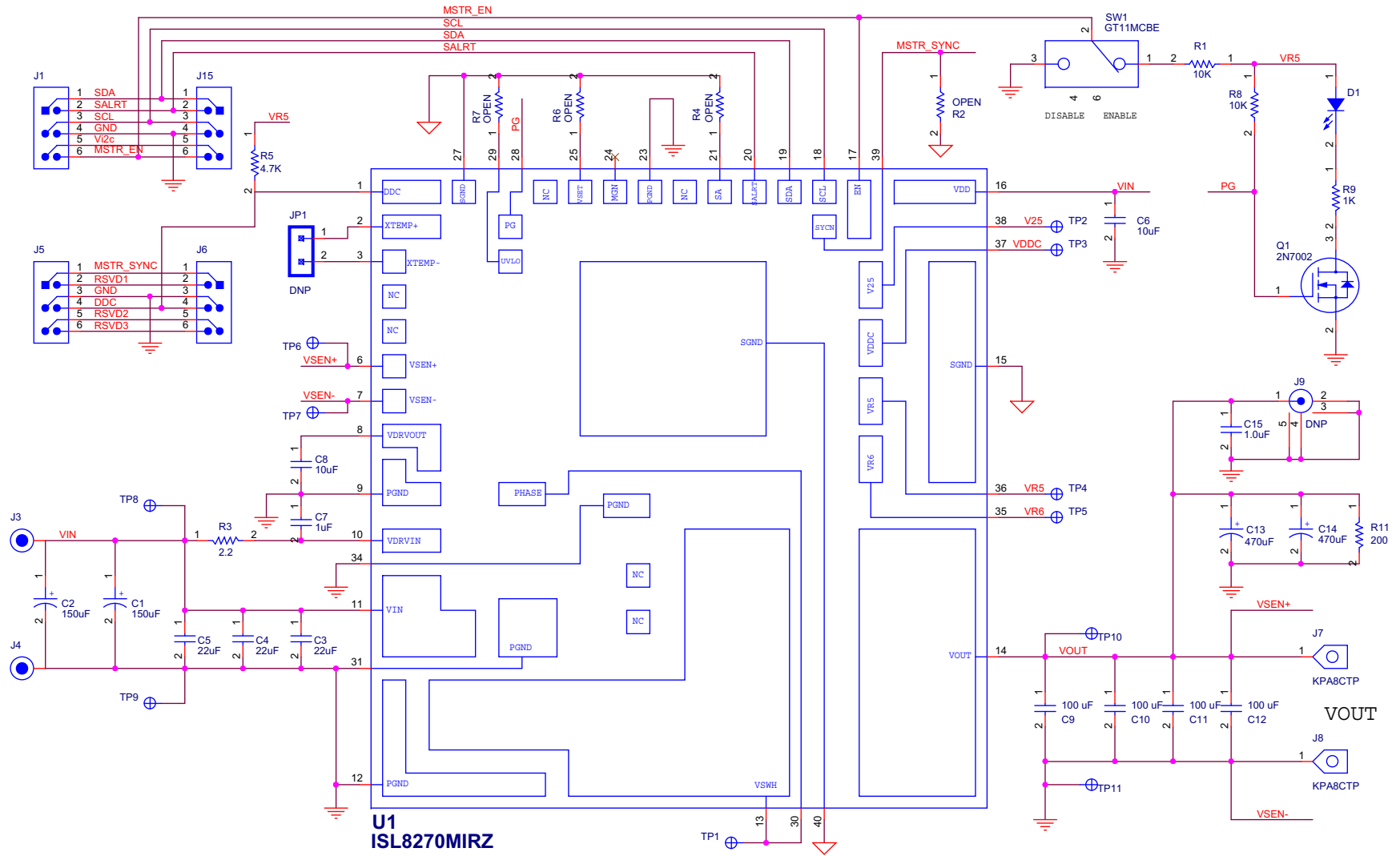

FIGURE 2. APPLICATION CIRCUIT

Bill of Materials

REFERENCE DESIGNATOR	QTY	MANUFACTURER	MANUFACTURER PART	DESCRIPTION
C7	1	MURATA	GRM188R71E105KA12D	CAP, SMD, 0603, 1 μ F, 25V, 10%, X7R, ROHS
C3-C5	3	MURATA	GRM32ER71E226KE15L	CAP, SMD, 1210, 22 μ F, 25V, 10%, X7R, ROHS
C15	1	PANASONIC	ECJ-0EB0J105K	CAP, SMD, 0402, 1 μ F, 6.3V, 10%, X5R, ROHS
C8	1	PANASONIC	ECJ-1VB1A106M	CAP, SMD, 0603, 10 μ F, 10V, 20%, X5R, ROHS
C6	1	TDK	C2012X5R1E106K	CAP, SMD, 0805, 10 μ F, 25V, 10%, X5R, ROHS
C9, C10, C11, C12	4	TDK	C3225X5R0J107M	CAP, SMD, 1210, 100 μ F, 6.3V, 20%, X5R, ROHS
C1, C2	2	SANYO/PANASONIC	16TQC150MYF	CAP-POSCAP, SMD, 7.3X4.3, 150 μ F, 16V, 20%, 50m Ω , ROHS
C13, C14	2	SANYO/PANASONIC	6TPF470MAH	CAP TANT 470 μ F 6.3V 20%
TP8, TP10	2	KEYSTONE	5000	CONN-MINI TEST PT, VERTICAL, RED, ROHS
TP9, TP11	2	KEYSTONE	5001	CONN-MINI TEST PT, VERTICAL, BLK, ROHS
J3, J4	2	KEYSTONE	575-4	CONN-JACK, MINI BANANA, 0.175 PLUG, NICKEL/BRASS, ROHS
J2, J6	2	SAMTEC	SSQ-103-02-T-D-RA	CONN-SOCKET STRIP, TH, 2X3, 2.54mm, TIN, R/A, ROHS
J1, J5	2	SAMTEC	TSW-103-08-T-D-RA	CONN-HEADER, 2X3, BRKAWY, 2.54mm, TIN, R/A, ROHS
D1	1	CHICAGO MINIATURE	CMD17-21VGC/TR8	LED, SMD, 0805, GREEN, CLEAR, 10mcd, 2.1V, 20mA, 570nm, ROHS
U1	1	INTERSIL	ISL8270MIRZ	IC-25A DIGITAL DC/DC PMBUS MODULE, 26P, QFN, ROHS
Q1	1	ON SEMICONDUCTOR	2N7002LT1G	TRANSISTOR-MOS, N-CHANNEL, SMD, SOT23, 60V, 115mA, ROHS
R5	1	YAGEO	9C06031A4701FKHFT	RES, SMD, 0603, 4.7k, 1/10W, 1%, TF, ROHS
R2, R4, R6, R7	0			RESISTOR, SMD, 0603, 0.1%, MF, DNP-PLACE HOLDER
R3	1	PANASONIC	ERJ-3RQF2R2V	RES, SMD, 0603, 2.2 Ω , 1/10W, 1%, TF, ROHS
R9	1	PANASONIC	ERJ-3EKF1001V	RES, SMD, 0603, 1k, 1/10W, 1%, TF, ROHS
R1, R8	2	KOA	RK73H1JT1002F	RES, SMD, 0603, 10k, 1/10W, 1%, TF, ROHS
R11	1	PANASONIC	ERJ-8ENF2000V	RES, SMD, 1206, 200 Ω , 1/4W, 1%, TF, ROHS
SW1	1	ITT CANNON	GT11MCBE	SWITCH-TOGGLE, THRU-HOLE, SPDT, 5P, ROHS
J7, J8	2	BERG/FCI	KPA8CTP	HDWARE, MTG, CABLE TERMINAL, 6-14AWG, LUG and SCREW, ROHS
J9	0	TE CONNECTIVITY	5-1814832-1	DO NOT POPULATE
JP1	0			DO NOT POPULATE
TP1-TP7	0			DO NOT POPULATE

Configuration File

Sample Configuration File for ISL8270M Module. Copy and paste (from RESTORE_FACTORY TO ### End User Store) to a notepad and save it as Confile_file_name.txt. The # symbol is used for a comment line. Following settings are already loaded to ISL8270M module as factory defaults.

```

RESTORE_FACTORY                # reset device to the factory setting
STORE_USER_ALL                 # Clears user memory space
# VOUT Related
VOUT_COMMAND                   0x2666                # 1.2 V
VOUT_MAX                       0x2a3c                # 1.32 V
VOUT_MARGIN_HIGH               0x2851                # 1.26 V
VOUT_MARGIN_LOW                0x247a                # 1.14 V
VOUT_OV_FAULT_LIMIT           0x2c28                # 1.38 V
VOUT_OV_FAULT_RESPONSE        0x80                  # Disable and no retry
VOUT_OV_WARN_LIMIT            0x2a3c                # 1.32 V
VOUT_UV_WARN_LIMIT             0x228f                # 1.08 V
VOUT_UV_FAULT_LIMIT           0x20a3                # 1.02 V
VOUT_UV_FAULT_RESPONSE        0x80                  # Disable and no retry
POWER_GOOD_ON                  0x228f                # 1.08 V
VOUT_TRANSITION_RATE          0xba00                # 1 mV/us
VOUT_DROOP                     0x0000                # 0 mV/A
VOUT_CAL_OFFSET                0x0000                # 0 mV/A
# IOUT Related
IOUT_CAL_GAIN                  0xb380                # 0.875 mV/A
IOUT_CAL_OFFSET                0x0000                # 0 A
IOUT_OC_FAULT_LIMIT            0xdc0                 # 30 A
IOUT_UC_FAULT_LIMIT            0xdc3f                # -30A
MFR_IOUT_OC_FAULT_RESPONSE     0x80                  # Disable and no retry
MFR_IOUT_UC_FAULT_RESPONSE     0x80                  # Disable and no retry
ISENSE_CONFIG                  0x05                  # 256ns Blanking time, Mid-Range
# Other Faults
OT_FAULT_LIMIT                 0xebe8                # 125 °C
OT_FAULT_RESPONSE              0x80                  # Disable and no retry
OT_WARN_LIMIT                  0xeb70                # 110 °C
UT_WARN_LIMIT                  0xdc40                # -30 °C
UT_FAULT_LIMIT                 0xe530                # -45 °C
UT_FAULT_RESPONSE              0x80                  # Disable and no retry
VIN_OV_FAULT_LIMIT             0xd380                # 14 V
VIN_OV_FAULT_RESPONSE          0x80                  # Disable and no retry
VIN_OV_WARN_LIMIT              0xd327                # 12.609 V
VIN_UV_WARN_LIMIT              0xca79                # 4.945 V
VIN_UV_FAULT_LIMIT             0xca40                # 4.5 V
VIN_UV_FAULT_RESPONSE          0x80                  # Disable and no retry
#Enable, Timing and Sequence Related
ON_OFF_CONFIG                  0x17                  # Pin Enable, Immediate Off
TON_DELAY                      0xca80                # 5 ms
TON_RISE                        0xca80                # 5 ms
TOFF_DELAY                     0xca80                # 5 ms
TOFF_FALL                      0xca80                # 5 ms
POWER_GOOD_DELAY               0xba00                # 1 ms
FREQUENCY_SWITCH               0x0215                # Sequence Disabled
SYNC_CONFIG                    0x00                  # Use Pin-strap for FSW setting
SEQUENCE                       0x0000                # 533 kHz
# Manufacturer Related
MFR_ID                          Intersil Corp          # Example Only
MFR_MODEL                      ISL8270MEVAL1Z        # Example Only
MFR_REVISION                   Rev-1                  # Example Only
MFR_LOCATION                   Milpitas, CA          # Example Only
MFR_DATE                       3/14/2014             # Example Only
MFR_SERIAL                     1234                  # Example Only
USER_DATA_00                   Module                 # Example Only
# Advance Settings
USER_CONFIG                    0x00                  # Open Drain PG, XTEMP Disabled
DDC_CONFIG                     0x01                  # DDC rail ID = 1
DDC_GROUP                      0x00000000           # All Broadcast disabled
# Loop Compensation
ASCR_CONFIG                    0x15a0100            # ASCR gain = 256, Residual = 90
STORE_USER_ALL                 # Store all above settings to NVRAM
### End User Store

```

Measured Data

The following data was acquired using a ISL8270MEVAL1Z evaluation board.

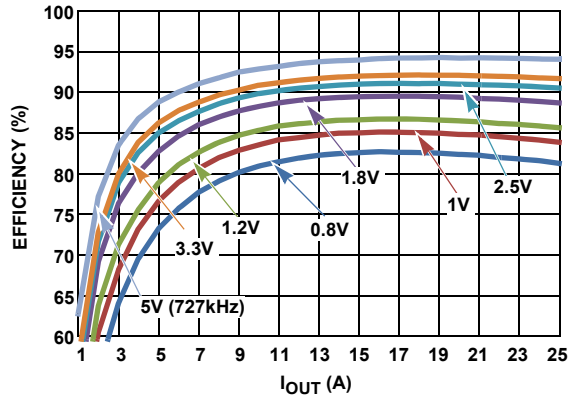

FIGURE 3. EFFICIENCY vs OUTPUT CURRENT AT $V_{IN} = 12V$, $F_{SW} = 550kHz$ FOR VARIOUS OUTPUT VOLTAGES

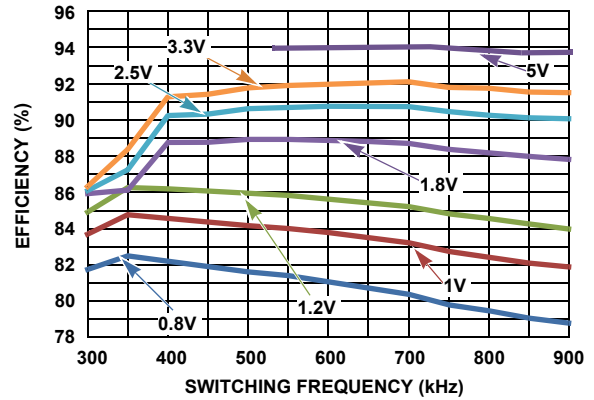

FIGURE 4. EFFICIENCY vs SWITCHING FREQUENCY AT $V_{IN} = 12V$, $I_{OUT} = 25A$ FOR VARIOUS OUTPUT VOLTAGES

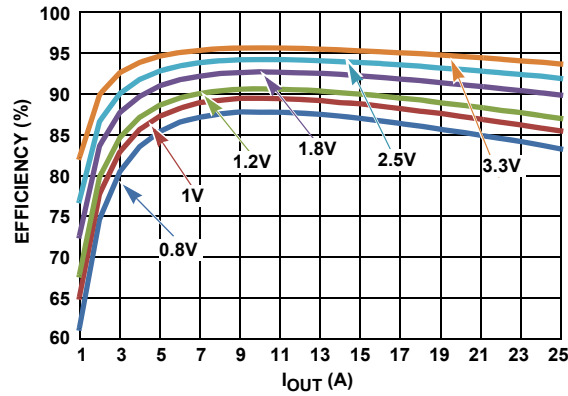

FIGURE 5. EFFICIENCY vs OUTPUT CURRENT AT $V_{IN} = 5V$, $F_{SW} = 550kHz$ FOR VARIOUS OUTPUT VOLTAGES

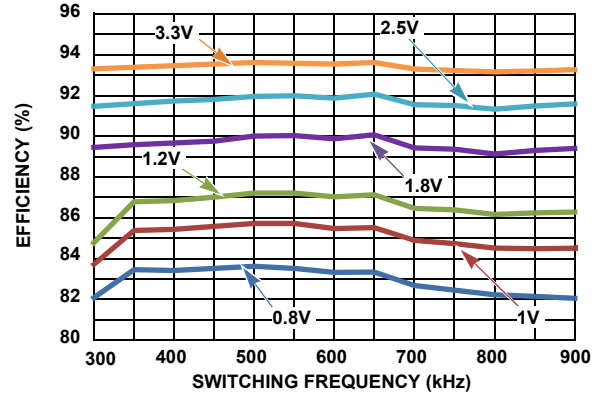

FIGURE 6. EFFICIENCY vs SWITCHING FREQUENCY AT $V_{IN} = 5V$, $I_{OUT} = 25A$ FOR VARIOUS OUTPUT VOLTAGES

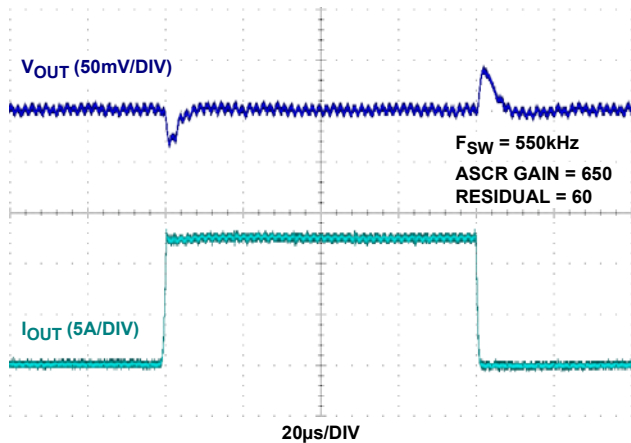

FIGURE 7. 1.2V TRANSIENT RESPONSE

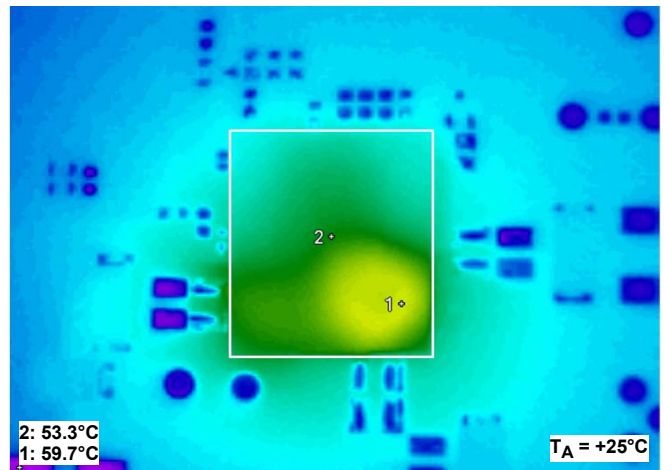

FIGURE 8. THERMAL IMAGE, $12V_{IN}$ to $1V_{OUT}$, $I_{OUT} = 25A$, $T_A = +25^\circ C$, $F_{SW} = 533kHz$, NO AIR FLOW

ISL8270MEVAL1Z Board Layout

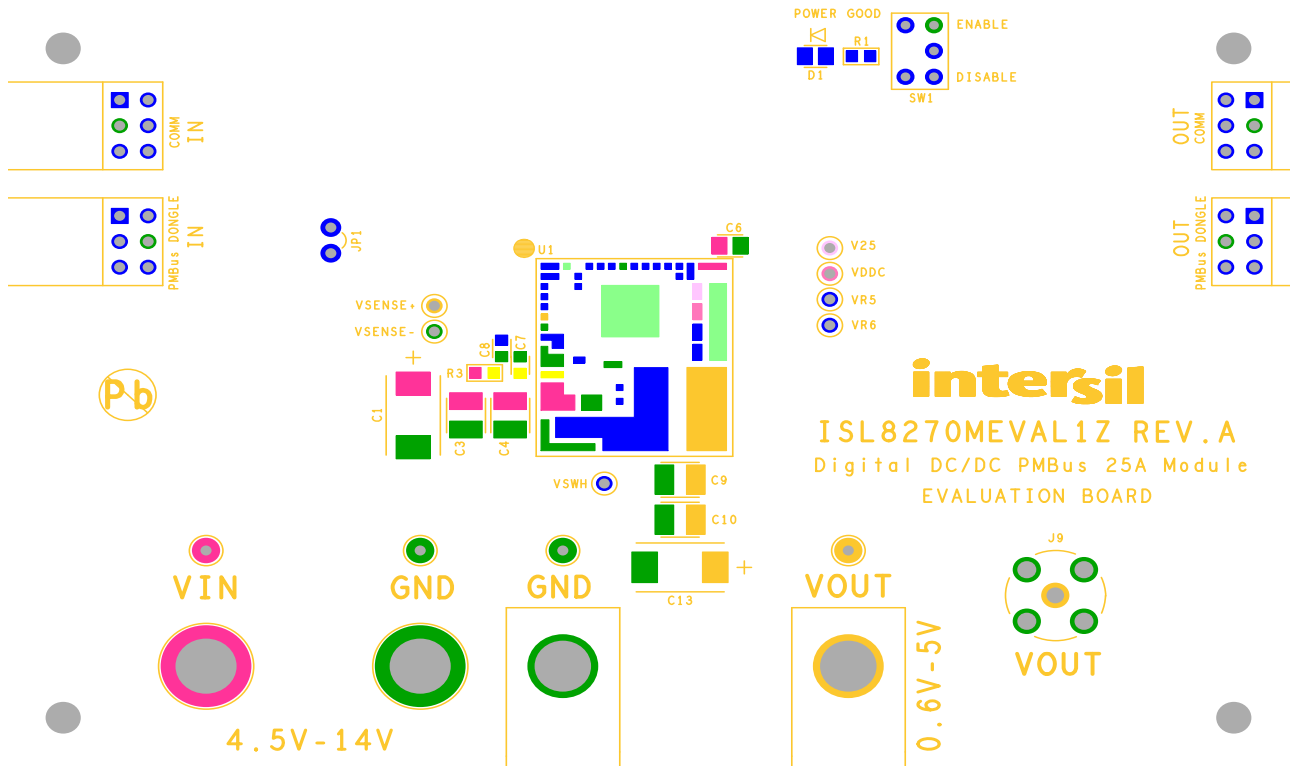

FIGURE 9. PCB - TOP SILK SCREEN

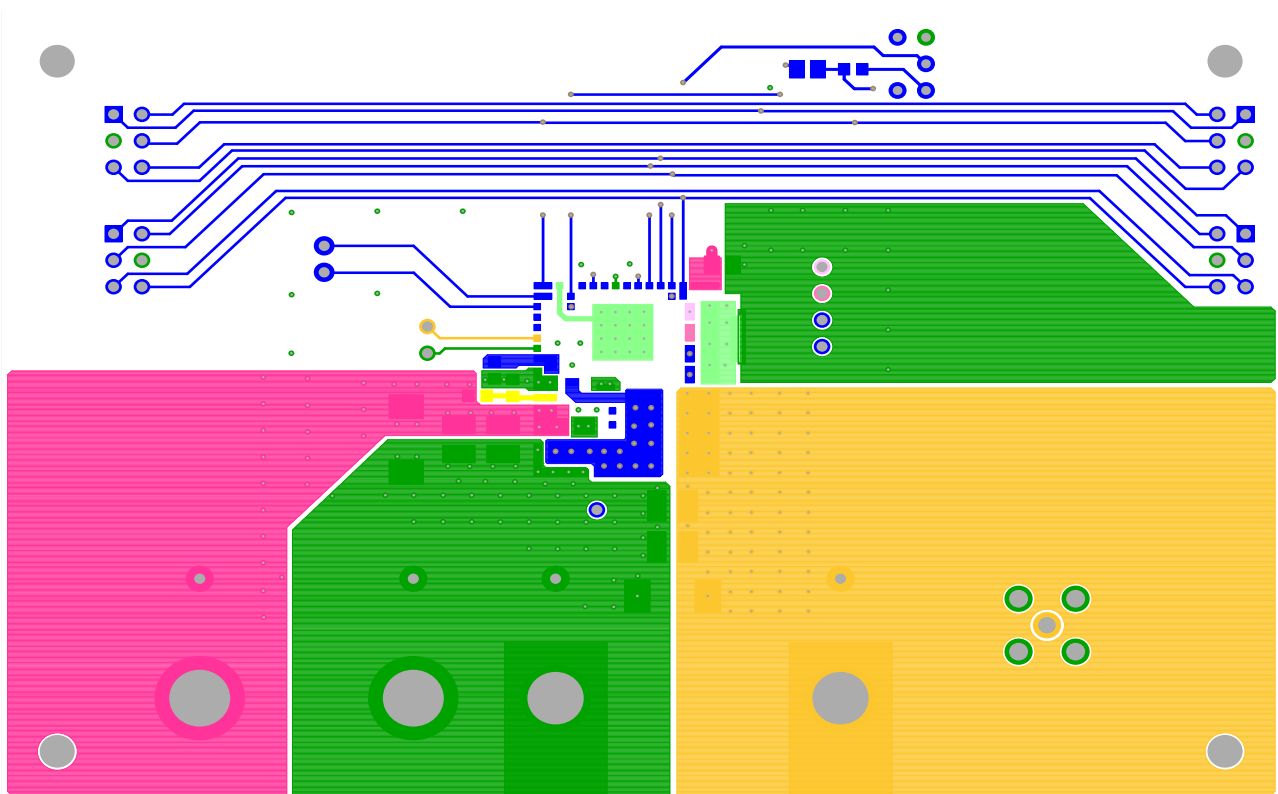

FIGURE 10. PCB - TOP LAYER

ISL8270MEVAL1Z Board Layout (Continued)

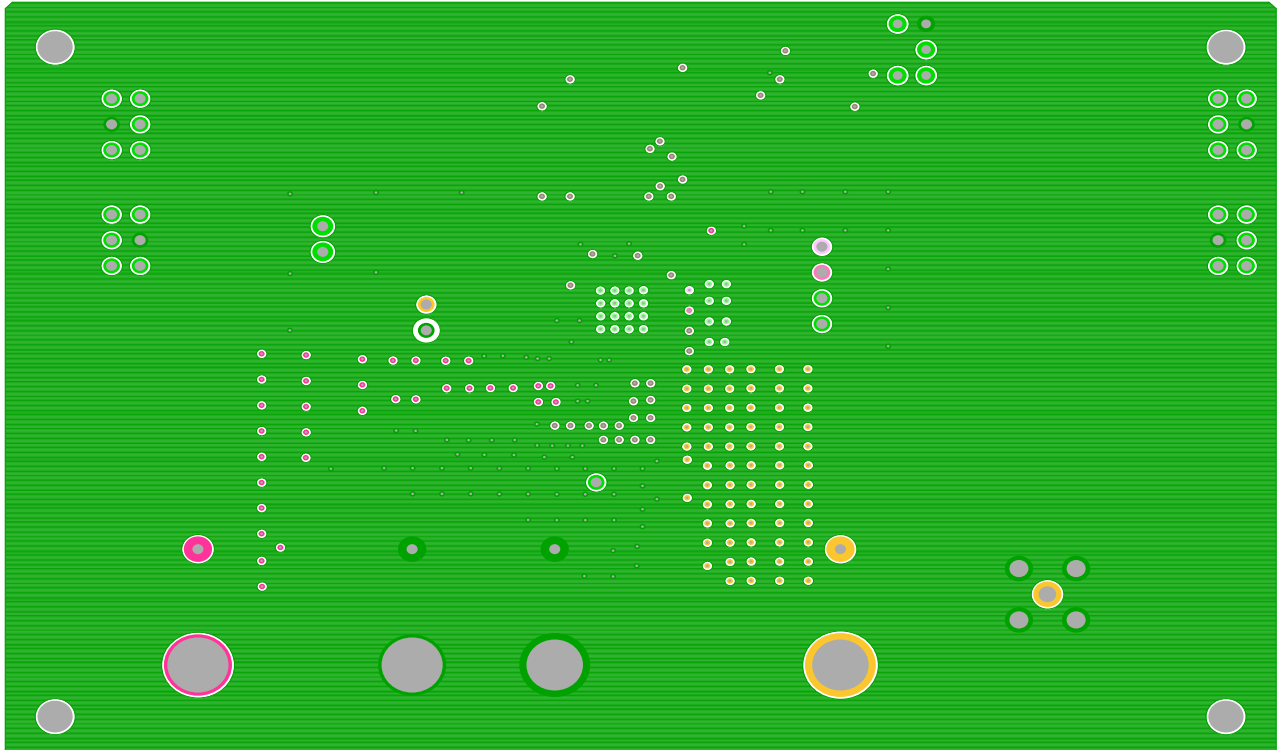

FIGURE 11. PCB - INNER LAYER - LAYER 2 (TOP VIEW)

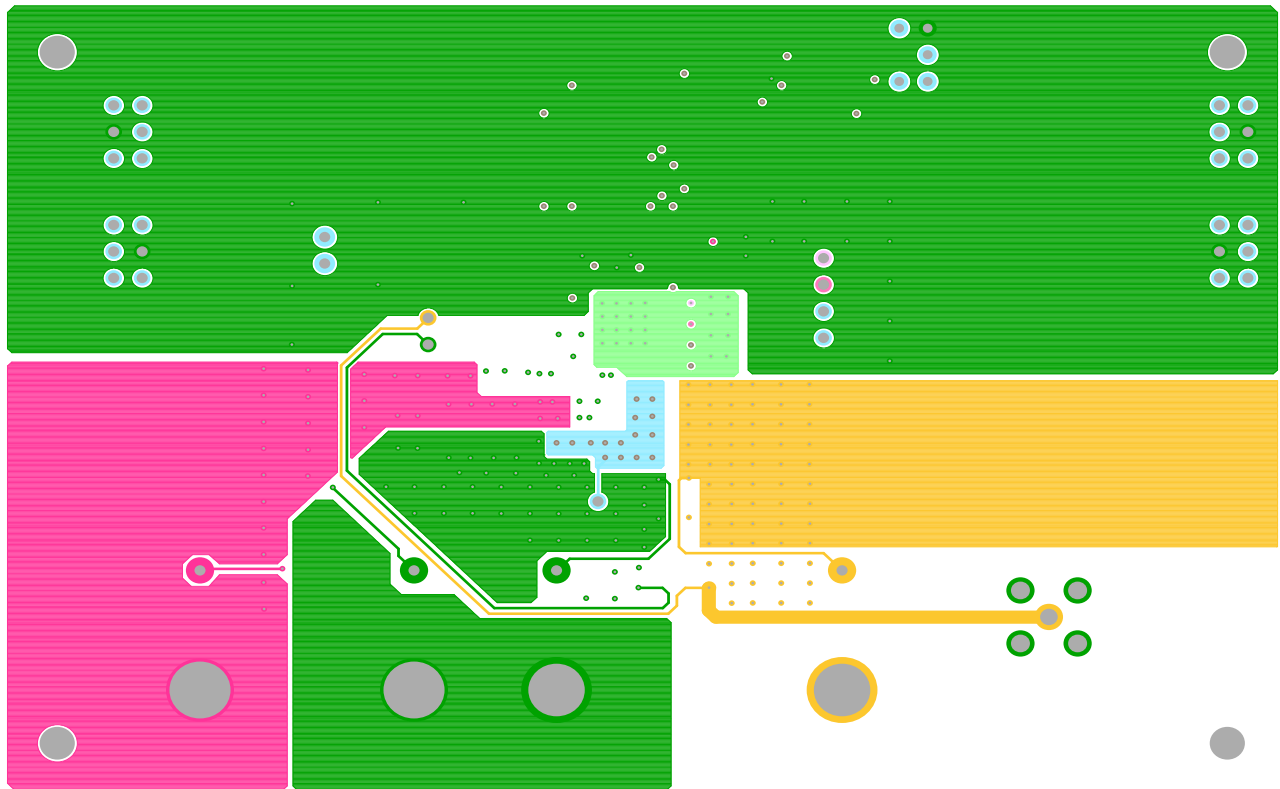

FIGURE 12. PCB - INNER LAYER - LAYER 3 (TOP VIEW)

ISL8270MEVAL1Z Board Layout (Continued)

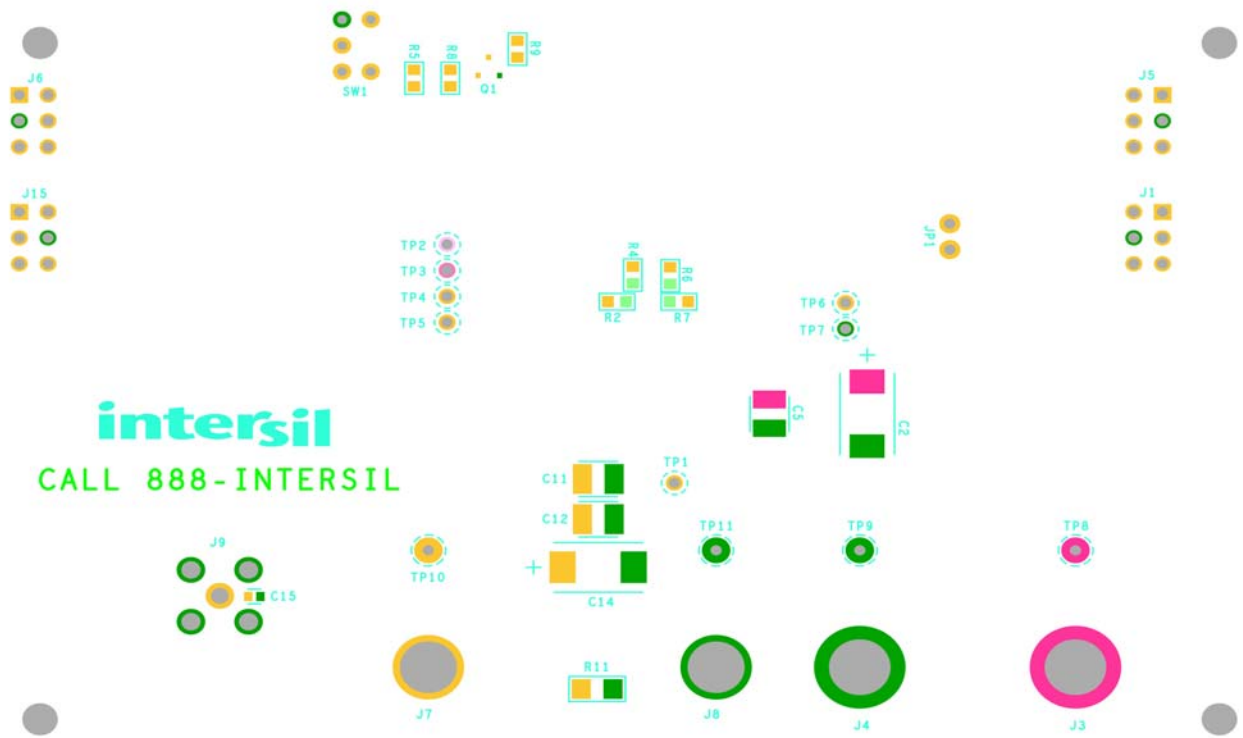

FIGURE 13. PCB - BOTTOM LAYER (BOTTOM VIEW)

Notice

1. Descriptions of circuits, software and other related information in this document are provided only to illustrate the operation of semiconductor products and application examples. You are fully responsible for the incorporation or any other use of the circuits, software, and information in the design of your product or system. Renesas Electronics disclaims any and all liability for any losses and damages incurred by you or third parties arising from the use of these circuits, software, or information.
 2. Renesas Electronics hereby expressly disclaims any warranties against and liability for infringement or any other claims involving patents, copyrights, or other intellectual property rights of third parties, by or arising from the use of Renesas Electronics products or technical information described in this document, including but not limited to, the product data, drawings, charts, programs, algorithms, and application examples.
 3. No license, express, implied or otherwise, is granted hereby under any patents, copyrights or other intellectual property rights of Renesas Electronics or others.
 4. You shall not alter, modify, copy, or reverse engineer any Renesas Electronics product, whether in whole or in part. Renesas Electronics disclaims any and all liability for any losses or damages incurred by you or third parties arising from such alteration, modification, copying or reverse engineering.
 5. Renesas Electronics products are classified according to the following two quality grades: "Standard" and "High Quality". The intended applications for each Renesas Electronics product depends on the product's quality grade, as indicated below.
"Standard": Computers; office equipment; communications equipment; test and measurement equipment; audio and visual equipment; home electronic appliances; machine tools; personal electronic equipment; industrial robots; etc.
"High Quality": Transportation equipment (automobiles, trains, ships, etc.); traffic control (traffic lights); large-scale communication equipment; key financial terminal systems; safety control equipment; etc.
Unless expressly designated as a high reliability product or a product for harsh environments in a Renesas Electronics data sheet or other Renesas Electronics document, Renesas Electronics products are not intended or authorized for use in products or systems that may pose a direct threat to human life or bodily injury (artificial life support devices or systems; surgical implantations; etc.), or may cause serious property damage (space system; undersea repeaters; nuclear power control systems; aircraft control systems; key plant systems; military equipment; etc.). Renesas Electronics disclaims any and all liability for any damages or losses incurred by you or any third parties arising from the use of any Renesas Electronics product that is inconsistent with any Renesas Electronics data sheet, user's manual or other Renesas Electronics document.
 6. When using Renesas Electronics products, refer to the latest product information (data sheets, user's manuals, application notes, "General Notes for Handling and Using Semiconductor Devices" in the reliability handbook, etc.), and ensure that usage conditions are within the ranges specified by Renesas Electronics with respect to maximum ratings, operating power supply voltage range, heat dissipation characteristics, installation, etc. Renesas Electronics disclaims any and all liability for any malfunctions, failure or accident arising out of the use of Renesas Electronics products outside of such specified ranges.
 7. Although Renesas Electronics endeavors to improve the quality and reliability of Renesas Electronics products, semiconductor products have specific characteristics, such as the occurrence of failure at a certain rate and malfunctions under certain use conditions. Unless designated as a high reliability product or a product for harsh environments in a Renesas Electronics data sheet or other Renesas Electronics document, Renesas Electronics products are not subject to radiation resistance design. You are responsible for implementing safety measures to guard against the possibility of bodily injury, injury or damage caused by fire, and/or danger to the public in the event of a failure or malfunction of Renesas Electronics products, such as safety design for hardware and software, including but not limited to redundancy, fire control and malfunction prevention, appropriate treatment for aging degradation or any other appropriate measures. Because the evaluation of microcomputer software alone is very difficult and impractical, you are responsible for evaluating the safety of the final products or systems manufactured by you.
 8. Please contact a Renesas Electronics sales office for details as to environmental matters such as the environmental compatibility of each Renesas Electronics product. You are responsible for carefully and sufficiently investigating applicable laws and regulations that regulate the inclusion or use of controlled substances, including without limitation, the EU RoHS Directive, and using Renesas Electronics products in compliance with all these applicable laws and regulations. Renesas Electronics disclaims any and all liability for damages or losses occurring as a result of your noncompliance with applicable laws and regulations.
 9. Renesas Electronics products and technologies shall not be used for or incorporated into any products or systems whose manufacture, use, or sale is prohibited under any applicable domestic or foreign laws or regulations. You shall comply with any applicable export control laws and regulations promulgated and administered by the governments of any countries asserting jurisdiction over the parties or transactions.
 10. It is the responsibility of the buyer or distributor of Renesas Electronics products, or any other party who distributes, disposes of, or otherwise sells or transfers the product to a third party, to notify such third party in advance of the contents and conditions set forth in this document.
 11. This document shall not be reprinted, reproduced or duplicated in any form, in whole or in part, without prior written consent of Renesas Electronics.
 12. Please contact a Renesas Electronics sales office if you have any questions regarding the information contained in this document or Renesas Electronics products.
- (Note 1) "Renesas Electronics" as used in this document means Renesas Electronics Corporation and also includes its directly or indirectly controlled subsidiaries.
(Note 2) "Renesas Electronics product(s)" means any product developed or manufactured by or for Renesas Electronics.

(Rev.4.0-1 November 2017)



SALES OFFICES

Renesas Electronics Corporation

<http://www.renesas.com>

Refer to "<http://www.renesas.com/>" for the latest and detailed information.

Renesas Electronics America Inc.
1001 Murphy Ranch Road, Milpitas, CA 95035, U.S.A.
Tel: +1-408-432-8888, Fax: +1-408-434-5351

Renesas Electronics Canada Limited
9251 Yonge Street, Suite 8309 Richmond Hill, Ontario Canada L4C 9T3
Tel: +1-905-237-2004

Renesas Electronics Europe Limited
Dukes Meadow, Millboard Road, Bourne End, Buckinghamshire, SL8 5FH, U.K
Tel: +44-1628-651-700, Fax: +44-1628-651-804

Renesas Electronics Europe GmbH
Arcadiastrasse 10, 40472 Düsseldorf, Germany
Tel: +49-211-6503-0, Fax: +49-211-6503-1327

Renesas Electronics (China) Co., Ltd.
Room 1709 Quantum Plaza, No.27 ZhichunLu, Haidian District, Beijing, 100191 P. R. China
Tel: +86-10-8235-1155, Fax: +86-10-8235-7679

Renesas Electronics (Shanghai) Co., Ltd.
Unit 301, Tower A, Central Towers, 555 Langao Road, Putuo District, Shanghai, 200333 P. R. China
Tel: +86-21-2226-0888, Fax: +86-21-2226-0999

Renesas Electronics Hong Kong Limited
Unit 1601-1611, 16/F., Tower 2, Grand Century Place, 193 Prince Edward Road West, Mongkok, Kowloon, Hong Kong
Tel: +852-2265-6688, Fax: +852-2886-9022

Renesas Electronics Taiwan Co., Ltd.
13F, No. 363, Fu Shing North Road, Taipei 10543, Taiwan
Tel: +886-2-8175-9600, Fax: +886-2-8175-9670

Renesas Electronics Singapore Pte. Ltd.
80 Bendemeer Road, Unit #06-02 Hyflux Innovation Centre, Singapore 339949
Tel: +65-6213-0200, Fax: +65-6213-0300

Renesas Electronics Malaysia Sdn.Bhd.
Unit 1207, Block B, Menara Amcorp, Amcorp Trade Centre, No. 18, Jln Persiaran Barat, 46050 Petaling Jaya, Selangor Darul Ehsan, Malaysia
Tel: +60-3-7955-9390, Fax: +60-3-7955-9510

Renesas Electronics India Pvt. Ltd.
No.777C, 100 Feet Road, HAL 2nd Stage, Indiranagar, Bangalore 560 038, India
Tel: +91-80-67208700, Fax: +91-80-67208777

Renesas Electronics Korea Co., Ltd.
17F, KAMCO Yangjae Tower, 262, Gangnam-daero, Gangnam-gu, Seoul, 06265 Korea
Tel: +82-2-558-3737, Fax: +82-2-558-5338