

To our customers,

---

## Old Company Name in Catalogs and Other Documents

---

On April 1<sup>st</sup>, 2010, NEC Electronics Corporation merged with Renesas Technology Corporation, and Renesas Electronics Corporation took over all the business of both companies. Therefore, although the old company name remains in this document, it is a valid Renesas Electronics document. We appreciate your understanding.

Renesas Electronics website: <http://www.renesas.com>

April 1<sup>st</sup>, 2010  
Renesas Electronics Corporation

Issued by: Renesas Electronics Corporation (<http://www.renesas.com>)

Send any inquiries to <http://www.renesas.com/inquiry>.

## Notice

1. All information included in this document is current as of the date this document is issued. Such information, however, is subject to change without any prior notice. Before purchasing or using any Renesas Electronics products listed herein, please confirm the latest product information with a Renesas Electronics sales office. Also, please pay regular and careful attention to additional and different information to be disclosed by Renesas Electronics such as that disclosed through our website.
2. Renesas Electronics does not assume any liability for infringement of patents, copyrights, or other intellectual property rights of third parties by or arising from the use of Renesas Electronics products or technical information described in this document. No license, express, implied or otherwise, is granted hereby under any patents, copyrights or other intellectual property rights of Renesas Electronics or others.
3. You should not alter, modify, copy, or otherwise misappropriate any Renesas Electronics product, whether in whole or in part.
4. Descriptions of circuits, software and other related information in this document are provided only to illustrate the operation of semiconductor products and application examples. You are fully responsible for the incorporation of these circuits, software, and information in the design of your equipment. Renesas Electronics assumes no responsibility for any losses incurred by you or third parties arising from the use of these circuits, software, or information.
5. When exporting the products or technology described in this document, you should comply with the applicable export control laws and regulations and follow the procedures required by such laws and regulations. You should not use Renesas Electronics products or the technology described in this document for any purpose relating to military applications or use by the military, including but not limited to the development of weapons of mass destruction. Renesas Electronics products and technology may not be used for or incorporated into any products or systems whose manufacture, use, or sale is prohibited under any applicable domestic or foreign laws or regulations.
6. Renesas Electronics has used reasonable care in preparing the information included in this document, but Renesas Electronics does not warrant that such information is error free. Renesas Electronics assumes no liability whatsoever for any damages incurred by you resulting from errors in or omissions from the information included herein.
7. Renesas Electronics products are classified according to the following three quality grades: "Standard", "High Quality", and "Specific". The recommended applications for each Renesas Electronics product depends on the product's quality grade, as indicated below. You must check the quality grade of each Renesas Electronics product before using it in a particular application. You may not use any Renesas Electronics product for any application categorized as "Specific" without the prior written consent of Renesas Electronics. Further, you may not use any Renesas Electronics product for any application for which it is not intended without the prior written consent of Renesas Electronics. Renesas Electronics shall not be in any way liable for any damages or losses incurred by you or third parties arising from the use of any Renesas Electronics product for an application categorized as "Specific" or for which the product is not intended where you have failed to obtain the prior written consent of Renesas Electronics. The quality grade of each Renesas Electronics product is "Standard" unless otherwise expressly specified in a Renesas Electronics data sheets or data books, etc.

"Standard": Computers; office equipment; communications equipment; test and measurement equipment; audio and visual equipment; home electronic appliances; machine tools; personal electronic equipment; and industrial robots.

"High Quality": Transportation equipment (automobiles, trains, ships, etc.); traffic control systems; anti-disaster systems; anti-crime systems; safety equipment; and medical equipment not specifically designed for life support.

"Specific": Aircraft; aerospace equipment; submersible repeaters; nuclear reactor control systems; medical equipment or systems for life support (e.g. artificial life support devices or systems), surgical implantations, or healthcare intervention (e.g. excision, etc.), and any other applications or purposes that pose a direct threat to human life.

8. You should use the Renesas Electronics products described in this document within the range specified by Renesas Electronics, especially with respect to the maximum rating, operating supply voltage range, movement power voltage range, heat radiation characteristics, installation and other product characteristics. Renesas Electronics shall have no liability for malfunctions or damages arising out of the use of Renesas Electronics products beyond such specified ranges.
9. Although Renesas Electronics endeavors to improve the quality and reliability of its products, semiconductor products have specific characteristics such as the occurrence of failure at a certain rate and malfunctions under certain use conditions. Further, Renesas Electronics products are not subject to radiation resistance design. Please be sure to implement safety measures to guard them against the possibility of physical injury, and injury or damage caused by fire in the event of the failure of a Renesas Electronics product, such as safety design for hardware and software including but not limited to redundancy, fire control and malfunction prevention, appropriate treatment for aging degradation or any other appropriate measures. Because the evaluation of microcomputer software alone is very difficult, please evaluate the safety of the final products or system manufactured by you.
10. Please contact a Renesas Electronics sales office for details as to environmental matters such as the environmental compatibility of each Renesas Electronics product. Please use Renesas Electronics products in compliance with all applicable laws and regulations that regulate the inclusion or use of controlled substances, including without limitation, the EU RoHS Directive. Renesas Electronics assumes no liability for damages or losses occurring as a result of your noncompliance with applicable laws and regulations.
11. This document may not be reproduced or duplicated, in any form, in whole or in part, without prior written consent of Renesas Electronics.
12. Please contact a Renesas Electronics sales office if you have any questions regarding the information contained in this document or Renesas Electronics products, or if you have any other inquiries.

(Note 1) "Renesas Electronics" as used in this document means Renesas Electronics Corporation and also includes its majority-owned subsidiaries.

(Note 2) "Renesas Electronics product(s)" means any product developed or manufactured by or for Renesas Electronics.

# H8S/2678R E6000 Emulator

User's Manual

Renesas Microcomputer  
Development Environment  
System

H8S Family / H8S/2600 Series

H8S Family / H8S/2300 Series

HS2678REPI61HE-U2



## Keep safety first in your circuit designs!

1. Renesas Technology Corp. puts the maximum effort into making semiconductor products better and more reliable, but there is always the possibility that trouble may occur with them. Trouble with semiconductors may lead to personal injury, fire or property damage.  
Remember to give due consideration to safety when making your circuit designs, with appropriate measures such as (i) placement of substitutive, auxiliary circuits, (ii) use of nonflammable material or (iii) prevention against any malfunction or mishap.

## Notes regarding these materials

1. These materials are intended as a reference to assist our customers in the selection of the Renesas Technology Corp. product best suited to the customer's application; they do not convey any license under any intellectual property rights, or any other rights, belonging to Renesas Technology Corp. or a third party.
2. Renesas Technology Corp. assumes no responsibility for any damage, or infringement of any third-party's rights, originating in the use of any product data, diagrams, charts, programs, algorithms, or circuit application examples contained in these materials.
3. All information contained in these materials, including product data, diagrams, charts, programs and algorithms represents information on products at the time of publication of these materials, and are subject to change by Renesas Technology Corp. without notice due to product improvements or other reasons. It is therefore recommended that customers contact Renesas Technology Corp. or an authorized Renesas Technology Corp. product distributor for the latest product information before purchasing a product listed herein.  
The information described here may contain technical inaccuracies or typographical errors.  
Renesas Technology Corp. assumes no responsibility for any damage, liability, or other loss rising from these inaccuracies or errors.  
Please also pay attention to information published by Renesas Technology Corp. by various means, including the Renesas Technology Corp. Semiconductor home page (<http://www.renesas.com>).
4. When using any or all of the information contained in these materials, including product data, diagrams, charts, programs, and algorithms, please be sure to evaluate all information as a total system before making a final decision on the applicability of the information and products. Renesas Technology Corp. assumes no responsibility for any damage, liability or other loss resulting from the information contained herein.
5. Renesas Technology Corp. semiconductors are not designed or manufactured for use in a device or system that is used under circumstances in which human life is potentially at stake. Please contact Renesas Technology Corp. or an authorized Renesas Technology Corp. product distributor when considering the use of a product contained herein for any specific purposes, such as apparatus or systems for transportation, vehicular, medical, aerospace, nuclear, or undersea repeater use.
6. The prior written approval of Renesas Technology Corp. is necessary to reprint or reproduce in whole or in part these materials.
7. If these products or technologies are subject to the Japanese export control restrictions, they must be exported under a license from the Japanese government and cannot be imported into a country other than the approved destination.  
Any diversion or reexport contrary to the export control laws and regulations of Japan and/or the country of destination is prohibited.
8. Please contact Renesas Technology Corp. for further details on these materials or the products contained therein.



# IMPORTANT INFORMATION

## READ FIRST

- **READ this user's manual before using this emulator product.**
- **KEEP the user's manual handy for future reference.**

**Do not attempt to use the emulator product until you fully understand its mechanism.**

### **Emulator Product:**

Throughout this document, the term "emulator product" shall be defined as the following products produced only by Renesas Technology Corp. excluding all subsidiary products.

- Emulator station
- User system interface cables
- PC interface board
- Optional SIMM memory module
- Optional board

The user system or a host computer is not included in this definition.

### **Purpose of the Emulator Product:**

This emulator product is a software and hardware development tool for systems employing the Renesas microcomputer (hereinafter referred to as the MCU). This emulator product must only be used for the above purpose.

### **Limited Applications:**

This emulator product is not authorized for use in MEDICAL, atomic energy, aeronautical or space technology applications without consent of the appropriate officer of a Renesas sales company. Such use includes, but is not limited to, use in life support systems. Buyers of this emulator product must notify the relevant Renesas sales offices before planning to use the product in such applications.

### **Improvement Policy:**

Renesas Technology Corp. (including its subsidiaries, hereafter collectively referred to as Renesas) pursues a policy of continuing improvement in design, performance, and safety of the emulator product. Renesas reserves the right to change, wholly or partially, the specifications, design, user's manual, and other documentation at any time without notice.

### **Target User of the Emulator Product:**

This emulator product should only be used by those who have carefully read and thoroughly understood the information and restrictions contained in the user's manual. Do not attempt to use the emulator product until you fully understand its mechanism.

It is highly recommended that first-time users be instructed by users that are well versed in the operation of the emulator product.

## **LIMITED WARRANTY**

Renesas warrants its emulator products to be manufactured in accordance with published specifications and free from defects in material and/or workmanship. Renesas, at its option, will repair or replace any emulator products returned intact to the factory, transportation charges prepaid, which Renesas, upon inspection, determine to be defective in material and/or workmanship. The foregoing shall constitute the sole remedy for any breach of Renesas' warranty. See the Renesas warranty booklet for details on the warranty period. This warranty extends only to you, the original Purchaser. It is not transferable to anyone who subsequently purchases the emulator product from you. Renesas is not liable for any claim made by a third party or made by you for a third party.

## **DISCLAIMER**

RENESAS MAKES NO WARRANTIES, EITHER EXPRESS OR IMPLIED, ORAL OR WRITTEN, EXCEPT AS PROVIDED HEREIN, INCLUDING WITHOUT LIMITATION THEREOF, WARRANTIES AS TO MARKETABILITY, MERCHANTABILITY, FITNESS FOR ANY PARTICULAR PURPOSE OR USE, OR AGAINST INFRINGEMENT OF ANY PATENT. IN NO EVENT SHALL RENESAS BE LIABLE FOR ANY DIRECT, INCIDENTAL OR CONSEQUENTIAL DAMAGES OF ANY NATURE, OR LOSSES OR EXPENSES RESULTING FROM ANY DEFECTIVE EMULATOR PRODUCT, THE USE OF ANY EMULATOR PRODUCT, OR ITS DOCUMENTATION, EVEN IF ADVISED OF THE POSSIBILITY OF SUCH DAMAGES. EXCEPT AS EXPRESSLY STATED OTHERWISE IN THIS WARRANTY, THIS EMULATOR PRODUCT IS SOLD "AS IS", AND YOU MUST ASSUME ALL RISK FOR THE USE AND RESULTS OBTAINED FROM THE EMULATOR PRODUCT.



## **State Law:**

Some states do not allow the exclusion or limitation of implied warranties or liability for incidental or consequential damages, so the above limitation or exclusion may not apply to you. This warranty gives you specific legal rights, and you may have other rights which may vary from state to state.

## **The Warranty is Void in the Following Cases:**

Renesas shall have no liability or legal responsibility for any problems caused by misuse, abuse, misapplication, neglect, improper handling, installation, repair or modifications of the emulator product without Renesas' prior written consent or any problems caused by the user system.

## **All Rights Reserved:**

This user's manual and emulator product are copyrighted and all rights are reserved by Renesas. No part of this user's manual, all or part, may be reproduced or duplicated in any form, in hard-copy or machine-readable form, by any means available without Renesas' prior written consent.

## **Other Important Things to Keep in Mind:**

1. Circuitry and other examples described herein are meant merely to indicate the characteristics and performance of Renesas' semiconductor products. Renesas assumes no responsibility for any intellectual property claims or other problems that may result from applications based on the examples described herein.
2. No license is granted by implication or otherwise under any patents or other rights of any third party or Renesas.

## **Figures:**

Some figures in this user's manual may show items different from your actual system.

## **Limited Anticipation of Danger:**

Renesas cannot anticipate every possible circumstance that might involve a potential hazard. The warnings in this user's manual and on the emulator product are therefore not all inclusive. Therefore, you must use the emulator product safely at your own risk.

# SAFETY PAGE

## READ FIRST

- **READ** this user's manual before using this emulator product.
- **KEEP the user's manual handy for future reference.**

Do not attempt to use the emulator product until you fully understand its mechanism.

## DEFINITION OF SIGNAL WORDS



This is the safety alert symbol. It is used to alert you to potential personal injury hazards. Obey all safety messages that follow this symbol to avoid possible injury or death.



**DANGER** indicates an imminently hazardous situation which, if not avoided, will result in death or serious injury.



**WARNING** indicates a potentially hazardous situation which, if not avoided, could result in death or serious injury.



**CAUTION** indicates a potentially hazardous situation which, if not avoided, may result in minor or moderate injury.



**CAUTION** used without the safety alert symbol indicates a potentially hazardous situation which, if not avoided, may result in property damage.

**NOTE** emphasizes essential information.

# **WARNING**

**Observe the precautions listed below. Failure to do so will result in a FIRE HAZARD and will damage the user system and the emulator product or will result in PERSONAL INJURY. The USER PROGRAM will be LOST.**

- 1. Do not repair or remodel the emulator product by yourself for electric shock prevention and quality assurance.**
- 2. Always switch OFF the E6000 emulator and user system before connecting or disconnecting any CABLES or PARTS.**
- 3. Always before connecting any CABLES, make sure that pin 1 on both sides are correctly aligned.**
- 4. Supply power according to the power specifications and do not apply an incorrect power voltage. Use only the provided power cable.**

# CAUTION

**This equipment has been tested and found to comply with the limits for a Class A digital device, pursuant to part 15 of the FCC Rules. These limits are designed to provide reasonable protection against harmful interference when the equipment is operated in a commercial environment. This equipment generates, uses, and can radiate radio frequency energy and, if not installed and used in accordance with the instruction manual, may cause harmful interference to radio communications. Operation of this equipment in a residential area is likely to cause harmful interference in which case the user will be required to correct the interference at his own expense.**

# Introduction

The E6000 emulator is an advanced realtime in-circuit emulator, which allows programs to be developed and debugged for the H8S family microcomputers.

The E6000 emulator can either be used without a user system, for developing and debugging software, or connected via a user system interface cable to a user system, for debugging user hardware.

High-performance Embedded Workshop is a Graphical User Interface intended to ease the development and debugging of applications written in C/C++ programming language and assembly language for Renesas microcomputers. Its aim is to provide a powerful yet intuitive way of accessing, observing and modifying the debugging platform in which the application is running.

High-performance Embedded Workshop is a powerful development environment for embedded applications targeted at Renesas microcontrollers. The main features are:

- A configurable build engine that allows you to set-up compiler, assembler and linker options via an easy to use interface.
- An integrated text editor with user customizable syntax coloring to improve code readability.
- A configurable environment to run your own tools.
- An integrated debugger which allows you to build and debug in the same application.
- Version control support.

High-performance Embedded Workshop has been designed with two key aims; firstly to provide you, the user, with a set of powerful development tools and, secondly, to unify and present them in a way that is easy to use.

# About This Manual

This manual contains the following information.

Emulator Debugger Part: Preparation before use, E6000 emulator functions, debugging function, tutorial, and hardware and software specifications of the E6000 emulator.

Refer to the High-performance Embedded Workshop User's Manual for details on the information on the basic usage of the High-performance Embedded Workshop, customization of the environment, build functions, and debugging functions common to each High-performance Embedded Workshop product.

This manual does not intend to explain how to write C/C++ or assembly language programs, how to use any particular operating system or how best to tailor code for the individual devices. These issues are left to the respective manuals.

Microsoft®, MS-DOS, Windows®, Windows NT® are registered trademarks of Microsoft Corporation.

Visual SourceSafe is a trademark of Microsoft Corporation.

IBM is a registered trademark of International Business Machines Corporation.

All brand or product names used in this manual are trademarks or registered trademarks of their respective companies or organizations.

## Document Conventions

This manual uses the following typographic conventions:

**Table 1** Typographic Conventions

| Convention                 | Meaning  |
|----------------------------|--|
| [Menu->Menu Option]        | Bold text with '->' is used to indicate menu options (for example, [ <b>File-&gt;Save As...</b> ]).  |
| FILENAME.C                 | Uppercase names are used to indicate filenames.  |
| "enter this string"        | Used to indicate text that must be entered (excluding the "" quotes).  |
| Key + Key                  | Used to indicate required key presses. For example, <b>CTRL+N</b> means press the <b>CTRL</b> key and then, whilst holding the <b>CTRL</b> key down, press the <b>N</b> key. |
| ↻<br>(The "how to" symbol) | When this symbol is used, it is always located in the left hand margin. It indicates that the text to its immediate right is describing "how to" do something.               |

## Components

Check all the components described in the component list unpacking. If the components are not complete, contact a Renesas sales office.

# Contents

## Emulator Debugger Part

|  |    |
|--|----|
| Section 1 Overview .....   | 1  |
| 1.1 Features .....   | 1  |
| 1.2 Warnings .....   | 2  |
| 1.3 Environmental Conditions .....   | 3  |
| 1.4 Emulator External Dimensions and Mass .....  | 3  |
| Section 2 Preparation before Use .....   | 5  |
| 2.1 Emulator Preparation .....   | 5  |
| 2.2 Installing Emulator's Software .....   | 5  |
| 2.3 Connecting to the User System .....  | 6  |
| 2.3.1 Example of Connecting the User System Interface Cable Head<br>to the User System ..... | 6  |
| 2.3.2 Plugging the User System Interface Cable Body into the Emulator .....                  | 7  |
| 2.3.3 Plugging the User System Interface Cable Body into the Cable Head .....                | 7  |
| 2.4 Power Supply .....   | 8  |
| 2.4.1 AC Adapter .....   | 8  |
| 2.4.2 Polarity .....   | 8  |
| 2.4.3 Power Supply Monitor Circuit .....   | 8  |
| 2.5 SIMM Memory Module .....   | 8  |
| 2.5.1 Optional SIMM Memory Module Configuration .....  | 8  |
| 2.6 Hardware Interface .....   | 9  |
| 2.6.1 Signal Protection on the emulator .....  | 9  |
| 2.6.2 User System Interface Circuits .....   | 9  |
| 2.6.3 Clock Oscillator .....   | 9  |
| 2.6.4 External Probe 1 (EXT1)/Trigger Output .....   | 9  |
| 2.6.5 External Probe 2 (EXT2)/Trigger Output .....   | 10 |
| 2.6.6 Voltage Follower Circuit .....   | 11 |
| 2.7 System Check .....   | 12 |
| 2.8 Communication Problems .....   | 17 |
| 2.9 Other Methods for Activating the Emulator .....  | 17 |
| 2.10 Uninstalling the Emulator's Software .....  | 17 |
| Section 3 E6000 Emulator Functions .....   | 19 |
| 3.1 Debugging Features .....   | 19 |
| 3.1.1 Breakpoints .....  | 19 |
| 3.1.2 Trace .....  | 19 |
| 3.1.3 Execution Time Measurements .....  | 19 |
| 3.1.4 Performance Analysis .....   | 19 |
| 3.1.5 Bus Monitoring .....   | 20 |
| 3.2 Complex Event System (CES) .....   | 20 |
| 3.2.1 Event Channels .....   | 20 |
| 3.2.2 Range Channels .....   | 21 |
| 3.2.3 Breaks .....   | 21 |
| 3.2.4 Timing .....   | 21 |
| 3.3 Hardware Features .....  | 22 |
| 3.3.1 Memory .....   | 22 |
| 3.3.2 Clocks .....   | 23 |

|  |  |    |
|--|--|----|
| 3.3.3                                  | Probes .....   | 23 |
| 3.4                                    | Stack Trace Function .....                                     | 23 |
| 3.5                                    | Online Help.....   | 23 |
| Section 4 Preparation before Use ..... |  | 25 |
| 4.1                                    | Method for Activating High-performance Embedded Workshop.....  | 25 |
| 4.1.1                                  | Creating a New Workspace (Toolchain Not Used).....             | 26 |
| 4.1.2                                  | Creating a New Workspace (Toolchain Used).....                 | 30 |
| 4.1.3                                  | Selecting an Existing Workspace.....                           | 34 |
| 4.2                                    | Connecting the Emulator .....                                  | 35 |
| 4.3                                    | Reconnecting the Emulator.....                                 | 36 |
| 4.4                                    | Ending the Emulator.....                                       | 36 |
| Section 5 Debugging .....              |  | 37 |
| 5.1                                    | Setting the Environment for Emulation .....                    | 38 |
| 5.1.1                                  | Opening the [Configuration Properties] Dialog Box .....        | 38 |
| 5.1.2                                  | Selecting an MCU Not Included in the List.....                 | 40 |
| 5.1.3                                  | Selecting the Interface to be Connected.....                   | 41 |
| 5.1.4                                  | Opening the [Memory Mapping] Dialog Box.....                   | 42 |
| 5.1.5                                  | Changing the Memory Map Setting.....                           | 43 |
| 5.2                                    | Downloading a Program .....                                    | 44 |
| 5.2.1                                  | Downloading a Program .....                                    | 44 |
| 5.2.2                                  | Viewing the Source Code .....                                  | 45 |
| 5.2.3                                  | Viewing the Assembly-Language Code.....                        | 48 |
| 5.2.4                                  | Modifying the Assembly-Language Code .....                     | 49 |
| 5.2.5                                  | Viewing a Specific Address.....                                | 49 |
| 5.2.6                                  | Viewing the Current Program Counter Address .....              | 49 |
| 5.3                                    | Viewing the Current Status.....                                | 50 |
| 5.4                                    | Reading and Displaying the Emulator Information Regularly..... | 51 |
| 5.4.1                                  | Opening the [Extended Monitor] Window .....                    | 51 |
| 5.4.2                                  | Selecting Items to be Displayed.....                           | 52 |
| 5.5                                    | Displaying Memory Contents in Realtime.....                    | 53 |
| 5.5.1                                  | Opening the [Monitor] Window .....                             | 53 |
| 5.5.2                                  | Changing the Monitor Settings .....                            | 55 |
| 5.5.3                                  | Temporarily Stopping Update of the Monitor .....               | 55 |
| 5.5.4                                  | Deleting the Monitor Settings.....                             | 55 |
| 5.5.5                                  | Monitoring Variables.....                                      | 55 |
| 5.5.6                                  | Hiding the [Monitor] Window .....                              | 56 |
| 5.5.7                                  | Managing the [Monitor] Window .....                            | 57 |
| 5.6                                    | Viewing the Variables.....                                     | 58 |
| 5.6.1                                  | [Watch] Window.....  | 58 |
| 5.7                                    | Using the Event Points.....                                    | 60 |
| 5.7.1                                  | Software Breakpoints.....                                      | 60 |
| 5.7.2                                  | Event Points .....   | 60 |
| 5.7.3                                  | Event Detection System.....                                    | 60 |
| 5.7.4                                  | Signals to Indicate Bus States and Areas .....                 | 61 |
| 5.7.5                                  | Opening the [Event] Window .....                               | 62 |
| 5.7.6                                  | Setting Software Breakpoints.....                              | 62 |
| 5.7.7                                  | Setting Event Points.....                                      | 64 |
| 5.7.8                                  | Setting Trigger Points .....                                   | 72 |
| 5.7.9                                  | Editing Event Points .....                                     | 73 |
| 5.7.10                                 | Modifying Event Points.....                                    | 73 |
| 5.7.11                                 | Enabling an Event Point.....                                   | 73 |



|                         |   |     |
|-------------------------|---|-----|
| 5.7.12                  | Disabling an Event Point.....                                       | 73  |
| 5.7.13                  | Deleting an Event Point .....                                       | 73  |
| 5.7.14                  | Deleting All Event Points .....                                     | 73  |
| 5.7.15                  | Viewing the Source Line for an Event Point.....                     | 73  |
| 5.8                     | Viewing the Trace Information.....                                  | 74  |
| 5.8.1                   | Opening the [Trace] Window .....                                    | 74  |
| 5.8.2                   | Acquiring Trace Information .....                                   | 74  |
| 5.8.3                   | Specifying Trace Acquisition Conditions .....                       | 76  |
| 5.8.4                   | Searching for a Trace Record.....                                   | 84  |
| 5.8.5                   | Clearing the Trace Information.....                                 | 93  |
| 5.8.6                   | Saving the Trace Information in a File.....                         | 93  |
| 5.8.7                   | Viewing the [Editor] Window.....                                    | 94  |
| 5.8.8                   | Trimming the Source .....   | 94  |
| 5.8.9                   | Acquiring a Snapshot of the Trace Information.....                  | 94  |
| 5.8.10                  | Temporarily Stopping Trace Acquisition.....                         | 94  |
| 5.8.11                  | Restarting Trace Acquisition .....                                  | 94  |
| 5.8.12                  | Extracting Records from the Acquired Information.....               | 95  |
| 5.8.13                  | Calculating the Difference in Time Stamping.....                    | 105 |
| 5.8.14                  | Analyzing Statistical Information .....                             | 106 |
| 5.8.15                  | Extracting Function Calls from the Acquired Trace Information ..... | 107 |
| 5.9                     | Analyzing Performance.....  | 108 |
| 5.9.1                   | Opening the [Performance Analysis] Window .....                     | 110 |
| 5.9.2                   | Setting Conditions for Measurement .....                            | 111 |
| 5.9.3                   | Selecting the Address Detection Mode and Resolution .....           | 118 |
| 5.9.4                   | Starting Performance Data Acquisition .....                         | 118 |
| 5.9.5                   | Deleting a Measurement Condition .....                              | 118 |
| 5.9.6                   | Deleting All Measurement Conditions.....                            | 118 |
| Section 6 Tutorial..... |   | 119 |
| 6.1                     | Introduction.....   | 119 |
| 6.2                     | Running the High-performance Embedded Workshop.....                 | 120 |
| 6.3                     | Downloading the Tutorial Program .....                              | 121 |
| 6.3.1                   | Downloading the Tutorial Program.....                               | 121 |
| 6.3.2                   | Displaying the Source Program.....                                  | 122 |
| 6.4                     | Setting a Software Breakpoint .....                                 | 123 |
| 6.5                     | Setting Registers .....   | 124 |
| 6.6                     | Executing the Program.....  | 125 |
| 6.7                     | Reviewing Breakpoints.....  | 128 |
| 6.8                     | Referring to Symbols.....   | 129 |
| 6.9                     | Viewing Memory.....   | 130 |
| 6.10                    | Watching Variables.....   | 131 |
| 6.11                    | Displaying Local Variables.....                                     | 134 |
| 6.12                    | Stepping Through a Program .....                                    | 135 |
| 6.12.1                  | Executing the [Step In] Command .....                               | 135 |
| 6.12.2                  | Executing the [Step Out] Command .....                              | 137 |
| 6.12.3                  | Executing the [Step Over] Command .....                             | 138 |
| 6.13                    | Forced Breaking of Program Executions .....                         | 139 |
| 6.14                    | Resetting the MCU .....   | 139 |
| 6.15                    | Break Function.....   | 140 |
| 6.15.1                  | Software Break Function.....  | 140 |
| 6.15.2                  | Breaking Execution at Event Points.....                             | 145 |
| 6.16                    | Trace Functions.....  | 149 |
| 6.16.1                  | Displaying a Trace (when Time Stamping is not Available) .....      | 150 |

|   |  |            |
|---|--|------------|
| 6.16.2  | Displaying a Trace (when Time Stamping is Available) .....             | 156        |
| 6.16.3  | Statistics .....   | 160        |
| 6.16.4  | Function Calls .....   | 164        |
| 6.17  | Stack Trace Function .....   | 165        |
| 6.18  | Performance Measurement Function .....                                 | 167        |
| 6.18.1  | Time Of Specified Range Measurement .....                              | 167        |
| 6.19  | Monitor Function .....   | 170        |
| 6.20  | What Next? .....   | 172        |
| <b>Section 7 Hardware Specifications Specific to This Product .....</b> |  | <b>173</b> |
| 7.1   | H8S/2678R E6000 Emulator Specifications .....                          | 173        |
| 7.1.1   | Supported MCUs and User System Interface Cables .....                  | 173        |
| 7.1.2   | Operating Voltage and Frequency Specifications .....                   | 173        |
| 7.2   | User System Interface .....  | 174        |
| 7.2.1   | Signal Protection .....  | 174        |
| 7.2.2   | User System Interface Circuits .....                                   | 174        |
| 7.3   | Differences between MCU and Emulator .....                             | 176        |
| 7.3.1   | A/D Converter and D/A Converter .....                                  | 176        |
| 7.3.2   | Operating Frequency for the H8S/2378, H8S/2378R, and H8S/2368 .....    | 176        |
| <b>Section 8 Software Specifications Specific to This Product .....</b> |  | <b>177</b> |
| 8.1   | Software Specifications of the H8S/2678R E6000 Emulator .....          | 177        |
| 8.1.1   | Target Hardware .....  | 177        |
| 8.1.2   | Selectable Platforms .....   | 177        |
| 8.1.3   | [Configuration Properties] Dialog Box ([General] Page) .....           | 178        |
| 8.1.4   | [Configuration Properties] Dialog Box ([Custom] Page) .....            | 183        |
| 8.1.5   | Memory Mapping Function .....  | 186        |
| 8.1.6   | [Status] Window .....  | 186        |
| 8.1.7   | Extended Monitor Function .....  | 188        |
| 8.1.8   | Signals to Indicate Bus States and Areas .....                         | 189        |
| 8.1.9   | Monitoring Function .....  | 189        |
| 8.1.10  | Trigger Points .....   | 189        |
| 8.1.11  | Trace Information .....  | 190        |
| 8.1.12  | Searching for a Trace Record .....                                     | 191        |
| 8.1.13  | Trace Filtering Function .....   | 192        |
| 8.2   | Notes on Usage of the H8S/2678R E6000 Emulator .....                   | 194        |
| 8.2.1   | Environment for Execution of the Tutorial Program .....                | 194        |
| 8.2.2   | I/O Register Differences between the Actual MCU and the Emulator ..... | 194        |
| 8.2.3   | Access to the Reserved Area .....                                      | 194        |
| 8.2.4   | Using the Internal RAM Area as External Addresses .....                | 194        |
| 8.2.5   | Support of Flash Memory .....  | 194        |
| 8.2.6   | Hardware Standby .....   | 195        |
| 8.2.7   | EXDMA Controller .....   | 195        |
| 8.2.8   | SIMM Memory Module Access .....  | 195        |
| 8.2.9   | Power Supply Follower Circuit .....                                    | 195        |
| 8.2.10  | IRQ Signal Trace .....   | 195        |
| <b>Appendix A I/O File Format .....</b>                                 |  | <b>197</b> |
| A.1   | File format (Bit Field Not Supported) .....                            | 197        |
| A.2   | File format (Bit Field Supported) .....                                | 199        |
| <b>Appendix B Menus .....</b>   |  | <b>201</b> |

Appendix C Command Lines..... 205

Appendix D Diagnostic Test Procedure ..... 209

D.1 System Set-Up for Test Program Execution .....209

D.2 Diagnostic Test Procedure Using Test Program .....210



## Emulator Debugger Part



# Section 1 Overview

## 1.1 Features

- The breakpoint, memory map, performance, and trace can be set through the dialog box.
  - Intuitive user interface
  - Online help
  - Common display and operability
- Supported host interfaces  
The PCI interface, PC card (PCMCIA) interface, USB interface, or LAN interface can be used for connecting to the host computer.
- Realtime emulation  
Realtime emulation of the user system is enabled at the maximum operating frequency of the CPU.
- Excellent operability  
Using the High-performance Embedded Workshop enables user program debugging using a pointing device such as a mouse. The High-performance Embedded Workshop enables high-speed downloading of load module files.
- Various debugging functions  
Various break and trace functions enable efficient debugging. Breakpoints and break conditions can be set by the specific window, trace information can be displayed on a window, and command-line functions can be used.
- Memory access during emulation  
During emulation, the memory contents can be read and modified.

## 1.2 Warnings

### CAUTION

**READ the following warnings before using the emulator product. Incorrect operation will damage the user system and the emulator product. The USER PROGRAM will be LOST.**

1. Check all components against the component list after unpacking the emulator.
2. Never place heavy objects on the casing.
3. Do not place the emulator in places where:
  - The temperature becomes high such as in direct sunlight or near a heater. For details, refer to section 1.3, Environmental Conditions.
  - The temperature or humidity changes greatly.
  - There is a lot of dust.
  - There is a lot of vibration. For details, refer to section 1.3, Environmental Conditions.
4. Protect the emulator from excessive impacts and stresses.
5. Only supply the specified voltage and power-supply frequency.
6. When moving the emulator, take care not to vibrate or damage it.
7. After connecting the cable, check that it is connected correctly. For details, refer to section 2, Preparation before Use. Supply power to the connected equipment after connecting all cables. For the supplying procedures, refer to section 2.7, System Check. Cables must not be connected or disconnected while the power is on.



### 1.3 Environmental Conditions

## CAUTION

Observe the conditions listed in table 1.1 when using the emulator. Failure to do so will cause illegal operation in the user system, the emulator product, and the user program.

Table 1.1 Environmental Conditions

| Item          | Specifications  |
|---------------|---|
| Temperature   | Operating: +10°C to +35°C<br>Storage: -10°C to +50°C  |
| Humidity      | Operating: 35% RH to 80% RH, no condensation<br>Storage: 35% RH to 80% RH, no condensation                                |
| Vibration     | Operating: 2.45 m/s <sup>2</sup> max.<br>Storage: 4.9 m/s <sup>2</sup> max.<br>Transportation: 14.7 m/s <sup>2</sup> max. |
| Ambient gases | No corrosive gases may be present   |

### 1.4 Emulator External Dimensions and Mass

Table 1.2 Emulator External Dimensions and Mass

| Item       | Specifications        |
|------------|-----------------------|
| Dimensions | 219 × 170 × 54 mm     |
| Mass       | Approximately 1,000 g |



## Section 2 Preparation before Use

### 2.1 Emulator Preparation

Unpack the emulator and prepare it for use as follows:

 **WARNING**

**READ the reference sections shaded in figure 2.1 before using the emulator product. Incorrect operation will damage the user system and the emulator product. The USER PROGRAM will be LOST.**

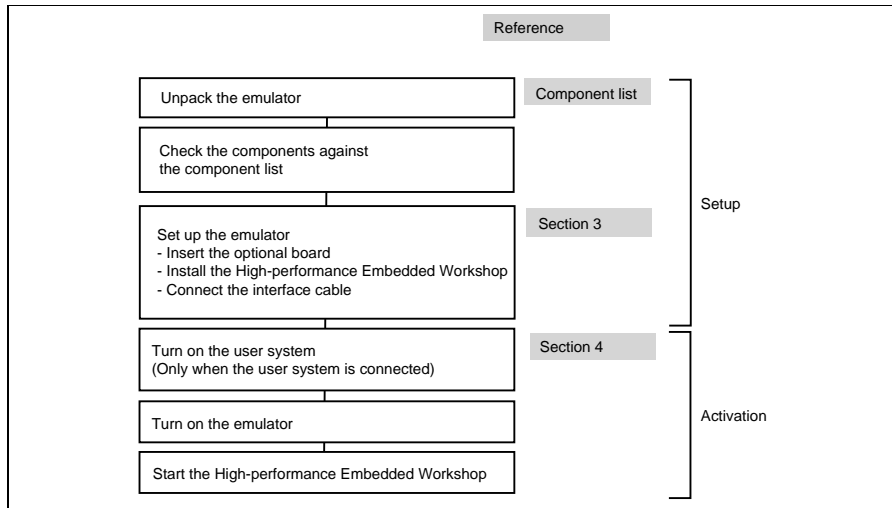

Figure 2.1 Emulator Preparation Flowchart

### 2.2 Installing Emulator's Software

To install the High-performance Embedded Workshop, refer to the Setup Guide for the E6000 Emulator supplied together with the emulator.

## 2.3 Connecting to the User System

To connect the emulator to a user system, proceed as follows:

- Connect the user system interface cable head to the user system.
- Plug the cable body into the emulator.
- Plug the cable body into the cable head.

For details of these steps, refer to the User System Interface Cable User's Manual.

Figure 2.2 gives details of the connectors provided on the emulator.

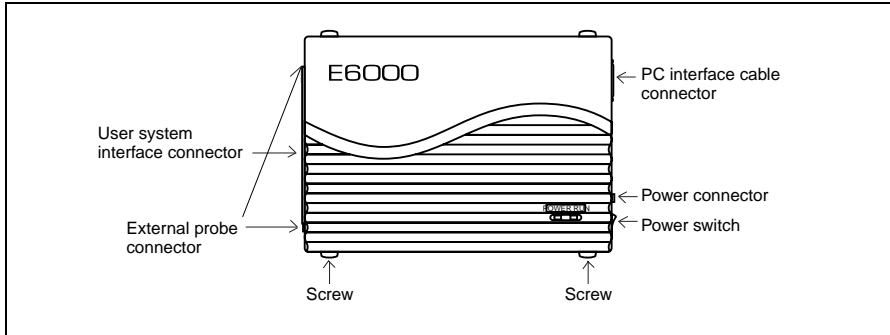

Figure 2.2 E6000 Emulator Connectors

### 2.3.1 Example of Connecting the User System Interface Cable Head to the User System

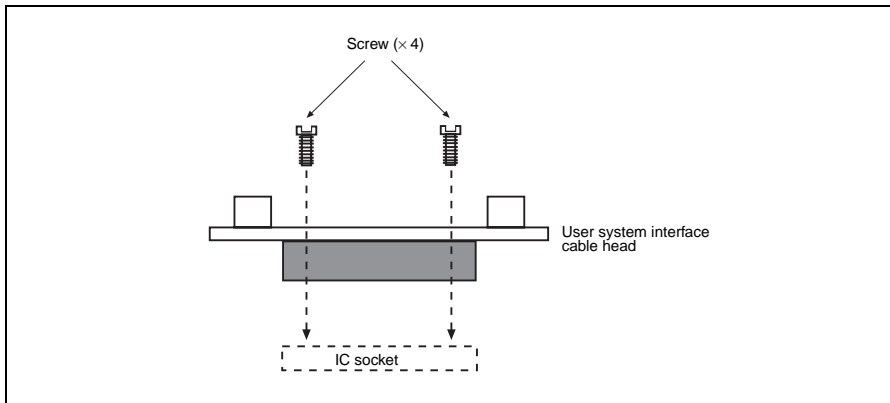
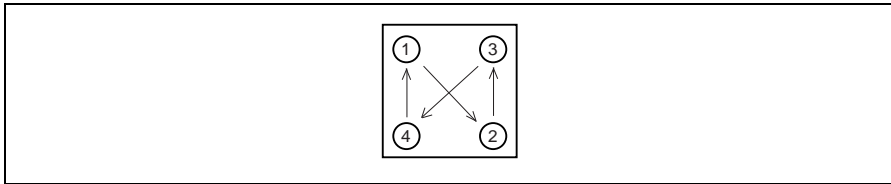

Figure 2.3 Example of Connecting User System Interface Cable Head to User System

- Ensure that all power is off to the emulator and the user system.
- Insert the cable head into the socket on the user system.

Note: Depending upon the package, it may be possible to orientate this cable head in any position on the socket, so care should be taken to correctly identify pin 1 on the emulator and socket when installing.

- Screw the cable head to the socket with the screws provided. Progressively tighten the screws in the sequence shown in figure 2.4 until all are 'finger tight'.

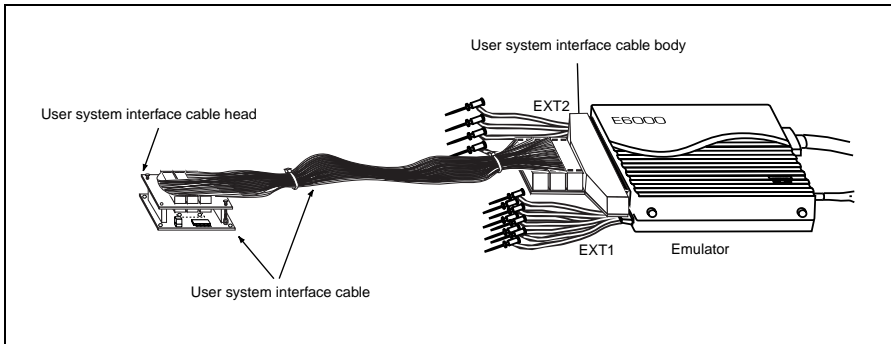

**Figure 2.4 Sequence of Screw Tightening**

Note: Be careful not to over-tighten the screws as this may result in contact failure on the user system or damage the cable head. Where provided, use the 'solder lugs' on the QFP socket to provide extra strength to the emulator/user system connection.

### 2.3.2 Plugging the User System Interface Cable Body into the Emulator

Plug the cable body into the emulator, taking care to insert it straight, and push it firmly into place.



**Figure 2.5 Plugging User System Interface Cable Body to Emulator**

### 2.3.3 Plugging the User System Interface Cable Body into the Cable Head

Plug the cable body into the cable head on the user system.

## 2.4 Power Supply

### 2.4.1 AC Adapter

The AC adapter supplied with the emulator must be used at all times.

### 2.4.2 Polarity

Figure 2.6 shows the polarity of the power-supply plug.

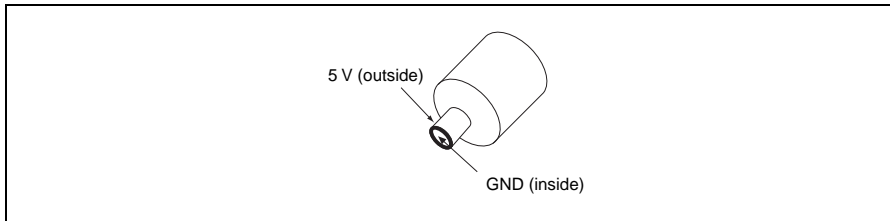

**Figure 2.6 Polarity of Power Supply Plug**

### 2.4.3 Power Supply Monitor Circuit

The emulator incorporates a power supply monitor circuit which only lights the red LED when a voltage higher than 4.75 V is supplied. If this LED is not illuminated, you should check the emulator voltage level. An input voltage less than 4.75 V could indicate that enough current cannot be supplied to the emulator.

Note: Use the provided AC adapter for the emulator.

## 2.5 SIMM Memory Module

E6000 emulator's optional SIMM memory modules are available which provide emulation memory for user code without needing a user system. The optional SIMM memory modules are available in different memory size, but all are partitioned into four equal banks. These banks can be relocated on page boundaries anywhere in the user area. Note that, however, some products do not support the SIMM memory module.

### 2.5.1 Optional SIMM Memory Module Configuration

The configuration of the optional SIMM memory module is controlled by the mapping RAM. Opening the [Memory] sheet of the [System Status] window allows you to check which optional SIMM memory module, if any, is installed and also allows the four banks to be relocated to the required addresses from the [Memory Mapping] dialog box.

## 2.6 Hardware Interface

All signals are directly connected to the MCU in the emulator with no buffering with the exception of those listed in section 7, Hardware Specifications Specific to This Product.

### 2.6.1 Signal Protection on the emulator

All signals are over/under voltage protected by use of diode arrays. The only exceptions being the  $AV_{cc}$  and  $V_{ref}$ .

All ports have pull-up resistors except for analog port.

All  $V_{cc}$  pins on the cable head assembly are connected together (with the exception of the  $AV_{cc}$  pin), and are then monitored by the emulator to detect powered user system presence.

### 2.6.2 User System Interface Circuits

The interface circuit between the MCU in the emulator and the user system has a signal delay of about 8 ns due to the user system interface cable and it includes pull-up resistors. Therefore, high-impedance signals will be pulled up to the high level. When connecting the emulator to a user system, adjust the user system to compensate for propagation delays.

The following diagrams show the equivalent circuit examples of the interface signals. The interface circuits depend on the MCU type. For details, refer to section 7, Hardware Specifications Specific to This Product.

### 2.6.3 Clock Oscillator

The oscillator circuit has been implemented on the user system interface cable head. For details on the oscillator circuit, refer to the user's manual for each user system interface cable.

### 2.6.4 External Probe 1 (EXT1)/Trigger Output

An 8-pin connector, marked EXT1 (on the right under the user system interface cable connector), on the emulator case accommodates four external probe inputs and two trigger outputs. The pin assignment of this connector is shown in figure 2.7.

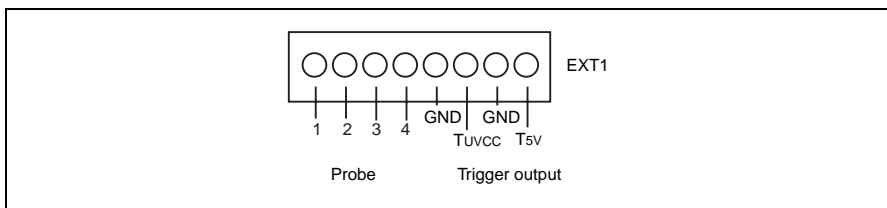
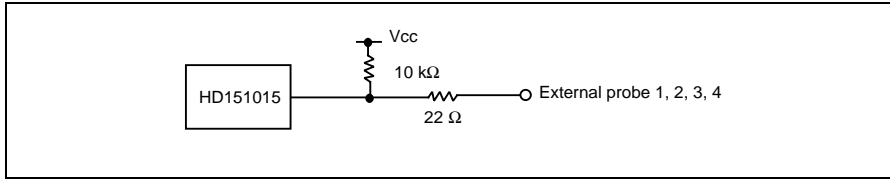

Figure 2.7 External Probe Connector 1

The interface circuit for the external probe 1 is shown in figure 2.8.

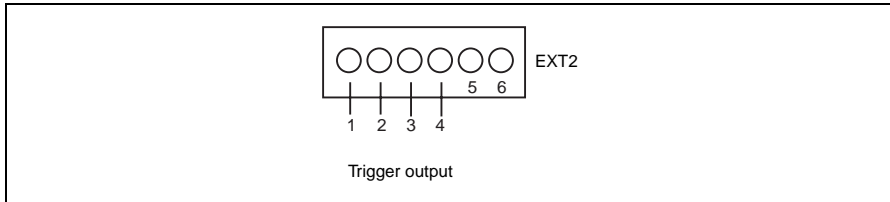

**Figure 2.8 Interface Circuit for External Probe 1**

The trigger output is controlled by event channel 8 and is an active low signal. The trigger output is available as either T5V (within the range from 2.5 V to 5 V; does not depend on the user  $V_{cc}$  level) or  $TUV_{cc}$  (the user  $V_{cc}$  level).

### 2.6.5 External Probe 2 (EXT2)/Trigger Output

A 6-pin connector, marked EXT2 (on the left under the user system interface cable connector), on the emulator case accommodates four trigger outputs. The pin assignment of this connector is shown in figure 2.9.



**Figure 2.9 External Probe 2 Connector**

The trigger output is an active high signal which is output during the read or write cycles when a trace condition (1 to 4) of the bus monitor function is satisfied. The trigger output is available as user  $V_{cc}$  level. Note that, however, some products do not support the external probe 2 (EXT2).



## 2.6.6 Voltage Follower Circuit

### CAUTION

1. Do not connect the user system interface cable to the emulator without user system connection.
2. Turn on the user system before starting up the emulator.

A voltage follower circuit is implemented on the emulator which allows the user system voltage level from the user system to be monitored. This monitored voltage level is automatically supplied to the logic on the emulator and is derived from the emulator power supply unit. This means that no power is taken from the user system board.

If no user system interface cable is connected to the emulator, the emulator will operate at a specified voltage and all clock frequencies will be available to the user. If the user system interface cable is attached, the emulator will match the voltage supplied to the user target in all cases; i.e. even when the user  $V_{cc}$  is below the operating voltage for the MCU. You must be careful not to select an invalid clock frequency. When the emulator is connected to the user system and the user system is turned off, the voltage follower circuit output voltage level is 0 V. In this case, the emulator will not operate correctly.

You can set a user  $V_{cc}$  threshold in the range  $V_{cc} \text{ max.} - 0 \text{ V}$  by using the emulator configuration dialog box. If the user  $V_{cc}$  drops below this threshold, [User System Voltage] in the [Extended Monitor] window will display Down, otherwise OK is displayed.

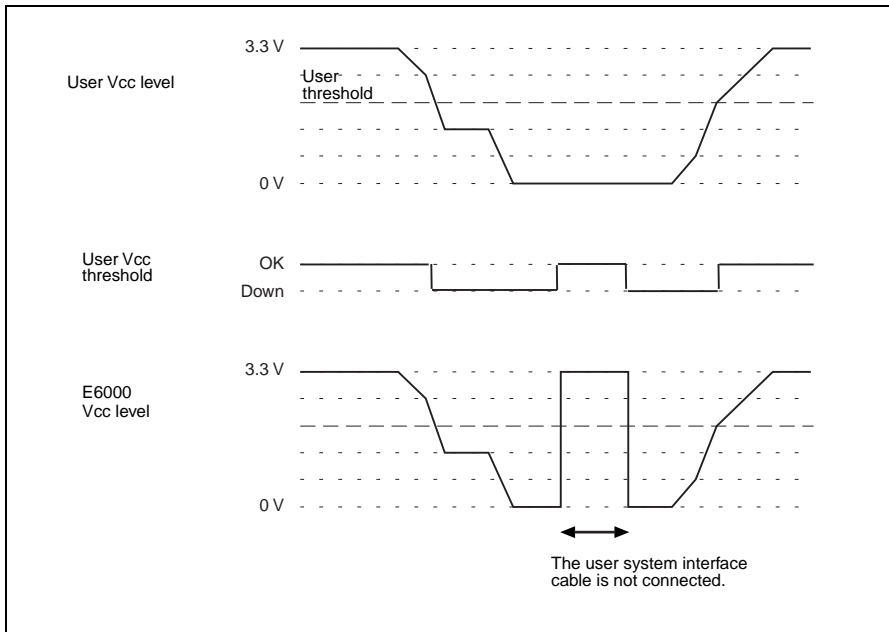

Figure 2.10 Voltage Level Monitoring (Example for  $V_{cc} = 3.3 \text{ V}$ )

## 2.7 System Check

When the software is executed, use the procedure below to check that the emulator is connected correctly. Here, use the workspace for a tutorial provided on the product.

Refer to section 2.9, Other Methods for Activating the Emulator, for the other activating method to create a new project or use a workspace for the High-performance Embedded Workshop of the old version.

1. Connect the emulator to the host computer.
2. Connect the user system interface cable to the connector of the emulator.
3. Turn on the emulator.
4. Activate the High-performance Embedded Workshop from the [Programs] in the [Start] menu (figure 2.11).

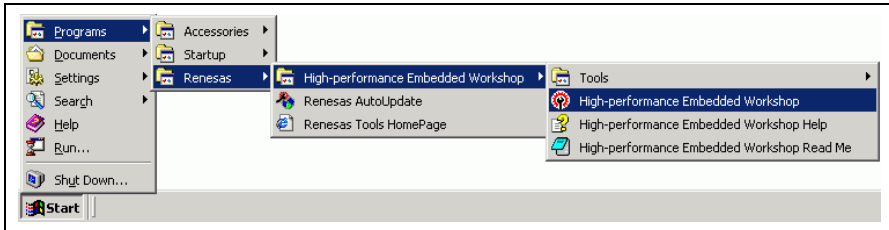
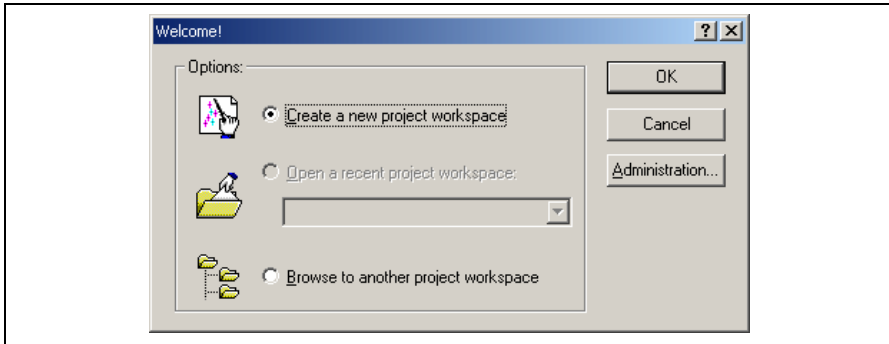

Figure 2.11 [Start] Menu

Note: If 'LAN Driver' is not selected at installation, [Tools] is not displayed.

5. The [Welcome!] dialog box is displayed.



**Figure 2.12 [Welcome!] Dialog Box**

To use a workspace for the tutorial, select the [Browse to another project workspace] radio button and click the [OK] button.

When the [Open Workspace] dialog box is opened, specify the following directory:  
OS installation drive \Workspace\Tutorial\E6000\xxxx

Note: The directory mentioned above cannot be specified depending on the version of the software. In such cases, specify the following directory instead.

High-performance Embedded Workshop installation destination directory  
\Tools\Renesas\DebugComp\Platform\E6000\xxxx\Tutorial

After the directory has been specified, select the following file and click the [Open] button.

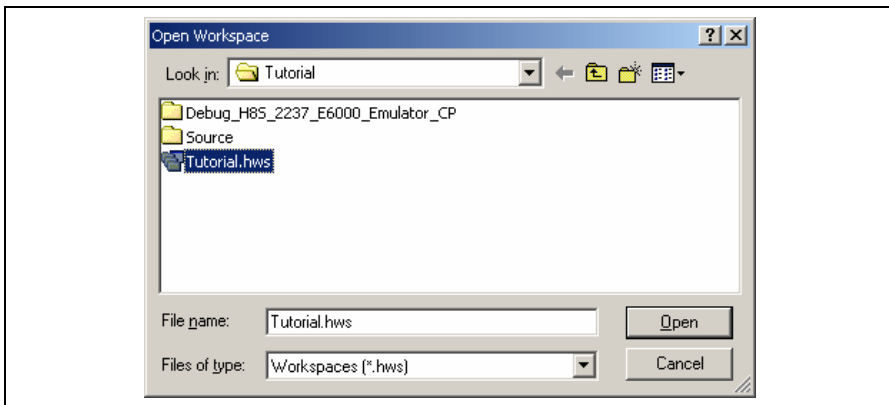

**Figure 2.13 [Open Workspace] Dialog Box**

When no compiler package or that of a different version is installed, the following message box will be displayed.

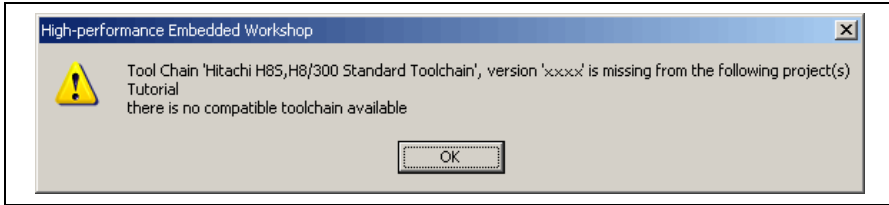

**Figure 2.14 Message Box**

6. The [E6000 Driver Details] dialog box is displayed. This dialog box is only displayed at the first initiation. When only one of interface drivers is selected, this dialog box is not displayed.

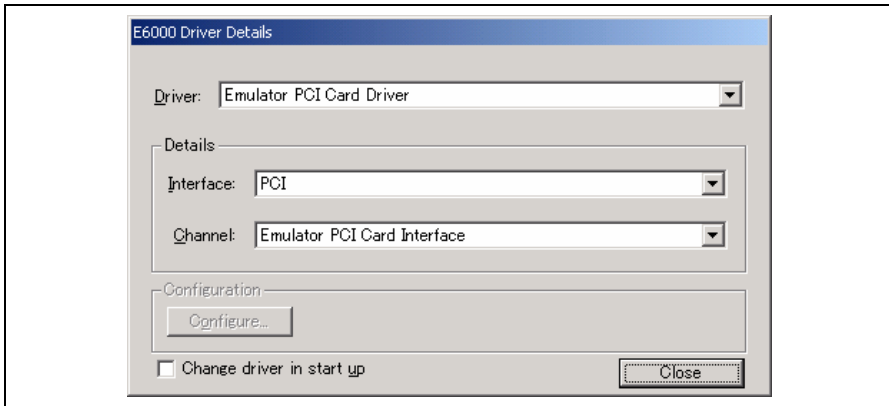

**Figure 2.15 [E6000 Driver Details] Dialog Box**

- In the [Driver] combo box, select the driver to connect the emulator.
- [Interface] displays the name of the interface to be connected.
- Click the [Close] button.

7. Set up the emulator. During this process, the following dialog box is displayed.

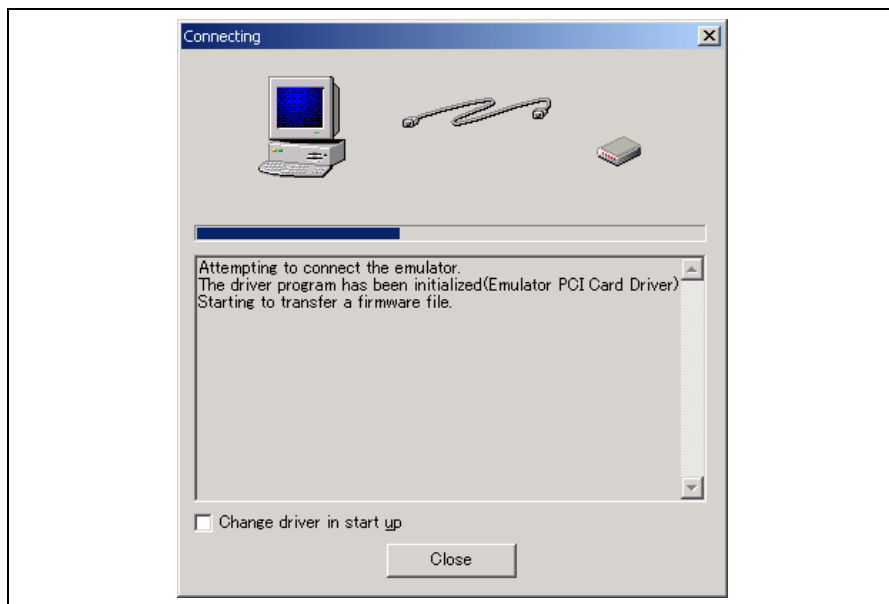

**Figure 2.16 [Connecting] Dialog Box**

- When "Connected" is displayed in the [Output] window of the High-performance Embedded Workshop, the emulator initiation is completed.

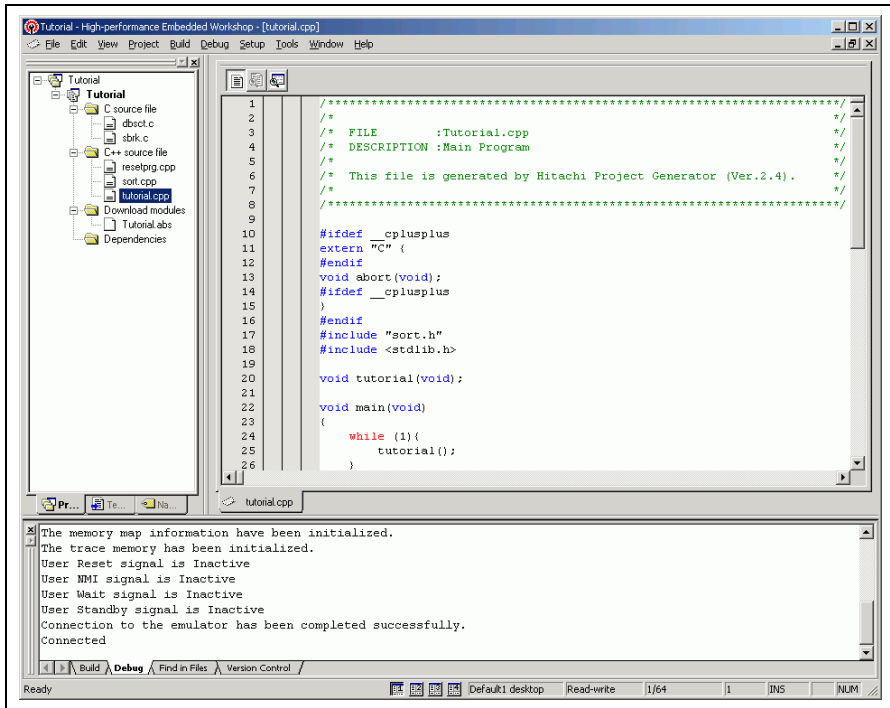

Figure 2.17 High-performance Embedded Workshop Window

## 2.8 Communication Problems

The following message box will be displayed when the emulator power is turned off or the PC interface cable is not correctly connected.

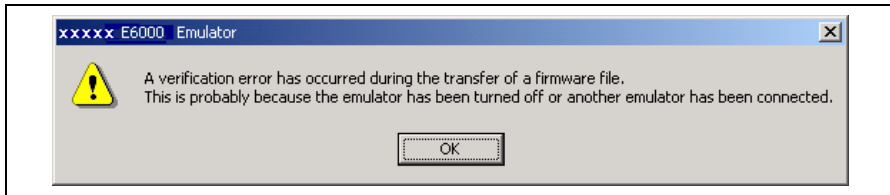

Figure 2.18 Error Message

For information on other errors, refer to the Setup Guide for the E6000 Emulator.

## 2.9 Other Methods for Activating the Emulator

Refer to section 4, Preparation before Use.

## 2.10 Uninstalling the Emulator's Software

For details on uninstallation, refer to the Setup Guide for the E6000 Emulator.





## Section 3 E6000 Emulator Functions

### 3.1 Debugging Features

#### 3.1.1 Breakpoints

The emulator provides a comprehensive range of alternative types of breakpoints, to give you the maximum flexibility in debugging applications and user system.

**Hardware Break Conditions:** Up to 12 break conditions can be defined using the event and range channels in the complex event system (CES). For more information about the hardware break conditions, see section 3.2, Complex Event System (CES).

**Software Breakpoints:** Up to 256 software breakpoints can be defined. These software breakpoints are set by replacing the user instruction by a BREAK instruction. In target ROM, only one breakpoint (on-chip break) can be set.

#### 3.1.2 Trace

The emulator incorporates a powerful realtime trace facility which allows you to examine MCU activity in detail. The realtime trace buffer holds up to 32768 bus cycles, and it is continuously updated during execution. The buffer is configured as a rolling buffer, which can be stopped during execution and read back by the host computer without halting emulation.

The data stored in the trace buffer is displayed in both source program and assembly languages for ease of debugging. However, if trace filtering is used, only assembly language can be displayed.

The buffer can be set up to store all bus cycles or just selected cycles. This is called trace acquisition and uses the complex event system (CES) to select the parts of the program you are interested in.

It is also possible to store all bus cycles and then just look at selected cycles. This is called trace filtering.

#### 3.1.3 Execution Time Measurements

The emulator allows you to measure the total execution time, or to measure the time of execution between specified events in the complex event system. You can set the resolution of the timer to any of the following values:

20 ns, 125 ns, 250 ns, 500 ns, 1  $\mu$ s, 2  $\mu$ s, 4  $\mu$ s, 8  $\mu$ s, or 16  $\mu$ s.

At 20 ns the maximum time that can be measured is about six hours, and at 16 $\mu$ s the maximum time is about 200 days.

#### 3.1.4 Performance Analysis

The emulator provides functions for measuring the performance of a program. The performance of the specified program range can be displayed either as a histogram or in percentage form. A timer resolution of 20 ns, 40 ns, or 160 ns can be selected. In addition, the execution count of the specified program range can be measured (1 to 65535).

### 3.1.5 Bus Monitoring

The emulator incorporates a bus monitoring function that monitors and displays the contents of the accessed area in High-performance Embedded Workshop windows without stopping the program execution. Up to eight blocks of 256 bytes can be monitored. In addition, the emulator can output trigger signals from external probe 2 (EXT2) when specified addresses (four points max.) are accessed. Note that, however, some products do not support the bus monitoring function.

## 3.2 Complex Event System (CES)

In most practical debugging applications, the program or hardware errors that you are trying to debug occur under a certain restricted set of circumstances. For example, a hardware error may only occur after a specific area of memory has been accessed. Tracking down such problems using simple software breakpoints can be very time-consuming.

The emulator provides a very sophisticated system for giving a precise description of the conditions you want to examine, called the complex event system. This allows you to define events which depend on the state of a specified combination of the MCU signals.

The complex event system provides a unified way of controlling the trace, break, and timing functions of the emulator.

### 3.2.1 Event Channels

The event channels allow you to detect when a specified event has occurred. The event can be defined as a combination of one or more of the followings:

- Address or address range
- Address outside range
- Read or Write or either
- Data, with an optional mask
- MCU access type (e.g., DMAC and instruction prefetch)
- MCU access area (e.g., on-chip ROM and on-chip RAM)
- A signal state on one or more of the four external probes
- A certain number of times that the event must be triggered
- Delay cycles after an event

Up to eight events can be combined into a sequence, in which each event is either activated or deactivated by the occurrence of the previous event in the sequence. For example, you can cause a break if an I/O register is written to after a specified area of RAM has been accessed.

### 3.2.2 Range Channels

The range channels can be set up to be triggered on a combination of one or more of the following:

- Address or address range (inside the range)
- Read or Write or either
- Data, with an optional mask
- MCU access type (e.g., DMAC and instruction prefetch)
- MCU access area (e.g., on-chip ROM and on-chip RAM)
- A signal state on one or more of the four external probes
- Delay cycles after an event

The complex event system can be used to control the following functions of the emulator:

### 3.2.3 Breaks

Use breaks to interrupt program execution when a specified event, or sequence of events, is activated. For example, you can set up a break to halt execution when the program reads from one address, and then writes to another address. The break can also optionally be delayed by up to 65535 bus cycles.

### 3.2.4 Timing

You can set up two events and then measure the execution time of the program between the activation of the first event and second event.

### 3.3 Hardware Features

#### 3.3.1 Memory

The emulator provides standard emulation memory as the substitute for on-chip ROM memory and on-chip RAM memory. When a device type or device mode without an on-chip ROM or on-chip RAM is selected, the standard emulation memory is disabled. When debugging with only the emulator and the user program and data are stored in an external address space, an optional SIMM memory module must be used. The optional SIMM memory modules can be separately purchased.

The emulation memory can be mapped in 64-byte units to any number of separate memory blocks in the MCU address space. Each memory block can be specified using the memory mapping function as user (Target) or emulator (SIMM memory module) and, in each case, the access can be specified as read-write, read-only, or guarded.

The definition of each type of memory is as follows:

**Table 3.1 Memory Types**

| <b>Memory Type</b> | <b>Description</b>                        |
|--------------------|---|
| On-chip            | Uses the MCU on-chip memory.              |
| User               | Accesses the user system memory.          |
| Emulator           | Accesses the emulator SIMM memory module. |

The contents of a specified block of memory can be displayed using the memory function. The contents of memory can be modified at any time, even during program execution and the results are immediately reflected in all other appropriate windows.

Note that modifying memory contents during program execution has the following time requirements:

1. MCU on-chip ROM or RAM, or emulator SIMM memory module  
The emulator modifies the memory contents by temporarily switching the memory bus to the emulator side without stopping the user program execution. Therefore, the emulator uses the memory bus for up to 80  $\mu$ s in reading of 256 bytes (25 MHz, on-chip ROM).
2. MCU on-chip I/O, DTCRAM, or user system memory  
The emulator stops the user program execution, then modifies the memory contents. Therefore, the user program stops for a maximum of 2 ms in reading 256 bytes (25 MHz, emulation memory).

### 3.3.2 Clocks

The clock can be specified as emulator internal clock or target clock. The frequencies that can be specified as the emulator internal clock depend on the MCU. For details, refer to section 8, Software Specifications Specific to This Product.

### 3.3.3 Probes

External probes 1 and 2 (EXT1 and EXT2) can be connected to the emulator, to make use of signals on the user system for break or trace. The signal for external probe 1 can be set as the condition for the event detection system depending on the low or high level. Since the signal for external probe 2 outputs high level when the trigger setting (1 to 4) condition is matched in the bus monitor function, the signal can be used for the trigger condition for such as an oscilloscope.

## 3.4 Stack Trace Function

The emulator uses the stack's information to display the name of the calling function for a function at which the program counter is currently pointing. This function can be used only when the load module that has the Dwarf2-type debugging information is loaded. For the usage of this function, refer to section 6.17, Stack Trace Function.

## 3.5 Online Help

An online help explains the usage of each function or the command syntax that can be entered from the command line window.

Select [Emulator Help] from the [Help] menu to view the emulator help.



## Section 4 Preparation before Use

### 4.1 Method for Activating High-performance Embedded Workshop

To activate the High-performance Embedded Workshop, follow the procedure listed below.

1. Connect the emulator to the host computer.
2. Connect the user system interface cable to the connector of the emulator if you use the user system interface cable. This is not necessary when you do not use the user system interface cable.
3. Turn on the emulator. Be sure to turn on the user system before supplying power to the emulator if you use the user system.
4. Activate the High-performance Embedded Workshop from [Programs] in the [Start] menu.
5. The [Welcome!] dialog box is displayed.

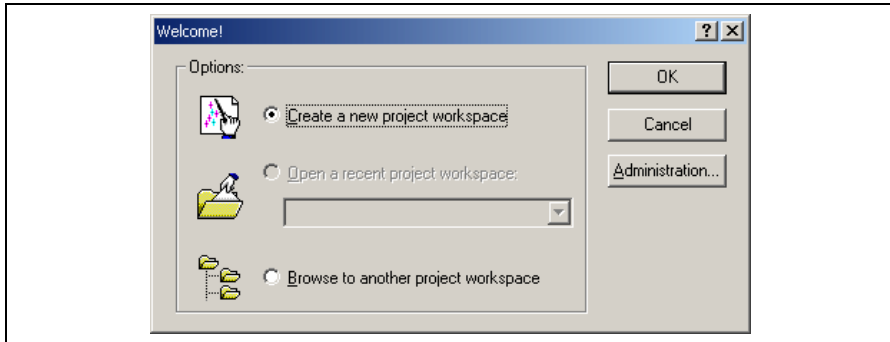

**Figure 4.1 [Welcome!] Dialog Box**

[Create a new project workspace] radio button: Creates a new workspace.

[Open a recent project workspace] radio button: Uses an existing workspace and displays the history of the opened workspace.

[Browse to another project workspace] radio button: Uses an existing workspace; this radio button is used when the history of the opened workspace does not remain.

In this section, we describe the following three ways to start up the High-performance Embedded Workshop:

- [Create a new project workspace] - a toolchain is not in use
- [Create a new project workspace] - a toolchain is in use
- [Browse to another project workspace]

The method to create a new workspace depends on whether a toolchain is or is not in use. Note that this emulator product does not include a toolchain. Use of a toolchain is available in an environment where the H8S, H8/300 series C/C++ compiler package has been installed. For details on this, refer to the manual attached to the H8S, H8/300 series C/C++ compiler package.

#### 4.1.1 Creating a New Workspace (Toolchain Not Used)

1. In the [Welcome!] dialog box that is displayed when the High-performance Embedded Workshop is activated, select [Create a new project workspace] radio button and click the [OK] button.

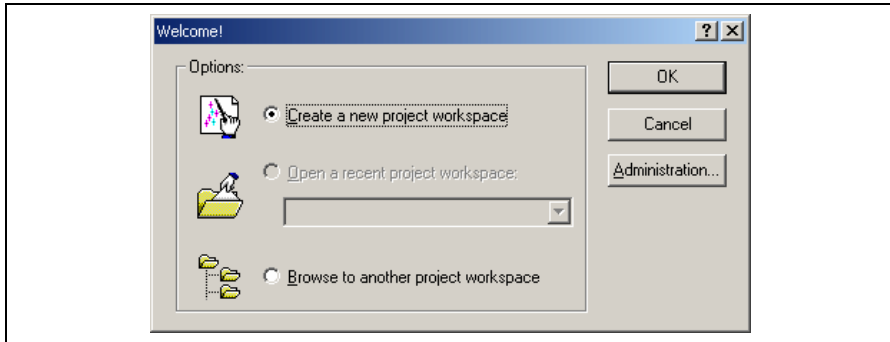
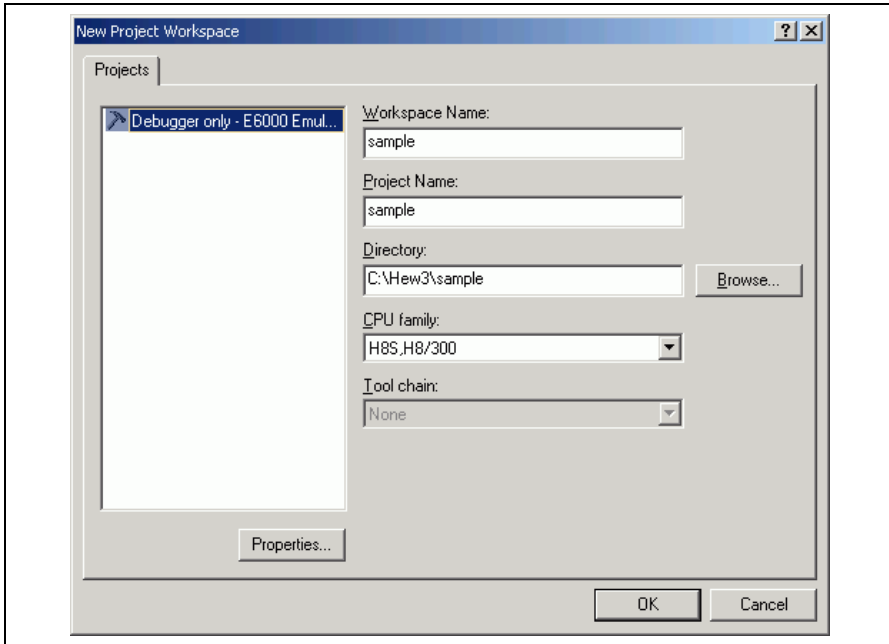

Figure 4.2 [Welcome!] Dialog Box



2. Creation of a new workspace is started. The following dialog box is displayed.



**Figure 4.3 [New Project Workspace] Dialog Box**

[Workspace Name] edit box: Enter the new workspace name.

[Project Name] edit box: Enter the project name. When the project name is the same as the workspace name, it needs not be entered.

[Directory] edit box: Enter the directory name in which the workspace will be created. Click the [Browse...] button to select a directory.

[CPU family] combo box: Select the target CPU family.

Other list boxes are used for setting the toolchain; the fixed information is displayed when the toolchain has not been installed.

Click the [OK] button.

3. Select the target platform of the session file. The following dialog box is displayed.

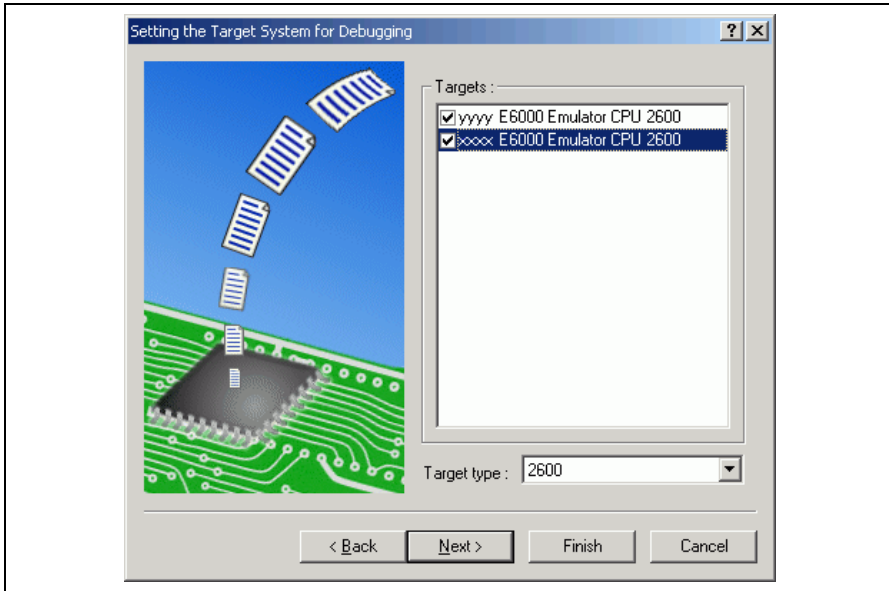

**Figure 4.4 [New Project – Step 7] Dialog Box**

The target platform for the session file used when the High-performance Embedded Workshop is activated must be selected here. Check the box against the target platform and then click the [Next] button. For details on the session file, refer to the High-performance Embedded Workshop user's manual.

4. Set the configuration file name.

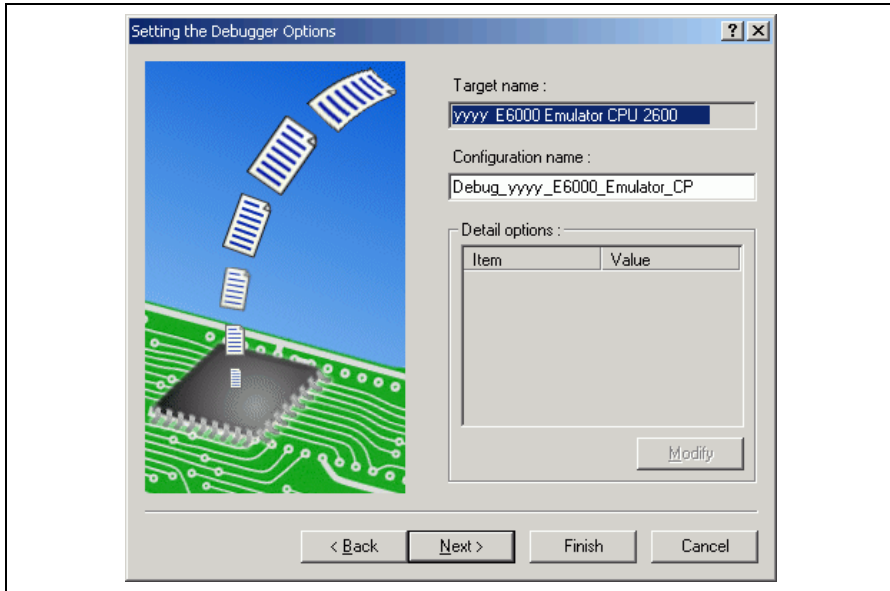

**Figure 4.5 [New Project – Step 8] Dialog Box**

If multiple target platforms were selected in the [New Project – Step 7] dialog box shown in figure 4.5, set the name of a configuration file for each of them, each time pressing the [Next] button to proceed to the next target.

Setting of the configuration file name is the end of the emulator settings.

Click the [Finish] button to display the [Summary] dialog box. Pressing the [OK] button activates the High-performance Embedded Workshop.

5. After the High-performance Embedded Workshop has been activated, the emulator is automatically connected. The message “Connected” is displayed on the [Debug] tab in the [Output] window to indicate the completion of connection.

#### 4.1.2 Creating a New Workspace (Toolchain Used)

1. In the [Welcome!] dialog box that is displayed when the High-performance Embedded Workshop is activated, select [Create a new project workspace] radio button and click the [OK] button.

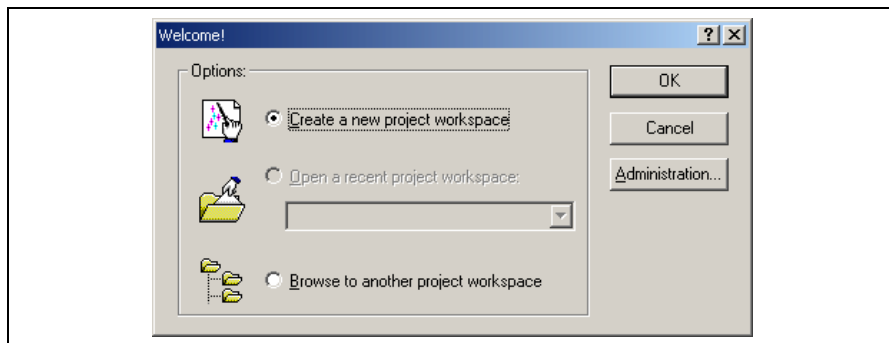
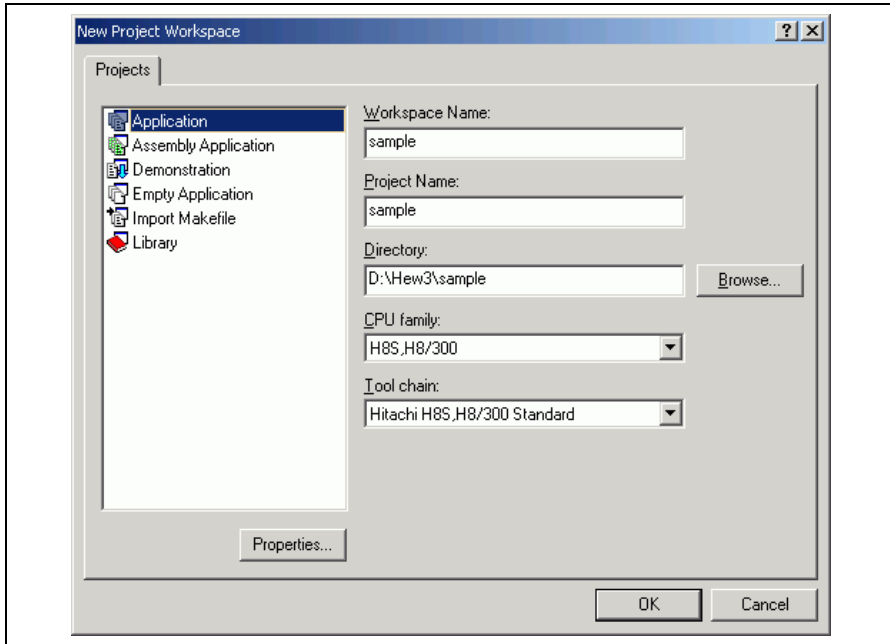

Figure 4.6 [Welcome!] Dialog Box

2. Creation of a new workspace is started. The following dialog box is displayed.



**Figure 4.7 [New Project Workspace] Dialog Box**

[Workspace Name] edit box: Enter the new workspace name. Here, enter 'test'.

[Project Name] edit box: Enter the project name. When the project name is the same as the workspace name, it needs not be entered.

[Directory] edit box: Enter the directory name in which the workspace will be created. Click the [Browse...] button to select a directory.

[CPU family] combo box: Select the target CPU family.

[Tool chain] combo box: Select the target toolchain name when using the toolchain. Otherwise, select [None].

[Project type] list box: Select the project type to be used.

Notes: 1. When [Demonstration] is selected in the emulator, note the followings:

The [Demonstration] is a program for the simulator attached to the H8S, H8/300 compiler package.  
To use the generated source file, delete the Printf statement in the source file.

3. Make the required setting for the toolchain. When the setting has been completed, the following dialog box is displayed.

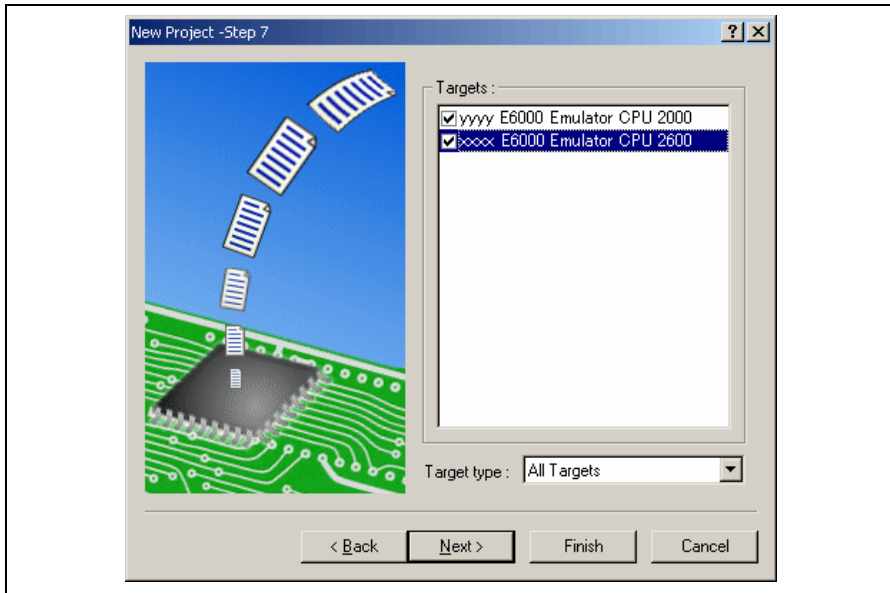

**Figure 4.8 [New Project – Step 7] Dialog Box**

The target platform for the session file used when the High-performance Embedded Workshop is activated must be selected here. Check the box against the target platform and then click the [Next] button. For details on the session file, refer to the High-performance Embedded Workshop user's manual.

4. Set the configuration file name.

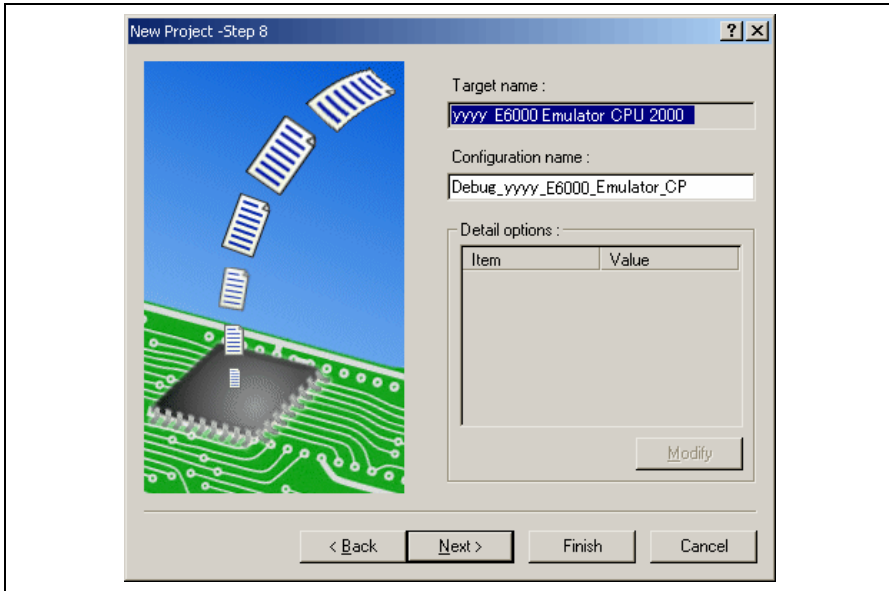

**Figure 4.9 [New Project – Step 8] Dialog Box**

If multiple target platforms were selected in the [New Project – Step 7] dialog box shown in figure 4.9, set the name of a configuration file for each of them, each time pressing the [Next] button to proceed to the next target.

Setting of the configuration file name is the end of the emulator settings.

Complete the creation of a new workspace according to the instructions on the screen. This activates the High-performance Embedded Workshop.

5. After the High-performance Embedded Workshop has been activated, connect the emulator. However, it is not necessary to connect the emulator immediately after the High-performance Embedded Workshop has been activated.

Select either of the following two ways to connect the emulator: connecting the emulator after the setting at emulator activation or without the setting at emulator activation. For details on the connection of the emulator, refer to section 4.2, Connecting the Emulator.

### 4.1.3 Selecting an Existing Workspace

1. In the [Welcome!] dialog box that is displayed when the High-performance Embedded Workshop is activated, select [Browse to another project workspace] radio button and click the [OK] button.

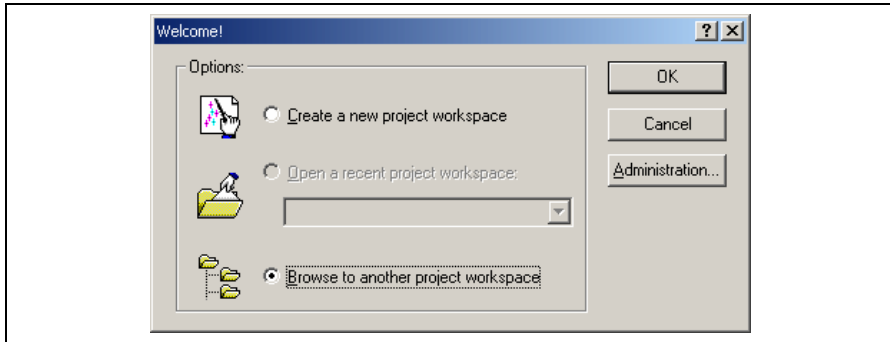

**Figure 4.10 [Welcome!] Dialog Box**

2. The [Open Workspace] dialog box is displayed. Select a directory in which you have created a workspace. After that, select the workspace file (.hws) and press the [Open] button.

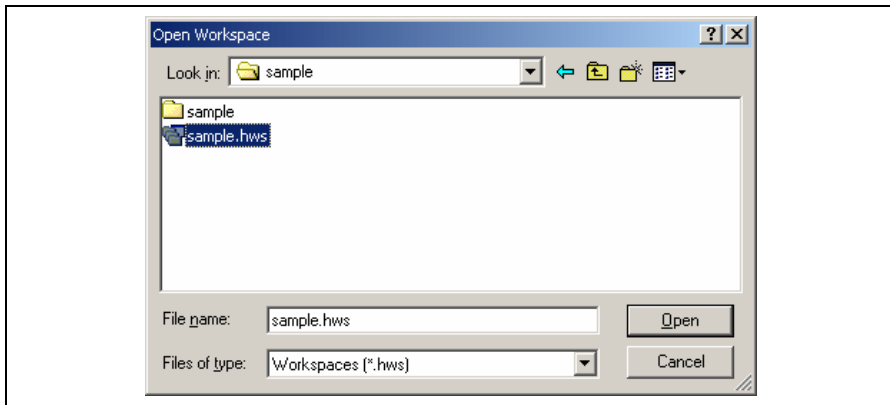

**Figure 4.11 [Open Workspace] Dialog Box**

3. This activates the High-performance Embedded Workshop and recovers the state of the selected workspace at the time it was saved.  
When the saved state information of the selected workspace includes connection to the emulator, the emulator will automatically be connected. To connect the emulator when the saved state information does not include connection to the emulator, refer to section 4.2, Connecting the Emulator.



## 4.2 Connecting the Emulator

Select either of the following two ways to connect the emulator:

(a) Connecting the emulator after the setting at emulator activation

Select [Debug -> Debug Settings...] to open the [Debug Settings] dialog box. It is possible to register the download module or the command chain that is automatically executed at activation.

When the dialog box is closed after setting the [Debug Settings] dialog box, the emulator will automatically be connected.

(b) Connecting the emulator without the setting at emulator activation

Connect the emulator by simply switching the session file to one in which the setting for the emulator use has been registered.

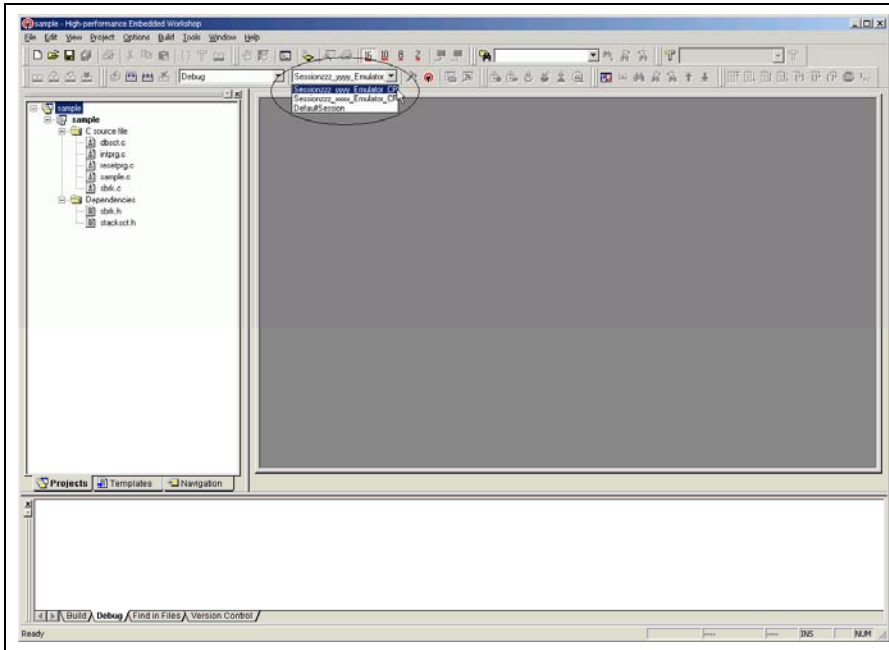



Figure 4.12 Selecting the Session File

In the list box that is circled in figure 4.12, select the session name including the character string that has been set in the [Target name] text box in figure 4.9, [New Project – Step 8] dialog box. The setting for using the emulator has been registered in this session file.

After the session name is selected, the emulator will automatically be connected. For details on the session file, refer to the High-performance Embedded Workshop user's manual.

### 4.3 Reconnecting the Emulator

When the emulator is disconnected, use the following way for reconnection:

Select [Debug -> Connect] or click the [Connect] toolbar button (). The emulator is connected.

Note: Before reconnecting the emulator, a load module must be registered to the High-performance Embedded Workshop.

### 4.4 Ending the Emulator

When using the toolchain, the emulator can be exited by using the following two methods:

- Canceling the connection of the emulator being activated
- Exiting the High-performance Embedded Workshop

(1) Canceling the connection of the emulator being activated

Select [Debug -> Disconnect] or click the [Disconnect] toolbar button ().

(2) Exiting the High-performance Embedded Workshop

Select [File -> Exit].

A message box is displayed. If necessary, click the [Yes] button to save a session. After saving a session, the High-performance Embedded Workshop exits. If not necessary, click the [No] button to exit the High-performance Embedded Workshop.

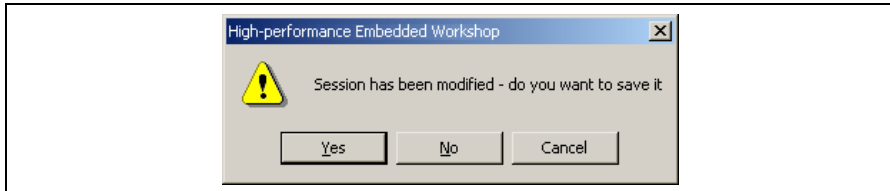

Figure 4.13 [Session has been modified] Message Box

## Section 5 Debugging

This section describes the debugging operations and their related windows and dialog boxes.

Refer to the High-performance Embedded Workshop user's manual about High-performance Embedded Workshop common functions as below.

- Preparations for Debugging
- Viewing a Program
- Operating Memory
- Displaying Memory Contents as Waveforms
- Displaying Memory Contents as an Image
- Modifying the variables
- Viewing the I/O Memory
- Looking at Registers
- Executing Your Program
- Viewing the Function Call History
- Debugging with the Command Line Interface
- Elf/Dwarf2 Support
- Looking at Labels

## 5.1 Setting the Environment for Emulation

### 5.1.1 Opening the [Configuration Properties] Dialog Box

Selecting [Setup -> Emulator -> System...] or clicking the [Emulator System] toolbar button () opens the Configuration Properties] dialog box.

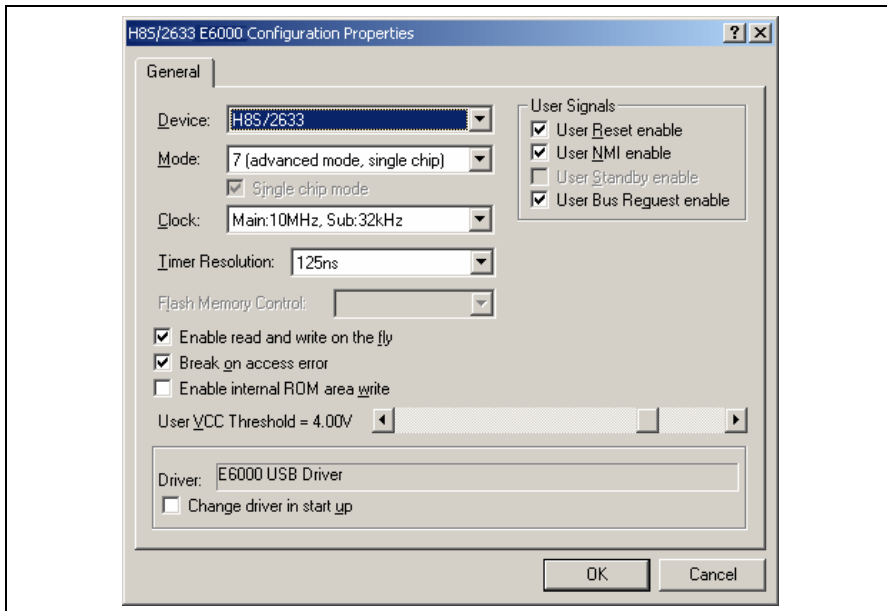

Figure 5.1 [Configuration Properties] Dialog Box ([General] Page)

This dialog allows the user to set conditions for the target MCU before downloading a program to the emulator.

## [General] page

|                                    |  |
|------------------------------------|--|
| [Device]                           | Selects the MCU to be emulated. To use an MCU not included in the list, select CUSTOM to specify the functions required for this MCU. See the hardware manual for details.   |
| [Mode]                             | Selects the MCU's operating mode.  |
| [Clock]                            | Selects the speed of the MCU's clock and sub-clock.  |
| [Timer Resolution]                 | Selects the resolution of the timer for use in execution time measurement. The value 20 ns, 125 ns, 250 ns, 500 ns, 1 us, 2 us, 4 us, 8 us, or 16 us can be selected.<br><br>The timer for execution time measurement has a 40-bit counter.<br><br>At 20 ns the maximum time that can be measured is about six hours, and at 16 $\mu$ s the maximum time is about 200 days.<br><br>When the counter overflows, the maximum time possible for measurement will be displayed with prompt ">" that indicates that the counter has overflowed. |
| [Enable read and write on the fly] | When this box is checked, it is possible to access the target system memory while the user program is running. Do not check this check box if you require realtime emulation.  |
| [Break on access error]            | When this box is checked, a break (the user program stops) occurs if your program accesses a guarded memory area or writes to a write-protected area.  |
| [Enable internal ROM area write]   | When this box is checked, writing to the internal ROM area is enabled. For the result of writing, see the [Extended Monitor] window.   |
| [User VCC Threshold]               | Sets the voltage level for the user system.  |
| [User Signals]                     | When this box is checked, the reset, NMI, standby, and bus request signals from the user system are enabled.   |
| [Driver]                           | Displays the E6000 driver that is currently installed.   |
| [Change driver in start up]        | When this box is checked, selection of a driver will be available next time the emulator is connected.   |

Note: The items that can be set in this dialog box vary according to the emulator in use. For details, refer to section 8, Software Specifications Specific to This Product, or the online help.

### 5.1.2 Selecting an MCU Not Included in the List

Selecting [Custom] in [Device] of the [Configuration Properties] dialog box adds the [Custom Device] page to the dialog box.

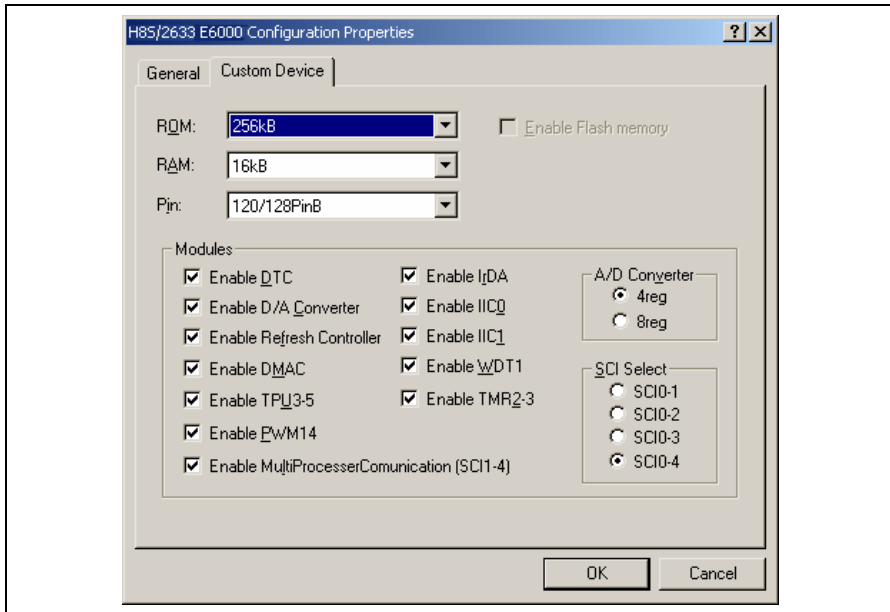

**Figure 5.2 [Configuration Properties] Dialog Box ([Custom Device] Page)**

Use this page to specify functions for an MCU not included in the list of MCUs. The items are adopted by the device last selected.

#### [Custom Device] page

|           |   |
|-----------|---|
| [ROM]     | Specify the internal ROM area size.             |
| [RAM]     | Specify the internal RAM area size.             |
| [Pin]     | Specify the product package.                    |
| [Modules] | Check this box to validate on-chip peripherals. |

Note: The items that can be set in this dialog box vary according to the emulator in use. Some emulators may not support the [Custom Device] function. For details, refer to section 8, Software Specifications Specific to This Product, or the online help.

### 5.1.3 Selecting the Interface to be Connected

Checking [Change driver in start up] on the [Configuration Properties] dialog box allows a selection of the driver next time the emulator is connected.

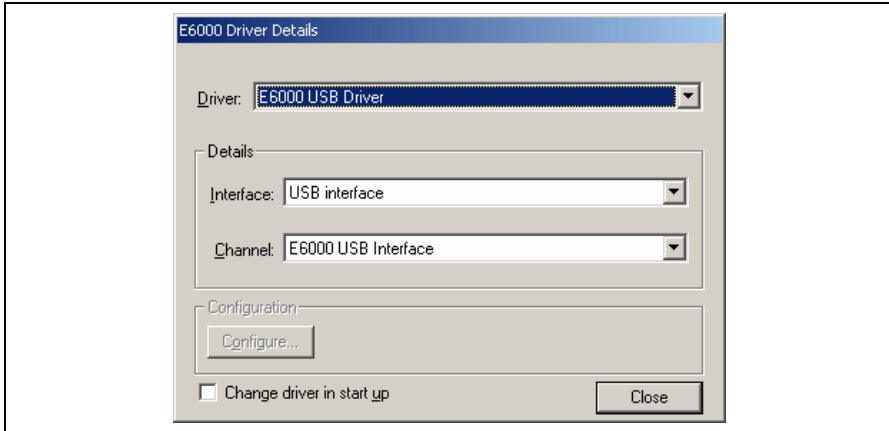

**Figure 5.3 [Driver Details] Dialog Box**

[Driver]: Selects the driver that connects the High-performance Embedded Workshop and the emulator.

[Details]: Sets the details of the driver being connected.

[Interface]: The name of the interface to be connected. This should not be changed in this emulator.

[Channel]: Channel for the selected interface. This should not be changed in this emulator.

[Configuration]: Driver setting.

[Configure...]: A dialog box for setting will be displayed when the driver supports the configuration dialog. Note that this item is not available with this emulator.

[Change driver in start up]:  
Checking this box selects the driver when the emulator is connected the next time.

### 5.1.4 Opening the [Memory Mapping] Dialog Box

Selecting [Setup -> Emulator -> Memory Resource...] or clicking the [Emulator Memory Resource] toolbar button (  ) opens the [Memory Mapping] dialog box.

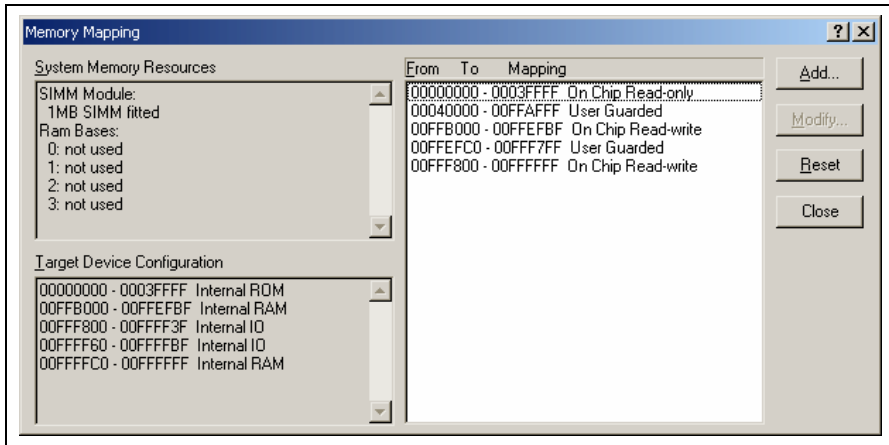

**Figure 5.4 [Memory Mapping] Dialog Box**

This dialog box displays the current memory map. The E6000 H8S or H8/300 series supports four blocks of user memory. These can be 256 kbyte or 1 Mbyte each, depending on the SIMM fitted. Each block can be placed in the address space on a 256-kbyte or 1-Mbyte boundary.

The memory mapping has a granularity of H'40 (D'64) byte. Each 64-byte block can be set to the internal (emulation) or external memory and can be guarded (access-prohibited), write-protected or read-write.

The H8/300 series E6000 generally incorporates an emulation memory.

In the memory map, the memory can be set as an internal (emulation) or external, guarded (access-prohibited), write-protected, or read/write in a byte unit.

[Add...]: Displays the [Edit Memory Mapping] dialog box, allowing the user to modify the address range and attributes of a memory map.

[Modify...]: Displays the [Edit Memory Mapping] dialog box, allowing the user to modify the address range and attributes of a memory map.

[Reset]: Resets the map memory to its default settings.

[Close]: Closes the dialog box.

The memory configuration of the device being emulated is displayed by the [Memory] sheet in the [Status] window.

Note: Some emulators may not support the emulation memory or the memory mapping function. For details, refer to section 8, Software Specifications Specific to This Product, or the online help.



### 5.1.5 Changing the Memory Map Setting

Clicking the [Add...] button on the [Memory Mapping] dialog box or clicking the [Modify...] button after selecting the information on the memory map setting you want to change opens the [Edit Memory Mapping] dialog box.

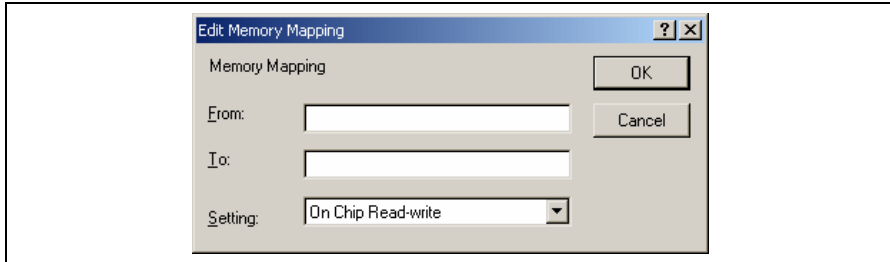

**Figure 5.5 [Edit Memory Mapping] Dialog Box**

Use this dialog box to change the address range and attributes of a memory map.

[From]: Enter the start address of the map range.

[To]: Enter the end address of the map range.

[Setting]: Enter the memory map setting.  
The choices given are listed below. The User (external memory) and Emulator (emulation memory) attributes can be modified.

- On-chip Read-write (Cannot be changed)
- On-chip Read-only (Cannot be changed)
- On-chip Guarded (Cannot be changed)
- User Read-write (Cannot be selected when the single chip mode is selected.)
- User Read-only (Cannot be selected when the single chip mode is selected.)
- User Guarded
- Emulator Read-write
- Emulator Read-only
- Emulator Guarded

## 5.2 Downloading a Program

This section describes how to download a program and view it as source code or assembly-language mnemonics.

**Note:** After a break occurs, the High-performance Embedded Workshop displays the location of the program counter (PC) on the editor. In most cases, for example if an Elf/Dwarf2 based project is moved from its original path (at the build), the source file may not be automatically found. In this case, the High-performance Embedded Workshop will open a source file browser dialog box to allow you to manually locate the file. This path will then be used to update any other source files in this debug project.

### 5.2.1 Downloading a Program

A load module to be debugged must be downloaded.

To download a program, select the load module from [Debug -> Download] or select [Download] from the popup menu opened by clicking the right-hand mouse button on the load module in [Download modules] of the [Workspace] window.

**Note:** Before downloading a program, it must be registered to the High-performance Embedded Workshop as a load module.

## 5.2.2 Viewing the Source Code

To view a source file's code, double-click on its icon in the file tree, or right-click on the source file and select the [Open] option on the pop-up menu. The [Editor] window is displayed.

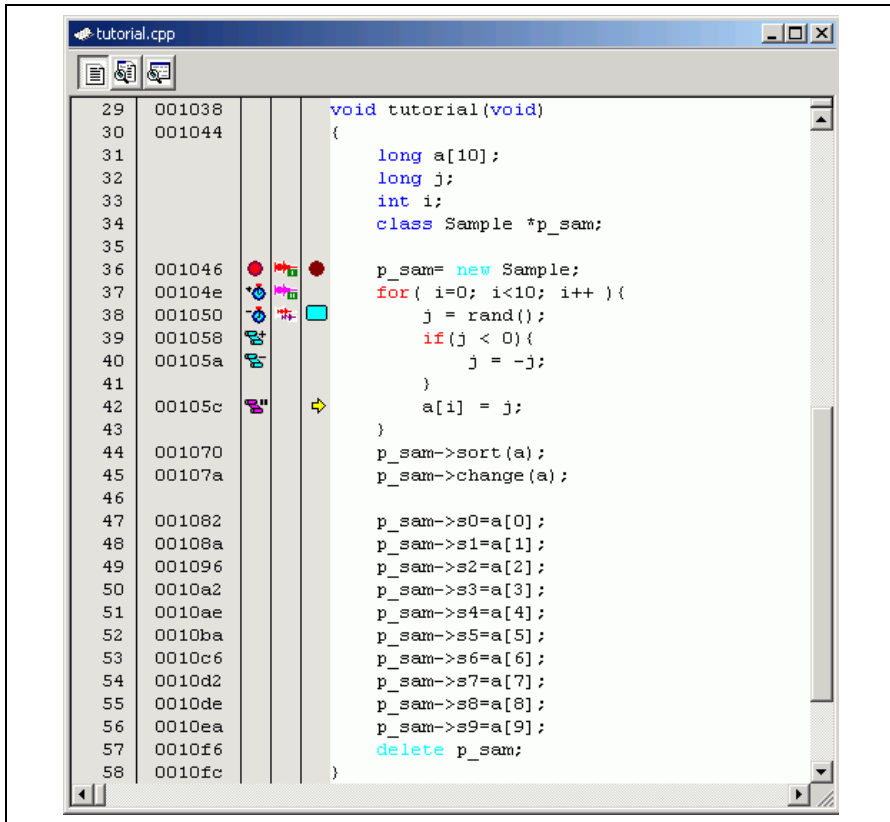

Figure 5.6 [Editor] Window

In this window, the following items are shown on the left as information on lines.

- 1st column (Line Number column): A line number for the source file
- 2nd column (Source Address column): Address information for the source line
- 3rd column (Event column): Event information (break)
- 4th column (EXT.2 Trigger column): EXT.2 Trigger information
- 5th column (S/W Breakpoints column): PC, bookmark, and breakpoint information

The text area is displayed in the right part of the [Editor] window.

### Line Number column







This column displays the line number for the source file.

### Source Address column

When a program is downloaded, an address for the current source file is displayed on the Source address column. These addresses are helpful when setting the PC value or a breakpoint.

### Event column





The Event column displays the following items:

- : Address condition break by an event or a range channel
- : Starts time measurement by an event channel
- : Ends time measurement by an event channel
- : Starts a point-to-point range trace
- : Ends a point-to-point range trace
- : Halts trace

These are also set by using the popup menu.

### EXT.2 Trigger column



The EXT.2 Trigger column displays the following items:

- : EXT.2-1 trigger condition
- : EXT.2-2 trigger condition
- : EXT.2-3 trigger condition
- : EXT.2-4 trigger condition
- : Two or more EXT.2 trigger conditions

It is also possible to set them by using the popup menu.

### S/W Breakpoints column

This column displays the following items:

- : A bookmark is set.
- : A Software Break is set.
- : PC location

☛ To switch off a column in all source files

1. Right-click on the [Editor] window or select the [Edit] menu.
2. Click the [Define Column Format...] menu item.
3. The [Global Editor Column States] dialog box is displayed.
4. A check box indicates whether the column is enabled or not. If it is checked, the column is enabled. If the check box is gray, the column is enabled in some files and disabled in others. Deselect the check box of a column you want to switch off.
5. Click the [OK] button for the new column settings to take effect.

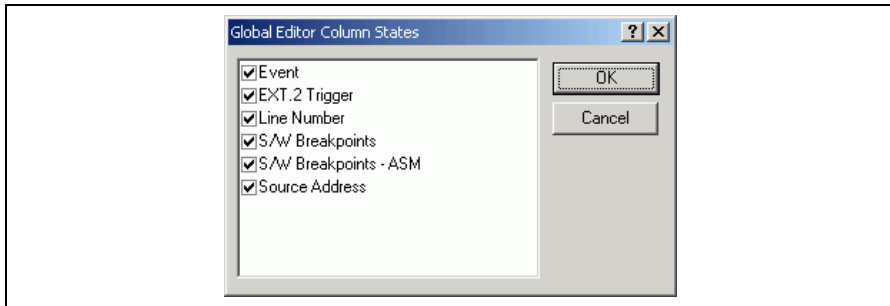

**Figure 5.7 [Global Editor Column States] Dialog Box**

☛ To switch off a column in one source file

1. Click the right-hand mouse button on the [Editor] window which contains the column you want to remove to display the popup menu.
2. Click the [Columns] menu item to display a cascaded menu item. The columns are displayed in this popup menu. If a column is enabled, it has a tick mark next to its name. Clicking the entry will toggle whether the column is displayed or not.

### 5.2.3 Viewing the Assembly-Language Code

If you have a source file open, right-click to open the pop-up menu and select the [View Disassembly] option to open a Disassembly view at the same address as the current Source view.

It is also possible to view the disassembly using the new integrated [Disassembly view] in the source file.

If you do not have a source file, but wish to view code at assembly-language level, then select one of the following operations:

- Click on the View Disassembly toolbar button (  ).
- Choose the [View -> Disassembly...] menu option.
- Press Ctrl + D.

The [Disassembly] window opens at the current PC location.

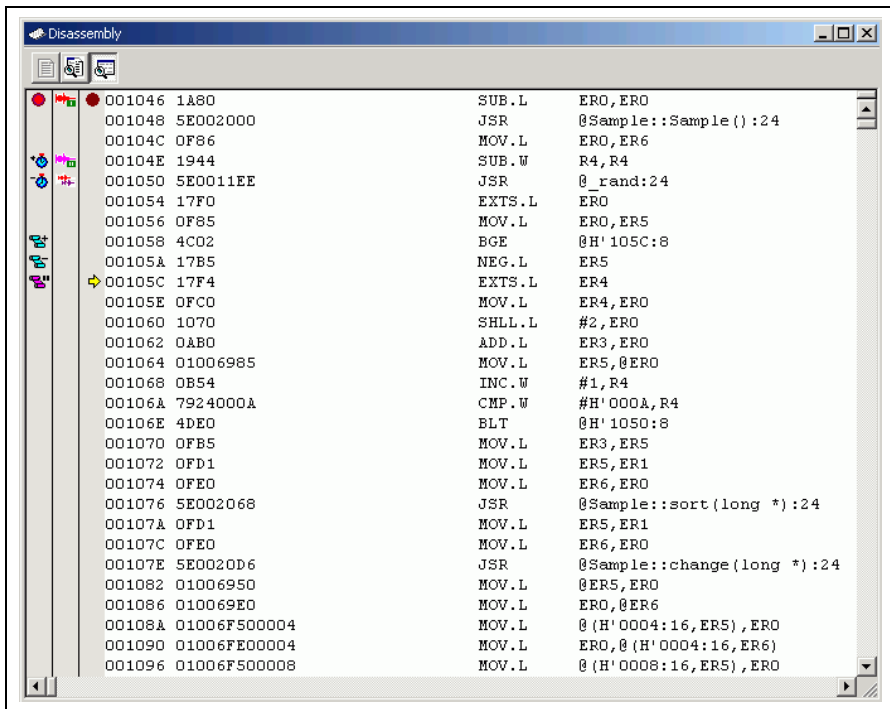

Figure 5.8 [Disassembly] Window

In this window, the following information is shown on the left as information lines.

- 1st column (Event column): Event information (break)
- 2nd column (EXT.2 Trigger column): EXT.2 Trigger information
- 3rd column (S/W Breakpoints - ASM column): PC and breakpoint information

This window is used in the same way as the source code window.

#### 5.2.4 Modifying the Assembly-Language Code

You can modify the assembly-language code by double-clicking on the instruction that you want to change. The [Assembler] dialog box will be opened.

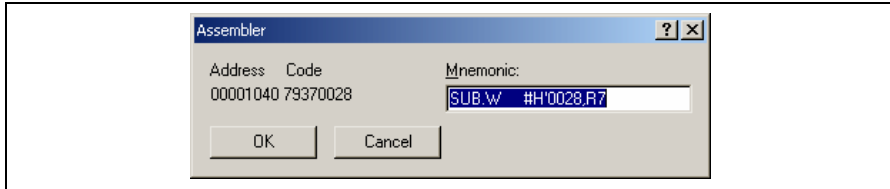

Figure 5.9 [Assembler] Dialog Box

The address, instruction code, and mnemonic are displayed. Enter the new instruction or edit the old instruction in the [Mnemonics] field. Pressing the [Enter] key will replace the memory content with the new instruction and move on to the next instruction. Clicking the [OK] button will replace the memory content with the new instruction and close the dialog box. Clicking the [Cancel] button or pressing the [Esc] key will close the dialog box without modifying the memory contents.

Note: The assembly-language code being displayed is the current memory content. If the memory contents are changed the [Assembler] dialog box and the [Disassembly] window will show the new assembly-language code, but the source file displayed in the [Editor] window will be unchanged. This is the same even if the source file contains an assembler.

#### 5.2.5 Viewing a Specific Address

When you are viewing your program in the [Disassembly] window, you may wish to look at another area of your program's code. Rather than scrolling through a lot of code in the program, you can go directly to a specific address. Select [Set Address...] from the popup menu, and the dialog box shown in figure 5.10 is displayed.

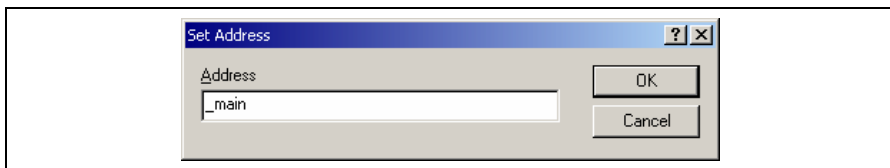



Figure 5.10 [Set Address] Dialog Box

Enter the address in the [Address] edit box and either click on the [OK] button or press the Enter key. A label name can also be specified as the address. The [Disassembly] window will be updated to show the code at the new address. When an overloaded function or a class name is entered, the [Select Function] dialog box opens for you to select a function.

#### 5.2.6 Viewing the Current Program Counter Address

Wherever you can enter an address or value into the High-performance Embedded Workshop, you can also enter an expression. If you enter a register name prefixed by the # character, the contents of that register will be used as the value in the expression. Therefore, if you open the [Set Address] dialog box and enter the expression #pc, the [Editor] or [Disassembly] window will display the current PC address. It also allows the offset of the current PC to be displayed by entering an expression with the PC register plus an offset, e.g., #PC+0x100.

### 5.3 Viewing the Current Status

Choose [View -> CPU -> Status] or click the [View Status] toolbar button () to open the [Status] window and see the current status of the debugging platform.

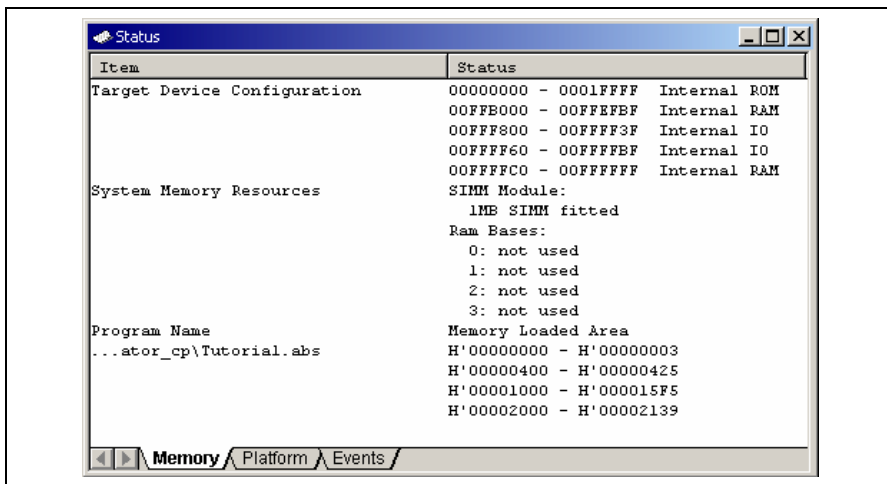

Figure 5.11 [Status] Window

The [Status] window has three sheets:

- [Memory] sheet  
Contains information about the current memory status including the memory mapping resources and the areas used by the currently loaded object file.
- [Platform] sheet  
Contains information about the current status of the debugging platform, typically including CPU type and mode; and run status.
- [Events] sheet  
Contains information about the current event (breakpoint) status, including resource information.

Note: The items that can be set in this dialog box vary according to the emulator in use. For details, refer to section 8, Software Specifications Specific to This Product, or the online help.



## 5.4 Reading and Displaying the Emulator Information Regularly

Use the [Extended Monitor] window to know the changing information on the emulator no matter the user program is running or halted.

Note: The Extended Monitor function does not affect the execution of the user program since it monitors the user system or the signal output from the MCU in the emulator by using the emulator's hardware circuit.

### 5.4.1 Opening the [Extended Monitor] Window

Selecting [View -> CPU -> Extended Monitor] or clicking the [Extended Monitor] toolbar button  displays this window. The interval of updating the display is approximately 100 ms during user program execution or 1,000 ms while breaking, respectively.

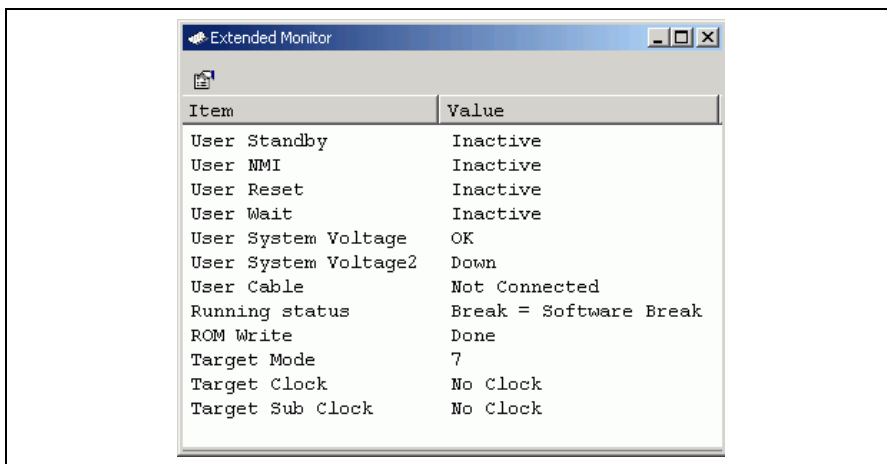
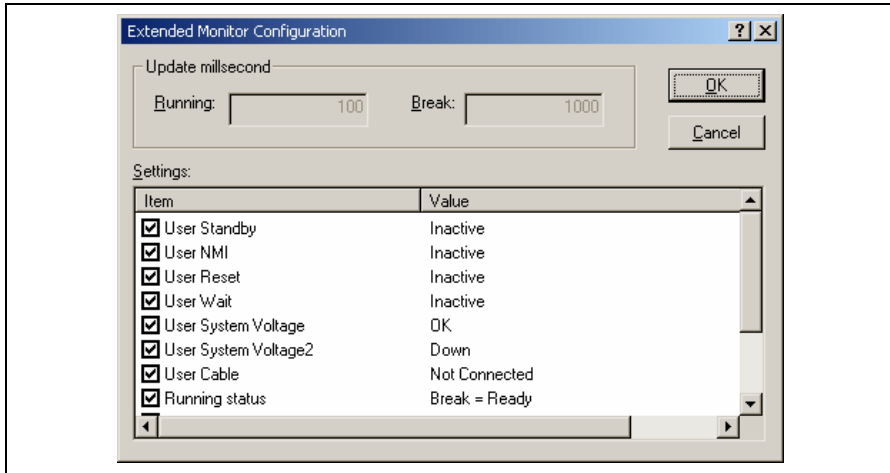

Figure 5.12 [Extended Monitor] Window

## 5.4.2 Selecting Items to be Displayed

Selecting [Properties...] from the popup menu displays the [Extended Monitor Configuration] dialog box.



**Figure 5.13 [Extended Monitor Configuration] Dialog Box**

This dialog box allows the user to set the items to be displayed in the [Extended Monitor] window.

Note: The items that can be set in this dialog box vary according to the emulator in use. For details, refer to section 8, Software Specifications Specific to This Product, or the online help.

## 5.5 Displaying Memory Contents in Realtime

Use the [Monitor] window to monitor the memory contents during user program execution. In the Monitor function, the realtime operation is retained since the bus monitoring circuit of the emulator sets the read/write signal of the MCU as a trigger and holds the address bus and data bus values to update the displayed contents of the memory.

Up to eight points can be set by using the eight monitoring channels on the bus monitoring circuit. 1 to 256 bytes can be monitored at one point. It is possible that a part or all of monitoring ranges is overlapped.

Note: Monitoring is impossible for an area, such as an internal timer counter, where no internal read/write signal is generated to update a value.

### 5.5.1 Opening the [Monitor] Window

To open the [Monitor] window, select [View -> CPU -> Monitor -> Monitor Setting...] or click the [Monitor] toolbar button (  ) to display the [Monitor Settings] dialog box.

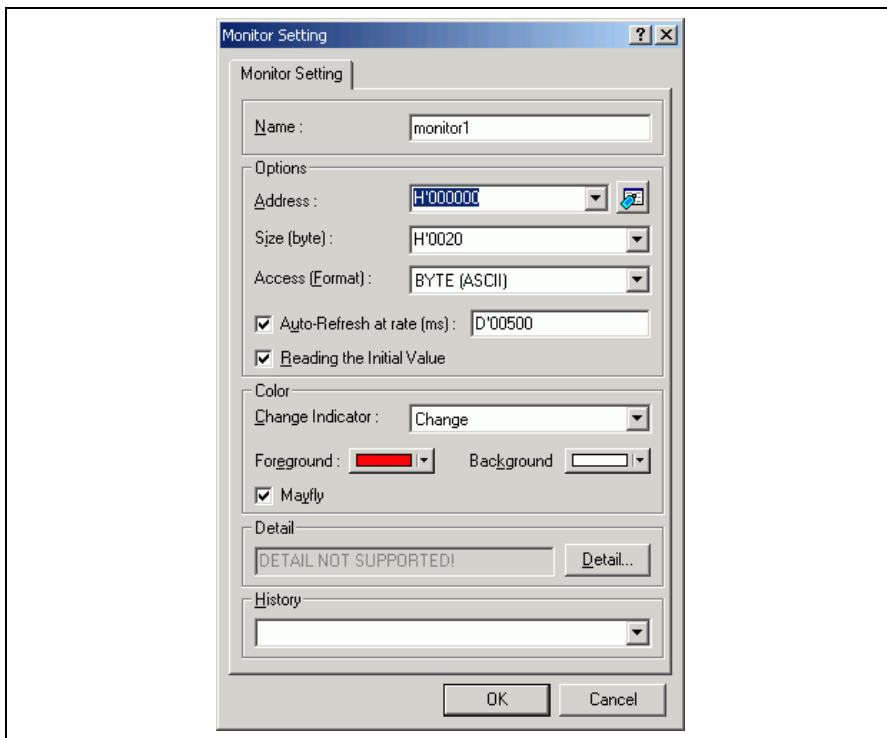

Figure 5.14 [Monitor Setting] Dialog Box

- [Name]: Decides the name of the monitor window.
- [Options]: Sets monitor conditions.
- [Address]: Sets the start address for monitoring.
- [Size]: Sets the range for monitoring.
- [Access]: Sets the access size to be displayed in the monitor window.
- [Auto-Refresh at rate (ms)]: Sets the interval for acquisition by monitoring (500 ms at minimum).
- [Reading the Initial Value]: Selects reading of the values in the monitored area when the monitor window is opened.
- [Color]: Sets the method to update monitoring and the attribute of colors.
- [Change Indicator]: Selects how to display the values that have changed during monitoring (available when [Reading the Initial Value] has been selected).
- No change:** No color change.
- Change:** Color is changed according to the [Foreground] and [Background] options.
- Gray:** Those data with values that have not been changed are displayed in gray.
- Appear:** A value is only displayed after changed.
- [Foreground]: Sets the color used for display (available when [Change] has been selected).
- [Background]: Sets the background color (available when [Change] has been selected).
- [Mayfly]: A check in this box selects restoration of the color of those data which have not been updated in a specified interval to the color selected in the [Background] option. The specified interval is the interval for monitor acquisition (available when [Change], [Gray], or [Appear] has been selected).
- [Detail]: Sets the items specific to the emulator. Not used with this emulator.
- [History]: Displays the previous settings.

- Notes: 1. In this emulator, odd addressees cannot be specified as the start addresses for monitoring.  
 2. Selection of the foreground or background color may not be available depending on the operating system in use.

After setting, clicking the [OK] button displays the [Monitor] window.

| Address | +0 | +1 | +2 | +3 | +4 | +5 | +6 | +7 | +8 | +9 | +A | +B | +C | +D | +E | +F |
|---------|----|----|----|----|----|----|----|----|----|----|----|----|----|----|----|----|
| FFEF80  | 00 | 00 | 13 | 72 | 00 | 00 | 28 | 47 | 00 | 00 | 2C | 67 | 00 | 00 | 33 | 59 |
| FFEF90  | 00 | 00 | 42 | 87 | 00 | 00 | 4D | AA | 00 | 00 | 50 | 0F | 00 | 00 | 64 | 88 |
| FFEFA0  | 00 | 00 | 69 | 56 | 00 | 00 | 75 | 66 | 00 | 02 | 12 | 24 | 00 | 00 | AA | AA |
| FFEFB0  | 57 | 70 | 00 | 00 | 00 | 01 | 80 | 74 | 00 | 00 | 10 | 36 | 00 | 00 | 04 | 1E |
| FFEF80  | 6A | 18 | 6A | 18 | 6A | 18 | 6A | 18 | 6A | 18 | 6A | 18 | 6A | 18 | 6A | 18 |

**Figure 5.15 [Monitor] Window**

During user program execution, the display is updated according to the setting value of the auto-update interval.

Note: Select [Refresh] from the popup menu when data is not displayed correctly after changing the address or content of memory.

### 5.5.2 Changing the Monitor Settings

Selecting [Monitor Setting...] from the popup menu of the [Monitor] window displays the [Monitor Setting] dialog box, which allows the settings to be changed.

Colors, the size of accesses, and the display format can be easily changed from [Color] or [Access] of the popup menu.

### 5.5.3 Temporarily Stopping Update of the Monitor

During user program execution, the display of the [Monitor] window is automatically updated according to the auto-update interval. Select [Lock Refresh] from the popup menu of the [Monitor] window to stop the update of display. The characters in the address section are displayed in black, and the update of display is stopped.

Selecting [Lock Refresh] again from the popup menu cancels the stopped state.

### 5.5.4 Deleting the Monitor Settings

Selecting [Close] from the popup menu of the [Monitor] window to be deleted closes the [Monitor] window and deletes the monitor settings.

### 5.5.5 Monitoring Variables

Using the [Watch] window refers to the value of any variables.

When the address of the variable registered in the [Watch] window exists within the monitoring range that has been set by the Monitor function, the value of the variable can be updated and displayed.

This function allows checking the content of a variable without affecting the realtime operation.

### 5.5.6 Hiding the [Monitor] Window

When using the Monitor function to monitor the value of a variable from the [Watch] window, hide the [Monitor] window for the effective use of the screen.

The current monitoring information is listed as the submenu when selecting [Display -> CPU -> Monitor]. The list consists of the [Monitor] window name and the address to start monitoring.

When the left of the list is checked, the [Monitor] window is being displayed.

Selecting items of the [Monitor] window you want to hide from the monitor setting list displays no [Monitor] window and removes the check mark at the left of the list.

To display the [Monitor] window again, select the hidden the [Monitor] window.

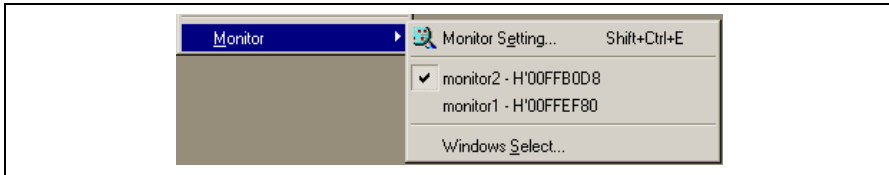
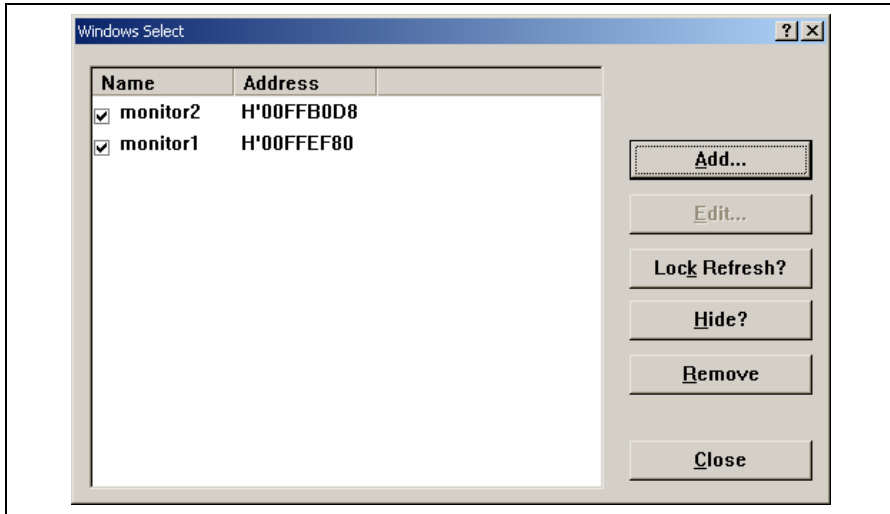

Figure 5.16 Monitor Setting List

### 5.5.7 Managing the [Monitor] Window

Selecting [Display -> CPU -> Monitor -> Windows Select...] displays the [Windows Select] dialog box. In this window, the current monitoring condition is checked and the new monitoring condition is added, edited, and deleted in succession.

Selecting multiple monitoring conditions enables a temporary stop of update, hiding, and deletion.



**Figure 5.17 Selection in the [Monitor] Window**

[Add]: Adds a new monitoring condition.

[Edit]: Changes the settings of the selected [Monitor] window (disabled when selecting multiple items).

[Lock Refresh/Unlock Refresh]: Automatically updates or stops updating the display of the selected [Monitor] window.

[Hide/UnHide]: Displays or hides the selected [Monitor] window.

[Remove]: Removes the selected monitoring conditions.

[Close]: Closes this dialog box.

## 5.6 Viewing the Variables

This section describes how you can look at variables in the source program.

### 5.6.1 [Watch] Window

You can view any value in the [Watch] window.

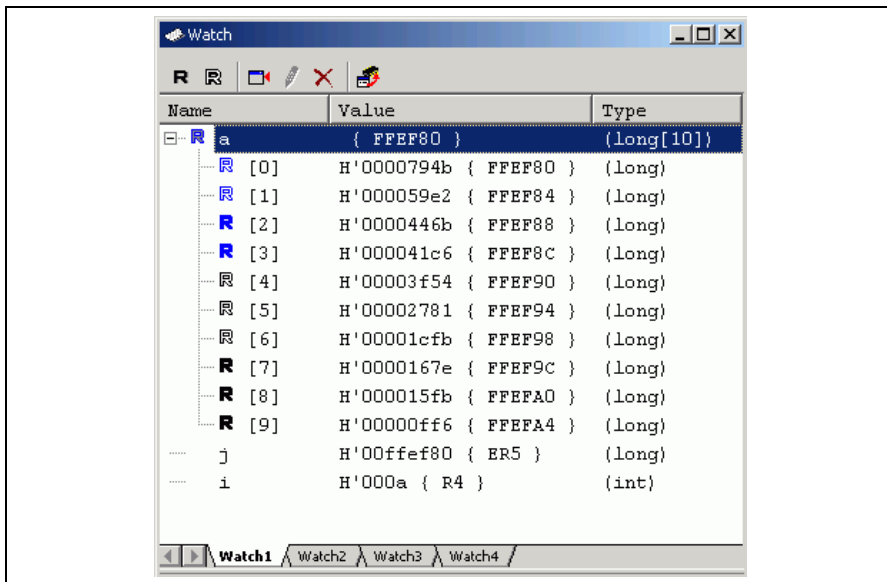

Figure 5.18 [Watch] Window

The [R] mark shows that the value of the variable can be updated during user program execution.

For updating of the content of the variable that has been registered in the [Watch] window, there are the following three methods:

1. Use the Monitor function without halting the user program

The read/write signal of the MCU is set as a trigger and holds the address bus and data bus values to update the value of the variable.

Note: Although the realtime operation is retained, the size and number points to be monitored are limited. For the Monitor function, refer to section 5.5, Displaying Memory Contents in Realtime.



2. Read the memory content directly from the High-performance Embedded Workshop to update the values without halting the user program since the bus mastership is owned by the emulator

Note: While the emulator reserves the bus mastership, the realtime operation is disabled because the CPU stops operation. This method is only available for accessing the internal ROM, internal RAM, and emulation memory.

The area used here or this method may not be available depending on the emulator in use. For details, refer to section 8, Software Specifications Specific to This Product, or [Enable read and write on the fly] on the [General] page of the [Configuration Properties] dialog box in the online help.

3. Temporarily stops the user program and reads the memory contents

Note: The realtime operation is disabled because the user program is stopped temporarily. This method is only available for accessing the areas (internal I/O, DTCRAM, and user memory) other than those in item 2 mentioned above.

It is possible to recognize the method for updating the value during user program execution according to the color of the [R] mark.

Blue-outline [R]: The variable's address is within the range that has been set for the monitoring function and the data is readable by using the monitoring function.

Blue [R]: An updated value of the data at this location has been read by the monitoring function.

Black-outline [R]: The variable's address is outside the range that has been set for the monitoring function and the data is not readable by using the monitoring function.

Black [R]: A value has been updated by reading the normal data.

- Notes:
1. This function can be set per variable or per element or body for structures of data.
  2. The color of an [R] in the [Name] column changes according to the trace and monitoring settings.
  3. A variable that is allocated to a register cannot be selected for monitoring.

## 5.7 Using the Event Points

The emulator has the event point function that performs breaking, tracing, and execution time measurement by specifying higher-level conditions along with the software breakpoints standard for the High-performance Embedded Workshop.

### 5.7.1 Software Breakpoints

When the instruction of the specified address is fetched, the user program is stopped. Up to 256 points can be set.

Note that, however, only one software breakpoint can be set in the ROM area of the user system. This particular breakpoint is called the on-chip breakpoint, which stops the user program after executing the instruction of the specified address.

When it is necessary to set two or more software breakpoints to the external ROM area of the user system, allocate this area to the emulation memory, copy the code, and then set the software breakpoints.

### 5.7.2 Event Points

Event points can be used for higher-level conditions such as the data condition as well as specification of the single address. Up to 12 event points can be set by using event channels and range channels in the event detection system.

When the condition is satisfied, event points are also used as the start/end conditions for execution time measurement or trace acquisition in addition to halting the user program. Several event points can be used to set more complex conditions.

Note: Event points acquire the data, test conditions, and execute an action (such as halting the user program) by the hardware circuit of the emulator. Therefore, a delay of several cycles will occur from the satisfaction of the condition to the execution of an action.

### 5.7.3 Event Detection System

In addition to the 4 range channels, the emulator also has 8 event channels. The event channels have more functions (such as sequencing or counting) than the range channels.

#### Event Channels (Ch1 to Ch8):

The emulator has 8 event channels. The event channel can be defined as a combination of one or more of the followings:

- An address or an address range
- Outside of an address range
- A read, a write, or either
- Data with a mask specification
- Bus state
- Area
- The value of four external probe signals
- The number of times the event has occurred
- The number of delay cycles after the event has occurred

A maximum of eight points can be used as a combination in a sequence. The program is activated or halted by an occurrence of the previous event in each sequence.

**Range Channels (Ch9 to Ch12):**

The emulator has 4 range channels. The range channel can be defined as a combination of one or more of the followings:

- An address or an address range
- Outside of an address range
- A read, a write, or either
- Data with a mask specification
- Bus state
- Area
- The value of four external probe signals
- The number of delay cycles after the event has occurred

**5.7.4 Signals to Indicate Bus States and Areas**

In the event detection system, signals indicating the MCU’s bus states and the accessed areas can be specified as the event detection condition.

These signals are output from the MCU on the emulator; the signals to be acquired will vary according to the emulator in use.

The signals to indicate bus states and areas are used to set the [Bus/Area] condition of the event point. They can also be acquired as the trace information.

The bus state signals are also used to set the condition not to acquire the trace ([Suppress] option) and in the Access Count Of Specified Range Measurement mode for measuring the hardware performance ([Access Type] option).

For the trace function, refer to section 5.8, Viewing the Trace Information. For the hardware performance function, refer to section 5.9, Analyzing Performance.

The following tables show examples of signals to indicate the bus states and areas that can be acquired by the emulator.

**Table 5.1 Bus State Signals Acquired by the Emulator**

| <b>Bus State</b> | <b>Trace Display (Status)</b> | <b>Description</b>     |
|------------------|-------------------------------|------------------------|
| CPU Prefetch     | PROG                          | CPU prefetch cycles    |
| CPU Data         | DATA                          | CPU data access cycles |
| Refresh          | REFRESH                       | Refresh cycles         |
| DMAC             | DMAC                          | DMAC cycles            |
| DTC              | DTC                           | DTC cycles             |
| Other            | OTHER                         | Others                 |

**Table 5.2 Area Signals Acquired by the Emulator**

| Area               | Trace Display (Status) | Description           |
|--------------------|------------------------|-----------------------|
| On-chip ROM        | ROM                    | ROM                   |
| On-chip RAM        | RAM                    | RAM                   |
| On-chip I/O 16bit  | I/O-16                 | 16-bit I/O            |
| On-chip I/O 8bit   | I/O-8                  | 8-bit I/O             |
| External I/O 16bit | EXT-16                 | 16-bit EXT (external) |
| External I/O 8bit  | EXT-8                  | 8-bit EXT (external)  |
| DTC RAM            | RAM/DTC                | DTCRAM                |

Note: The signals to indicate the bus states and areas vary according to the emulator in use. For details, refer to section 8, Software Specifications Specific to This Product, or the online help.

### 5.7.5 Opening the [Event] Window

Select [View -> Code -> Eventpoints] or click the [Eventpoints] toolbar button  to open the [Event] window.

The [Event] window has the following three sheets:

[Breakpoint] sheet: Displays the settings made for software breakpoints. It is also possible to set, modify, and cancel software breakpoints.

[Event] sheet: Displays or sets event points.

[Trigger] sheet: Displays or sets trigger points.

### 5.7.6 Setting Software Breakpoints

It is possible to display, modify, and add software breakpoints on the [Breakpoint] sheet.

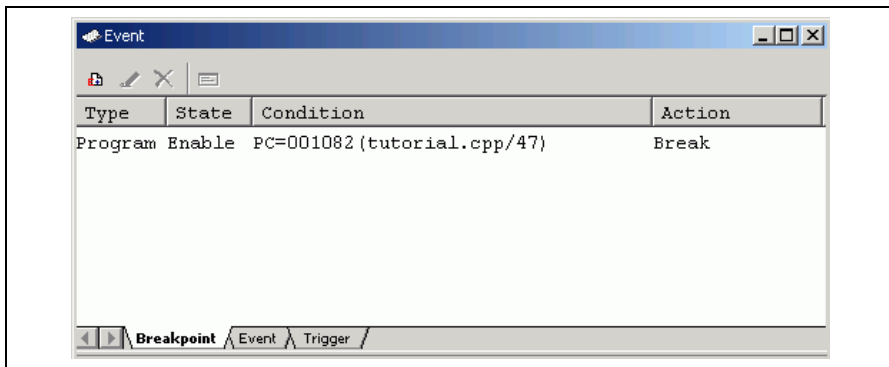

**Figure 5.19 [Event] Window ([Breakpoint] Sheet)**

Select [Add...] or the software breakpoint displayed in this window and then select [Edit...] from the popup menu to display the [Breakpoint/Event Properties] dialog box.

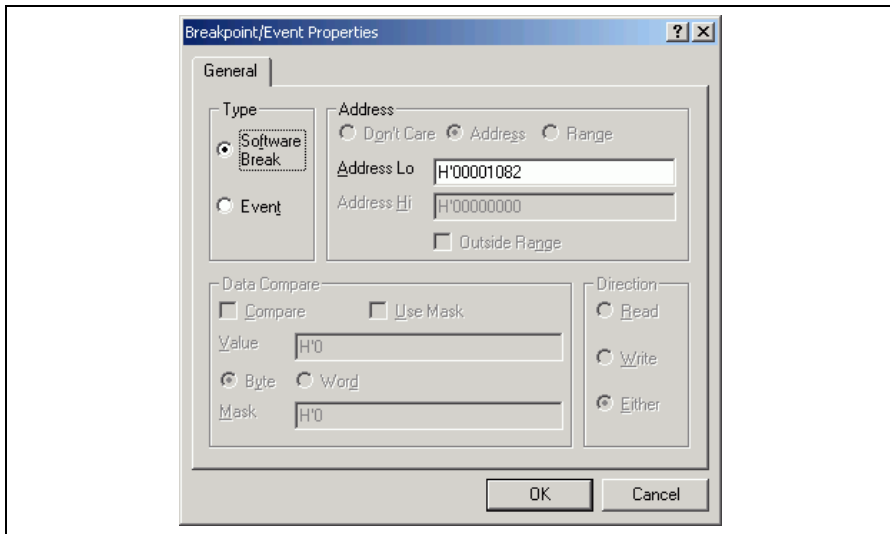

**Figure 5.20 [Breakpoint/Event Properties] Dialog Box (Setting a Software Break)**

In this dialog box, select the address condition to set software breakpoints.

[Type]: Select the type of a breakpoint. Note that the [Breakpoint/Event Properties] dialog box is used for setting software breakpoints and event points. Selecting a particular type of breakpoint enables or disables other pages and parts of the dialog according to the options available to that type of breakpoint.

[Software Break]: Only a single address with a program fetch can be selected. Other options are invalid.

[Event]: Set conditions in detail with other options on this page, or on the [Bus/Area], [Signals], or [Action] page.

[Address]: Set address conditions.

[Address Lo]: Select a single address where a software breakpoint will be set.

### 5.7.7 Setting Event Points

On the [Event] sheet, the settings for event points are displayed, modified, and added.

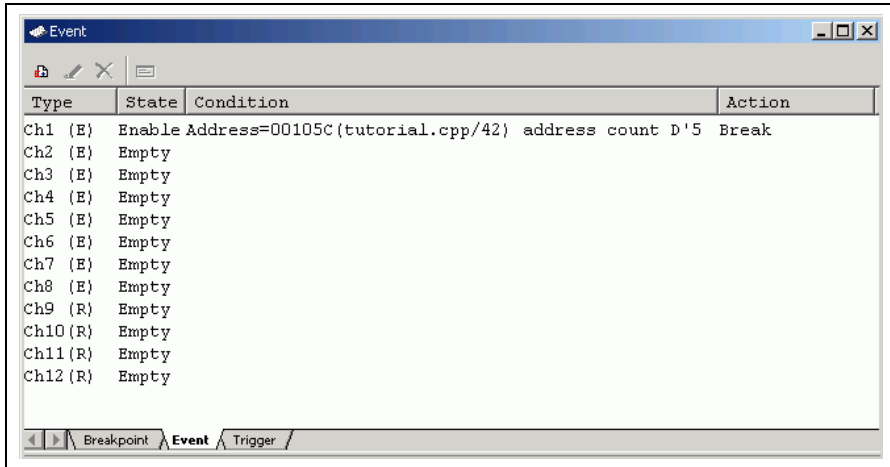

Figure 5.21 [Event] Window ([Event] Sheet)

Select [Add...] or the event point displayed in this window and then select [Edit...] from the popup menu to display the [Breakpoint/Event Properties] dialog box.

The conditions for the event point are set on the [General], [Bus/Area], [Signals], and [Action] pages. The search condition for the event point is set by multiple conditions set on these pages.

- Notes:
1. Channel 8 has the trigger output function. When the condition on channel 8 is satisfied, the low-level signal will be output from the external probe 1 (EXT1) for a bus cycle.
  2. When the event point is used as the condition for acquiring the trace information, select [Trace Acquisition...] from the popup menu. For the trace function, refer to section 5.8, Viewing Trace Information.
  3. If a condition that is unavailable for a range channel is set in editing of the range channels (Ch9 to Ch12), the selected channel is automatically replaced by an unused event channel (Ch1 to Ch8).

Table 5.3 Conditions Unavailable for a Range Channel

| Condition  | Related Options   |
|--|---|
| Selecting outside the specified address range                | [Outside Range] on the [General] page                       |
| Selecting the start or end of the execution time measurement | [Start Timer] and [Stop Timer] on the [Action] page         |
| Specifying the count when an event occurs (twice or more)    | [Required number of event occurrences] on the [Action] page |
| Specifying sequencing  | [Enable Sequencing] on the [Action] page                    |

(1) [General] page

The address and data conditions are set.

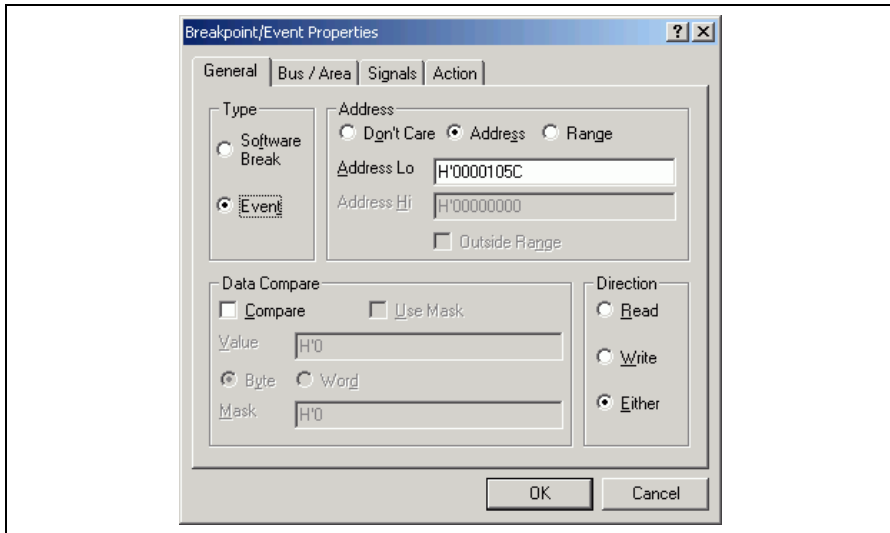

**Figure 5.22 [Breakpoint/Event Properties] Dialog Box ([General] Page)**

[Type]: Select the type of a breakpoint. Note that the [Breakpoint/Event Properties] dialog box is used for setting software breakpoints and event points. Selecting a particular type of breakpoint enables or disables other pages and parts of the dialog according to the options available to that type of breakpoint.

[Software Break]: Only a single address with a program fetch can be selected. Other options are invalid.

[Event]: Set conditions in detail with other options on this page, or on the [Bus/Area], [Signals], or [Action] page.

[Address]: Sets the address condition.

[Don't care]: Sets no address condition.

[Address]: Allows a single address to be selected.

[Range]: Allows an address range to be selected.

[Address Lo]: Set a single address or the start of an address range (available when [Address] or [Range] has been selected).

[Address Hi]: Set the end of an address range (available when [Range] has been selected).

[Outside Range]: Used to negate the range (i.e., the event will occur when the address is outside the range). This is available when [Address] or [Range] has been selected.

[Data Compare]: Sets the data condition.

[Compare]: Checking this box compares data.

[Use Mask]: Sets a mask condition (available when [Compare] has been selected).

[Value]: Specifies the data bus value as numerics. The size of data for access can also be selected (available when [Compare] has been selected).

[Byte]: Sets access in bytes as the condition (available when [Compare] has been selected).

[Word]: Sets access in words as the condition (available when [Compare] has been selected).

[Mask]: Sets a value to be masked. This value will be ANDed with the value of the data bus and data condition. The result will be used to compare data (available when [Use Mask] has been selected).

[Direction]: Selects a condition with read or write cycles.

[Read]: Sets read cycles as the condition.

[Write]: Sets write cycles as the condition.

[Either]: Sets either read or write cycles as the condition.



(2) [Bus/Area] page

Use this page to set the bus status and the memory area being accessed.

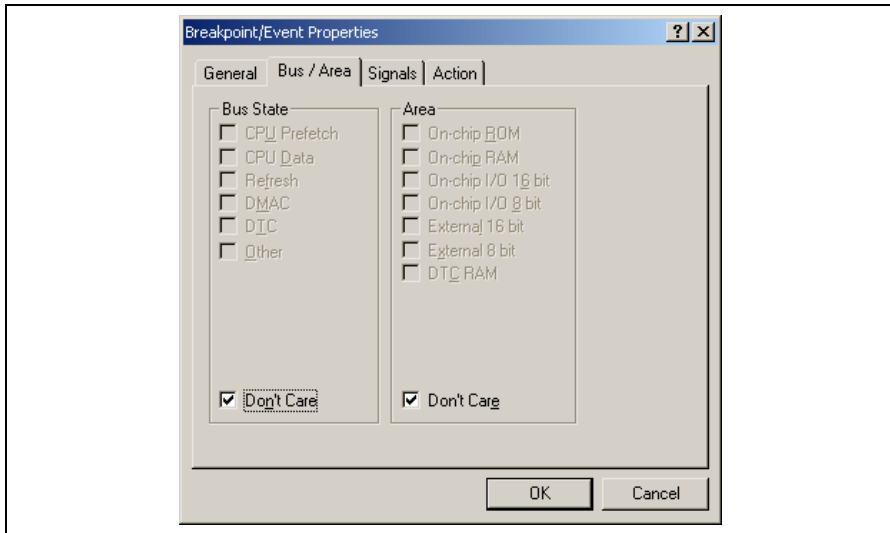

**Figure 5.23 [Breakpoint/Event Properties] Dialog Box ([Bus/Area] Page)**

[Bus State]: Sets the bus status as the condition. When the [Don't care] check box is checked, the event will be satisfied with any bus status.

[Area]: Specifies the area for searching. When the [Don't care] check box is checked, the event will be satisfied in any area.

Note: Items set for the bus state and memory access area vary according to the emulator in use. For details, refer to section 5.7.4, Signals to Indicate Bus States and Areas.

(3) [Signals] page

Use this page to set external signals.

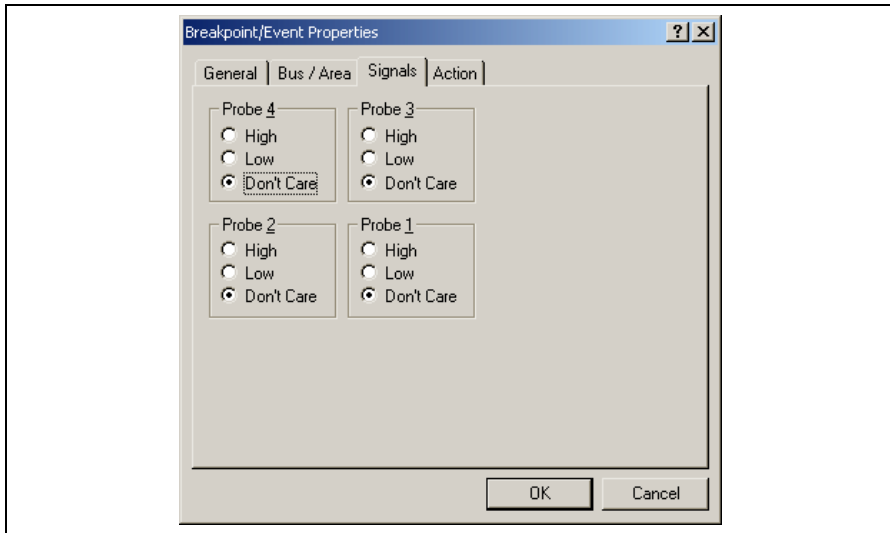

Figure 5.24 [Breakpoint/Event Properties] Dialog Box ([Signals] Page)

- [Probe4]: Detects the status of the input probe signal 4
  - [High]: Detects the high level of the input probe signal
  - [Low]: Detects the low level of the input probe signal
  - [Don't care]: The status of the input probe signal is not detected
- [Probe3]: Detects the status of the input probe signal 3
  - [High]: Detects the high level of the input probe signal
  - [Low]: Detects the low level of the input probe signal
  - [Don't care]: The status of the input probe signal is not detected
- [Probe2]: Detects the status of the input probe signal 2
  - [High]: Detects the high level of the input probe signal
  - [Low]: Detects the low level of the input probe signal
  - [Don't care]: The status of the input probe signal is not detected

- [Probe1]: Detects the status of the input probe signal 1
- [High]: Detects the high level of the input probe signal
- [Low]: Detects the low level of the input probe signal
- [Don't care]: The status of the input probe signal is not detected

(4) [Action] page

Use this page to decide what action the emulator takes when the defined event occurs.

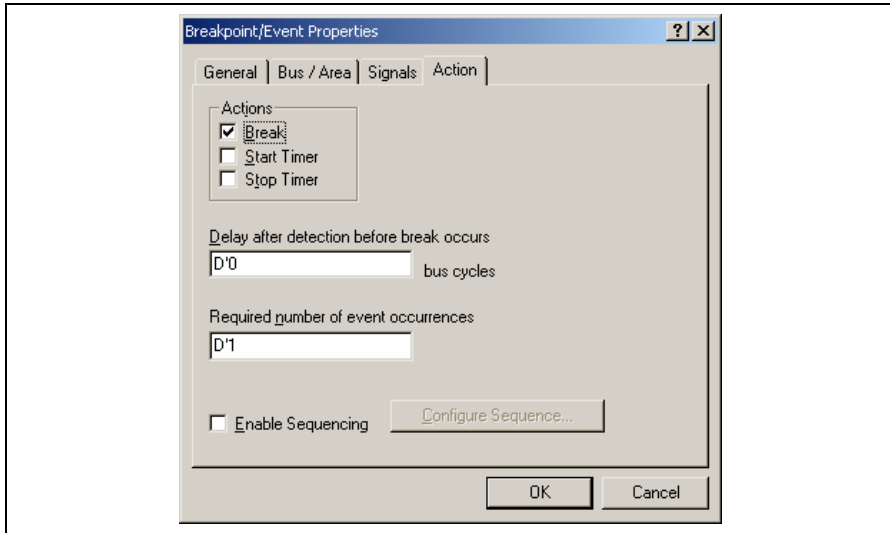

**Figure 5.25 [Breakpoint/Event Properties] Dialog Box ([Action] Page)**

- [Action]: Selects an action that occurs when the event is satisfied. This cannot be used for an event point being used as the trace acquisition condition.
- [Break]: Causes a break (stop) in the user program when the event occurs. This is the default action.
- [Start Timer]: Starts the run timer (the run timer value is displayed in the [Status] window).
- [Stop Timer]: Stops the run timer (the run timer value is displayed in the [Status] window).
- [Delay after detection before break occurs]: Sets a 16-bit delay (in bus cycles) after the event has occurred before the action is taken. The delay is only applicable to break events and there is only one delay counter in hardware, therefore only one breakpoint can have a non-zero delay. The range of values is D'0 to D'65,535 (only available when [Break] has been selected). This cannot be used for an event point being used as the trace acquisition condition.

[Required number of event occurrences]:

Allows a 16-bit pass count to be set. The event must occur the specified number of times before the action is taken. The range of values is D'0 to D'65,535.

[Enable Sequencing]: Allows the event to take part in a sequence of events (setting this requires the event to use an event detector).

[Configure Sequence...]: Displays the [Event Sequencing] dialog box to allow the event sequencing to be configured (only available when [Enable Sequencing] has been selected).

(5) [Event Sequencing] dialog box

This dialog box allows the user to define which events are triggered by other events. If this dialog box is accessed (directly or indirectly) from [Trace Acquisition...], only those events assigned to the trace subsystem are displayed. If accessed from the [Eventpoint] window, only the breakpoint or timer events are shown.

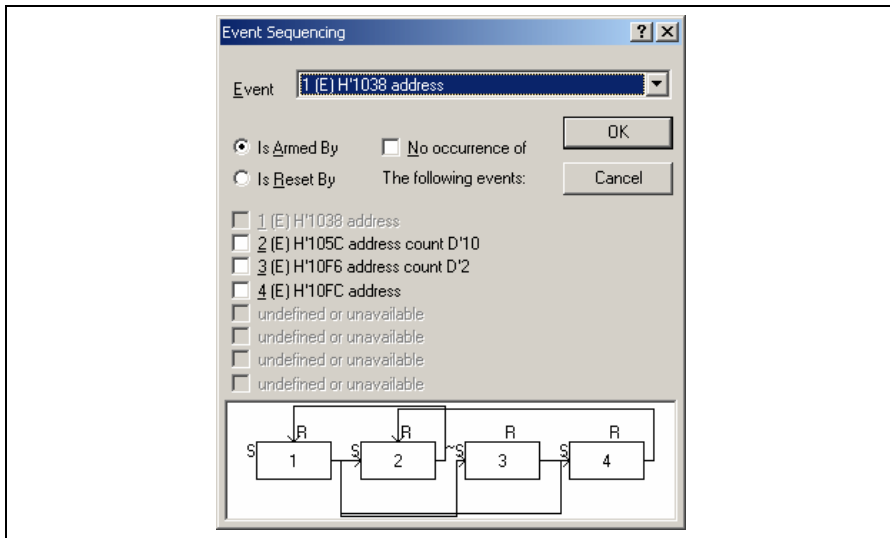

Figure 5.26 [Event Sequencing] Dialog Box

[Event]: Selects an event point to be set.

[Is Armed By]: Arms the selected event.

[Is Reset By]: Resets the selected event.

[No occurrence of]: Arms an event when the set of events being selected does not occur (only available when [Is Armed By] has been selected).

The test of conditions on event points is started with the execution of the user program. The conditions on event points have not been satisfied immediately after the execution of the user program is started.

Satisfaction of the condition on an event point allows a transition of the state to that where the condition is satisfied.

The state where the condition is satisfied is retained until the user program is stopped or the event point is reset.

When the condition on the event point is satisfied, no action will be taken even if the condition is satisfied again. If you want the action to be taken again, reset the event point so that the state transits to that where no condition is satisfied.

When the user program is stopped, the states of all the event points transit to that where no condition is satisfied.

When an event point must be in the state where its condition is satisfied or not (when [No occurrence of] is selected) as the satisfaction condition of another event point, this event point is called the arm event.

An event point can reset the tested states of conditions of other event points or itself by satisfying the condition. This event point is called a reset event.

A reset event resets event points regardless of their states where the condition is satisfied or not (e.g., resetting the pass count).

Select an event point from the [Event] combo box. To set an arm event on the selected event point, select [Is Armed By] and check the box corresponding to each event. The [No occurrence of] check box is used to set a condition that the arm event is in the state where its condition is not satisfied.

To set a reset event on the selected event point, select [Is Reset By] and check the box corresponding to each event.

At the bottom of the screen is a diagram showing the current sequencing of the events (figure 5.26). The S input sets (arms) an event and the R input resets it. The legend ~S indicates the event is set (armed) by the non-occurrence of the input events.

Figure 5.26 is an example that Ch1 is the arm event for Ch2, Ch3, and Ch4. Ch3 is the arm event for Ch4. Ch2 and Ch4 are the reset events for Ch1 and Ch2, respectively.

To satisfy the condition of the event point having an arm event, the arm event must be in the state where the condition is satisfied or not (when [No occurrence of] is selected). When multiple arm events exist on one event point, one of the arm events must be in the state where the condition is satisfied or not (when [No occurrence of] selected) to satisfy the condition of the event point.

As the condition of the arm event on one event point, either of the states where the condition is satisfied or not should be set.

To reset an event point with a reset event, the condition of the reset event must be satisfied. While the condition of the reset point is satisfied, no event point is reset even if the condition of the reset event is satisfied again.

When multiple reset events exist on one event point, the event point is reset when the condition of one of reset events is satisfied.

### 5.7.8 Setting Trigger Points

The trigger point is an event to output a trigger when the specified address has been accessed. Up to four trigger points can be set by using the trigger outputs (four channels) on the bus monitoring circuit of the emulator.

The settings of the trigger point are displayed and modified on the [Trigger] sheet.

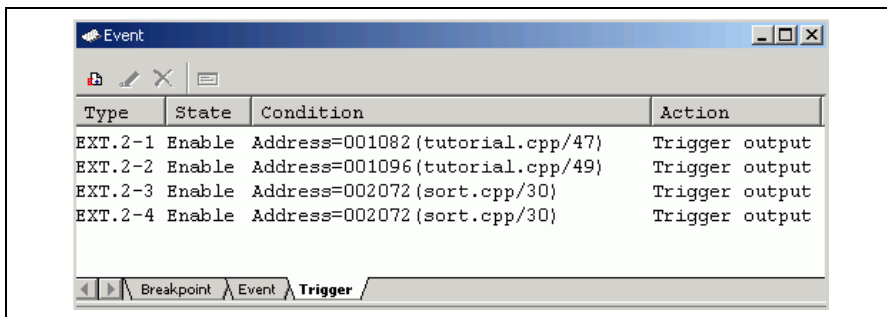

Figure 5.27 [Event] Window ([Trigger] Sheet)

Selecting [Add...] or the event point and [Edit...] from the popup menu in this window displays the [Set Address For Trigger] dialog box.

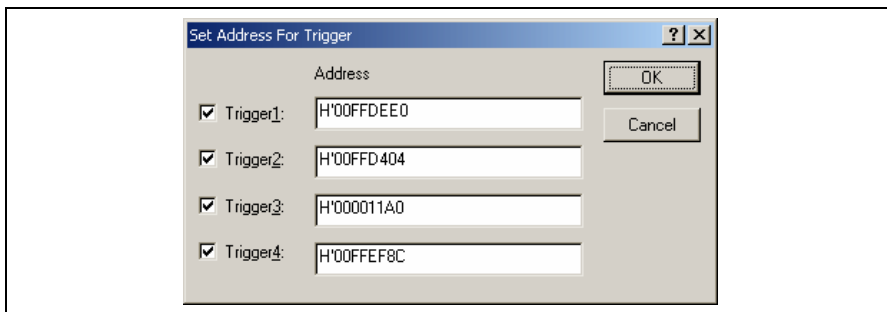

Figure 5.28 [Set Address For Trigger] Dialog Box

This dialog box allows the user to specify the address to be accessed as the trigger output condition during the user program execution. Enable or disable the trigger output point by checking the check box on the left in the screen.

- [Trigger1]: Enables the output of trigger channel 1.
- [Trigger2]: Enables the output of trigger channel 2.
- [Trigger3]: Enables the output of trigger channel 3.
- [Trigger4]: Enables the output of trigger channel 4.
- [Address]: Sets the address condition of the channel.

- Notes:
1. When the condition set for the trigger output (1 to 4) is satisfied, the high-level signal will be output from the corresponding pin (1 to 4) of the external probe 2 (EXT2) during reading or writing.
  2. Some emulators may not support the trigger point. For details, refer to section 8, Software Specifications Specific to This Product, or the online help.

### **5.7.9 Editing Event Points**

Handlings for settings other than software breakpoints, event points, and trigger points are common. The following describes examples of such handling.

#### **5.7.10 Modifying Event Points**

Select an event point to be modified, and choose [Edit...] from the popup menu to open the dialog box that corresponds the event, which allows the user to modify the event conditions. The [Edit...] menu is only available when one event point is selected.

#### **5.7.11 Enabling an Event Point**

Select an event point and choose [Enable] from the popup menu to enable the selected event point.

#### **5.7.12 Disabling an Event Point**

Select an event point and choose [Disable] from the popup menu to disable the selected event point. When an event point is disabled, the event point will remain in the list, but an event will not occur when the specified conditions have been satisfied.

#### **5.7.13 Deleting an Event Point**

Select an event point and choose [Delete] from the popup menu to remove the selected event point. To retain the event point but not have it cause an event when its conditions are met, use the [Disable] option (see section 5.7.12, Disabling an Event Point).

Note: No trigger point can be deleted. Use the [Disable] option to clear the settings.

#### **5.7.14 Deleting All Event Points**

Choose [Delete All] from the popup menu to remove all event points.

Note: No trigger point can be deleted. If [Delete All] is selected, the settings of all channels become disabled.

#### **5.7.15 Viewing the Source Line for an Event Point**

Select an event point and choose [Go to Source] from the popup menu to open the [Editor] or [Disassembly] window at address of event point. The [Go to Source] menu is only available when one event point that has the corresponding source file is selected.

## 5.8 Viewing the Trace Information

The emulator acquires the results of each instruction execution into the trace buffer as trace information and displays it in the [Trace] window. The conditions for the trace information acquisition can be specified in the [Trace Acquisition] dialog box.

Since trace information in bus-cycles is acquired by the hardware circuit and stored in the trace buffer, the realtime operation is retained. The [Trace] window displays the content of the trace buffer, which records up to 32,768 bus cycles from the last program run and is always updated.

### 5.8.1 Opening the [Trace] Window

To open the [Trace] window, choose [View -> Code -> Trace] or click the [Trace] toolbar button (  ).

### 5.8.2 Acquiring Trace Information

When the emulator does not set the acquisition condition of the trace information, all bus cycles are acquired by default without any condition (free trace mode).

In the free trace mode, trace acquisition is started with the execution of the user program and stopped by halting the user program. The acquired trace information is displayed in the [Trace] window.

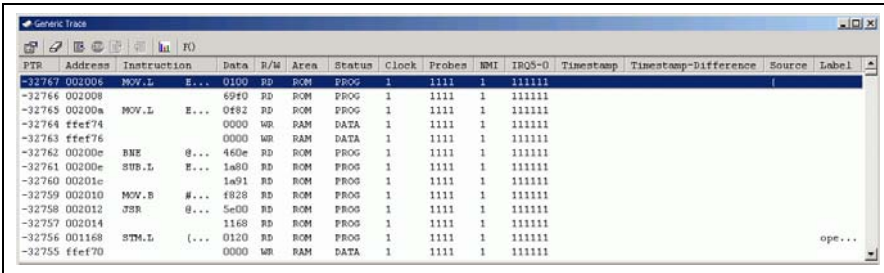

| PTR    | Address | Instruction | Data  | R/W  | Area | Status | Clock | Proben | NMT  | IPQS-0 | Timestamp | Timestamp-Difference | Source | Label  |
|--------|---------|-------------|-------|------|------|--------|-------|--------|------|--------|-----------|----------------------|--------|--------|
| -32767 | 002006  | MOV.L       | E...  | 0100 | RD   | ROM    | PROG  | 1      | 1111 | 1      | 111111    |                      |        |        |
| -32766 | 002009  |             |       | 69F0 | RD   | ROM    | PROG  | 1      | 1111 | 1      | 111111    |                      |        |        |
| -32765 | 00200a  | MOV.L       | E...  | 0482 | RD   | ROM    | PROG  | 1      | 1111 | 1      | 111111    |                      |        |        |
| -32764 | ffeef74 |             |       | 0000 | WR   | RAM    | DATA  | 1      | 1111 | 1      | 111111    |                      |        |        |
| -32763 | ffeef76 |             |       | 0000 | WR   | RAM    | DATA  | 1      | 1111 | 1      | 111111    |                      |        |        |
| -32762 | 00200e  | BNE         | @...  | 460e | RD   | ROM    | PROG  | 1      | 1111 | 1      | 111111    |                      |        |        |
| -32761 | 00200e  | SUB.L       | E...  | 1a80 | RD   | ROM    | PROG  | 1      | 1111 | 1      | 111111    |                      |        |        |
| -32760 | 00201e  |             |       | 1a91 | RD   | ROM    | PROG  | 1      | 1111 | 1      | 111111    |                      |        |        |
| -32759 | 002010  | MOV.B       | #...  | 1828 | RD   | ROM    | PROG  | 1      | 1111 | 1      | 111111    |                      |        |        |
| -32758 | 002012  | JBR         | @...  | 5e00 | RD   | ROM    | PROG  | 1      | 1111 | 1      | 111111    |                      |        |        |
| -32757 | 002014  |             |       | 1160 | RD   | ROM    | PROG  | 1      | 1111 | 1      | 111111    |                      |        |        |
| -32756 | 001168  | STM.L       | [...] | 0120 | RD   | ROM    | PROG  | 1      | 1111 | 1      | 111111    |                      |        | ope... |
| -32755 | ffeef70 |             |       | 0000 | WR   | RAM    | DATA  | 1      | 1111 | 1      | 111111    |                      |        |        |

Figure 5.29 [Trace] Window

This window displays the following trace information items:

[PTR]: Cycle number in the trace buffer. When the most recent record is record 0, earlier record numbers go backwards (-1, -2, ...). If a delay count has been set, the cycle number where the trace stop condition has been satisfied is record 0. For the cycle (during delay) executed until the trace has stopped, earlier record numbers go forward (+1, +2, ...) the most recent record.

[Address]: Address (6-digit hexadecimal)

[Instruction]: Disassembled code of the executed instruction

[Data]: Data bus value, displayed as 2-digit or 4-digit hexadecimal

[R/W]: Whether access was read (RD) or write (WR)

[Area]: Memory area being accessed; ROM, RAM, 8- or 16-bit I/O, 8- or 16-bit EXT (external), or DTC RAM (not available when a time stamp is acquired)



|                         |   |
|-------------------------|---|
| [Status]:               | Bus status during this cycle; DTC operation, PROG (prefetch), Data (CPU data access cycle), Refresh (refresh cycle), or DMAC (DMAC cycle) (not available when a time stamp is acquired)   |
| [Clock]:                | Number of clock cycles in bus cycle as 1 to 8. To indicate more clock cycles, "OVR" is displayed (not available when a time stamp is acquired).   |
| [Probes]:               | A 4-bit binary number showing the four probe pins in the order of Probe 4, Probe 3, Probe 2, and Probe 1 from the left (not available when a time stamp is acquired).   |
| [NMI]:                  | Status of the NMI input (not available when a time stamp is acquired)   |
| [IRQ7-0]:               | Status of eight IRQ inputs (not available when a time stamp is acquired)  |
| [Timestamp]:            | Time stamp of the record. Time stamps start from zero each time the user program is executed. The timer resolution depends on the time stamp clock rate selected in the trace acquisition (only available when a time stamp is acquired).   |
| [Source]:               | Source program  |
| [Label]:                | Label information that corresponds to the address (if defined)  |
| [Timestamp-Difference]: | Displays the difference from the timestamp value shown on the previous line (only available when a time stamp is acquired).   |
| Note:                   | Items other than [PTR], [Address], [Instruction], [Data], [R/W], [Area], [Status], [Probes], [Timestamp], [Source], [Label], and [Timestamp-Difference] vary according to the emulator in use. For details, refer to section 8, Software Specifications Specific to This Product, or the online help. |

It is possible to hide any column not necessary in the [Trace] window. Selecting a column you want to hide from the popup menu displayed by clicking the right-hand mouse button on the header column hides that column. To display the hidden column, select the column from the said popup menu again.

### 5.8.3 Specifying Trace Acquisition Conditions

The capacity of the trace buffer is limited. When the buffer becomes full, the oldest trace information is overwritten. Setting the trace acquisition condition allows acquisition of useful trace information and effective use of the trace buffer. The condition is enabled by the event point to control starting, stopping, and ending the trace acquisition. For event points, refer to section 5.7, Using the Event Points.

The trace acquisition condition is set in the [Trace Acquisition] dialog box that is displayed by selecting [Acquisition...] from the popup menu.

The [Trace Acquisition] dialog box has the following pages:

**Table 5.4 [Trace Acquisition] Dialog Box Pages**

| Page           | Item  |
|----------------|---|
| [General]      | Sets trace acquisition conditions.  |
| [Stop]         | Sets trace stop conditions (without a delay).                               |
| [Delayed Stop] | Sets trace stop conditions (with a delay).                                  |
| [1] to [4]     | Sets the range trace (only available when the free trace mode is disabled). |

(1) [General] page

Sets trace acquisition conditions.

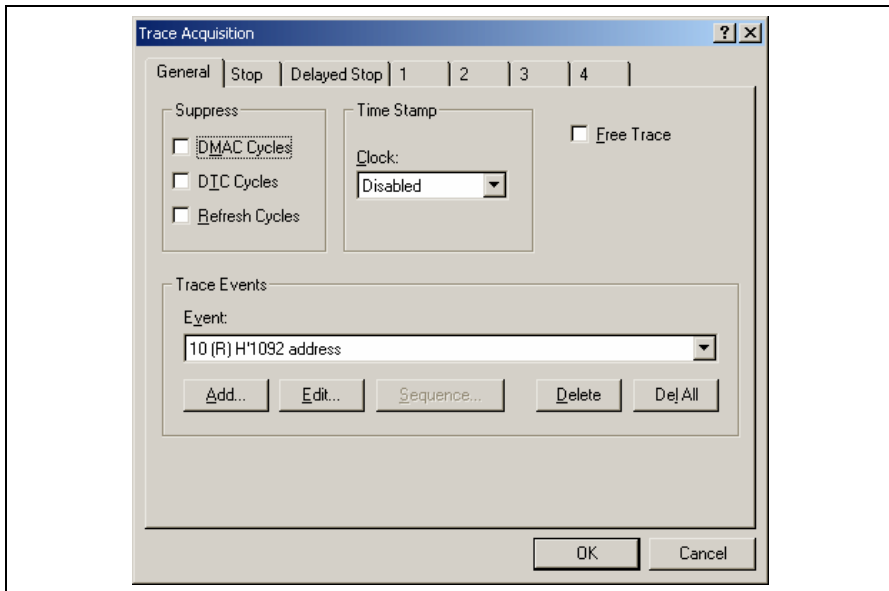

**Figure 5.30 [Trace Acquisition] Dialog Box ([General] Page)**

[Suppress]: Acquires no trace information of the specified types of bus cycle.

[Time Stamp]: Sets a condition for time stamping.

[Clock]: Select either from Disabled, 125 ns, 250 ns, 500 ns, 1 us, 2 us, 4 us, 8 us, 16 us, or 100 us as the resolution for time stamping. A time stamp has a 32-bit counter. At 125 ns the maximum time that can be measured is about 9 minutes, and at 100  $\mu$ s the maximum time is about 5 days.  
When the counter overflows, its content will be cleared to continue counting. No time stamp information will be acquired when Disabled is selected.

[Free Trace]: Checking this box enables the free trace mode.

When the free trace mode is enabled: Starts acquiring the data immediately after program execution has been started. Only the trace halt condition is available. The range trace is unavailable and four range-trace pages (1 to 4) become disabled.

When the free trace mode is disabled: Sets the start and halt conditions of trace acquisition.

[Trace Events]: Sets event points to be used as trace acquisition conditions.

[Event]: Lists the event points to be used as trace acquisition conditions.

[Add...]: Adds a new event point.

[Edit...]: Changes the setting for the selected event point.

[Sequence...]: Configures an event sequence for the event point being used as a trace acquisition condition. To set up the sequence, an event must have been set.

[Delete]: Deletes the selected event point.

[Del All]: Deletes all event points.

- Notes:
1. The bus cycles that can be specified by the [Suppress] option vary according to the emulator in use. For details, refer to section 5.7.4, Signals to Indicate Bus States and Areas.
  2. The trace buffer is used for the time stamp information and some of the trace information. Therefore, when the time stamp is acquired, it is impossible to acquire the trace information other than PTR, Address, Instruction, Data, R/W, Source, Label, Timestamp, and Timestamp-Difference.
  3. If an event that is used for the range trace or trace stop function is deleted, that function becomes disabled.

(2) [Stop] page

Sets trace stop conditions. It is possible to set trace stop conditions with and without delay, with both allowed simultaneously.

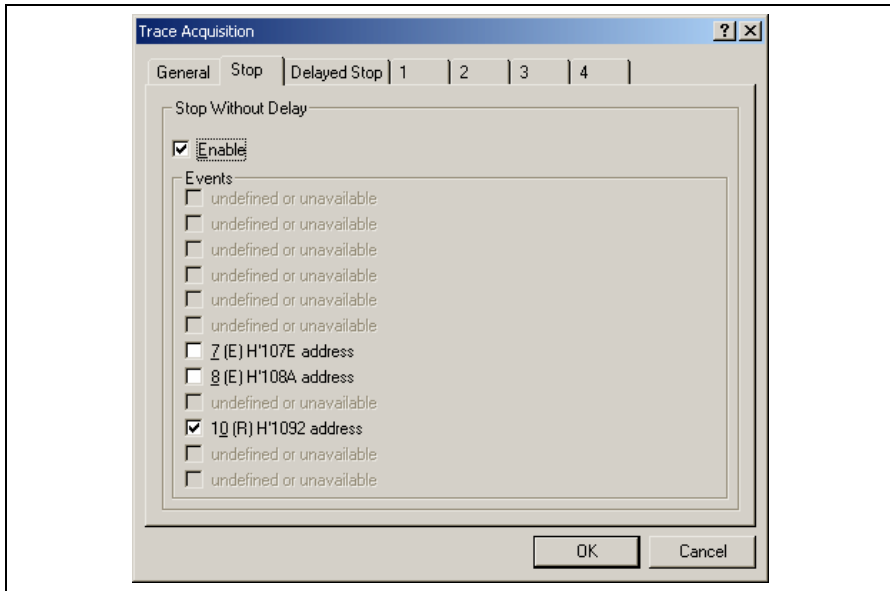

Figure 5.31 [Trace Acquisition] Dialog Box ([Stop] Page)

[Stop Without Delay]: Defines a trace stop condition.

[Enable]: Checking this box enables a trace stop.

[Events]: Lists the event points where trace acquisition conditions have been set. If the box that corresponds to an event point is checked, trace acquisition will be stopped when that event is satisfied (only available when [Enable] has been selected).

(3) [Delayed Stop] page

Sets trace stop conditions. It is possible to set trace stop conditions with and without delay, with both allowed simultaneously.

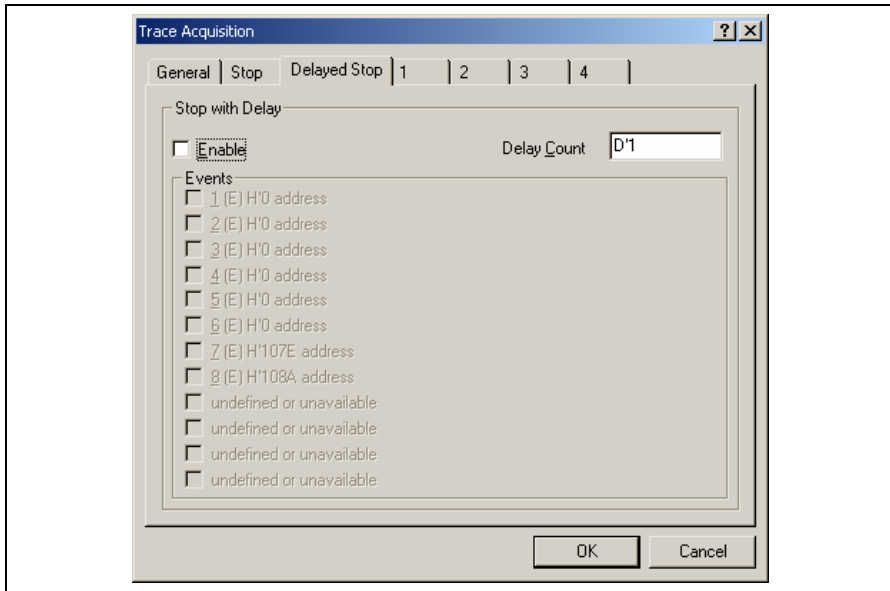

Figure 5.32 [Trace Acquisition] Dialog Box ([Delayed Stop] Page)

[Stop With Delay]: Defines a trace stop condition.

[Enable]: Checking this box enables a trace stop.

[Delay Count]: Sets the delay count (in bus cycles, range 1 to 65535). This function allows you to acquire a number of trace records after any of the specified events occur.

[Events]: Lists the event points where trace acquisition conditions have been set. If the box that corresponds to an event point is checked, trace acquisition will be stopped when that event is satisfied (only available when [Enable] has been selected).

(4) [1] to [4] pages

Sets a range trace. This is only available when the free trace mode is disabled. Select either of the following four modes: [Disabled], [Point to Point], [Range], and [Event].

- Disabled

Disables a range trace.

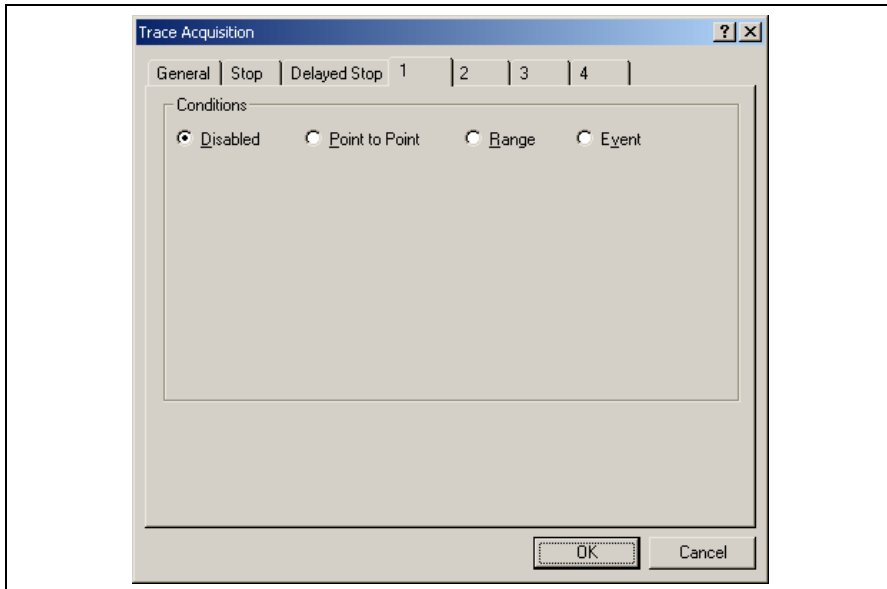
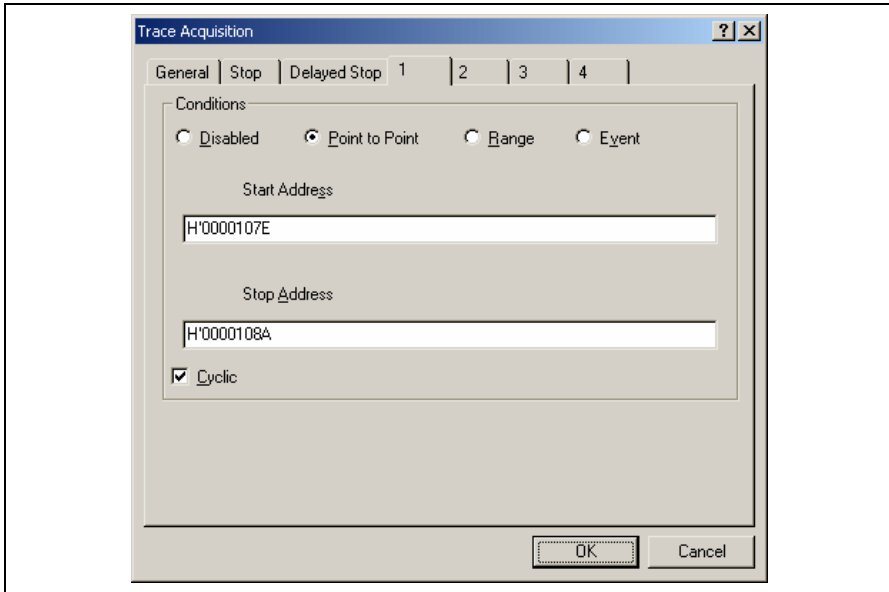

Figure 5.33 Range Trace Setting (Disabled)

- Point to Point

Acquires trace information in the specified range.



**Figure 5.34 Range Trace Setting (Point to Point)**

[Start Address]: Address where trace acquisition starts

[Stop Address]: Address where trace acquisition stops

[Cyclic]: When this box is checked, the event sequencing is configured so that the events reset themselves which causes tracing to be restarted when the start event occurs after the stop event.

Sets the event points that are required to start or stop trace acquisition when the start or end address is accessed, respectively.

Point to Point mode is an easy method to set up the event mode. The event to start or stop trace acquisition is an access to a single address.

Select [Cyclic] to continue acquisition of the trace information only in the specified address range.

Note: This function automatically configures a sequence of event points. Note, however, that an unexpected result may arise. In such cases, modify the setting of the sequence in the [Event Sequencing] dialog box.

- Range

Only acquires the trace information that satisfies the specified condition.

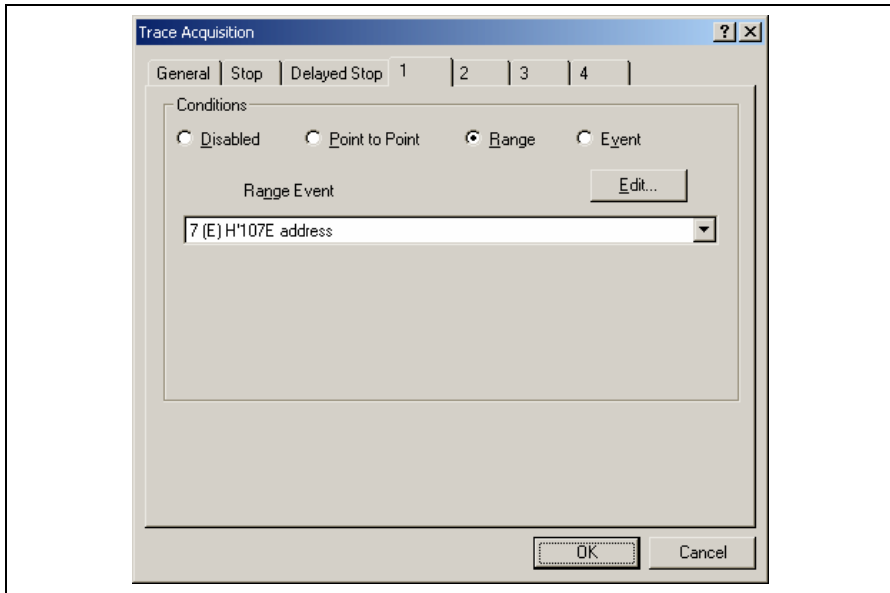

**Figure 5.35 Range Trace Setting (Range)**

[Range Event]: Selects an event point for which a trace acquisition condition has been set.

[Edit...]: Changes the setting for the selected event point.

Only acquires trace information from all bus cycles that matches the condition set in the selected event. This mode uses one event channel or range channel.



- Event

Acquires trace information, controlling the start and end of trace acquisition with the specified condition.

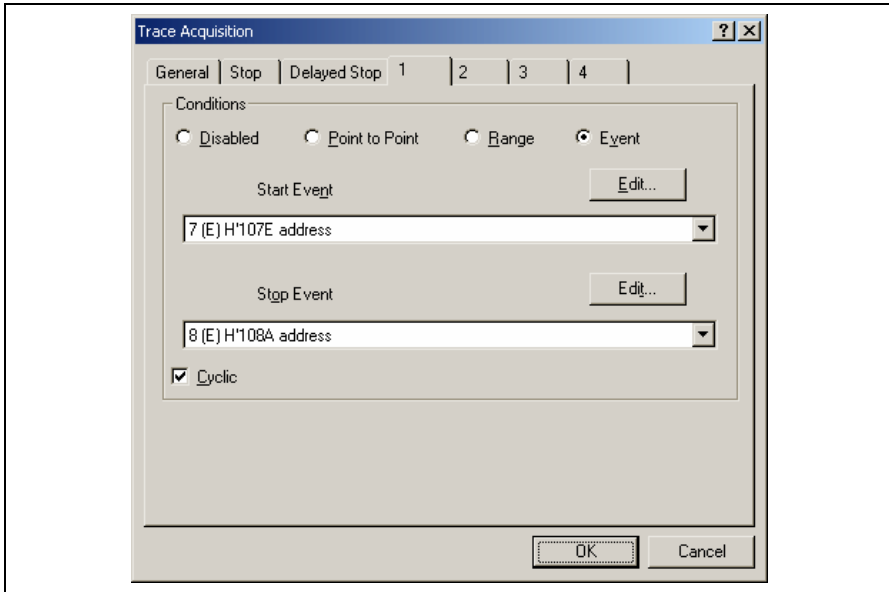

**Figure 5.36 Range Trace Setting (Event)**

- [Start Event]: Selects the event point for which the condition to start trace acquisition has been set.
- [Stop Event]: Selects the event point for which the condition to stop trace acquisition has been set.
- [Edit...]: Changes the setting for the selected event point.
- [Cyclic]: When this box is checked, the event sequencing is configured so that the events reset themselves which causes tracing to be restarted when the start event occurs after the stop event.
- Starts and stops trace acquisition when the conditions for starting and ending are satisfied, respectively. Selecting [Cyclic] allows a continuous acquisition of trace information that can be acquired with the specified condition.

#### 5.8.4 Searching for a Trace Record

Use the [Trace Find] dialog box to search for a trace record. To open this dialog box, choose [Find...] from the popup menu.

The [Trace Find] dialog box has the following options:

**Table 5.5 [Trace Find] Dialog Box Pages**

| Page        | Description  |
|-------------|--|
| [General]   | Sets the range for searching.  |
| [Address]   | Sets an address condition.   |
| [Data]      | Sets a data condition.   |
| [R/W]       | Selects the type of access cycles.   |
| [Area]      | Selects the area being accessed (not available when a time stamp is acquired).                 |
| [Status]    | Selects the status of a bus (not available when a time stamp is acquired).                     |
| [Probes]    | Selects the status of four probe signals (not available when a time stamp is acquired).        |
| [IRQ7-0]    | Selects the status of eight probe input signals (not available when a time stamp is acquired). |
| [Timestamp] | Specify the time stamp value for bus cycles (only available when a time stamp is acquired).    |

Note: Items other than [General], [Address], [Data], [R/W], [Area], [Status], [Probes], and [Timestamp] vary according to the emulator in use. For details, refer to section 8, Software Specifications Specific to This Product or the online help.

Clicking the [OK] button after setting conditions in those pages stores the settings and starts searching. Clicking the [Cancel] button closes this dialog box without setting of conditions.

When a trace record that matches the search conditions is found, the line for the trace record will be highlighted. When no matching trace record is found, a message dialog box will appear.

Only the trace information that satisfies all the conditions set in above pages will be searched.

If a find operation is successful, selecting [Find Next] from the popup menu will move to the next found item.

(1) [General] page

Set the range for searching.

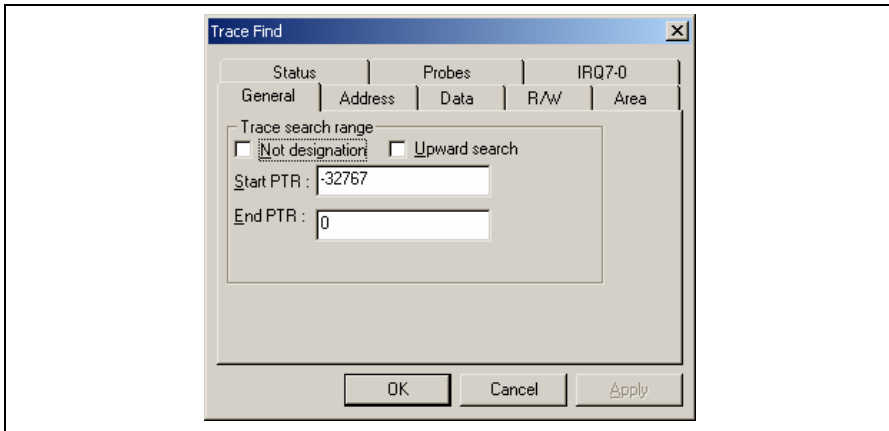

**Figure 5.37 [Trace Find] Dialog Box ([General] Page)**

[Trace search range]: Sets the range for searching.

[Not designation]: Searches for information that does not match the conditions set in other pages when this box is checked.

[Upward search]: Searches upwards when this box is checked.

[Start PTR]: Enters a PTR value to start a search.

[End PTR]: Enters a PTR value to end a search.

Note: Along with setting the range for searching, PTR values to start and end searching can be set in the [Start PTR] and [End PTR] options, respectively.

(2) [Address] page

Set an address condition.

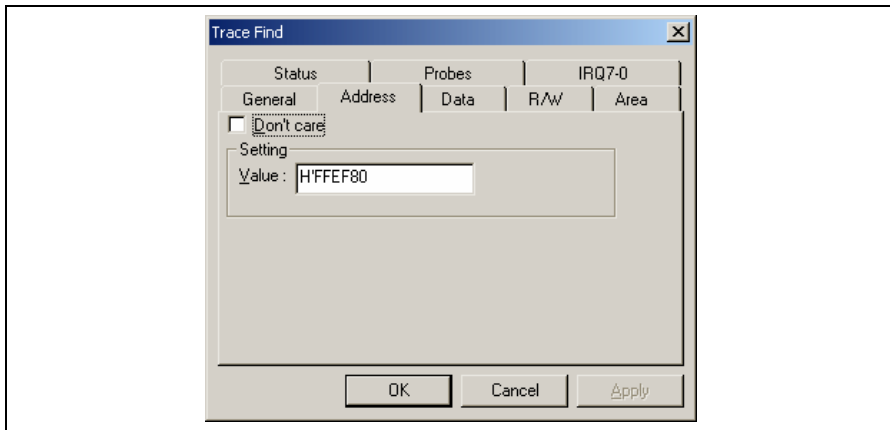

**Figure 5.38 [Trace Find] Dialog Box ([Address] Page)**

[Don't care]: Detects no address when this box is checked.

[Setting]: Detects the specified address.

[Value]: Enter the address value (not available when [Don't care] has been checked).

(3) [Data] page  
Set a data condition.

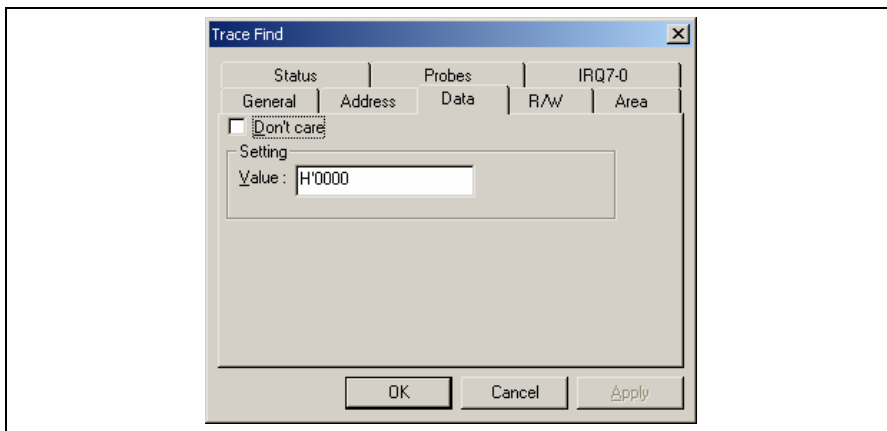

**Figure 5.39 [Trace Find] Dialog Box ([Data] Page)**

[Don't care]: Detects no data when this box is checked.

[Setting]: Detects the specified data.

[Value]: Enter the data value (not available when [Don't care] has been checked).

(4) [R/W] page

Select the type of access cycles.

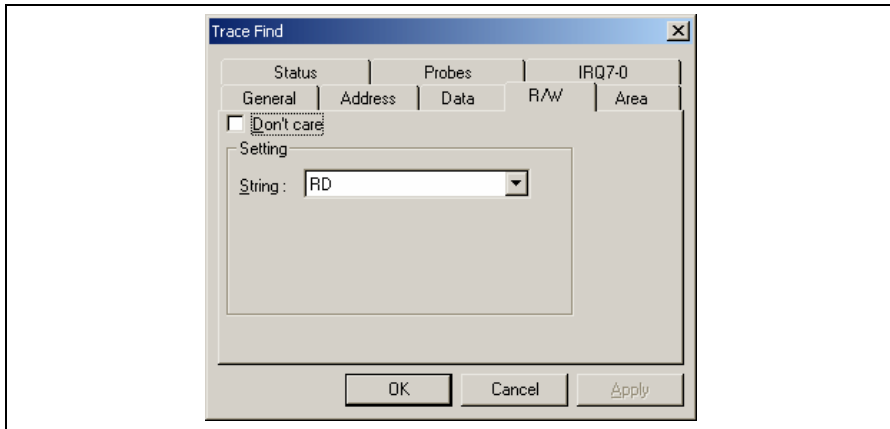

**Figure 5.40 [Trace Find] Dialog Box ([R/W] Page)**

[Don't care]: Detects no read/write condition when this box is checked.

[Setting]: Detects the specified read/write condition.

[String]: Select a read/write condition (not available when [Don't care] has been checked).

RD: Read cycle

WR: Write cycle

(5) [Area] page

Select the area being accessed. The selection is not available when a time stamp is acquired.

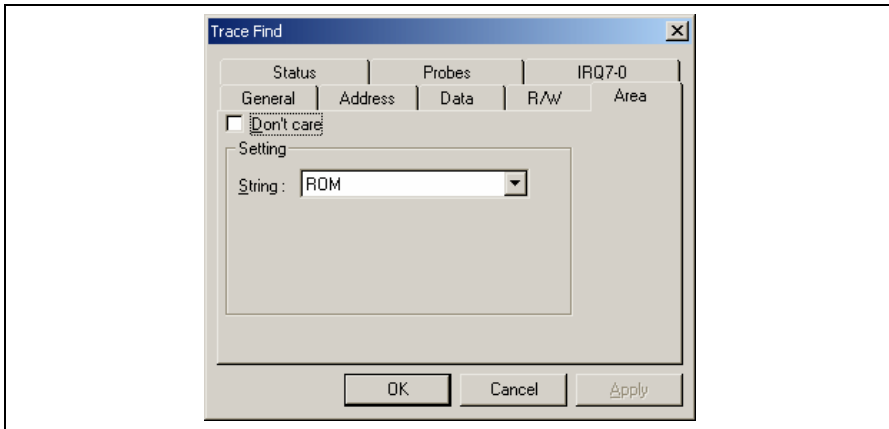

**Figure 5.41 [Trace Find] Dialog Box ([Area] Page)**

[Don't care]: Detects no area condition when this box is checked.

[Setting]: Detects the specified area condition.

[String]: Select an area condition (not available when [Don't care] has been checked).

Note: Available areas vary according to the emulator in use. For details, refer to section 5.7.4, Signals to Indicate Bus States and Areas.

(6) [Status] page

Select the status of a bus. The selection is not available when a time stamp is acquired.

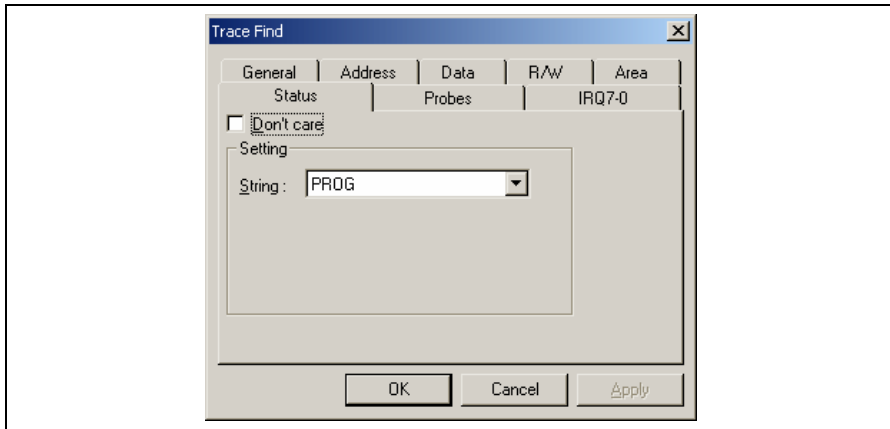

**Figure 5.42 [Trace Find] Dialog Box ([Status] Page)**

[Don't care]: Detects no bus condition when this box is checked.

[Setting]: Detects the specified bus condition.

[String]: Select a bus condition (not available when [Don't care] has been checked).

Note: Available bus conditions vary according to the emulator in use. For details, refer to section 5.7.4, Signals to Indicate Bus States and Areas.



(7) [Probes] page

Select the status of four probe signals. The selection is not available when a time stamp is acquired.

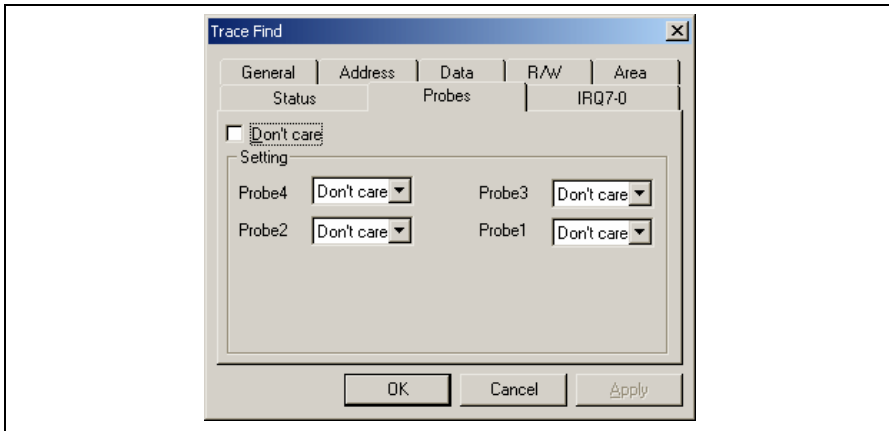

**Figure 5.43 [Trace Find] Dialog Box ([Probes] Page)**

[Don't care]: Detects no probe signal condition when this box is checked.

[Setting]: Detects the specified probe signal condition.

[Probe4] to [Probe1]: Select probe conditions (not available when [Don't care] has been checked).

Don't care: Detects no selected probe condition.

High: The status of the probe signal is high.

Low: The status of the probe signal is low.

(8) [IRQ7-0] page

Select the status of IRQ signals. The selection is not available when a time stamp is acquired.

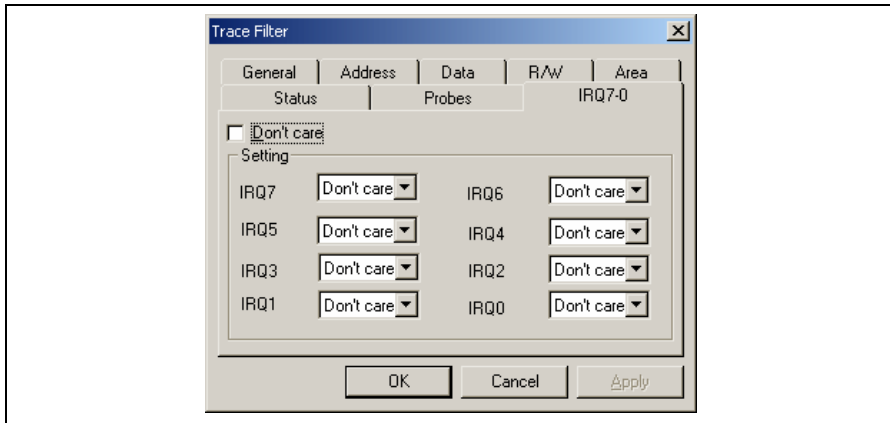

**Figure 5.44 [Trace Find] Dialog Box ([IRQ7-0] Page)**

[Don't care]: Detects no IRQ input condition when this box is checked.

[Setting]: Detects the specified IRQ input condition.

[IRQ7] to [IRQ0]: Select IRQ input conditions (not available when [Don't care] has been checked).

Don't care: Detects no selected IRQ input condition.

High: The status of the IRQ input is high.

Low: The status of the IRQ input is low.

(9) [Timestamp] page

Specify the time stamp value for bus cycles. The specification is not available when a time stamp is acquired.

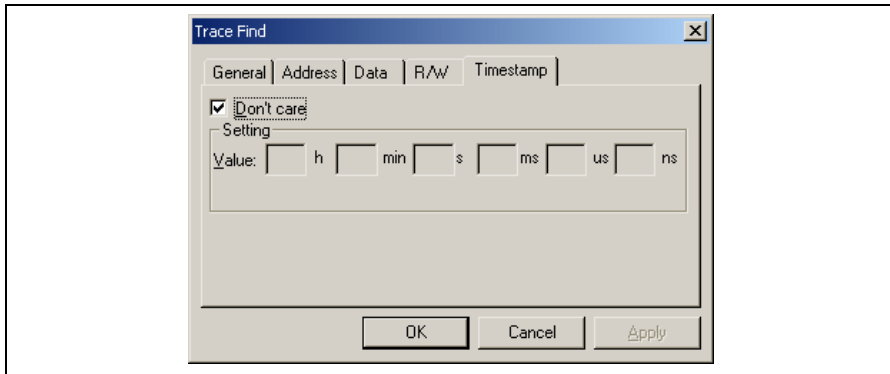

**Figure 5.45 [Trace Find] Dialog Box ([Timestamp] Page)**

[Don't care]: Detects no time stamp value when this box is checked.

[Setting]: Detects the specified time stamp value. (Every field must be filled in.)

[Value]: Enter the time stamp value.

The format is as follows:

hour: h, minute: min, second: s, millisecond: ms, microsecond: us, nanosecond: ns

(Not available when [Don't care] has been checked.)

### 5.8.5 Clearing the Trace Information

Select [Clear] from the popup menu to empty the trace buffer that stores the trace information. If several [Trace] windows are open, all [Trace] windows will be cleared as they all access the same buffer.

### 5.8.6 Saving the Trace Information in a File

Select [Save...] from the popup menu to open the [Save As] file dialog box, which allows the user to save the information displayed in the [Trace] window as a text file. A range can be specified based on the [PTR] number (saving the complete buffer may take several minutes). Note that this file cannot be reloaded into the [Trace] window.

Note: In filtering of trace information, the range to be saved cannot be selected. All the trace information displayed in the [Trace] window after filtering will be saved. Select a filtering range on the [General] page in the [Trace Filter] dialog box if you want to save the selected range. For details on the filtering function, refer to section 5.8.12, Extracting Records from the Acquired Information.

### 5.8.7 Viewing the [Editor] Window

The [Editor] window corresponding to the selected trace record can be displayed in the following two ways:

- Select a trace record and choose [View Source] from the popup menu.
- Double-click a trace record

The [Editor] or [Disassembly] window opens and the selected line is marked with a cursor.

### 5.8.8 Trimming the Source

Choose [Trim Source] from the popup menu to remove the white space from the left side of the source.

When the white space is removed, a check mark is shown to the left of the [Trim Source] menu. To restore the white space, choose [Trim Source] while the check mark is shown.

### 5.8.9 Acquiring a Snapshot of the Trace Information

A snapshot can be acquired when you need to check the trace information during execution of the user program. This is useful for checking time stamping or probe input signals. To acquire a snapshot of trace information, select [Snapshot] from the popup menu. Trace acquisition is temporarily stopped to display a record of the latest trace information, and then restarted. A snapshot of trace information is only acquired during execution of the user program.

### 5.8.10 Temporarily Stopping Trace Acquisition

To temporarily stop trace acquisition during execution of the user program, select [Halt] from the popup menu. This stops trace acquisition and updates the trace display. Use this method to check the trace information without stopping execution of the user program.

### 5.8.11 Restarting Trace Acquisition

To restart trace acquisition being stopped during execution of the user program, select [Restart] from the popup menu.

### 5.8.12 Extracting Records from the Acquired Information

Use the filtering function to extract the records you need from the acquired trace information. The filtering function allows the trace information acquired by hardware to be filtered by software. Unlike the settings made in the [Trace Acquisition] dialog box for acquiring trace information by conditions, changing the settings for filtering several times to filter the acquired trace information allows easy extraction of necessary information, which is useful for analysis of data. The content of the trace buffer will not be changed even when the filtering function is used. Acquiring useful information as much as possible by the [Trace Acquisition] settings improves the efficiency in analysis of data because the capacity of the trace buffer is limited.

Use the filtering function in the [Trace Filter] dialog box. To open the [Trace Filter] dialog box, select [Filter...] from the popup menu.

The [Trace Filter] dialog box has the following pages:

**Table 5.6 [Trace Filter] Dialog Box Pages**

| Page        | Description   |
|-------------|---|
| [General]   | Selects the range for filtering.  |
| [Address]   | Sets address conditions.  |
| [Data]      | Sets data conditions.   |
| [R/W]       | Selects the type of access cycles.  |
| [Area]      | Selects the area being accessed (not available when a time stamp is acquired).                |
| [Status]    | Sets the status of a bus (not available when a time stamp is acquired).                       |
| [Probes]    | Selects the states of four probe signals (not available when a time stamp is acquired).       |
| [IRQ7-0]    | Selects the states of eight IRQ input signals (not available when a time stamp is acquired).  |
| [Timestamp] | Specifies the time stamp value for bus cycles (only available when a time stamp is acquired). |

Note: Items other than [General], [Address], [Data], [R/W], [Area], [Status], [Probes], and [Timestamp] vary according to the emulator in use. For details, refer to section 8, Software Specifications Specific to This Product or the online help.

Set filtering conditions and then press the [OK] button. This starts filtering according to the conditions. Clicking the [Cancel] button closes the [Trace Filter] dialog box, which holds the settings at the time when the dialog box was opened.

In filtering, only the trace information that satisfies one or more filtering conditions set in the above pages will be displayed in the [Trace] window.

Filtering conditions can be changed several times to analyze data because the content of the trace buffer is not changed by filtering.

(1) [General] page

Set the range for filtering.

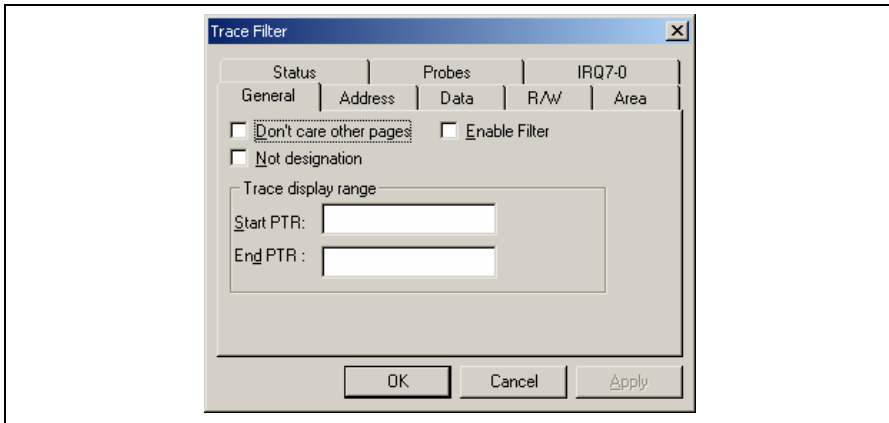

**Figure 5.46 [Trace Filter] Dialog Box ([General] Page)**

[Don't care other pages]: Only selects the cycle number when this box is checked. Other options become invalid.

[Enable Filter]: Enables the filter when this box is checked.

[No]: Filters information that does not match the conditions set in those pages when this box is checked.

[Trace display range]: Sets the range for filtering.

[Start PTR]: Enters a PTR value to start filtering.

[End PTR]: Enters a PTR value to end filtering.

Note: Along with setting the range for filtering, PTR values to start and end filtering can be set in the [Start PTR] and [End PTR] options, respectively.

(2) [Address] page  
Set address conditions.

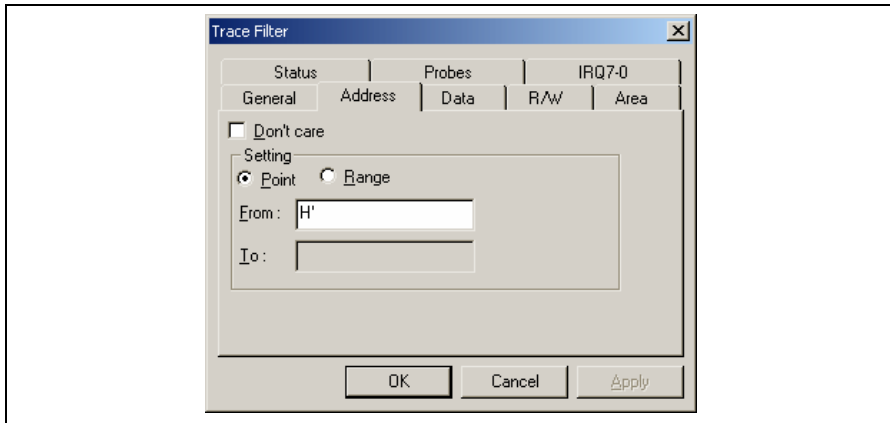

**Figure 5.47 [Trace Filter] Dialog Box ([Address] Page)**

[Don't care]: Detects no address when this box is checked.

[Setting]: Detects the specified address.

[Point]: Specifies a single address (not available when [Don't care] has been checked).

[Range]: Specifies an address range (not available when [Don't care] has been checked).

[From]: Enter a single address or the start of the address range (not available when [Don't care] has been checked).

[To]: Enter a single address or the end of the address range (only available when [Range] has been selected).

Note: Along with setting the address range, the start and end of the address range can be set in the [From] and [To] options, respectively.

(3) [Data] page  
Set a data condition.

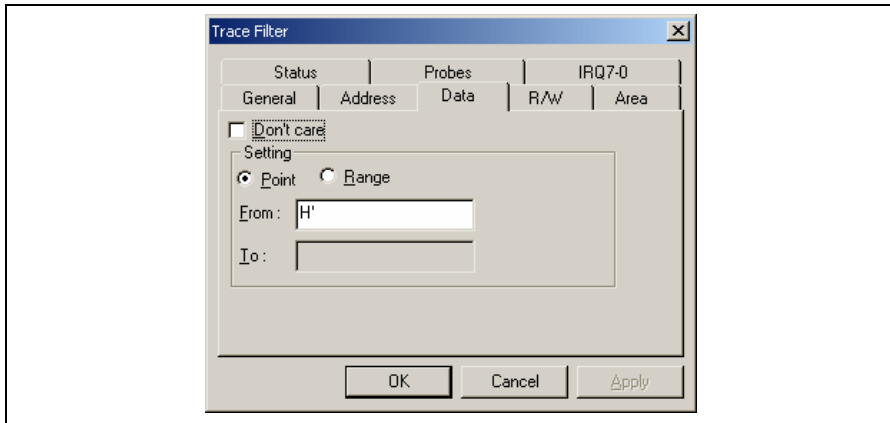

**Figure 5.48 [Trace Filter] Dialog Box ([Data] Page)**

[Don't care]: Detects no data when this box is checked.

[Setting]: Detects the specified data.

[Point]: Specifies single data (not available when [Don't care] has been checked).

[Range]: Specifies a data range (not available when [Don't care] has been checked).

[From]: Enter single data or the minimum value of the data range (not available when [Don't care] has been checked).

[To]: Enter the maximum value of the data range (only available when [Range] has been selected).

Note: Along with setting the data range, the minimum and maximum values can be set in the [From] and [To] options, respectively.



(4) [R/W] page

Select the type of access cycles.

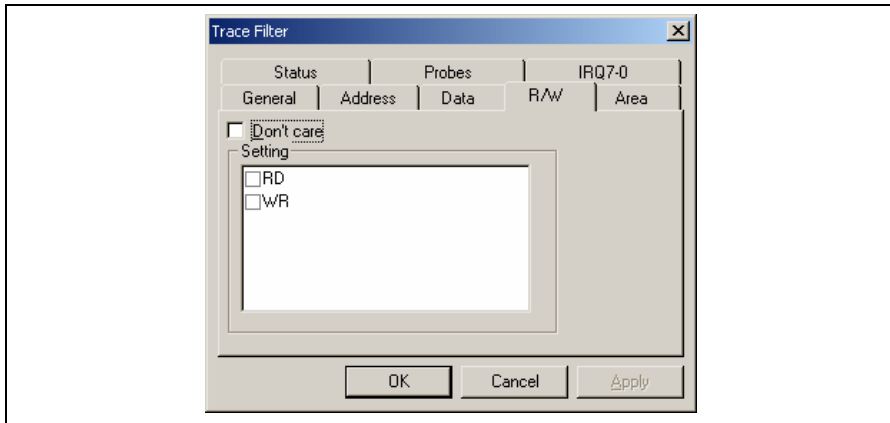

**Figure 5.49 [Trace Filter] Dialog Box ([R/W] Page)**

[Don't care]: Detects no read/write condition when this box is checked.

[Setting]: Detects the specified read/write condition.

RD: Detects read cycles when this box is checked (not available when [Don't care] has been checked).

WR: Detects write cycles when this box is checked (not available when [Don't care] has been checked).

(5) [Area] page

Select the area being accessed. The selection is not available when a time stamp is acquired.

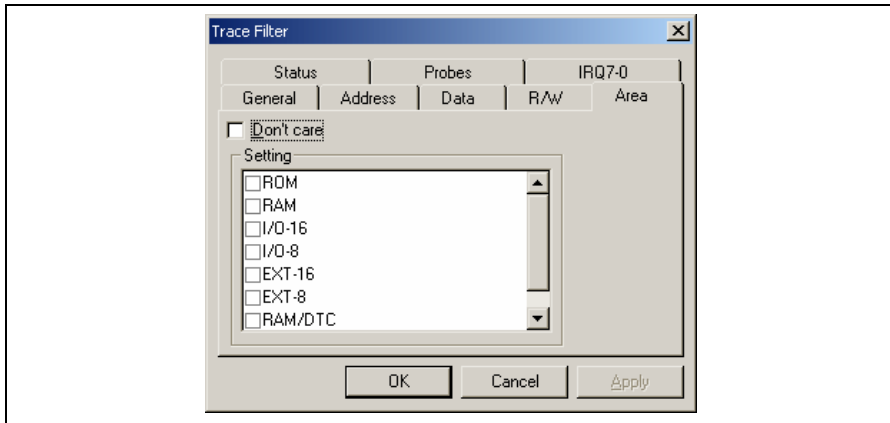

**Figure 5.50 [Trace Filter] Dialog Box ([Area] Page)**

[Don't care]: Detects no area condition when this box is checked.

[Setting]: Detects the specified area condition (not available when [Don't care] has been checked).

Note: Available area conditions vary according to the emulator in use. For details, refer to section 5.7.4, Signals to Indicate Bus States and Areas.

(6) [Status] page

Select the status of a bus. The selection is not available when a time stamp is acquired.

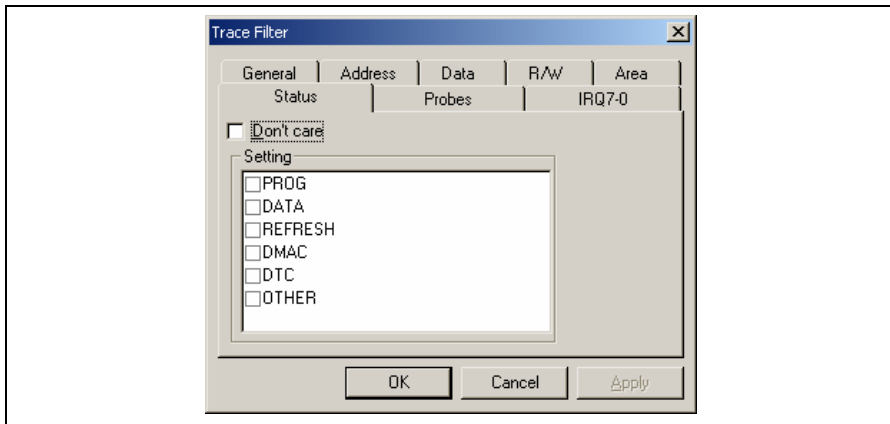

**Figure 5.51 [Trace Filter] Dialog Box ([Status] Page)**

[Don't care]: Detects no bus condition when this box is checked.

[Setting]: Detects the specified bus condition (not available when [Don't care] has been checked).

Note: Available bus conditions vary according to the emulator in use. For details, refer to section 5.7.4, Signals to Indicate Bus States and Areas.

(7) [Probes] page

Select the status of four probe signals. The selection is not available when a time stamp is acquired.

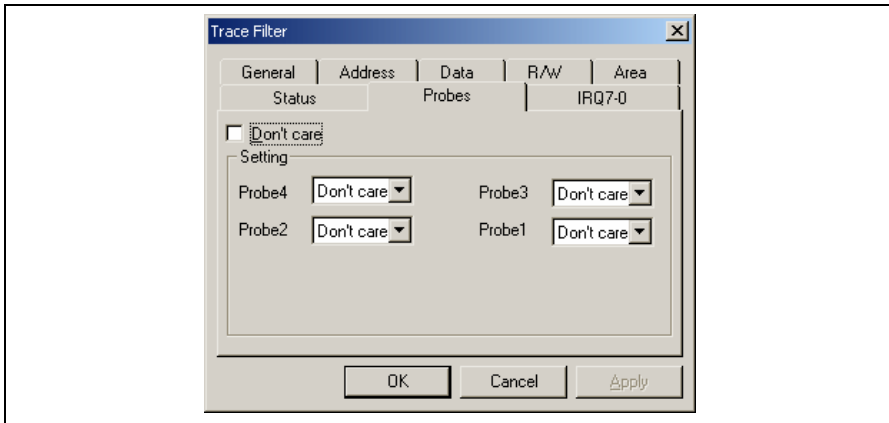

Figure 5.52 [Trace Filter] Dialog Box ([Probes] Page)

[Don't care]: Detects no probe signal condition when this box is checked.

[Setting]: Detects the specified probe signal condition.

[Probe4] to [Probe1]: Select probe conditions (not available when [Don't care] has been checked).

Don't care: Detects no selected probe condition.

High: The status of the probe signal is high.

Low: The status of the probe signal is low.

(8) [IRQ7-0] page

Select the status of IRQ signals. The selection is not available when a time stamp is acquired.

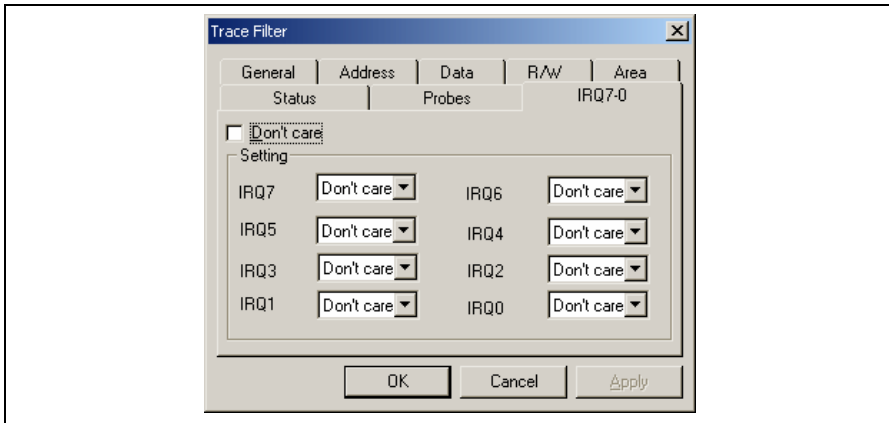

**Figure 5.53 [Trace Filter] Dialog Box ([IRQ7-0] Page)**

[Don't care]: Detects no IRQ input condition when this box is checked.

[Setting]: Detects the specified IRQ input condition.

[IRQ7] to [IRQ0]: Select IRQ input conditions (not available when [Don't care] has been checked).

Don't care: Detects no selected IRQ input condition.

High: The status of the IRQ input is high.

Low: The status of the IRQ input is low.

(9) [Timestamp] page

Specify the time stamp value for bus cycles. The specification is not available when a time stamp is acquired.

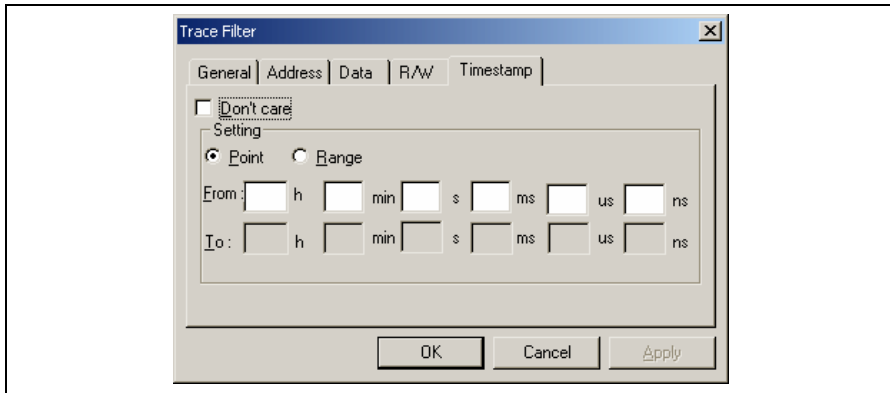

**Figure 5.54 [Trace Filter] Dialog Box ([Timestamp] Page)**

[Don't care]: Detects no time stamp value when this box is checked.

[Setting]: Detects the specified time stamp value.

[Point]: Specifies a single time stamp (not available when [Don't care] has been checked).

[Range]: Specifies a time stamp range (not available when [Don't care] has been checked).

[From]: Enter a single time stamp value or the minimum value of the time stamp range.  
The format is as follows:  
hour: h, minute: min, second: s, millisecond: ms, microsecond: us, nanosecond: ns  
(Not available when [Don't care] has been checked.)

[To]: Enter the maximum value of the time stamp range.  
The format is as follows:  
hour: h, minute: min, second: s, millisecond: ms, microsecond: us, nanosecond: ns  
(Only available when [Range] has been selected.)

Note: Along with setting the time stamp range, the minimum and maximum time stamp values can be set in the [From] and [To] options, respectively.

### 5.8.13 Calculating the Difference in Time Stamping

Select [Timestamp Difference...] from the popup menu to calculate the time difference between the two points selected by the result of tracing in acquisition of time stamp information.

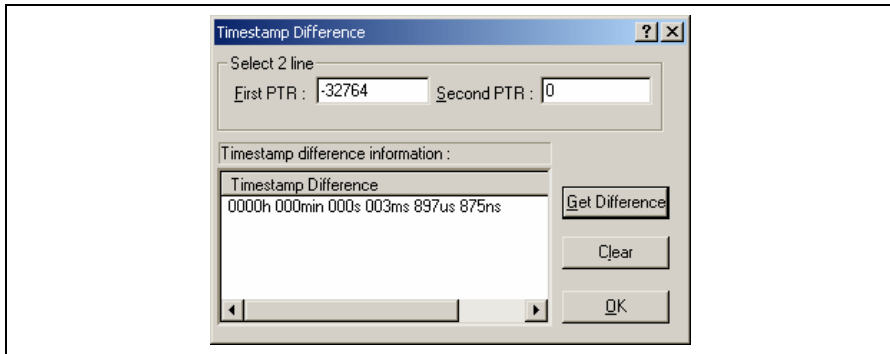

**Figure 5.55 [Timestamp Difference] Dialog Box**

- [Select 2 line]: Select trace records to calculate the time stamp difference.
- [First PTR]: Specifies the first pointer to measure the difference. The pointer of the line selected on the Trace window is displayed by default.
- [Second PTR]: Specifies the second pointer to measure the difference.
- [Timestamp Difference]: Displays the results of calculation.
- [Get Difference]: Calculates the difference between the specified two points and display its result in the [Timestamp Difference] list.
- [Clear]: Clears all the results in the [Timestamp Difference] list.
- [OK]: Closes the dialog box. All the results in the [Timestamp Difference] list are cleared.

#### 5.8.14 Analyzing Statistical Information

Choose [Statistic] from the popup menu to open the [Statistic] dialog box and analyze statistical information under the specified conditions.

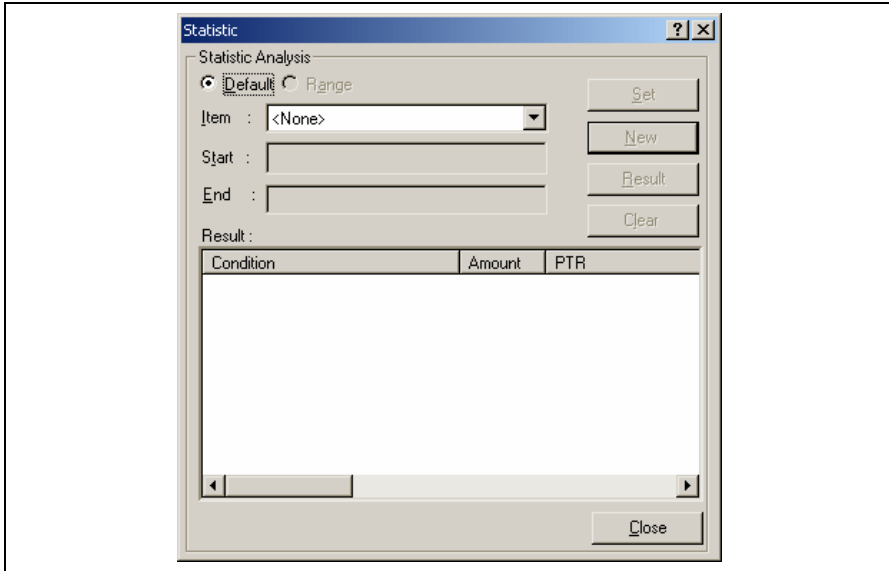

Figure 5.56 [Statistic] Dialog Box

- [Statistic Analysis]: Setting required for analysis of statistical information.
- [Default]: Sets a single input value or character string.
- [Range]: Sets the input value or character string as a range.
- [Item]: Sets the item for analysis.
- [Start]: Sets the input value or character string. To set a range, the start value must be specified here.
- [End]: Specify the end value if a range has been set (only available when [Range] has been selected).
- [Set]: Adds a new condition to the current one.
- [New]: Creates a new condition.
- [Result]: Obtains the result of statistical information analysis.
- [Clear]: Clears all conditions and results of statistical information analysis.
- [Close]: Closes this dialog box. All the results displayed in the [Result] list will be cleared.



This dialog box allows the user to analyze statistical information concerning the trace information. Set the target of analysis in [Item] and the input value or character string by [Start] and [End]. Click the [Result] button after setting a condition by pressing the [New] or [Add] button to analyze the statistical information and display its result in the [Result] list.

Note: In this emulator, only [PTR] can be set as a range. Each of other items must be specified as a character string. In analysis of statistical information, character strings are compared with those displayed in the [Trace] window. Only those that completely match are counted. Note, however, that this test is not case sensitive. The number of blanks will not be cared either.

### 5.8.15 Extracting Function Calls from the Acquired Trace Information

To extract function calls from the acquired trace information, select [Function Call...] from the popup menu. The [Function Call Display] dialog box will be displayed.

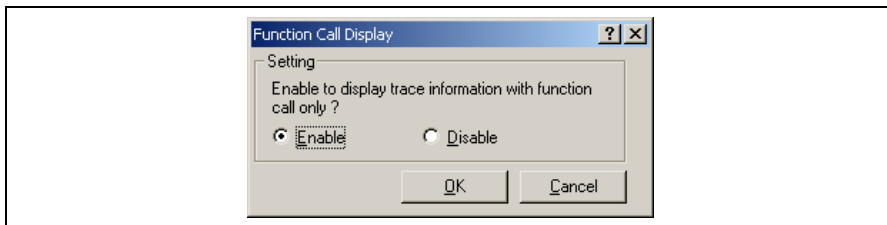

Figure 5.57 [Function Call Display] Dialog Box

[Setting]: Selects whether or not to extract function calls.

[Enable]: Extracts function calls.

[Disable]: Does not extract function calls.

When [Enable] is selected, only the cycles that include function calls are extracted for display from the acquired trace information. The content of the trace buffer is not changed by extraction of function calls. Using this function for the result of the free trace or the trace information that includes function calls allows the user to know the order of function calls.

## 5.9 Analyzing Performance

Use the performance analysis function to measure the rate of execution time. The performance analysis function does not affect the realtime operation because it measures the rate of execution time in the specified range by using the circuit for measurement of hardware performance included in the emulator.

Select either of the following five modes according to the purpose of measurement.

**Table 5.7 Available Measurement Modes**

| <b>Mode</b>                                 | <b>Description</b>   | <b>Purpose</b>   |
|---|--|--|
| Time Of Specified Range Measurement         | Measures the execution time and execution count in the specified range.                  | Measurement of time taken for processing of functions except for that required for child functions called from the functions.  |
| Start Point To End Point Measurement        | Measures the execution time and execution count between the specified addresses.         | Measurement of time taken for processing of functions.   |
| Start Range To End Range Measurement        | Measures the execution time from a specified range to another specified range.           | Measurement of execution time spent from calling of any of sequential subroutines to calling of any of another sequential subroutines in a program that includes subroutines in sequence, such as an assembly program. |
| Access Count Of Specified Range Measurement | Measures the number of times a specified range is accessed from another specified range. | Measurement of the number of times a global variable is accessed from a specific function.   |
| Called Count Of Specified Range Measurement | Measures the number of times a specified range has called another specified range.       | Measurement of the number of times a function is called from a specific function.  |

Use eight performance channels installed on the circuit for measurement of hardware performance in the emulator for setting of conditions for measurement. Up to eight points can be set.

Note, however, that up to four points can be set in Start Range To End Range Measurement, Access Count Of Specified Range Measurement, or Called Count Of Specified Range Measurement because two sequential points are used for setting a condition in these modes.

**Table 5.8 Mode Settings for Measurement**

| Page  | Point |   |   |   |   |   |   |   |
|---|-------|---|---|---|---|---|---|---|
|   | 1     | 2 | 3 | 4 | 5 | 6 | 7 | 8 |
| Time Of Specified Range Measurement         | 0     | 0 | 0 | 0 | 0 | 0 | 0 | 0 |
| Start Point To End Point Measurement        | 0     | 0 | 0 | 0 | 0 | 0 | 0 | 0 |
| Start Range To End Range Measurement        | 0     | — | 0 | — | 0 | — | 0 | — |
| Access Count Of Specified Range Measurement | 0     | — | 0 | — | 0 | — | 0 | — |
| Called Count Of Specified Range Measurement | 0     | — | 0 | — | 0 | — | 0 | — |

Note: 0: Available  
 —: Not available

Note: Only one point is used in Time Of Specified Range Measurement and Start Point To End Point Measurement, while two sequential points are used in Start Range To End Range Measurement, Access Count Of Specified Range Measurement, and Called Count Of Specified Range Measurement. The conditions that have been set will be canceled when switching these modes of different types.

### 5.9.1 Opening the [Performance Analysis] Window

Choose [View -> Performance -> Performance Analysis] or click the [PA] toolbar button  to open the [Select Performance Analysis Type] dialog box.

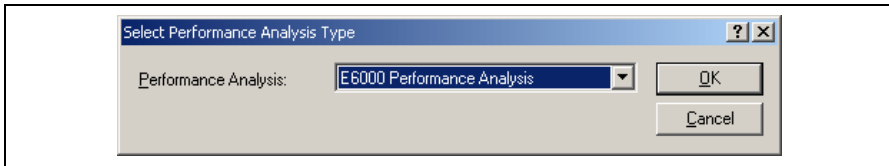

**Figure 5.58 [Select Performance Analysis Type] Window**

Select [E6000 Performance Analysis] and then click the [OK] button to open the [Performance Analysis] window.

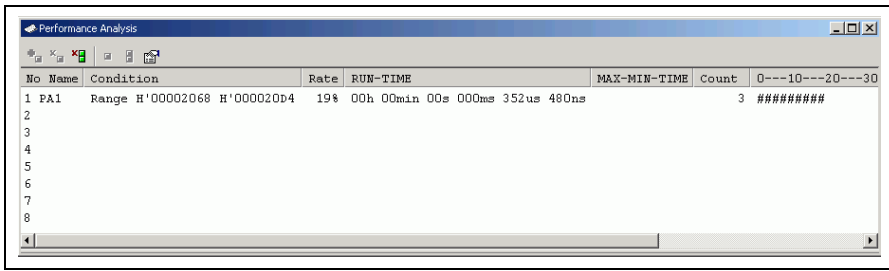

**Figure 5.59 [Performance Analysis] Window**

This window displays the rate of execution time in the area selected by the user during the last program run in percentages, histogram, or numerical values.

It is possible to hide any column not necessary in the [Performance Analysis] window. Selecting a column you want to hide from the popup menu displayed by clicking the right-hand mouse button on the header column hides that column. To display the hidden column, select the column from the said popup menu again.

## 5.9.2 Setting Conditions for Measurement

Conditions for measurement can be displayed and changed in the [Performance Analysis] window. Select a point where a condition is to be set, and then select [Set...] from the popup menu to display the [Performance Analysis Properties] dialog box.

Select either from the following five modes as the condition by the [Measurement Method] option:

**Table 5.9 Conditions for Measurement (Measurement Method)**

| [Measurement Method] Option                 |
|---|
| Time Of Specified Range Measurement         |
| Start Point To End Point Measurement        |
| Start Range To End Range Measurement        |
| Access Count Of Specified Range Measurement |
| Called Count Of Specified Range Measurement |

Set a condition for measurement according to the mode being selected. The parameters to be set depend on the modes.

The [Performance Analysis] window has a support function to enter the address range of a function automatically if the name of the function is entered to set an address range. Entering a function name in the [Input Function Range] dialog box displayed by clicking the [...] button on the [Performance Analysis Properties] dialog box automatically enters the address range of the function.

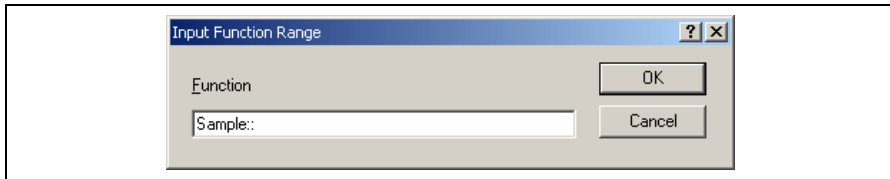

**Figure 5.60 [Input Function Range] Window**

- Notes:
1. Entering the name of an overload function or a class opens the [Select Function] dialog box. Select a function in this dialog box.
  2. The addresses figured out are just for reference. In some cases, the end address of a function may be different. Check the last instruction of the function in the [Disassembly] window to correct the value set in [End Address] so that it will be the address of the last instruction (in general, the last instruction of a function is a RTS instruction). A label name or an expression can be entered instead of an address value in boxes where an address should be entered.

(1) Time Of Specified Range Measurement

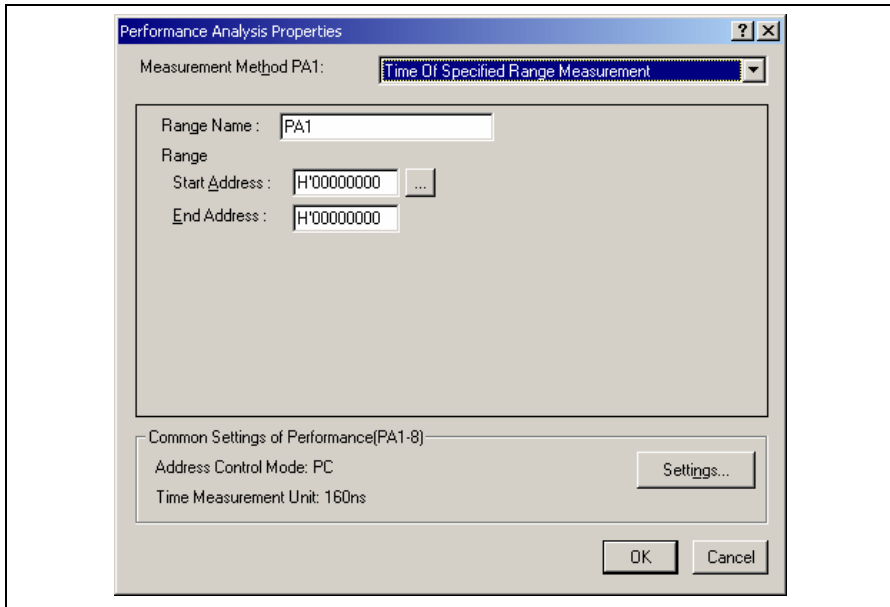
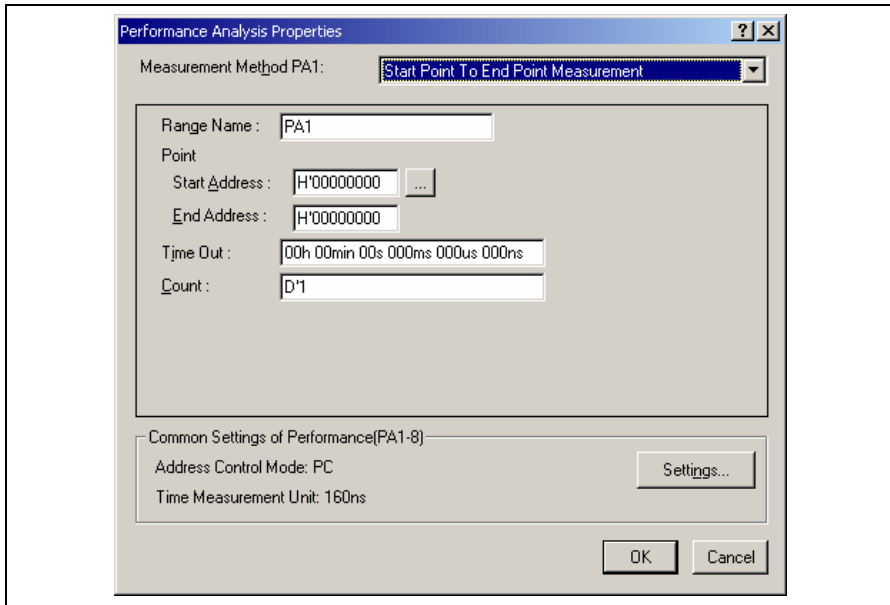

**Figure 5.61 Time Of Specified Range Settings**

- [Range Name]: The name of the range to be measured
- [Range]: The range for the Time Of Specified Range Measurement
- [Start Address]: Address to start measurement
- [End Address]: Address to end measurement

Measures the execution time and the execution count in the range between the start address and end address. Starts measurement with a detected program prefetch in the range specified between the start and end addresses, and then stops with a detected program prefetch out of the specified range. Measurement can be restarted with a detected program prefetch in the specified range. The execution count is incremented every time the program is prefetched at the end address of the specified range. The execution time measured does not include the time spent while being called from the specified range.

## (2) Start Point To End Point Measurement



**Figure 5.62 Start Point To End Point Measurement Settings**

[Range Name]: The name of the range to be measured

[Point]: The range for the Start Point To End Point Measurement

[Start Address]: Address to start measurement

[End Address]: Address to end measurement

[Time Out]: The timeout value to finish measurement. When the minimum time for measurement is 160 ns, 40 ns, or 20 ns, enter the value as follows.  
Example: 1h 2min 3s 123ms 456us 789ns

If the CPU operating mode is target, enter a hexadecimal number in 10 digits.  
Example: 123456789A

A break occurs every time a value measured in the specified range exceeds the timeout value (not the total time). This is only available for channel 1.

[Count]: The count-up value used in measurement of the execution count. A break occurs every time the execution count exceeds the count-up value. This is only available for channel 1.

Measures the execution time and the execution count in the range between start address and end address. Starts measurement with a detected program prefetch at the start address, and then stops with a detected program prefetch at the end address. The execution count is incremented every time the program is prefetched at the end address of the specified range. The execution time measured includes the time spent while being called from the specified range. When either from one to four points is selected, the maximum and minimum time in the specified range can be measured.

- Notes:
1. When [Time Out] is selected in the Start Point To End Point Measurement mode, the execution time will not be measured correctly.
  2. When [Time Out] and [Count] are selected, satisfaction of either of these options stops execution of the user program (performance break).
  3. Only channel 1 can be used for [Time Out] and [Count]. Use other channels if you do not want to select [Time Out] or [Count] in the Start Point To End Point Measurement mode.



(3) Start Range To End Range Measurement

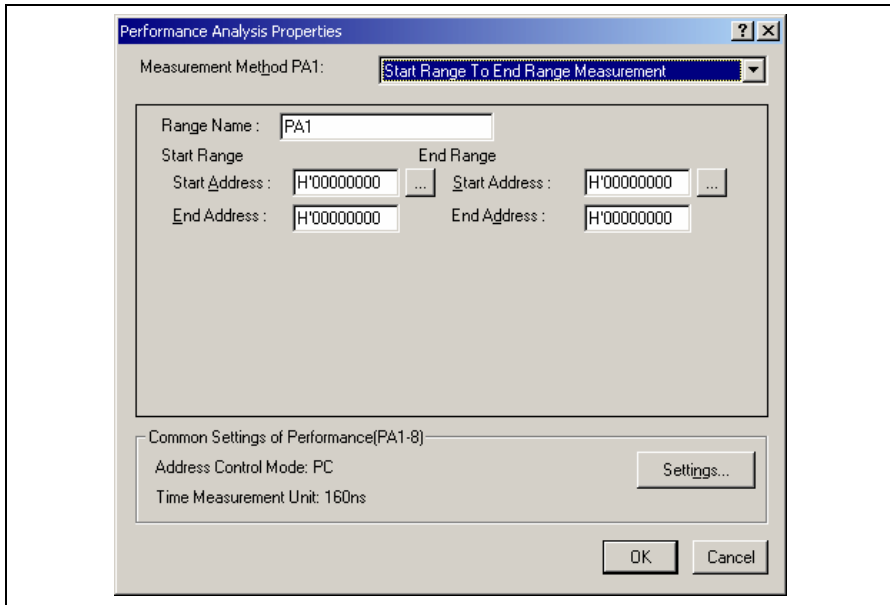
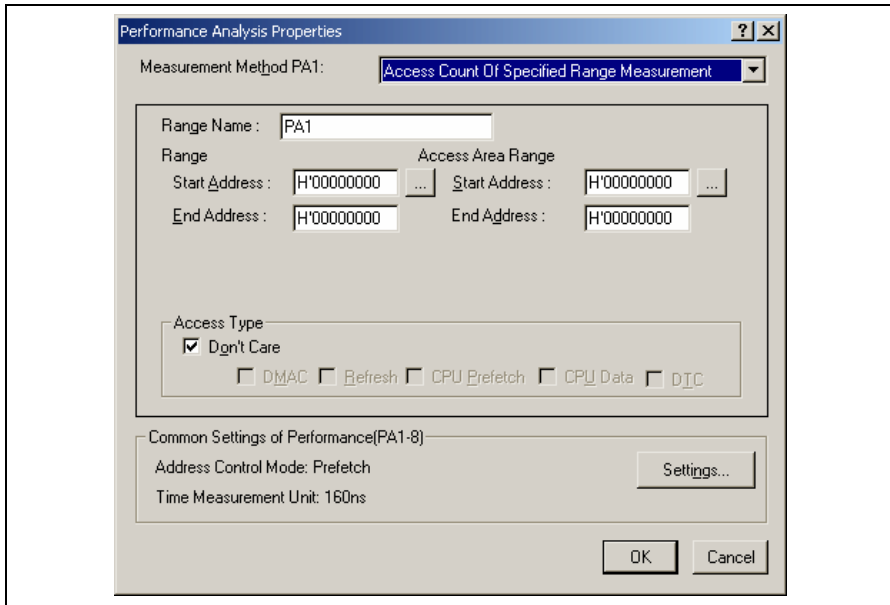

**Figure 5.63 Start Range To End Range Measurement Settings**

- [Range Name]: The name of the range to be measured
- [Start Range]: The start range for the Start Range To End Range Measurement
- [Start Address]: Start address
- [End Address]: End address
- [End Range]: The end range for the Start Range To End Range Measurement
- [Start Address]: Start address
- [End Address]: End address

Starts measurement with a detected prefetch cycle in the specified start address range, and then stops with a detected prefetch cycle in the specified end address range. The execution count is incremented every time the program passes the end address range.

#### (4) Access Count Of Specified Range Measurement



**Figure 5.64 Access Count Of Specified Range Measurement Settings**

[Range Name]: The name of the range to be measured

[Range]: The range for the Access Count Of Specified Range Measurement

[Start Address]: Start address

[End Address]: End address

[Access Area Range]: The access range for the Access Count Of Specified Range Measurement

[Start Address]: Start address

[End Address]: End address

[Access Type]: The bus cycle on the access range to be measured

Measures the number of times the range specified as the access range is accessed from the range specified by the start and end addresses. The execution count in the range is measured with Time Of Specified Range Measurement mode.

Note: Available bus cycle conditions vary according to the emulator in use. For details, refer to section 5.7.4, Signals to Indicate Bus States and Areas.

(5) Called Count Of Specified Range Measurement

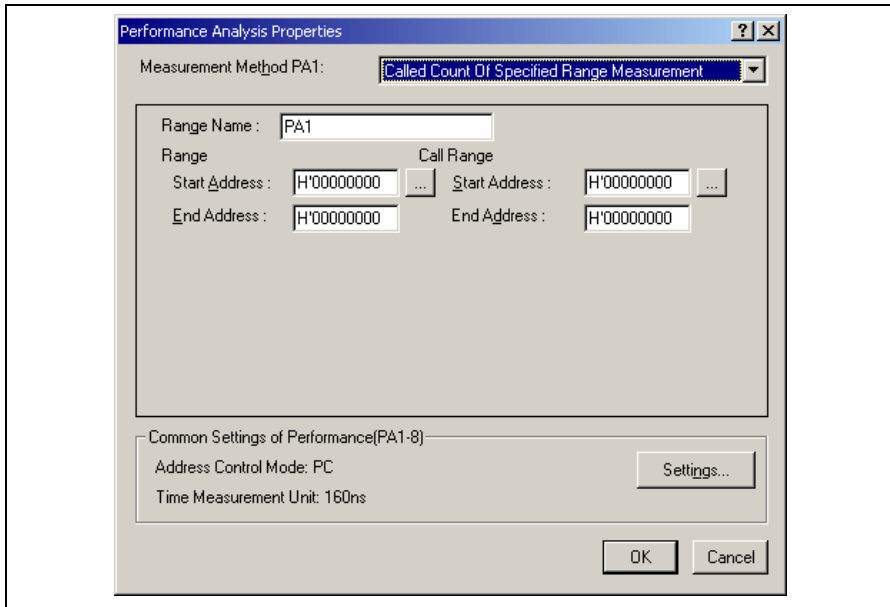

**Figure 5.65 Called Count Of Specified Range Measurement Settings**

[Range Name]: The name of the range to be measured

[Range]: The range for the Called Count Of Specified Range Measurement

[Start Address]: Start address

[End Address]: End address

[Call Range]: The range for the Called Count Of Specified Range Measurement. As the call range, specify the start and end addresses of the selected subroutine.

[Start Address]: Start address

[End Address]: End address

Measures the number of times the range specified as the call range is called from the range specified by the start and end addresses. The execution time in the specified range can be measured with Time Of Specified Range Measurement mode. As the call range, specify the start and end addresses of the selected subroutine.

### 5.9.3 Selecting the Address Detection Mode and Resolution

In measurement of hardware performance, there are two types of address detection modes: prefetch address detection mode and PC address detection mode. Select the appropriate address detection mode according to the measurement mode in use. The resolution can also be selected here.

To select an address detection mode and resolution, click the [Settings...] button on the [Performance Analysis Properties] dialog box. The [Common Settings of Performance(PA1-8)] dialog box will be displayed.

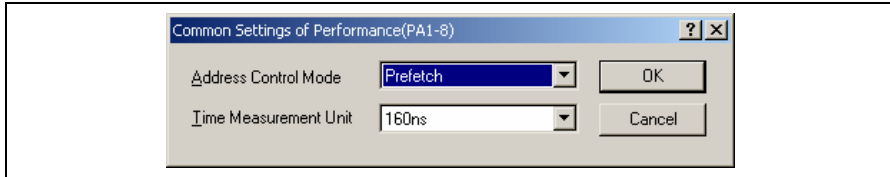

**Figure 5.66 [Common Settings of Performance(PA1-8)] Dialog Box**

- [Address Control Mode]: Select the method to detect addresses for the rate of execution time.
- PC: PC address detection mode
  - Prefetch: Prefetch address detection mode
- [Time Measurement Unit]: Select the timer resolution to be used for measurement from 160ns, 40ns, 20ns, or Target. The timer for execution time measurement has a 40-bit counter. At 20 ns the maximum time that can be measured is about six hours, and at 160  $\mu$ s the maximum time is about two days. When the counter overflows, "Timer Overflow" is displayed as the result of measurement. When Target is selected, the counter is incremented by an input clock. The result of measurement is displayed as 10 digits in hexadecimal.

Select the prefetch address detection mode in Access Count Of Specified Range Measurement, and PC address detection mode in other measurement modes. Otherwise, the result of the measurement will be incorrect.

### 5.9.4 Starting Performance Data Acquisition

Executing the user program clears the result of previous measurement and automatically starts measuring the rate of execution time according to the conditions that have been set. Stopping the user program displays the result of measurement in the [Performance Analysis] window.

### 5.9.5 Deleting a Measurement Condition

Select [Reset] from the popup menu with a measurement condition selected to delete the condition.

### 5.9.6 Deleting All Measurement Conditions

Choose [Reset All] from the popup menu to delete all the conditions that have been set.

## Section 6 Tutorial

### 6.1 Introduction

The following describes the main functions of the emulator by using a tutorial program.

The tutorial program is based on the C++ program that sorts ten random data items in ascending or descending order. The tutorial program performs the following actions:

- The `main` function repeatedly calls the `tutorial` function to repeat sorting.
- The `tutorial` function generates random data to be sorted and calls the `sort` and `tutorial` functions in order.
- The `sort` function enters the array where the random data generated by the `tutorial` function are stored, and sorts them in ascending order.
- The `change` function then sorts the array, which was sorted in ascending order by the `sort` function, in descending order.

The file `tutorial.cpp` contains source code for the tutorial program. The file `Tutorial.abs` is a compiled load module in the Dwarf2 format.

- Notes:
1. After recompilation, the addresses may differ from those given in this section.
  2. This section describes general usage examples for the emulator. For the specifications of particular products, refer to section 8, Software Specifications Specific to This Product, or the online help.
  3. The operation address of `Tutorial.abs` attached to each product differs according to products. Replace the address used in this section with the relevant address in each product after checking that it is placed on the corresponding line of the source program.
  4. In this tutorial, the H8S/2646 E6000 emulator is taken as an example. File paths or the appearance of figures differs according to products.

## 6.2 Running the High-performance Embedded Workshop

Open a workspace by following the procedure listed in section 4.1.3, Selecting an Existing Workspace.

Select the following directory:

OS installation drive \Workspace\Tutorial\E6000\2646

Note: The file path differs depending on the product. Refer to section 8.2.1, Environment for Execution of the Tutorial Program.

Then select the file indicated below.

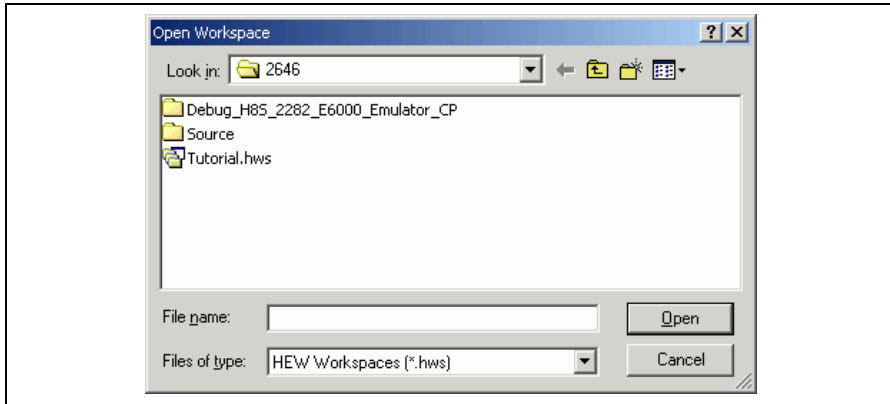

**Figure 6.1 [Open Workspace] Dialog Box**

Opening this workspace automatically connects the emulator.

## 6.3 Downloading the Tutorial Program

### 6.3.1 Downloading the Tutorial Program

Download the object program to be debugged.

- Select [Download module] from the popupmenu opened by clicking the right-hand mouse button on [Tutorial.abs] of [Download modules].

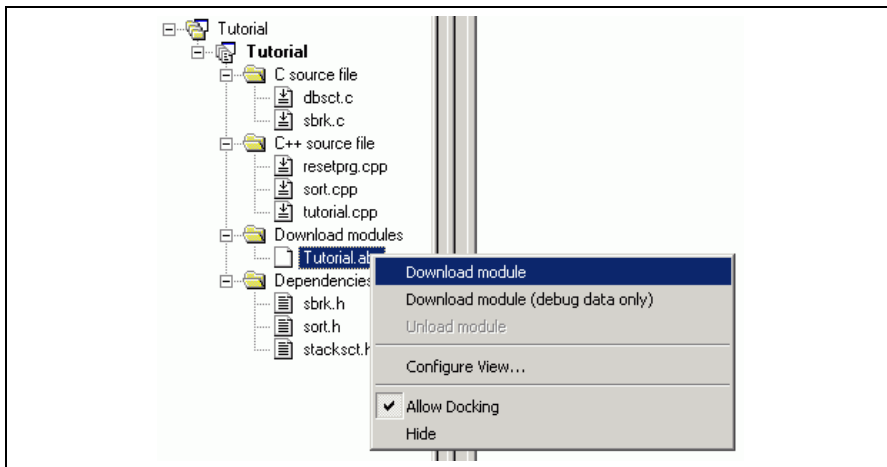

Figure 6.2 Downloading the Tutorial Program

### 6.3.2 Displaying the Source Program

The High-performance Embedded Workshop allows the user to debug a user program at the source level.

- Double-click [Tutorial.cpp] under [C++ source file].

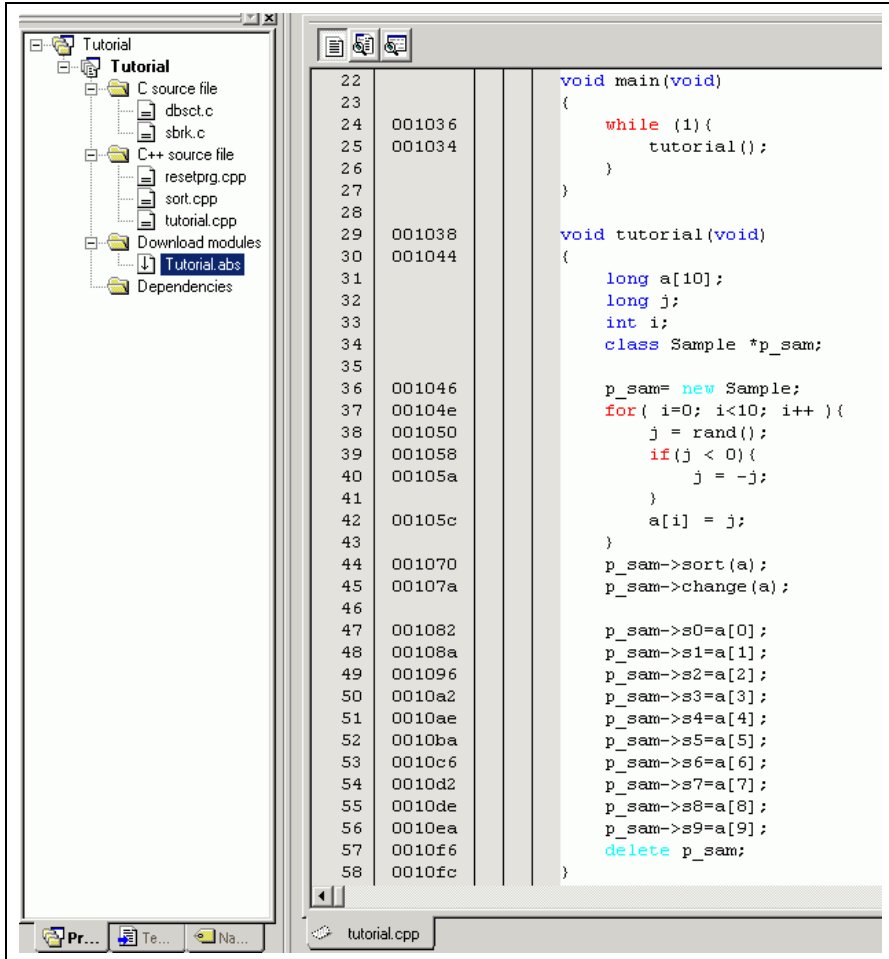

Figure 6.3 [Editor] Window (Displaying the Source Program)

- Select a font and size that are legible if necessary. For details, refer to the High-performance Embedded Workshop user's manual.

Initially the [Editor] window shows the start of the user program, but the user can use the scroll bar to scroll through the user program and look at the other statements.



## 6.4 Setting a Software Breakpoint

A software breakpoint is a simple debugging function.

The [Editor] window provides a very simple way of setting a software breakpoint at any point in a program. For example, to set a software breakpoint at the `sort` function call:

- Select by double-clicking the [S/W Breakpoints] column on the line containing the `sort` function call.

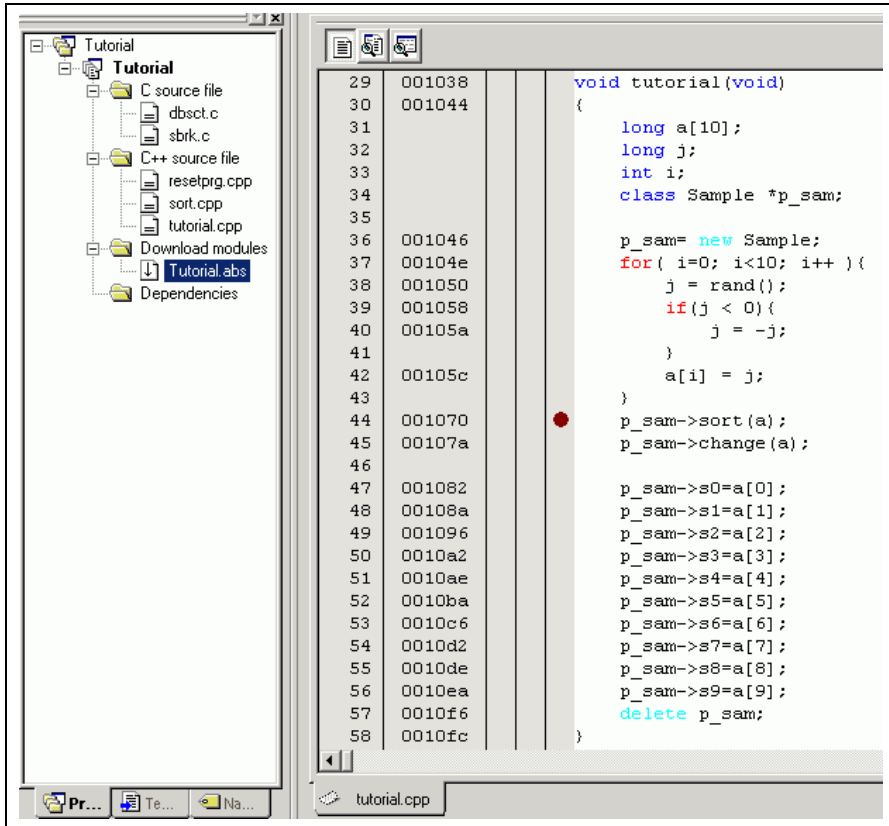

Figure 6.4 [Editor] Window (Setting a Software Breakpoint)

The symbol • will appear on the line containing the `sort` function. This shows that a software breakpoint has been set.

## 6.5 Setting Registers

Set a value of the program counter before executing the program.

- Select [Registers] from the [CPU] submenu of the [View] menu. The [Register] window is displayed.

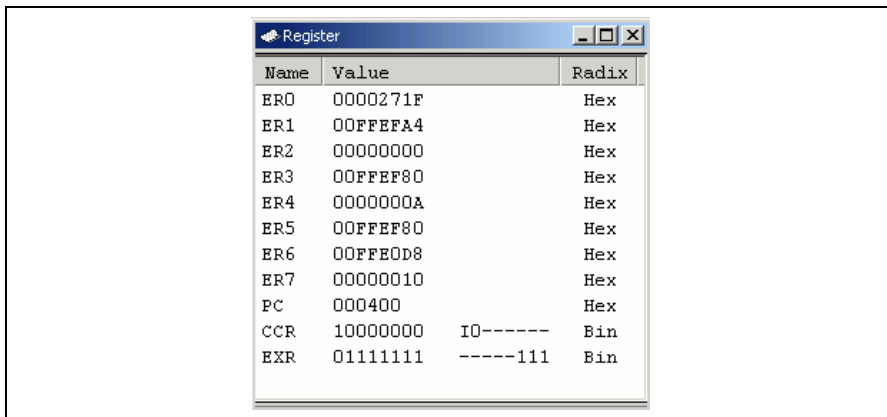

Figure 6.5 [Register] Window

- To change the value of the program counter (PC), double-click the value area in the [Register] window with the mouse. The following dialog box is then displayed, and the value can be changed. Set the program counter to H'00000400 in this tutorial program, and click the [OK] button.

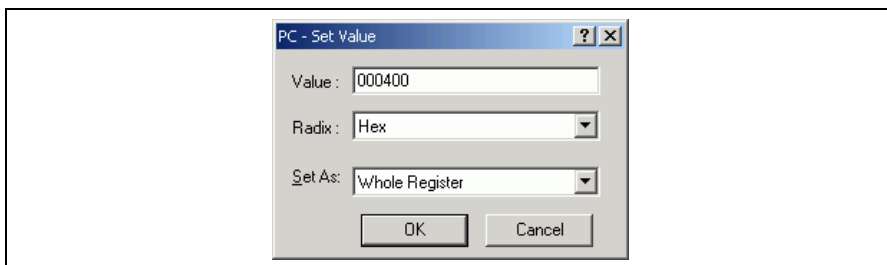
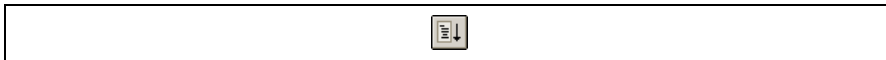

Figure 6.6 [Register] Dialog Box (PC)

## 6.6 Executing the Program

Execute the program as described in the following:

- To execute the program, select [Go] from the [Debug] menu, or click the [Go] button on the toolbar.



**Figure 6.7 [Go] Button**

While the program is executing, the current address bus value and the operating state of the MCU are displayed on the status bar.

The program will be executed up to the breakpoint that has been inserted, and an arrow will appear on the [S/W Breakpoints] column in the [Editor] window to show the position that the program has halted, with the message [Break = Software Break] in the status bar.

**Note:** When the source file is displayed after a break, a path of the source file may be inquired. The location of the source file is as follows:

OS installation drive \Workspace\Tutorial\E6000\2646\Source

The directory mentioned above cannot be specified depending on the version of the software. In such cases, specify the following directory instead.

High-performance Embedded Workshop installation destination directory  
\Tools\Renesas\DebugComp\Platform\E6000\2646\Source

The file path differs depending on the product. If necessary, replace \2646 with another name.

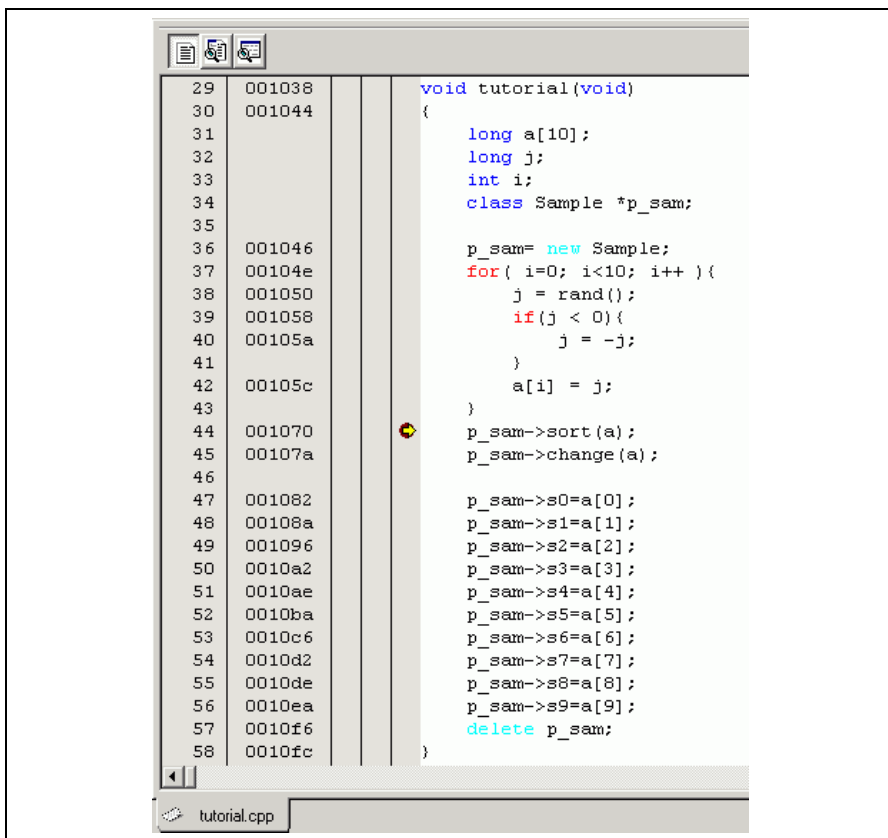
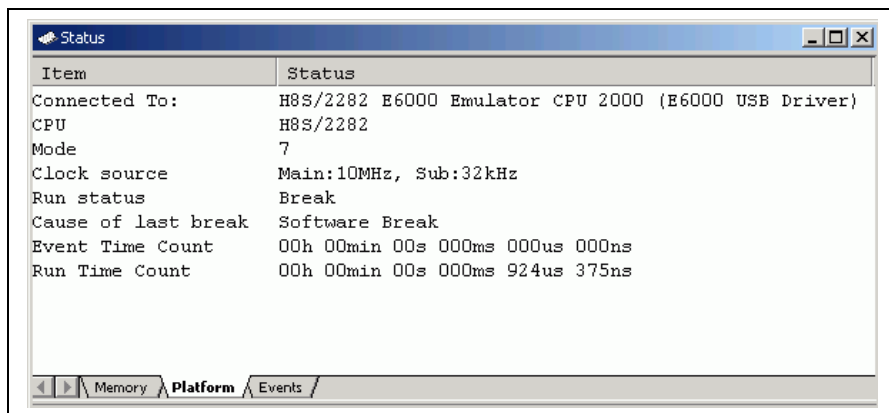

Figure 6.8 [Editor] Window (Break Status)

The user can see the cause of the break that occurred last time in the [Status] window.

- Select [Status] from the [CPU] submenu of the [View] menu. After the [Status] window is displayed, open the [Platform] sheet, and check the Status of Cause of last break.



**Figure 6.9 [Status] Window**

Note: The items that can be displayed in this window differ depending on the product. For the items that can be displayed, refer to section 8, Software Specifications Specific to This Product, or the online help.

## 6.7 Reviewing Breakpoints

The user can see all the breakpoints set in the program in the [Event] window.

- Select [Eventpoints] from the [Code] submenu of the [View] menu. The [Event] window is displayed. Select the [Breakpoint] sheet.

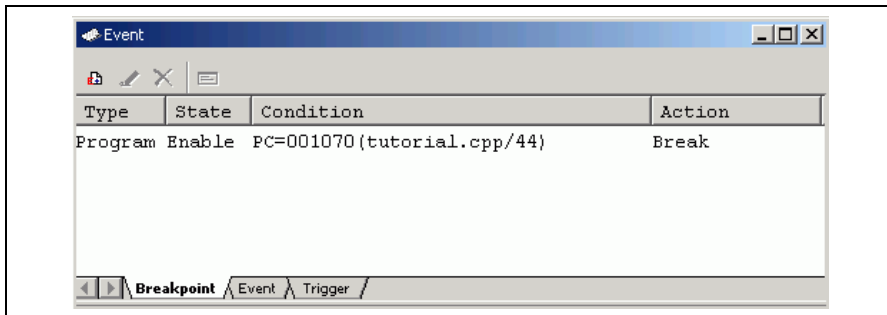

Figure 6.10 [Event] Window

The popup menu, opened by clicking the [Event] window with the right-hand mouse button, allows the user to set or change breakpoints, define new breakpoints, and delete, enable, or disable breakpoints.

## 6.8 Referring to Symbols

The [Label] window can be used to display the information on symbols in modules.

Select [Label] from the [Symbol] submenu of the [View] menu. The [Label] window is displayed so that the user can refer to the addresses of symbols in modules.

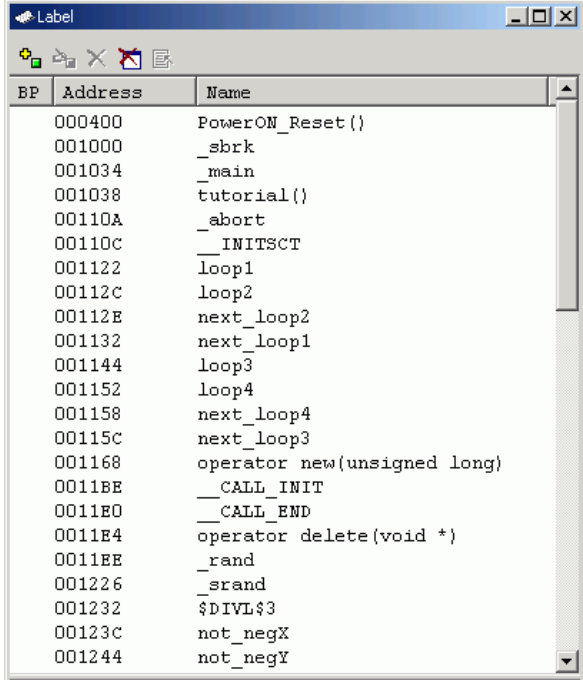

The screenshot shows a window titled "Label" with a standard Windows-style title bar and toolbar. The window contains a table with three columns: "BP", "Address", and "Name". The table lists various symbols and their corresponding memory addresses, such as "PowerON\_Reset()", "\_sbrk", "\_main", "tutorial()", "\_abort", "\_INIT SCT", "loop1", "loop2", "next\_loop2", "next\_loop1", "loop3", "loop4", "next\_loop4", "next\_loop3", "operator new(unsigned long)", "\_\_CALL\_INIT", "\_\_CALL\_END", "operator delete(void \*)", "\_rand", "\_srand", "\$DIVL\$3", "not\_negX", and "not\_negY".

| BP | Address | Name                        |
|----|---------|-----------------------------|
|    | 000400  | PowerON_Reset()             |
|    | 001000  | _sbrk                       |
|    | 001034  | _main                       |
|    | 001038  | tutorial()                  |
|    | 00110A  | _abort                      |
|    | 00110C  | _INIT SCT                   |
|    | 001122  | loop1                       |
|    | 00112C  | loop2                       |
|    | 00112E  | next_loop2                  |
|    | 001132  | next_loop1                  |
|    | 001144  | loop3                       |
|    | 001152  | loop4                       |
|    | 001158  | next_loop4                  |
|    | 00115C  | next_loop3                  |
|    | 001168  | operator new(unsigned long) |
|    | 0011BE  | __CALL_INIT                 |
|    | 0011E0  | __CALL_END                  |
|    | 0011E4  | operator delete(void *)     |
|    | 0011EE  | _rand                       |
|    | 001226  | _srand                      |
|    | 001232  | \$DIVL\$3                   |
|    | 00123C  | not_negX                    |
|    | 001244  | not_negY                    |

Figure 6.11 [Label] Window

## 6.9 Viewing Memory

When the label name is specified, the user can view the memory contents that the label has been registered in the [Memory] window. For example, to view the memory contents corresponding to `_main` in byte size:

- Select [Memory ...] from the [CPU] submenu of the [View] menu or click the [View Memory] toolbar button (🔍) to open the [Display Address] dialog box. Enter `_main` in the [Display Address] edit box.

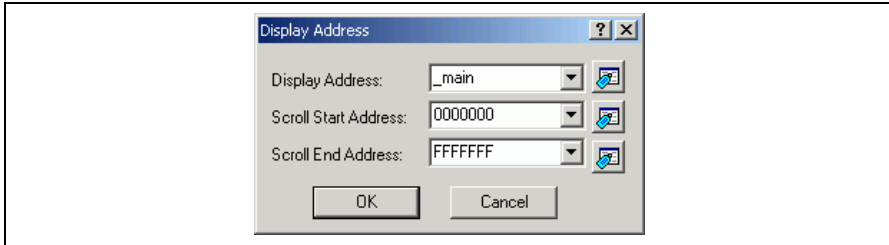

Figure 6.12 [Display Address] Dialog Box

- Click the [OK] button. The [Memory] window showing the selected area of memory is displayed.

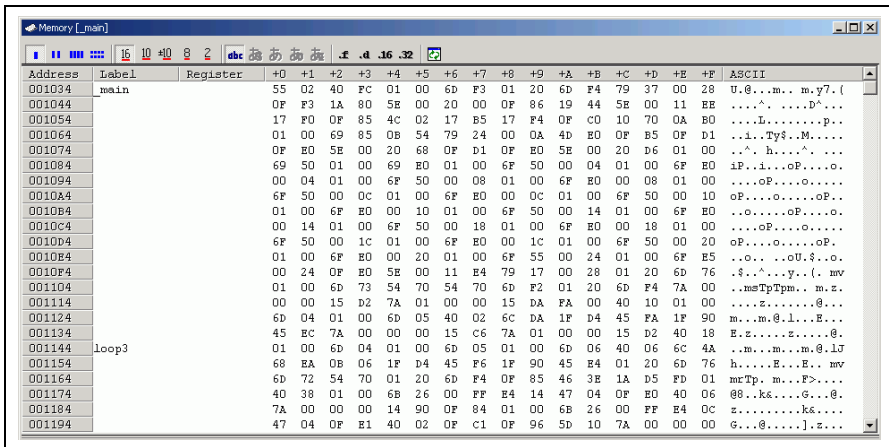

Figure 6.13 [Memory] Window



## 6.10 Watching Variables

As the user steps through a program, it is possible to watch that the values of variables used in the user program are changed. For example, set a watch on the long-type array `a` declared at the beginning of the program, by using the following procedure:

- Click the left of displayed array `a` in the [Editor] window to position the cursor.
- Select [Instant Watch...] with the right-hand mouse button.

The following dialog box will be displayed.

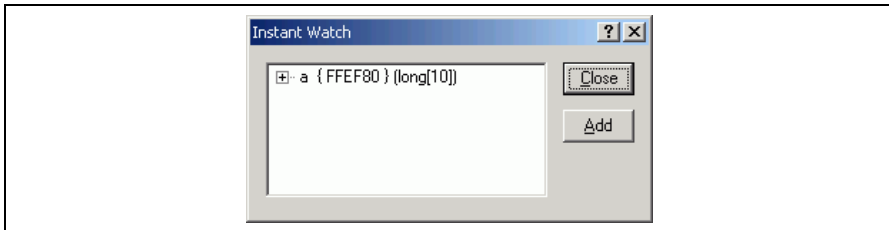

Figure 6.14 [Instant Watch] Dialog Box

- Click the [Add] button to add a variable to the [Watch] window.

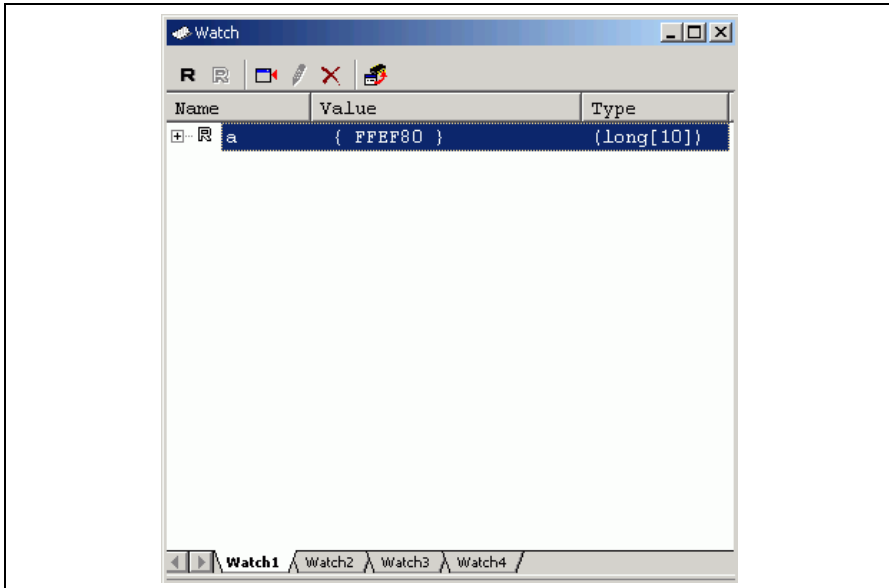

Figure 6.15 [Watch] Window (Displaying the Array)

The user can also add a variable to the [Watch] window by specifying its name.

- Click the [Watch] window with the right-hand mouse button and select [Add Watch...] from the popup menu.

The following dialog box will be displayed.

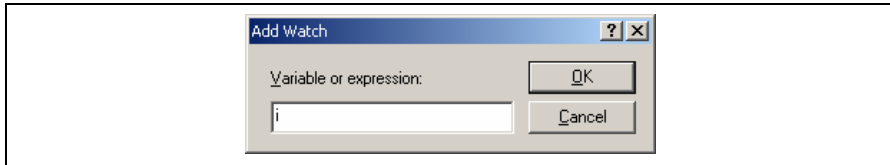

Figure 6.16 [Add Watch] Dialog Box

- Input variable *i* to [Variable or expression] edit box and click the [OK] button.

The [Watch] window will now also show the int-type variable *i*.

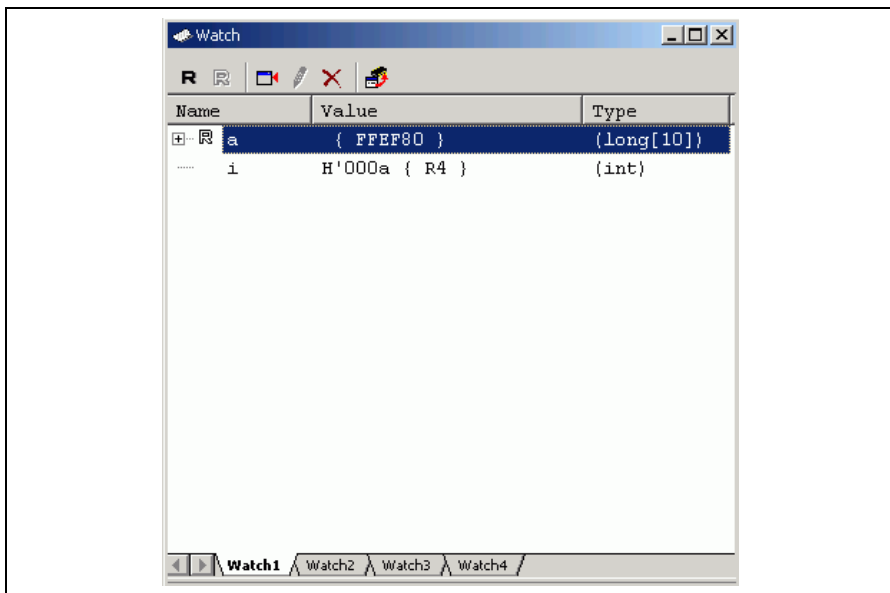

Figure 6.17 [Watch] Window (Displaying the Variable)

The user can click mark '+' at the left side of array a in the [Watch] window to watch all the elements.

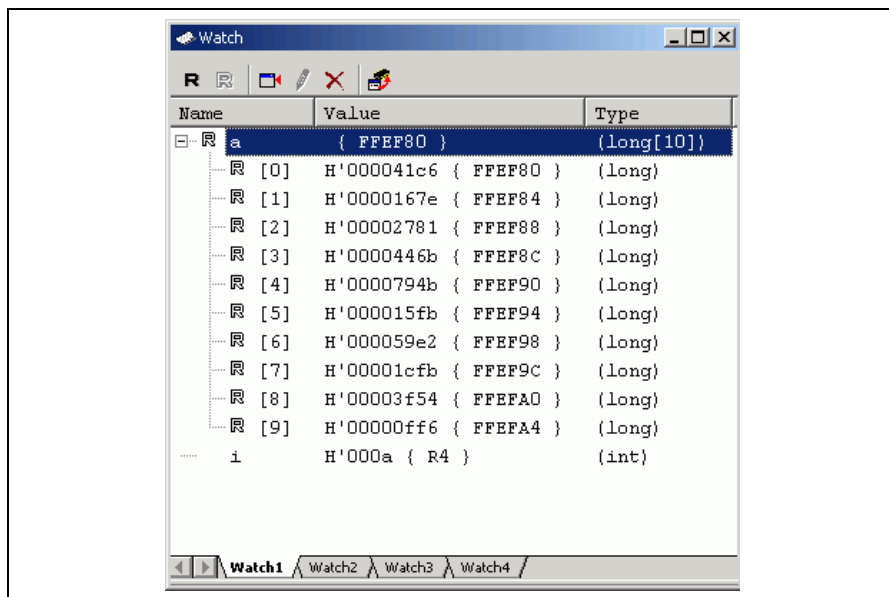

Figure 6.18 [Watch] Window (Displaying Array Elements)

## 6.11 Displaying Local Variables

The user can display local variables in a function using the [Locals] window. For example, we will examine the local variables in the `tutorial` function, which declares four local variables: `a`, `j`, `i`, and `p_sam`.

- Select [Locals] from the [Symbol] submenu of the [View] menu. The [Locals] window is displayed.

The [Locals] window shows the local variables in the function currently pointed to by the program counter, along with their values. Note, however, that the [Locals] window is initially empty because local variables are yet to be declared.

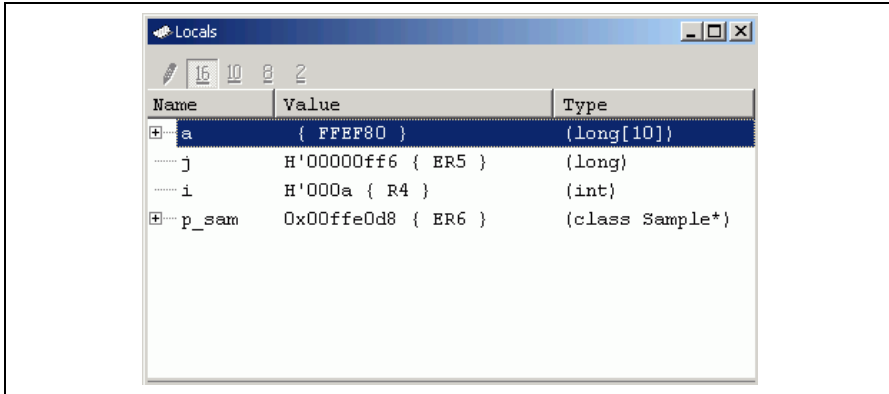

Figure 6.19 [Locals] Window

- Click mark '+' at the left side of array `a` in the [Locals] window to display the elements.
- Refer to the elements of array `a` before and after the execution of the `sort` function, and confirm that random data is sorted in descending order.

## 6.12 Stepping Through a Program

The High-performance Embedded Workshop provides a range of step menu commands that allow efficient program debugging.

**Table 6.1 Step Option**

| <b>Menu Command</b> | <b>Description</b>   |
|---------------------|--|
| Step In             | Executes each statement, including statements within functions.  |
| Step Over           | Executes a function call in a single step.   |
| Step Out            | Steps out of a function, and stops at the statement following the statement in the program that called the function. |
| Step...             | Steps the specified times repeatedly at a specified rate.  |

### 6.12.1 Executing the [Step In] Command

The [Step In] command steps into the called function and stops at the first statement of the called function.

- To step through the `sort` function, select [Step In] from the [Debug] menu, or click the [Step In] button in the toolbar.

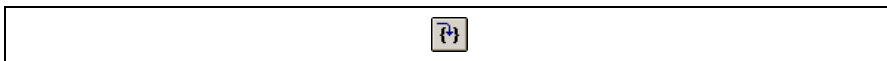

**Figure 6.20 [Step In] Button**

```

11 002000 Sample::Sample()
12 002006 {
13 00201c     s0=0;
14 002026     s1=0;
15 00202c     s2=0;
16 002032     s3=0;
17 002038     s4=0;
18 00203e     s5=0;
19 002044     s6=0;
20 00204a     s7=0;
21 002050     s8=0;
22 002056     s9=0;
23 002060 }
24
25 002068 void Sample::sort(long *a)
26 002070 {
27     long t;
28     int i, j, k, gap;
29
30     gap = 5;
31     while( gap > 0 ){
32         for( k=0; k<gap; k++){
33             for( i=k+gap; i<10; i=i+gap ){
34                 for( j=i-gap; j>=k; j=j-gap){
35                     if(a[j]>a[j+gap]){
36                         t = a[j];
37                         a[j] = a[j+gap];
38                         a[j+gap] = t;
39                     }
40                     else
41                         break;
42                 }
43             }
44         }
45         gap = gap/2;
46     }
47 }

```

tutorial.cpp sort.cpp

Figure 6.21 [Editor] Window (Step In)

- The highlighted line moves to the first statement of the `sort` function in the [Editor] window.

## 6.12.2 Executing the [Step Out] Command

The [Step Out] command steps out of the called function and stops at the next statement of the calling statement in the main function.

- To step out of the `sort` function, select [Step Out] from the [Debug] menu, or click the [Step Out] button in the toolbar.



Figure 6.22 [Step Out] Button

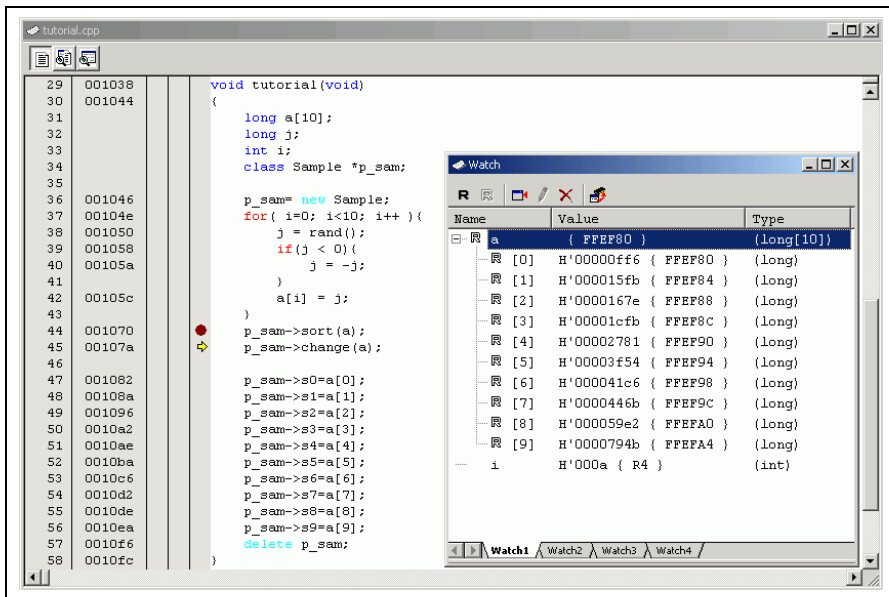

Figure 6.23 [High-performance Embedded Workshop] Window (Step Out)

The data of variable `a` displayed in the [Watch] window is sorted in ascending order.

### 6.12.3 Executing the [Step Over] Command

The [Step Over] executes a function call as a single step and stops at the next statement of the main program.

- To step through all statements in the change function at a single step, select [Step Over] from the [Debug] menu, or click the [Step Over] button in the toolbar.



Figure 6.24 [Step Over] Button

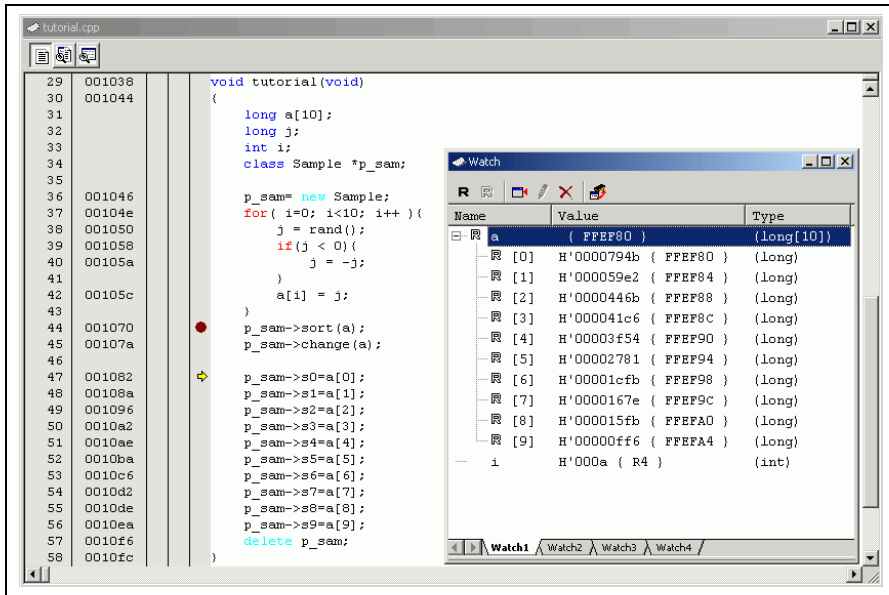

Figure 6.25 [High-performance Embedded Workshop] Window (Step Over)



### 6.13 Forced Breaking of Program Executions

The High-performance Embedded Workshop can force a break in the execution of a program.

- Cancel all the breaks.
- To execute the remaining sections of the tutorial function, select [Go] from the [Debug] menu or the [Go] button on the toolbar.

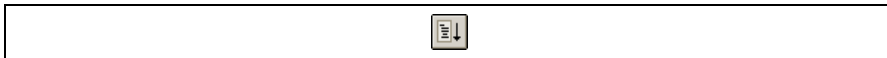

Figure 6.26 [Go] Button

- The program goes into an endless loop. To force a break in execution, select [Halt] from the [Debug] menu or the [Stop] button on the toolbar.



Figure 6.27 [Stop] Button

### 6.14 Resetting the MCU

Resetting the MCU initializes the internal I/O registers and makes the program counter jump to the address set in the reset vector.

To reset the MCU, select [Reset CPU] from the [Debug] menu or the [Reset CPU] button on the toolbar.

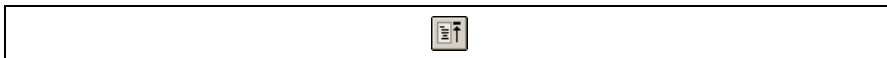

Figure 6.28 [Reset CPU] Button

To execute the program from the reset vector, select [Reset Go] from the [Debug] menu or the [Reset Go] button on the toolbar.

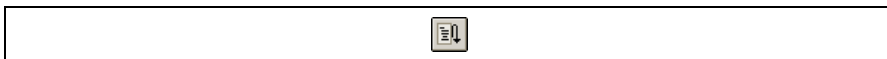

Figure 6.29 [Reset Go] Button

Note: This tutorial program is executable from the reset vector.

## 6.15 Break Function

The emulator's break functions are of two types: software breaks and breaks at event points. software breakpoints and event points are set in the High-performance Embedded Workshop's [Event] window.

An overview and setting of the break function are described below.

### 6.15.1 Software Break Function

The emulator can set up to 256 software breakpoints.

- Select [Eventpoints] from the [Code] submenu of the [View] menu. The [Event] window is displayed.
- Select the [Breakpoint] sheet.

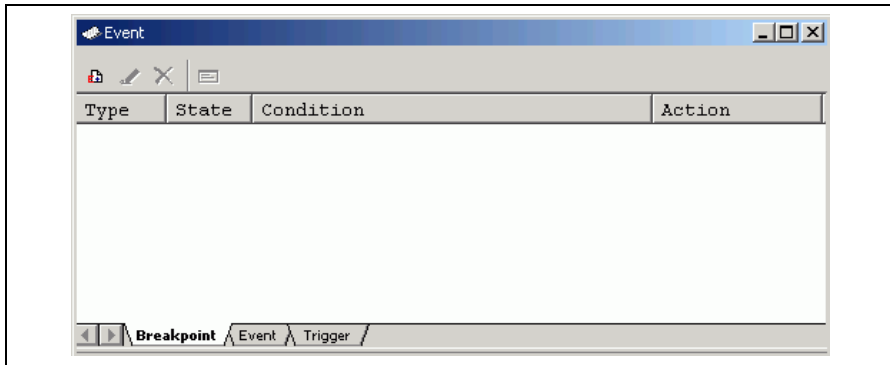
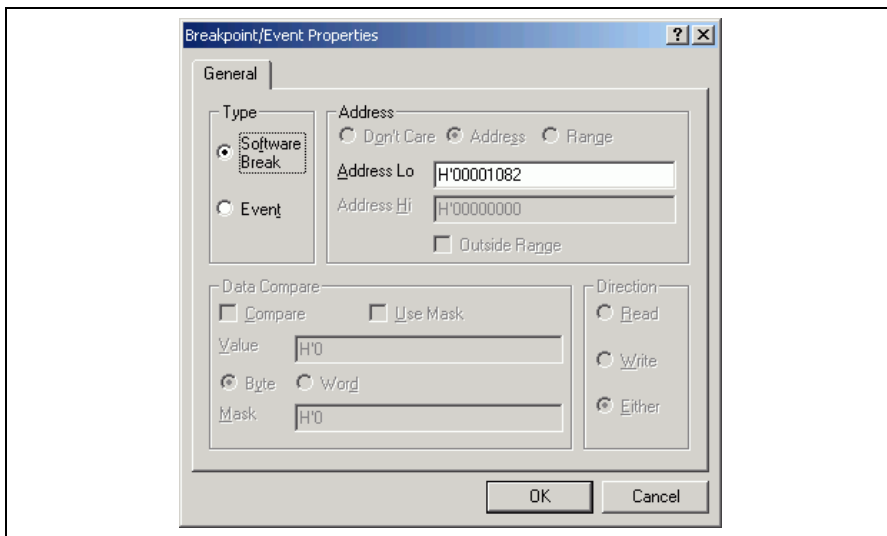

Figure 6.30 [Event] Window (Before Setting a Software Breakpoint)

- Click the [Event] window with the right-hand mouse button and select [Add...] from the popup menu.
- The [Breakpoint/Event Properties] dialog box is displayed.



**Figure 6.31 [Breakpoint/Event Properties] Dialog Box**

- Check the [Software Break] radio button in the [Type] group box.
- Use the [Editor] window to refer to the address on the line that has 'p\_sam->s0=a[0];' within the tutorial function and enter this address in the [Address Lo] edit box of the [Address] group box. In this example, enter **H'00001082**.

Note: This dialog box differs according to the product. For the items of each product, refer to section 8, Software Specifications Specific to This Product, or the online help.

- Click the [OK] button.

The software breakpoint that has been set is displayed in the [Event] window.

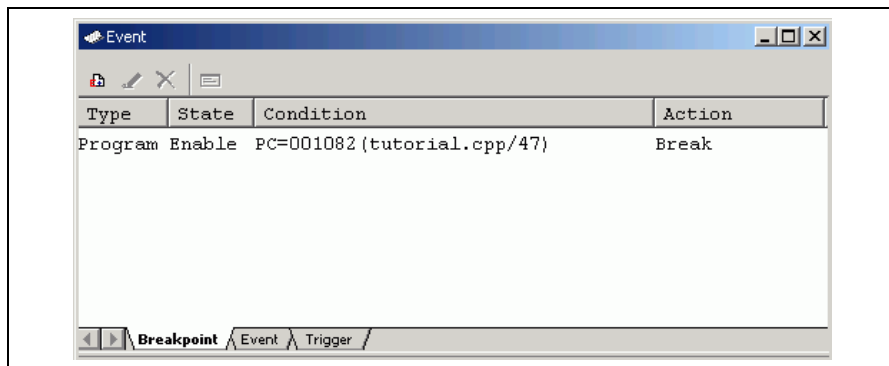

**Figure 6.32 [Event] Window (Software Breakpoint Setting)**

Note: The items that can be displayed in this window differ depending on the product. For the items that can be displayed, refer to section 8, Software Specifications Specific to This Product, or the online help.

- Close the [Event] window.
- To stop the tutorial program at the breakpoint, select [Reset Go] from the [Debug] menu.

The program runs until it stops at the breakpoint that has been set.

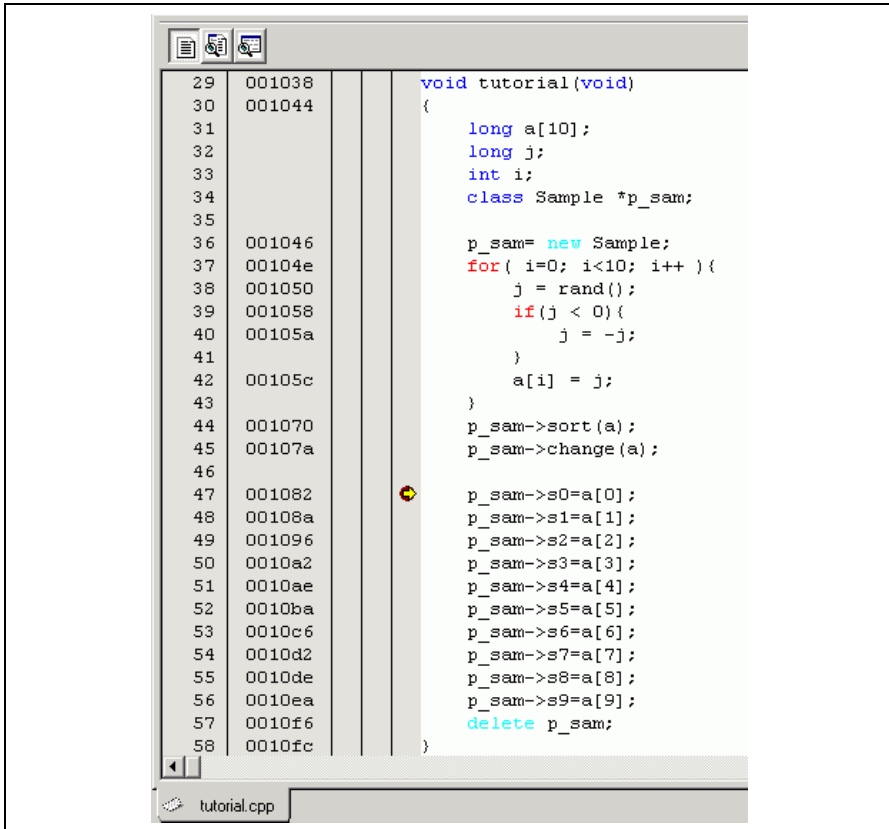
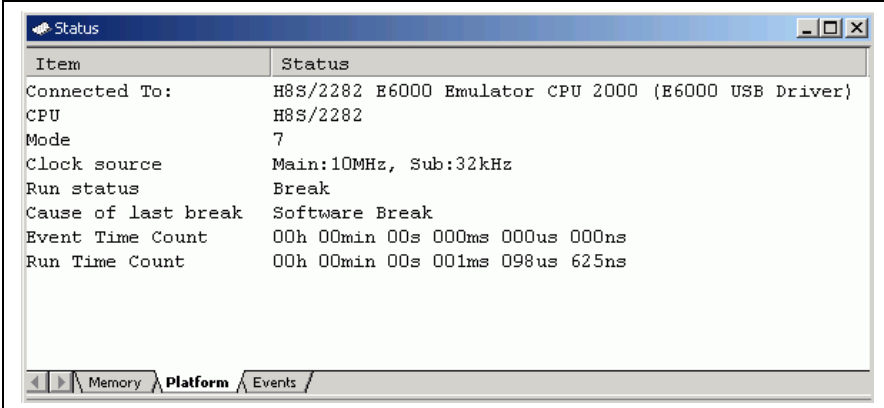

Figure 6.33 [Editor] Window at Execution Stop (Software Break)

The [Status] window displays the following contents:



The screenshot shows a window titled "Status" with a table of system information. The table has two columns: "Item" and "Status". The data is as follows:

| Item                | Status  |
|---------------------|---|
| Connected To:       | H8S/2282 E6000 Emulator CPU 2000 (E6000 USB Driver) |
| CPU                 | H8S/2282  |
| Mode                | 7   |
| Clock source        | Main:10MHz, Sub:32kHz                               |
| Run status          | Break   |
| Cause of last break | Software Break                                      |
| Event Time Count    | 00h 00min 00s 000ms 000us 000ns                     |
| Run Time Count      | 00h 00min 00s 001ms 098us 625ns                     |

At the bottom of the window, there are three tabs: "Memory", "Platform" (which is selected), and "Events".

**Figure 6.34** Displayed Contents of the [Status] Window (Software Break)

Note: The items that can be displayed in this window differ depending on the product. For the items that can be displayed, refer to section 8, Software Specifications Specific to This Product, or the online help.

## 6.15.2 Breaking Execution at Event Points

Setting up of an event point on event channel 1 (Ch1) such that a break is triggered when the event point's conditions have been satisfied five times is explained as an example of the use of event points.

- Select [Eventpoints] from the [Code] submenu of the [View] menu. The [Event] window is displayed.
- The breakpoint that has been previously set must be deleted. Click the [Breakpoints] window with the right-hand mouse button and select [Delete All] from the popup menu to delete all the breakpoints that have been set.
- Click the [Event] tab.

Up to 12 event points (eight event channels and four range channels) can be set up as independent conditions. In this example, we are setting the condition for event channel 1.

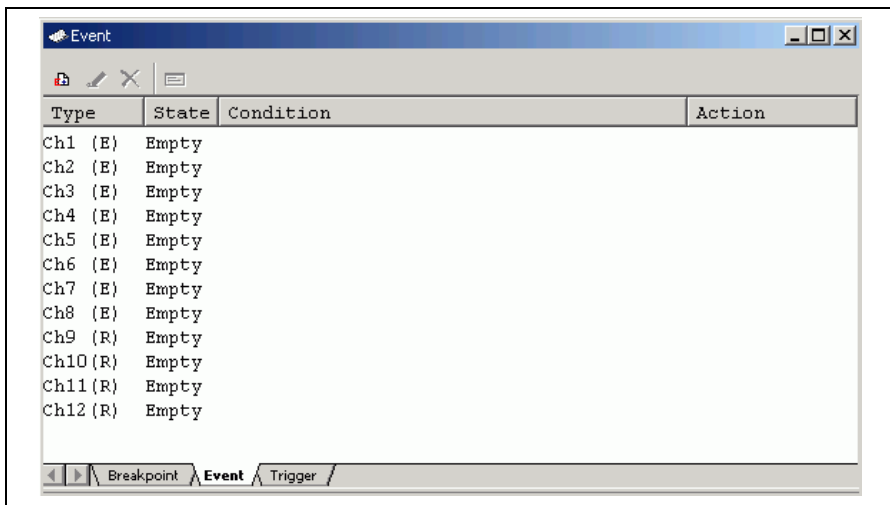

Figure 6.35 [Event] Window (Event Channel 1 [Ch1])

- Select the line for Ch1 in the [Event] window. Double-click on this line that is highlighted.
- The [Breakpoint/Event Properties] dialog box is displayed.
- Make the following settings in the boxes on the [General] page:
  - Select the [Event] radio button in the [Type] group box.
  - Select the [Address] radio button in the [Address] group box. Then use the [Editor] window to refer to the address on the line that has 'a[i]=j;' within the tutorial function and enter this address in the [Address Lo] edit box. In this example, enter `H'0000105c`.
- Enter `D'5` as the number of times the event condition is to be satisfied in the [Required number of event occurrences] edit box on the [Action] page.

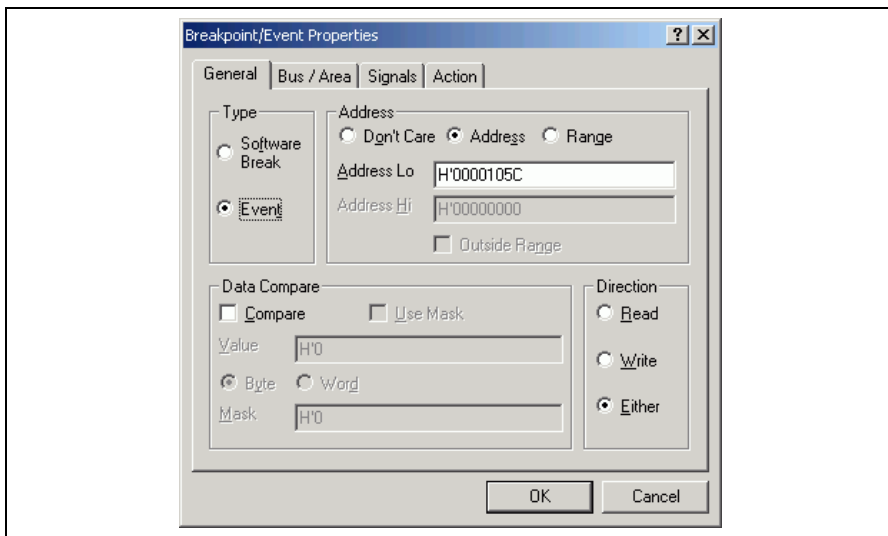

Figure 6.36 [General] Page ([Breakpoint/Event Properties] Dialog Box)

- Click the [OK] button. The [Event] window is displayed, as shown below.

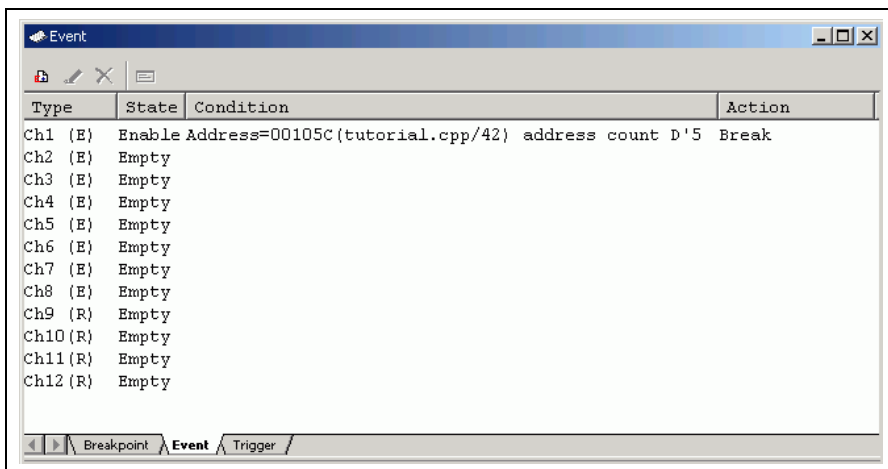

Figure 6.37 [Event] Window (Setting Completed)

Note: The items that can be displayed in this window differ depending on the product. For the items that can be displayed, refer to section 8, Software Specifications Specific to This Product, or the online help.



Select [Reset Go] from the [Debug] menu to stop the tutorial program at breakpoints.

The program runs then stops at the condition specified under Ch1.

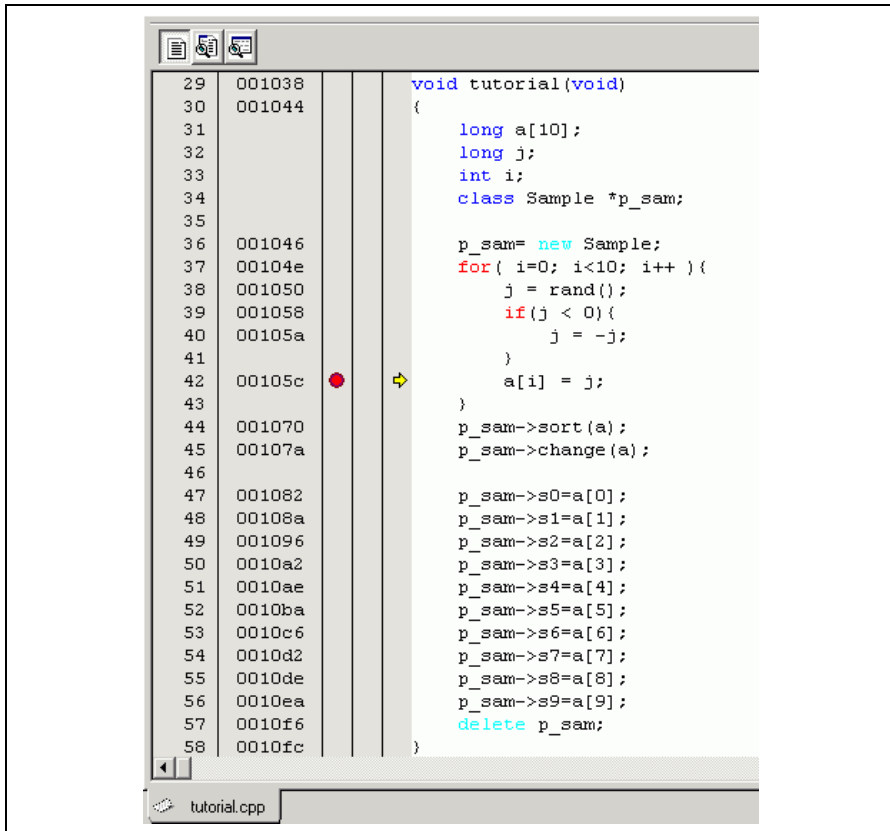

```
29 001038 void tutorial(void)
30 001044 {
31     long a[10];
32     long j;
33     int i;
34     class Sample *p_sam;
35
36 001046     p_sam= new Sample;
37 00104e     for( i=0; i<10; i++ ){
38 001050         j = rand();
39 001058         if(j < 0){
40 00105a             j = -j;
41
42 00105c             a[i] = j;
43         }
44 001070     p_sam->sort( a);
45 00107a     p_sam->change( a);
46
47 001082     p_sam->s0=a[0];
48 00108a     p_sam->s1=a[1];
49 001096     p_sam->s2=a[2];
50 0010a2     p_sam->s3=a[3];
51 0010ae     p_sam->s4=a[4];
52 0010ba     p_sam->s5=a[5];
53 0010c6     p_sam->s6=a[6];
54 0010d2     p_sam->s7=a[7];
55 0010de     p_sam->s8=a[8];
56 0010ea     p_sam->s9=a[9];
57 0010f6     delete p_sam;
58 0010fc }
```

Figure 6.38 [Editor] Window at Execution Stop

The [Status] window displays the following contents.

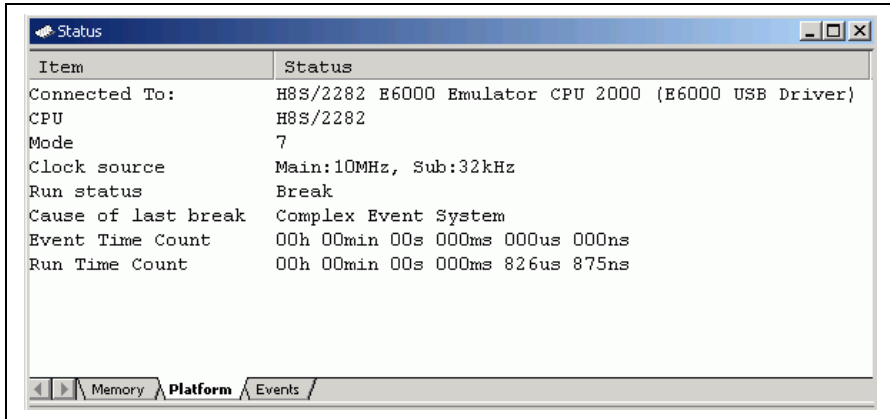

**Figure 6.39** Displayed Contents of the [Status] Window

Refer to the [Watch] window for the value of variable *i*. The value is 4, indicating that the break occurred after the condition had been satisfied five times.

**Note:** The items that can be displayed in this window differ depending on the product. For the items that can be displayed, refer to section 8, Software Specifications Specific to This Product, or the online help.

Remove the event point. Clicking the right-hand mouse button on the [Event] window displays a popup menu. Select [Remove All] from this menu to remove all event points.

## 6.16 Trace Functions

The trace functions of the emulator use the realtime trace buffer, which is able to store the information on up to 32,768 bus cycles. The content of this buffer, which is constantly updated during execution, is displayed in the [Trace] window.

Select [Trace] from the [Code] submenu of the [View] menu to display the [Trace] window.

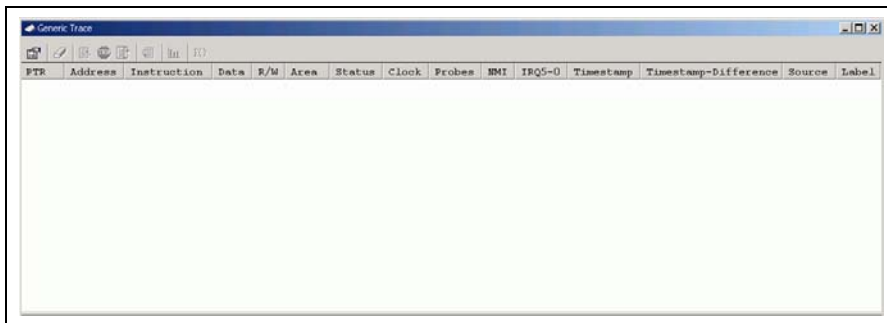

**Figure 6.40 [Trace] Window**

When trace information is displayed in the [Trace] window, clicking the right-hand mouse button on the [Trace] window displays a popup menu. Select [Clear] from this menu to clear the trace information.

The following sections give an overview of the trace functions and methods for setting them.

### 6.16.1 Displaying a Trace (when Time Stamping is not Available)

The method used to specify an address as an event condition for the tracing of read/write cycles and display the trace is described below.

- (1) Clicking the right-hand mouse button on the [Trace] window displays a popup menu. Select [Acquisition...] from this menu to display the [Trace Acquisition] dialog box.

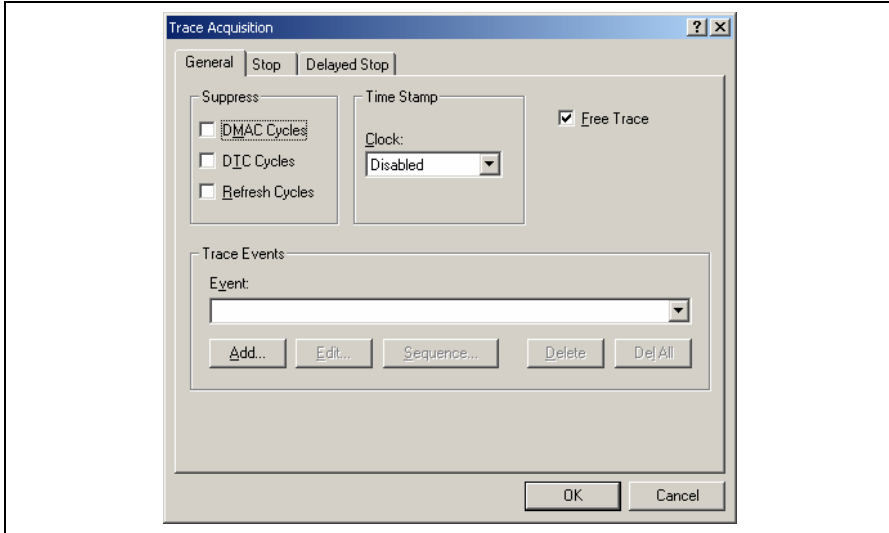

Figure 6.41 [Trace Acquisition] Dialog Box

- (2) Register an address as an event condition for trace acquisition. Click the [Add...] button in the [Trace Events] group box on the [General] page to display the [Breakpoint/Event Properties] dialog box.

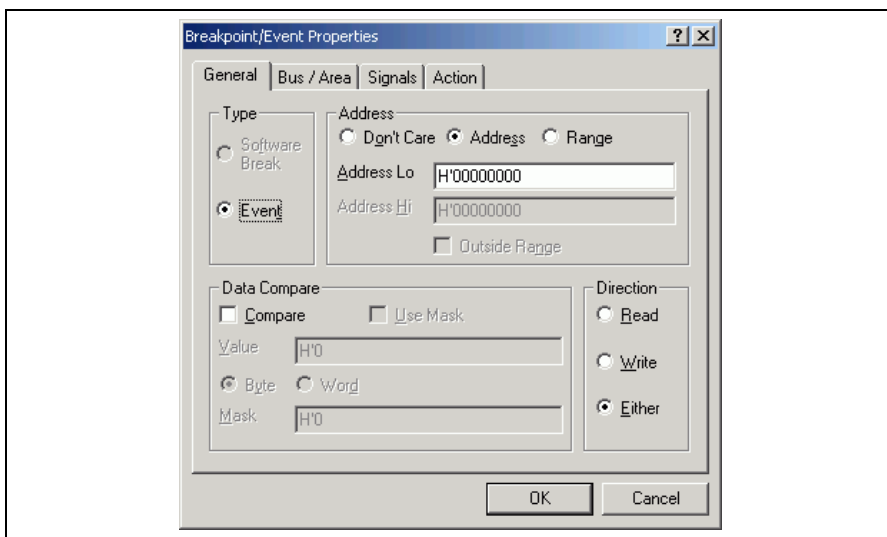

Figure 6.42 [Breakpoint/Event Properties] Dialog Box

- (3) Use the [Editor] window to refer to the address on the line that has 'a[i]=j;' within the tutorial function and enter this address in the [Address Lo] edit box of the [Address] group box on the [General] page of the [Breakpoint/Event Properties] dialog box. In this example, enter `H'0000105C`. This address has thus been set. Click the [OK] button to close the [Breakpoint/Event Properties] dialog box.

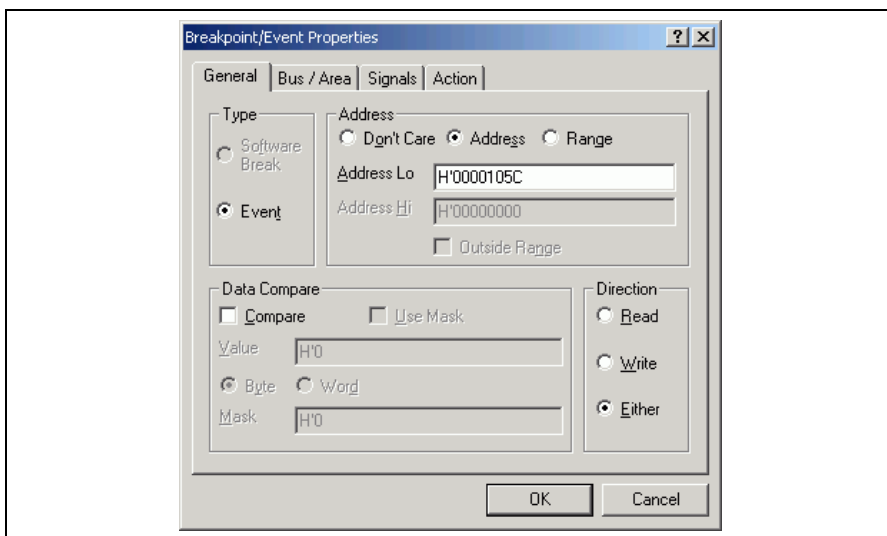
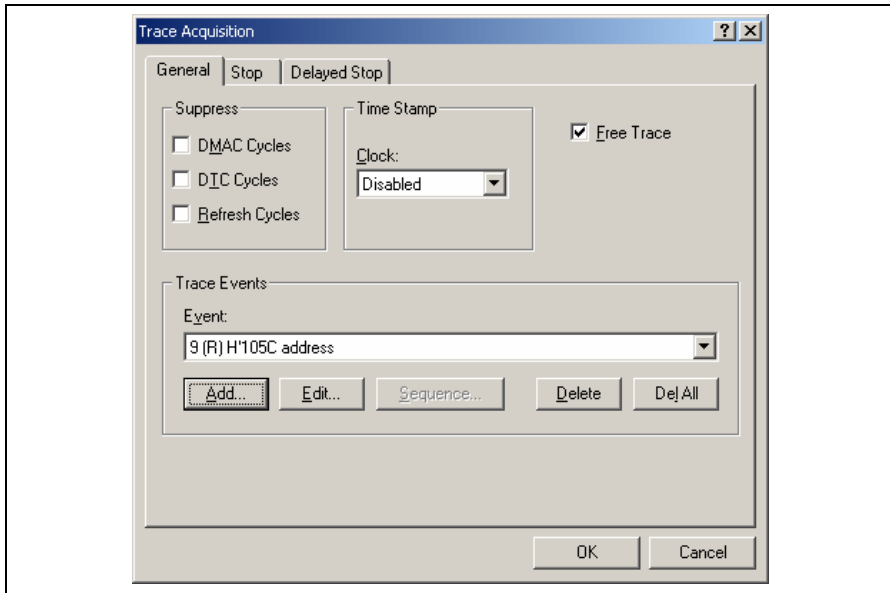

Figure 6.43 [Breakpoint/Event Properties] Dialog Box (after Setting an Event)

- (4) The event that has been set is now displayed in the [Event] combo box of the [Trace Events] group box on the [General] page of the [Trace Acquisition] dialog box.



**Figure 6.44** [Trace Acquisition] Dialog Box (Adding an Event)

- (5) To enable the event condition that has been set, uncheck the [Free Trace] check box on the [General] page. This will add pages [1] to [4] to the [Trace Acquisition] dialog box.

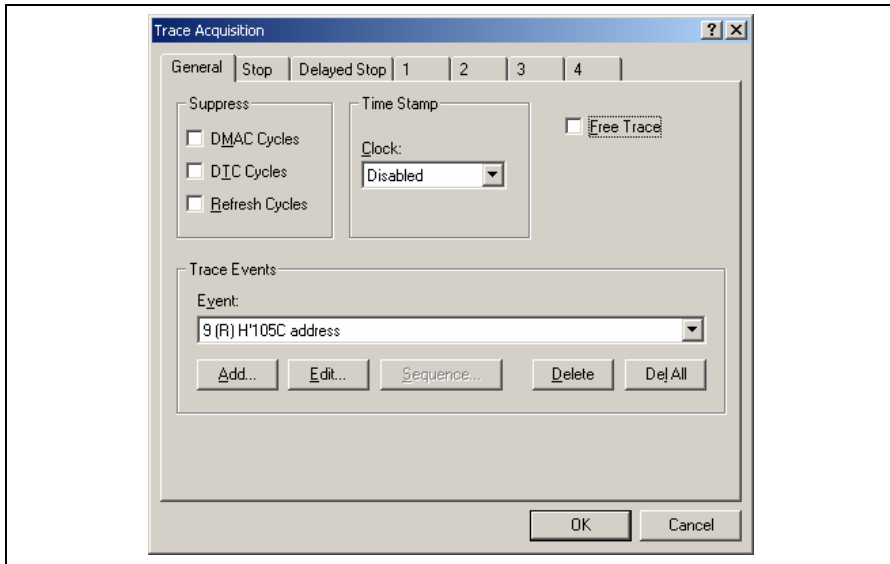

**Figure 6.45 [Trace Acquisition] Dialog Box (Pages Added)**

(6) Select page [1] and click the [Range] radio button in the [Conditions] group box. This will display the [Range Event] combo box and the [Edit...] button.

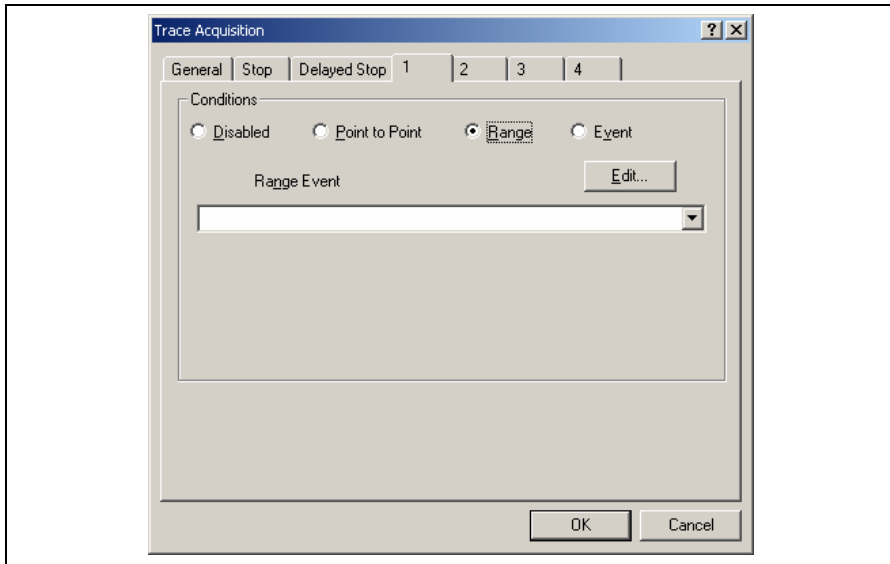

Figure 6.46 [Trace Acquisition] Dialog Box (Displaying Page [1])



- (7) Select the event you have registered from the [Range Event] combo box. The event is now enabled. Click the [OK] button to complete the trace setting.

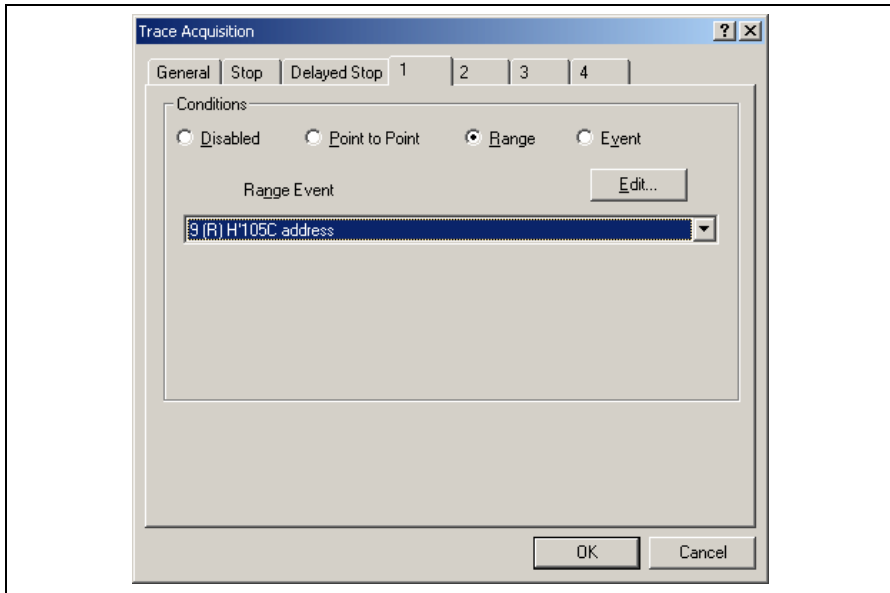

Figure 6.47 [Trace Acquisition] Dialog Box (Setting Completed)

- (8) Make the setting such that the break occurs after the instruction at the address on the line that has 'a[i]=j;' within the tutorial function (H'000105C in this example) has been executed five times (for details on this, refer to section 6.15.2, Breaking Execution at Event Points).
- (9) Select [Reset Go] from the [Debug] menu. Processing stops when the break condition is satisfied, and the [Trace] window then displays the following content.

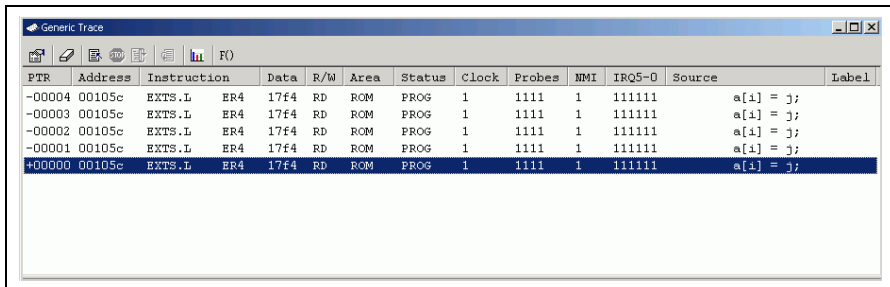

Figure 6.48 [Trace] Window (Displaying the Result)

If you have trouble viewing a column, drag the header (vertical) bars below the title bar to adjust the width of the column.

- (10) Remove the event points that have been set and clear the trace information. Click the right-hand mouse button on the [Event] window to display a popup menu. Select [Delete All] from this menu to remove all of the event points that have been set. Click the right-hand mouse button on the [Trace] window to display a further popup menu. Select [Clear] from this menu to clear the trace information.

### 6.16.2 Displaying a Trace (when Time Stamping is Available)

The following procedure is for obtaining and displaying, with time stamps, trace information on cycles of writing to memory locations in the specified address range.

- (1) Clicking the right-hand mouse button on the [Trace] window displays a popup menu. Select [Acquisition...] from this menu to display the [Trace Acquisition] dialog box (see figure 6.41, [Trace Acquisition] dialog box).
- (2) Register the address range for trace acquisition as an event condition. Click the [Add...] button in the [Trace Events] group box on the [General] page to display the [Breakpoint/Event Properties] dialog box (see figure 6.42, [Breakpoint/Event Properties] dialog box).
- (3) Click the [Range] radio button in the [Address] group box on the [General] page of the [Breakpoint/Event Properties] dialog box. Use the [Locals] window to refer to the address on the line where variable `a`, which is defined within the `tutorial` function, is allocated (`H'00FFFEF80` in this example) and enter this address in the [Address Lo] edit box. Then enter an address, which is `H'27` added to that entered in the [Address Lo] edit box (`H'00FFFEFA7` in this example), in the [Address Hi] edit box. This procedure sets the memory range for variable `a` of the `tutorial` function.
- (4) Click the [Write] radio button in the [Direction] group box to set a write cycle for the specified range. This completes the setting of a memory range. Click the [OK] button to close the [Breakpoint/Event Properties] dialog box.

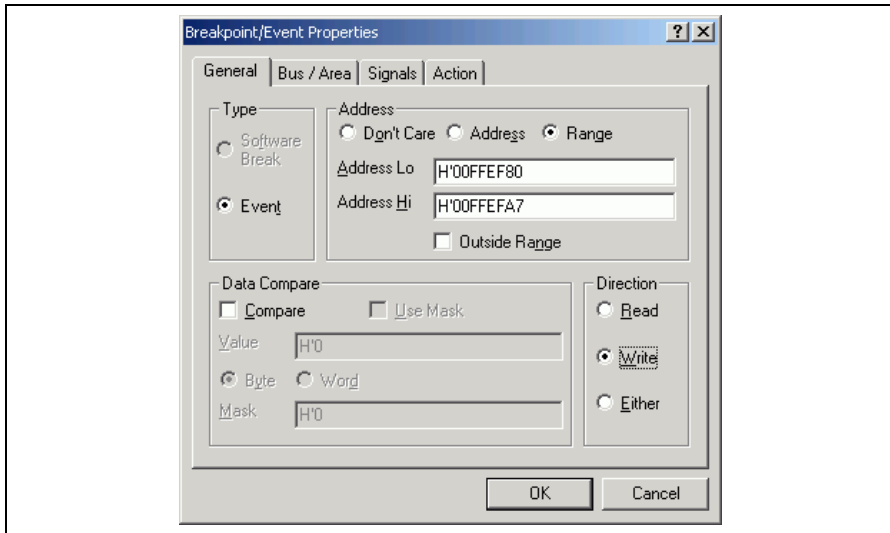
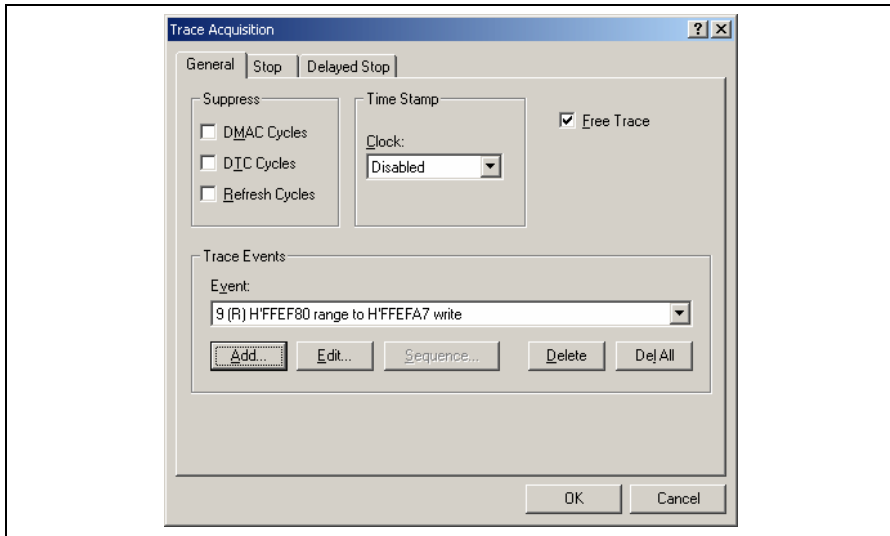

Figure 6.49 [Breakpoint/Event Properties] Dialog Box (after Setting an Event)

- (5) The event that has been set in the [Event] combo box of the [Trace Events] group box on the [General] page of the [Trace Acquisition] dialog box is displayed.



**Figure 6.50 [Trace Acquisition] Dialog Box (Adding an Event)**

- (6) To enable time stamping, select 125ns from the [Clock] combo box of the [Time Stamp] group box.

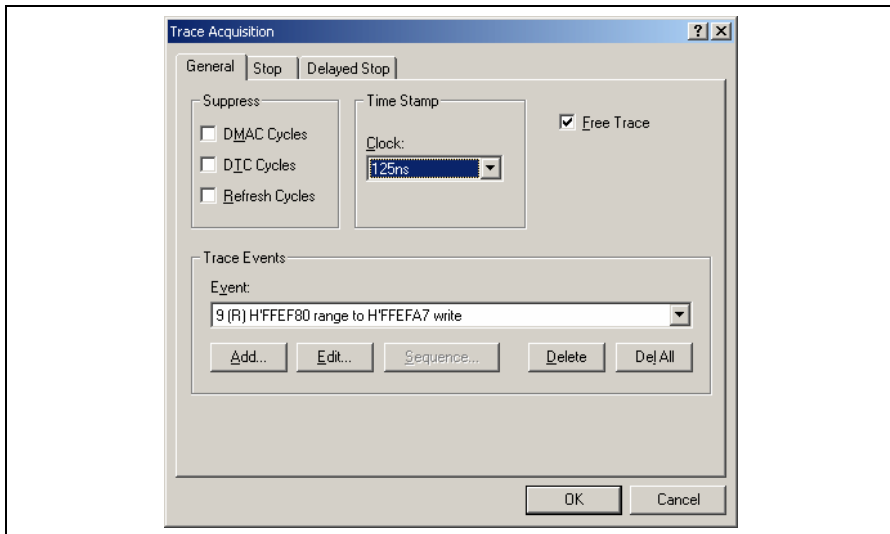

**Figure 6.51 [Trace Acquisition] Dialog Box (Time Stamping is Available)**

- (7) To enable the event condition that has been set, uncheck the [Free Trace] check box on the [General] page. This will add pages [1] to [4] (see figure 6.45, [Trace Acquisition] dialog box).
- (8) Select page [1] and click the [Range] radio button in the [Conditions] group box. This will display the [Range Event] combo box and the [Edit...] button (see figure 6.46, [Trace Acquisition] dialog box).
- (9) Click the [Range Event] combo box to select the event you have registered. The event is now enabled. Click the [OK] button to complete the trace setting.

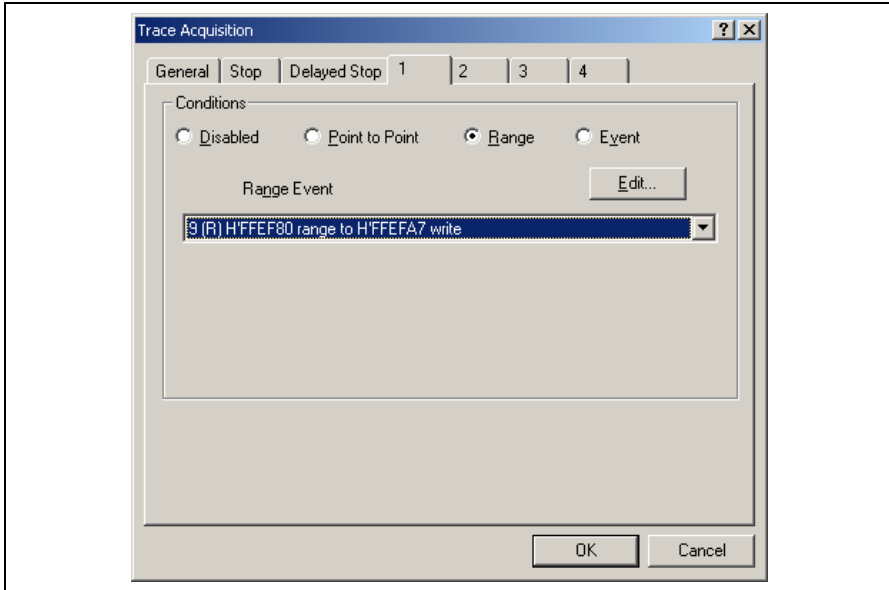

**Figure 6.52 [Trace Acquisition] Dialog Box (Setting Completed)**

- (10) Make the setting such that the break occurs after the instruction at the address on the line that has 'p\_sam->s0=a[0];' within the tutorial function (H'00001082 in this example) (for details on this, refer to section 6.15.1, Software Break Function).

- (11) Select [Reset Go] from the [Debug] menu. Processing stops when the break condition is satisfied, and the [Trace] window then displays the following content.

| PTR    | Address | I. | Data | R/W | A | S | C | P | K | I | Timestamp                      | Timestamp-Difference           | Source |
|--------|---------|----|------|-----|---|---|---|---|---|---|--------------------------------|--------------------------------|--------|
| -00012 | ffef8e  |    | 41c6 | WR  |   |   |   |   |   |   | 0000h000min000s001ms081us875ns | 0000h000min000s000ms000us000ns |        |
| -00011 | ffef90  |    | 0000 | WR  |   |   |   |   |   |   | 0000h000min000s001ms084us125ns | 0000h000min000s000ms002us250ns |        |
| -00010 | ffef92  |    | 3f54 | WR  |   |   |   |   |   |   | 0000h000min000s001ms084us250ns | 0000h000min000s000ms000us125ns |        |
| -00009 | ffef94  |    | 0000 | WR  |   |   |   |   |   |   | 0000h000min000s001ms086us375ns | 0000h000min000s000ms002us125ns |        |
| -00008 | ffef96  |    | 2781 | WR  |   |   |   |   |   |   | 0000h000min000s001ms086us500ns | 0000h000min000s000ms000us125ns |        |
| -00007 | ffef98  |    | 0000 | WR  |   |   |   |   |   |   | 0000h000min000s001ms088us750ns | 0000h000min000s000ms002us250ns |        |
| -00006 | ffef9a  |    | 1cfb | WR  |   |   |   |   |   |   | 0000h000min000s001ms088us875ns | 0000h000min000s000ms000us125ns |        |
| -00005 | ffef9c  |    | 0000 | WR  |   |   |   |   |   |   | 0000h000min000s001ms091us000ns | 0000h000min000s000ms002us125ns |        |
| -00004 | ffef9e  |    | 167e | WR  |   |   |   |   |   |   | 0000h000min000s001ms091us125ns | 0000h000min000s000ms000us125ns |        |
| -00003 | ffefa0  |    | 0000 | WR  |   |   |   |   |   |   | 0000h000min000s001ms093us375ns | 0000h000min000s000ms002us250ns |        |
| -00002 | ffefa2  |    | 15fb | WR  |   |   |   |   |   |   | 0000h000min000s001ms093us375ns | 0000h000min000s000ms000us000ns |        |
| -00001 | ffefa4  |    | 0000 | WR  |   |   |   |   |   |   | 0000h000min000s001ms095us625ns | 0000h000min000s000ms002us250ns |        |
| +00000 | ffefa6  |    | 0ff6 | WR  |   |   |   |   |   |   | 0000h000min000s001ms095us750ns | 0000h000min000s000ms000us125ns |        |

Figure 6.53 [Trace] Window (Displaying the Result)

If you have trouble viewing a column, drag the header (vertical) bars below the title bar to adjust the width of the column.

- (12) Remove the event points that have been set and clear the trace information. Clicking the right-hand mouse button on the [Breakpoints] window displays a popup menu. Select [Delete All] from this menu to remove all the event points that have been set. Clicking the right-hand mouse button on the [Trace] window displays a further popup menu. Select [Clear] from this menu to clear the trace information. To disable time stamping, select Disabled in the [Clock] combo box of the [Time Stamp] group box on the [General] page of the [Trace Acquisition] dialog box.

### 6.16.3 Statistics

The number of times the internal RAM has been written to can be included in the acquired trace information.

- (1) Make the setting such that a break occurs at the address on the line that has 'p\_sam->s0=a[0];' within the tutorial function (**H'00001082** in this example) (for details on this, refer to section 6.15.1, Software Break Function).
- (2) Select [Reset Go] from the [Debug] menu. Processing stops when the break condition is satisfied, and the [Trace] window then displays trace information.
- (3) Select [Statistic...] from the popup menu that is displayed when you click the right-hand mouse button on the [Trace] window. A message box appears, indicating that the trace data is being loaded, and the [Statistic] dialog box will be displayed.

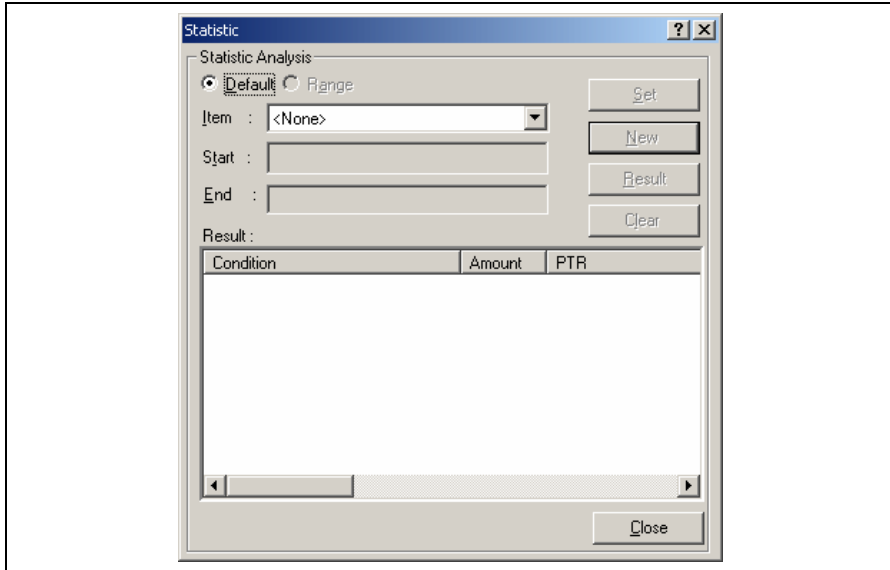

Figure 6.54 [Statistic] Dialog Box

- (4) Select R/W in the [Item] combo box and enter WR in the [Start] edit box. After that, click the [New] button. “R/W=WR” is now displayed in the [Condition] column of the [Result] list box.

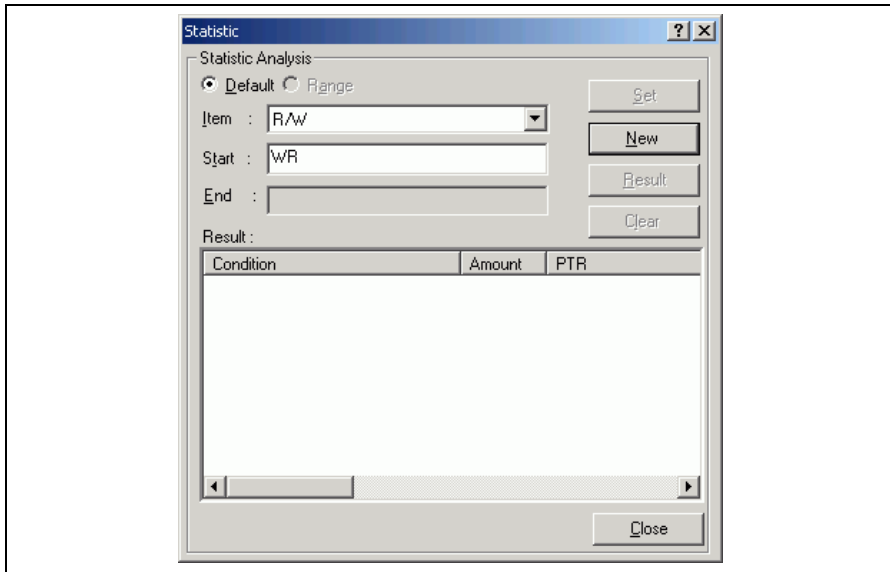

Figure 6.55 [Statistic] Dialog Box (New Condition)

- (5) Then, select Area from the [Item] combo box and enter RAM in the [Start] edit box. After that, click the [Add] button; the new condition is now added to the “R/W=WR” display in the [Condition] column of the [Result] list box, so that it now shows “R/W=WR & Area=RAM”. This completes setting of the condition.

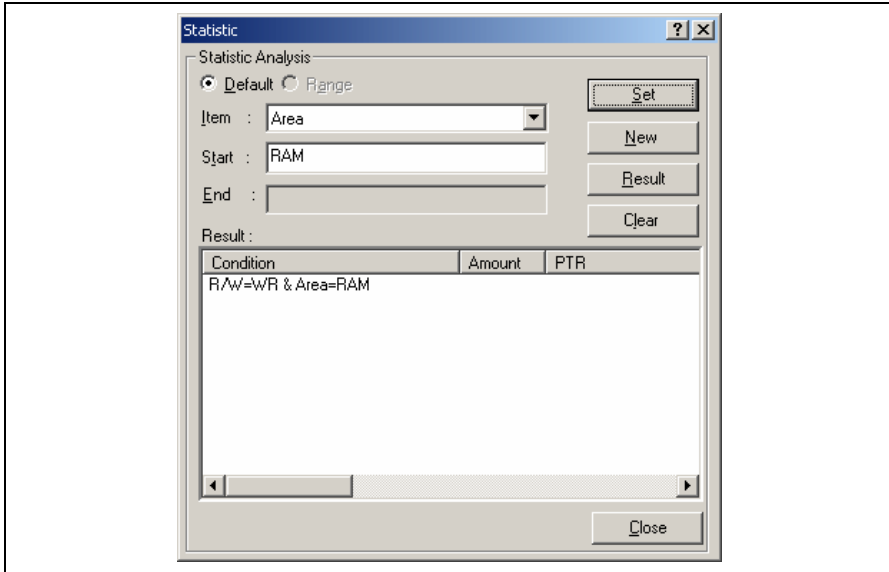

Figure 6.56 [Statistic] Dialog Box (Condition Added)



- (6) To start statistical analysis of the specified condition, press the [Result] button. The number of write operations that satisfy the condition and the PTR values will be displayed.

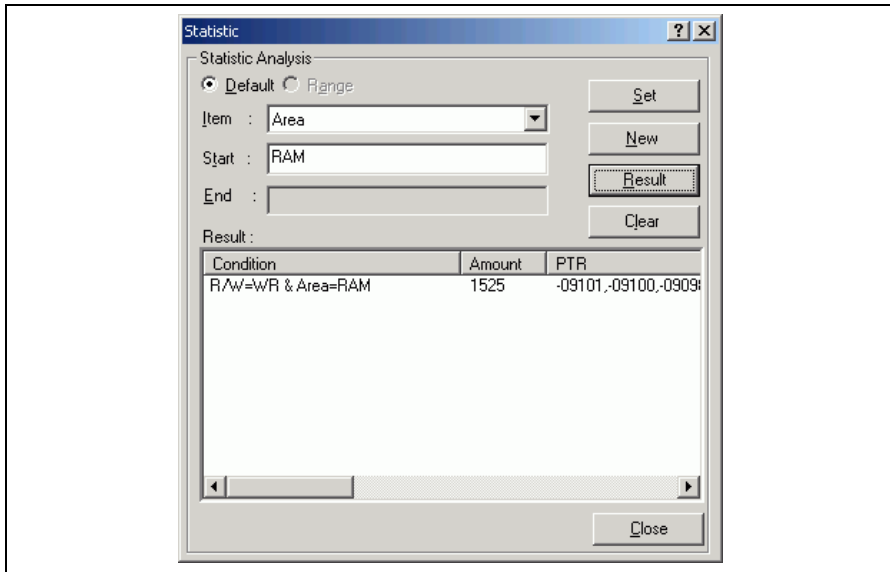

Figure 6.57 [Statistic] Dialog Box (Result of Analysis)

- (7) Click the [Close] button to close the [Statistic] dialog box.
- (8) Remove the event points that have been set and clear the trace information. Clicking the right-hand mouse button on the [Event] window displays a popup menu. Select [Delete All] from this menu to remove all the event points that have been set. Clicking the right-hand mouse button on the [Trace] window displays a further popup menu. Select [Clear] from this menu to clear the trace information.

## 6.16.4 Function Calls

This mechanism is used to only collect trace information on the function calls.

- (1) Make the setting such that a break occurs at the address on the line that has 'p\_sam->s0=a[0];' within the tutorial function (**H'00001082** in this example) (for details on this, refer to section 6.15.1, Software Break Function).
- (2) Select [Reset Go] from the [Debug] menu. Processing stops when the break condition is satisfied, and the [Trace] window then displays trace information.
- (3) Select [Function Call...] from the popup menu displayed by clicking the right-hand mouse button on the [Trace] window. The [Function Call Display] dialog box will be displayed.

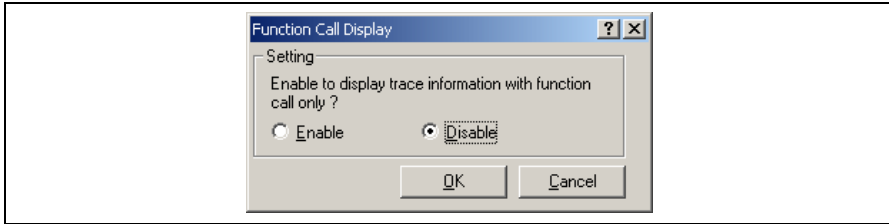

Figure 6.58 [Function Call Display] Dialog Box

- (4) Click the [Enable] radio button and then the [OK] button. Only the information on function calls is now displayed in the [Trace] window (the [Label] column's right-side boundary has been moved to the left in the [Trace] window to show the function calls).

| Label                  | PTR    | Address | Instruction | Data             | R/W  | Area | Status | Clock | Probes | NMI  | IRQ5 |      |
|------------------------|--------|---------|-------------|------------------|------|------|--------|-------|--------|------|------|------|
| PowerON_Reset()        | -09108 | 000400  | MOV.L       | #H'00FFFEFC0,ER7 | 7a07 | RD   | ROM    | PROG  | 1      | 1111 | 1    | 1111 |
| _main                  | -03582 | 001034  | BSR         | @tutorial():8    | 5502 | RD   | ROM    | PROG  | 1      | 1111 | 1    | 1111 |
| tutorial()             | -03578 | 001038  | MOV.L       | ER3,@-ER7        | 0100 | RD   | ROM    | PROG  | 1      | 1111 | 1    | 1111 |
| Sample::Sample()       | -03558 | 002000  | MOV.L       | ER2,@-ER7        | 0100 | RD   | ROM    | PROG  | 1      | 1111 | 1    | 1111 |
| _sbrk                  | -03669 | 001000  | STM.L       | (ER2-ER3),@-SP   | 0110 | RD   | ROM    | PROG  | 1      | 1111 | 1    | 1111 |
| Sample::sort(Long *)   | -01667 | 002068  | STM.L       | (ER2-ER3),@-SP   | 0110 | RD   | ROM    | PROG  | 1      | 1111 | 1    | 1111 |
| Sample::change(Long *) | -00469 | 0020d6  | MOV.L       | ER3,@-ER7        | 0100 | RD   | ROM    | PROG  | 1      | 1111 | 1    | 1111 |

Figure 6.59 [Trace] Window (Function Calls)

- (5) To return the display in the [Trace] window to its previous state, follow the procedure in (3) to display the [Function Call Display] dialog box. Click the [Disable] button and then the [OK] button.
- (6) Remove the event points that have been set and clear the trace information. Clicking the right-hand mouse button on the [Breakpoints] window displays a popup menu. Select [Delete All] from this menu to remove all the event points that have been set. Clicking the right-hand mouse button on the [Trace] window displays a further popup menu. Select [Clear] from this menu to clear the trace information.

## 6.17 Stack Trace Function

The emulator uses the information on the stack to display the function call history.

Notes: 1. This function can be used only when the load module that has the Dwarf2-type debugging information is loaded. Such load module is supported in H8S, H8/300 C/C++ compiler V4.0 or later.

2. For details on the stack trace function, refer to the online help.

- Double-click the [Editor] column in the `sort` function and set a software breakpoint.

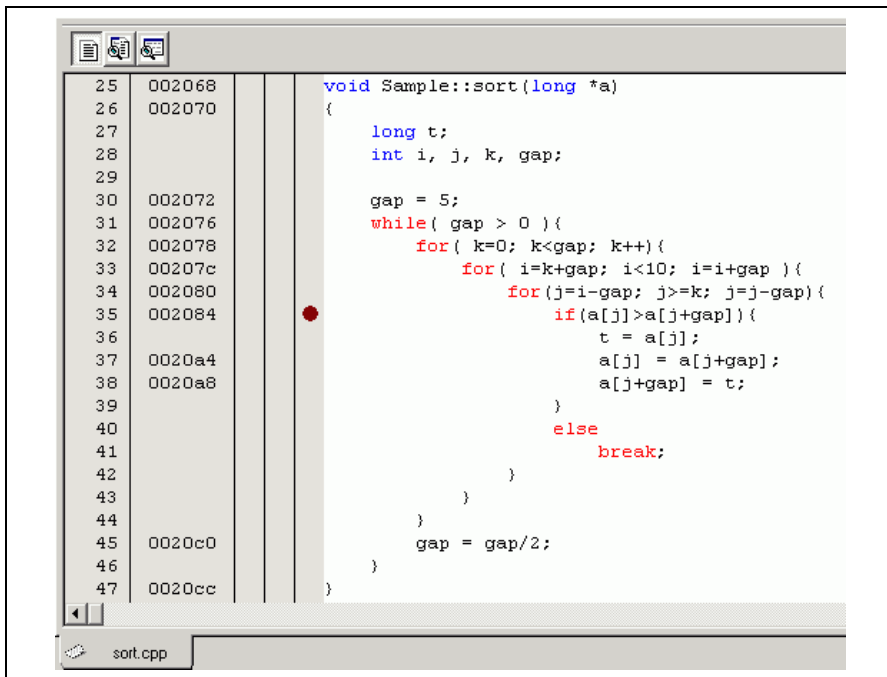

Figure 6.60 [Editor] Window (Software Breakpoint Setting)

- Select [Reset Go] from the [Debug] menu.
- After the break in program execution, select [Stack Trace] from the [Code] submenu of the [View] menu to open the [Stack Trace] window.

| Kind | Name                 | Value      |
|------|----------------------|------------|
| F    | Sample::sort(long *) | { 002084 } |
| F    | tutorial()           | { 00107A } |
| F    | main()               | { 001036 } |
| F    | PowerON_Reset()      | { 00041E } |

**Figure 6.61 [Stack Trace] Window**

Figure 6.61 shows that the position of the program counter is currently at the selected line of the `sort()` function, and that the `sort()` function is called from the `tutorial()` function.

To remove the software breakpoint, double-click the [Editor] column in the `sort` function again.

## 6.18 Performance Measurement Function

Performance measurement by the emulator is in the following modes:

- Time Of Specified Range Measurement
- Start Point To End Point Measurement
- Start Range To End Range Measurement
- Access Count Of Specified Range Measurement
- Called Count Of Specified Range Measurement

In this tutorial, we describe the Time Of Specified Range Measurement.

### 6.18.1 Time Of Specified Range Measurement

(1) Select [Performance Analysis] from the [Performance] submenu of the [View] menu to display the [Select Performance Analysis Type] dialog box.

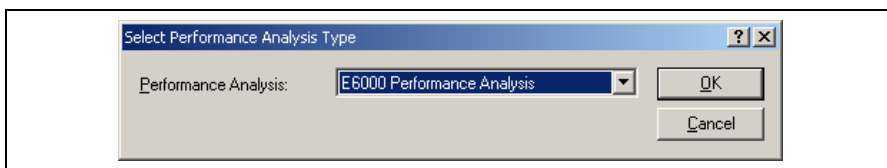

Figure 6.62 [Select Performance Analysis Type] Dialog Box

(2) Select "E6000 Performance Analysis" from the [Performance Analysis] combo box in the [Select Performance Analysis Type] dialog box and click the [OK] button. The [Performance Analysis] window will be displayed.

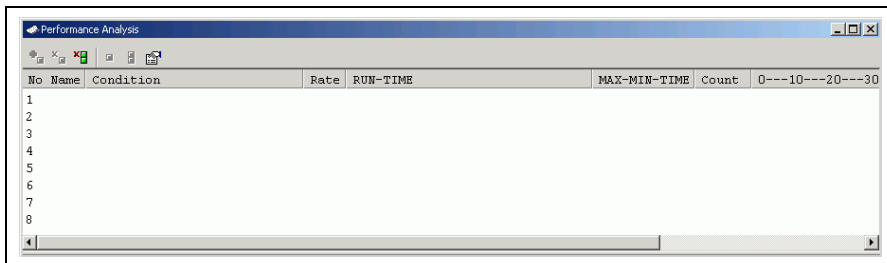
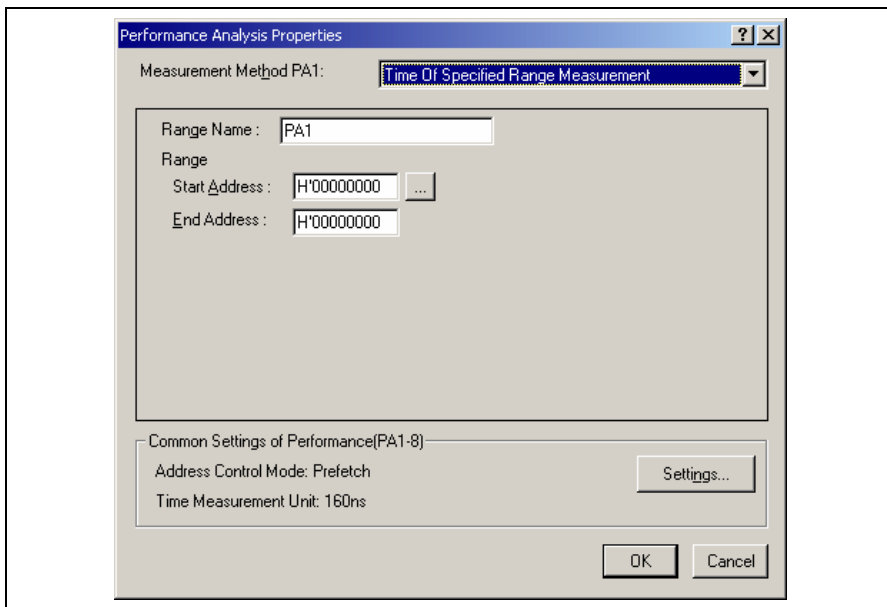

Figure 6.63 [Performance Analysis] Window

- (3) Select the line of the [Performance Analysis] window that has 1 in its [No] column and click the right-hand mouse button to display a popup menu. Select [Set...] from this popup menu to display the [Performance Analysis Properties] dialog box.



**Figure 6.64 [Performance Analysis Properties] Dialog Box**

- (4) Select Time Of Specified Range Measurement from the [Measurement Method PA1] combo box.  
 (5) The parameter settings are as follows.

- Enter "sort" in the [Range Name] edit box.
- Click the [...] button to the right of the [Start Address] edit box to display the [Input Function Range] dialog box. Enter the function name "Sample::sort(long \*)" in the [Function] edit box of this dialog box and then click the [OK] button. The corresponding addresses for the function "Sample::sort(long \*)" will now be set in the [Start Address] and [End Address] edit boxes.

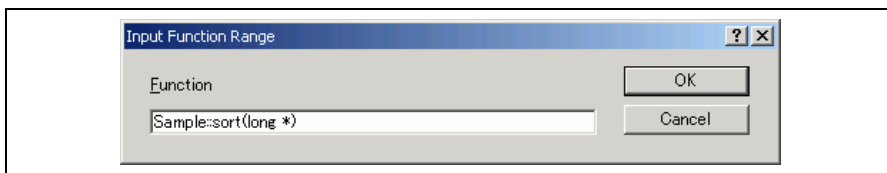

**Figure 6.65 [Input Function Range] Dialog Box**

**Note:** The addresses figured out in the [Input Function Range] dialog box are just for reference. In some cases, the end address of a function may be different. Check the last instruction of the function in the [Disassembly] window to correct the value set in [End Address] so that it will be the address of the last instruction (in general, the last instruction of a function is a RTS instruction). A label name or an expression can be entered instead of an address value in boxes where an address should be entered.

- (6) Click the [Settings...] button in the [Common Settings of Performance(PA1-8)] group box to display the [Common Settings of Performance(PA1-8)] dialog box. Select [PC] from the [Address Control Mode] combo box and then click the [OK] button. PC is now displayed in the [Address Control Mode] text field of the [Common Setting of Performance(PA1-8)] dialog box.

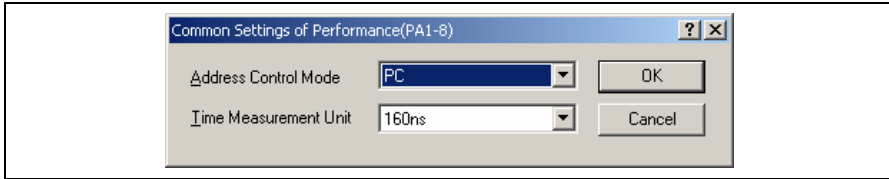

**Figure 6.66 [Common Setting of Performance(PA1-8)] Dialog Box**

- (7) Click the [OK] button to display the content that has been set for line 1 of the [No] column in the [Performance Analysis] window. This completes the settings for a Time Of Specified Range Measurement.

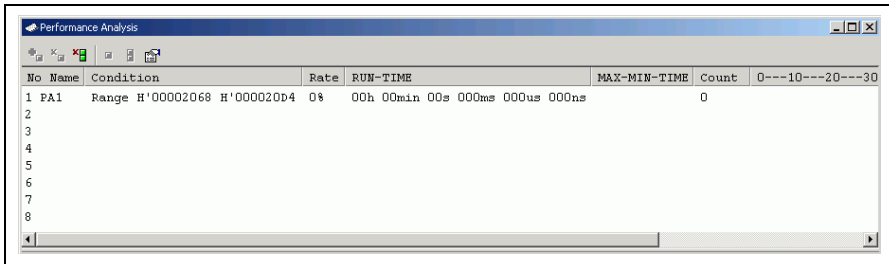

**Figure 6.67 [Performance Analysis] Dialog Box (Setting Completed)**

- (8) Set an event point at the address on the line that has 'p\_sam->change(a);' within the tutorial function (H'0000107 in this example) so that a break occurs when the specified sort function has been executed three times (refer to section 6.15.2, Breaking Execution at Event Points).
- (9) Select [Reset Go] from the [Debug] menu. Processing stops when the break condition is satisfied, and the [Performance Analysis] window then displays the information shown below. The value shown in the [Count] column is 3, which indicates that the sort function has been executed three times and the execution time.

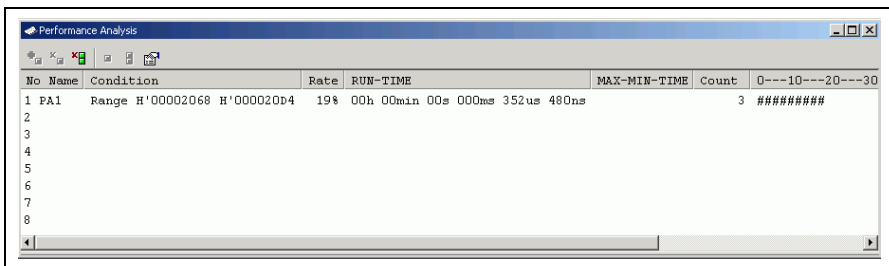

**Figure 6.68 [Performance Analysis] Dialog Box (Displaying the Result)**

- (10) Delete the setting for performance analysis and remove the event point. Click the right-hand mouse button on the [Performance Analysis] window to display a popup menu. Select [Reset All] from this popup menu to delete all of the settings. Clicking the right-hand mouse button on the [Event] window also displays a popup menu. Select [Delete All] from this popup menu to remove all the event points that have been set.

## 6.19 Monitor Function

The emulator allows monitoring of the content of specified addresses in memory during execution of the user program. In this example, we monitor the content of the address range where variable `a` of the `tutorial` function is stored.

- (1) Select the [CPU] submenu from the [View] menu. Then selecting [Monitor Setting...] from the [Monitor] submenu displays the [Monitor Setting] dialog box.

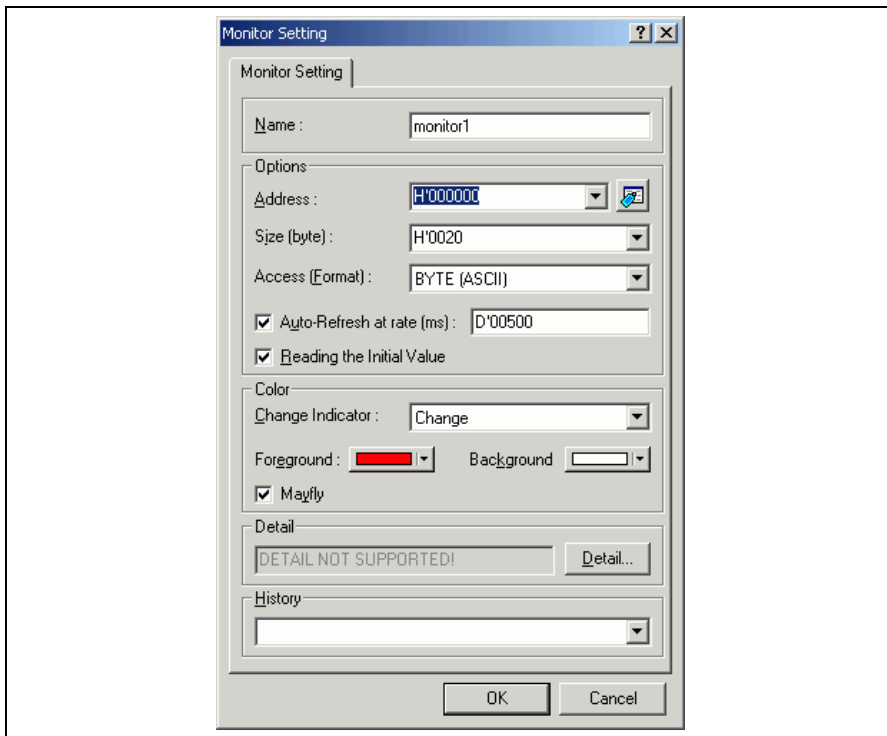

Figure 6.69 [Monitor Setting] Dialog Box



(2) Set the items in the [Monitor Setting] dialog box as follows:

- Enter monitor1 in the [Name] edit box.
- Set the parameters in the [Options] group box as follows:
  - (a) Use the [Locals] window to refer to the address on the line where variable a, which is defined within the tutorial function, is allocated and enter this address in the [Address] edit box. In this example, enter **H'00FFEF80**.
  - (b) Enter **H'50** in the [Size] edit box.
  - (c) Select **BYTE (HEX)** from the [Access] combo box.
  - (d) Check the [Auto-refresh at rate] check box and enter **D'00500**.
  - (e) Check the [Reading the Initial Value] check box.
- Set the parameters in the [Color] group box as follows:
  - (a) Select **Change** from the [Change Indicator] combo box.
  - (b) Select **red** and **white** in the [Foreground] and [Background] combo boxes, respectively.
  - (c) Check the [Mayfly] check box.

Note: Depending on the operating system in use, the foreground and background colors may not be selectable.

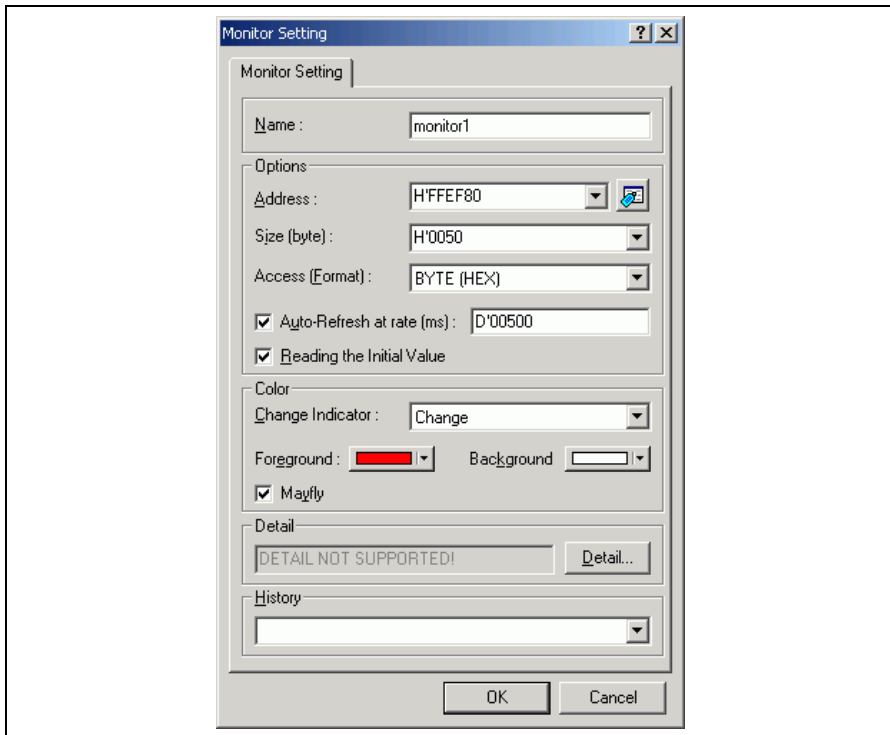

Figure 6.70 [Monitor Setting] Dialog Box (Setting Completed)

(3) Click the [OK] button to open the [Monitor] window.

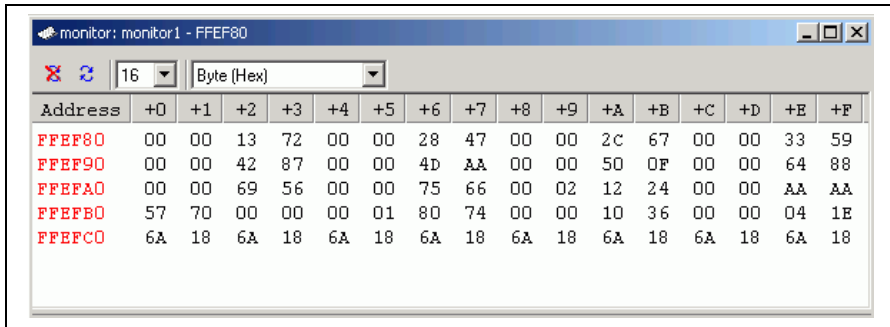

Figure 6.71 [Monitor] Window

(4) Select [Reset Go] from the [Debug] menu. When the content of the address range changes with execution, the updated values are red (i.e. the color that was selected in the [Foreground] and [Background] combo boxes). Values will be displayed in black if they have not been updated or a certain period of time has elapsed since the last update.

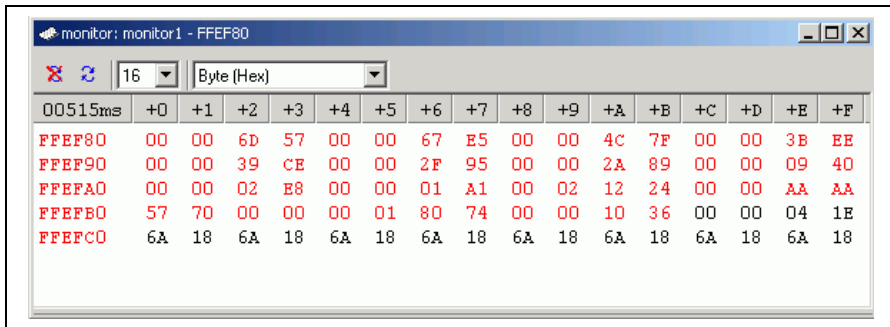

Figure 6.72 [Monitor] Window (during Execution)

(5) After you have finished checking the states in the [Monitor] window, select [Halt Program] from the [Debug] menu to halt the program's execution.

## 6.20 What Next?

This tutorial has described the major features of the emulator and the use of the High-performance Embedded Workshop.

Sophisticated debugging can be carried out by using the emulation functions that the emulator offers. This provides for effective investigation of hardware and software problems by accurately isolating and identifying the conditions under which such problems arise.

## Section 7 Hardware Specifications Specific to This Product

This section describes the hardware specifications on the H8S/2678R E6000 emulator.

### 7.1 H8S/2678R E6000 Emulator Specifications

The H8S/2678R E6000 emulator supports the system development using the following microcomputers:

- H8S/2678 group and H8S/2678R group
- H8S/2668 group
- H8S/2368 group
- H8S/2378 group and H8S/2378R group

#### 7.1.1 Supported MCUs and User System Interface Cables

See the development support tool catalog for the MCU type names and packages supported by the E6000 emulator and for the combination of the E6000 user system interface cables and optional boards.

#### 7.1.2 Operating Voltage and Frequency Specifications

Table 7.1 shows the MCU operating voltage and frequency specifications supported by the E6000 emulator. If the emulator is used in an environment that exceeds the operating voltage range and operating frequency range guaranteed for the MCU operation, normal emulator operation is not guaranteed.

**Table 7.1 Operating Voltage and Frequency Specifications**

| No. | MCU Types  | Operating Voltage (V) | Operating Frequency ( $\phi$ ) (MHz) |
|-----|--|-----------------------|--------------------------------------|
| 1   | H8S/2678 group   | 3.0-3.6               | 2-33                                 |
| 2   | H8S/2678R group<br>H8S/2668 group<br>H8S/2368 group<br>H8S/2378 group<br>H8S/2378R group | 3.0-3.6               | 8-33                                 |

## NOTE

**For details on the operating voltage and frequency specifications, refer to the MCU hardware manual.**

## 7.2 User System Interface

All user system interface signals are directly connected to the MCU in the emulator with no buffering except for those listed below which are connected to the MCU through control circuits:

- NMI
- RESET
- MD2, MD1, MD0
- XTAL
- EXTAL
- WAIT

### 7.2.1 Signal Protection

All user system interface signals are protected from over- or under-voltage by use of diode arrays except for the AVcc and Vref.

The Vcc pins (except for the AVcc pin) at the head of the user system interface cable are connected together. The emulator monitors the voltage level of the Vcc pins and displays the power-supply status in the [Extended Monitor] window.

### 7.2.2 User System Interface Circuits

The interface circuit between the MCU in the emulator and the user system has a signal delay of about 8 ns due to the user system interface cable. Thus high-impedance signals will be pulled up to the high level by pull-up resistors. When connecting the emulator to a user system, adjust the user system hardware to compensate for propagation delays.

**Default:**

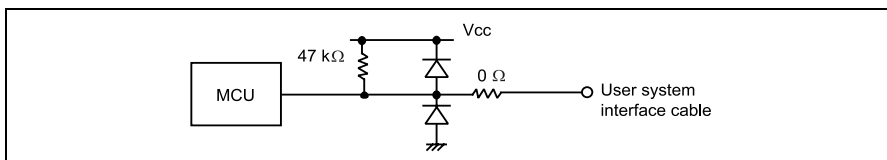

Figure 7.1 Default User System Interface Circuit

**Mode Pins (MD2, MD1 and MD0), NMI, and WAIT:** The NMI signal is input to the MCU through the emulator control circuit. The rising/falling time of the NMI signal must be 8 ns/V or less. The mode pins are only monitored. The CPU mode depends on the High-performance Embedded Workshop Configuration settings.

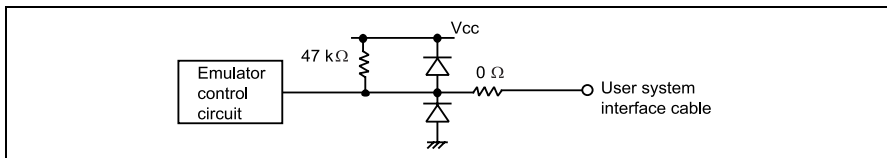
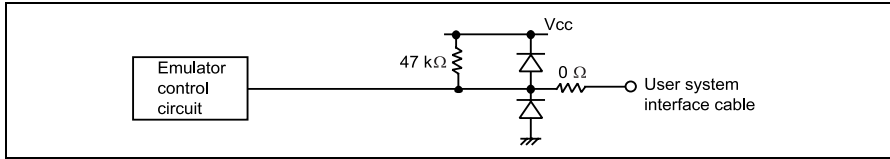

Figure 7.2 User System Interface Circuit for MD2, MD1, MD0, NMI, and WAIT

**RESET:**



**Figure 7.3 User System Interface Circuit for RESET**

**P40 to P47 (pins used for AN0 to AN7 and DA0 to DA1), P54 to P57 (pins used for AN12 to AN15 and DA2 to DA3) Vcc, AVcc, AVss, and Vref:** Pins P50 to P57 are also used for interrupt inputs. When the user system is not connected and pull-up resistors are removed, input will be undefined and may illegally detect an interrupt. When P50 to P57 are used to input interrupt signals, it is recommended to connect the pull-up resistors to these pins.

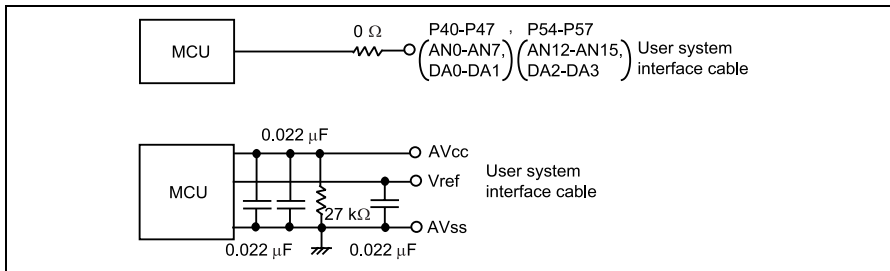

**Figure 7.4 User System Interface Circuit for P40 to P47, P54 to P57, Vcc, AVcc, AVss, and Vref Signals**

### 7.3 Differences between MCU and Emulator

When the emulator is turned on or initialized, or the system is reset, there are some differences in the initial values in some of the general registers between the MCU and the emulator as shown in table 7.2.

**Table 7.2 Initial Value Differences between MCU and Emulator**

| Status                   | Register   | E6000 Emulator  | MCU   |
|--------------------------|------------|---|---|
| Power-on/<br>initialized | PC         | Reset vector value                                      | Reset vector value                                      |
|                          | ER0 to ER6 | Undefined   | Undefined   |
|                          | ER7 (SP)   | H'10  | Undefined   |
|                          | CCR        | The I mask is set to 1 and the other bits are undefined | The I mask is set to 1 and the other bits are undefined |
| Reset command            | PC         | Reset vector value                                      | Reset vector value                                      |
|                          | ER0 to ER6 | Undefined   | Undefined   |
|                          | ER7 (SP)   | H'10  | Undefined   |
|                          | CCR        | The I mask is set to 1 and the other bits are undefined | The I mask is set to 1 and the other bits are undefined |

#### 7.3.1 A/D Converter and D/A Converter

Due to the use of a user system interface cable, there is a slight degradation in the A/D and D/A conversion than that quoted in the hardware manual for the MCU being emulated.

#### 7.3.2 Operating Frequency for the H8S/2378, H8S/2378R, and H8S/2368

The maximum operating frequency for the H8S/2378, H8S/2378R, and H8S/2368 supported by this emulator is 33 MHz.

## Section 8 Software Specifications Specific to This Product

This section describes the software specifications of the H8S/2678R E6000 emulator.

### 8.1 Software Specifications of the H8S/2678R E6000 Emulator

Information specific to this emulator is given below.

#### 8.1.1 Target Hardware

This emulator software conforms to the H8S/2678R E6000 (HS2678REPI61H) and H8S/2678 E6000 (HS2678EPI61H) emulators.

#### 8.1.2 Selectable Platforms

The debugging platforms selectable in this emulator are listed below. The MCUs that can be emulated depends on the debugging platform selected.

**Table 8.1 Selectable Target Platforms**

| <b>Debugging Platform</b>         | <b>Remark</b>   |
|-----------------------------------|---|
| H8S/2378 E6000 Emulator CPU 2000  | For emulation of the MCUs that have the H8S/2000 CPU as the core. |
| H8S/2678 E6000 Emulator CPU 2600  | For emulation of the MCUs that have the H8S/2600 CPU as the core. |
| H8S/2678R E6000 Emulator CPU 2600 | For emulation of the MCUs that have the H8S/2600 CPU as the core. |

### 8.1.3 [Configuration Properties] Dialog Box ([General] Page)

Items that can be set in this dialog box are listed below.

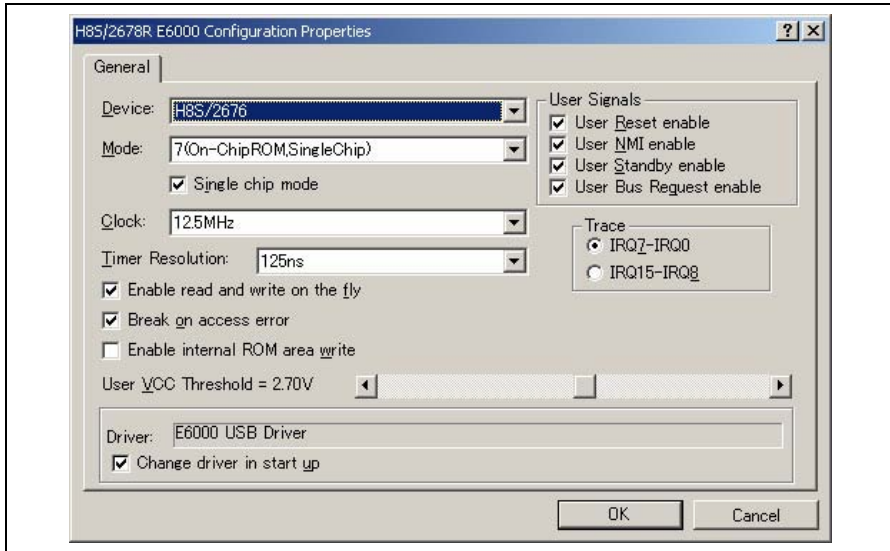

Figure 8.1 [Configuration Properties] Dialog Box ([General] Page)

#### [General] page

|                    |   |
|--------------------|---|
| [Device]           | Selects the MCU to be emulated. To use an MCU not included in the list, select [Custom] to specify the functions required for this MCU. See the hardware manual for details.  |
| [Mode]             | Selects the MCU's operating mode.   |
| [Single chip mode] | Only available in mode 7. Check this box to use the emulator in the single-chip mode. This prevents setting of the external areas as the user read/write area or the user read-only area. The emulator enters the single-chip mode by setting the EXPE bit in the SYSCR register to 0. Specify the EXPE bit in the user program.  |
| [Clock]            | Selects the speed of the MCU's clock.   |
| [Timer Resolution] | Selects the resolution of the timer for use in execution time measurement. The value 20 ns, 125 ns, 250 ns, 500 ns, 1 $\mu$ s, 2 $\mu$ s, 4 $\mu$ s, 8 $\mu$ s, or 16 $\mu$ s can be selected.<br><br>The timer for execution time measurement has a 40-bit counter.<br><br>At 20 ns the maximum time that can be measured is about six hours, and at 16 $\mu$ s the maximum time is about 200 days.<br><br>When the counter overflows, the maximum time possible for measurement will be displayed with prompt ">" that indicates that the counter has overflowed. |



[Enable read and write on the fly]

When this box is checked, it is possible to access the target system memory while the user program is running. Do not check this box if you require realtime emulation.

- When accessing the internal ROM, internal RAM, or emulation memory

High-performance Embedded Workshop accesses the memory directly as the bus mastership is released to the emulator without breaking the user program. The MCU waits for approximately 80 us while operating at 25 MHz.

- When accessing the internal I/O, DTCRAM, or user memory

Memory is accessed with breaking the user program. This pause is approximately 2 ms while operating at 25 MHz.

When the internal RAM is disabled, an access to this area is not available during the user program execution.

Note:

When the content of the memory is modified during the user program execution (e.g. modification in the [Memory] window or by the MEMORY\_EDIT command), High-performance Embedded Workshop reads the content to update the value.

High-performance Embedded Workshop also reads the memory content when the content has been updated by operations such as selecting [Refresh] from the popup menu of the [Memory] window. In this case, the content of memory is read and then updated in each of the windows.

To prevent unnecessary reading of the memory content, close the window displaying the memory content (such as the [Memory] or [Disassembly] window) or make the settings so that the content will not be updated.

The [Monitor] window, or the [Watch] window that satisfies the conditions listed below displays the memory content. Note that, however, opening these windows does not prevent realtime operation because the method of updating the memory content in these windows is different.

Conditions:

1. Registered symbols are only allocated to general-purpose registers.
  2. Registered symbols are only allocated to the monitor range set by the [Monitor] function (the mark R is colored in blue).
  3. Registered symbols are comprised of those with the conditions 1 and 2 listed above.
-

[General] page (cont)

|                                  |   |
|----------------------------------|---|
| [Break on access error]          | When this box is checked, a break (the user program stops) occurs if your program accesses an access-prohibited area or writes to a write-protected area.   |
| [Enable internal ROM area write] | When this box is checked, writing to the internal ROM area is enabled. For the result of writing, see the [Extended Monitor] window.  |
| [User VCC Threshold]             | Sets the voltage level for the user system. [Down] will be displayed in [User System Voltage] of the [Extended Monitor] window when the actual user VCC of the target system is lower than the specified value. |
| [User Signals]                   | When this box is checked, the reset, NMI, standby, and bus request signals from the user system are enabled.  |
| [Trace]                          | Selects the IRQ inputs to be acquired by tracing.<br>IRQ7-IRQ0: IRQ0 to IRQ7 are acquired.<br>IRQ15-IRQ8: IRQ8 to IRQ15 are acquired.   |
| [Driver]                         | Displays the E6000 driver that is currently installed.  |
| [Change driver in start up]      | When this box is checked, selection of a driver will be available next time the emulator is connected.  |

The MCUs selectable by the [Device] option and options that depend on the MCUs are listed below. To emulate an MCU with a description in the Expansion Hardware column, connect the correct expansion hardware.

**Table 8.2 Environment for the H8S/2378 E6000 Emulator CPU 2000 Debugging Platform**

| [Device] Option | [Mode] Option   | [Clock] Option | Expansion Hardware |
|-----------------|---|----------------|--------------------|
| Custom          | The MCU previously selected   |                |                    |
| H8S/2378        | 1 (advanced mode, 16bit Bus)  | Main: 12 MHz   | None               |
| H8S/2377        | 2 (advanced mode, 8bit Bus)   | Main: 25 MHz   |                    |
| H8S/2376        | 4 (advanced mode, 8bit Bus, on-chip ROM)  | Main: 33 MHz   |                    |
| H8S/2375        | 7 (advanced mode, on-chip ROM, single chip)   | Main: Target   |                    |
| H8S/2374F       | Target  | Main: Target/2 |                    |
| H8S/2372F       |   |                |                    |
| H8S/2371F       |   |                |                    |
| H8S/2370F       |   |                |                    |
| H8S/2378R       |   |                |                    |
| H8S/2377R       |   |                |                    |
| H8S/2375R       |   |                |                    |
| H8S/2374RF      |   |                |                    |
| H8S/2372RF      |   |                |                    |
| H8S/2371RF      |   |                |                    |
| H8S/2370RF      |   |                |                    |
| H8S/2368        |   |                |                    |
| H8S/2367        |   |                |                    |
| H8S/2366        |   |                |                    |
| H8S/2365        |   |                |                    |
| H8S/2364F       |   |                |                    |
| H8S/2362F       |   |                |                    |
| H8S/2361F       |   |                |                    |
| H8S/2360F       |   |                |                    |
| H8S/2363        | 1 (advanced mode, 16bit Bus)  |                |                    |
| H8S/2373        | 2 (advanced mode, 8bit Bus)   |                |                    |
| H8S/2373R       | Target  |                |                    |
| Notes:          | 1. Target in [Mode] is only available when the target system is connected.                |                |                    |
|                 | 2. Target and Target/2 in [Clock] are only available when the target system is connected. |                |                    |

**Table 8.3 Environment for the H8S/2678 E6000 Emulator CPU 2600 Debugging Platform**

| [Device] Option | [Mode] Option   | [Clock] Option | Expansion Hardware |
|-----------------|---|----------------|--------------------|
| Custom          | The MCU previously selected   |                |                    |
| H8S/2677        | 1 (advanced mode, 16bit Bus)  | Main: 12 MHz   | None               |
| H8S/2676        | 2 (advanced mode, 8bit Bus)   | Main: 25 MHz   |                    |
| H8S/2675        | 4 (advanced mode, 8bit Bus, on-chip ROM)  | Main: 33 MHz   |                    |
| H8S/2673        | 5 (advanced mode, 16bit Bus, on-chip ROM, external ROM activation)                        | Main: Target   |                    |
|                 | 6 (advanced mode, 8bit Bus, on-chip ROM, external ROM activation)                         | Main: Target/2 |                    |
|                 | 7 (advanced mode, on-chip ROM, single chip)   |                |                    |
|                 | Target  |                |                    |
| H8S/2670        | 1 (advanced mode, 16bit Bus)  |                |                    |
|                 | 2 (advanced mode, 8bit Bus)   |                |                    |
|                 | Target  |                |                    |
| Notes:          | 1. Target in [Mode] is only available when the target system is connected.                |                |                    |
|                 | 2. Target and Target/2 in [Clock] are only available when the target system is connected. |                |                    |

**Table 8.4 Environment for the H8S/2678R E6000 Emulator CPU 2600 Debugging Platform**

| [Device] Option | [Mode] Option  | [Clock] Option | Expansion Hardware |
|-----------------|--|----------------|--------------------|
| Custom          | The MCU previously selected  |                |                    |
| H8S/2667        | 1 (advanced mode, 16bit Bus)   | Main: 12 MHz   | None               |
|                 | 2 (advanced mode, 8bit Bus)  | Main: 25 MHz   |                    |
|                 | 4 (advanced mode, 8bit Bus, on-chip ROM)   | Main: 33 MHz   |                    |
|                 | 5 (advanced mode, 16bit Bus, on-chip ROM, external ROM activation)                     | Main: Target   |                    |
|                 | 6 (advanced mode, 8bit Bus, on-chip ROM, external ROM activation)                      | Main: Target/2 |                    |
|                 | 7 (advanced mode, on-chip ROM, single chip)  |                |                    |
|                 | Target   |                |                    |
| H8S/2674R       | 1 (advanced mode, 16bit Bus)   |                |                    |
|                 | 2 (advanced mode, 8bit Bus)  |                |                    |
|                 | Target   |                |                    |
| Notes: 1.       | Target in [Mode] is only available when the target system is connected.                |                |                    |
| 2.              | Target and Target/2 in [Clock] are only available when the target system is connected. |                |                    |

### 8.1.4 [Configuration Properties] Dialog Box ([Custom] Page)

Items that can be set in this dialog box are listed below.

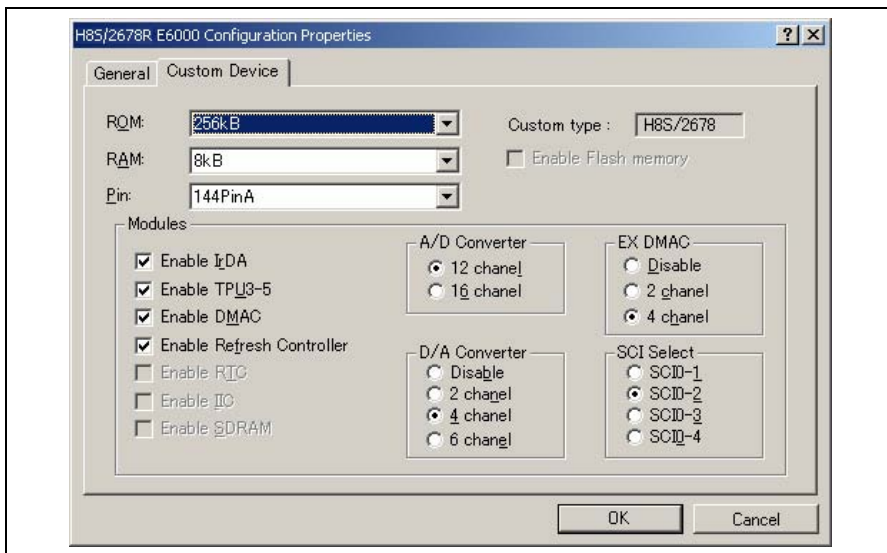

Figure 8.2 [Configuration Properties] Dialog Box ([Custom Device] Page)

|       |  |
|-------|--|
| [ROM] | <p>Specify the internal ROM area size.</p> <p><b>None:</b> -</p> <p><b>32kB:</b> Sets the internal ROM area to be 32 kbytes (H'000000 to H'007FFF).</p> <p><b>64kB:</b> Sets the internal ROM area to be 64 kbytes (H'000000 to H'00FFFF).</p> <p><b>128kB:</b> Sets the internal ROM area to be 128 kbytes (H'000000 to H'01FFFF).</p> <p><b>256kB:</b> Sets the internal ROM area to be 256 kbytes (H'000000 to H'03FFFF).</p> <p><b>384kB:</b> Sets the internal ROM area to be 384 kbytes (H'000000 to H'05FFFF).</p> <p><b>512kB:</b> Sets the internal ROM area to be 512 kbytes (H'000000 to H'07FFFF).</p>   |
| [RAM] | <p>Specify the internal RAM area size.</p> <p><b>2kB:</b> Sets the internal RAM area to be 2 kbytes (H'FFE800 to H'FFEFBF and H'FFFFC0 to H'FFFFFF).</p> <p><b>4kB:</b> Sets the internal RAM area to be 4 kbytes (H'FFE000 to H'FFEFBF and H'FFFFC0 to H'FFFFFF).</p> <p><b>8kB:</b> Sets the internal RAM area to be 8 kbytes (H'FFD000 to H'FFEFBF and H'FFFFC0 to H'FFFFFF).</p> <p><b>12kB:</b> Sets the internal RAM area to be 12 kbytes (H'FFC000 to H'FFEFBF and H'FFFFC0 to H'FFFFFF).</p> <p><b>16kB:</b> Sets the internal RAM area to be 16 kbytes (H'FFB000 to H'FFEFBF and H'FFFFC0 to H'FFFFFF).</p> <p><b>24kB:</b> Sets the internal RAM area to be 24 kbytes (H'FF9000 to H'FFEFBF and H'FFFFC0 to H'FFFFFF).</p> <p><b>32kB:</b> Sets the internal RAM area to be 32 kbytes (H'FF7000 to H'FFEFBF and H'FFFFC0 to H'FFFFFF).</p> <p><b>48kB:</b> Sets the internal RAM area to be 48 kbytes (H'FF3000 to H'FFEFBF and H'FFFFC0 to H'FFFFFF).</p> <p><b>64kB:</b> Sets the internal RAM area to be 64 kbytes (H'FEF000 to H'FFEFBF and H'FFFFC0 to H'FFFFFF).</p> <p><b>80kB:</b> Sets the internal RAM area to be 80 kbytes (H'FEB000 to H'FFEFBF and H'FFFFC0 to H'FFFFFF).</p> <p><b>96kB:</b> Sets the internal RAM area to be 96 kbytes (H'FE7000 to H'FFEFBF and H'FFFFC0 to H'FFFFFF).</p> <p><b>128kB:</b> Sets the internal RAM area to be 128 kbytes (H'FDF000 to H'FFEFBF and H'FFFFC0 to H'FFFFFF).</p> |
| [Pin] | <p>Specify the product package:</p> <p><b>144PinA</b></p> <p><b>144PinB</b></p> <p><b>120Pin</b></p> <p><b>144PinE</b></p> <p><b>144PinS</b></p> <p><b>120PinE</b></p> <p><b>120PinS</b></p>   |

[Modules]

Check this box to validate on-chip peripherals.

**Enable IrDA:** Enables IrDA.

**Enable TPU3-5:** Enables TPU3 to TPU5. TPU0 to TPU2 are always available.

**Enable DMAC:** Enables DMAC.

**Enable Refresh Controller:** Enables the refresh controller.

**Enable RTC:** Enables RTC.

**Enable IIC:** Enables IIC.

**Enable SDRAM:** Enables the synchronous DRAM interface.

**A/D Converter:** Selects the number of channels in the A/D converter.

**12 channel:** 12 channels are used in the A/D converter.

**16 channel:** 16 channels are used in the A/D converter.

**D/A Converter:** Selects the number of channels in the D/A converter.

**Disable:** No D/A converter is incorporated.

**2 channel:** 2 channels are used in the D/A converter.

**4 channel:** 4 channels are used in the D/A converter.

**6 channel:** 6 channels are used in the D/A converter.

**EX DMAC:** Selects the number of EX-DMAC channels.

**Disable:** No EX-DMAC is incorporated.

**2 channel:** 2 channels are used in EX-DMAC.

**4 channel:** 4 channels are used in EX-DMAC.

**SCI Select:** Selects the number of SCI channels.

**SCI0-1:** Enables SCI0 and SCI1.

**SCI0-2:** Enables SCI0 to SCI2.

**SCI0-3:** Enables SCI0 to SCI3.

**SCI0-4:** Enables SCI0 to SCI4.

---

[Custom type]

H8S/2678R or H8S/2678 is displayed here depending on the debugging platform selected.

---

### 8.1.5 Memory Mapping Function

This emulator supports four blocks of user memory. These can be 256 kbytes or 1 Mbyte each, depending on the SIMM fitted. Each block can be placed in the address space on a 256-kbyte or 1-Mbyte boundary.

The memory mapping has a granularity of H'40 (D'64) bytes. Each 64-byte block can be set to the emulation memory or external memory and can be access-prohibited, write-protected or read-write.

Note: The minimum unit available for mapping is a block (64 bytes).

### 8.1.6 [Status] Window

Selecting [View -> CPU -> Status] or clicking the [Status Display] toolbar button displays the [Status] window. The [Status] window has three sheets. This emulator displays the following items.

(1) [Memory] Sheet

Selecting the [Memory] tab on the [Status] window displays this sheet.

**Table 8.5 [Memory] Sheet Items**

| [Item] Column               | [Status] Column  |
|-----------------------------|--|
| Target Device Configuration | Displays memory mapping.                               |
| System Memory Resources     | Displays the memory resource of the emulator hardware. |
| Program Name                | Displays the program file name.                        |



(2) [Platform] Sheet

Selecting the [Platform] tab on the [Status] window displays this sheet.

**Table 8.6 [Platform] Sheet Items**

| [Item] Column       | [Status] Column  |
|---------------------|--|
| Connected To:       | Displays emulator name (driver used).  |
| CPU                 | Displays the target MCU name.  |
| Mode                | Displays the selected mode.  |
| Clock source        | Displays the selected clock.   |
| Run status          | Displays the execution status.<br><b>Break:</b> The user program breaks<br><b>Running:</b> The user program is running   |
| Cause of last break | Displays the cause of the emulator stopping at break.<br><b>Ready:</b> User program not executed (immediately after starting the High-performance Embedded Workshop)<br><b>User Break:</b> Break by the user<br><b>Software Break:</b> Break by software breakpoint<br><b>On Chip Break A:</b> Break by On Chip Break<br><b>Complex Event System:</b> Break by complex event system<br><b>Stepping Completed:</b> Break by stepping completed<br><b>Stepping Aborted:</b> Break by stepping aborted<br><b>ROM Write Access Break:</b> Break by writing to ROM<br><b>Write-protect Access Break:</b> Break by writing to read-only memory<br><b>Unused Area Access Break:</b> Break by accessing to guarded memory<br><b>Performance Break:</b> Break by Performance Analysis<br><b>Invalid breakpoint:</b> Break by break-instruction without Software Break |
| Event Time Count    | Displays the measured result of the timer between events.  |
| Run Time Count      | Displays the total execution time of the program.  |

(3) [Events] Sheet

Selecting the [Events] tab on the [Status] window displays this sheet.

**Table 8.7 [Events] Sheet Item**

| [Item] Column | [Status] Column   |
|---------------|---|
| Resources     | Displays the resource information and the information on events such as the breakpoint. |

### 8.1.7 Extended Monitor Function

Selecting [View -> CPU -> Extended Monitor] or clicking the [Extended Monitor] toolbar button displays the [Extended Monitor] window. This emulator displays the following items.

**Table 8.8 [Extended Monitor] Window Items**

| [Item] Column       | [Value] Column  |
|---------------------|---|
| User Standby        | Displays the status of the standby pin.   |
| User NMI            | Displays the status of the NMI pin.   |
| User Reset          | Displays the status of the reset pin.   |
| User Wait           | Displays the status of the wait pin (if no corresponding pins exist, "Inactive" is displayed).  |
| User System Voltage | Displays whether or not the user VCC is equal to or exceeds the value set in [User VCC Threshold] on the [General] page of the [Configuration Properties] dialog box.   |
| User Cable          | Displays whether or not the user cable is connected.  |
| Running status      | <p>Displays the address bus value in the MCU and the status of the CPU while the user program is running, and the cause of a break while the user program is halted.</p> <p><b>Break = &lt;Cause of break&gt;</b>: Displays the cause of a break.</p> <p><b>Address = &lt;Address bus value&gt;</b>: Displays the address bus value during the user program execution.</p> <p><b>Status = &lt;Status of the CPU&gt;</b>: Displays the status of the CPU.</p> <p><b>PREFETCH</b>: CPU instruction prefetch cycles<br/> <b>DATA</b>: CPU data access cycles<br/> <b>DMAC</b>: Operation of DMAC<br/> <b>DTC</b>: Operation of DTC<br/> <b>SLEEP</b>: Sleep mode<br/> <b>STANDBY</b>: Standby mode<br/> <b>REFRESH</b>: Refresh cycles</p> |
| ROM Write           | <p>Displays whether or not the ROM has been written to during the user program execution.</p> <p>Once the ROM has been written to, the state is retained until the Configure Platform is set again.</p>   |
| Target Mode         | Displays the mode to be input from the user system.   |
| Target Clock        | Displays whether or not there is a clock signal to be input from the user system.   |

Note: In this emulator, the update interval in the [Extended Monitor] window cannot be selected or changed.

### 8.1.8 Signals to Indicate Bus States and Areas

The following tables show examples of signals to indicate the bus states and areas that can be acquired by the emulator.

**Table 8.9 Bus State Signals Acquired by the Emulator**

| Bus State    | Trace Display (Status) | Description            |
|--------------|------------------------|------------------------|
| CPU Prefetch | PROG                   | CPU prefetch cycles    |
| CPU Data     | DATA                   | CPU data access cycles |
| Refresh      | REFRESH                | Refresh cycles         |
| DMAC         | DMAC                   | DMAC cycles            |
| DTC          | DTC                    | DTC cycles             |
| Other        | OTHER                  | Others                 |

**Table 8.10 Area Signals Acquired by the Emulator**

| Area              | Trace Display (Area) | Description           |
|-------------------|----------------------|-----------------------|
| On-chip ROM       | ROM                  | ROM                   |
| On-chip RAM       | RAM                  | RAM                   |
| On-chip I/O 16bit | I/O-16               | 16-bit I/O            |
| On-chip I/O 8bit  | I/O-8                | 8-bit I/O             |
| External 16bit    | EXT-16               | 16-bit EXT (external) |
| External 8bit     | EXT-8                | 8-bit EXT (external)  |
| DTC RAM           | RAM/DTC              | DTCRAM                |

Note: The signals to indicate bus states and areas are used to set the [Bus/Area] condition of the event point. They can also be acquired as the trace information. The bus state signals are also used to set the condition not to acquire the trace ([Suppress] option) and in the Access Count Of Specified Range Measurement mode for measuring the hardware performance ([Access Type] option).

### 8.1.9 Monitoring Function

This emulator incorporates the bus monitoring circuit as the standard, which thus allows a use of the monitoring function to update the content of memory without affecting the realtime operation.

#### 8.1.10 Trigger Points

This emulator incorporates the bus monitoring circuit as the standard, which thus allows a use of trigger points that can be set on the [Trigger] sheet in the [Event] window.

### 8.1.11 Trace Information

Selecting [View -> Code -> Trace] or clicking the [Trace] toolbar button displays the [Trace] window. Trace information that can be acquired by the emulator and trace information items to be displayed are as listed below.

|                        |   |
|------------------------|---|
| [PTR]                  | Cycle number in the trace buffer. When the most recent record is record 0, earlier record numbers go backwards (-1, -2, ...). If a delay count has been set, the cycle number where the trace stop condition has been satisfied is record 0. For the cycle (during delay) executed until the trace has stopped, earlier record numbers go forward (+1, +2, ...) the most recent record.   |
| [Address]              | Address (6-digit hexadecimal)   |
| [Instruction]          | Disassembled code of the executed instruction   |
| [Data]                 | Data bus value, displayed as 2-digit or 4-digit hexadecimal   |
| [R/W]                  | Whether access was read (RD) or write (WR)  |
| [Area]                 | Memory area being accessed; ROM, RAM, 8- or 16-bit I/O, 8- or 16-bit EXT (external), or DTC RAM (not available when a time stamp is acquired)   |
| [Status]               | Bus status during this cycle; DTC operation, PROG (prefetch), Data (CPU data access cycle), Refresh (refresh cycle), or DMAC (DMAC cycle) (not available when a time stamp is acquired)   |
| [Clock]                | Number of clock cycles in bus cycle as 1 to 8. To indicate more clock cycles, "OVR" is displayed (not available when a time stamp is acquired).   |
| [Probes]               | A 4-bit binary number showing the four probe pins in the order of Probe 4, Probe 3, Probe 2, and Probe 1 from the left (not available when a time stamp is acquired).   |
| [NMI]                  | Status of the NMI input (not available when a time stamp is acquired)   |
| [IRQ]                  | Status of IRQ input signals: 0 (input) or 1 (no input). The content to be displayed depends on the selection made as the [Trace] option on the [General] page of the [Configuration Properties] dialog box.<br><br><b>When [IRQ7-IRQ0] is selected as the [Trace] option:</b><br>The status of IRQ7 to IRQ0 is shown from the left, respectively.<br><br><b>When [IRQ15-IRQ8] is selected as the [Trace] option:</b><br>The status of IRQ15 to IRQ8 is shown from the left, respectively.<br><br>(This item is not available when a time stamp is acquired) |
| [EXDMAC]               | Whether EXDMAC is operating or not (not available when a time stamp is acquired).<br><br>0: Operating<br>1: Not operating   |
| [Timestamp]            | Time stamp of the record. Time stamps start from zero each time the user program is executed. The timer resolution depends on the time stamp clock rate selected in the trace acquisition (only available when a time stamp is acquired).   |
| [Source]               | Source program  |
| [Label]                | Label information that corresponds to the address (if defined)  |
| [Timestamp-Difference] | The time lag from a front cycle.  |

### 8.1.12 Searching for a Trace Record

While using the emulator, the [Trace Find] dialog box has the following pages:

**Table 8.11 [Trace Find] Dialog Box Pages**

| Page        | Description   |
|-------------|---|
| [General]   | Sets the range for searching.   |
| [Address]   | Sets an address condition.  |
| [Data]      | Sets a data condition.  |
| [R/W]       | Selects the type of access cycles.  |
| [Area]      | Selects the area being accessed (not available when a time stamp is acquired).              |
| [Status]    | Selects the status of a bus (not available when a time stamp is acquired).                  |
| [Probes]    | Selects the status of four probe signals (not available when a time stamp is acquired).     |
| [IRQ]       | Selects the status of IRQ input signals (not available when a time stamp is acquired).      |
| [Timestamp] | Specify the time stamp value for bus cycles (only available when a time stamp is acquired). |

The [IRQ] page is specific to this emulator. The description is given below.

- [IRQ] page

Select the status of IRQ signals. IRQ0 to IRQ7 or IRQ8 to IRQ15 are applied when [IRQ7-IRQ0] or [IRQ15-IRQ8] has been selected in [Trace] on the [General] page of the [Configuration Properties] dialog box, respectively. The selection is not available when a time stamp is acquired.

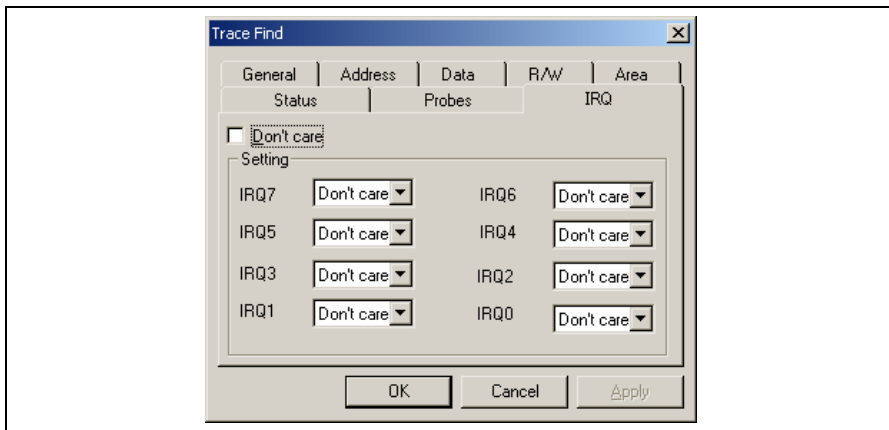

**Figure 8.3 [Trace Find] Dialog Box ([IRQ] Page)**

[Don't care]: Detects no IRQ input condition when this box is checked.

[Setting]: Detects the specified IRQ input condition.

[IRQ7] to [IRQ0] or [IRQ15] to [IRQ8]: Select IRQ input conditions.

When [IRQ7-IRQ0] is selected as the [Trace] option:  
The status of IRQ7 to IRQ0, respectively, can be selected.

When [IRQ15-IRQ8] is selected as the [Trace] option:  
The status of IRQ15 to IRQ8, respectively, can be selected.

(Selection is not available when a time stamp is acquired.)

Don't care: Detects no selected IRQ input condition.

High: The status of the IRQ input is high.

Low: The status of the IRQ input is low.

### 8.1.13 Trace Filtering Function

While using the emulator, the [Trace Filter] dialog box has the following pages:

**Table 8.12 [Trace Filter] Dialog Box Pages**

| Page        | Description   |
|-------------|---|
| [General]   | Selects the range for filtering.  |
| [Address]   | Sets address conditions.  |
| [Data]      | Sets data conditions.   |
| [R/W]       | Selects the type of access cycles.  |
| [Area]      | Selects the area being accessed (not available when a time stamp is not acquired).            |
| [Status]    | Sets the status of a bus (not available when a time stamp is not acquired).                   |
| [Probes]    | Selects the states of four probe signals (not available when a time stamp is not acquired).   |
| [IRQ]       | Selects the states of IRQ input signals (not available when a time stamp is not acquired).    |
| [Timestamp] | Specifies the time stamp value for bus cycles (only available when a time stamp is acquired). |

The [IRQ] page is specific to this emulator. The description is given below.

- [IRQ] page

Select the status of IRQ signals. IRQ0 to IRQ7 or IRQ8 to IRQ15 are applied when [IRQ7-IRQ0] or [IRQ15-IRQ8] has been selected in [Trace] on the [General] page of the [Configuration Properties] dialog box, respectively. The selection is not available when a time stamp is acquired.

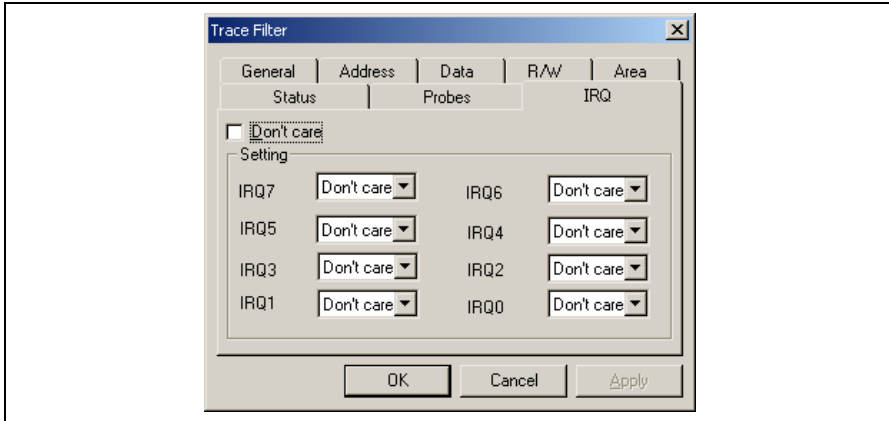

**Figure 8.4 [Trace Filter] Dialog Box ([IRQ] Page)**

[Don't care]: Detects no IRQ input condition when this box is checked.

[Setting]: Detects the specified IRQ input condition.

[IRQ7] to [IRQ0] or [IRQ15] to [IRQ8]: Select IRQ input conditions.

When [IRQ7-IRQ0] is selected as the [Trace] option:  
The status of IRQ7 to IRQ0 from the left, respectively, can be selected.

When [IRQ15-IRQ8] is selected as the [Trace] option:  
The status of IRQ15 to IRQ8 from the left, respectively, can be selected.

(Selection is not available when a time stamp is acquired.)

Don't care: Detects no selected IRQ input condition.

High: The status of the IRQ input is high.

Low: The status of the IRQ input is low.

## 8.2 Notes on Usage of the H8S/2678R E6000 Emulator

There are the following notes on usage of the emulator.

### 8.2.1 Environment for Execution of the Tutorial Program

To execute the tutorial program, specify "Tutorial.hws" stored in the following directory:

OS installation drive \Workspace\Tutorial\E6000\2678R

The directory mentioned above cannot be specified depending on the version of the software. In such cases, specify the following directory instead.

High-performance Embedded Workshop installation destination directory  
\Tools\Renesas\DebugComp\Platform\E6000\2678R\Tutorial

### 8.2.2 I/O Register Differences between the Actual MCU and the Emulator

In the E6000 emulator, one evaluation chip emulates several types of MCU. Therefore, there are some differences in I/O registers between an actual MCU and the emulator. Note these differences when accessing the I/O registers.

I/O port is in the input state at default. The I/O register contents indicate the emulator port status. When the user system interface cable is not connected, the read value is 1 due to pull-up resistors.

In the emulator, accesses to the following registers for controlling the flash memory are invalid.

- RAM emulation register (RAMER: H'FEDB)
- System control register 2 (SYSCR2: H'FF42)
- Flash memory control register 1 (FLMCR1: H'FFC8)
- Flash memory control register 2 (FLMCR2: H'FFC9)
- Block register 1 (EBR1: H'FFCA)
- Block register 2 (EBR2: H'FFCB)

Note: The addresses indicate the lower 16 bits.

### 8.2.3 Access to the Reserved Area

When accessing the reserved area, note the following:

If the reserved area is used, the operation in the actual MCU cannot be guaranteed. If the user program extends to the reserved area during debugging, select the MCU having the largest ROM capacity (for example, debug the H8S/2675R program in the H8S/2676R mode).

### 8.2.4 Using the Internal RAM Area as External Addresses

When the RAME bit in SYSCR is 0, the internal RAM area can be used external addresses. Note that, however, the only memory that can be accessed is User (external), not Emulator (emulation memory). In this case, the On-Chip Read-write (Internal RAM) setting is applied for memory mapping.

### 8.2.5 Support of Flash Memory

This emulator does not emulate the flash memory in the MCU.



### **8.2.6 Hardware Standby**

When the [User Standby enable] check box is selected in the [Configuration Properties] dialog box, the STBY signal of the user system is directly input to the emulator, and the MCU operation stops.

When disabling the STBY signal, be sure to keep the oscillator stabilization time and the timing specifications of the RES signal.

### **8.2.7 EXDMA Controller**

The H8S/2678 group, H8S/2678R group, H8S/2668 group, H8S/2368 group, H8S/2378 group includes an EXDMA controller that performs direct memory access (DMA) transfers between external addresses. The EXDMA controller can only access User (user memory) and cannot access Emulator (option memory).

### **8.2.8 SIMM Memory Module Access**

When SIMM memory module is used for the external area, memory will always be accessed via 16-bit bus in three cycles regardless of the setting of the bus controller.

### **8.2.9 Power Supply Follower Circuit**

If the [Configuration Properties] dialog box is used to set [User Vcc Threshold], set the Vcc between 2.7 V to 3.6 V.

### **8.2.10 IRQ Signal Trace**

The H8S/2678 group, H8S/2678R group, H8S/2668 group, H8S/2368 group, H8S/2378 group MCU has 16 interrupt input pins IRQ0 to IRQ15. The emulator can trace the state of eight interrupt pins simultaneously. To do this, select the [IRQ7-IRQ0] or [IRQ15-IRQ8] checkbox in the [Configuration Properties] dialog box.



## Appendix A I/O File Format

High-performance Embedded Workshop formats the [IO] window based on information it finds in an I/O Register definition file. When you select a debugging platform, High-performance Embedded Workshop will look for a “<device>.IO” file corresponding to the selected device and load it if it exists. This file is a formatted text file that describes the I/O modules and the address and size of their registers. You can edit this file, with a text editor, to add support for memory mapped registers or peripherals you may have specific to your application (e.g. registers in an ASIC device mapped into the microcomputer's address space).

The following describes two formats of the “<device>.IO” file that supports or not the bit field.

### A.1 File format (Bit Field Not Supported)

Each module name must be defined in the [Modules] definition section and the numbering of each module must be sequential. Each module corresponds to a register definition section and within the section each entry defines an I/O register.

The [BaseAddress] definition is for devices where the location of I/O registers moves in the address space depending on the CPU mode. In this case, the [BaseAddress] value is the base address of the I/O registers in one specific mode and the addresses used in the register definitions are the address locations of the registers in the same mode. When the I/O register file is actually used, the [BaseAddress] value is subtracted from the defined register address and the resultant offset added to the relevant base address for the selected mode.

The [Register] definition entry is entered in the format <name> = <address> [<size> [<absolute>]].

1. <name> register name to be displayed.
2. <address> address of the register.
3. <size> which may be B, W or L for byte, word, or longword (default is byte).
4. <absolute> which can be set to A if the register is at an absolute address. This is only relevant if the I/O area address range moves about on the CPU in different modes. In this case, if a register is defined as absolute the base address offset calculation is not performed and the specified address is used directly.

Comment lines are allowed and must start with a “;” character.

An example is shown below.

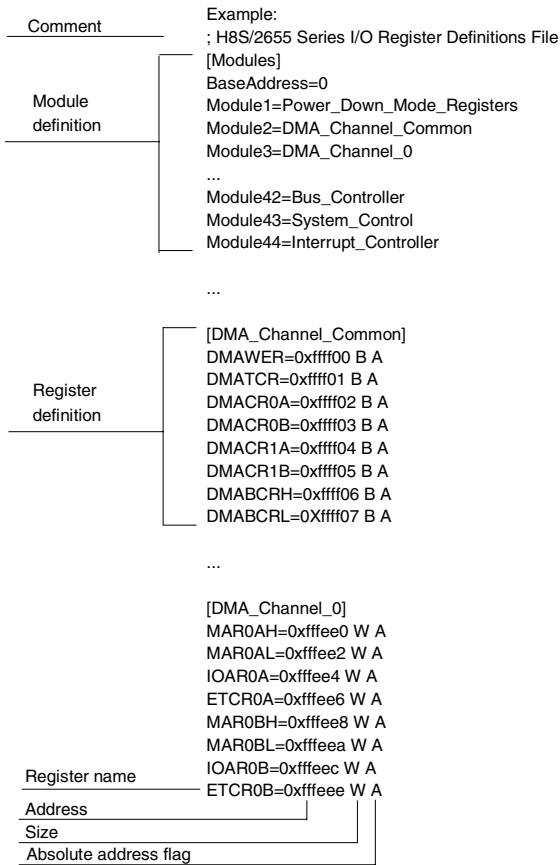

## A.2 File format (Bit Field Supported)

Each module name must be defined in the [Modules] definition section and the numbering of each module must be sequential. Each module corresponds to a register definition section and within the section each entry defines an I/O register.

The user must define "FileVersion=2" at the start of the section. It means that this I/O register file is described with the version that supports the bit field.

The [BaseAddress] definition is for devices where the location of I/O registers moves in the address space depending on the CPU mode. In this case, the [BaseAddress] value is the base address of the I/O registers in one specific mode and the addresses used in the register definitions are the address locations of the registers in the same mode. When the I/O register file is actually used, the [BaseAddress] value is subtracted from the defined register address and the resultant offset added to the relevant base address for the selected mode.

Each module has a section that defines the registers forming it along with an optional dependency. The dependency is checked to see if the module is enabled or not. Each register name must be defined in the section and the numbering of each register must be sequential. The dependency is entered in the section as dep=<reg> <bit> <value>.

1. <reg> is the register id of the dependency.
2. <bit> is the bit position within the register.
3. <value> is the value that the bit must be for the module to be enabled.

The [Register] definition entry is entered in the format id=<name> <address> [<size> [<absolute>[<format>[<bitfields>]]]].

1. <name> register name to be displayed.
2. <address> address of the register.
3. <size> which may be B, W or L for byte, word, or longword (default is byte).
4. <absolute> which can be set to A if the register is at an absolute address. This is only relevant if the I/O area address range moves about on the CPU in different modes. In this case, if a register is defined as absolute the base address offset calculation is not performed and the specified address is used directly.
5. <format> format for register output. Valid values are H for Hexadecimal, D for decimal, and B for binary.
6. <bitfields> section defining the bits within the register.

Bitfield sections define the bits within a register each entry is of the type bit<no>=<name>.

1. <no> is the bit number.
2. <name> is a symbolic name of the bit.

Comment lines are allowed and must start with a ";" character.

An example is shown below.

Example:  
; H8S/2655 Series I/O Register Definitions File  
[Modules]  
FileVersion=2  
BaseAddress=0  
Module1=Power\_Down\_Mode\_Registers  
Module2=DMA\_Channel\_Common  
Module3=DMA\_Channel\_0  
...  
Module42=Bus\_Controller  
Module43=System\_Control  
Module44=Interrupt\_Controller

...  
[DMA\_Channel\_Common]  
reg0=regDMAWER  
reg1=regDMATCR  
reg2=regDMACR0A  
reg3=regDMACR0B  
reg4=regDMACR1A  
reg5=regDMACR1B  
reg6=regDMABCRH  
reg7=regDMABCRL  
dep= regMSTPCRH 7 0

Register name  
Bit  
Value

...  
Register definition [regDMAWER]  
id=DMAWER 0xffff00 B A H dmawer\_bitfields



















Register name  
Address  
Size  
Absolute address flag  
Format  
Bit field

Bit-field definition [dmawer\_bitfields]  
bit3=WE1B  
bit2=WE1A  
bit1=WE0B  
bit0=WE0A









## Appendix B Menus

Table B.1 shows GUI menus.

**Table B.1 GUI Menus**







| Menu             | Option       | Shortcut           | Toolbar Button  | Remarks   |   |
|------------------|--------------|--------------------|---|---|---|
| View             | Difference   |                    |    | Opens the [Difference] window.  |   |
|                  | Command Line | Ctrl + L           |    | Opens the [Command Line] window.  |   |
|                  | TCL toolkit  | Shift + Ctrl + L   |    | Opens the [Console] window.   |   |
|                  | Workspace    | Alt + K            |    | Opens the [Workspace] window.   |   |
|                  | Output       | Alt + U            |    | Opens the [Output] window.  |   |
|                  | Disassembly  | Ctrl + D           |    | Opens the [Disassembly] window.   |   |
|                  | CPU          | Registers          | Ctrl + R  |  | Opens the [Registers] window.   |
|                  |              | Memory...          | Ctrl + M  |  | Opens the [Memory] window.  |
|                  |              | IO                 | Ctrl + I  |  | Opens the [IO] window.  |
|                  |              | Status             | Ctrl + U  |  | Opens the [Status] window.  |
| Extended Monitor |              |                    |    | Opens the [Extended Monitor] window.  |   |
| Monitor          |              | Monitor Setting... | Shift + Ctrl + E  |  | Opens the [Monitor] window.   |
|                  |              | Windows Select...  |   |   | Opens the [Windows Select] dialog box to list, add, or edit the [Monitor] window. |
| Symbol           | Labels       | Shift + Ctrl + A   |    | Opens the [Labels] window.  |   |
|                  | Watch        | Ctrl + W           |  | Opens the [Watch] window.   |   |
|                  | Locals       | Shift + Ctrl + W   |  | Opens the [Locals] window.  |   |
| Code             | Eventpoints  | Ctrl + E           |  | Opens the [Eventpoints] window.   |   |
|                  | Trace        | Ctrl + T           |  | Opens the [Trace] window.   |   |
|                  | Stack Trace  | Ctrl + K           |  | Opens the [Stack Trace] window.   |   |

**Table G.1 GUI Menus (cont)**







| Menu        | Option            | Shortcut             | Toolbar Button   | Remarks   |   |
|-------------|-------------------|----------------------|------------------|---|---|
| View (cont) | Graphic           | Image...             | Shift + Ctrl + G |    | Opens the [Image] window.   |
|             |                   | Waveform...          | Shift + Ctrl + V |    | Opens the [Waveform] window.  |
|             | Performance       | Performance Analysis | Shift + Ctrl + P |    | Opens the [Performance Analysis] window.  |
| Debug       | Debug Sessions... |                      |                  |   | Opens the [Debug Sessions] dialog box to list, add, or remove the debug session.  |
|             | Debug Settings... |                      |                  |   | Opens the [Debug Settings] dialog box to set the debugging conditions or download modules.  |
|             | Reset CPU         |                      |                  |    | Resets the target hardware and sets the PC to the reset vector address.   |
|             | Go                |                      | F5               |    | Starts executing the user program at the current PC.  |
|             | Reset Go          |                      | Shift + F5       |    | Resets the target hardware and executes the user program from the reset vector address.   |
|             | Go To Cursor      |                      |                  |    | Starts executing the user program at the current PC until the PC reaches the address indicated by the current text cursor position. |
|             | Set PC To Cursor  |                      |                  |    | Sets the PC to the address at the row of the text cursor.   |
|             | Run...            |                      |                  |   | Launches the [Run Program] dialog box allowing the user to enter the PC or PC breakpoint during executing the user program.         |
|             | Display PC        |                      | Shift + Ctrl + Y |  | Opens the Editor or Disassembly window at the address of the PC.  |



**Table G.1 GUI Menus (cont)**

| Menu         | Option               | Shortcut    | Toolbar Button  | Remarks  |
|--------------|----------------------|-------------|---|--|
| Debug (cont) | Step In              | F11         |    | Executes a block of user program before breaking.  |
|              | Step Over            | F10         |    | Executes a block of user program before breaking. If a subroutine call is reached, then the subroutine will not be entered.                                      |
|              | Step Out             | Shift + F11 |    | Executes the user program to reach the end of the current function.  |
|              | Step...              |             |   | Launches the [Step Program] dialog box allowing the user to modify the settings for stepping.  |
|              | Step Mode            | Auto        |   | Steps only one source line when the [Source] window is active. When the [Disassembly] window is active, stepping is executed in a unit of assembly instructions. |
|              | Assembly             |             | Executes stepping in a unit of assembly instructions.                               |  |
|              | Source               |             | Steps only one source line.   |  |
|              | Halt Program         | Esc         |    | Stops the execution of the user program.   |
|              | Initialize           |             |   | Disconnects the debugging platform and connects it again.  |
|              | Connect              |             |    | Connects the debugging platform.   |
|              | Disconnect           |             |    | Disconnects the debugging platform.  |
|              | Save Memory...       |             |   | Saves the specified memory area data to a file.  |
|              | Verify Memory...     |             |   | Verifies file contents against memory contents.  |
|              | Configure Overlay... |             |  | Selects the target section group when the overlay function is used.  |
|              | Download Modules     |             |   | Downloads the object program.  |
|              | Unload Modules       |             |   | Unloads the object program.  |

**Table G.1 GUI Menus (cont)**

| <b>Menu</b> | <b>Option</b>      | <b>Shortcut</b> | <b>Toolbar Button</b>   | <b>Remarks</b>  |   |
|-------------|--------------------|-----------------|---|---|---|
| Setup       | Customize...       |                 |   | Customize the High-performance Embedded Workshop application.   |   |
|             | Options...         |                 |   | Sets option of the High-performance Embedded Workshop application.  |   |
|             | Format Views...    |                 |   | Configure fonts, colors, keywords and so on, for the window.  |   |
|             | Radix              | Hexadecimal     |   |                                      | Uses a hexadecimal for displaying a radix in which the numerical values will be displayed and entered by default. |
|             |                    | Decimal         |   |                                      | Uses a decimal for displaying a radix in which the numerical values will be displayed and entered by default.     |
|             | Octal              |                 |  | Uses an octal for displaying a radix in which the numerical values will be displayed and entered by default.          |   |
|             | Binary             |                 |  | Uses a binary for displaying a radix in which the numerical values will be displayed and entered by default.          |   |
| Emulator    | System...          |                 |  | Opens the [Configuration] dialog box allowing the user to modify the debugging platform settings.                     |   |
|             | Memory Resource... |                 |  | Opens the [Memory Mapping] dialog box allowing the user to view and edit the debugging platform's current memory map. |   |

## Appendix C Command Lines

Table C.1 lists the High-performance Embedded Workshop commands.

**Table C.1 High-performance Embedded Workshop Commands**

| No. | Command Name          | Abbreviation | Function  |
|-----|-----------------------|--------------|---|
| 1   | !                     | -            | Comment   |
| 2   | ADD_FILE              | AF           | Adds a file to the current project  |
| 3   | ANALYSIS              | AN           | Enables or disables performance analysis                                  |
| 4   | ANALYSIS_RANGE        | AR           | Sets or displays a performance analysis range                             |
| 5   | ANALYSIS_RANGE_DELETE | AD           | Deletes a performance analysis range                                      |
| 6   | AUTO_COMPLETE         | AC           | Enables or disables command complement function                           |
| 7   | ASSEMBLE              | AS           | Assembles instructions into memory  |
| 8   | ASSERT                | -            | Checks if an expression is true or false                                  |
| 9   | BREAKPOINT            | BP           | Sets a breakpoint at an instruction address                               |
| 10  | BREAKPOINT_CLEAR      | BC           | Deletes breakpoints   |
| 11  | BREAKPOINT_DISPLAY    | BD           | Displays a list of breakpoints  |
| 12  | BREAKPOINT_ENABLE     | BE           | Enables or disables a breakpoint  |
| 13  | BREAKPOINT_SEQUENCE   | BS           | Sets sequential breakpoints   |
| 14  | BUILD                 | BU           | Starts a build operation on the current project                           |
| 15  | BUILD_ALL             | BL           | Starts a build all operation on the current project                       |
| 16  | CHANGE_CONFIGURATION  | CC           | Sets the current configuration  |
| 17  | CHANGE_PROJECT        | CP           | Sets the current project  |
| 18  | CHANGE_SESSION        | CS           | Changes the session of the current project                                |
| 19  | CLOCK                 | CK           | Set the CPU clock rate in the emulator                                    |
| 20  | CONFIGURE_PLATFORM    | CPF          | Sets the debugging environment for the emulator                           |
| 21  | CLOSE_WORKSPACE       | CW           | Close the current workspace   |
| 22  | DEFAULT_OBJECT_FORMAT | DO           | Sets the default object (program) format                                  |
| 23  | DEVICE_TYPE           | DE           | Selects a device type to emulate  |
| 24  | DISASSEMBLE           | DA           | Disassembles memory contents  |
| 25  | ERASE                 | ER           | Clears the [Command Line] window  |
| 26  | EVALUATE              | EV           | Evaluates an expression   |
| 27  | EXMONITOR_DISPLAY     | EXMD         | Displays the content of the expansion monitor                             |
| 28  | EXMONITOR_SET         | EXMS         | Selects whether or not to display the items in the expansion monitor      |
| 29  | EXMONITOR_SETRATE     | EXMSR        | Sets the time to update the expansion monitor during emulation or a break |
| 30  | FILE_LOAD             | FL           | Loads an object (program) file  |
| 31  | FILE_SAVE             | FS           | Saves memory to a file  |
| 32  | FILE_UNLOAD           | FU           | Unloads a file  |
| 33  | FILE_VERIFY           | FV           | Verifies file contents against memory                                     |

**Table H.1 High-performance Embedded Workshop Commands (cont)**

| No. | Command Name       | Abbreviation | Function  |
|-----|--------------------|--------------|---|
| 34  | GENERATE_MAKE_FILE | GM           | Creates a makefile to be built outside the High-performance Embedded Workshop |
| 35  | GO                 | GO           | Executes user program   |
| 36  | GO_RESET           | GR           | Executes user program from reset vector                                       |
| 37  | GO_TILL            | GT           | Executes user program until temporary breakpoint                              |
| 38  | HALT               | HA           | Halts the user program  |
| 39  | HELP               | HE           | Displays the syntax of a command  |
| 40  | INITIALIZE         | IN           | Initializes the debugging platform  |
| 41  | LOG                | LO           | Controls command output logging   |
| 42  | MAP_DISPLAY        | MA           | Displays memory mapping   |
| 43  | MAP_SET            | MS           | Sets memory mapping   |
| 44  | MEMORY_COMPARE     | MC           | Compares memory contents  |
| 45  | MEMORY_DISPLAY     | MD           | Displays memory contents  |
| 46  | MEMORY_EDIT        | ME           | Modifies memory contents  |
| 47  | MEMORY_FILL        | MF           | Modifies the content of a memory area by specifying data                      |
| 48  | MEMORY_FIND        | MI           | Searches for data within the memory range                                     |
| 49  | MEMORY_MOVE        | MV           | Moves a block of memory   |
| 50  | MEMORY_TEST        | MT           | Tests a block of memory   |
| 51  | MODE               | MO           | Sets or displays the CPU mode   |
| 52  | MODULES            | MU           | Sets up or displays the on-chip peripheral functions                          |
| 53  | MONITOR_CLEAR      | MOC          | Deletes a monitor point   |
| 54  | MONITOR_DISPLAY    | MOD          | Displays the content of the monitor   |
| 55  | MONITOR_REFRESH    | MOR          | Controls an automatic update of the content of the monitor                    |
| 56  | MONITOR_SET        | MOS          | Sets or displays a monitor point  |
| 57  | OPEN_WORKSPACE     | OW           | Opens a workspace   |
| 58  | QUIT               | QU           | Exits High-performance Embedded Workshop                                      |
| 59  | RADIX              | RA           | Sets default input radix  |
| 60  | REFRESH            | RF           | Updates windows related to memory   |
| 61  | REGISTER_DISPLAY   | RD           | Displays CPU register values  |
| 62  | REGISTER_SET       | RS           | Sets CPU register contents  |
| 63  | REMOVE_FILE        | REM          | Deletes the specified file from the current project                           |
| 64  | RESET              | RE           | Resets CPU  |
| 65  | SLEEP              | -            | Delays command execution  |
| 66  | SAVE_SESSION       | SE           | Saves the session of the current project                                      |
| 67  | STATUS             | STS          | The content of the [Platform] sheet in the [Status] window is displayed.      |
| 68  | STEP               | ST           | Steps program (by instructions or source lines)                               |
| 69  | STEP_MODE          | SM           | Sets the step mode  |
| 70  | STEP_OUT           | SP           | Steps out of the current function   |
| 71  | STEP_OVER          | SO           | Steps program, not stepping into functions                                    |
| 72  | STEP_RATE          | SR           | Sets or displays rate of stepping   |

**Table H.1 High-performance Embedded Workshop Commands (cont)**

| <b>No.</b> | <b>Command Name</b>     | <b>Abbreviation</b> | <b>Function</b>   |
|------------|-------------------------|---------------------|---|
| 73         | SUBMIT                  | SU                  | Executes a command file   |
| 74         | SYMBOL_ADD              | SA                  | Defines a symbol  |
| 75         | SYMBOL_CLEAR            | SC                  | Deletes a symbol  |
| 76         | SYMBOL_LOAD             | SL                  | Loads a symbol information file                                 |
| 77         | SYMBOL_SAVE             | SS                  | Saves a symbol information file                                 |
| 78         | SYMBOL_VIEW             | SV                  | Displays symbols  |
| 79         | SAVE_WORKSPACE          | SW                  | Saves the current workspace                                     |
| 80         | TCL                     | -                   | Enables or disables the TCL                                     |
| 81         | TIMER                   | TI                  | Sets or displays the timer resolution                           |
| 82         | TOOL_INFORMATION        | TO                  | The information on the tool registered is outputted by the file |
| 83         | TRACE                   | TR                  | Displays trace information                                      |
| 84         | TRACE_ACQUISITION       | TA                  | Sets or displays trace acquisition parameters                   |
| 85         | TRACE_BINARY_COMPARE    | TBC                 | Compares a trace binary file with the current trace information |
| 86         | TRACE_BINARY_SAVE       | TBV                 | Outputs trace information into a binary file                    |
| 87         | TRACE_FILTER            | TF                  | Filter the trace information                                    |
| 88         | TRACE_STATISTIC         | TST                 | Analyzes statistic information                                  |
| 89         | TRACE_SAVE              | TV                  | Outputs trace information into a file                           |
| 90         | TRIGGER_CLEAR           | TGC                 | Deletes the trigger output condition for EXT.2                  |
| 91         | TRIGGER_DISPLAY         | TGD                 | Displays the trigger output condition for EXT.2                 |
| 92         | TRIGGER_SET             | TGS                 | Sets the trigger output condition for EXT.2                     |
| 93         | UPDATE_ALL_DEPENDENCIES | UD                  | Updates the dependencies for the current project                |
| 94         | USER_SIGNALS            | US                  | Enables or disables the user signal information                 |
| 95         | WATCH_ADD               | WA                  | Adds a watch item   |
| 96         | WATCH_AUTO_UPDATE       | WU                  | Selects or cancels automatic update of watch items              |
| 97         | WATCH_DELETE            | WD                  | Deletes a watch item  |
| 98         | WATCH_DISPLAY           | WI                  | Displays the contents of the Watch window                       |
| 99         | WATCH_EDIT              | WE                  | Edits the value of a watch item                                 |
| 100        | WATCH_EXPAND            | WX                  | Expands or collapses a watch item                               |
| 101        | WATCH_RADIX             | WR                  | Changes the radix of a watch item to be displayed               |
| 102        | WATCH_SAVE              | WS                  | Saves the contents of the Watch window to a file                |

For the syntax of each command, refer to the online help.



## Appendix D Diagnostic Test Procedure

This section describes the diagnostic test procedure using the E6000 test program.

### D.1 System Set-Up for Test Program Execution

To execute the test program, use the following hardware; do not connect the user system interface cable and user system.

- E6000 emulator (HS2678REPI61H, HS2678EPI61H)
- Host computer
- The E6000 PC interface board (Select one interface board or card from the following depending on the PC interface specifications.):

PCI bus interface board (HS6000EIC01H or HS6000EIC02H)

PCMCIA interface card (HS6000EIP01H)

1. Install the E6000 PC interface board in the host computer and connect the supplied PC interface cable to the board.
2. Connect the PC interface cable to the emulator.
3. Connect the supplied AC adapter to the emulator.
4. Initiate the host computer to make it enter DOS prompt command input wait state.
5. Turn on the emulator power switch.

## D.2 Diagnostic Test Procedure Using Test Program

Insert the CD-R (HS2678REPI61SR supplied with the emulator) into the CD-ROM drive of the host computer and move the current directory to either of those listed below with a command prompt.

When HS2678REPI61H is in use: <Drive>:\Diag\HS2678REPI61H

When HS2678EPI61H is in use: <Drive>:\Diag\HS2678EPI61H

Then enter one of the following commands according to the PC interface board in use to initiate the test program:

1. PCI bus interface board (HS6000EIC01H or HS6000EIC02H)

When HS2678REPI61H is in use: > TM2678R –PCI (RET)

When HS2678EPI61H is in use: > TM2678 –PCI (RET)

2. PCMCIA interface card (HS6000EIP01H)

When HS2678REPI61H is in use: > TM2678R –PCCD (RET)

When HS2678EPI61H is in use: > TM2678 –PCCD (RET)

The High-performance Embedded Workshop must be installed before the test program is executed.

Be sure to initiate the test program from <Drive>\Diag. Do not initiate it from a directory other than <Drive>\Diag, such as ><Drive>\Diag\TM2678R –PCI (RET). If the test program is initiated when the current directory is not <Drive>\Diag, the test program will not operate correctly.

When –S is added to the command line such as >TM2678R –PCI –S (RET), steps 1 to 19 will be repeatedly executed. To stop the execution, enter Q.

Notes: 1. <Drive> is a drive name for the CD-ROM drive.

2. Do not remove the CD-R from the CD-ROM drive during test program execution.



The following messages are displayed during test. This test consists of steps 1 to 19. This example assumes that HS2678REPI61H is in use.

| Message  | Description  |
|--|--|
| E6000 H8S/2678R Emulator Tests Vx.x                                    | Test program start message. Vx.x shows the version number.   |
| Option memory board fitted? ( 1. None 2. 1MB 3. 4MB ) : 1              | Enter 1 and press the Enter key because the SIMM memory module is not installed in this example.             |
| Loading driver .....OK (Use PCI)                                       | Shows that driver software has been correctly loaded.  |
| Initializing driver .....OK  | Shows that driver software has been correctly initialized.   |
| Searching for interface card .....OK                                   | Shows that the PC interface board is correctly installed in the host computer.                               |
| Checking emulator is connected .....OK                                 | Shows that the E6000 is correctly connected to the host computer.  |
| Emulator board information:  |  |
| Main board ID: H'5                      Emulation board ID: H'18       | Shows the ID number of the lower board of the E6000 (always 5) and the upper board of the E6000 (always 18). |
| Companion chip ID: None                      Option memory board: None | Shows the ID number of the companion chip and whether the SIMM memory board is installed or not.             |
| 01) Test Register  |  |
| A) IDR0 Register .....OK   | Shows the check results for the registers in the E6000 (normal completion).                                  |
| B) PAGE Register .....OK   |  |
| C) TRACE G/A Register .....OK  |  |
| D) PERFM G/A Register .....OK  |  |
| E) CES G/A Register .....OK  |  |
| F) IDR1 Register .....OK   |  |
| G) IDR2 Register .....OK   |  |
| 02) Test DPRAM   |  |
| A) Decode Test .....OK   | Shows the results of decoding test and marching test for the dual-port RAM in the E6000 (normal completion). |
| B) Marching Test .....OK   |  |

|  |   |   |
|--|---|---|
| 03) Test Firmware RAM                        |   | Shows the results of decoding test for the firmware RAM in the E6000 (normal completion).                       |
| A) Decode Test                               | page[H'700 - H'71f] .....OK             |   |
| B) Marching test                             | page[H'700 - H'71f] .....OK             | Shows the results of marching test for the firmware RAM in the E6000 (normal completion).                       |
| 04) Test Trace memory                        |   | Shows the results of decoding test for the trace RAM (first half) in the E6000 (normal completion).             |
| A) Decode Test                               | page[H'000 - H'04f] (Lower 32K) .....OK |   |
| B) Marching test                             | page[H'000 - H'04f] (Lower 32K) .....OK | Shows the results of marching test for the trace RAM (first half) in the E6000 (normal completion).             |
| C) Decode Test                               | page[H'000 - H'04f] (Upper 32K) .....OK | Shows the results of decoding test for the trace RAM (last half) in the E6000 (normal completion).              |
| D) Marching test                             | page[H'000 - H'04f] (Upper 32K) .....OK | Shows the results of marching test for the trace RAM (last half) in the E6000 (normal completion).              |
| 05) Test Map control memory                  |   | Shows the results of decoding test for the mapping RAM in the E6000 (normal completion).                        |
| A) Decode Test                               | page[H'200 - H'27f] .....OK             |   |
| B) Marching test                             | page[H'200 - H'27f] .....OK             | Shows the results of marching test for the mapping RAM in the E6000 (normal completion).                        |
| 06) Test Internal ROM and RAM                |   | Shows the results of decoding test and marching test for internal ROM and RAM in the E6000 (normal completion). |
| A) Decode Test                               | (Internal ROM) .....OK                  |   |
| B) Marching test                             | (Internal ROM) .....OK                  |   |
| C) Decode Test                               | (Internal RAM) .....OK                  |   |
| D) Marching Test                             | (Internal RAM) .....OK                  |   |
| 07) Test Option RAM                          |   | Shows the check results for the optional SIMM memory module in the E6000 (not installed).                       |
| No option memory board fitted - test skipped |   |   |
| 08) Test Emulation RAM STEP Operation        |   | Shows the check results for the step execution controlling circuits in the E6000 (normal completion).           |
| A) Step Operation                            | .....OK                                 |   |

|   |  |
|---|--|
| 09) Test Keybreak                         |  |
| A) Key Break .....                        | OK   |
|   | Shows the check results for the forced break controlling circuits in the E6000 (normal completion).                  |
| 10) Test Emulation RAM Hardware Break     |  |
| A) GRD Break .....                        | OK   |
| B) WPT Break .....                        | OK   |
| C) WPT (ROM) Break .....                  | OK   |
|   | Shows the check results for the illegal access break controlling circuits in the E6000 (normal completion).          |
| 11) Test Internal ROM Write Protect       |  |
| A) Write-Protect .....                    | OK   |
|   | Shows the check results for the internal ROM write-protection controlling circuits in the E6000 (normal completion). |
| 12) Test Hardware Break                   |  |
| A) Break Point Initialized .....          | OK   |
| B) Event Detectors CES channel 1-12 ..... | OK   |
| C) Test Sequencing 1 .....                | OK   |
| D) Check Range Break .....                | OK   |
| E) Range Break Test for Data .....        | OK   |
| F) Check Compare Either .....             | OK   |
|   | Shows the check results for the hardware break control circuits in the E6000 (normal completion).                    |
| 13) Test Emulation RAM Trace              |  |
| A) Free Trace .....                       | OK   |
| B) Range Trace .....                      | OK   |
| C) Point to Point Trace .....             | OK   |
| D) Start and Stop Event Trace .....       | OK   |
| E) Trace memory Overflow .....            | OK   |
| F) Time STAMP Trace (33MHz) .....         | OK   |
| G) Time STAMP Trace (25MHz) .....         | OK   |
| H) Time STAMP Trace (12.5MHz) .....       | OK   |
|   | Shows the check results for the trace controlling circuits in the E6000 (normal completion).                         |
| 14) Test Runtime Counter                  |  |
| A) Runtime Counter (33.0MHz) .....        | OK   |
| B) Runtime Counter (25.0MHz) .....        | OK   |
| C) Runtime Counter (12.5MHz) .....        | OK   |
|   | Shows the check results for the run-time counter in the E6000 (normal completion).                                   |
| 15) Test Emulation Monitor                |  |
| A) EMA23-EMA0 .....                       | OK   |
| B) ACST2-ACST0 .....                      | OK   |
| C) ASEST3-ASEST0 .....                    | OK   |
| D) ASEBRKACK .....                        | OK   |
| E) CNN .....                              | OK   |
| F) NOCLK .....                            | OK   |
| G) WINDOW .....                           | OK   |
|   | Shows the check results for the emulation monitor controlling circuits in the E6000 (normal completion).             |
| 16) Test PERFM G/A                        |  |
| A) Time Measurement .....                 | OK   |
| B) RESERVED                               |  |
| C) Subroutine Count Measurement .....     | OK   |
| D) Timeout Function (TIMOT Bit) .....     | OK   |
| E) Timeout Function (TIMOP Bit) .....     | OK   |
|   | Shows the check results for the performance analysis controlling circuits in the E6000 (normal completion).          |

|   |  |
|---|--|
| 17) Test Bus Monitor                                    | Shows the check results for the bus monitor controlling circuits in the E6000 (normal completion).         |
| A) Register .....OK                                     |  |
| B) Parallel RAM .....OK                                 |  |
| C) SPRSEL2 .....OK                                      |  |
| D) RAM Monitor .....OK                                  |  |
| <br>18) Test Parallel Access                            | <br>Shows the check results for the parallel access controlling circuits in the E6000 (normal completion). |
| A) Internal ROM Parallel Read Access(WORD) .....OK      |  |
| B) Internal ROM Parallel Write Access(WORD) .....OK     |  |
| C) Internal ROM Parallel Write Access(High Byte) ...OK  |  |
| D) Internal ROM Parallel Write Access(Low Byte) ....OK  |  |
| E) Internal RAM Parallel Read Access(WORD) .....OK      |  |
| F) Internal RAM Parallel Write Access(WORD) .....OK     |  |
| G) Internal RAM Parallel Write Access(High Byte) ...OK  |  |
| H) Internal RAM Parallel Write Access(Low Byte) ....OK  |  |
| I) Option RAM Parallel Read Access(WORD) .....SKIP      |  |
| J) Option RAM Parallel Write Access(WORD) .....SKIP     |  |
| K) Option RAM Parallel Write Access(High Byte) ....SKIP |  |
| L) Option RAM Parallel Write Access(Low Byte) .....SKIP |  |
| <br>19) Test RTC  | <br>Shows the check results for the RTC controlling circuits in the E6000 (normal completion).             |
| A) RTC .....OK  |  |
| <br>Tests run for xH:xM:xS                              | <br>Shows the check time.  |
| Tests passed, emulator functioning correctly            | Shows that the E6000 is correctly operating.   |

When -S is added to the command line, step 1 will be executed again after step 19.

---

**Renesas Microcomputer Development Environment System  
User's Manual  
H8S/2678R E6000 Emulator**

Publication Date: Rev.5.00, June 7, 2006  
Published by: Sales Strategic Planning Div.  
Renesas Technology Corp.  
Edited by: Customer Support Department  
Global Strategic Communication Div.  
Renesas Solutions Corp.

Renesas Technology Corp. Sales Strategic Planning Div. Nippon Bldg., 2-6-2, Ohte-machi, Chiyoda-ku, Tokyo 100-0004, Japan

---



**RENESAS SALES OFFICES**

<http://www.renesas.com>

Refer to "<http://www.renesas.com/en/network>" for the latest and detailed information.

**Renesas Technology America, Inc.**

450 Holger Way, San Jose, CA 95134-1368, U.S.A  
Tel: <1> (408) 382-7500, Fax: <1> (408) 382-7501

**Renesas Technology Europe Limited**

Dukes Meadow, Millboard Road, Bourne End, Buckinghamshire, SL8 5FH, U.K.  
Tel: <44> (1628) 585-100, Fax: <44> (1628) 585-900

**Renesas Technology (Shanghai) Co., Ltd.**

Unit 204, 205, AZIACenter, No.1233 Lujiazui Ring Rd, Pudong District, Shanghai, China 200120  
Tel: <86> (21) 5877-1818, Fax: <86> (21) 6887-7898

**Renesas Technology Hong Kong Ltd.**

7th Floor, North Tower, World Finance Centre, Harbour City, 1 Canton Road, Tsimshatsui, Kowloon, Hong Kong  
Tel: <852> 2265-6688, Fax: <852> 2730-6071

**Renesas Technology Taiwan Co., Ltd.**

10th Floor, No.99, Fushing North Road, Taipei, Taiwan  
Tel: <886> (2) 2715-2888, Fax: <886> (2) 2713-2999

**Renesas Technology Singapore Pte. Ltd.**

1 Harbour Front Avenue, #06-10, Keppel Bay Tower, Singapore 098632  
Tel: <65> 6213-0200, Fax: <65> 6278-8001

**Renesas Technology Korea Co., Ltd.**

Kukje Center Bldg. 18th Fl., 191, 2-ka, Hangang-ro, Yongsan-ku, Seoul 140-702, Korea  
Tel: <82> (2) 796-3115, Fax: <82> (2) 796-2145

**Renesas Technology Malaysia Sdn. Bhd**

Unit 906, Block B, Menara Amcorp, Amcorp Trade Centre, No.18, Jalan Persiaran Barat, 46050 Petaling Jaya, Selangor Darul Ehsan, Malaysia  
Tel: <603> 7955-9390, Fax: <603> 7955-9510



# H8S/2678R E6000 Emulator User's Manual



**Renesas Electronics Corporation**

1753, Shimonumabe, Nakahara-ku, Kawasaki-shi, Kanagawa 211-8668 Japan

REJ10J1129-0500