

Renesas Peripheral Driver Library

User's Manual

RX63N Group

All information contained in these materials, including products and product specifications, represents information on the product at the time of publication and is subject to change by Renesas Electronics Corp. without notice. Please review the latest information published by Renesas Electronics Corp. through various means, including the Renesas Electronics Corp. website (<http://www.renesas.com>).

Notice

1. Descriptions of circuits, software and other related information in this document are provided only to illustrate the operation of semiconductor products and application examples. You are fully responsible for the incorporation of these circuits, software, and information in the design of your equipment. Renesas Electronics assumes no responsibility for any losses incurred by you or third parties arising from the use of these circuits, software, or information.
2. Renesas Electronics has used reasonable care in preparing the information included in this document, but Renesas Electronics does not warrant that such information is error free. Renesas Electronics assumes no liability whatsoever for any damages incurred by you resulting from errors in or omissions from the information included herein.
3. Renesas Electronics does not assume any liability for infringement of patents, copyrights, or other intellectual property rights of third parties by or arising from the use of Renesas Electronics products or technical information described in this document. No license, express, implied or otherwise, is granted hereby under any patents, copyrights or other intellectual property rights of Renesas Electronics or others.
4. You should not alter, modify, copy, or otherwise misappropriate any Renesas Electronics product, whether in whole or in part. Renesas Electronics assumes no responsibility for any losses incurred by you or third parties arising from such alteration, modification, copy or otherwise misappropriation of Renesas Electronics product.
5. Renesas Electronics products are classified according to the following two quality grades: "Standard" and "High Quality". The recommended applications for each Renesas Electronics product depends on the product's quality grade, as indicated below.
"Standard": Computers; office equipment; communications equipment; test and measurement equipment; audio and visual equipment; home electronic appliances; machine tools; personal electronic equipment; and industrial robots etc.
"High Quality": Transportation equipment (automobiles, trains, ships, etc.); traffic control systems; anti-disaster systems; anti-crime systems; and safety equipment etc.

Renesas Electronics products are neither intended nor authorized for use in products or systems that may pose a direct threat to human life or bodily injury (artificial life support devices or systems, surgical implantations etc.), or may cause serious property damages (nuclear reactor control systems, military equipment etc.). You must check the quality grade of each Renesas Electronics product before using it in a particular application. You may not use any Renesas Electronics product for any application for which it is not intended. Renesas Electronics shall not be in any way liable for any damages or losses incurred by you or third parties arising from the use of any Renesas Electronics product for which the product is not intended by Renesas Electronics.
6. You should use the Renesas Electronics products described in this document within the range specified by Renesas Electronics, especially with respect to the maximum rating, operating supply voltage range, movement power voltage range, heat radiation characteristics, installation and other product characteristics. Renesas Electronics shall have no liability for malfunctions or damages arising out of the use of Renesas Electronics products beyond such specified ranges.
7. Although Renesas Electronics endeavors to improve the quality and reliability of its products, semiconductor products have specific characteristics such as the occurrence of failure at a certain rate and malfunctions under certain use conditions. Further, Renesas Electronics products are not subject to radiation resistance design. Please be sure to implement safety measures to guard them against the possibility of physical injury, and injury or damage caused by fire in the event of the failure of a Renesas Electronics product, such as safety design for hardware and software including but not limited to redundancy, fire control and malfunction prevention, appropriate treatment for aging degradation or any other appropriate measures. Because the evaluation of microcomputer software alone is very difficult, please evaluate the safety of the final products or systems manufactured by you.
8. Please contact a Renesas Electronics sales office for details as to environmental matters such as the environmental compatibility of each Renesas Electronics product. Please use Renesas Electronics products in compliance with all applicable laws and regulations that regulate the inclusion or use of controlled substances, including without limitation, the EU RoHS Directive. Renesas Electronics assumes no liability for damages or losses occurring as a result of your noncompliance with applicable laws and regulations.
9. Renesas Electronics products and technology may not be used for or incorporated into any products or systems whose manufacture, use, or sale is prohibited under any applicable domestic or foreign laws or regulations. You should not use Renesas Electronics products or technology described in this document for any purpose relating to military applications or use by the military, including but not limited to the development of weapons of mass destruction. When exporting the Renesas Electronics products or technology described in this document, you should comply with the applicable export control laws and regulations and follow the procedures required by such laws and regulations.
10. It is the responsibility of the buyer or distributor of Renesas Electronics products, who distributes, disposes of, or otherwise places the product with a third party, to notify such third party in advance of the contents and conditions set forth in this document, Renesas Electronics assumes no responsibility for any losses incurred by you or third parties as a result of unauthorized use of Renesas Electronics products.
11. This document may not be reproduced or duplicated in any form, in whole or in part, without prior written consent of Renesas Electronics.
12. Please contact a Renesas Electronics sales office if you have any questions regarding the information contained in this document or Renesas Electronics products, or if you have any other inquiries.

(Note 1) "Renesas Electronics" as used in this document means Renesas Electronics Corporation and also includes its majority-owned subsidiaries.

(Note 2) "Renesas Electronics product(s)" means any product developed or manufactured by or for Renesas Electronics.

General Precautions in the Handling of MPU/MCU Products

The following usage notes are applicable to all MPU/MCU products from Renesas. For detailed usage notes on the products covered by this document, refer to the relevant sections of the document as well as any technical updates that have been issued for the products.

1. Handling of Unused Pins

Handle unused pins in accordance with the directions given under Handling of Unused Pins in the manual.

- The input pins of CMOS products are generally in the high-impedance state. In operation with an unused pin in the open-circuit state, extra electromagnetic noise is induced in the vicinity of LSI, an associated shoot-through current flows internally, and malfunctions occur due to the false recognition of the pin state as an input signal become possible. Unused pins should be handled as described under Handling of Unused Pins in the manual.

2. Processing at Power-on

The state of the product is undefined at the moment when power is supplied.

- The states of internal circuits in the LSI are indeterminate and the states of register settings and pins are undefined at the moment when power is supplied.
In a finished product where the reset signal is applied to the external reset pin, the states of pins are not guaranteed from the moment when power is supplied until the reset process is completed. In a similar way, the states of pins in a product that is reset by an on-chip power-on reset function are not guaranteed from the moment when power is supplied until the power reaches the level at which resetting has been specified.

3. Prohibition of Access to Reserved Addresses

Access to reserved addresses is prohibited.

- The reserved addresses are provided for the possible future expansion of functions. Do not access these addresses; the correct operation of LSI is not guaranteed if they are accessed.

4. Clock Signals

After applying a reset, only release the reset line after the operating clock signal has become stable. When switching the clock signal during program execution, wait until the target clock signal has stabilized.

- When the clock signal is generated with an external resonator (or from an external oscillator) during a reset, ensure that the reset line is only released after full stabilization of the clock signal. Moreover, when switching to a clock signal produced with an external resonator (or by an external oscillator) while program execution is in progress, wait until the target clock signal is stable.

5. Differences between Products

Before changing from one product to another, i.e. to a product with a different part number, confirm that the change will not lead to problems.

- The characteristics of an MPU or MCU in the same group but having a different part number may differ in terms of the internal memory capacity, layout pattern, and other factors, which can affect the ranges of electrical characteristics, such as characteristic values, operating margins, immunity to noise, and amount of radiated noise. When changing to a product with a different part number, implement a system-evaluation test for the given product.

Table of Contents

Table of Contents	1
1. Introduction	1
1.1. Tool chain requirements	2
1.2. Compiler options when you use this product	2
1.3. Using the library within your project	3
1.3.1. Via the PDG graphical utility	3
1.3.2. Using RPDL stand-alone	3
1) Unzip the RPDL files	3
2) Copy the files into your project area	3
3) Include the new directory	6
4) Add the RPDL library file	7
5) Include the new source files	8
6) Peripherals that are not required	8
7) Peripherals that are not supported by RPDL	8
8) Avoid conflicts with standard project files	9
9) Set the build options	11
10) Build the project	13
11) Using library with debug information	14
1.3.3. Header file inclusion	15
1.3.4. Header file order	15
1.3.5. Recommended initialisation code	16
1) Initialisation of pins that are not available	16
2) Initialisation of the sub-clock oscillator if not used	16
1.4. Document structure	17
1.5. List of Abbreviations and Acronyms	18
2. Driver	19
2.1. Overview	19
2.2. Control Functions summary	19
2.3. Clock Generation Circuit Driver	21
2.4. Interrupt Control Driver	22
2.5. I/O Port Driver	23
2.6. Multifunction Pin Controller Driver	24
2.7. MCU Operation Driver	25
2.8. Voltage Detection Circuit Driver	26
2.9. Frequency Measurement Circuit Driver	27
2.10. Low Power Consumption Driver	28
2.11. Register Write Protection Driver	29
2.12. Bus Controller Driver	30
2.13. DMA Controller Driver	31
2.14. External DMA Controller Driver	32
2.15. Data Transfer Controller Driver	33
2.16. Multi-Function Timer Pulse Unit Driver	34
2.17. Port Output Enable Driver	35

2.18.	Timer Pulse Unit Driver	36
2.19.	Programmable Pulse Generator Driver	37
2.20.	8-bit Timer Driver	38
2.21.	Compare Match Timer Driver	39
2.22.	Real-time Clock Driver	40
2.23.	Watchdog Timer Driver	41
2.24.	Independent Watchdog Timer Driver	42
2.25.	Serial Communication Interface Driver	43
2.26.	I ² C Bus Interface Driver	44
2.27.	Serial Peripheral Interface Driver	45
2.28.	IEBus Interface Driver	46
2.29.	CRC Calculator Driver	47
2.30.	12-bit Analog to Digital Converter Driver	48
2.31.	10-bit Analog to Digital Converter Driver	49
2.32.	10-bit Digital to Analog Converter Driver	50
2.33.	Temperature Sensor Driver	51
3.	Types and definitions	52
3.1.	Data types	52
3.2.	General definitions	52
3.2.1.	PDL_NO_FUNC	52
3.2.2.	PDL_NO_PTR	52
3.2.3.	PDL_NO_DATA	52
3.2.4.	PDL_MCU_GROUP	52
3.2.5.	PDL_VERSION	52
3.2.6.	Bit definitions	52
4.	Library Reference	53
4.1.	API List by Peripheral Function	53
4.2.	Description of Each API	57
4.2.1.	Clock Generation Circuit	58
1)	R_CGC_Set	58
2)	R_CGC_Control	63
3)	R_CGC_GetStatus	66
4.2.2.	Interrupt Control Unit	67
1)	R_INTC_SetExtInterrupt	67
2)	R_INTC_CreateExtInterrupt	69
3)	R_INTC_CreateSoftwareInterrupt	71
4)	R_INTC_CreateFastInterrupt	72
5)	R_INTC_CreateExceptionHandler	76
6)	R_INTC_ControlExtInterrupt	77
7)	R_INTC_GetExtInterruptStatus	79
8)	R_INTC_Read	85
9)	R_INTC_Write	86
10)	R_INTC_Modify	87
11)	R_INTC_CreateGroup	88
12)	R_INTC_ControlGroup	89
13)	R_INTC_GetStatusGroup	91
14)	R_INTC_Control	93
4.2.3.	I/O Port	94

1)	R_IO_PORT_Set	96
2)	R_IO_PORT_ReadControl	97
3)	R_IO_PORT_ModifyControl	99
4)	R_IO_PORT_Read	101
5)	R_IO_PORT_Write	102
6)	R_IO_PORT_Compare	103
7)	R_IO_PORT_Modify	104
8)	R_IO_PORT_Wait	105
9)	R_IO_PORT_NotAvailable	106
10)	R_IO_PORT_Switch	107
4.2.4.	Multifunction Pin Controller	108
1)	R_MPC_Read	109
2)	R_MPC_Write	110
3)	R_MPC_Modify	111
4.2.5.	MCU operation	112
1)	R_MCU_Control	112
2)	R_MCU_GetStatus	113
3)	R_MCU_OFS	115
4.2.6.	Voltage Detection Circuit	118
1)	R_LVD_Create	118
2)	R_LVD_Control	120
3)	R_LVD_GetStatus	121
4.2.7.	Frequency Measurement Circuit	122
1)	R_MCK_Control	122
4.2.8.	Low Power Consumption	123
1)	R_LPC_Create	123
2)	R_LPC_Control	128
3)	R_LPC_WriteBackup	130
4)	R_LPC_ReadBackup	131
5)	R_LPC_GetStatus	132
4.2.9.	Register Write Protection	134
1)	R_RWP_Control	134
2)	R_RWP_GetStatus	135
4.2.10.	Bus Controller	136
1)	R_BSC_Set	136
2)	R_BSC_Create	137
3)	R_BSC_CreateArea	140
4)	R_BSC_Destroy	143
5)	R_BSC_Control	144
6)	R_BSC_SDRAM_CreateArea	146
7)	R_BSC_GetStatus	149
4.2.11.	DMA Controller	151
1)	R_DMAC_Create	151
2)	R_DMAC_Destroy	155
3)	R_DMAC_Control	156
4)	R_DMAC_GetStatus	159
4.2.12.	External DMA Controller	161
1)	R_EXDMAC_Set	161
2)	R_EXDMAC_Create	162
3)	R_EXDMAC_Destroy	165
4)	R_EXDMAC_Control	166
5)	R_EXDMAC_GetStatus	168
4.2.13.	Data Transfer Controller	170
1)	R_DTC_Set	170
2)	R_DTC_Create	171
3)	R_DTC_Destroy	175
4)	R_DTC_Control	176
5)	R_DTC_GetStatus	178
4.2.14.	Multi-Function Timer Pulse Unit	180
1)	R_MTU2_Set	180

2)	R_MTU2_Create.....	183
3)	R_MTU2_Destroy.....	193
4)	R_MTU2_ControlChannel.....	194
5)	R_MTU2_ControlUnit.....	197
6)	R_MTU2_ReadChannel.....	202
7)	R_MTU2_ReadUnit.....	205
4.2.15.	Port Output Enable.....	206
1)	R_POE_Set.....	206
2)	R_POE_Create.....	208
3)	R_POE_Control.....	210
4)	R_POE_GetStatus.....	212
4.2.16.	16-bit Timer Pulse Unit.....	213
1)	R_TPU_Set.....	213
2)	R_TPU_Create.....	216
3)	R_TPU_Destroy.....	222
4)	R_TPU_ControlChannel.....	223
5)	R_TPU_ControlUnit.....	225
6)	R_TPU_Read.....	227
4.2.17.	Programmable Pulse Generator.....	229
1)	R_PPG_Create.....	229
2)	R_PPG_Destroy.....	232
3)	R_PPG_Control.....	234
4.2.18.	8-bit Timer.....	235
1)	R_TMR_Set.....	235
2)	R_TMR_CreateChannel.....	237
3)	R_TMR_CreateUnit.....	240
4)	R_TMR_CreatePeriodic.....	243
5)	R_TMR_CreateOneShot.....	246
6)	R_TMR_Destroy.....	248
7)	R_TMR_ControlChannel.....	249
8)	R_TMR_ControlUnit.....	250
9)	R_TMR_ControlPeriodic.....	252
10)	R_TMR_ReadChannel.....	254
11)	R_TMR_ReadUnit.....	255
4.2.19.	Compare Match Timer.....	257
1)	R_CMT_Create.....	257
2)	R_CMT_CreateOneShot.....	259
3)	R_CMT_Destroy.....	261
4)	R_CMT_Control.....	262
5)	R_CMT_Read.....	264
4.2.20.	Real-time Clock.....	265
1)	R_RTC_Create.....	265
2)	R_RTC_Destroy.....	269
3)	R_RTC_Control.....	270
4)	R_RTC_Read.....	275
5)	R_RTC_CreateWarm.....	277
4.2.21.	Watchdog Timer.....	278
1)	R_WDT_Set.....	278
2)	R_WDT_Control.....	280
3)	R_WDT_Read.....	281
4.2.22.	Independent Watchdog Timer.....	282
1)	R_IWDT_Set.....	282
2)	R_IWDT_Control.....	284
3)	R_IWDT_Read.....	285
4.2.23.	Serial Communication Interface.....	286
1)	R_SCI_Set.....	286
2)	R_SCI_Create.....	291
3)	R_SCI_Destroy.....	296
4)	R_SCI_Send.....	297
5)	R_SCI_Receive.....	300

6)	R_SCI_SPI_Transfer	303
7)	R_SCI_IIC_Write	306
8)	R_SCI_IIC_Read	308
9)	R_SCI_IIC_ReadLastByte	310
10)	R_SCI_Control	311
11)	R_SCI_GetStatus	313
4.2.24.	I ² C Bus Interface	315
1)	R_IIC_Create	315
2)	R_IIC_Destroy	320
3)	R_IIC_MasterSend	321
4)	R_IIC_MasterReceive	323
5)	R_IIC_MasterReceiveLast	325
6)	R_IIC_SlaveMonitor	326
7)	R_IIC_SlaveSend	328
8)	R_IIC_Control	329
9)	R_IIC_GetStatus	330
4.2.25.	Serial Peripheral Interface	332
1)	R_SPI_Set	332
2)	R_SPI_Create	334
3)	R_SPI_Destroy	337
4)	R_SPI_Command	338
5)	R_SPI_Transfer	340
6)	R_SPI_Control	342
7)	R_SPI_GetStatus	344
4.2.26.	IEBus Controller	345
1)	R_IEB_Set	345
2)	R_IEB_Create	346
3)	R_IEB_Destroy	348
4)	R_IEB_MasterSend	349
5)	R_IEB_MasterReceive	351
6)	R_IEB_SlaveMonitor	353
7)	R_IEB_SlaveWrite	354
8)	R_IEB_Control	355
9)	R_IEB_GetStatus	357
4.2.27.	CRC calculator	359
1)	R_CRC_Create	359
2)	R_CRC_Destroy	360
3)	R_CRC_Write	361
4)	R_CRC_Read	362
4.2.28.	12-bit Analog to Digital Converter	363
1)	R_ADC_12_Create	363
2)	R_ADC_12_Destroy	368
3)	R_ADC_12_Control	369
4)	R_ADC_12_Read	370
4.2.29.	10-bit Analog to Digital Converter	371
1)	R_ADC_10_Set	371
2)	R_ADC_10_Create	372
3)	R_ADC_10_Destroy	376
4)	R_ADC_10_Control	377
5)	R_ADC_10_Read	378
4.2.30.	10-bit Digital to Analog Converter	379
1)	R_DAC_10_Create	379
2)	R_DAC_10_Destroy	381
3)	R_DAC_10_Write	382
4.2.31.	Temperature Sensor	383
1)	R_TS_Create	383
2)	R_TS_Destroy	384
3)	R_TS_Control	385
5.	Usage Examples	386

5.1.	Clock Generation Circuit.....	387
5.2.	Interrupt control	389
5.3.	I/O Port	391
5.4.	Voltage Detection Circuit	393
5.5.	Frequency Measurement Circuit	394
5.5.1.	Using System 1.....	394
5.5.2.	Using System 2.....	397
5.6.	Low Power Consumption	400
5.6.1.	Software Standby Mode.....	400
5.6.2.	Deep Software Standby Mode	401
5.7.	Bus Controller	403
5.7.1.	External bus, CS area.....	403
5.7.2.	External bus, SDRAM area.....	407
5.8.	DMA controller	409
5.9.	Data Transfer Controller	412
5.9.1.	Block transfer mode.....	412
5.9.2.	Chain transfer operation	414
5.10.	Port Output Enable	416
5.11.	Timer Pulse Unit	418
5.12.	Watchdog Timer.....	420
5.13.	8-bit Timer.....	421
5.13.1.	Periodic operation	421
5.14.	Compare Match Timer	423
5.15.	Real-time Clock	425
5.15.1.	Use case of RTC (configuration and use case).....	425
1)	Configuration CGC and RTC counting by sub-clock	425
2)	Configuration CGC and RTC counting by main clock	427
3)	Use using capture pin	429
5.15.2.	Initialization in case of RTC is not used.....	431
1)	Initialize RTC with providing sub-clock (use-case sub clock is available).....	431
2)	Initialize RTC with providing main-clock (use-case main clock is available).....	432
3)	Initialize RTC without providing clock	433
5.15.3.	Use case of RTC over reset and power consumption	434
1)	Wake up from sleep mode	434
2)	Wake up from deep standby mode.....	440
3)	With Vbatt mode	446
5.16.	Independent Watchdog Timer	450
5.17.	Serial Communication Interface	451
5.17.1.	SCI Asynchronous Using Polling	451
5.17.2.	SCI Asynchronous Using Interrupts.....	453
5.17.3.	SCI Asynchronous Using DMAC	455
5.17.4.	Synchronous Transmission and Reception	457
5.17.5.	Synchronous Full Duplex Operation	459
5.17.6.	SCI Reception in Asynchronous Multi-Processor mode	461
5.17.7.	SCI Transmission in Asynchronous Multi-Processor mode	463
5.17.8.	SCI in SPI Mode	465
5.17.9.	SCI in IIC Mode.....	466
5.17.10.	SCI in IIC Mode using DMAC	468
5.17.11.	SCI in IIC Mode using DTC.....	470
5.18.	I ² C Bus Interface.....	473
5.18.1.	Master mode	473

1)	Configuration and transmission	474
2)	Reception.....	475
3)	Repeated Start.....	476
5.18.2.	Master mode with DMAC.....	477
5.18.3.	Master mode with DTC.....	481
5.18.4.	Slave mode.....	485
5.19.	Serial Peripheral Interface.....	488
5.19.1.	Using one slave (1).....	488
5.19.2.	Using one slave (2).....	491
5.19.3.	Master operation with multiple slaves.....	494
5.20.	IEBus Interface.....	497
5.20.1.	Master operation.....	497
5.20.2.	Slave operation using polling.....	500
5.20.3.	Slave operation using interrupts.....	503
5.21.	CRC calculator.....	506
5.22.	10-bit Analog to Digital Converter.....	507
5.23.	12-bit Analog to Digital Converter.....	508
5.24.	10-bit Digital to Analog Converter.....	509
5.25.	Programmable Pulse Generator.....	510
5.26.	Temperature Sensor.....	511
5.27.	Multi-Function Timer Pulse Unit.....	513
6.	RX-specific notes.....	515
6.1.	Interrupts and processor mode.....	515
6.2.	Interrupts and DSP instructions.....	515
Revision History	1

1. Introduction

The Renesas Peripheral Driver Library (RPDL) is a unified API for controlling the peripheral modules on the microcontrollers made by Renesas Electronics.

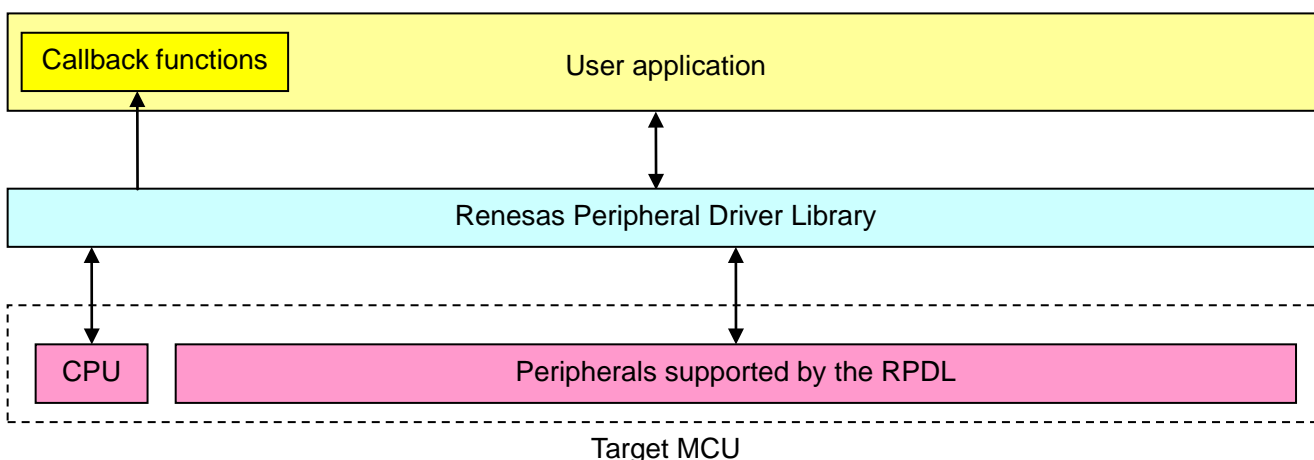

Figure 1-1: System configuration, with all peripherals supported by RPDL

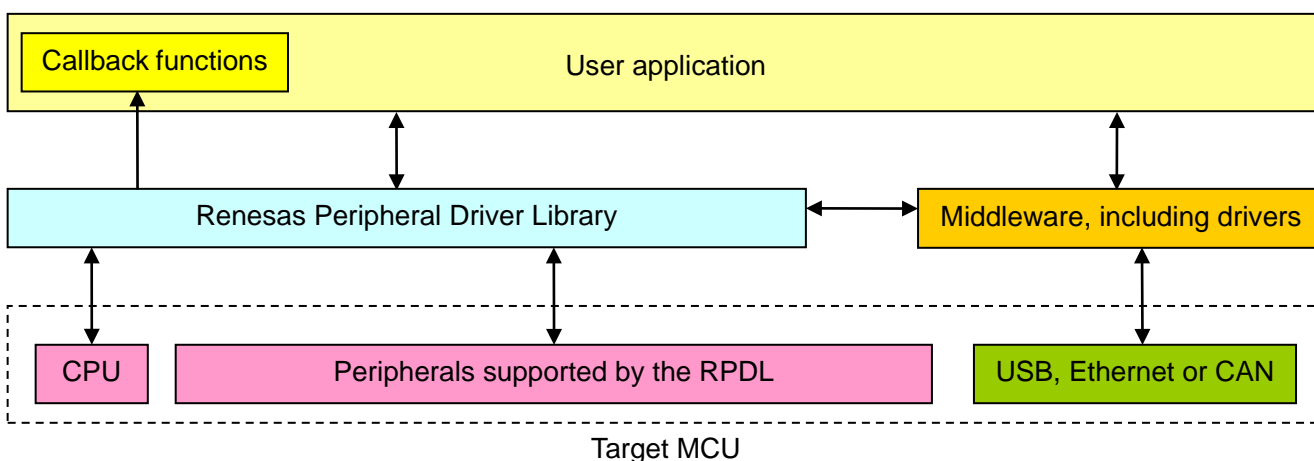

Figure 1-2: System configuration, with middleware taking direct control of some peripherals

The library is packaged as:

- a) A binary file containing all of the peripheral driver functions,
- b) Header files containing the information that the user needs to call any of the functions from their own application code and
- c) Interrupt handlers supplied as source code.

For best use of this library, it is required that the user will have the following documents as a minimum:

- i. The hardware schematic diagram
- ii. The MCU hardware manual
- iii. This RPDL API User's manual

The binary file is produced using the Renesas RX C tool chain. It should be usable by another linker that conforms to the Renesas Application Binary Interface.

The coding standards and naming conventions are specified by Renesas.

1.1. Tool chain requirements

This RPD Library has been built and tested using the C/C++ Compiler Package for RX Family V.1.02 Release 01. It cannot be used with older versions of the tool chain.

The latest version of the tool chain can be downloaded from the Renesas Web site ([Home / Products / Software and Tools / Coding Tools / C/C++ Compilers and Assemblers / C/C++ Compiler Package for RX Family /](#)).

1.2. Compiler options when you use this product

(1) The options which must be specified in your project are listed below.

The options other than -cpu, -dbl_size are the default setting of the compiler.

- cpu = rx600
- round = nearest
- denormalize = off
- dbl_size = 8
- unsigned_char
- unsigned_bitfield
- bit_order = right
- unpack
- noexception
- rtti = off
- fint_register = 0
- branch = 24

(2) The options which must NOT be specified in your project are listed below.

As the default setting of the compiler, the following options are not specified.

- int_to_short
- auto_enum
- base
- patch
- pic
- pid
- nouse_pid_register
- save_acc

1.3. Using the library within your project

The driver library can be used in two ways.

1.3.1. Via the PDG graphical utility

PDG can be downloaded from www.renesas.com/pdg.

The directions for use of the PDG utility are given in the PDG manual.

1.3.2. Using RPDL stand-alone

To add the driver library to your project's build environment, you need to

- a) Unzip the RPDL distribution.
- b) Copy the required source, header and library files into your project folder.
- c) Include the required source files.
- d) Add the driver library file to the linked files list.

The instructions to follow for stand-alone use start are given below.

- 1) Unzip the RPDL files

Double-click on the file RPDL_RX63N.exe to unpack the files.
The default location is C:\Renesas\RPDL_RX63N.

- 2) Copy the files into your project area

Navigate to where the RPDL files were unpacked.

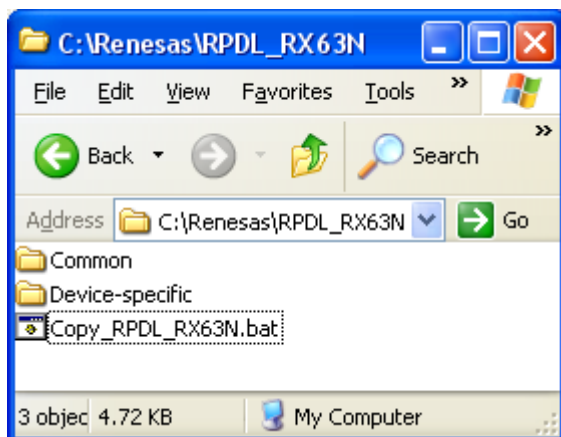

Double-click on "Copy_RPDL_RX63N.bat" to start the copy process. The batch file requires some information about the target device so that it can configure RPDL correctly.

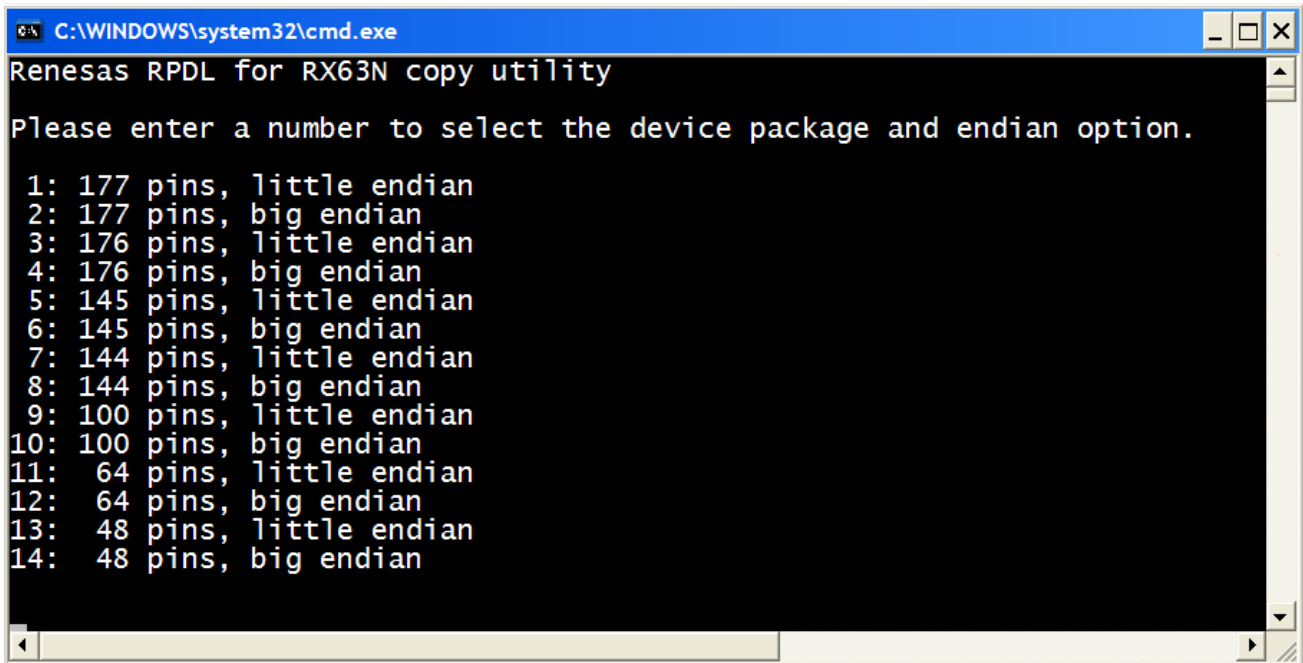

```
C:\WINDOWS\system32\cmd.exe
Renesas RPDL for RX63N copy utility
Please enter a number to select the device package and endian option.
1: 177 pins, little endian
2: 177 pins, big endian
3: 176 pins, little endian
4: 176 pins, big endian
5: 145 pins, little endian
6: 145 pins, big endian
7: 144 pins, little endian
8: 144 pins, big endian
9: 100 pins, little endian
10: 100 pins, big endian
11: 64 pins, little endian
12: 64 pins, big endian
13: 48 pins, little endian
14: 48 pins, big endian
```

Select the required device package, endian and debug information options by pressing the corresponding number, and then press Enter. For example, select '3' for "176 pins, little endian".

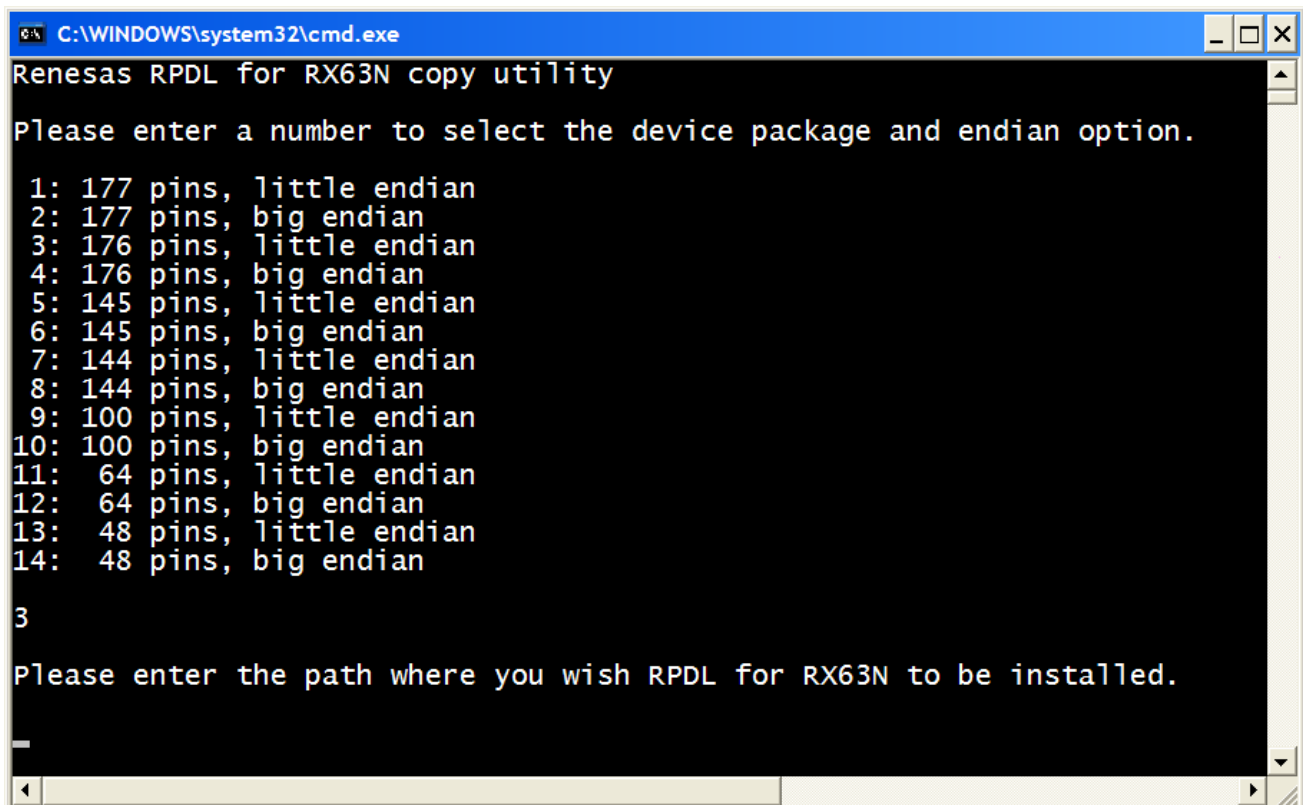

```
C:\WINDOWS\system32\cmd.exe
Renesas RPDL for RX63N copy utility
Please enter a number to select the device package and endian option.
1: 177 pins, little endian
2: 177 pins, big endian
3: 176 pins, little endian
4: 176 pins, big endian
5: 145 pins, little endian
6: 145 pins, big endian
7: 144 pins, little endian
8: 144 pins, big endian
9: 100 pins, little endian
10: 100 pins, big endian
11: 64 pins, little endian
12: 64 pins, big endian
13: 48 pins, little endian
14: 48 pins, big endian
3
Please enter the path where you wish RPDL for RX63N to be installed.
_
```

Type the full path (for example "c:\my_project_folder") to the folder where you wish RPDL to be copied to, and then press Enter. The utility will create a folder in the location that you specified and copy the files into the new folder

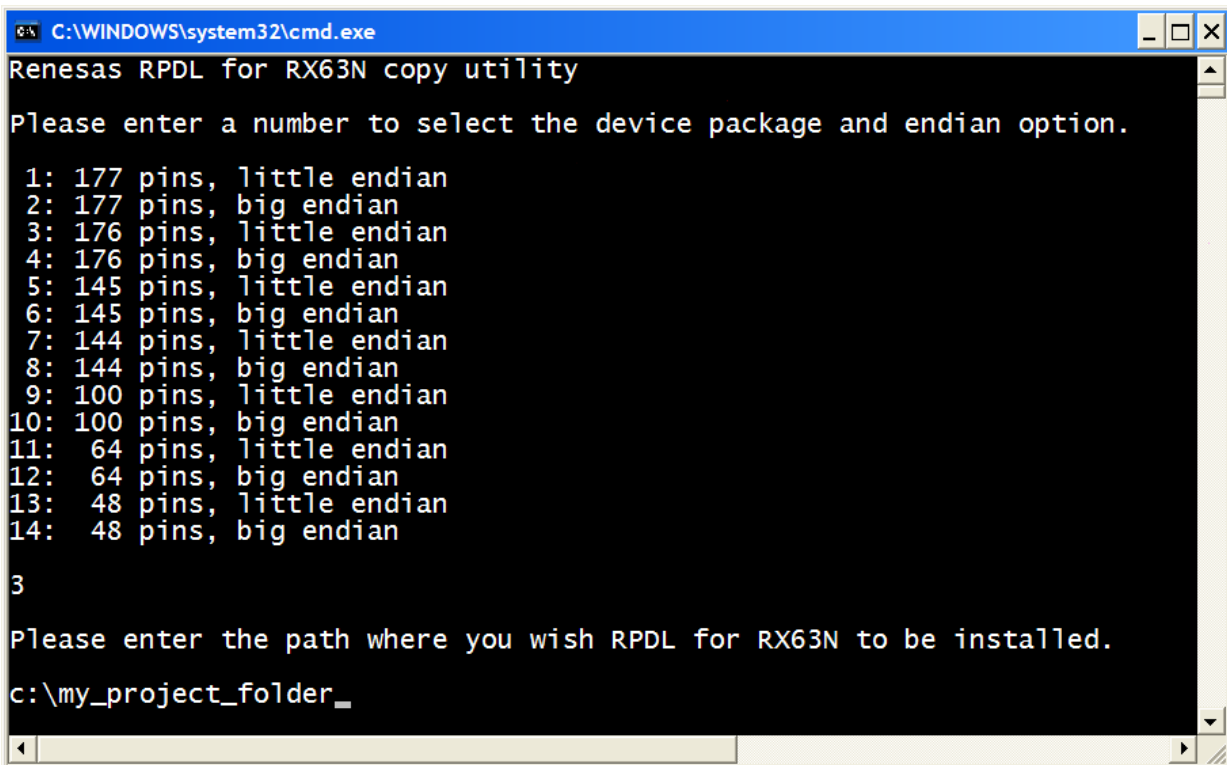

```
C:\WINDOWS\system32\cmd.exe
Renesas RPDL for RX63N copy utility
Please enter a number to select the device package and endian option.

1: 177 pins, little endian
2: 177 pins, big endian
3: 176 pins, little endian
4: 176 pins, big endian
5: 145 pins, little endian
6: 145 pins, big endian
7: 144 pins, little endian
8: 144 pins, big endian
9: 100 pins, little endian
10: 100 pins, big endian
11: 64 pins, little endian
12: 64 pins, big endian
13: 48 pins, little endian
14: 48 pins, big endian

3

Please enter the path where you wish RPDL for RX63N to be installed.
c:\my_project_folder_
```

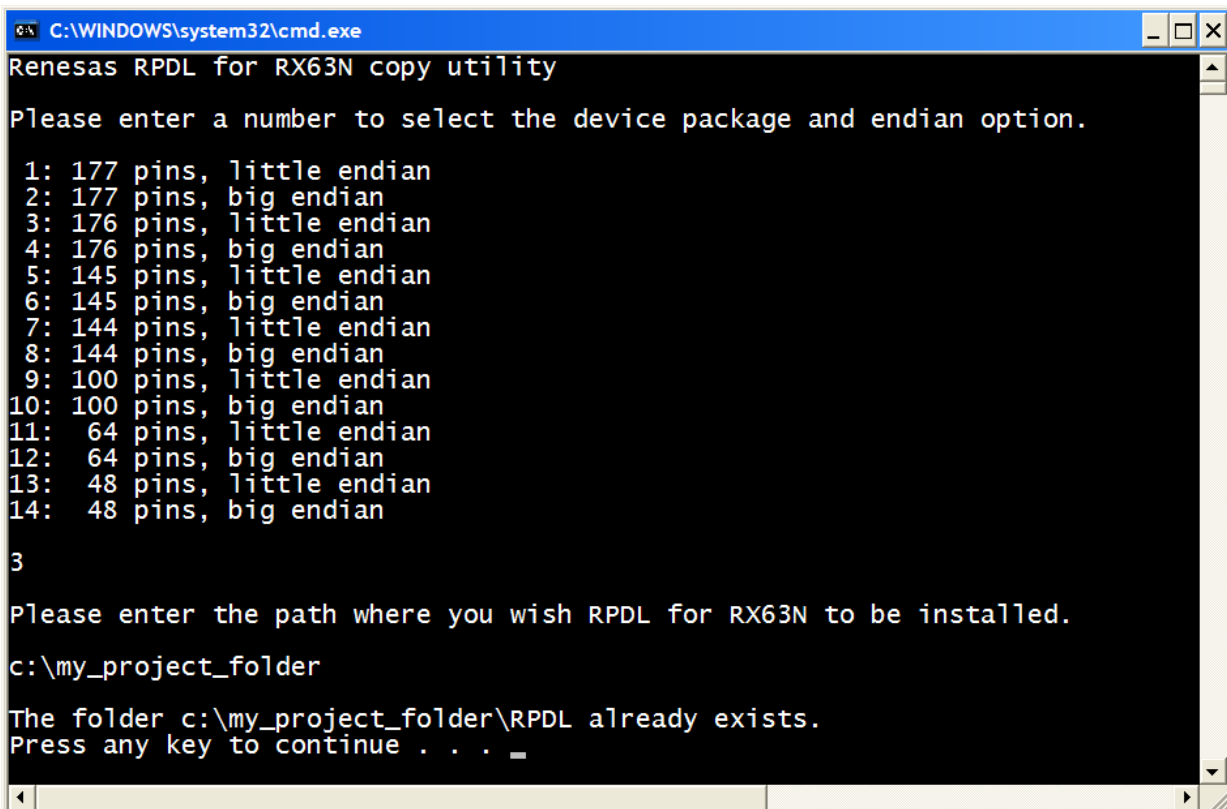

```
C:\WINDOWS\system32\cmd.exe
Renesas RPDL for RX63N copy utility
Please enter a number to select the device package and endian option.

1: 177 pins, little endian
2: 177 pins, big endian
3: 176 pins, little endian
4: 176 pins, big endian
5: 145 pins, little endian
6: 145 pins, big endian
7: 144 pins, little endian
8: 144 pins, big endian
9: 100 pins, little endian
10: 100 pins, big endian
11: 64 pins, little endian
12: 64 pins, big endian
13: 48 pins, little endian
14: 48 pins, big endian

3

Please enter the path where you wish RPDL for RX63N to be installed.
c:\my_project_folder

The folder c:\my_project_folder\RPDL already exists.
Press any key to continue . . . _
```

Press any key to close the window.

Copy folder "RPDL" into the folder project workspace created. (Example "C:\WorkSpace\rpdl_lib_test\rpdl_lib_test")

3) Include the new directory

Use the key sequence Alt, B, R to open the “RX Standard Toolchain” window.

Select the C/C++ tab.

Use the key sequence S, I to show the included file directories.

Click on the “Add...” button.

In the “Add include file directory” window, enter the details as shown:

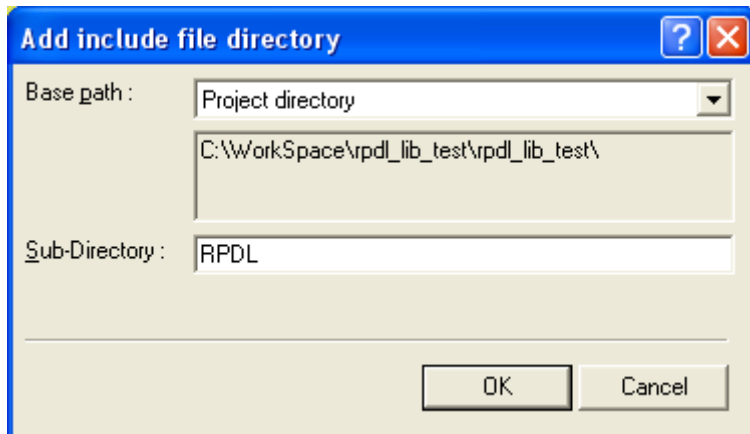

Click on “OK” to close the window.

Click on the “Add...” button.

In the “Add include file directory” window, enter the details as shown:

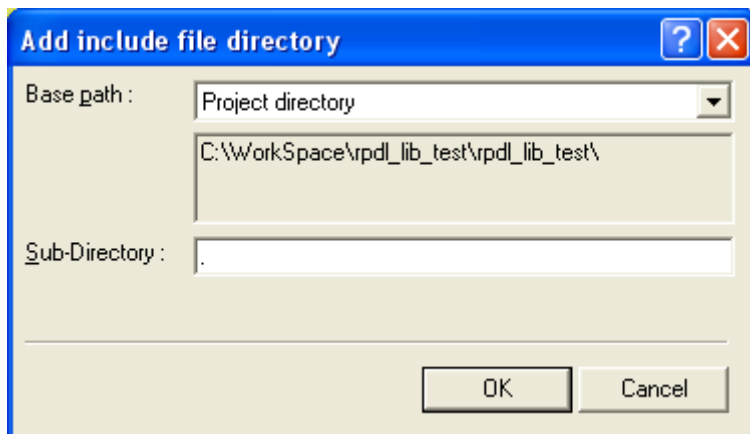

Click on “OK” to close the window.

4) Add the RPD_L library file

The library file is added to the list used by the linker application.

Select the Link/Library tab.

From the “Show entries for :” drop-down menu, select “Library files”.

Click on the “Add...” button.

In the “Add library file” window, select “Project directory”.

To use library without debug information, enter “RPDL\RX63N_library” as the File path.

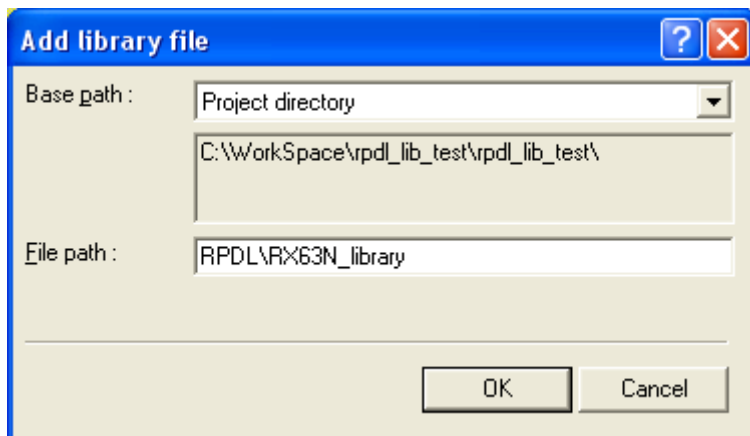

To use library with debug information, enter “RPDL\RX63N_library_debug” as the File path.

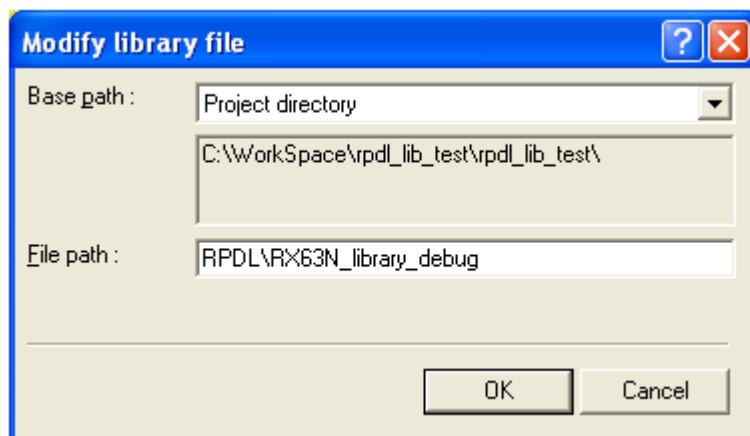

Click on “OK” to close the window.

Click on “OK” to return to the main HEW window.

Copy the to folder C:\Workspace\rpd_lib_test\rpd_lib_test

5) Include the new source files

Use the key sequence Alt, P, A to open the "Add files to project '<your project>'" window.

Double click on the RPD_L folder.

From the "Files of type" drop-down list, select "C source file (*.C)".
Use the key sequence Ctrl-A to select all of the files, as shown below.

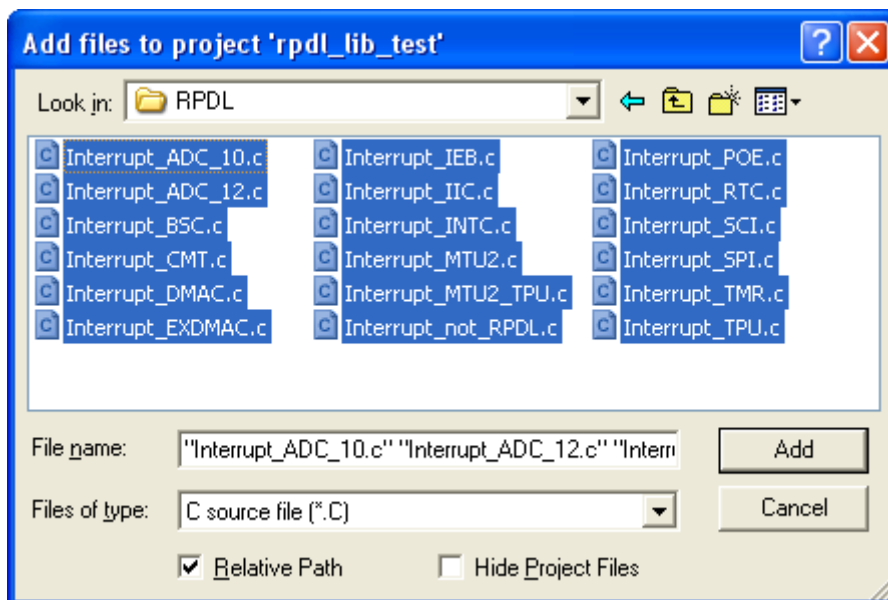

Click on "Add".

Click on "OK" to return to the main HEW window.

6) Peripherals that are not required

If a peripheral module is not required, the interrupt handler file does not need to be included.

If the unused interrupts still require entries in the interrupt vector table, edit the file Interrupt_not_RPD_L.c to uncomment the #define for the unused peripherals.

For example,

```
//#define RPD_L_ADC_12_not_used
```

Becomes

```
#define RPD_L_ADC_12_not_used
```

The file Interrupt_INTC.c must be included.

7) Peripherals that are not supported by RPD_L

The file Interrupt_not_RPD_L.c also contains handlers for the peripherals that are not supported by RPD_L. This allows the user to add handler code for these peripherals while supporting the Fast Interrupt feature (see R_INTC_CreateFastInterrupt).

8) Avoid conflicts with standard project files

If the files 'intrpg.c' or 'vecttbl.c' are included in the project, remove or exclude them.

(a) Removal

Use the key sequence Alt, P, R to open the "Remove Project Files" window.

Select the files and click on Remove.

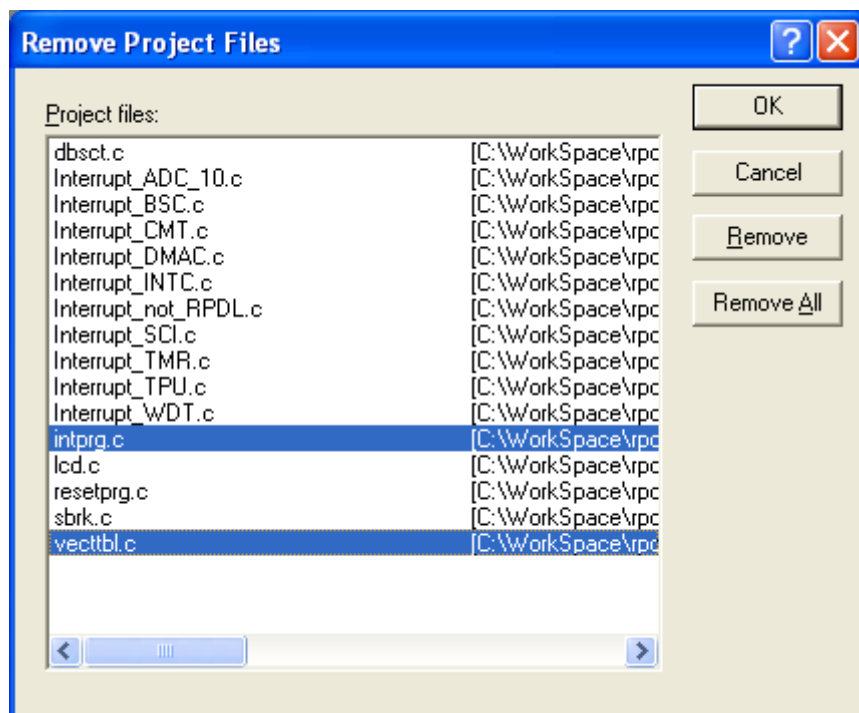

(b) Exclusion

Select the two files and use the key sequence Alt, B, I to exclude them.

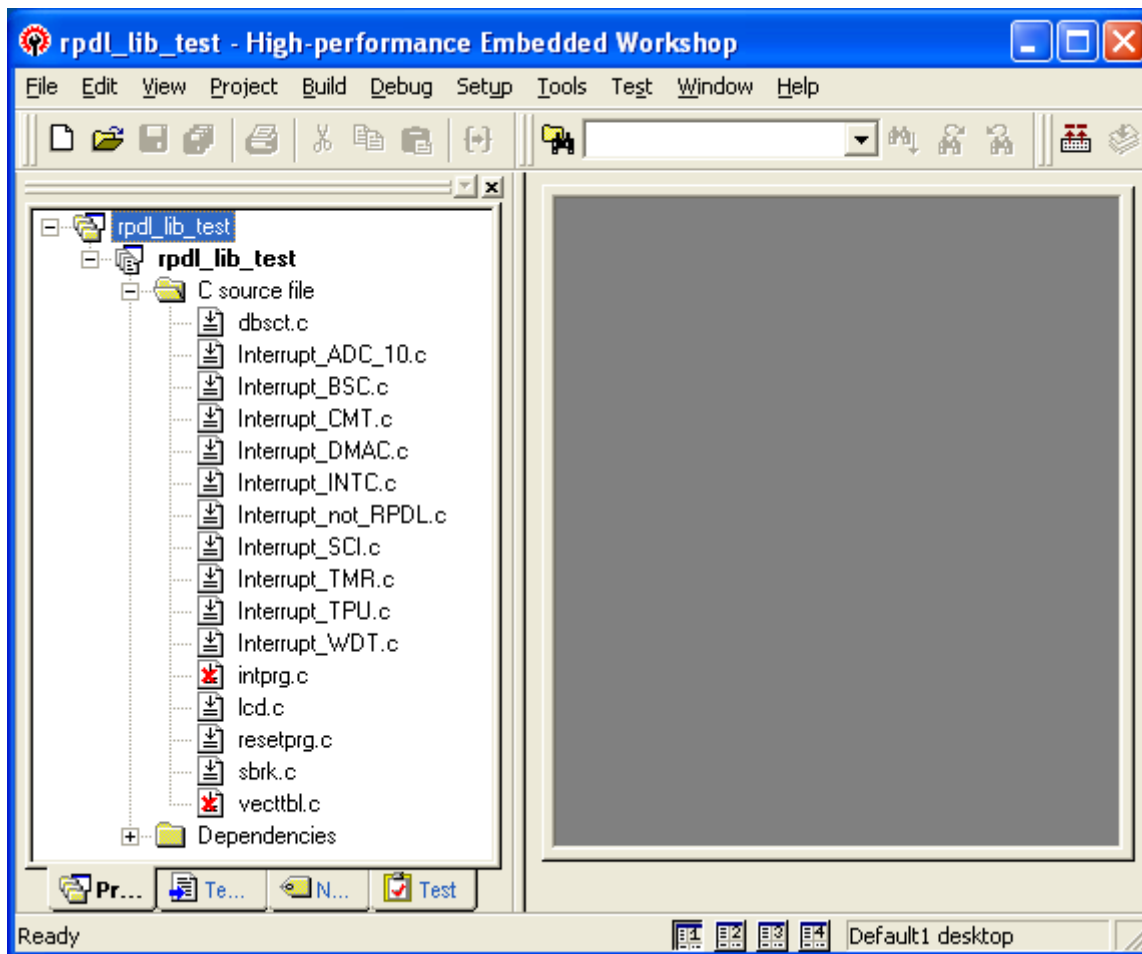

Figure 1-3: intrpg.c and vecttbl.c have been excluded

9) Set the build options.

Use the key sequence Alt, B, R to open the "RX Standard Toolchain" window.

In this section, only options which you must change from the default settings are described. If you add RPDL in existing project, see also "1.2 Compiler options"

(a) Set the optimisation

To avoid linking unused RPDL functions, adjust the Compiler and Linker settings.

(i) Compiler

Select the C/C++ tab.

Use the key sequence Y, O, O to show the optimisation options.

Ensure that the "Inter-module optimization" option is enabled.

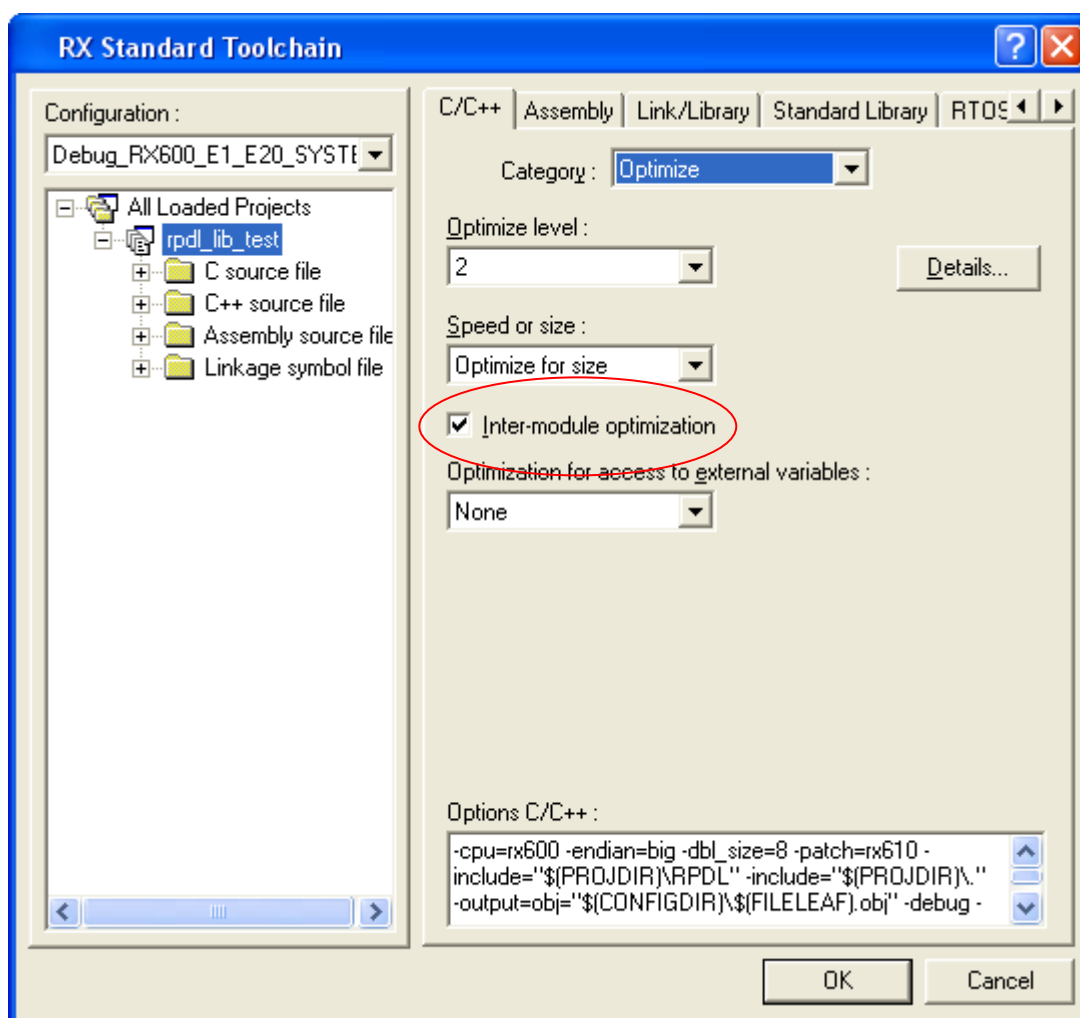

(ii) Linker

Select the Link/Library tab.

Use the key sequence Y, O, O to show the optimisation options.

If the "Eliminate dead code" option is not enabled, from the Optimize drop-down list select Custom and enable the option.

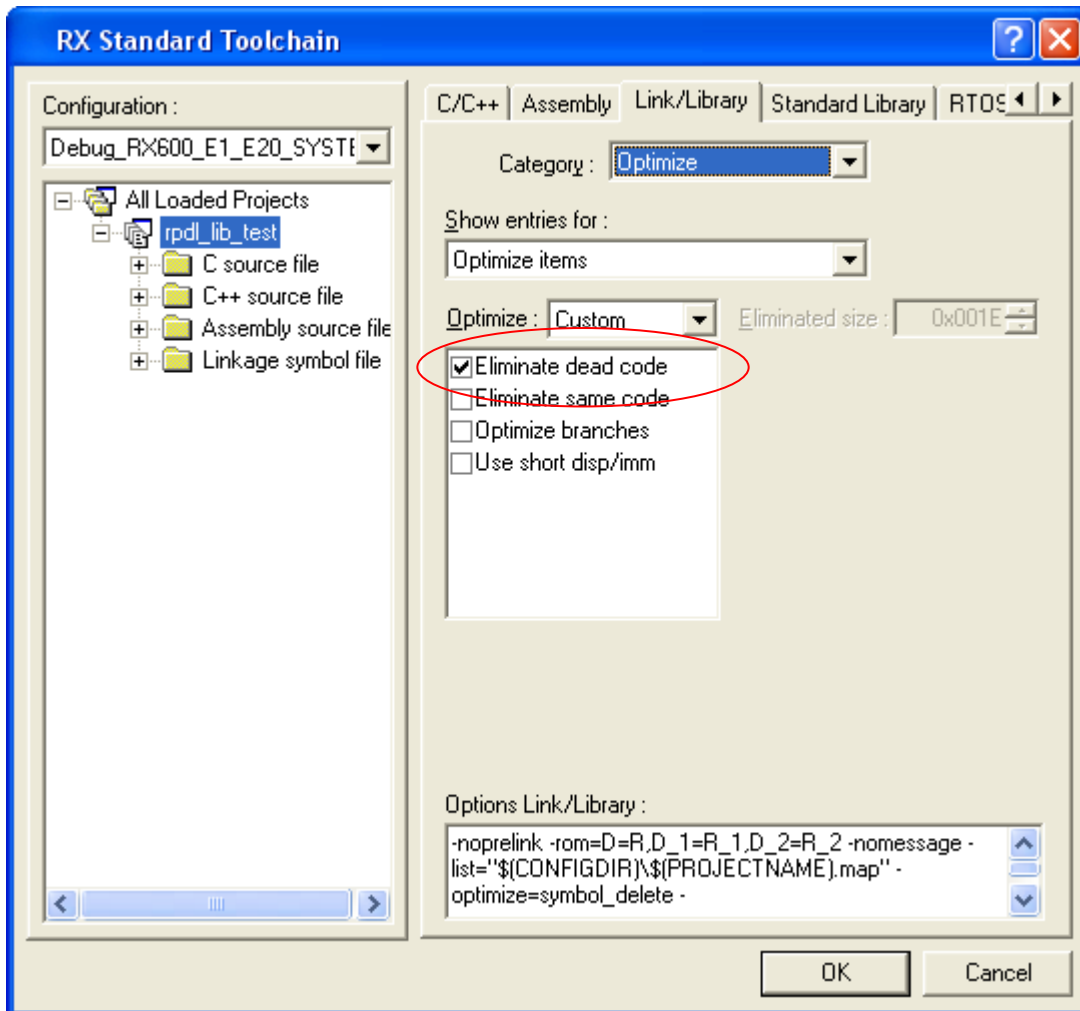

(b) Set the floating point precision

The wide range of possible internal clock frequencies requires double-precision floating point number storage.

Select the CPU tab.

Click on the Details... button to open the “CPU details” window.

Use the drop-down menu to select Double precision.

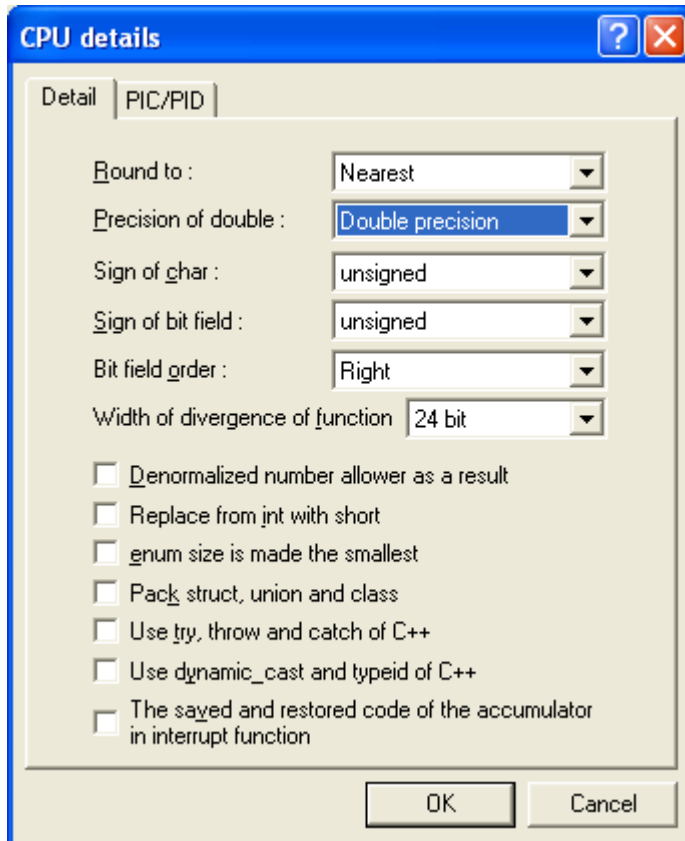

Click on “OK” to close the window.

Click on “OK” to return to the main HEW window.

10) Build the project

No further configuration should be required.
Simply build the project.

11) Using library with debug information

RPDL library with debug information should be chosen, in order to step in the RPDL source code for debugging.

Unzip the RPDL source zip file (e.g. "RPDL_RX63N_CS.x.xx_source.zip") into a folder (e.g. "c:\my_project_folder").

Set a breakpoint at the RPDL API to be debugged.

When the program breaks at the RPDL API, press "F11" key to step in the function.

A pop-up window will appear to request for the location of the corresponding RPDL source file.

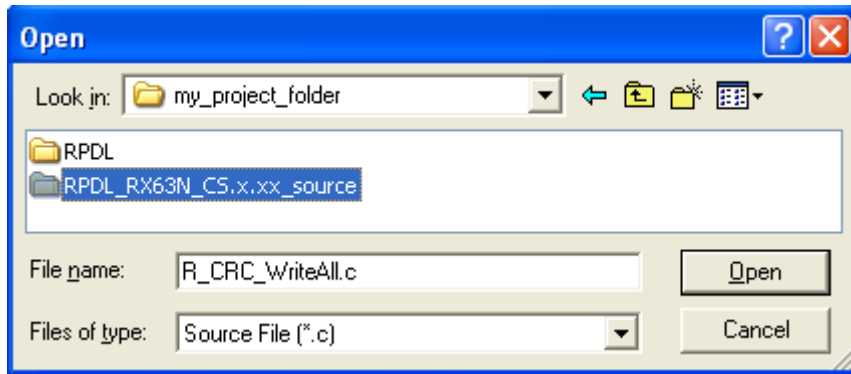

Select the folder where you unzip the RPDL source file, and open the source file under respective module folder.

Once the correct source file is selected, user could step in to the file and step through the function.

1.3.3. Header file inclusion

The RPD_L folder contains a header file, `iodefine_RPD_L.h`.

This file is included by the RPD_L source files and will also be included by any user-generated files that call RPD_L functions.

The main HEW project folder may contain the header file `iodefine.h`.

This file is normally used if access to the I/O registers in the MCU is required.

For any user-generated files that call RPD_L functions, there is no need to include this file `iodefine.h`.

1.3.4. Header file order

The file `r_pdl_definitions.h` must be included after any peripheral-specific header file.

For example:

```
/* Peripheral driver function prototypes and definitions */
#include "r_pdl_cgc.h"
#include "r_pdl_cmt.h"

/* PDL device-specific definitions */
#include "r_pdl_definitions.h"
```

1.3.5. Recommended initialisation code

The RX tool chain has a designated function for MCU initialisation, `HardwareSetup()`.

During the MCU initialisation phase, it is recommended that the following functions are placed in this function.

Note that the file `resetprg.c` (supplied when a new project is created) requires editing to remove the “//” comment identifiers for the two lines below.

```
//extern void HardwareSetup(void);  
// HardwareSetup();
```

1) Initialisation of pins that are not available

For pins that are not available on the selected MCU package type, set the control registers to the recommended values using `R_IO_PORT_NotAvailable()`;

This function can be called even if the largest device has been selected. This will allow for the user's code to be ported to another project that does use a smaller MCU package.

2) Initialisation of the sub-clock oscillator if not used

If the sub-clock oscillator will not be used, it should be put into a stable state. Please refer the program in section 5.15.2 Initialization in case of RTC is not used.

1.4. Document structure

The drivers are summarised in section 2 and explained in detail in section 4.

Section 5 provides usage examples.

Section 6 provides details which are specific to the RX CPU.

1.5. List of Abbreviations and Acronyms

Abbreviation	Full form
ADC	Analog to Digital Converter
API	Application Programming Interface
BCD	Binary-Coded Decimal
Bit	Binary digit
bps	Bits per second
BSC	Bus State Controller
CAN	Controller Area Network
CGC	Clock Generation Circuit
CMOS	Complementary Metal-Oxide Semiconductor
CMT	Compare Match Timer
CPU	Central Processing Unit
CRC	Cyclic Redundancy Check
DAC	Digital to Analog Converter
DC	Direct Current
DMA	Direct Memory Access
DMAC	DMA Controller
DSP	Digital Signal Processing
DTC	Data Transfer Controller
EEPROM	Electrically Erasable and Programmable ROM
EXDMA	External DMA
EXDMAC	External DMAC
FIFO	First-In, First-Out
GSM	Global System for Mobile communications
HEW	High-performance Embedded Workbench
HOCO	High-speed On-Chip Oscillator
IEBus	Inter-Equipment Bus
I ² C	Inter-Integrated Circuit
INTC	Interrupt Controller
I/O	Input / Output
IWDT	Independent WDT
kB	Kilo Byte (1024 bytes)
LOCO	Low-speed On-Chip Oscillator
LPC	Low Power Consumption
LSB	Least-Significant Bit
MB	Mega Byte (1024 kB)
MCU	Microcontroller Unit
MPC	Multifunction Pin Controller
MSB	Most-Significant Bit
MTU	Multi-function Timer pulse Unit
NMI	Non-Maskable Interrupt
OFS	Option Function Select
PDG	Peripheral Driver Generator
PLL	Phase-Locked Loop
POE	Port Output Enable
PPG	Programmable Pulse Generator
PWM	Pulse-Width Modulation
RAM	Random-Access Memory
ROM	Read-Only Memory
RPDL	Renesas Peripheral Driver Library
RSPI	Renesas SPI
SCI	Serial Communications Interface
SDRAM	Synchronous Dynamic RAM
SMBus	System Management Bus
SPI	Serial Peripheral Interface
USB	Universal Serial Bus
VGA	Video Graphics Array
WDT	Watchdog Timer

All trademarks and registered trademarks are the property of their respective owners.

2. Driver

2.1. Overview

This library provides a set of peripheral function control programs (peripheral drivers) for Renesas microcontrollers and allows the peripheral driver to be built into a user program.

2.2. Control Functions summary

This library has the following control functions available as peripheral drivers.

- (1) Clock Generation Circuit
These driver functions are used to configure the multiple internal clock signals.
- (2) Interrupt
These driver functions are used for configuring the external interrupt pins, handling fixed interrupts and controlling the interrupt priority.
- (3) I/O Port
These driver functions are used to configure the I/O pins and provide data read, write, compare and modify operations.
- (4) Multifunction Pin Controller
These driver functions are used for configuring the I/O pin optional functions.
- (5) MCU Operation
These driver functions are used for configuring the MCU operation.
- (6) Voltage Detection Circuit
These driver functions are used for configuring the low-voltage detection response.
- (7) Frequency Measurement Circuit
These driver functions are used for configuring the frequency measurement circuit.
- (8) Low Power Consumption
These driver functions are used for selecting lower power consumption.
- (9) Register Write Protection
These driver functions are used for controlling and checking the register write protection.
- (10) Bus Controller
These driver functions are used for configuring the external address bus, data bus and chip select pins and handling any bus errors.
- (11) DMA Controller
These driver functions are used for configuring and controlling the transfer of data within the address space.
- (12) External DMA Controller
These driver functions are used for configuring and controlling the transfer of data within the address space.
- (13) Data Transfer Controller
These driver functions are used for configuring and controlling the transfer of data triggered by peripheral interrupts.
- (14) Multi-Function Timer Pulse Unit
These driver functions are used for configuring and controlling the multi-function timers.
- (15) Port Output Enable
These driver functions are used for additional configuring and controlling of the timer outputs.
- (16) Timer Pulse Unit driver
These driver functions are used to configuring and controlling the timer pulse.
- (17) Programmable Pulse Generator
These driver functions are used for configuring and controlling the pulse generator outputs.

- (18) 8-bit Timer
These driver functions are used for configuring and controlling the timers.
- (19) Compare Match Timer
These driver functions are used for configuring and controlling the timers.
- (20) Real-time Clock
These driver functions are used for configuring and controlling the real-time clock timer.
- (21) Watchdog Timer
These driver functions are used for configuring and controlling the timer.
- (22) Independent Watchdog Timer
These driver functions are used for configuring and controlling the timer.
- (23) Serial Communication Interface
These driver functions are used to configure the serial channels and manage the transmission and / or reception of data across them.
- (24) I²C Bus Interface
These driver functions are used for controlling the I²C bus channels.
- (25) Serial Peripheral Interface
These driver functions are used for controlling the SPI channels.
- (26) IEBus Interface Driver
These driver functions are used for controlling the IEBus interface channel.
- (27) CRC calculator
These driver functions are used for controlling the calculator.
- (28) 12-bit Analog to Digital Converter
These driver functions are used for configuring the 12-bit ADC units, controlling the units and reading the conversion results.
- (29) 10-bit Analog to Digital Converter
These driver functions are used for configuring the 10-bit ADC units, controlling the units and reading the conversion results.
- (30) 10-bit Digital to Analog converter
These driver functions are used for configuring the DAC module and setting the output voltages.
- (31) Temperature Sensor driver
These driver functions are used for configuring the Temperature sensor module.

2.3. Clock Generation Circuit Driver

The driver functions support the control of the internal clock generator, providing the following operations.

1. Configuration of the multiple clock outputs for system, peripheral and external bus operation.
2. Controlling the clock generator operation.
3. Reading the Clock generator status flags.

Note: Configuring the Clock Generation Circuit also provides information on clock frequencies that will be used by the integrated drivers for other peripherals.

2.4. Interrupt Control Driver

The driver functions support the use of the interrupt controller, providing the following operations.

1. Selecting the applicable interrupt pins.
2. Configuration of an external interrupt signal for use.
3. Enabling use of the software interrupt.
4. Assigning an interrupt to be processed using the Fast Interrupt route.
5. Assigning handlers for the fixed exception interrupts.
6. Controlling an external interrupt input.
7. Reading the status of an external interrupt.
8. Reading an interrupt register.
9. Writing to an interrupt register.
10. Modifying an interrupt register.
11. Configuring a group of interrupt sources.
12. Controlling a group of interrupt sources.
13. Reading the status of a group of interrupt sources.
14. Choosing the timer source for shared interrupts.

2.5. I/O Port Driver

The driver functions support the use of the I/O port pins, providing the following operations.

1. Configuration for use.
2. Reading the pin or port configuration.
3. Modifying the pin or port configuration.
4. Reading a pin or 8-bit port value.
5. Writing to a pin or 8-bit port.
6. Comparing a pin or 8-bit port with a supplied value.
7. Modifying a pin or 8-bit port using a logical operation.
8. Waiting until a pin or 8-bit port matches a supplied value.
9. Configuring the pins that are not available on smaller packages to the required state.
10. Modify an I/O port's switch registers

2.6. Multifunction Pin Controller Driver

The driver functions support access to the Multifunction Pin Controller (MPC) registers which select the mode of operation for some I/O pins.

The other driver functions modify the MPC registers automatically. For peripherals that are not supported by the driver library, these functions support:

1. Reading from an MPC register.
2. Writing to an MPC register.
3. Modifying an MPC register

2.7. MCU Operation Driver

The driver functions support access to the registers which select the mode of operation for the microcontroller. These functions support:

1. Controlling the MCU features and on-chip ROM.
2. Reading the MCU status flags.
3. Setting the MCU start-up options.

2.8. Voltage Detection Circuit Driver

The driver function supports configuration of VDET1 and VDET2 voltage detection circuits. This function supports:

1. Setting voltage thresholds.
2. Defining a voltage event.
3. Configuring a reset when supply voltage drops below a voltage threshold.

2.9. Frequency Measurement Circuit Driver

The driver functions support access to the registers which control the frequency measurement circuit. These functions support:

1. Selecting the reference clock for each measurement system.

2.10. Low Power Consumption Driver

The driver functions support access to the registers which select the lower power modes of operation for the microcontroller. These functions support:

1. Configuring the state while in standby mode, and the activity that can be used to resume operation.
2. Selecting one of the low-power modes.
3. Writing data to the backup memory area.
4. Reading data from the backup memory area.
5. Determining the cause of the exit from the lowest power mode.

2.11. Register Write Protection Driver

The driver functions support the control of the Register Write Protection, providing the following operations.

1. Enabling or disabling writing to the registers.
2. Reading the status of the write protection.

2.12. Bus Controller Driver

The driver functions support the control of the external bus, providing the following operations.

1. Setting the internal bus operation.
2. Configuration of the controller.
3. Configuration of the eight address space areas.
4. Configuration of the SDRAM address space area.
5. Disabling an area that is not required.
6. Controlling the bus controller.
7. Reading the status of the controller.

2.13. DMA Controller Driver

The driver functions support the control of the Direct Memory Access (DMA) controller, providing the following operations.

1. Configuration for use, including
 - Access to all control bits.
 - Automatic interrupt control
2. Disabling DMA channels that are no longer required and enabling low-power mode.
3. Control of a channel.
4. Reading the status and operation registers of a channel.

2.14. External DMA Controller Driver

The driver functions support the control of the external bus Direct Memory Access controller (EXDMAC), providing the following operations.

1. Selecting the pins to be used.
2. Configuration for use, including
 - Access to all control bits.
 - Automatic interrupt control
3. Disabling EXDMAC channels that are no longer required and enabling low-power mode.
4. Control of a channel.
5. Reading the status and operation registers of a channel.

2.15. Data Transfer Controller Driver

The driver functions support the control of the Data Transfer Controller, providing the following operations.

1. Setting the central options.
2. Configuration for use, including support for chain transfers.
3. Disabling the controller.
4. Starting, stopping or modifying the operation of the controller.
5. Reading the status flags and data transfer registers.

2.16. Multi-Function Timer Pulse Unit Driver

The driver functions support the use of the six 16-bit timers, providing the following operations.

1. Selection of the MTU pins for use.
2. Configuration for use, including
 - Access to all control bits.
 - Automatic interrupt control
 - Automatic I/O pin configuration
3. Disabling channels that are no longer required and enabling low-power mode.
4. Control of a timer channel.
5. Control of a timer unit.
6. Reading the status flags and registers of a timer channel.
7. Reading the status flags and registers of a timer unit.

Note: The Clock Generation Circuit must be configured before configuring any timer channel.

2.17. Port Output Enable Driver

The driver functions support the use of the Port Output module, providing the following operations.

1. Configuring the pins for use.
2. Configuring the interrupts and callback functions.
3. Run-time control of outputs, interrupts and flags.
4. Checking the module status.

2.18. Timer Pulse Unit Driver

The driver functions support the use of the twelve 16-bit timers, providing the following operations.

1. I/O pin configuration
2. Configuration for use, including
 - Access to all control bits.
 - Automatic interrupt control
3. Disabling channels that are no longer required and enabling low-power mode.
4. Control of a timer.
5. Control of a unit.
6. Reading the status and registers of a timer.

2.19. Programmable Pulse Generator Driver

The driver functions support the use of the pulse generator, providing the following operations.

1. Configuring the generator for use.
2. Disabling groups of outputs that are no longer required.
3. Control of the generator during run-time.

2.20. 8-bit Timer Driver

The driver functions support the use of the four 8-bit timers, providing the following operations.

1. Selection of the TMR pins for use.
2. Configuring a channel for use, using register values which have been determined elsewhere.
3. Configuring two channels as a 16-bit pair, using register values which have been determined elsewhere.
4. Configuration for as a periodic timer, including
 - Automatic clock setting using frequency or period as an input.
 - Automatic pulse width setting, using pulse width or duty cycle as an input.
 - Automatic interrupt control
5. Configuration for as a one-shot timer, including
 - Automatic clock setting, using pulse width as an input
 - Automatic interrupt control
 - CPU sleep option
 - Automatic support for using two channels as a single 16-bit timer.
6. Disabling channels that are no longer required and enabling low-power mode.
7. Control of a single timer channel.
8. Control of two timer channels when configured as one 16-bit channel.
9. Control of channels in periodic mode, enabling pulse-width modulation (PWM) output.
10. Reading the registers of a single timer channel.
11. Reading the registers of a 16-bit timer channel pair.

Note: The Clock Generation Circuit must be configured before configuring any timer channel.

2.21. Compare Match Timer Driver

The driver functions support the use of the two 16-bit timers, providing the following operations.

1. Configuration for use, including
 - Automatic clock setting using frequency or period as an input.
 - Manual clock setting using register values as inputs.
 - Automatic interrupt control
2. Configuration for use as a one-shot timer.
3. Disabling channels that are no longer required and enabling low-power mode.
4. Control of a timer, including constant register updates, change of frequency.
5. Reading the counter value and status flag.

Note: The Clock Generation Circuit must be configured before configuring any timer channel.

2.22. Real-time Clock Driver

The driver functions support the use of the real-time clock, providing the following operations.

1. Configuring the clock for use, including
 - Count source selection.
 - Alarm configuration.
 - Optional day-of-week calculation.
 - 12 or 24 hour mode selection.
 - Automatic alarm and periodic interrupt control.
 - Setup of capture pins.
2. Disabling the clock.
3. Control of the clock, including
 - Changing the alarm settings.
 - Changing the current date or time.
 - Error adjustment.
4. Reading the clock status flags, current time and date, alarm time and date and any captured times.
5. Reconfigure callback function and priority setting of alarm and periodic interrupts at warm start up.

2.23. Watchdog Timer Driver

The driver functions support the use of the watchdog timer, providing the following operations.

1. Configuring the timer for use, including
 - Clock selection.
 - Time-out period.
 - Window position.
 - Reset or NMI Interrupt selection when timer overflows.
2. Control of the timer, including
 - Counter refresh to prevent timeout.
3. Reading the timer status including counter value.

2.24. Independent Watchdog Timer Driver

The driver functions support the use of the independent watchdog timer, providing the following operations.

1. Configuring the timer for use.
2. Refreshing the timer to prevent the reset operation.
3. Reading the timer status and counter register.

2.25. Serial Communication Interface Driver

The driver functions support the use of the serial communication (SCI) channels providing the following operations.

1. Selection of the SCI pins for use.
2. Configuration for use, including
 - Automatic baud rate clock calculations
 - Automatic interrupt control
 - Automatic I/O pin configuration
 - Supporting the following modes:
 - Asynchronous
 - Multi-Processor
 - Clock Synchronous
 - Smart Card Interface
 - Simple IIC
 - Simple SPI
3. Disabling channels that are no longer required.
4. Transmitting data, with polling or interrupt mode automatically selected.
5. Receiving data, with polling or interrupt mode automatically selected.
6. Transmitting and/or receiving data in SPI mode, with polling or interrupt mode automatically selected.
7. Transmitting data in simple IIC mode, with polling or interrupt mode automatically selected.
8. Receiving data in simple IIC mode, with polling or interrupt mode automatically selected.
9. Transmitting the last byte of data in simple IIC mode.
10. Control the channel operation.
11. Reading the status flags.

Note: The Clock Generation Circuit must be configured before configuring any serial channel.

2.26. I²C Bus Interface Driver

The driver functions support the use of the I²C module, providing the following operations.

1. Configuration for use, including
 - Automatic clock setting using transfer rate as an input.
 - Automatic interrupt control
2. Disabling the module that is no longer required and enabling low-power mode.
3. Transmitting data in Master mode.
4. Receiving data in Master mode.
5. Completing the reception of data in Master mode.
6. Monitoring the bus and handling the reception of data in Slave mode.
7. Transmitting data in Slave mode.
8. Control of the unit, including bus lock-up recovery support.
9. Reading the status of the module.

Note: The Clock Generation Circuit must be configured before configuring the I²C module.

2.27. Serial Peripheral Interface Driver

The driver functions support the use of the SPI channels, providing the following operations.

1. Selection of the SPI pins for use.
2. Configuration for use, including
 - Automatic clock setting using transfer rate as an input.
3. Disabling channels that are no longer required and enabling low-power mode.
4. Configuration of command sequence settings.
5. Managing the transfer of data on the interface, including
 - Automatic interrupt control
 - Automatic DMAC / DTC control.
6. Control of special modes such as loopback.
7. Reading the status of a module.

Note: The Clock Generation Circuit must be configured before configuring any SPI channel.

2.28. IEBus Interface Driver

The driver functions support the use of the IEBus channel, providing the following operations.

1. Selection of the IEBus pins for use.
2. Configuration for use, including
 - Automatic clock setting using the transfer rate as an input.
3. Disabling channels that are no longer required and enabling low-power mode.
4. Sending data as a bus master.
5. Receiving data as a bus master.
6. Monitor the bus and receiving data as a bus slave.
7. Sending data as a bus slave.
8. Control of special modes.
9. Reading the status of the module.

Note: The Clock Generation Circuit must be configured before configuring any IEBus channel.

2.29. CRC Calculator Driver

The driver functions support the CRC calculator, providing the following operations.

1. Configuration for use, including
 - Polynomial selection.
 - Bit order selection.
 - Preparation for a new calculation.
2. Disabling the calculator and enabling low-power mode.
3. Writing data to be used for the calculation.
4. Reading the calculation result.

2.30. 12-bit Analog to Digital Converter Driver

The driver functions support the use of the 12-bit ADC unit, providing the following operations.

1. Configuration for use, including
 - Automatic clock setting using sampling time as an input
 - Automatic interrupt control
 - Sampling time control
2. Disabling the unit when no longer required and enabling low-power mode.
3. Control the ADC unit, including
 - CPU sleep option
4. Reading the conversion results, with support for polling or interrupts.

Note: The Clock Generation Circuit must be configured before configuring the ADC unit.

2.31. 10-bit Analog to Digital Converter Driver

The driver functions support the use of the 10-bit ADC unit, providing the following operations.

1. I/O pin configuration
2. Configuration for use, including
 - Automatic clock setting using sampling time as an input.
 - Automatic interrupt control
3. Disabling units that are no longer required and enabling low-power mode.
4. Control the unit, including
 - CPU sleep option
5. Reading the conversion results of the 10-bit ADC unit, with support for polling or interrupts.

Note: The Clock Generation Circuit must be configured before configuring any 10-bit ADC unit.

2.32. 10-bit Digital to Analog Converter Driver

The driver functions support the use of the DAC module, providing the following operations.

1. Configuring a channel for use, including
 - Data alignment
 - D/A A/D synchronous conversion
2. Disabling channels that are no longer required and enabling low-power mode.
3. Writing data to a channel.

2.33. Temperature Sensor Driver

The driver functions support the use of the Temperature Sensor module, providing the following operations.

1. Configuring and enabling the Temperature Sensor.
2. Disabling the Temperature Sensor and enabling low-power mode.
3. Controlling the A/D conversion.

3. Types and definitions

3.1. Data types

This section describes the data types used in this library. For details about the setting values, refer to the section “4.2 Description of Each API”.

The header files `stdint.h` and `stdbool.h` are included with the Renesas RX compiler.

Table 1: Data types

Type	Defined in	Description	Range
<code>bool</code>	<code>stdbool.h</code>	Boolean	0 (false) to 1 (true)
<code>double</code>	C	Floating point, 64 bits	$\pm\infty$
<code>uint8_t</code>	<code>stdint.h</code>	Unsigned, 8 bits	0 to 255
<code>uint16_t</code>		Unsigned, 16 bits	0 to $2^{15} - 1$
<code>int32_t</code>		Signed, 32 bits	-2^{31} to $2^{31} - 1$
<code>uint32_t</code>		Unsigned, 32 bits	0 to $2^{32} - 1$

3.2. General definitions

3.2.1. PDL_NO_FUNC

Used as a parameter when there is no applicable function.

3.2.2. PDL_NO_PTR

Used as a parameter when there is no applicable data location.

3.2.3. PDL_NO_DATA

Used as a parameter when there is no applicable data value.

3.2.4. PDL_MCU_GROUP

The MCU group supported by this build of the driver library. It is defined as `RX63N`.

A usage example is:

```
#if PDL_MCU_GROUP != RX63N
  #error "Wrong RPDG !"
#endif
```

3.2.5. PDL_VERSION

The version number of the RPDG library. The number is stored in BCD format (xx.xx). For example, 0100h is v1.00.

A usage example is:

```
const uint16_t rpdg_version_number = PDL_VERSION;
```

3.2.6. Bit definitions

The definitions `BIT_n` and `INV_BIT_n`, where `n = 0 to 31`, are available to the user.

4. Library Reference

4.1. API List by Peripheral Function

Table 4.1 lists the Renesas Embedded APIs by peripheral function.

Table 4.1 Renesas Embedded API List

Category	Number	Name	Description
Clock Generation Circuit	1	R_CGC_Set	Configure the clock generation circuit.
	2	R_CGC_Control	Modify the clock generation circuit operation.
	3	R_CGC_GetStatus	Read the status of the clock generation circuit.
Interrupt control unit	1	R_INTC_SetExtInterrupt	Select the external interrupt pins.
	2	R_INTC_CreateExtInterrupt	Configure an external interrupt signal.
	3	R_INTC_CreateSoftwareInterrupt	Enable use of the software interrupt.
	4	R_INTC_CreateFastInterrupt	Assign handlers for the fixed-vector interrupts.
	5	R_INTC_CreateExceptionHandler	Enable faster interrupt processing for one interrupt.
	6	R_INTC_ControlExtInterrupt	External interrupt control.
	7	R_INTC_GetExtInterruptStatus	Read the external interrupt status.
	8	R_INTC_Read	Read an interrupt register.
	9	R_INTC_Write	Update an interrupt register.
	10	R_INTC_Modify	Modify an interrupt register.
	11	R_INTC_CreateGroup	Configure an interrupt source group.
	12	R_INTC_ControlGroup	Control an interrupt source group.
	13	R_INTC_GetStatusGroup	Read the status of an interrupt source group.
	14	R_INTC_Control	Control the operation of the interrupt controller.
I/O port	1	R_IO_PORT_Set	Configure an I/O port.
	2	R_IO_PORT_ReadControl	Read an I/O port's control registers.
	3	R_IO_PORT_ModifyControl	Modify an I/O port's control registers.
	4	R_IO_PORT_Read	Read data from an I/O port.
	5	R_IO_PORT_Write	Write data to an I/O port.
	6	R_IO_PORT_Compare	Check the pin states on an I/O port.
	7	R_IO_PORT_Modify	Modify the pin states on an I/O port.
	8	R_IO_PORT_Wait	Wait for a match on an I/O port.
	9	R_IO_PORT_NotAvailable	Configure I/O port pins that are not available.
	10	R_IO_PORT_Switch	Modify an I/O port's switch registers
Multifunction Pin Controller	1	R_MPC_Read	Read a PFC register.
	2	R_MPC_Write	Write to a PFC register.
	3	R_MPC_Modify	Modify a PFC register.
MCU operation	1	R_MCU_Control	Control the operation of the MCU.
	2	R_MCU_GetStatus	Read the MCU status.
	3	R_MCU_OFS	Configure the device start-up operation.
Voltage Detection Circuit	1	R_LVD_Create	Configure the voltage detection circuit.
	2	R_LVD_Control	Control the voltage detection circuit.
	3	R_LVD_GetStatus	Check the status of the voltage detection module.
Frequency Measurement Circuit	1	R_MCK_Control	Configure the frequency measurement circuit.
Low Power Consumption	1	R_LPC_Create	Configure the MCU low power conditions.
	2	R_LPC_Control	Select a low power consumption mode.
	3	R_LPC_WriteBackup	Write to the Backup registers.
	4	R_LPC_ReadBackup	Read from the Backup registers.
	5	R_LPC_GetStatus	Read the status flags.
Register Write Protection	1	R_RWP_Control	Control register write protection.
	2	R_RWP_GetStatus	Get the status of the register protection.

Bus Controller	1	R_BSC_Set	Configure the internal bus operation.
	2	R_BSC_Create	Configure the external bus controller.
	3	R_BSC_CreateArea	Configure an external bus area.
	4	R_BSC_Destroy	Stop the Bus Controller.
	5	R_BSC_Control	Modify the External Bus Controller operation.
	6	R_BSC_SDRAM_CreateArea	Configure the SDRAM area.
	7	R_BSC_GetStatus	Read the External Bus Controller status flags.
DMA Controller	1	R_DMAMAC_Create	Configure the DMA controller.
	2	R_DMAMAC_Destroy	Disable a DMA channel.
	3	R_DMAMAC_Control	Control the DMA controller.
	4	R_DMAMAC_GetStatus	Check the status of the DMA channel.
External DMA Controller	1	R_EXDMAC_Set	Configure the EXDMAC pins.
	2	R_EXDMAC_Create	Configure the EXDMA controller.
	3	R_EXDMAC_Destroy	Disable the EXDMA controller.
	4	R_EXDMAC_Control	Control the EXDMA controller.
	5	R_EXDMAC_GetStatus	Check the status of an EXDMAC channel.
Data Transfer Controller	1	R_DTC_Set	Set the Data Transfer Controller options.
	2	R_DTC_Create	Configure the DTC for a transfer.
	3	R_DTC_Destroy	Shutdown the Data Transfer Controller.
	4	R_DTC_Control	Control the Data Transfer Controller.
	5	R_DTC_GetStatus	Check the status of the Data Transfer Controller.
Multi-function Timer pulse unit	1	R_MTU2_Set	Configure the Multi-function Timer Pulse Units.
	2	R_MTU2_Create	Configure a MTU channel.
	3	R_MTU2_Destroy	Disable a Multi-function Timer Pulse Unit.
	4	R_MTU2_ControlChannel	Control an MTU channel.
	5	R_MTU2_ControlUnit	Control a Multi-function Timer Pulse Unit.
	6	R_MTU2_ReadChannel	Read from MTU channel registers.
	7	R_MTU2_ReadUnit	Read from MTU registers.
Port Output Enable	1	R_POE_Set	Configure the Port Output Enable module.
	2	R_POE_Create	Configure the Port Output Enable event handling.
	3	R_POE_Control	Control the Port Output Enable module.
	4	R_POE_GetStatus	Check the status of the Port Output Enable module.
16-bit Timer Pulse Unit	1	R_TPU_Set	Configure the Timer Pulse Unit pins.
	2	R_TPU_Create	Configure a Timer Pulse Unit channel.
	3	R_TPU_Destroy	Disable a timer unit.
	4	R_TPU_ControlChannel	Control a timer channel.
	5	R_TPU_ControlUnit	Control a timer unit.
	6	R_TPU_Read	Read from timer channel registers.
Programmable Pulse Generator	1	R_PPG_Create	Configure a PPG group
	2	R_PPG_Destroy	Disable PPG outputs.
	3	R_PPG_Control	Control a PPG group.
8-bit Timer	1	R_TMR_Set	Configure the optional TMR pins.
	2	R_TMR_CreateChannel	Configure a TMR timer channel.
	3	R_TMR_CreateUnit	Configure a TMR timer unit.
	4	R_TMR_CreatePeriodic	Select periodic operation.
	5	R_TMR_CreateOneShot	Configure and use a one-shot timer.
	6	R_TMR_Destroy	Disable a TMR timer unit.
	7	R_TMR_ControlChannel	Write to timer channel registers.
	8	R_TMR_ControlUnit	Write to timer unit registers.
	9	R_TMR_ControlPeriodic	Control periodic operation.
	10	R_TMR_ReadChannel	Read from timer channel registers.
	11	R_TMR_ReadUnit	Read from timer unit registers.
Compare Match Timer	1	R_CMT_Create	Configure a CMT channel.
	2	R_CMT_CreateOneShot	Configure a CMT channel as a one-shot event.
	3	R_CMT_Destroy	Disable a CMT unit.
	4	R_CMT_Control	Control CMT operation.
	5	R_CMT_Read	Read CMT channel status and registers.

Real-time Clock	1	R_RTC_Create	Configure the Real-time clock.
	2	R_RTC_Destroy	Shut down the Real-time clock.
	3	R_RTC_Control	Modify the Real-time clock operation.
	4	R_RTC_Read	Read the Real-time clock status flags and counters.
	5	R_RTC_CreateWarm	Reconfigure RTC interrupt setting at warm start up.
Watchdog Timer	1	R_WDT_Set	Configure the Watchdog timer operation.
	2	R_WDT_Control	Control the Watchdog operation.
	3	R_WDT_Read	Read the Watchdog timer status and registers.
Independent Watchdog Timer	1	R_IWDT_Set	Configure the Independent Watchdog operation.
	2	R_IWDT_Control	Control the Independent Watchdog operation.
	3	R_IWDT_Read	Read the watchdog timer status and counter.
Serial Communication Interface	1	R_SCI_Set	Configure the SCI pin selection.
	2	R_SCI_Create	SCI channel setup.
	3	R_SCI_Destroy	Shut down a SCI channel.
	4	R_SCI_Send	Send a string of characters.
	5	R_SCI_Receive	Receive a string of characters.
	6	R_SCI_SPI_Transfer	Perform an SCI SPI transfer.
	7	R_SCI_IIC_Write	Perform an SCI IIC master write.
	8	R_SCI_IIC_Read	Perform an SCI IIC master read.
	9	R_SCI_IIC_ReadLastByte	Finish an SCI master read if using DMAC or DTC.
	10	R_SCI_Control	Control the SCI channel.
	11	R_SCI_GetStatus	Check the status of an SCI channel.
I ² C bus interface	1	R_IIC_Create	I ² C channel setup.
	2	R_IIC_Destroy	Disable an I ² C channel.
	3	R_IIC_MasterSend	Write data to a slave device.
	4	R_IIC_MasterReceive	Read data from a slave device.
	5	R_IIC_MasterReceiveLast	Complete a DMAC or DTC-based read process.
	6	R_IIC_SlaveMonitor	Monitor the bus and receive data from a master.
	7	R_IIC_SlaveSend	Write data to a master device.
	8	R_IIC_Control	I ² C channel control.
	9	R_IIC_GetStatus	Read the status for an I ² C channel.
Serial Peripheral Interface	1	R_SPI_Set	Configure the SPI pin selection.
	2	R_SPI_Create	Configure an SPI channel.
	3	R_SPI_Destroy	Shutdown an SPI channel.
	4	R_SPI_Command	Configure an SPI command.
	5	R_SPI_Transfer	Transfer data over an SPI channel.
	6	R_SPI_Control	Control an SPI channel.
	7	R_SPI_GetStatus	Check the status of an SPI channel.
IEBus Controller	1	R_IEB_Set	Configure the IEBus pin selection.
	2	R_IEB_Create	Configure the IEBus channel.
	3	R_IEB_Destroy	Shutdown an IEBus channel.
	4	R_IEB_MasterSend	Transmit data over an IEBus channel.
	5	R_IEB_MasterReceive	Receive data over an IEBus channel.
	6	R_IEB_SlaveMonitor	Monitor the IEBus.
	7	R_IEB_SlaveWrite	Prepare data for sending to a master unit.
	8	R_IEB_Control	Change the IEBus channel configuration.
	9	R_IEB_GetStatus	Check the status of an IEBus channel.
CRC calculator	1	R_CRC_Create	Configure the CRC calculator.
	2	R_CRC_Destroy	Shut down the CRC calculator.
	3	R_CRC_Write	Write data into the CRC calculation register.
	4	R_CRC_Read	Read the CRC calculation result.
12-bit Analog to Digital converter	1	R_ADC_12_Create	Configure the 12-bit ADC unit.
	2	R_ADC_12_Destroy	Shut down the ADC unit.
	3	R_ADC_12_Control	Start or stop the ADC unit.
	4	R_ADC_12_Read	Read the ADC conversion results.
10-bit Analog to Digital converter	1	R_ADC_10_Set	Select the I/O pins for 10-bit ADC.
	2	R_ADC_10_Create	Configure a 10-bit ADC unit.
	3	R_ADC_10_Destroy	Shut down an ADC unit.
	4	R_ADC_10_Control	Start or stop an ADC unit.
	5	R_ADC_10_Read	Read the ADC conversion results.

10-bit Digital to Analog converter	1	R_DAC_10_Create	Configure the 10-bit DAC module.
	2	R_DAC_10_Destroy	Disable a DAC channel.
	3	R_DAC_10_Write	Write data to a DAC channel.
Temperature sensor	1	R_TS_Create	Configure the Temperature Sensor.
	2	R_TS_Destroy	Shut down the Temperature Sensor.
	3	R_TS_Control	Control the Temperature Sensor operation.

4.2. Description of Each API

This section describes each API and explains how to use them, showing a program example for each. The description of each API is divided into the following items.

Synopsis	Summarises processing by the API function.
Prototype	The function format and a brief explanation of the arguments.
Description	Explains how to use the API function and shows assignable parameters separating each argument with [argument] .
Return value	Describes the returned value of the API function.
Category	Indicates the category of the API function.
Reference	Indicates the API functions to be referred.
Remark	Describes notes to use the API function.
Program example	Represents how to use the API function by a program example. Two examples of return value checking are shown below.

```

/* RPD_L definitions */
#include "r_pdl_mpc.h"
#include "r_pdl_sci.h"

/* RPD_L device-specific definitions */
#include "r_pdl_definitions.h"

void func( void )
{
    bool result;

    /* Write 0xFF to register MPC1 */
    result = R_MPC_Write(
        1,
        0xFF
    );
    if (result == false)
    {
        /* Handle the error here */
    }

    /* Keep trying to send a string (if the channel is busy) */
    do
    {
        result = R_SCI_Send(
            2,
            "Renesas RX",
            NULL,
            PDL_NO_FUNC
        );
    } while (result == false);
}

```

For clarity, the return value is not checked in the examples used in this manual.

The RPD_L API is implemented using function macros. To avoid the possibility of parameters being evaluated more than once do not use operators or function calls within the RPD_L API parameter list.

4.2.1. Clock Generation Circuit

1) R_CGC_Set

Synopsis

Configure the clock generation circuit.

Prototype

```
bool R_CGC_Set(
    uint8_t data1, // Clock selection
    uint32_t data2, // Configuration options
    double data3, // Clock frequency
    double data4, // System clock frequency
    double data5, // Peripheral module clock A frequency
    double data6, // Peripheral module clock B frequency
    double data7, // Flash interface clock frequency
    double data8, // External bus clock frequency
    double data9, // IEBus clock frequency
    double data10, // USB clock frequency
    uint16_t data11 // Sub-clock stabilization time
);
```

Description (1/2)

Set a clock source frequencies and options.

[data1]

Clock source selection.

- Clock source selection

PDL_CGC_CLK_LOCO or PDL_CGC_CLK_HOCO or PDL_CGC_CLK_MAIN or PDL_CGC_CLK_SUB_CLOCK or PDL_CGC_CLK_PLL or PDL_CGC_CLK_IWDTLOCO	Select the low-speed on-chip oscillator (LOCO), high-speed on-chip oscillator (HOCO), main clock oscillator, sub-clock oscillator, Phase-locked loop (PLL) circuit or IWDT-dedicated low-speed clock on-chip oscillator (IWDTLOCO).
---	---

[data2]

Configuration settings.

- BCLK signal control (ignored for 64 and 48 pin packages)

PDL_CGC_BCLK_DIV_1 or PDL_CGC_BCLK_DIV_2 or PDL_CGC_BCLK_DISABLE	Select the BCLK or BCLK ÷ 2 signal to be output or disable the BCLK signal.
--	---

- SDCLK signal control (ignored for 100, 64 and 48 pin packages)

PDL_CGC_SDCLK_ENABLE or PDL_CGC_SDCLK_DISABLE	Allow the SDRAM clock (SDCLK) signal to be output on the SDCLK pin, or leave the SDCLK pin as an I/O port.
--	--

- RTC Count source selection (select only once when power on)

PDL_CGC_RTC_SRC_SUB or PDL_CGC_RTC_SRC_MAIN or PDL_CGC_RTC_SRC_NONE	RTC source is sub-clock RTC source is main clock RTC source is not used
--	---

- Sub-clock oscillator drive ability (select only once when power on)

The standard load capacitance is for the case the sub-clock resonator is not fitted.

PDL_CGC_SUB_CLOCK_CL_LOW or PDL_CGC_SUB_CLOCK_CL_STANDARD	Adjust the drive level for a crystal with low or standard load capacitance.
---	---

[data3]

The frequency of the selected clock source, in Hertz.

[data4]

The desired frequency of the System clock (ICLK), in Hertz.

Description (2/2)

[data5]

The desired frequency of the Peripheral module A clock (PCLKA), in Hertz.

[data6]

The desired frequency of the Peripheral module B clock (PCLKB), in Hertz.

[data7]

The desired frequency of the Flash memory interface clock (FCLK), in Hertz.

[data8]

The desired frequency of the External Bus clock (BCLK) and SDRAM clock (SDCLK), in Hertz. If the external bus will not be used, specify PDL_NO_DATA.

[data9]

The desired frequency of the IEBus clock (IECLK), in Hertz. If the IEBus will not be used, specify PDL_NO_DATA.

[data10]

The desired frequency of the USB clock (UCLK), in Hertz. If the USB will not be used, specify PDL_NO_DATA.

[data11]

Select the sub-clock oscillator stabilization times. If no selections are required, specify PDL_NO_DATA.

- Sub-clock oscillator waiting time. Compulsory option if PDL_CGC_CLK_SUB_CLOCK is selected.

Make sure to set the option whether Sub-clock is used or not based on the actual board situation

PDL_CGC_SUB_2 or PDL_CGC_SUB_4 or PDL_CGC_SUB_8 or PDL_CGC_SUB_16 or PDL_CGC_SUB_32 or PDL_CGC_SUB_64 or PDL_CGC_SUB_512 or PDL_CGC_SUB_1024 or PDL_CGC_SUB_2048 or PDL_CGC_SUB_4096 or PDL_CGC_SUB_16384 or PDL_CGC_SUB_32768 or PDL_CGC_SUB_65536 or PDL_CGC_SUB_131072 or PDL_CGC_SUB_262144 or PDL_CGC_SUB_524288	Select the oscillation settling time of the sub clock oscillator
--	--

Return value

True if all parameters are valid and exclusive; otherwise false.

For RX63N, the following rules shall be checked:

- $f_{\text{MAIN_CLOCK_OSCILLATOR}} \leq 20$ MHz (between 4 and 16 MHz if a resonator is used).
- $f_{\text{PLL}} = 104$ to 200 MHz
- $f_{\text{ICLK}} \leq 100$ MHz
- $f_{\text{PCLKA}} \leq 100$ MHz
- $f_{\text{PCLKB}} \leq 50$ MHz
- $f_{\text{FCLK}} \leq 50$ MHz
- $f_{\text{BCLK}} \leq 100$ MHz for 177, 176, 145 and 144 pin packages
- $f_{\text{BCLK}} \leq 50$ MHz for 100, 64 and 48 pin packages
- $f_{\text{BCLK_PIN}} \leq 50$ MHz for 177, 176, 145 and 144 pin packages
- $f_{\text{BCLK_PIN}} \leq 25$ MHz for 100, 64 and 48 pin packages
- $f_{\text{SDCLK_PIN}} \leq 50$ MHz
- $f_{\text{BCLK}} \leq f_{\text{ICLK}}$
- $f_{\text{IEBus_CLOCK}} \leq 50$ MHz
- $f_{\text{USB_CLOCK}} = 48$ MHz
- $f_{\text{HOCO_CLOCK}} = 50$ MHz
- The frequency of the PLL is achievable: (main clock) x 8, 10, 12, 16, 20, 24, 25 or 50.
- The frequencies of the internal clocks (ICLK, PCLKA, PCLKB, FCLK and BCLK) are achievable: (selected clock source) ÷ 1, 2, 4, 8, 16, 32 or 64.
- The frequency of the IEBus clock (IECLK) is achievable: (selected clock source) ÷ 2, 4, 6, 8, 16, 32 or 64.
- The frequency of the USB clock (UCLK) is achievable: (selected clock source) ÷ 3 or 4.

Category

Clock generation circuit

References

R_CGC_Control, R_MCU_GetStatus, R_LPC_Create, R_BSC_Control

Remarks

- Call this function once to set the clock frequency for each clock source whether it is used as system clock or RTC count source.
- If the current clock source is selected in parameter data1, the frequencies of the internal clocks will be changed by this function.
Because this can not be done if ROM/Flash Program Erase mode is set or if a operating power mode transition is in progress, this function will return false if this is detected.
- If the current clock source is selected in parameter data1, the frequencies of the internal clocks will be changed by this function.
- After a power-on reset, the MCU selects the LOCO as the clock source.
- This function must be called before configuring clock-dependent modules.
- This function will enable the selected clock but will not select it as the current clock source. After the required settling time, use R_CGC_Control to select the desired clock source.
- If the sub-clock oscillator is not fitted, use R_CGC_Control to disable the oscillation circuit.
- The registers MOSCWTCR (main clock), SOSCWTCR (sub-clock) and PLLWTCR (PLL) provide stabilisation delays for the respective oscillator and must be written to while that clock is stopped. If any of these registers needs to be modified, stop the clock (using R_CGC_Control) and call R_LPC_Create to set the new value.
- If the PLL will be used, first use this function to configure the main clock oscillator settings.
- If the PLL will be used, the frequencies of the internal clocks (ICLK, PCLKA, PCLKB, FCLK and BCLK) must be no more than the PLL output clock frequency $\div 2$.
- If the main clock will be used, the frequencies of the internal clocks (ICLK, PCLKB, FCLK, BCLK and IECLK) must be no more than the main clock frequency $\div 4$.
- If the PLL output frequency is to be changed while the PLL is enabled, before calling this function use R_CGC_Control to select another clock source and stop the PLL.
- If the IWDTLOCO is selected, specify PDL_NO_DATA for parameters data2 and data4 to data10.
- The BCLK pin output will not be active until the external bus is enabled (using R_BSC_Control).
- The SDCLK pin output will not be active until the BSC functions are used to configure and enable the SDRAM controller.
- If the HOCO is selected, the HOCO power must not be turned off.
- If the sub-clock will be selected while in low-speed operating mode 2 (see R_LPC_Create), $f_{ICLK(\text{Sub-clock})}$ and $f_{FCLK(\text{Sub-clock})}$ must equal $f_{\text{SUB-CLOCK}}$.
- If low-speed operating mode 1 or 2 is selected, do not call this function to configure the PLL.
- When USB module is used, UCLK must be set to 48MHz.
- If setting the ICLK > 32MHz then high-speed operating mode must be set first. (see R_LPC_Control).
- External bus clock is not available for 64 and 48 pin packages.
- Sub-clock oscillator is not available for 48 pin package.
- Sub-clock oscillator is fixed at standard drive ability for 64 pin package.
- Make sure PCLKB clock frequency \geq RTC count source clock frequency.
- If main clock oscillator is used as RTC count source, main clock and sub-clock cannot be used as system clock.
- When RTC is not to be used, call R_CGC_Control with option PDL_CGC_RTC_NOT_USE after calling this function to configure the RTC count source.

Program example

```

/* RPD definitions */
#include "r_pdl_cgc.h"

/* RPD device-specific definitions */
#include "r_pdl_definitions.h"

void func(void)
{
    /* Configure main clock operation using a 12.0 MHz crystal */
    /* ICLK = 3 MHz, PCLKA = 3 MHz, PCLKB = 3 MHz , FCLK = 3 MHz */
    /* BCLK = IECLK = UCLK = not used, BCLK(pin) not used */
    R_CGC_Set(
        PDL_CGC_CLK_MAIN,
        PDL_CGC_BCLK_DISABLE | PDL_CGC_SDCLK_DISABLE |
PDL_CGC_RTC_SRC_MAIN,
        12E6,
        3E6,
        3E6,
        3E6,
        3E6,
        PDL_NO_DATA,
        PDL_NO_DATA,
        PDL_NO_DATA,
        PDL_NO_DATA
    );

    /* Configure PLL operation. The PLL will be set to 192 MHz */
    /* ICLK = 96 MHz, PCLKA = 96 MHz, PCLKB = 48 MHz, FCLK = 48 MHz */
    /* BCLK = 48 MHz, BCLK(pin) = 48 MHz. IECLK = UCLK = not used */
    R_CGC_Set(
        PDL_CGC_CLK_PLL,
        PDL_CGC_BCLK_DIV_1 | PDL_CGC_SDCLK_ENABLE,
        192E6,
        96E6,
        96E6,
        48E6,
        48E6,
        48E6,
        PDL_NO_DATA,
        PDL_NO_DATA,
        PDL_NO_DATA
    );
}

```

2) R_CGC_Control

Synopsis Modify the clock generation circuit operation.

Prototype

```
bool R_CGC_Control(
    uint8_t data1, // Clock selection
    uint32_t data2, // Clock control options
    uint8_t data3 // Clock control options
);
```

Description (1/2) Modify the clock control registers.

[data1]
Clock source selection. If no change is required, specify PDL_NO_DATA.

- Clock source selection

PDL_CGC_CLK_LOCO or PDL_CGC_CLK_HOCO or PDL_CGC_CLK_MAIN or PDL_CGC_CLK_SUB_CLOCK or PDL_CGC_CLK_PLL	Select the low-speed on-chip oscillator (LOCO), high-speed on-chip oscillator (HOCO), main clock oscillator, sub-clock oscillator, Phase-locked loop (PLL) circuit.
--	---

[data2]
Clock control selection.
All selections are optional. If no change is required, specify PDL_NO_DATA.
If multiple selections are required, use “|” to separate each selection.

- BCLK pin output control (ignored if the device package does not support the external bus)

PDL_CGC_BCLK_ENABLE or PDL_CGC_BCLK_DISABLE	Enable or disable the BCLK pin output.
--	--
- Low-speed on-chip oscillator control

PDL_CGC_LOCO_ENABLE or PDL_CGC_LOCO_DISABLE	Enable or disable the LOCO.
--	-----------------------------
- High-speed on-chip oscillator control

PDL_CGC_HOCO_ENABLE or PDL_CGC_HOCO_DISABLE	Enable or disable the HOCO.
--	-----------------------------
- High-speed on-chip oscillator power control

PDL_CGC_HOCO_POWER_ON or PDL_CGC_HOCO_POWER_OFF	Control the HOCO power supply.
--	--------------------------------
- Main clock oscillator control

PDL_CGC_MAIN_ENABLE or PDL_CGC_MAIN_DISABLE	Enable or disable the main clock oscillator.
--	--
- Main clock oscillator forced oscillation control

PDL_CGC_MAIN_FORCED_ENABLE or PDL_CGC_MAIN_FORCED_DISABLE	Enable or disable forced oscillation of the main clock oscillator.
--	--
- Main clock Oscillation Stop Detection control

PDL_CGC_OSC_STOP_ENABLE or PDL_CGC_OSC_STOP_INTERRUPT or PDL_CGC_OSC_STOP_DISABLE	Enable (without or with interrupt request output) or disable the oscillation stop detection function for the main clock oscillator.
---	---
- Main clock Oscillation Stop Detection flag control

PDL_CGC_OSC_STOP_CLEAR_FLAG	Clear the main clock oscillation stop detection flag.
-----------------------------	---
- SDCLK signal control (ignored for 100, 64 and 48 pin packages)

PDL_CGC_SDCLK_ENABLE or PDL_CGC_SDCLK_DISABLE	Enable or disable the SDRAM clock (SDCLK) signal.
--	---

Description (2/2)	<p>[data3] Clock control selection. All selections are optional. If no change is required, specify PDL_NO_DATA. If multiple selections are required, use “ ” to separate each selection.</p> <ul style="list-style-type: none"> Sub-clock oscillator control. (ignore for 48 pin package) <table border="1" style="width: 100%;"> <tr> <td style="width: 60%;">PDL_CGC_SUB_CLOCK_ENABLE or PDL_CGC_SUB_CLOCK_DISABLE</td> <td>Enable or disable the sub-clock oscillator.</td> </tr> </table> <ul style="list-style-type: none"> PLL control <table border="1" style="width: 100%;"> <tr> <td style="width: 60%;">PDL_CGC_PLL_ENABLE or PDL_CGC_PLL_DISABLE</td> <td>Enable or disable the PLL circuit.</td> </tr> </table> <ul style="list-style-type: none"> IWDT-dedicated low-speed on-chip oscillator control <table border="1" style="width: 100%;"> <tr> <td style="width: 60%;">PDL_CGC_IWDTLOCO_ENABLE or PDL_CGC_IWDTLOCO_DISABLE</td> <td>Enable or disable the IWDTLOCO.</td> </tr> </table> <ul style="list-style-type: none"> RTC initialization control <table border="1" style="width: 100%;"> <tr> <td style="width: 60%;">PDL_CGC_RTC_TO_BE_USED or PDL_CGC_RTC_NOT_USE</td> <td>Select whether RTC will be used.</td> </tr> </table>	PDL_CGC_SUB_CLOCK_ENABLE or PDL_CGC_SUB_CLOCK_DISABLE	Enable or disable the sub-clock oscillator.	PDL_CGC_PLL_ENABLE or PDL_CGC_PLL_DISABLE	Enable or disable the PLL circuit.	PDL_CGC_IWDTLOCO_ENABLE or PDL_CGC_IWDTLOCO_DISABLE	Enable or disable the IWDTLOCO.	PDL_CGC_RTC_TO_BE_USED or PDL_CGC_RTC_NOT_USE	Select whether RTC will be used.
PDL_CGC_SUB_CLOCK_ENABLE or PDL_CGC_SUB_CLOCK_DISABLE	Enable or disable the sub-clock oscillator.								
PDL_CGC_PLL_ENABLE or PDL_CGC_PLL_DISABLE	Enable or disable the PLL circuit.								
PDL_CGC_IWDTLOCO_ENABLE or PDL_CGC_IWDTLOCO_DISABLE	Enable or disable the IWDTLOCO.								
PDL_CGC_RTC_TO_BE_USED or PDL_CGC_RTC_NOT_USE	Select whether RTC will be used.								
Return value	True if all parameters are valid and exclusive and a selected clock source has been configured; otherwise false.								
Category	Clock generation circuit								
References	R_CGC_Set, R_LPC_GetStatus, R_LPC_Create								
Remarks	<ul style="list-style-type: none"> Use R_CGC_Set to configure a clock source before calling this function. While the main clock Oscillation Stop Detection feature is enabled, the LOCO is started and cannot be stopped. Clearing the main clock Oscillation Stop Detection flag will not succeed until a clock source other than the main oscillator or PLL circuit is selected (using parameter data1). If the main clock Oscillation Stop Detection flag is cleared, the interrupt output is also disabled. Use this function to re-enable the interrupt output after the main clock oscillation has been restored. Do not stop a clock that is in use. Do not change the clock source if an Operating Power Control Mode transition is taking place (see R_LPC_GetStatus). If low-speed operating mode 2 is selected (see R_LPC_Create), disable the HOCO. If middle-speed operating modes 1 or 2 are selected (see R_LPC_Create), do not change the HOCO power state. If low-speed operating mode 1 or 2 is selected, do not enable the PLL. If the main clock oscillator pins will be used as general I/O, call this function with PDL_CGC_MAIN_DISABLE and PDL_CGC_MAIN_FORCED_DISABLE selected in parameter data2. If this function is used to enable a clock oscillator, wait for the required settling time before selecting the clock source. Sub-clock oscillator is not available for 48 pin package. External bus clock is not available for 64 and 48 pin packages. Sub-clock oscillator is fixed at standard drive ability for 64 pin package. This function can not be used if ROM/Flash Program Erase mode is set or if an operating power mode transition is in progress. This function will return false if this is detected. If main clock oscillator is used as RTC count source, main clock and sub-clock cannot be used as system clock (see R_CGC_Set). Make sure PCLKB clock frequency ≥ RTC count source clock frequency. If main clock oscillator is used as RTC count source, main clock and sub-clock cannot be used as system clock (see R_CGC_Set). The forced oscillation of the main clock oscillator will be automatically enabled when main clock as RTC count source and PDL_CGC_RTC_TO_BE_USED is selected in parameter data3. Do not use option PDL_CGC_MAIN_FORCED_DISABLE or PDL_CGC_MAIN_DISABLE when main clock as RTC count source and PDL_CGC_RTC_TO_BE_USED is selected in parameter data3. Calling R_RTC_Create after using option PDL_CGC_RTC_TO_BE_USED 								

Program example

```
/* RPDL definitions */
#include "r_pdl_cgc.h"

/* RPDL device-specific definitions */
#include "r_pdl_definitions.h"

void func(void)
{
    /* Stop the sub-clock oscillator */
    R_CGC_Control(
        PDL_NO_DATA,
        PDL_NO_DATA,
        PDL_CGC_SUB_CLOCK_DISABLE | PDL_CGC_RTC_NOT_USE
    );

    /* Select the PLL */
    R_CGC_Control(
        PDL_CGC_CLK_PLL,
        PDL_NO_DATA,
        PDL_NO_DATA
    );
}
```

3) R_CGC_GetStatus

Synopsis Read the status of the clock generation circuit.

Prototype `bool R_CGC_GetStatus(uint16_t * data // Pointer to the variable where the status value shall be stored.);`

Description Read the clock status register.

[data]
The status flags shall be stored in the format below.

b15	b14	b13	b12	b11	b10	b9	b8
0	HOCO power	Clock control					
		HOCO	IWDTLOCO	LOCO	Sub-clock	Main clock	PLL
	0: Power on 1: Power off	0: Operating 1: Stopped					

b7	b6 - b4	b3 - b2	b1	b0	
0	Selected clock source		Main clock oscillation stop detection		
	000b: LOCO 001b: HOCO 010b: Main clock 011b: Sub-clock 100b: PLL		0	0: Disabled 1: Enabled	0: Normal operation 1: Stop detected

Return value True.

Category Clock generation circuit

References R_CGC_Control

Remarks • Use R_CGC_Control to clear the main clock oscillation stop detection flag.

Program example

```

/* RPDL definitions */
#include "r_pdl_cgc.h"

/* RPDL device-specific definitions */
#include "r_pdl_definitions.h"

void func(void)
{
    uint16_t Status_flags;

    R_CGC_GetStatus(
        &Status_flags
    );
}
    
```

4.2.2. Interrupt Control Unit

1) R_INTC_SetExtInterrupt

Synopsis

Select the external interrupt pins.

Prototype

```
bool R_INTC_SetExtInterrupt(
    uint32_t data1, // Pin selection
    uint32_t data2 // Pin selection
);
```

Description (1/2)

Assign the external interrupt pins.

[data1]

Allocate the pins for signals IRQ0 to IRQ7. All selections are optional. If multiple selections are required, use “|” to separate each selection. If no pins are required, specify PDL_NO_DATA.

PDL_INTC_IRQ0_P30 or PDL_INTC_IRQ0_P10 or PDL_INTC_IRQ0_PD0	Select the pins to be used for signals IRQ0 to IRQ7.
PDL_INTC_IRQ1_P31 or PDL_INTC_IRQ1_P11 or PDL_INTC_IRQ1_PD1	
PDL_INTC_IRQ2_P32 or PDL_INTC_IRQ2_P12 or PDL_INTC_IRQ2_PD2	
PDL_INTC_IRQ3_P33 or PDL_INTC_IRQ3_P13 or PDL_INTC_IRQ3_PD3	
PDL_INTC_IRQ4_PB1 or PDL_INTC_IRQ4_P14 or PDL_INTC_IRQ4_P34 or PDL_INTC_IRQ4_PD4 or PDL_INTC_IRQ4_PF5	
PDL_INTC_IRQ5_PA4 or PDL_INTC_IRQ5_P15 or PDL_INTC_IRQ5_PD5 or PDL_INTC_IRQ5_PE5	
PDL_INTC_IRQ6_PA3 or PDL_INTC_IRQ6_P16 or PDL_INTC_IRQ6_PD6 or PDL_INTC_IRQ6_PE6	
PDL_INTC_IRQ7_PE2 or PDL_INTC_IRQ7_P17 or PDL_INTC_IRQ7_PD7 or PDL_INTC_IRQ7_PE7	

Description (2/2)

[data2]

Allocate the pins for signals IRQ8 to IRQ15. All selections are optional. If multiple selections are required, use “|” to separate each selection. If no pins are required, specify PDL_NO_DATA.

PDL_INTC_IRQ8_P40 or PDL_INTC_IRQ8_P00 or PDL_INTC_IRQ8_P20	Select the pins to be used for signals IRQ8 to IRQ15.
PDL_INTC_IRQ9_P41 or PDL_INTC_IRQ9_P01 or PDL_INTC_IRQ9_P21	
PDL_INTC_IRQ10_P42 or PDL_INTC_IRQ10_P02 or PDL_INTC_IRQ10_P55	
PDL_INTC_IRQ11_P43 or PDL_INTC_IRQ11_P03 or PDL_INTC_IRQ11_PA1	
PDL_INTC_IRQ12_P44 or PDL_INTC_IRQ12_PB0 or PDL_INTC_IRQ12_PC1	
PDL_INTC_IRQ13_P45 or PDL_INTC_IRQ13_P05 or PDL_INTC_IRQ13_PC6	
PDL_INTC_IRQ14_P46 or PDL_INTC_IRQ14_PC0 or PDL_INTC_IRQ14_PC7	
PDL_INTC_IRQ15_P47 or PDL_INTC_IRQ15_P07 or PDL_INTC_IRQ15_P67	

Return value

True if all parameters are valid and exclusive; otherwise false.

Category

Interrupt control

References

R_INTC_CreateExtInterrupt

Remarks

- Before calling R_INTC_CreateExtInterrupt, call this function to select the required pins.
- The Multifunction Pin Control registers are modified to enable each selected IRQ pin and the I/O Port PMR and PDR registers are modified to set the pin as an input.
- A pin can be used both as an interrupt input and a peripheral or general purpose input or output (apart from an analog input). If the dual operation is required, call this function before configuring the peripheral or I/O port operation.
- Some pin options are not available on smaller device packages.
- Some IRQ pins (labelled in the hardware manual with the suffix –DS) can also be used to exit from Deep Software Standby mode. Please refer to the Low Power Consumption section for details.

Program example

```

/* RPDL definitions */
#include "r_pdl_intc.h"

/* RPDL device-specific definitions */
#include "r_pdl_definitions.h"

void func(void)
{
    /* Select P30 for IRQ0, P31 for IRQ1 and P42 for IRQ10 */
    R_INTC_SetExtInterrupt(
        PDL_INTC_IRQ0_P30 | PDL_INTC_IRQ1_P31,
        PDL_INTC_IRQ10_P42
    );
}

```

2) R_INTC_CreateExtInterrupt

Synopsis

Configure an external interrupt signal.

Prototype

```
bool R_INTC_CreateExtInterrupt(
    uint8_t data1, // Signal selection
    uint32_t data2, // Configuration
    void * func, // Callback function
    uint8_t data3 // Interrupt priority level
);
```

Description (1/2)

Sets the specified interrupt detection and control.

[data1]

Choose the interrupt signal to be configured.

PDL_INTC_IRQn (n = 0 to 15) or PDL_INTC_NMI	IRQn (n = 0 to 15) interrupt pin or NMI.
--	---

[data2]

Choose the settings. If multiple selections are required, use "[" to separate each selection. The default settings are shown in **bold**.

- Digital filter selection

PDL_INTC_FILTER_DISABLE or PDL_INTC_FILTER_DIV_1 or PDL_INTC_FILTER_DIV_8 or PDL_INTC_FILTER_DIV_32 or PDL_INTC_FILTER_DIV_64	The interrupt pin input can be unfiltered or sampled using the peripheral clock PCLKB divided by 1, 8, 32 or 64. For the NMI signal, this selection is ignored if the NMI pin is not enabled.
--	--

Options which only apply to the IRQ pins

- Input sense selection

PDL_INTC_LOW or PDL_INTC_FALLING or PDL_INTC_RISING or PDL_INTC_BOTH	Select Low level, Falling edge, Rising edge or Falling and rising edge detection.
---	--

- DMAC / DTC trigger control. Not enabled if low-level detection is selected.

PDL_INTC_DMDC DTC_TRIGGER_DISABLE or PDL_INTC_DMDC_TRIGGER_ENABLE or PDL_INTC_DTC_TRIGGER_ENABLE	Disable or enable activation of the DMAC or DTC when a valid edge transition is detected on a valid IRQn pin.
---	---

Options which only apply to the NMI

- Pin enable and input sense selection

PDL_INTC_FALLING or PDL_INTC_RISING	Enable the NMI pin and select falling or rising edge detection. Required only if the NMI pin is to be used.
--	---

- Internal detection control

PDL_INTC_OSD_DISABLE or PDL_INTC_OSD_ENABLE	Disable or enable the NMI signal when the oscillation stop detection interrupt occurs.
PDL_INTC_WDT_DISABLE or PDL_INTC_WDT_ENABLE	Disable or enable the NMI signal when a WDT underflow interrupt occurs.
PDL_INTC_IWDT_DISABLE or PDL_INTC_IWDT_ENABLE	Disable or enable the NMI signal when an IWDT underflow interrupt occurs.
PDL_INTC_LVD1_DISABLE or PDL_INTC_LVD1_ENABLE	Disable or enable the NMI signal when a low-voltage detection 1 interrupt occurs.
PDL_INTC_LVD2_DISABLE or PDL_INTC_LVD2_ENABLE	Disable or enable the NMI signal when a low-voltage detection 2 interrupt occurs.

Description (2/2)	<p>[func] The function to be called when a valid condition is detected. Specify PDL_NO_FUNC if no IRQn interrupt is required. A function must be specified for the NMI.</p> <p>[data3] The IRQn interrupt priority level. Select between 1 (lowest priority) and 15 (highest priority). This parameter will be ignored if PDL_NO_FUNC is specified for parameter func. This value does not apply to the NMI and is ignored.</p>
Return value	True if all parameters are valid and exclusive; otherwise false.
Category	Interrupt control
Reference	R_INTC_SetExtInterrupt
Remarks	<ul style="list-style-type: none"> • Function R_INTC_SetExtInterrupt must be called before any use of this function. • The selected interrupt is enabled automatically. • Please see the notes on callback function use in §6. • The NMI callback function should not return. It should stop operation or reset the system. • If the NMI interrupt fails to initialise, this function will return false.

Program example

```

/* RPDL definitions */
#include "r_pdl_intc.h"

/* RPDL device-specific definitions */
#include "r_pdl_definitions.h"

/* Callback function */
void CallBackFunc( void ){}

void func( void )
{
    /* Configure the IRQ1 interrupt */
    R_INTC_CreateExtInterrupt(
        PDL_INTC_IRQ1,
        PDL_INTC_FALLING,
        CallBackFunc,
        7
    );

    /* Configure the NMI pin */
    R_INTC_CreateExtInterrupt(
        PDL_INTC_NMI,
        PDL_INTC_FALLING,
        CallBackFunc,
        15
    );

    /* Configure the NMI triggered by the WDT only (no NMI pin) */
    R_INTC_CreateExtInterrupt(
        PDL_INTC_NMI,
        PDL_INTC_WDT_ENABLE,
        CallBackFunc,
        10
    );
}

```

3) R_INTC_CreateSoftwareInterrupt

Synopsis

Enable use of the software interrupt.

Prototype

```
bool R_INTC_CreateSoftwareInterrupt(
    uint8_t data1, // Configuration
    void * func, // Callback function
    uint8_t data2 // Interrupt priority level
);
```

Description

Configure and enable the software interrupt.

[data1]

Choose the pin settings. The default setting is shown in **bold**.

- DTC trigger control.

PDL_INTC_DTC_SW_TRIGGER_DISABLE or PDL_INTC_DTC_SW_TRIGGER_ENABLE	Disable or enable activation of the DTC when a software interrupt is generated.
--	---

[func]

The function to be called when a valid condition is detected. Specify PDL_NO_FUNC if no interrupt is required.

[data2]

The interrupt priority level. Select between 1 (lowest priority) and 15 (highest priority). This parameter will be ignored if PDL_NO_FUNC is specified for parameter func.

Return value

True if all parameters are valid; otherwise false.

Category

Interrupt control

Reference

R_INTC_Write

Remarks

- Please see the notes on callback function use in §6.
- Specifying PDL_NO_FUNC for the callback function allows the software interrupt to be used as a DTC trigger.
- Use R_INTC_Write to generate the software interrupt.

Program example

```
/* RPDL definitions */
#include "r_pdl_intc.h"

/* RPDL device-specific definitions */
#include "r_pdl_definitions.h"

/* Declaration of callback function */
void CallBackFunc( void );

void func( void )
{
    /* Configure the software interrupt handler */
    R_INTC_CreateSoftwareInterrupt(
        PDL_NO_DATA,
        CallBackFunc,
        7
    );
}
```

4) R_INTC_CreateFastInterrupt

Synopsis Enable faster interrupt processing for one interrupt.

Prototype `bool R_INTC_CreateFastInterrupt(uint8_t data // The interrupt to be selected);`

Description (1/4) **[data]** Choose the interrupt vector to be processed using the fast interrupt process.

Name	Module	Interrupt cause
PDL_INTC_VECTOR_BUSERR	External bus	Error (illegal access or timeout)
PDL_INTC_VECTOR_FIFERR	Flash memory	Error
PDL_INTC_VECTOR_FRDYI		Ready
PDL_INTC_VECTOR_SWINT	Interrupt control	Software interrupt
PDL_INTC_VECTOR_CMT0	Compare match timer	Compare match
PDL_INTC_VECTOR_CMT1		
PDL_INTC_VECTOR_CMT2		
PDL_INTC_VECTOR_CMT3		
PDL_INTC_VECTOR_EINT	Ethernet control	Event detection
PDL_INTC_VECTOR_D0FIFO0	USB channel 0	D0FIFO transfer request
PDL_INTC_VECTOR_D1FIFO0		D1FIFO transfer request
PDL_INTC_VECTOR_USBI0		Event detection
PDL_INTC_VECTOR_USBR0		Resume
PDL_INTC_VECTOR_D0FIFO1	USB channel 1	D0FIFO transfer request
PDL_INTC_VECTOR_D1FIFO1		D1FIFO transfer request
PDL_INTC_VECTOR_USBI1		Event detection
PDL_INTC_VECTOR_USBR1		Resume
PDL_INTC_VECTOR_SPRI0	SPI channel 0	Receive buffer full
PDL_INTC_VECTOR_SPTI0		Transmit buffer empty
PDL_INTC_VECTOR_SPII0		Idle
PDL_INTC_VECTOR_SPRI1	SPI channel 1	Receive buffer full
PDL_INTC_VECTOR_SPTI1		Transmit buffer empty
PDL_INTC_VECTOR_SPII1		Idle
PDL_INTC_VECTOR_SPRI2	SPI channel 2	Receive buffer full
PDL_INTC_VECTOR_SPTI2		Transmit buffer empty
PDL_INTC_VECTOR_SPII2		Idle
PDL_INTC_VECTOR_RXF0	CAN channel 0	Receive FIFO
PDL_INTC_VECTOR_TXF0		Transmit FIFO
PDL_INTC_VECTOR_RXM0		Reception complete
PDL_INTC_VECTOR_TXM0		Transmission complete
PDL_INTC_VECTOR_RXF1	CAN channel 1	Receive FIFO
PDL_INTC_VECTOR_TXF1		Transmit FIFO
PDL_INTC_VECTOR_RXM1		Reception complete
PDL_INTC_VECTOR_TXM1		Transmission complete
PDL_INTC_VECTOR_RXF2	CAN channel 2	Receive FIFO
PDL_INTC_VECTOR_TXF2		Transmit FIFO
PDL_INTC_VECTOR_RXM2		Reception complete
PDL_INTC_VECTOR_TXM2		Transmission complete
PDL_INTC_VECTOR_CUP	Real-time clock	Carry
PDL_INTC_VECTOR_ALM		Alarm
PDL_INTC_VECTOR_PRD		Periodic

Description (2/4)		
PDL_INTC_VECTOR_IRQ0	Interrupt controller	Valid edge or level detected on an external interrupt pin
PDL_INTC_VECTOR_IRQ1		
PDL_INTC_VECTOR_IRQ2		
PDL_INTC_VECTOR_IRQ3		
PDL_INTC_VECTOR_IRQ4		
PDL_INTC_VECTOR_IRQ5		
PDL_INTC_VECTOR_IRQ6		
PDL_INTC_VECTOR_IRQ7		
PDL_INTC_VECTOR_IRQ8		
PDL_INTC_VECTOR_IRQ9		
PDL_INTC_VECTOR_IRQ10		
PDL_INTC_VECTOR_IRQ11		
PDL_INTC_VECTOR_IRQ12		
PDL_INTC_VECTOR_IRQ13		
PDL_INTC_VECTOR_IRQ14		
PDL_INTC_VECTOR_IRQ15		
PDL_INTC_VECTOR_GROUP0		Group 0 event
PDL_INTC_VECTOR_GROUP1		Group 1 event
PDL_INTC_VECTOR_GROUP2		Group 2 event
PDL_INTC_VECTOR_GROUP3		Group 3 event
PDL_INTC_VECTOR_GROUP4		Group 4 event
PDL_INTC_VECTOR_GROUP5		Group 5 event
PDL_INTC_VECTOR_GROUP6		Group 6 event
PDL_INTC_VECTOR_GROUP12		Group 12 event
PDL_INTC_VECTOR_ADI0	10-bit ADC	Conversion completed
PDL_INTC_VECTOR_S12ADI0	12-bit ADC	Conversion completed
PDL_INTC_VECTOR_SCIX0	SCI channel 12	Extended serial mode, Break field
PDL_INTC_VECTOR_SCIX1		Extended serial mode, Control field
PDL_INTC_VECTOR_SCIX2		Extended serial mode, Bus collision
PDL_INTC_VECTOR_SCIX3		Extended serial mode, Valid edge
PDL_INTC_VECTOR_TGI0A	Timer Pulse Unit channel 0	Compare match or Input capture A
PDL_INTC_VECTOR_TGI0B		Compare match or Input capture B
PDL_INTC_VECTOR_TGI0C		Compare match or Input capture C
PDL_INTC_VECTOR_TGI0D		Compare match or Input capture D
PDL_INTC_VECTOR_TGI1A	Timer Pulse Unit channel 1	Compare match or Input capture A
PDL_INTC_VECTOR_TGI1B		Compare match or Input capture B
PDL_INTC_VECTOR_TGI2A	Timer Pulse Unit channel 2	Compare match or Input capture A
PDL_INTC_VECTOR_TGI2B		Compare match or Input capture B
PDL_INTC_VECTOR_TGI3A	Timer Pulse Unit channel 3	Compare match or Input capture A
PDL_INTC_VECTOR_TGI3B		Compare match or Input capture B
PDL_INTC_VECTOR_TGI3C		Compare match or Input capture C
PDL_INTC_VECTOR_TGI3D		Compare match or Input capture D
PDL_INTC_VECTOR_TGI4A	Timer Pulse Unit channel 4	Compare match or Input capture A
PDL_INTC_VECTOR_TGI4B		Compare match or Input capture B
PDL_INTC_VECTOR_TGI5A	Timer Pulse Unit channel 5	Compare match or Input capture A
PDL_INTC_VECTOR_TGI5B		Compare match or Input capture B
PDL_INTC_VECTOR_TGI6A_A0	Timer Pulse Unit channel 6 or Multi-function	Compare match or Input capture A
PDL_INTC_VECTOR_TGI6B_B0		Compare match or Input capture B
PDL_INTC_VECTOR_TGI6C_C0		Compare match or Input capture C
PDL_INTC_VECTOR_TGI6D_D0		Compare match or Input capture D
PDL_INTC_VECTOR_TGIE0	Timer Pulse Unit channel 0	Compare match E
PDL_INTC_VECTOR_TGIF0		Compare match F
PDL_INTC_VECTOR_TGI7A_A1	Timer Pulse Unit channel 7 or Multi-function	Compare match or Input capture A
PDL_INTC_VECTOR_TGI7B_B1		Compare match or Input capture B
PDL_INTC_VECTOR_TGI8A_A2	Timer Pulse Unit channel 8 or Multi-function	Compare match or Input capture A
PDL_INTC_VECTOR_TGI8B_B2		Compare match or Input capture B

Description (3/4)		
PDL_INTC_VECTOR_TGIA3	Timer Pulse Unit channel 9 or Multi-function Timer Pulse Unit channel 3	Compare match or Input capture A
PDL_INTC_VECTOR_TGIB3		Compare match or Input capture B
PDL_INTC_VECTOR_TGIC3		Compare match or Input capture C
PDL_INTC_VECTOR_TGID3		Compare match or Input capture D
PDL_INTC_VECTOR_TGI10A_A4	Timer Pulse Unit channel 10 or Multi-function Timer Pulse Unit channel 4	Compare match or Input capture A
PDL_INTC_VECTOR_TGI10B_B4		Compare match or Input capture B
PDL_INTC_VECTOR_TGIC4		Compare match or Input capture C
PDL_INTC_VECTOR_TGID4		Compare match or Input capture D
PDL_INTC_VECTOR_TCIV4		Overflow or underflow
PDL_INTC_VECTOR_TGIU5	Timer Pulse Unit channel 11 or Multi-function	Compare match or Input capture U
PDL_INTC_VECTOR_TGIV5		Compare match or Input capture V
PDL_INTC_VECTOR_TGIW5		Compare match or Input capture W
PDL_INTC_VECTOR_TGI11A	Timer Pulse Unit channel 5	Compare match or Input capture A
PDL_INTC_VECTOR_TGI11B		Compare match or Input capture B
PDL_INTC_VECTOR_OEI1	Port Output Enable	Input-level sampling or output-level comparison detection
PDL_INTC_VECTOR_OEI2		
PDL_INTC_VECTOR_CMIA0	8-bit timer TMR channel 0	Compare match A
PDL_INTC_VECTOR_CMIB0		Compare match B
PDL_INTC_VECTOR_OVI0		Overflow
PDL_INTC_VECTOR_CMIA1	8-bit timer TMR channel 1	Compare match A
PDL_INTC_VECTOR_CMIB1		Compare match B
PDL_INTC_VECTOR_OVI1		Overflow
PDL_INTC_VECTOR_CMIA2	8-bit timer TMR channel 2	Compare match A
PDL_INTC_VECTOR_CMIB2		Compare match B
PDL_INTC_VECTOR_OVI2		Overflow
PDL_INTC_VECTOR_CMIA3	8-bit timer TMR channel 3	Compare match A
PDL_INTC_VECTOR_CMIB3		Compare match B
PDL_INTC_VECTOR_OVI3		Overflow
PDL_INTC_VECTOR_ICEEI0	I ² C bus interface channel 0	Transfer error or event generation
PDL_INTC_VECTOR_ICRXI0		Data received
PDL_INTC_VECTOR_ICTXI0		Start of next data transfer
PDL_INTC_VECTOR_ICTEI0		End of data transfer
PDL_INTC_VECTOR_ICEEI1	I ² C bus interface channel 1	Transfer error or event generation
PDL_INTC_VECTOR_ICRXI1		Data received
PDL_INTC_VECTOR_ICTXI1		Start of next data transfer
PDL_INTC_VECTOR_ICTEI1		End of data transfer
PDL_INTC_VECTOR_ICEEI2	I ² C bus interface channel 2	Transfer error or event generation
PDL_INTC_VECTOR_ICRXI2		Data received
PDL_INTC_VECTOR_ICTXI2		Start of next data transfer
PDL_INTC_VECTOR_ICTEI2		End of data transfer
PDL_INTC_VECTOR_ICEEI3	I ² C bus interface channel 3	Transfer error or event generation
PDL_INTC_VECTOR_ICRXI3		Data received
PDL_INTC_VECTOR_ICTXI3		Start of next data transfer
PDL_INTC_VECTOR_ICTEI3		End of data transfer
PDL_INTC_VECTOR_DMACEI0	Direct memory access controller	
PDL_INTC_VECTOR_DMACEI1		
PDL_INTC_VECTOR_DMACEI2		
PDL_INTC_VECTOR_DMACEI3		
PDL_INTC_VECTOR_EXDMACEI0	External DMAC	Transfer complete or Transfer escape end
PDL_INTC_VECTOR_EXDMACEI1		
PDL_INTC_VECTOR_RXI0	SCI channel 0	Data received
PDL_INTC_VECTOR_TXI0		Start of next data transfer
PDL_INTC_VECTOR_TEI0		End of data transfer
PDL_INTC_VECTOR_RXI1	SCI channel 1	Data received
PDL_INTC_VECTOR_TXI1		Start of next data transfer
PDL_INTC_VECTOR_TEI1		End of data transfer
PDL_INTC_VECTOR_RXI2	SCI channel 2	Data received
PDL_INTC_VECTOR_TXI2		Start of next data transfer
PDL_INTC_VECTOR_TEI2		End of data transfer
PDL_INTC_VECTOR_RXI3	SCI channel 3	Data received
PDL_INTC_VECTOR_TXI3		Start of next data transfer
PDL_INTC_VECTOR_TEI3		End of data transfer

Description (4/4)		
PDL_INTC_VECTOR_RXI4	SCI channel 4	Data received
PDL_INTC_VECTOR_TXI4		Start of next data transfer
PDL_INTC_VECTOR_TEI4		End of data transfer
PDL_INTC_VECTOR_RXI5	SCI channel 5	Data received
PDL_INTC_VECTOR_TXI5		Start of next data transfer
PDL_INTC_VECTOR_TEI5		End of data transfer
PDL_INTC_VECTOR_RXI6	SCI channel 6	Data received
PDL_INTC_VECTOR_TXI6		Start of next data transfer
PDL_INTC_VECTOR_TEI6		End of data transfer
PDL_INTC_VECTOR_RXI7	SCI channel 7	Data received
PDL_INTC_VECTOR_TXI7		Start of next data transfer
PDL_INTC_VECTOR_TEI7		End of data transfer
PDL_INTC_VECTOR_RXI8	SCI channel 8	Data received
PDL_INTC_VECTOR_TXI8		Start of next data transfer
PDL_INTC_VECTOR_TEI8		End of data transfer
PDL_INTC_VECTOR_RXI9	SCI channel 9	Data received
PDL_INTC_VECTOR_TXI9		Start of next data transfer
PDL_INTC_VECTOR_TEI9		End of data transfer
PDL_INTC_VECTOR_RXI10	SCI channel 10	Data received
PDL_INTC_VECTOR_TXI10		Start of next data transfer
PDL_INTC_VECTOR_TEI10		End of data transfer
PDL_INTC_VECTOR_RXI11	SCI channel 11	Data received
PDL_INTC_VECTOR_TXI11		Start of next data transfer
PDL_INTC_VECTOR_TEI11		End of data transfer
PDL_INTC_VECTOR_RXI12	SCI channel 12	Data received
PDL_INTC_VECTOR_TXI12		Start of next data transfer
PDL_INTC_VECTOR_TEI12		End of data transfer
PDL_INTC_VECTOR_IEBINT	IEBus	Any enabled event

Return value

True.

Category

Interrupt control

Reference

Remarks

- The fast interrupt processing is allocated to only one interrupt handler.
- Open the file `r_pdl_user_definitions.h` and edit the definition `FAST_INTC_VECTOR` to give it the same value as the interrupt vector used in parameter `data1`.
For example:
`#define FAST_INTC_VECTOR PDL_INTC_VECTOR_IRQ2`
This will direct the compiler to generate the instructions required for a fast interrupt vector.
- This function uses an interrupt routine to modify the `FINTV` register. If the user has disabled interrupts (cleared the 'I' bit in the `PSW` register) in their own code, this function will lock up.

Program example

```

/* RPDL definitions */
#include "r_pdl_intc.h"

/* RPDL device-specific definitions */
#include "r_pdl_definitions.h"

void func( void )
{
    /* Assign the fast interrupt to the handler for pin IRQ3 */
    R_INTC_CreateFastInterrupt(
        PDL_INTC_VECTOR_IRQ3
    );
}

/* Remember to edit r_pdl_user_definitions.h (see remark 2) */

```

5) R_INTC_CreateExceptionHandlers

Synopsis

Assign handlers for the fixed-vector interrupts.

Prototype

```
bool R_INTC_CreateExceptionHandlers(
    void * func1, // Callback function
    void * func2, // Callback function
    void * func3, // Callback function
    void * func4 // Callback function
);
```

Description

Register the user functions to be called by the fixed-vector and software interrupts.

[func1]

The function to be called when a privileged instruction is detected while in user mode. Specify PDL_NO_FUNC if no callback function is required.

[func2]

The function to be called when an access exception is detected. Specify PDL_NO_FUNC if no callback function is required.

[func3]

The function to be called when an undefined instruction is detected. Specify PDL_NO_FUNC if no callback function is required.

[func4]

The function to be called when a floating point exception is detected. Specify PDL_NO_FUNC if no callback function is required.

Return value

True.

Category

Interrupt control

Reference**Remarks**

- Please see the notes on callback function use in §6.

Program example

```
/* RPDL definitions */
#include "r_pdl_intc.h"

/* RPDL device-specific definitions */
#include "r_pdl_definitions.h"

/* Declaration of callback function */
void UndefinedInstruction( void ){}

void func( void )
{
    /* Assign a function to manage undefined instruction errors */
    R_INTC_CreateExceptionHandlers(
        PDL_NO_FUNC,
        PDL_NO_FUNC,
        UndefinedInstruction,
        PDL_NO_FUNC
    );
}
```

6) R_INTC_ControlExtInterrupt

Synopsis	External interrupt control.																				
Prototype	<pre>bool R_INTC_ControlExtInterrupt(uint8_t data1, // Pin selection uint32_t data2 // Control);</pre>																				
Description	<p>Modifies the specified external interrupt.</p> <p>[data1] Choose the interrupt pin to be controlled.</p> <table border="1"> <tr> <td>PDL_INTC_IRQn (n = 0 to 15) or PDL_INTC_NMI</td> <td>IRQn interrupt pin or NMI interrupt pin</td> </tr> </table> <p>[data2] Select the controls. If multiple selections are required, use “ ” to separate each selection.</p> <ul style="list-style-type: none"> Enable or disable the interrupt pin (for the IRQ pins) <table border="1"> <tr> <td>PDL_INTC_ENABLE or PDL_INTC_DISABLE</td> <td>Enable or disable the IRQn interrupt pin.</td> </tr> </table> Digital filter selection <table border="1"> <tr> <td>PDL_INTC_FILTER_DISABLE or PDL_INTC_FILTER_DIV_1 or PDL_INTC_FILTER_DIV_8 or PDL_INTC_FILTER_DIV_32 or PDL_INTC_FILTER_DIV_64</td> <td>Disable the filter or select PCLKB divided by 1, 8, 32 or 64.</td> </tr> </table> Detection sense selection (for the IRQ pins) <table border="1"> <tr> <td>PDL_INTC_LOW or PDL_INTC_FALLING or PDL_INTC_RISING or PDL_INTC_BOTH</td> <td>Select Low level, Falling edge, Rising edge or Falling and rising edge detection.</td> </tr> </table> Interrupt request clearing <table border="1"> <tr> <td>PDL_INTC_CLEAR_IR_FLAG</td> <td>Clear the IRQ or NMI interrupt request flag. This is not required if: <ul style="list-style-type: none"> A callback function has been specified. The interrupt priority level is higher than 0. The processor interrupt priority level is lower than the interrupt priority level. <p>This operation should not be applied when low-level detection is used.</p> </td> </tr> <tr> <td>PDL_INTC_CLEAR_OSD_FLAG</td> <td>Clear the Oscillation Stop detection NMI flag.</td> </tr> <tr> <td>PDL_INTC_CLEAR_WDT_FLAG</td> <td>Clear the WDT event detection NMI flag.</td> </tr> <tr> <td>PDL_INTC_CLEAR_IWDT_FLAG</td> <td>Clear the IWDT event detection NMI flag.</td> </tr> <tr> <td>PDL_INTC_CLEAR_LVD1_FLAG</td> <td>Clear the LVD1 event detection NMI flag.</td> </tr> <tr> <td>PDL_INTC_CLEAR_LVD2_FLAG</td> <td>Clear the LVD2 event detection NMI flag.</td> </tr> </table> 	PDL_INTC_IRQn (n = 0 to 15) or PDL_INTC_NMI	IRQn interrupt pin or NMI interrupt pin	PDL_INTC_ENABLE or PDL_INTC_DISABLE	Enable or disable the IRQn interrupt pin.	PDL_INTC_FILTER_DISABLE or PDL_INTC_FILTER_DIV_1 or PDL_INTC_FILTER_DIV_8 or PDL_INTC_FILTER_DIV_32 or PDL_INTC_FILTER_DIV_64	Disable the filter or select PCLKB divided by 1, 8, 32 or 64.	PDL_INTC_LOW or PDL_INTC_FALLING or PDL_INTC_RISING or PDL_INTC_BOTH	Select Low level, Falling edge, Rising edge or Falling and rising edge detection.	PDL_INTC_CLEAR_IR_FLAG	Clear the IRQ or NMI interrupt request flag. This is not required if: <ul style="list-style-type: none"> A callback function has been specified. The interrupt priority level is higher than 0. The processor interrupt priority level is lower than the interrupt priority level. <p>This operation should not be applied when low-level detection is used.</p>	PDL_INTC_CLEAR_OSD_FLAG	Clear the Oscillation Stop detection NMI flag.	PDL_INTC_CLEAR_WDT_FLAG	Clear the WDT event detection NMI flag.	PDL_INTC_CLEAR_IWDT_FLAG	Clear the IWDT event detection NMI flag.	PDL_INTC_CLEAR_LVD1_FLAG	Clear the LVD1 event detection NMI flag.	PDL_INTC_CLEAR_LVD2_FLAG	Clear the LVD2 event detection NMI flag.
PDL_INTC_IRQn (n = 0 to 15) or PDL_INTC_NMI	IRQn interrupt pin or NMI interrupt pin																				
PDL_INTC_ENABLE or PDL_INTC_DISABLE	Enable or disable the IRQn interrupt pin.																				
PDL_INTC_FILTER_DISABLE or PDL_INTC_FILTER_DIV_1 or PDL_INTC_FILTER_DIV_8 or PDL_INTC_FILTER_DIV_32 or PDL_INTC_FILTER_DIV_64	Disable the filter or select PCLKB divided by 1, 8, 32 or 64.																				
PDL_INTC_LOW or PDL_INTC_FALLING or PDL_INTC_RISING or PDL_INTC_BOTH	Select Low level, Falling edge, Rising edge or Falling and rising edge detection.																				
PDL_INTC_CLEAR_IR_FLAG	Clear the IRQ or NMI interrupt request flag. This is not required if: <ul style="list-style-type: none"> A callback function has been specified. The interrupt priority level is higher than 0. The processor interrupt priority level is lower than the interrupt priority level. <p>This operation should not be applied when low-level detection is used.</p>																				
PDL_INTC_CLEAR_OSD_FLAG	Clear the Oscillation Stop detection NMI flag.																				
PDL_INTC_CLEAR_WDT_FLAG	Clear the WDT event detection NMI flag.																				
PDL_INTC_CLEAR_IWDT_FLAG	Clear the IWDT event detection NMI flag.																				
PDL_INTC_CLEAR_LVD1_FLAG	Clear the LVD1 event detection NMI flag.																				
PDL_INTC_CLEAR_LVD2_FLAG	Clear the LVD2 event detection NMI flag.																				
Return value	True if all parameters are valid and exclusive; otherwise false.																				
Category	Interrupt control																				
Reference	R_INTC_CreateExtInterrupt, R_INTC_GetExtInterruptStatus																				
Remarks	<ul style="list-style-type: none"> The NMI pin was enabled during R_INTC_CreateExtInterrupt and cannot be disabled (an MCU design feature). When disabling an IRQn pin, the Interrupt Request flag will be cleared automatically. A callback function may be called once more if a valid event occurs just before the interrupt pin is disabled. 																				

Program example

```
/* RPDL definitions */
#include "r_pdl_intc.h"

/* RPDL device-specific definitions */
#include "r_pdl_definitions.h"

void func( void )
{
    /* Disable the IRQ1 interrupt pin and clear the flag */
    R_INTC_ControlExtInterrupt(
        PDL_INTC_IRQ1,
        PDL_INTC_DISABLE | PDL_INTC_CLEAR_IR_FLAG
    );
}
```

7) R_INTC_GetExtInterruptStatus

Synopsis

Read the external interrupt status.

Prototype

```
bool R_INTC_GetExtInterruptStatus(
    uint8_t data1, // Pin selection
    uint8_t * data2 // A pointer to the buffer where the status data shall be stored.
);
```

Description

Acquire the status for the specified external interrupt.

[data1]

Choose the interrupt pin to be checked.

PDL_INTC_IRQn (n = 0 to 15) or PDL_INTC_NMI	IRQn (n = 0 to 15) interrupt pin or NMI interrupt pin
--	--

[data2]

The status flags shall be stored in the following format:

For an IRQ pin:

b7 – b4	b3 – b2	b1	b0
0	Detection condition 00: Low level 01: Falling edge 10: Rising edge 11: Both edges	Current level 0: Low 1: High	Status 0: Not detected 1: Detected

For the NMI interrupt:

b7	b6	b5	b4	b3	b2	b1	b0
Other interrupt request				NMI pin			
LVD2	LVD1	Underflow IWDT WDT		Oscillation stop	Current level	Detection condition	Request status
0: Not detected 1: Detected					0: Low 1: High	0: Falling 1: Rising	0: Not detected 1: Detected

Return value

True if all parameters are valid and exclusive; otherwise false.

Category

Interrupt control

Reference

R_INTC_ControlExtInterrupt

Remarks

- The MPC registers are used to determine which pin is used for IRQn.
- If this function is called from within a callback function, the input detection status will be 0.
- Clear the NMI status flags using R_INTC_ControlExtInterrupt.

Program example

```
/* RPDL definitions */
#include "r_pdl_intc.h"

/* RPDL device-specific definitions */
#include "r_pdl_definitions.h"

void func( void )
{
    uint8_t irq_status;

    /* Read the IR flag and pin state for IRQ5 */
    R_INTC_GetExtInterruptStatus(
        PDL_INTC_IRQ5,
        &irq_status
    );
}
```

The INTC Read, Write and Modify functions use one of the following register definitions.

IR register definitions

PDL_INTC_REG_IR_BSC_BUSERR	PDL_INTC_REG_IR_ICU_GROUP2
PDL_INTC_REG_IR_FCU_FIFERR	PDL_INTC_REG_IR_ICU_GROUP3
PDL_INTC_REG_IR_FCU_FRDYI	PDL_INTC_REG_IR_ICU_GROUP4
PDL_INTC_REG_IR_ICU_SWINT	PDL_INTC_REG_IR_ICU_GROUP5
PDL_INTC_REG_IR_CMT0_CMI	PDL_INTC_REG_IR_ICU_GROUP6
PDL_INTC_REG_IR_CMT1_CMI	PDL_INTC_REG_IR_ICU_GROUP12
PDL_INTC_REG_IR_CMT2_CMI	PDL_INTC_REG_IR_SCI12_SCIX0
PDL_INTC_REG_IR_CMT3_CMI	PDL_INTC_REG_IR_SCI12_SCIX1
PDL_INTC_REG_IR_ETHER_EINT	PDL_INTC_REG_IR_SCI12_SCIX2
PDL_INTC_REG_IR_USB0_D0FIFO	PDL_INTC_REG_IR_SCI12_SCIX3
PDL_INTC_REG_IR_USB0_D1FIFO	PDL_INTC_REG_IR_TPU0_TGIA
PDL_INTC_REG_IR_USB0_USBI	PDL_INTC_REG_IR_TPU0_TGIB
PDL_INTC_REG_IR_USB1_D0FIFO	PDL_INTC_REG_IR_TPU0_TGIC
PDL_INTC_REG_IR_USB1_D1FIFO	PDL_INTC_REG_IR_TPU0_TGID
PDL_INTC_REG_IR_USB1_USBI	PDL_INTC_REG_IR_TPU1_TGIA
PDL_INTC_REG_IR_SPI0_SPRI	PDL_INTC_REG_IR_TPU1_TGIB
PDL_INTC_REG_IR_SPI0_SPTI	PDL_INTC_REG_IR_TPU2_TGIA
PDL_INTC_REG_IR_SPI0_SPII	PDL_INTC_REG_IR_TPU2_TGIB
PDL_INTC_REG_IR_SPI1_SPRI	PDL_INTC_REG_IR_TPU3_TGIA
PDL_INTC_REG_IR_SPI1_SPTI	PDL_INTC_REG_IR_TPU3_TGIB
PDL_INTC_REG_IR_SPI1_SPII	PDL_INTC_REG_IR_TPU3_TGIC
PDL_INTC_REG_IR_SPI2_SPRI	PDL_INTC_REG_IR_TPU3_TGID
PDL_INTC_REG_IR_SPI2_SPTI	PDL_INTC_REG_IR_TPU4_TGIA
PDL_INTC_REG_IR_SPI2_SPII	PDL_INTC_REG_IR_TPU4_TGIB
PDL_INTC_REG_IR_CAN0_RXF	PDL_INTC_REG_IR_TPU5_TGIA
PDL_INTC_REG_IR_CAN0_TXF	PDL_INTC_REG_IR_TPU5_TGIB
PDL_INTC_REG_IR_CAN0_RXM	PDL_INTC_REG_IR_TPU6_TGIA
PDL_INTC_REG_IR_CAN0_TXM	PDL_INTC_REG_IR_TPU6_TGIB
PDL_INTC_REG_IR_CAN1_RXF	PDL_INTC_REG_IR_TPU6_TGIC
PDL_INTC_REG_IR_CAN1_TXF	PDL_INTC_REG_IR_TPU6_TGID
PDL_INTC_REG_IR_CAN1_RXM	PDL_INTC_REG_IR_TPU7_TGIA
PDL_INTC_REG_IR_CAN1_TXM	PDL_INTC_REG_IR_TPU7_TGIB
PDL_INTC_REG_IR_CAN2_RXF	PDL_INTC_REG_IR_TPU8_TGIA
PDL_INTC_REG_IR_CAN2_TXF	PDL_INTC_REG_IR_TPU8_TGIB
PDL_INTC_REG_IR_CAN2_RXM	PDL_INTC_REG_IR_TPU9_TGIA
PDL_INTC_REG_IR_CAN2_TXM	PDL_INTC_REG_IR_TPU9_TGIB
PDL_INTC_REG_IR_RTC_CUP	PDL_INTC_REG_IR_TPU9_TGIC
PDL_INTC_REG_IR_ICU_IRQ0	PDL_INTC_REG_IR_TPU9_TGID
PDL_INTC_REG_IR_ICU_IRQ1	PDL_INTC_REG_IR_TPU10_TGIA
PDL_INTC_REG_IR_ICU_IRQ2	PDL_INTC_REG_IR_TPU10_TGIB
PDL_INTC_REG_IR_ICU_IRQ3	PDL_INTC_REG_IR_TPU11_TGIA
PDL_INTC_REG_IR_ICU_IRQ4	PDL_INTC_REG_IR_TPU11_TGIB
PDL_INTC_REG_IR_ICU_IRQ5	PDL_INTC_REG_IR_MTU0_TGIA
PDL_INTC_REG_IR_ICU_IRQ6	PDL_INTC_REG_IR_MTU0_TGIB
PDL_INTC_REG_IR_ICU_IRQ7	PDL_INTC_REG_IR_MTU0_TGIC
PDL_INTC_REG_IR_ICU_IRQ8	PDL_INTC_REG_IR_MTU0_TGID
PDL_INTC_REG_IR_ICU_IRQ9	PDL_INTC_REG_IR_MTU0_TGIE
PDL_INTC_REG_IR_ICU_IRQ10	PDL_INTC_REG_IR_MTU0_TGIF
PDL_INTC_REG_IR_ICU_IRQ11	PDL_INTC_REG_IR_MTU1_TGIA
PDL_INTC_REG_IR_ICU_IRQ12	PDL_INTC_REG_IR_MTU1_TGIB
PDL_INTC_REG_IR_ICU_IRQ13	PDL_INTC_REG_IR_MTU2_TGIA
PDL_INTC_REG_IR_ICU_IRQ14	PDL_INTC_REG_IR_MTU2_TGIB
PDL_INTC_REG_IR_ICU_IRQ15	PDL_INTC_REG_IR_MTU3_TGIA
PDL_INTC_REG_IR_USB0_USBR	PDL_INTC_REG_IR_MTU3_TGIB
PDL_INTC_REG_IR_USB1_USBR	PDL_INTC_REG_IR_MTU3_TGIC
PDL_INTC_REG_IR_RTC_ALM	PDL_INTC_REG_IR_MTU3_TGID
PDL_INTC_REG_IR_RTC_PRD	PDL_INTC_REG_IR_MTU4_TGIA
PDL_INTC_REG_IR_AD_ADI	PDL_INTC_REG_IR_MTU4_TGIB
PDL_INTC_REG_IR_S12AD_S12ADI	PDL_INTC_REG_IR_MTU4_TGIC
PDL_INTC_REG_IR_ICU_GROUP0	PDL_INTC_REG_IR_MTU4_TGID
PDL_INTC_REG_IR_ICU_GROUP1	PDL_INTC_REG_IR_MTU4_TCIV

PDL_INTC_REG_IR_MTU5_TGIU	PDL_INTC_REG_IR_SCI0_RXI
PDL_INTC_REG_IR_MTU5_TGIV	PDL_INTC_REG_IR_SCI0_TXI
PDL_INTC_REG_IR_MTU5_TGIW	PDL_INTC_REG_IR_SCI0_TEI
PDL_INTC_REG_IR_POE_OEI1	PDL_INTC_REG_IR_SCI1_RXI
PDL_INTC_REG_IR_POE_OEI2	PDL_INTC_REG_IR_SCI1_TXI
PDL_INTC_REG_IR_TMR0_CMIA	PDL_INTC_REG_IR_SCI1_TEI
PDL_INTC_REG_IR_TMR0_CMIB	PDL_INTC_REG_IR_SCI2_RXI
PDL_INTC_REG_IR_TMR0_OVI	PDL_INTC_REG_IR_SCI2_TXI
PDL_INTC_REG_IR_TMR1_CMIA	PDL_INTC_REG_IR_SCI2_TEI
PDL_INTC_REG_IR_TMR1_CMIB	PDL_INTC_REG_IR_SCI3_RXI
PDL_INTC_REG_IR_TMR1_OVI	PDL_INTC_REG_IR_SCI3_TXI
PDL_INTC_REG_IR_TMR2_CMIA	PDL_INTC_REG_IR_SCI3_TEI
PDL_INTC_REG_IR_TMR2_CMIB	PDL_INTC_REG_IR_SCI4_RXI
PDL_INTC_REG_IR_TMR2_OVI	PDL_INTC_REG_IR_SCI4_TXI
PDL_INTC_REG_IR_TMR3_CMIA	PDL_INTC_REG_IR_SCI4_TEI
PDL_INTC_REG_IR_TMR3_CMIB	PDL_INTC_REG_IR_SCI5_RXI
PDL_INTC_REG_IR_TMR3_OVI	PDL_INTC_REG_IR_SCI5_TXI
PDL_INTC_REG_IR_IIC0_EEI	PDL_INTC_REG_IR_SCI5_TEI
PDL_INTC_REG_IR_IIC0_RXI	PDL_INTC_REG_IR_SCI6_RXI
PDL_INTC_REG_IR_IIC0_TXI	PDL_INTC_REG_IR_SCI6_TXI
PDL_INTC_REG_IR_IIC0_TEI	PDL_INTC_REG_IR_SCI6_TEI
PDL_INTC_REG_IR_IIC1_EEI	PDL_INTC_REG_IR_SCI7_RXI
PDL_INTC_REG_IR_IIC1_RXI	PDL_INTC_REG_IR_SCI7_TXI
PDL_INTC_REG_IR_IIC1_TXI	PDL_INTC_REG_IR_SCI7_TEI
PDL_INTC_REG_IR_IIC1_TEI	PDL_INTC_REG_IR_SCI8_RXI
PDL_INTC_REG_IR_IIC2_EEI	PDL_INTC_REG_IR_SCI8_TXI
PDL_INTC_REG_IR_IIC2_RXI	PDL_INTC_REG_IR_SCI8_TEI
PDL_INTC_REG_IR_IIC2_TXI	PDL_INTC_REG_IR_SCI9_RXI
PDL_INTC_REG_IR_IIC2_TEI	PDL_INTC_REG_IR_SCI9_TXI
PDL_INTC_REG_IR_IIC3_EEI	PDL_INTC_REG_IR_SCI9_TEI
PDL_INTC_REG_IR_IIC3_RXI	PDL_INTC_REG_IR_SCI10_RXI
PDL_INTC_REG_IR_IIC3_TXI	PDL_INTC_REG_IR_SCI10_TXI
PDL_INTC_REG_IR_IIC3_TEI	PDL_INTC_REG_IR_SCI10_TEI
PDL_INTC_REG_IR_DMAC_DMACH0I	PDL_INTC_REG_IR_SCI11_RXI
PDL_INTC_REG_IR_DMAC_DMACH1I	PDL_INTC_REG_IR_SCI11_TXI
PDL_INTC_REG_IR_DMAC_DMACH2I	PDL_INTC_REG_IR_SCI11_TEI
PDL_INTC_REG_IR_DMAC_DMACH3I	PDL_INTC_REG_IR_SCI12_RXI
PDL_INTC_REG_IR_EXDMAC_EXDMACH0I	PDL_INTC_REG_IR_SCI12_TXI
PDL_INTC_REG_IR_EXDMAC_EXDMACH1I	PDL_INTC_REG_IR_SCI12_TEI
	PDL_INTC_REG_IR_IEB_IEBINT

IER register definitions

PDL_INTC_REG_IER02	PDL_INTC_REG_IER12
PDL_INTC_REG_IER03	PDL_INTC_REG_IER13
PDL_INTC_REG_IER04	PDL_INTC_REG_IER14
PDL_INTC_REG_IER05	PDL_INTC_REG_IER15
PDL_INTC_REG_IER06	PDL_INTC_REG_IER16
PDL_INTC_REG_IER07	PDL_INTC_REG_IER17
PDL_INTC_REG_IER08	PDL_INTC_REG_IER18
PDL_INTC_REG_IER09	PDL_INTC_REG_IER19
PDL_INTC_REG_IER0B	PDL_INTC_REG_IER1A
PDL_INTC_REG_IER0C	PDL_INTC_REG_IER1B
PDL_INTC_REG_IER0D	PDL_INTC_REG_IER1C
PDL_INTC_REG_IER0E	PDL_INTC_REG_IER1D
PDL_INTC_REG_IER0F	PDL_INTC_REG_IER1E
PDL_INTC_REG_IER10	PDL_INTC_REG_IER1F
PDL_INTC_REG_IER11	

IPR register definitions

PDL_INTC_REG_IPR_BSC_BUSERR	PDL_INTC_REG_IPR_TPU0
PDL_INTC_REG_IPR_FCU_FIFERR	PDL_INTC_REG_IPR_TPU1
PDL_INTC_REG_IPR_FCU_FRDYI	PDL_INTC_REG_IPR_TPU2
PDL_INTC_REG_IPR_ICU_SWINT	PDL_INTC_REG_IPR_TPU3
PDL_INTC_REG_IPR_CMT0_CMI	PDL_INTC_REG_IPR_TPU4
PDL_INTC_REG_IPR_CMT1_CMI	PDL_INTC_REG_IPR_TPU5
PDL_INTC_REG_IPR_CMT2_CMI	PDL_INTC_REG_IPR_TPU6
PDL_INTC_REG_IPR_CMT3_CMI	PDL_INTC_REG_IPR_TPU7
PDL_INTC_REG_IPR_ETHER_EINT	PDL_INTC_REG_IPR_TPU8
PDL_INTC_REG_IPR_USB0_D0FIFO	PDL_INTC_REG_IPR_TPU9
PDL_INTC_REG_IPR_USB0_D1FIFO	PDL_INTC_REG_IPR_TPU10
PDL_INTC_REG_IPR_USB0_USBI	PDL_INTC_REG_IPR_TPU11
PDL_INTC_REG_IPR_USB1_D0FIFO	PDL_INTC_REG_IPR_MTU0_TGIAD
PDL_INTC_REG_IPR_USB1_D1FIFO	PDL_INTC_REG_IPR_MTU0_TGIEF
PDL_INTC_REG_IPR_USB1_USBI	PDL_INTC_REG_IPR_MTU1
PDL_INTC_REG_IPR_SPI0	PDL_INTC_REG_IPR_MTU2
PDL_INTC_REG_IPR_SPI1	PDL_INTC_REG_IPR_MTU3
PDL_INTC_REG_IPR_SPI2	PDL_INTC_REG_IPR_MTU4_TGIAD
PDL_INTC_REG_IPR_CAN0	PDL_INTC_REG_IPR_MTU4_TCIV
PDL_INTC_REG_IPR_CAN1	PDL_INTC_REG_IPR_MTU5
PDL_INTC_REG_IPR_CAN2	PDL_INTC_REG_IPR_POE
PDL_INTC_REG_IPR_RTC_CUP	PDL_INTC_REG_IPR_TMR0
PDL_INTC_REG_IPR_ICU_IRQ0	PDL_INTC_REG_IPR_TMR1
PDL_INTC_REG_IPR_ICU_IRQ1	PDL_INTC_REG_IPR_TMR2
PDL_INTC_REG_IPR_ICU_IRQ2	PDL_INTC_REG_IPR_TMR3
PDL_INTC_REG_IPR_ICU_IRQ3	PDL_INTC_REG_IPR_IIC0_EEI
PDL_INTC_REG_IPR_ICU_IRQ4	PDL_INTC_REG_IPR_IIC0_RXI
PDL_INTC_REG_IPR_ICU_IRQ5	PDL_INTC_REG_IPR_IIC0_TXI
PDL_INTC_REG_IPR_ICU_IRQ6	PDL_INTC_REG_IPR_IIC0_TEI
PDL_INTC_REG_IPR_ICU_IRQ7	PDL_INTC_REG_IPR_IIC1_EEI
PDL_INTC_REG_IPR_ICU_IRQ8	PDL_INTC_REG_IPR_IIC1_RXI
PDL_INTC_REG_IPR_ICU_IRQ9	PDL_INTC_REG_IPR_IIC1_TXI
PDL_INTC_REG_IPR_ICU_IRQ10	PDL_INTC_REG_IPR_IIC1_TEI
PDL_INTC_REG_IPR_ICU_IRQ11	PDL_INTC_REG_IPR_IIC2_EEI
PDL_INTC_REG_IPR_ICU_IRQ12	PDL_INTC_REG_IPR_IIC2_RXI
PDL_INTC_REG_IPR_ICU_IRQ13	PDL_INTC_REG_IPR_IIC2_TXI
PDL_INTC_REG_IPR_ICU_IRQ14	PDL_INTC_REG_IPR_IIC2_TEI
PDL_INTC_REG_IPR_ICU_IRQ15	PDL_INTC_REG_IPR_IIC3_EEI
PDL_INTC_REG_IPR_USB0_USBR	PDL_INTC_REG_IPR_IIC3_RXI
PDL_INTC_REG_IPR_USB1_USBR	PDL_INTC_REG_IPR_IIC3_TXI
PDL_INTC_REG_IPR_RTC_ALM	PDL_INTC_REG_IPR_IIC3_TEI
PDL_INTC_REG_IPR_RTC_PRD	PDL_INTC_REG_IPR_DMAC_DMAC0I
PDL_INTC_REG_IPR_AD_ADI	PDL_INTC_REG_IPR_DMAC_DMAC1I
PDL_INTC_REG_IPR_S12AD_S12ADI	PDL_INTC_REG_IPR_DMAC_DMAC2I
PDL_INTC_REG_IPR_ICU_GROUP0	PDL_INTC_REG_IPR_DMAC_DMAC3I
PDL_INTC_REG_IPR_ICU_GROUP1	PDL_INTC_REG_IPR_EXDMAC_EXDMAC0I
PDL_INTC_REG_IPR_ICU_GROUP2	PDL_INTC_REG_IPR_EXDMAC_EXDMAC1I
PDL_INTC_REG_IPR_ICU_GROUP3	PDL_INTC_REG_IPR_SCI0
PDL_INTC_REG_IPR_ICU_GROUP4	PDL_INTC_REG_IPR_SCI1
PDL_INTC_REG_IPR_ICU_GROUP5	PDL_INTC_REG_IPR_SCI2
PDL_INTC_REG_IPR_ICU_GROUP6	PDL_INTC_REG_IPR_SCI3
PDL_INTC_REG_IPR_ICU_GROUP12	PDL_INTC_REG_IPR_SCI4
PDL_INTC_REG_IPR_SCI12_SCIX	PDL_INTC_REG_IPR_SCI5
	PDL_INTC_REG_IPR_SCI6
	PDL_INTC_REG_IPR_SCI7
	PDL_INTC_REG_IPR_SCI8
	PDL_INTC_REG_IPR_SCI9
	PDL_INTC_REG_IPR_SCI10
	PDL_INTC_REG_IPR_SCI11
	PDL_INTC_REG_IPR_SCI12
	PDL_INTC_REG_IPR_IEB

DTCER register definitions

PDL_INTC_REG_DTCER_ICU_SWINT	PDL_INTC_REG_DTCER_TPU11_TGIA
PDL_INTC_REG_DTCER_CMT0_CMI	PDL_INTC_REG_DTCER_TPU11_TGIB
PDL_INTC_REG_DTCER_CMT1_CMI	PDL_INTC_REG_DTCER_MTU0_TGIA
PDL_INTC_REG_DTCER_CMT2_CMI	PDL_INTC_REG_DTCER_MTU0_TGIB
PDL_INTC_REG_DTCER_CMT3_CMI	PDL_INTC_REG_DTCER_MTU0_TGIC
PDL_INTC_REG_DTCER_USB0_D0FIFO	PDL_INTC_REG_DTCER_MTU0_TGID
PDL_INTC_REG_DTCER_USB0_D1FIFO	PDL_INTC_REG_DTCER_MTU1_TGIA
PDL_INTC_REG_DTCER_USB1_D0FIFO	PDL_INTC_REG_DTCER_MTU1_TGIB
PDL_INTC_REG_DTCER_USB1_D1FIFO	PDL_INTC_REG_DTCER_MTU2_TGIA
PDL_INTC_REG_DTCER_SPI0_SPRI	PDL_INTC_REG_DTCER_MTU2_TGIB
PDL_INTC_REG_DTCER_SPI0_SPTI	PDL_INTC_REG_DTCER_MTU3_TGIA
PDL_INTC_REG_DTCER_SPI1_SPRI	PDL_INTC_REG_DTCER_MTU3_TGIB
PDL_INTC_REG_DTCER_SPI1_SPTI	PDL_INTC_REG_DTCER_MTU3_TGIC
PDL_INTC_REG_DTCER_SPI2_SPRI	PDL_INTC_REG_DTCER_MTU3_TGID
PDL_INTC_REG_DTCER_SPI2_SPTI	PDL_INTC_REG_DTCER_MTU4_TGIA
PDL_INTC_REG_DTCER_ICU_IRQ0	PDL_INTC_REG_DTCER_MTU4_TGIB
PDL_INTC_REG_DTCER_ICU_IRQ1	PDL_INTC_REG_DTCER_MTU4_TGIC
PDL_INTC_REG_DTCER_ICU_IRQ2	PDL_INTC_REG_DTCER_MTU4_TGID
PDL_INTC_REG_DTCER_ICU_IRQ3	PDL_INTC_REG_DTCER_MTU4_TCIV
PDL_INTC_REG_DTCER_ICU_IRQ4	PDL_INTC_REG_DTCER_MTU5_TGIU
PDL_INTC_REG_DTCER_ICU_IRQ5	PDL_INTC_REG_DTCER_MTU5_TGIV
PDL_INTC_REG_DTCER_ICU_IRQ6	PDL_INTC_REG_DTCER_MTU5_TGIW
PDL_INTC_REG_DTCER_ICU_IRQ7	PDL_INTC_REG_DTCER_TMR0_CMIA
PDL_INTC_REG_DTCER_ICU_IRQ8	PDL_INTC_REG_DTCER_TMR0_CMIB
PDL_INTC_REG_DTCER_ICU_IRQ9	PDL_INTC_REG_DTCER_TMR1_CMIA
PDL_INTC_REG_DTCER_ICU_IRQ10	PDL_INTC_REG_DTCER_TMR1_CMIB
PDL_INTC_REG_DTCER_ICU_IRQ11	PDL_INTC_REG_DTCER_TMR2_CMIA
PDL_INTC_REG_DTCER_ICU_IRQ12	PDL_INTC_REG_DTCER_TMR2_CMIB
PDL_INTC_REG_DTCER_ICU_IRQ13	PDL_INTC_REG_DTCER_TMR3_CMIA
PDL_INTC_REG_DTCER_ICU_IRQ14	PDL_INTC_REG_DTCER_TMR3_CMIB
PDL_INTC_REG_DTCER_ICU_IRQ15	PDL_INTC_REG_DTCER_IIC0_RXI
PDL_INTC_REG_DTCER_AD_ADI	PDL_INTC_REG_DTCER_IIC0_TXI
PDL_INTC_REG_DTCER_S12AD_S12ADI	PDL_INTC_REG_DTCER_IIC1_RXI
PDL_INTC_REG_DTCER_TPU0_TGIA	PDL_INTC_REG_DTCER_IIC1_TXI
PDL_INTC_REG_DTCER_TPU0_TGIB	PDL_INTC_REG_DTCER_IIC2_RXI
PDL_INTC_REG_DTCER_TPU0_TGIC	PDL_INTC_REG_DTCER_IIC2_TXI
PDL_INTC_REG_DTCER_TPU0_TGID	PDL_INTC_REG_DTCER_IIC3_RXI
PDL_INTC_REG_DTCER_TPU1_TGIA	PDL_INTC_REG_DTCER_IIC3_TXI
PDL_INTC_REG_DTCER_TPU1_TGIB	PDL_INTC_REG_DTCER_DMAC_DMAC0I
PDL_INTC_REG_DTCER_TPU2_TGIA	PDL_INTC_REG_DTCER_DMAC_DMAC1I
PDL_INTC_REG_DTCER_TPU2_TGIB	PDL_INTC_REG_DTCER_DMAC_DMAC2I
PDL_INTC_REG_DTCER_TPU3_TGIA	PDL_INTC_REG_DTCER_DMAC_DMAC3I
PDL_INTC_REG_DTCER_TPU3_TGIB	PDL_INTC_REG_DTCER_EXDMAC_EXDMAC0I
PDL_INTC_REG_DTCER_TPU3_TGIC	PDL_INTC_REG_DTCER_EXDMAC_EXDMAC1I
PDL_INTC_REG_DTCER_TPU3_TGID	PDL_INTC_REG_DTCER_SCI0_RXI
PDL_INTC_REG_DTCER_TPU4_TGIA	PDL_INTC_REG_DTCER_SCI0_TXI
PDL_INTC_REG_DTCER_TPU4_TGIB	PDL_INTC_REG_DTCER_SCI1_RXI
PDL_INTC_REG_DTCER_TPU5_TGIA	PDL_INTC_REG_DTCER_SCI1_TXI
PDL_INTC_REG_DTCER_TPU5_TGIB	PDL_INTC_REG_DTCER_SCI2_RXI
PDL_INTC_REG_DTCER_TPU6_TGIA	PDL_INTC_REG_DTCER_SCI2_TXI
PDL_INTC_REG_DTCER_TPU6_TGIB	PDL_INTC_REG_DTCER_SCI3_RXI
PDL_INTC_REG_DTCER_TPU6_TGIC	PDL_INTC_REG_DTCER_SCI3_TXI
PDL_INTC_REG_DTCER_TPU6_TGID	PDL_INTC_REG_DTCER_SCI4_RXI
PDL_INTC_REG_DTCER_TPU7_TGIA	PDL_INTC_REG_DTCER_SCI4_TXI
PDL_INTC_REG_DTCER_TPU7_TGIB	PDL_INTC_REG_DTCER_SCI5_RXI
PDL_INTC_REG_DTCER_TPU8_TGIA	PDL_INTC_REG_DTCER_SCI5_TXI
PDL_INTC_REG_DTCER_TPU8_TGIB	PDL_INTC_REG_DTCER_SCI6_RXI
PDL_INTC_REG_DTCER_TPU9_TGIA	PDL_INTC_REG_DTCER_SCI6_TXI
PDL_INTC_REG_DTCER_TPU9_TGIB	PDL_INTC_REG_DTCER_SCI7_RXI
PDL_INTC_REG_DTCER_TPU9_TGIC	PDL_INTC_REG_DTCER_SCI7_TXI
PDL_INTC_REG_DTCER_TPU9_TGID	PDL_INTC_REG_DTCER_SCI8_RXI
PDL_INTC_REG_DTCER_TPU10_TGIA	PDL_INTC_REG_DTCER_SCI8_TXI
PDL_INTC_REG_DTCER_TPU10_TGIB	

PDL_INTC_REG_DTCER_SCI9_RXI	PDL_INTC_REG_DTCER_SCI11_RXI
PDL_INTC_REG_DTCER_SCI9_TXI	PDL_INTC_REG_DTCER_SCI11_TXI
PDL_INTC_REG_DTCER_SCI10_RXI	PDL_INTC_REG_DTCER_SCI12_RXI
PDL_INTC_REG_DTCER_SCI10_TXI	PDL_INTC_REG_DTCER_SCI12_TXI

8) R_INTC_Read

Synopsis

Read an interrupt register.

Prototype

```
bool R_INTC_Read(
    uint16_t data1, // Register selection
    uint8_t * data2 // Data storage location
);
```

Description

Read an interrupt register and store the value.

[data1]

- The register to be read.

PDL_INTC_REG_IPL or PDL_INTC_REG_IR_(register) or PDL_INTC_REG_IER_(register) or PDL_INTC_REG_IPR_(register) or PDL_INTC_REG_DTCER_(register)	Select the current CPU interrupt priority level or Interrupt Request register or Interrupt Request Enable register or Interrupt Priority register or DTC Activation Enable register
---	---

[data2]

The location where the register's value shall be stored.

Return value

True if all parameters are valid and exclusive; otherwise false.

Category

Interrupt control

Reference

None.

Remarks

- For (register), select one of the registers listed in the tables starting on page 80.

Program example

```
/* RPDL definitions */
#include "r_pdl_intc.h"

/* RPDL device-specific definitions */
#include "r_pdl_definitions.h"

void func( void )
{
    uint8_t ipl;

    /* Read the IPL bits */
    R_INTC_Read(
        PDL_INTC_REG_IPL,
        &ipl
    );
}
```

9) R_INTC_Write

Synopsis

Update an interrupt register.

Prototype

```
bool R_INTC_Write(
    uint16_t data1, // Register selection
    uint8_t data2   // Register value
);
```

Description

Write the new value to an interrupt register.

[data1]

- The register to be updated.

PDL_INTC_REG_IPL or PDL_INTC_REG_IR_(register) or PDL_INTC_REG_IER_(register) or PDL_INTC_REG_IPR_(register) or PDL_INTC_REG_DTCER_(register) or PDL_INTC_REG_SWINTR	Select the current CPU interrupt priority level or Interrupt Request register or Interrupt Request Enable register or Interrupt Priority register or DTC Activation Enable register or Software interrupt activation register
---	--

[data2]

The value to be written to the register.

Return value

True if the parameter is within range; otherwise false.

Category

Interrupt control

Reference

None.

Remarks

- This function uses an interrupt routine to modify the IPL bits. If the user has disabled interrupts (cleared the 'I' bit in the PSW register) in their own code, this function will lock up.
- For (register), select one of the registers listed in the tables starting on page 80.
- Write 1 to the SWINTR register to generate a software interrupt request.

Program example

```
/* RPDL definitions */
#include "r_pdl_intc.h"

/* RPDL device-specific definitions */
#include "r_pdl_definitions.h"

void func( void )
{
    /* Set the IPL to 6 */
    R_INTC_Write(
        PDL_INTC_REG_IPL,
        6
    );

    /* Set the IR for IRQ0 to 0 */
    R_INTC_Write(
        PDL_INTC_REG_IR_ICU_IRQ0,
        0
    );
}
```

10) R_INTC_Modify**Synopsis**

Modify an interrupt register.

Prototype

```
bool R_INTC_Modify(
    uint16_t data1, // Register selection
    uint8_t data2,  // Logical operation
    uint8_t data3   // Modification value
);
```

Description

Update the value in an interrupt register.

[data1]

- The register to be updated.

PDL_INTC_REG_IR_(register) or PDL_INTC_REG_IER_(register) or PDL_INTC_REG_IPR_(register)	Select the Interrupt Request register or Interrupt Request Enable register or Interrupt Priority register
--	---

[data2]

- The logical operation to be applied to the register contents.

PDL_INTC_AND or PDL_INTC_OR or PDL_INTC_XOR	Select between AND (&), OR () or Exclusive-OR (^).
---	---

[data3]

The value to be used by the logical operation.

Return value

True if the parameter is within range; otherwise false.

Category

Interrupt control

Reference

None.

Remarks

- This function uses an interrupt routine to modify the IPL bits. If the user has disabled interrupts (cleared the 'I' bit in the PSW register) in their own code, this function will lock up.
- For (register), select one of the registers listed in the tables starting on page 80.

Program example

```
/* RPDL definitions */
#include "r_pdl_intc.h"

/* RPDL device-specific definitions */
#include "r_pdl_definitions.h"

void func( void )
{
    /* Set bits 6 and 4 in IER09 to 1 */
    R_INTC_Modify(
        PDL_INTC_REG_IER09,
        PDL_INTC_OR,
        0x50
    );
}
```

11) R_INTC_CreateGroup**Synopsis**

Configure a group of peripheral interrupt requests.

Prototype

```
bool R_INTC_CreateGroup(
    uint8_t data1, // Group selection
    void * func,   // Callback function
    uint8_t data2  // Interrupt priority level
);
```

Description

Set up the grouped interrupt request callback function.

[data1]

The interrupt request group n to be configured (where n = 0 to 6 or 12).

[func]

The function to be called when a valid condition is detected.

[data2]

The interrupt priority level. Select between 1 (lowest priority) and 15 (highest priority).

Return value

True if all parameters are valid and exclusive; otherwise false.

Category

Interrupt control

Reference

R_INTC_ControlGroup

Remarks

- Do not use this function if RPD_L functions will be used to configure the applicable peripheral.
- Use R_INTC_ControlGroup to enable the required peripheral interrupt requests.
- Please see the notes on callback function use in §6.

Program example

```
/* RPD_L definitions */
#include "r_pdl_intc.h"

/* RPD_L device-specific definitions */
#include "r_pdl_definitions.h"

/* Callback function */
void CallBackFunc( void ){}

void func( void )
{
    /* Assign a handler for group 4 */
    R_INTC_CreateGroup(
        4,
        CallBackFunc,
        10
    );
}
```

12) R_INTC_ControlGroup

Synopsis

Control an interrupt request group.

Prototype

```
bool R_INTC_ControlGroup(
    uint8_t data1, // Group selection
    uint8_t data2, // Interrupt control operation
    uint32_t data3 // Interrupt source selection
);
```

Description (1/2)

Control an interrupt request group.

[data1]

The interrupt group n to be controlled (where n = 0 to 6 or 12).

[data2]

The logical operations to be applied to the interrupt request group.

If multiple selections are required, use “|” to separate each selection.

PDL_INTC_GROUP_DISABLE	Disable the interrupt requests.
PDL_INTC_GROUP_CLEAR	Clear the interrupt request flags.
PDL_INTC_GROUP_ENABLE	Enable the interrupt requests.

[data3]

Choose the peripheral interrupt request sources (for the group specified in parameter data1) to be modified.

If multiple selections are required, use “|” to separate each selection.

PDL_INTC_GRPn_ALL can be used to specify all applicable selections.

• Group 0 selections

PDL_INTC_GRP0_ERS0	Error on CAN channels 0, 1 or 2.
PDL_INTC_GRP0_ERS1	
PDL_INTC_GRP0_ERS2	

• Group 1 selections

PDL_INTC_GRP1_TCIV0	Overflow on MTU channels 0 or 1. Underflow on MTU channel 1.
PDL_INTC_GRP1_TCIV1	
PDL_INTC_GRP1_TCIU1	

• Group 2 selections

PDL_INTC_GRP2_TCIV2	Overflow on MTU channels 2 or 3. Underflow on MTU channel 3.
PDL_INTC_GRP2_TCIU2	
PDL_INTC_GRP2_TCIV3	

• Group 3 selections

PDL_INTC_GRP3_TCI0V	Overflow on TPU channels 0, 1 or 5. Underflow on TPU channels 1 or 5.
PDL_INTC_GRP3_TCI1V	
PDL_INTC_GRP3_TCI1U	
PDL_INTC_GRP3_TCI5V	
PDL_INTC_GRP3_TCI5U	

• Group 4 selections

PDL_INTC_GRP4_TCI2V	Overflow on TPU channels 2, 3 or 4. Underflow on TPU channels 2 or 4.
PDL_INTC_GRP4_TCI2U	
PDL_INTC_GRP4_TCI3V	
PDL_INTC_GRP4_TCI4V	
PDL_INTC_GRP4_TCI4U	

• Group 5 selections

PDL_INTC_GRP5_TCI6V	Overflow on TPU channels 6, 7 or 11. Underflow on TPU channels 7 or 11.
PDL_INTC_GRP5_TCI7V	
PDL_INTC_GRP5_TCI7U	
PDL_INTC_GRP5_TCI11V	
PDL_INTC_GRP5_TCI11U	

Description (2/2)	<ul style="list-style-type: none"> Group 6 selections <table border="1" style="width: 100%;"> <tr><td>PDL_INTC_GRP6_TCI8V</td></tr> <tr><td>PDL_INTC_GRP6_TCI8U</td></tr> <tr><td>PDL_INTC_GRP6_TCI9V</td></tr> <tr><td>PDL_INTC_GRP6_TCI10V</td></tr> <tr><td>PDL_INTC_GRP6_TCI10U</td></tr> </table> <p style="margin-left: 20px;">Overflow on TPU channels 8, 9 or 10. Underflow on TPU channels 8 or 10.</p> Group 12 selections. Flag clearing (using PDL_INTC_GROUP_CLEAR) is not possible. <table border="1" style="width: 100%;"> <tr><td>PDL_INTC_GRP12_ERI0</td></tr> <tr><td>PDL_INTC_GRP12_ERI1</td></tr> <tr><td>PDL_INTC_GRP12_ERI2</td></tr> <tr><td>PDL_INTC_GRP12_ERI3</td></tr> <tr><td>PDL_INTC_GRP12_ERI4</td></tr> <tr><td>PDL_INTC_GRP12_ERI5</td></tr> <tr><td>PDL_INTC_GRP12_ERI6</td></tr> <tr><td>PDL_INTC_GRP12_ERI7</td></tr> <tr><td>PDL_INTC_GRP12_ERI8</td></tr> <tr><td>PDL_INTC_GRP12_ERI9</td></tr> <tr><td>PDL_INTC_GRP12_ERI10</td></tr> <tr><td>PDL_INTC_GRP12_ERI11</td></tr> <tr><td>PDL_INTC_GRP12_ERI12</td></tr> <tr><td>PDL_INTC_GRP12_SPEI0</td></tr> <tr><td>PDL_INTC_GRP12_SPEI1</td></tr> <tr><td>PDL_INTC_GRP12_SPEI2</td></tr> </table> <p style="margin-left: 20px;">Reception error on SCI channels 0 to 12.</p> <p style="margin-left: 20px;">SPI error on channels 0 to 2.</p> 	PDL_INTC_GRP6_TCI8V	PDL_INTC_GRP6_TCI8U	PDL_INTC_GRP6_TCI9V	PDL_INTC_GRP6_TCI10V	PDL_INTC_GRP6_TCI10U	PDL_INTC_GRP12_ERI0	PDL_INTC_GRP12_ERI1	PDL_INTC_GRP12_ERI2	PDL_INTC_GRP12_ERI3	PDL_INTC_GRP12_ERI4	PDL_INTC_GRP12_ERI5	PDL_INTC_GRP12_ERI6	PDL_INTC_GRP12_ERI7	PDL_INTC_GRP12_ERI8	PDL_INTC_GRP12_ERI9	PDL_INTC_GRP12_ERI10	PDL_INTC_GRP12_ERI11	PDL_INTC_GRP12_ERI12	PDL_INTC_GRP12_SPEI0	PDL_INTC_GRP12_SPEI1	PDL_INTC_GRP12_SPEI2
PDL_INTC_GRP6_TCI8V																						
PDL_INTC_GRP6_TCI8U																						
PDL_INTC_GRP6_TCI9V																						
PDL_INTC_GRP6_TCI10V																						
PDL_INTC_GRP6_TCI10U																						
PDL_INTC_GRP12_ERI0																						
PDL_INTC_GRP12_ERI1																						
PDL_INTC_GRP12_ERI2																						
PDL_INTC_GRP12_ERI3																						
PDL_INTC_GRP12_ERI4																						
PDL_INTC_GRP12_ERI5																						
PDL_INTC_GRP12_ERI6																						
PDL_INTC_GRP12_ERI7																						
PDL_INTC_GRP12_ERI8																						
PDL_INTC_GRP12_ERI9																						
PDL_INTC_GRP12_ERI10																						
PDL_INTC_GRP12_ERI11																						
PDL_INTC_GRP12_ERI12																						
PDL_INTC_GRP12_SPEI0																						
PDL_INTC_GRP12_SPEI1																						
PDL_INTC_GRP12_SPEI2																						

Return value False if the group number is invalid; otherwise true.

Category Interrupt control

Reference R_INTC_CreateGroup

Remarks

- Do not use this function if RPDL functions will be used to control the applicable peripheral.
- Call R_INTC_CreateGroup before calling this function.
- Flag clearing is done after any interrupt disabling and before any interrupt enabling.
- Group 12 interrupts use level detection, so clearing must be done by clearing the source of the interrupt.

Program example

```

/* RPDL definitions */
#include "r_pdl_intc.h"

/* RPDL device-specific definitions */
#include "r_pdl_definitions.h"

void func( void )
{
    /* Disable the interrupt for the overflow on MTU channel 0 and clear
the flag */
    R_INTC_ControlGroup(
        1,
        PDL_INTC_GROUP_DISABLE | PDL_INTC_GROUP_CLEAR,
        PDL_INTC_GRP1_TCIV0
    );

    /* Enable all of the Group 3 interrupt sources */
    R_INTC_ControlGroup(
        3,
        PDL_INTC_GROUP_ENABLE,
        PDL_INTC_GRP3_ALL
    );
}

```

13) R_INTC_GetStatusGroup

Synopsis Read the status of an interrupt request group.

Prototype
bool R_INTC_GetStatusGroup(
 uint8_t data1, // Group selection
 uint32_t * data2 // Data storage location
);

Description (1/2) Read the grouped interrupt request status flags.

[data1]
 The interrupt request group n to be read (where n = 0 to 6 or 12).

[data2]
 The status flags shall be stored in the format below.

- Group 0

	b31 – b3	b2	b1	b0
0	CAN error interrupts			
	Channel 2	Channel 1	Channel 0	
	0: Not requested 1: Requested			

- Group 1

	b31 – b3	b2	b1	b0
0	MTU interrupts			
	Underflow on channel 1	Overflow on channel 1	Overflow on channel 0	
	0: Not requested 1: Requested			

- Group 2

	b31 – b3	b2	b1	b0
0	MTU interrupts			
	Overflow on channel 3	Underflow on channel 2	Overflow on channel 2	
	0: Not requested 1: Requested			

- Group 3

	b31 – b5	b4	b3	b2	b1	b0
0	TPU interrupts					
	Underflow on channel 5	Overflow on channel 5	Underflow on channel 1	Overflow on channel 1	Overflow on channel 0	
	0: Not requested 1: Requested					

- Group 4

	b31 – b5	b4	b3	b2	b1	b0
0	TPU interrupts					
	Underflow on channel 4	Overflow on channel 4	Overflow on channel 3	Underflow on channel 2	Overflow on channel 2	
	0: Not requested 1: Requested					

- Group 5

	b31 – b5	b4	b3	b2	b1	b0
0	TPU interrupts					
	Underflow on channel 11	Overflow on channel 11	Underflow on channel 7	Overflow on channel 7	Overflow on channel 6	
	0: Not requested 1: Requested					

Description (2/2)

- Group 6

	b31 – b5	b4	b3	b2	b1	b0
0	TPU interrupts					
	Underflow on channel 10	Overflow on channel 10	Overflow on channel 9	Underflow on channel 8	Overflow on channel 8	
	0: Not requested 1: Requested					
- Group 12

	b31 – b16	b15	b14	b13
0	SPI error			
	Channel 2	Channel 1	Channel 0	
	0: Not requested 1: Requested			

	b12	b11	b10	b9	b8	b7
SCI reception error						
Channel 12	Channel 11	Channel 10	Channel 9	Channel 8	Channel 7	
0: Not requested 1: Requested						

	b6	b5	b4	b3	b2	b1	b0
SCI reception error							
Channel 6	Channel 5	Channel 4	Channel 3	Channel 2	Channel 1	Channel 0	
0: Not requested 1: Requested							

Return value

True if all parameters are valid; otherwise false.

Category

Interrupt control

References

R_INTC_ControlGroup

Remarks

- Use R_INTC_ControlGroup to clear the flags.

Program example

```

/* RPDL definitions */
#include "r_pdl_intc.h"

/* RPDL device-specific definitions */
#include "r_pdl_definitions.h"

void func(void)
{
    uint32_t Status_flags;

    /* Read the group 3 status flags */
    R_INTC_GetStatusGroup(
        3,
        &Status_flags
    );
}
    
```

14) R_INTC_Control**Synopsis**

Control the operation of the interrupt controller.

Prototype

```
bool R_INTC_Control(
    uint16_t data // Interrupt selection
);
```

Description

Modify the interrupt selection register.

[data]

Select the MTU or TPU interrupt requests. All selections are optional. If multiple selections are required, use “|” to separate each selection.

PDL_INTC_SEL_MTU0 or PDL_INTC_SEL_TPU6	MTU channel 0 or TPU channel 6.
PDL_INTC_SEL_MTU1 or PDL_INTC_SEL_TPU7	MTU channel 1 or TPU channel 7.
PDL_INTC_SEL_MTU2 or PDL_INTC_SEL_TPU8	MTU channel 2 or TPU channel 8.
PDL_INTC_SEL_MTU3 or PDL_INTC_SEL_TPU9	MTU channel 3 or TPU channel 9.
PDL_INTC_SEL_MTU4 or PDL_INTC_SEL_TPU10	MTU channel 4 or TPU channel 10.
PDL_INTC_SEL_MTU5 or PDL_INTC_SEL_TPU11	MTU channel 5 or TPU channel 11.

Return value

True if all parameters are valid and exclusive; otherwise false.

Category

Interrupt control

References

R_MTU2_Create

Remarks

- The selection register is modified as required by the MTU and TPU Create functions.
- Do not use this function if RPDL functions will be used to configure the MTU or TPU.

Program example

```
/* RPDL definitions */
#include "r_pdl_intc.h"

/* RPDL device-specific definitions */
#include "r_pdl_definitions.h"

void func( void )
{
    /* Select interrupts from MTU channel 1 and TPU channel 11. */
    R_INTC_Control(
        PDL_INTC_SEL_MTU1 | PDL_INTC_SEL_TPU11
    );
}
```

4.2.3. I/O Port

I/O Port functions may operate on a complete port, or on individual port pins. The available definitions are listed below.

I/O port definitions

PDL_IO_PORT_0	Port P0	PDL_IO_PORT_7	Port P5	PDL_IO_PORT_E	Port PE
PDL_IO_PORT_1	Port P1	PDL_IO_PORT_8	Port P8	PDL_IO_PORT_F	Port PF
PDL_IO_PORT_2	Port P2	PDL_IO_PORT_9	Port P9	PDL_IO_PORT_G	Port PG
PDL_IO_PORT_3	Port P3	PDL_IO_PORT_A	Port PA	PDL_IO_PORT_H	Port PH
PDL_IO_PORT_4	Port P4	PDL_IO_PORT_B	Port PB	PDL_IO_PORT_J	Port PJ
PDL_IO_PORT_5	Port P5	PDL_IO_PORT_C	Port PC	PDL_IO_PORT_K	Port PK
PDL_IO_PORT_6	Port P6	PDL_IO_PORT_D	Port PD	PDL_IO_PORT_L	Port PL

Note: Refer to the hardware manual for the ports which are available on the device that you have selected.

I/O port pin definitions

PDL_IO_PORT_0_0	Port pin P0 ₀	PDL_IO_PORT_5_0	Port pin P5 ₀	PDL_IO_PORT_A_0	Port pin PA ₀
PDL_IO_PORT_0_1	Port pin P0 ₁	PDL_IO_PORT_5_1	Port pin P5 ₁	PDL_IO_PORT_A_1	Port pin PA ₁
PDL_IO_PORT_0_2	Port pin P0 ₂	PDL_IO_PORT_5_2	Port pin P5 ₂	PDL_IO_PORT_A_2	Port pin PA ₂
PDL_IO_PORT_0_3	Port pin P0 ₃	PDL_IO_PORT_5_3	Port pin P5 ₃	PDL_IO_PORT_A_3	Port pin PA ₃
PDL_IO_PORT_0_5	Port pin P0 ₅	PDL_IO_PORT_5_4	Port pin P5 ₄	PDL_IO_PORT_A_4	Port pin PA ₄
PDL_IO_PORT_0_7	Port pin P0 ₇	PDL_IO_PORT_5_5	Port pin P5 ₅	PDL_IO_PORT_A_5	Port pin PA ₅
		PDL_IO_PORT_5_6	Port pin P5 ₆	PDL_IO_PORT_A_6	Port pin PA ₆
PDL_IO_PORT_1_0	Port pin P1 ₀	PDL_IO_PORT_5_7	Port pin P5 ₇	PDL_IO_PORT_A_7	Port pin PA ₇
PDL_IO_PORT_1_1	Port pin P1 ₁				
PDL_IO_PORT_1_2	Port pin P1 ₂	PDL_IO_PORT_6_0	Port pin P6 ₀	PDL_IO_PORT_B_0	Port pin PB ₀
PDL_IO_PORT_1_3	Port pin P1 ₃	PDL_IO_PORT_6_1	Port pin P6 ₁	PDL_IO_PORT_B_1	Port pin PB ₁
PDL_IO_PORT_1_4	Port pin P1 ₄	PDL_IO_PORT_6_2	Port pin P6 ₂	PDL_IO_PORT_B_2	Port pin PB ₂
PDL_IO_PORT_1_5	Port pin P1 ₅	PDL_IO_PORT_6_3	Port pin P6 ₃	PDL_IO_PORT_B_3	Port pin PB ₃
PDL_IO_PORT_1_6	Port pin P1 ₆	PDL_IO_PORT_6_4	Port pin P6 ₄	PDL_IO_PORT_B_4	Port pin PB ₄
PDL_IO_PORT_1_7	Port pin P1 ₇	PDL_IO_PORT_6_5	Port pin P6 ₅	PDL_IO_PORT_B_5	Port pin PB ₅
		PDL_IO_PORT_6_6	Port pin P6 ₆	PDL_IO_PORT_B_6	Port pin PB ₆
PDL_IO_PORT_2_0	Port pin P2 ₀	PDL_IO_PORT_6_7	Port pin P6 ₇	PDL_IO_PORT_B_7	Port pin PB ₇
PDL_IO_PORT_2_1	Port pin P2 ₁				
PDL_IO_PORT_2_2	Port pin P2 ₂	PDL_IO_PORT_7_0	Port pin P7 ₀	PDL_IO_PORT_C_0	Port pin PC ₀
PDL_IO_PORT_2_3	Port pin P2 ₃	PDL_IO_PORT_7_1	Port pin P7 ₁	PDL_IO_PORT_C_1	Port pin PC ₁
PDL_IO_PORT_2_4	Port pin P2 ₄	PDL_IO_PORT_7_2	Port pin P7 ₂	PDL_IO_PORT_C_2	Port pin PC ₂
PDL_IO_PORT_2_5	Port pin P2 ₅	PDL_IO_PORT_7_3	Port pin P7 ₃	PDL_IO_PORT_C_3	Port pin PC ₃
PDL_IO_PORT_2_6	Port pin P2 ₆	PDL_IO_PORT_7_4	Port pin P7 ₄	PDL_IO_PORT_C_4	Port pin PC ₄
PDL_IO_PORT_2_7	Port pin P2 ₇	PDL_IO_PORT_7_5	Port pin P7 ₅	PDL_IO_PORT_C_5	Port pin PC ₅
		PDL_IO_PORT_7_6	Port pin P7 ₆	PDL_IO_PORT_C_6	Port pin PC ₆
PDL_IO_PORT_3_0	Port pin P3 ₀	PDL_IO_PORT_7_7	Port pin P7 ₇	PDL_IO_PORT_C_7	Port pin PC ₇
PDL_IO_PORT_3_1	Port pin P3 ₁				
PDL_IO_PORT_3_2	Port pin P3 ₂	PDL_IO_PORT_8_0	Port pin P8 ₀	PDL_IO_PORT_D_0	Port pin PD ₀
PDL_IO_PORT_3_3	Port pin P3 ₃	PDL_IO_PORT_8_1	Port pin P8 ₁	PDL_IO_PORT_D_1	Port pin PD ₁
PDL_IO_PORT_3_4	Port pin P3 ₄	PDL_IO_PORT_8_2	Port pin P8 ₂	PDL_IO_PORT_D_2	Port pin PD ₂
PDL_IO_PORT_3_5	Port pin P3 ₅	PDL_IO_PORT_8_3	Port pin P8 ₃	PDL_IO_PORT_D_3	Port pin PD ₃
PDL_IO_PORT_3_6	Port pin P3 ₆	PDL_IO_PORT_8_4	Port pin P8 ₄	PDL_IO_PORT_D_4	Port pin PD ₄
PDL_IO_PORT_3_7	Port pin P3 ₇	PDL_IO_PORT_8_5	Port pin P8 ₅	PDL_IO_PORT_D_5	Port pin PD ₅
		PDL_IO_PORT_8_6	Port pin P8 ₆	PDL_IO_PORT_D_6	Port pin PD ₆
PDL_IO_PORT_4_0	Port pin P4 ₀	PDL_IO_PORT_8_7	Port pin P8 ₇	PDL_IO_PORT_D_7	Port pin PD ₇
PDL_IO_PORT_4_1	Port pin P4 ₁				
PDL_IO_PORT_4_2	Port pin P4 ₂	PDL_IO_PORT_9_0	Port pin P9 ₀	PDL_IO_PORT_E_0	Port pin PE ₀
PDL_IO_PORT_4_3	Port pin P4 ₃	PDL_IO_PORT_9_1	Port pin P9 ₁	PDL_IO_PORT_E_1	Port pin PE ₁
PDL_IO_PORT_4_4	Port pin P4 ₄	PDL_IO_PORT_9_2	Port pin P9 ₂	PDL_IO_PORT_E_2	Port pin PE ₂
PDL_IO_PORT_4_5	Port pin P4 ₅	PDL_IO_PORT_9_3	Port pin P9 ₃	PDL_IO_PORT_E_3	Port pin PE ₃
PDL_IO_PORT_4_6	Port pin P4 ₆	PDL_IO_PORT_9_4	Port pin P9 ₄	PDL_IO_PORT_E_4	Port pin PE ₄
PDL_IO_PORT_4_7	Port pin P4 ₇	PDL_IO_PORT_9_5	Port pin P9 ₅	PDL_IO_PORT_E_5	Port pin PE ₅
		PDL_IO_PORT_9_6	Port pin P9 ₆	PDL_IO_PORT_E_6	Port pin PE ₆
		PDL_IO_PORT_9_7	Port pin P9 ₇	PDL_IO_PORT_E_7	Port pin PE ₇

PDL_IO_PORT_F_0	Port pin PF ₀	PDL_IO_PORT_G_0	Port pin PG ₀	PDL_IO_PORT_K_0	Port pin PK ₀
PDL_IO_PORT_F_1	Port pin PF ₁	PDL_IO_PORT_G_1	Port pin PG ₁	PDL_IO_PORT_K_1	Port pin PK ₁
PDL_IO_PORT_F_2	Port pin PF ₂	PDL_IO_PORT_G_2	Port pin PG ₂	PDL_IO_PORT_K_2	Port pin PK ₂
PDL_IO_PORT_F_3	Port pin PF ₃	PDL_IO_PORT_G_3	Port pin PG ₃	PDL_IO_PORT_K_3	Port pin PK ₃
PDL_IO_PORT_F_4	Port pin PF ₄	PDL_IO_PORT_G_4	Port pin PG ₄	PDL_IO_PORT_K_4	Port pin PK ₄
PDL_IO_PORT_F_5	Port pin PF ₅	PDL_IO_PORT_G_5	Port pin PG ₅	PDL_IO_PORT_K_5	Port pin PK ₅
		PDL_IO_PORT_G_6	Port pin PG ₆	PDL_IO_PORT_K_6	Port pin PK ₆
		PDL_IO_PORT_G_7	Port pin PG ₇	PDL_IO_PORT_K_7	Port pin PK ₇
		PDL_IO_PORT_H_4	Port pin PH ₄	PDL_IO_PORT_L_0	Port pin PL ₀
		PDL_IO_PORT_H_5	Port pin PH ₅	PDL_IO_PORT_L_1	Port pin PL ₁
				PDL_IO_PORT_L_2	Port pin PL ₂
		PDL_IO_PORT_J_3	Port pin PJ ₃	PDL_IO_PORT_L_3	Port pin PL ₃
		PDL_IO_PORT_J_5	Port pin PJ ₅	PDL_IO_PORT_L_4	Port pin PL ₄

Note: Refer to the hardware manual for the port pins which are available on the device that you have selected.

1) R_IO_PORT_Set

Synopsis

Configure an I/O port.

Prototype

```
bool R_IO_PORT_Set(
    uint16_t data1, // Port pin selection
    uint16_t data2 // Configuration
);
```

Description

Set the operating conditions for I/O port pins.

[data1]

Select the port pins to be configured (from §4.2.3). Do not use any whole-port definitions. Multiple pins on the same port may be specified, using “|” to separate each pin.

[data2]

Choose the pin settings. Use “|” to separate each selection.

Each selection is optional. If a selection is not made, the control setting will be left unchanged.

- Direction control

PDL_IO_PORT_INPUT or PDL_IO_PORT_OUTPUT	Input or output.
---	------------------

- Output type control

PDL_IO_PORT_TYPE_CMOS or PDL_IO_PORT_TYPE_NMOS or	Select CMOS push-pull output, N-channel open-drain	Available on all pins.
PDL_IO_PORT_TYPE_PMOS	P-channel open-drain	Available on pin PE1 only.

- Input pull-up resistor control

PDL_IO_PORT_PULL_UP_ON or PDL_IO_PORT_PULL_UP_OFF	On or off.
---	------------

- Drive capacity control

PDL_IO_PORT_DRIVE_NORMAL or PDL_IO_PORT_DRIVE_HIGH	Normal or high-current drive. Valid for ports 0, 2, 5 to 7, 9 to E and G.
--	---

Return value

True if all parameters are valid and exclusive; otherwise false.

Category

I/O port

References

R_IO_PORT_NotAvailable

Remarks

- Ensure that the specified functions are valid for the selected port pin.
- The data direction and mode registers may be modified by other driver functions. Take care to not overwrite existing settings.
- Pin P35 is fixed as an input and cannot be modified.
- All pins that are not available on the selected package can be set to the required state using the R_IO_PORT_NotAvailable function.
- Refer to the hardware manual Table 21.1 for the available pins open drain control setting.

Program example

```
/* RPDL definitions */
#include "r_pdl_io_port.h"

/* RPDL device-specific definitions */
#include "r_pdl_definitions.h"

void func(void)
{
    /* Set up port P13 as an input port with the pull-up on */
    R_IO_PORT_Set(
        PDL_IO_PORT_1_3,
        PDL_IO_PORT_INPUT | PDL_IO_PORT_PULL_UP_ON
    );
}
```

2) R_IO_PORT_ReadControl

Synopsis

Read an I/O port's control register.

Prototype

```
bool R_IO_PORT_ReadControl(
    uint16_t data1, // Port or port pin selection
    uint8_t data2, // Control register selection
    uint16_t * data3 // Data storage location
);
```

Description

Read an I/O port pin control setting.

[data1]

Use either one of the following definition values (from §4.2.3).

- One port definition or
- One port pin definition.

[data2]

- Select the register to be read.

PDL_IO_PORT_DIRECTION or	Data direction.
PDL_IO_PORT_MODE or	General or Peripheral I/O mode control.
PDL_IO_PORT_TYPE or	Open-drain control.
PDL_IO_PORT_PULL_UP or	Pull-up control.
PDL_IO_PORT_DRIVE	Drive capacity control. Valid for ports 0, 2, 5 to 7, 9 to E and G.

[data3]

The address where the register value shall be stored, using one of the formats below.

Pin (not PE1 open-drain control):

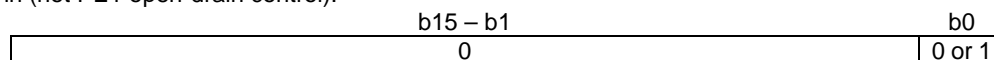

Pin PE1 open-drain control:

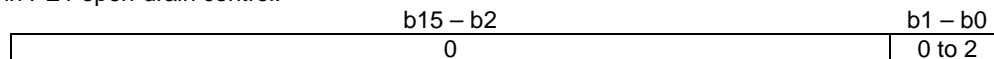

Port (not open-drain control):

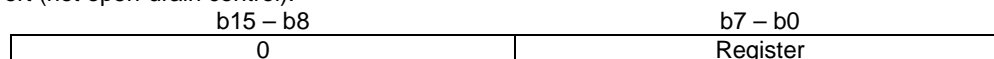

Port (open-drain control)

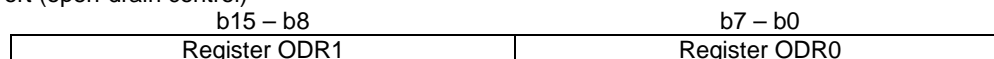

Return value

True if all parameters are valid and exclusive; otherwise false.

Category

I/O port

References

None.

Remarks

- Ensure that the specified register is valid for the selected port or port pin.
- Refer to the hardware manual Table 21.1 for the available pins open drain control reading.

Program example

```
/* RPD_L definitions */
#include "r_pdl_io_port.h"

/* RPD_L device-specific definitions */
#include "r_pdl_definitions.h"

void func(void)
{
    uint16_t result;

    /* Read the direction register for port C */
    R_IO_PORT_ReadControl(
        PDL_IO_PORT_C,
        PDL_IO_PORT_DIRECTION,
        &result
    );

    /* Read the output type for pin P13 */
    R_IO_PORT_ReadControl(
        PDL_IO_PORT_1_3,
        PDL_IO_PORT_TYPE,
        &result
    );
}
```

3) R_IO_PORT_ModifyControl

Synopsis Modify an I/O port's control registers.

Prototype

```
bool R_IO_PORT_ModifyControl(
    uint16_t data1, // Port or port pin selection
    uint8_t data2, // Control register and logical operation selection
    uint16_t data3 // Modification value
);
```

Description Modifying the operation of an I/O port or I/O port pin.

[data1]
Use either one of the following definition values (from §4.2.3).

- One port definition or
- One port pin definition.

[data2]
Select the register to be modified and the logical operation, using “|” to separate the selections.

- The control register to be modified.

PDL_IO_PORT_DIRECTION or	Data direction.
PDL_IO_PORT_MODE or	General or Peripheral I/O mode control.
PDL_IO_PORT_TYPE or	Open-drain control.
PDL_IO_PORT_PULL_UP or	Pull-up control.
PDL_IO_PORT_DRIVE	Drive capacity control. Valid for ports 0, 2, 5 to 7, 9 to E and G.

- The logical operation to be applied to the control register.

PDL_IO_PORT_AND or PDL_IO_PORT_OR or PDL_IO_PORT_XOR	Select between AND (&), OR () or Exclusive-OR (^).
--	---

[data3]
The value to be used for the modification, using one of the formats below.
Pin (not PE1 open-drain) control:

b15 – b1	b0
Do not care	0 or 1

Pin PE1 open-drain control:

b15 – b2	b1 – b0
Do not care	0 to 3

Port (not open-drain) control:

b15 – b8	b7 – b0
Do not care	Register

Port (open-drain) control:

b15 – b8	b7 – b0
Register ODR1	Register ODR0

Return value True if all parameters are valid and exclusive; otherwise false.

Category I/O port

References None.

Remarks

- Ensure that the specified functions are valid for the selected port pin.
- The data direction and mode registers may be modified by other driver Create functions. Take care to not overwrite existing settings.
- Pin P35 is fixed as an input and cannot be modified.
- Refer to the hardware manual Table 21.1 for the available pins open drain control modification.

Program example

```
/* RPD_L definitions */
#include "r_pdl_io_port.h"

/* RPD_L device-specific definitions */
#include "r_pdl_definitions.h"

void func(void)
{
    /* Set the lower 4 bits on port P1 to output */
    R_IO_PORT_ModifyControl(
        PDL_IO_PORT_1,
        PDL_IO_PORT_DIRECTION | PDL_IO_PORT_OR,
        0x0F
    );

    /* Enable the pull-up on pin PA3 */
    R_IO_PORT_ModifyControl(
        PDL_IO_PORT_A_3,
        PDL_IO_PORT_PULL_UP | PDL_IO_PORT_OR,
        1
    );

    /* change PE1 from N-channel open-drain output to P-channel open-drain
    output */
    R_IO_PORT_ModifyControl(
        PDL_IO_PORT_E_1,
        PDL_IO_PORT_TYPE | PDL_IO_PORT_XOR,
        0x03
    );
}
```

4) R_IO_PORT_Read

Synopsis

Read data from an I/O port.

Prototype

```
bool R_IO_PORT_Read(
    uint16_t data1, // Port or port pin selection
    uint8_t * data2 // Pointer to the variable in which the value shall be stored.
);
```

Description

Gets the value of an I/O port or I/O port pin.

[data1]

Use either one of the following definition values (from §4.2.3).

- One port definition or
- One port pin definition.

[data2]

The value will be between 0x00 and 0xFF for a port, 0 or 1 for a pin.

Return value

If the I/O port specification is incorrect, false is returned; otherwise, true is returned.

Category

I/O port

Reference

R_IO_PORT_Set

Remarks

- If an invalid port or pin is specified, the operation of the function cannot be guaranteed.
- The input buffer for the specified port or pin must be switched on (see R_IO_PORT_Set).

Program example

```
/* RPDFL definitions */
#include "r_pdl_io_port.h"

/* RPDFL device-specific definitions */
#include "r_pdl_definitions.h"

void func( void )
{
    uint8_t data;

    /* Get the value of port pin P12 */
    R_IO_PORT_Read(
        PDL_IO_PORT_1_2,
        &data
    );

    /* Get the value of port 4 */
    R_IO_PORT_Read(
        PDL_IO_PORT_4,
        &data
    );
}
```

5) R_IO_PORT_Write

Synopsis

Write data to an I/O port.

Prototype

```
bool R_IO_PORT_Write(
    uint16_t data1, // Port or port pin selection
    uint8_t data2   // The data to be written to the I/O port or port pin.
);
```

Description

Write data to an I/O port or I/O port pin.

[data1]

Use either one of the following definition values (from §4.2.3).

- One port definition or
- One port pin definition.

[data2]

The value must be between 0x00 and 0xFF for a port, 0 or 1 for a pin.

Return value

True if the parameters are valid; otherwise false.

Category

I/O port

References

None.

Remarks

- If an invalid port or pin is specified, the operation of the function cannot be guaranteed.

Program example

```
/* RPD_L definitions */
#include "r_pdl_io_port.h"

/* RPD_L device-specific definitions */
#include "r_pdl_definitions.h"

void func( void )
{
    /* Set the output of port pin P05 */
    R_IO_PORT_Write(
        PDL_IO_PORT_0_5,
        0
    );

    /* Set the output of port 6 */
    R_IO_PORT_Write(
        PDL_IO_PORT_6,
        0x55
    );
}
```

6) R_IO_PORT_Compare

Synopsis

Check the pin states on an I/O port.

Prototype

```
bool R_IO_PORT_Compare(
    uint16_t data1, // Input port or port pin selection
    uint8_t data2, // Comparison value
    void * func     // Function pointer
);
```

Description

Read the input state of an I/O port or I/O port pin and call a function if a match occurs.

[data1]

Use either one of the following definition values (from §4.2.3):

- One port definition or
- One port pin definition.

[data2]

The value to be compared with; Between 0x00 and 0xFF for a port, 0 or 1 for a pin.

[func]

The function to be called if a match occurs.

Return value

True if the parameters are valid; otherwise false.

Category

I/O port

References

R_IO_PORT_Set

Remarks

- If an invalid port or pin is specified, the operation of the function cannot be guaranteed.
- The input buffer for the specified port or pin must be switched on (see R_IO_PORT_Set).

Program example

```
/* RPDL definitions */
#include "r_pdl_io_port.h"

/* RPDL device-specific definitions */
#include "r_pdl_definitions.h"

void IoHandler1(void){}
void IoHandler2(void){}

void func( void )
{
    /* Call function IoHandler1 if port pin P05 is high */
    R_IO_PORT_Compare(
        PDL_IO_PORT_0_5,
        1,
        IoHandler1
    );

    /* Call function IoHandler2 if port 6 reads as 0x55 */
    R_IO_PORT_Compare(
        PDL_IO_PORT_6,
        0x55,
        IoHandler2
    );
}
```

7) R_IO_PORT_Modify

Synopsis

Modify the pin states on an I/O port.

Prototype

```
bool R_IO_PORT_Modify(
    uint16_t data1, // Output port or port pin selection
    uint16_t data2, // Logical operation
    uint8_t data3   // Modification value
);
```

Description

Read the output state of an I/O port or I/O port pin, modify the result and write it back to the port.

[data1]

Use either one of the following definition values (from §4.2.3).

- One port definition or
- One port pin definition.

[data2]

- The logical operation to be applied to the port or port pin.

PDL_IO_PORT_AND or PDL_IO_PORT_OR or PDL_IO_PORT_XOR	Select between AND (&), OR () or Exclusive-OR (^).
--	---

[data3]

The value to be used for the modification; Between 0x00 and 0xFF for a port, 0 or 1 for a pin.

Return value

True if the parameters are valid; otherwise false.

Category

I/O port

References

None.

Remarks

- If an invalid port or pin is specified, the operation of the function cannot be guaranteed.

Program example

```
/* RPDL definitions */
#include "r_pdl_io_port.h"

/* RPDL device-specific definitions */
#include "r_pdl_definitions.h"

void func( void )
{
    /* Invert port pin P05 */
    R_IO_PORT_Modify(
        PDL_IO_PORT_0_5,
        PDL_IO_PORT_XOR,
        1
    );

    /* And the value port 6 with 0x55 */
    R_IO_PORT_Modify(
        PDL_IO_PORT_6,
        PDL_IO_PORT_AND,
        0x55
    );
}
```

8) R_IO_PORT_Wait

Synopsis

Wait for a match on an I/O port.

Prototype

```
bool R_IO_PORT_Wait(
    uint16_t data1, // Output port or port pin selection
    uint8_t data2  // Comparison value
);
```

Description

Loop until an I/O port or I/O port pin matches the comparison value.

[data1]

Use either one of the following definition values (from §4.2.3).

- One port definition or
- One port pin definition.

[data2]

The value to be compared with; Between 0x00 and 0xFF for a port, 0 or 1 for a pin.

Return value

True if the parameters are valid; otherwise false.

Category

I/O port

References

R_IO_PORT_Set

Remarks

- If an invalid port or pin is specified, the operation of the function cannot be guaranteed.
- This function waits for the I/O port or port pin value to match the comparison data. If the I/O port's control registers are directly modified by the user, this function may lock up.
- The input buffer for the specified port or pin must be switched on (see R_IO_PORT_Set).

Program example

```
/* RPDL definitions */
#include "r_pdl_io_port.h"

/* RPDL device-specific definitions */
#include "r_pdl_definitions.h"

void func( void )
{
    /* Wait until pin P05 reads as 0 */
    R_IO_PORT_Wait(
        PDL_IO_PORT_0_5,
        0
    );

    /* Wait until port 6 reads as 0x55 */
    R_IO_PORT_Wait(
        PDL_IO_PORT_6,
        0x55
    );
}
```

9) R_IO_PORT_NotAvailable**Synopsis**

Configure I/O port pins that are not available.

Prototype

```
bool R_IO_PORT_NotAvailable(  
    void // No parameter is required  
);
```

Description

Set the port pins that are not available on smaller packages to the recommended state.

Return value

True.

Category

I/O port

References**Remarks**

- All pins that are not available on the selected package will be configured for CMOS-type low-level output.

Program example

```
/* RPDL definitions */  
#include "r_pdl_io_port.h"  
  
/* RPDL device-specific definitions */  
#include "r_pdl_definitions.h"  
  
void func( void )  
{  
    /* Set all reserved I/O port pins to the recommended state */  
    R_IO_PORT_NotAvailable();  
}
```

10) R_IO_PORT_Switch

Synopsis

Modify an I/O port's switch registers.

Prototype

```
bool R_IO_PORT_Switch(
    uint16_t data1 // PORT switch option selection
);
```

Description

Modifying an I/O port's switch registers.

[data1]

PORT Switch option selection.

All selections are optional. If no change is required, specify PDL_NO_DATA.

If multiple selections are required, use "|" to separate each selection.

- PORT Switch option selection. Valid on packages with 48 pins

PDL_IO_PORT_SWITCH_PC0_TO_PB0 or PDL_IO_PORT_SWITCH_PB0_TO_PC0	Selects the PB0 general I/O port Function Selects the PC0 general I/O port function
PDL_IO_PORT_SWITCH_PC1_TO_PB1 or PDL_IO_PORT_SWITCH_PB1_TO_PC1	Selects the PB1 general I/O port Function Selects the PC1 general I/O port function
PDL_IO_PORT_SWITCH_PC2_TO_PB3 or PDL_IO_PORT_SWITCH_PB3_TO_PC2	Selects the PB3 general I/O port Function Selects the PC2 general I/O port function
PDL_IO_PORT_SWITCH_PC3_TO_PB5 or PDL_IO_PORT_SWITCH_PB5_TO_PC3	Selects the PB5 general I/O port Function Selects the PC3 general I/O port function

- PORT Switch option selection. Valid on packages with 64 pins

PDL_IO_PORT_SWITCH_PC0_TO_PB6 or PDL_IO_PORT_SWITCH_PB6_TO_PC0	Selects the PB6 general I/O port Function Selects the PC0 general I/O port function
PDL_IO_PORT_SWITCH_PC1_TO_PB7 or PDL_IO_PORT_SWITCH_PB7_TO_PC1	Selects the PB7 general I/O port Function Selects the PC1 general I/O port function

Return value

True if all parameters are valid and exclusive; otherwise false.

Category

I/O port

References

R_IO_PORT_NotAvailable

Remarks

- Valid on packages with 64 pins or less
- This function will reset registers PMR, PDR, and PCR to 0 for the pins selected.

Program example

```
/* RPDL definitions */
#include "r_pdl_io_port.h"

/* RPDL device-specific definitions */
#include "r_pdl_definitions.h"

void func(void)
{
    #if defined (DEVICE_PACKAGE_48_PIN)
        /* select PC0 ~ PC3 general I/O pin function*/
        R_IO_PORT_Switch(
            PDL_IO_PORT_SWITCH_PB0_TO_PC0 | PDL_IO_PORT_SWITCH_PB1_TO_PC1 |
            PDL_IO_PORT_SWITCH_PB3_TO_PC2 | PDL_IO_PORT_SWITCH_PB5_TO_PC3
        );
    #endif

    #if defined (DEVICE_PACKAGE_64_PIN)
        /* select PB7 and PC0 general I/O pin function*/
        R_IO_PORT_Switch(
            PDL_IO_PORT_SWITCH_PC1_TO_PB7 | PDL_IO_PORT_SWITCH_PB6_TO_PC0
        );
    #endif
}
```

4.2.4. Multifunction Pin Controller

The peripheral functions can be assigned to different pins, controlled by the Multifunction Pin Controller. The definitions available to the MPC functions are listed below.

MPC register definitions

PDL_MPC_REG_P00PFS	PDL_MPC_REG_P60PFS	PDL_MPC_REG_PC0PFS
PDL_MPC_REG_P01PFS	PDL_MPC_REG_P61PFS	PDL_MPC_REG_PC1PFS
PDL_MPC_REG_P02PFS	PDL_MPC_REG_P66PFS	PDL_MPC_REG_PC2PFS
PDL_MPC_REG_P03PFS	PDL_MPC_REG_P67PFS	PDL_MPC_REG_PC3PFS
PDL_MPC_REG_P05PFS	PDL_MPC_REG_P70PFS	PDL_MPC_REG_PC4PFS
PDL_MPC_REG_P07PFS	PDL_MPC_REG_P71PFS	PDL_MPC_REG_PC5PFS
PDL_MPC_REG_P10PFS	PDL_MPC_REG_P72PFS	PDL_MPC_REG_PC6PFS
PDL_MPC_REG_P11PFS	PDL_MPC_REG_P73PFS	PDL_MPC_REG_PC7PFS
PDL_MPC_REG_P12PFS	PDL_MPC_REG_P74PFS	PDL_MPC_REG_PD0PFS
PDL_MPC_REG_P13PFS	PDL_MPC_REG_P75PFS	PDL_MPC_REG_PD1PFS
PDL_MPC_REG_P14PFS	PDL_MPC_REG_P76PFS	PDL_MPC_REG_PD2PFS
PDL_MPC_REG_P15PFS	PDL_MPC_REG_P77PFS	PDL_MPC_REG_PD3PFS
PDL_MPC_REG_P16PFS	PDL_MPC_REG_P80PFS	PDL_MPC_REG_PD4PFS
PDL_MPC_REG_P17PFS	PDL_MPC_REG_P81PFS	PDL_MPC_REG_PD5PFS
PDL_MPC_REG_P20PFS	PDL_MPC_REG_P82PFS	PDL_MPC_REG_PD6PFS
PDL_MPC_REG_P21PFS	PDL_MPC_REG_P83PFS	PDL_MPC_REG_PD7PFS
PDL_MPC_REG_P22PFS	PDL_MPC_REG_P86PFS	PDL_MPC_REG_PE0PFS
PDL_MPC_REG_P23PFS	PDL_MPC_REG_P87PFS	PDL_MPC_REG_PE1PFS
PDL_MPC_REG_P24PFS	PDL_MPC_REG_P90PFS	PDL_MPC_REG_PE2PFS
PDL_MPC_REG_P25PFS	PDL_MPC_REG_P91PFS	PDL_MPC_REG_PE3PFS
PDL_MPC_REG_P26PFS	PDL_MPC_REG_P92PFS	PDL_MPC_REG_PE4PFS
PDL_MPC_REG_P27PFS	PDL_MPC_REG_P93PFS	PDL_MPC_REG_PE5PFS
PDL_MPC_REG_P30PFS	PDL_MPC_REG_PA0PFS	PDL_MPC_REG_PE6PFS
PDL_MPC_REG_P31PFS	PDL_MPC_REG_PA1PFS	PDL_MPC_REG_PE7PFS
PDL_MPC_REG_P32PFS	PDL_MPC_REG_PA2PFS	PDL_MPC_REG_PF0PFS
PDL_MPC_REG_P33PFS	PDL_MPC_REG_PA3PFS	PDL_MPC_REG_PF1PFS
PDL_MPC_REG_P34PFS	PDL_MPC_REG_PA4PFS	PDL_MPC_REG_PF2PFS
PDL_MPC_REG_P40PFS	PDL_MPC_REG_PA5PFS	PDL_MPC_REG_PF5PFS
PDL_MPC_REG_P41PFS	PDL_MPC_REG_PA6PFS	PDL_MPC_REG_PJ3PFS
PDL_MPC_REG_P42PFS	PDL_MPC_REG_PA7PFS	PDL_MPC_REG_PFCSE
PDL_MPC_REG_P43PFS	PDL_MPC_REG_PB0PFS	PDL_MPC_REG_PFCSS0
PDL_MPC_REG_P44PFS	PDL_MPC_REG_PB1PFS	PDL_MPC_REG_PFCSS1
PDL_MPC_REG_P45PFS	PDL_MPC_REG_PB2PFS	PDL_MPC_REG_PFAOE0
PDL_MPC_REG_P46PFS	PDL_MPC_REG_PB3PFS	PDL_MPC_REG_PFAOE1
PDL_MPC_REG_P47PFS	PDL_MPC_REG_PB4PFS	PDL_MPC_REG_PFBCR0
PDL_MPC_REG_P50PFS	PDL_MPC_REG_PB5PFS	PDL_MPC_REG_PFBCR1
PDL_MPC_REG_P51PFS	PDL_MPC_REG_PB6PFS	PDL_MPC_REG_PFENET
PDL_MPC_REG_P52PFS	PDL_MPC_REG_PB7PFS	PDL_MPC_REG_PFUSB0
PDL_MPC_REG_P54PFS		PDL_MPC_REG_PFUSB1
PDL_MPC_REG_P55PFS		
PDL_MPC_REG_P56PFS		
PDL_MPC_REG_P57PFS		

1) R_MPC_Read

Synopsis

Read an MPC register.

Prototype

```
bool R_MPC_Read(
    uint8_t data1, // MPC register selection
    uint8_t * data2 // Pointer to the variable where the MPC register's value shall be stored.
);
```

Description

Get the value of an MPC register.

[data1]

One of the definition values from §4.2.4.

[data2]

The value read from the register.

Return value

True if a valid MPC register is specified; otherwise false.

Category

MPC registers

References

None.

Remarks

- None.

Program example

```
/* RPD_L definitions */
#include "r_pdl_mpc.h"

/* RPD_L device-specific definitions */
#include "r_pdl_definitions.h"

void func( void )
{
    uint8_t data;

    /* Get the value of register PFCSE */
    R_MPC_Read(
        PDL_MPC_REG_PFCSE,
        &data
    );
}
```

2) R_MPC_Write

Synopsis

Write to a MPC register.

Prototype

```
bool R_MPC_Write(
    uint8_t data1, // MPC register selection
    uint8_t data2  // Data to be written to the MPC register
);
```

Description

Write the value to an MPC register.

[data1]

One of the definition values from §4.2.4.

[data2]

The value to be written to the register.

Return value

True if a valid MPC register is specified; otherwise false.

Category

MPC registers

References

None.

Remarks

- The MPC registers are modified by other driver functions. Take care to not overwrite existing settings.
- Refer to the hardware manual for valid values for each register.

Program example

```
/* RPDL definitions */
#include "r_pdl_mpc.h"

/* RPDL device-specific definitions */
#include "r_pdl_definitions.h"

void func( void )
{
    /* Write data to register PD1PFS */
    R_MPC_Write(
        PDL_MPC_REG_PD1PFS,
        0xFF
    );
}
```

3) R_MPC_Modify**Synopsis**

Modify an MPC register.

Prototype

```
bool R_MPC_Modify(
    uint8_t data1, // MPC register selection
    uint8_t data2, // Logical operation
    uint8_t data3  // Modification value
);
```

Description

Write the value to an MPC register.

[data1]

One of the definition values from §4.2.4.

[data2]

- The logical operation to be applied to the register contents.

PDL_MPC_AND or PDL_MPC_OR or PDL_MPC_XOR	Select between AND (&), OR () or Exclusive-OR (^).
--	---

[data3]

The value to be used for the modification.

Return value

True if a valid MPC register is specified; otherwise false.

Category

MPC registers

References

None.

Remarks

- The MPC registers are modified by other driver functions. Take care to not overwrite existing settings.
- Refer to the hardware manual for valid values for each register.

Program example

```
/* RPDL definitions */
#include "r_pdl_mpc.h"

/* RPDL device-specific definitions */
#include "r_pdl_definitions.h"

void func( void )
{
    /* Set bit 7 in PFBCR0 to 1 */
    R_MPC_Modify(
        PDL_MPC_REG_PFBCR0,
        PDL_MPC_OR,
        0x80
    );
}
```

4.2.5. MCU operation

1) R_MCU_Control

Synopsis

Control the operation of the MCU.

Prototype

```
bool R_MCU_Control(
    uint8_t data // Control options
);
```

Description

Modify the MCU control registers.

[data]

Select the operation states. All selections are optional.

If multiple selections are required, use "|" to separate each selection.

- On-chip ROM control

PDL_MCU_ROM_ENABLE or PDL_MCU_ROM_DISABLE	Enable or disable the on-chip ROM.
--	------------------------------------

- Software reset control

PDL_MCU_RESET_START	Start a software reset of the MCU.
---------------------	------------------------------------

- Start type flag control

PDL_MCU_WARM_START	Set the Start type status flag to Warm.
--------------------	---

Return value

True if a valid register is specified; otherwise false.

Category

MCU registers

References

R_CGC_Set, R_RTC_Create

Remarks

- The PDL_MCU_WARM_START is used after the initialization of cold start (caused by a power-on reset) has completed. This is to indicate the next reset processing is warm start. (Caused by a reset signal during operation).

Program example

```
/* RPDL definitions */
#include "r_pdl_mcu.h"

/* RPDL device-specific definitions */
#include "r_pdl_definitions.h"

void func( void )
{
    /* Modify the MCU operation */
    R_MCU_Control(
        PDL_MCU_ROM_DISABLE
    );
}
```

2) R_MCU_GetStatus

Synopsis Read the MCU status.

Prototype

```
bool R_MCU_GetStatus(
    uint16_t * data1, // The location where the mode status flags shall be stored
    uint16_t * data2, // The location where the reset status flags shall be stored
    uint32_t * data3, // The storage location for the Option Function Select Register 0
    uint32_t * data4  // The storage location for the Option Function Select Register 1
);
```

Description Read the status registers for the MCU.

[data1]
The status flags shall be stored in the format below.
Specify PDL_NO_PTR if they are not required.

	b15 – b14	b13	b12 – b9	b8
0	User boot mode		0	1
	0: Other 1: Selected			

	b7 – b5	b4 – b1	b0
	Endian mode	0	MD pin level at release from reset
	000b: Big 111b: Little		0: Low 1: High

[data2]
The reset status flags shall be stored in the format below.
Specify PDL_NO_PTR if they are not required.

	b8
0	Start type
	0: Cold 1: Warm

	b7	b6	b5	b4	b3	b2	b1	b0
	Reset detection flags (0: not detected; 1: detected)							
Exit from deep software standby	Software	WDT	IWDT	Voltage monitor			Power-on	
				2	1	0		

[data3]
Where the OFS0 register contents shall be stored.
Please refer to the MCU hardware manual for the format.
Specify PDL_NO_PTR if they are not required.

[data4]
Where the OFS1 register contents shall be stored.
Please refer to the MCU hardware manual for the format.
Specify PDL_NO_PTR if they are not required.

Return value True.

Category MCU registers

References None.

Remarks

- If a reset detection flag is set to 1, it shall be automatically cleared to 0 by this function.

Program example

```
/* RPDL definitions */
#include "r_pdl_mcu.h"

/* RPDL device-specific definitions */
#include "r_pdl_definitions.h"

void func( void )
{
    uint16_t status;

    /* Read the MCU status registers */
    R_MCU_GetStatus(
        &status,
        PDL_NO_PTR,
        PDL_NO_PTR,
        PDL_NO_PTR
    );
}
```

3) R_MCU_OFS

Synopsis

Configure the device start-up operation.

Prototype

```
R_MCU_OFS(
    uint32_t data1, // IWDT configuration options
    uint32_t data2, // WDT configuration options
    uint32_t data3, // LVD configuration options
    uint32_t data4 // CGC configuration options
);
```

Description (1/2)

Select the auto-start settings to be stored in registers OFS0 and OFS1.

[data1]

Select the post-reset IWDT configuration settings.
If multiple selections are required, use “|” to separate each selection.

- Auto-start control

PDL_MCU_OFS_IWDT_HALTED or PDL_MCU_OFS_IWDT_AUTOSTART	Disable or enable the IWDT auto-start mode.
--	---

If auto-start mode is enabled, select one setting from each of the following.

- Timeout period

PDL_MCU_OFS_IWDT_TIMEOUT_1024 or PDL_MCU_OFS_IWDT_TIMEOUT_4096 or PDL_MCU_OFS_IWDT_TIMEOUT_8192 or PDL_MCU_OFS_IWDT_TIMEOUT_16384	Timeout period specified in cycles of the divided clock as specified in the Clock division selection below.
--	---

- Clock division

PDL_MCU_OFS_IWDT_CLOCK_LOCO_1 or PDL_MCU_OFS_IWDT_CLOCK_LOCO_16 or PDL_MCU_OFS_IWDT_CLOCK_LOCO_32 or PDL_MCU_OFS_IWDT_CLOCK_LOCO_64 or PDL_MCU_OFS_IWDT_CLOCK_LOCO_128 or PDL_MCU_OFS_IWDT_CLOCK_LOCO_256	The selected clock. The LOCO ÷ 1, 16, 32, 64, 128 or 256.
--	--

- Window end position

PDL_MCU_OFS_IWDT_WIN_END_75 or PDL_MCU_OFS_IWDT_WIN_END_50 or PDL_MCU_OFS_IWDT_WIN_END_25 or PDL_MCU_OFS_IWDT_WIN_END_0	The window end position specified as a percentage of the down-counter. 0% is when the down-counter would underflow. Selecting 0% is equivalent to no window end position.
--	---

- Window start position

PDL_MCU_OFS_IWDT_WIN_START_25 or PDL_MCU_OFS_IWDT_WIN_START_50 or PDL_MCU_OFS_IWDT_WIN_START_75 or PDL_MCU_OFS_IWDT_WIN_START_100	The window start position specified as a percentage of the down-counter. 0% is when the down-counter would underflow. Selecting 100% is equivalent to no window start position.
--	---

- Underflow action

PDL_MCU_OFS_IWDT_NMI or PDL_MCU_OFS_IWDT_RESET	Select an NMI or reset when the IWDT down-counter underflows.
---	---

- Count stop mode

PDL_MCU_OFS_IWDT_STOP_DISABLE or PDL_MCU_OFS_IWDT_STOP_ENABLE	Enable or disable Count stop mode. If the Count Stop mode is enabled the IWDT counter is stopped at a transition to sleep mode, software standby mode, deep software standby mode, or all-module clock stop mode.
--	--

Description (2/2)	<p>[data2] Select the post-reset WDT configuration settings. If multiple selections are required, use “ ” to separate each selection.</p> <ul style="list-style-type: none"> Auto-start control <table border="1" style="width: 100%;"> <tr> <td style="width: 50%;">PDL_MCU_OFS_WDT_HALTED or PDL_MCU_OFS_WDT_AUTOSTART</td> <td>Disable or enable the WDT auto-start mode.</td> </tr> </table> <p>If auto-start mode is enabled, select one setting from each of the following.</p> <ul style="list-style-type: none"> Timeout period <table border="1" style="width: 100%;"> <tr> <td style="width: 50%;">PDL_MCU_OFS_WDT_TIMEOUT_1024 or PDL_MCU_OFS_WDT_TIMEOUT_4096 or PDL_MCU_OFS_WDT_TIMEOUT_8192 or PDL_MCU_OFS_WDT_TIMEOUT_16384</td> <td>Timeout period specified in cycles of the divided clock as specified in the Clock Selection below.</td> </tr> </table> Clock division <table border="1" style="width: 100%;"> <tr> <td style="width: 50%;">PDL_MCU_OFS_WDT_CLOCK_PCLK_4 or PDL_MCU_OFS_WDT_CLOCK_PCLK_64 or PDL_MCU_OFS_WDT_CLOCK_PCLK_128 or PDL_MCU_OFS_WDT_CLOCK_PCLK_512 or PDL_MCU_OFS_WDT_CLOCK_PCLK_2048 or PDL_MCU_OFS_WDT_CLOCK_PCLK_8192</td> <td>The selected clock. The PCLKB ÷ 4, 64, 128, 512, 2048 or 8192.</td> </tr> </table> Window end position <table border="1" style="width: 100%;"> <tr> <td style="width: 50%;">PDL_MCU_OFS_WDT_WIN_END_75 or PDL_MCU_OFS_WDT_WIN_END_50 or PDL_MCU_OFS_WDT_WIN_END_25 or PDL_MCU_OFS_WDT_WIN_END_0</td> <td>The window end position specified as a percentage of the down counter. 0% is when the down-counter would underflow. Selecting 0% is equivalent to no window end position.</td> </tr> </table> Window start position <table border="1" style="width: 100%;"> <tr> <td style="width: 50%;">PDL_MCU_OFS_WDT_WIN_START_25 or PDL_MCU_OFS_WDT_WIN_START_50 or PDL_MCU_OFS_WDT_WIN_START_75 or PDL_MCU_OFS_WDT_WIN_START_100</td> <td>The window start position specified as a percentage of the down counter. 0% is when the down-counter would underflow. Selecting 100% is equivalent to no window start position.</td> </tr> </table> Underflow action <table border="1" style="width: 100%;"> <tr> <td style="width: 50%;">PDL_MCU_OFS_WDT_NMI or PDL_MCU_OFS_WDT_RESET</td> <td>Select an NMI or reset when the WDT down-counter underflows.</td> </tr> </table> <p>[data3] Select the post-reset LVD configuration settings.</p> <ul style="list-style-type: none"> Auto-start control <table border="1" style="width: 100%;"> <tr> <td style="width: 50%;">PDL_MCU_OFS_LVD_0_DISABLE or PDL_MCU_OFS_LVD_0_ENABLE</td> <td>Disable or enable the Voltage monitor 0 auto-start mode.</td> </tr> </table> <p>[data4] Select the post-reset CGC configuration settings.</p> <ul style="list-style-type: none"> Auto-start control <table border="1" style="width: 100%;"> <tr> <td style="width: 50%;">PDL_MCU_OFS_CGC_HOCO_DISABLE or PDL_MCU_OFS_CGC_HOCO_ENABLE</td> <td>Disable or enable the HOCO after a reset.</td> </tr> </table> 	PDL_MCU_OFS_WDT_HALTED or PDL_MCU_OFS_WDT_AUTOSTART	Disable or enable the WDT auto-start mode.	PDL_MCU_OFS_WDT_TIMEOUT_1024 or PDL_MCU_OFS_WDT_TIMEOUT_4096 or PDL_MCU_OFS_WDT_TIMEOUT_8192 or PDL_MCU_OFS_WDT_TIMEOUT_16384	Timeout period specified in cycles of the divided clock as specified in the Clock Selection below.	PDL_MCU_OFS_WDT_CLOCK_PCLK_4 or PDL_MCU_OFS_WDT_CLOCK_PCLK_64 or PDL_MCU_OFS_WDT_CLOCK_PCLK_128 or PDL_MCU_OFS_WDT_CLOCK_PCLK_512 or PDL_MCU_OFS_WDT_CLOCK_PCLK_2048 or PDL_MCU_OFS_WDT_CLOCK_PCLK_8192	The selected clock. The PCLKB ÷ 4, 64, 128, 512, 2048 or 8192.	PDL_MCU_OFS_WDT_WIN_END_75 or PDL_MCU_OFS_WDT_WIN_END_50 or PDL_MCU_OFS_WDT_WIN_END_25 or PDL_MCU_OFS_WDT_WIN_END_0	The window end position specified as a percentage of the down counter. 0% is when the down-counter would underflow. Selecting 0% is equivalent to no window end position.	PDL_MCU_OFS_WDT_WIN_START_25 or PDL_MCU_OFS_WDT_WIN_START_50 or PDL_MCU_OFS_WDT_WIN_START_75 or PDL_MCU_OFS_WDT_WIN_START_100	The window start position specified as a percentage of the down counter. 0% is when the down-counter would underflow. Selecting 100% is equivalent to no window start position.	PDL_MCU_OFS_WDT_NMI or PDL_MCU_OFS_WDT_RESET	Select an NMI or reset when the WDT down-counter underflows.	PDL_MCU_OFS_LVD_0_DISABLE or PDL_MCU_OFS_LVD_0_ENABLE	Disable or enable the Voltage monitor 0 auto-start mode.	PDL_MCU_OFS_CGC_HOCO_DISABLE or PDL_MCU_OFS_CGC_HOCO_ENABLE	Disable or enable the HOCO after a reset.
PDL_MCU_OFS_WDT_HALTED or PDL_MCU_OFS_WDT_AUTOSTART	Disable or enable the WDT auto-start mode.																
PDL_MCU_OFS_WDT_TIMEOUT_1024 or PDL_MCU_OFS_WDT_TIMEOUT_4096 or PDL_MCU_OFS_WDT_TIMEOUT_8192 or PDL_MCU_OFS_WDT_TIMEOUT_16384	Timeout period specified in cycles of the divided clock as specified in the Clock Selection below.																
PDL_MCU_OFS_WDT_CLOCK_PCLK_4 or PDL_MCU_OFS_WDT_CLOCK_PCLK_64 or PDL_MCU_OFS_WDT_CLOCK_PCLK_128 or PDL_MCU_OFS_WDT_CLOCK_PCLK_512 or PDL_MCU_OFS_WDT_CLOCK_PCLK_2048 or PDL_MCU_OFS_WDT_CLOCK_PCLK_8192	The selected clock. The PCLKB ÷ 4, 64, 128, 512, 2048 or 8192.																
PDL_MCU_OFS_WDT_WIN_END_75 or PDL_MCU_OFS_WDT_WIN_END_50 or PDL_MCU_OFS_WDT_WIN_END_25 or PDL_MCU_OFS_WDT_WIN_END_0	The window end position specified as a percentage of the down counter. 0% is when the down-counter would underflow. Selecting 0% is equivalent to no window end position.																
PDL_MCU_OFS_WDT_WIN_START_25 or PDL_MCU_OFS_WDT_WIN_START_50 or PDL_MCU_OFS_WDT_WIN_START_75 or PDL_MCU_OFS_WDT_WIN_START_100	The window start position specified as a percentage of the down counter. 0% is when the down-counter would underflow. Selecting 100% is equivalent to no window start position.																
PDL_MCU_OFS_WDT_NMI or PDL_MCU_OFS_WDT_RESET	Select an NMI or reset when the WDT down-counter underflows.																
PDL_MCU_OFS_LVD_0_DISABLE or PDL_MCU_OFS_LVD_0_ENABLE	Disable or enable the Voltage monitor 0 auto-start mode.																
PDL_MCU_OFS_CGC_HOCO_DISABLE or PDL_MCU_OFS_CGC_HOCO_ENABLE	Disable or enable the HOCO after a reset.																
Category	MCU registers																
References	R_IWDT_Set, R_WDT_Set, R_CGC_Set																
Remarks	<ul style="list-style-type: none"> This is a macro, not a function call. There is no error checking or return value. The auto-start setting for each parameter must be selected. 																

Program example

```
/* RPDL definitions */
#include "r_pdl_mcu_ofs.h"

/* Enable the IWDT auto-start mode. */
/* Leave the WDT disabled. */
/* Enable reset at Vdet0. */
/* Leave the HOCO disabled. */
R_MCU_OFS(
    PDL_MCU_OFS_IWDT_AUTOSTART | PDL_MCU_OFS_IWDT_TIMEOUT_4096 | \
    PDL_MCU_OFS_IWDT_CLOCK_LOCO_16 | PDL_MCU_OFS_IWDT_WIN_END_50 | \
    PDL_MCU_OFS_IWDT_WIN_START_75 | PDL_MCU_OFS_IWDT_NMI | \
    PDL_MCU_OFS_IWDT_STOP_DISABLE,
    PDL_MCU_OFS_WDT_HALTED,
    PDL_MCU_OFS_LVD_0_ENABLE,
    PDL_MCU_OFS_CGC_HOCO_DISABLE
);
```

4.2.6. Voltage Detection Circuit

1) R_LVD_Create

Synopsis

Configure the voltage detection circuit.

Prototype

```
bool R_LVD_Create(
    uint16_t data1, // Monitor 1 Configuration selection
    uint16_t data2 // Monitor 2 Configuration selection
);
```

Description

Set the voltage detection configuration.

[data1]

Monitor 1 voltage detection configuration.

If the monitor is not required specify PDL_NO_DATA, otherwise use “|” to separate each selection.

• Operation.

PDL_LVD_MONITOR_ONLY or PDL_LVD_RESET_NEGATION_VCC_MORE_THAN_VDET or PDL_LVD_RESET_NEGATION_AFTER_DELAY or PDL_LVD_INTERRUPT_NMI_DETECT_RISE or PDL_LVD_INTERRUPT_NMI_DETECT_FALL or PDL_LVD_INTERRUPT_NMI_DETECT_RISE_AND_FALL	Select no action, a reset on low voltage detection or non-maskable interrupt when a specified voltage event is detected.
--	--

• Digital Filter

PDL_LVD_FILTER_DISABLE or PDL_LVD_FILTER_LOCO_DIV_1 or PDL_LVD_FILTER_LOCO_DIV_2 or PDL_LVD_FILTER_LOCO_DIV_4 or PDL_LVD_FILTER_LOCO_DIV_8	Configure the digital filter.
--	-------------------------------

[data2]

Monitor 2 voltage detection configuration.

If the monitor is not required specify PDL_NO_DATA, otherwise use “|” to separate each selection.

• Operation

PDL_LVD_MONITOR_ONLY or PDL_LVD_RESET_NEGATION_VCC_MORE_THAN_VDET or PDL_LVD_RESET_NEGATION_AFTER_DELAY or PDL_LVD_INTERRUPT_NMI_DETECT_RISE or PDL_LVD_INTERRUPT_NMI_DETECT_FALL or PDL_LVD_INTERRUPT_NMI_DETECT_RISE_AND_FALL	Select no action, a reset on low voltage detection or non-maskable interrupt when a specified voltage event is detected.
--	--

• Digital Filter

PDL_LVD_FILTER_DISABLE or PDL_LVD_FILTER_LOCO_DIV_1 or PDL_LVD_FILTER_LOCO_DIV_2 or PDL_LVD_FILTER_LOCO_DIV_4 or PDL_LVD_FILTER_LOCO_DIV_8	Configure the digital filter.
--	-------------------------------

Return value

True if the parameters are valid; otherwise false.

Category

Voltage detection circuit.

References

R_INTC_CreateExtInterrupt, R_CGC_Set, R_LPC_GetStatus, R_CGC_Control, R_LPC_Create, R_MCU_OFS

Remarks

- If a non-maskable interrupt will be generated, call R_INTC_CreateExtInterrupt to set up the NMI handler and to accept LVD-based interrupt signals.
- If using the digital filter, function R_CGC_Set must be called (with the current clock source selected) before using this function.
- If using the digital filter the LOCO clock must be enabled. Use R_CGC_Set (with the LOCO selected).
- Following a reset, function R_LPC_GetStatus can be used to see what caused the reset.
- If using a delay on Reset negation then the LOCO clock must be enabled. See R_CGC_Set or R_CGC_Control.
- Ensure Monitor 1 and 2 are in PDL_LVD_MONITOR_ONLY during flash memory programming/erasure.
- Disable the digital filter circuit when using voltage monitoring 1 and 2 circuit in software standby mode or deep software standby mode.
- Do not use the voltage detection 1 and 2 circuit in deep software standby mode, with PDL_LPC_DEEPCUT_RAM_USB_LVD. See function R_LPC_Create.
- For control of voltage monitor 0, see R_MCU_OFS.

Program example

```

/* RPDL definitions */
#include "r_pdl_lvd.h"

/* RPDL device-specific definitions */
#include "r_pdl_definitions.h"

void func( void )
{
    /* Use Monitor 2 to generate an NMI when VCC drops below 2.95 V*/
    R_LVD_Create(
        PDL_NO_DATA,
        PDL_LVD_INTERRUPT_NMI_DETECT_FALL | PDL_LVD_FILTER_DISABLE
    );
}

```

2) R_LVD_Control

Synopsis

Control the voltage detection circuit.

Prototype

```
bool R_LVD_Control(
    uint8_t data1,    // Monitor 1 control
    uint8_t data2    // Monitor 2 control
);
```

Description

Control the voltage detection configuration.

[data1]

Monitor 1 control. All selections are optional.

If multiple selections are required, use “|” to separate each selection.

If no selections are required, specify PDL_NO_DATA.

- Monitor control

PDL_LVD_DISABLE	Disable monitor 1 operation.
-----------------	------------------------------

- Flag control

PDL_LVD_CLEAR_DETECTION	Clear the monitor 1 change detection flag.
-------------------------	--

[data2]

Monitor 2 control. All selections are optional.

If multiple selections are required, use “|” to separate each selection.

If no selections are required, specify PDL_NO_DATA.

- Monitor control

PDL_LVD_DISABLE	Disable monitor 2 operation.
-----------------	------------------------------

- Flag control

PDL_LVD_CLEAR_DETECTION	Clear the monitor 2 change detection flag.
-------------------------	--

Return value

True.

Category

Voltage detection circuit

References

R_LVD_Create

Remarks

- Other operation changes require the shutdown of both voltage monitors. If such changes are required, call R_LVD_Create with the new settings.

Program example

```
/* RPDL definitions */
#include "r_pdl_lvd.h"

/* RPDL device-specific definitions */
#include "r_pdl_definitions.h"

void func( void )
{
    /* Disable monitor 1; clear the monitor 2 flag */
    R_LVD_Control(
        PDL_LVD_DISABLE,
        PDL_LVD_CLEAR_DETECTION
    );
}
```

3) R_LVD_GetStatus

Synopsis

Check the status of the voltage detection module.

Prototype

```
bool R_LVD_GetStatus(
    uint8_t * data // Status flags pointer
);
```

Description

Return the status flags.

[data]

The Monitor 1 and Monitor 2 status flag shall be stored in the following format.

b7 - b6		b5	b4	b3 - b2		b1	b0
0	Monitor 2			0	Monitor 1		
	Status		Change		Status		Change
	0: VCC < Vdet2 1: VCC ≥ Vdet2, or the monitor is disabled		0: None 1: Detected		0: VCC < Vdet1 1: VCC ≥ Vdet1, or the monitor is disabled.		0: None 1: Detected

Return value

True.

Category

LVD

Reference

R_LVD_Control, R_LVD_Create

Remarks

- Use R_LVD_Control to clear the detection flags.
- A detection flag is not valid if Monitor-only operation was selected in R_LVD_Create.

Program example

```
/* RPDL definitions */
#include "r_pdl_lvd.h"

/* RPDL device-specific definitions */
#include "r_pdl_definitions.h"

void func(void)
{
    uint8_t StatusFlags;

    /* Read the LVD status */
    R_LVD_GetStatus(
        &StatusFlags
    );
}
```

4.2.7. Frequency Measurement Circuit

1) R_MCK_Control

Synopsis

Configure the frequency measurement circuit.

Prototype

```
bool R_MCK_Control(
    uint16_t data // Reference clock selection
);
```

Description

Configure the operation of the frequency measurement circuit.

[data]

Choose the reference clock settings. Use "|" to separate each selection.

- Reference clock selection for system 1

PDL_MCK_1_DISABLE or PDL_MCK_1_REFERENCE_MTCLKD or PDL_MCK_1_REFERENCE_LOCO or PDL_MCK_1_REFERENCE_MAIN or PDL_MCK_1_REFERENCE_SUB_CLOCK	Allow normal MTU operation or select the MTCLKD pin, low-speed on-chip oscillator, main clock oscillator or sub-clock oscillator to be monitored.
--	---

- Reference clock selection for system 2

PDL_MCK_2_DISABLE or PDL_MCK_2_REFERENCE_TCLKD or PDL_MCK_2_REFERENCE_LOCO or PDL_MCK_2_REFERENCE_MAIN or PDL_MCK_2_REFERENCE_SUB_CLOCK	Allow normal TPU operation or select the TCLKD pin, low-speed on-chip oscillator, main clock oscillator or sub-clock oscillator to be monitored.
---	--

Return value

True if all parameters are valid and exclusive; otherwise false.

Category

Frequency measurement circuit

References

R_CGC_Set, R_CGC_Control

Remarks

- The clock to be compared with the reference clock is the peripheral clock PCLKB.
- Ensure that the required clocks have been enabled using R_CGC_Set. The PCLKB clock source is selected using R_CGC_Control.
- This function will temporarily enable the MTU (if a reference clock is selected for system 1) and TPU (if a reference clock is selected for system 2) modules if they were disabled.
- Call this function before configuring the MTU (system 1) or TPU (system 2) channels for frequency measurement operation.
- If both MCK systems are disabled, the MCK module is put into the low-power state. If the MTU (for system 1) and TPU (for system 2) are no longer required then disable these modules using R_MTU2_Destroy or R_TPU_Destroy function calls.
- If system 1 is disabled, the MTCLKD pin signal is available as a clock input to MTU channel 0. If system 2 is disabled, the TCLKD pin signal is available as a clock input to TPU channel 0.
- The first TGRA counter value read from the MTU or TPU modules must be discarded.

Program example

```
/* RPDL definitions */
#include "r_pdl_mck.h"

/* RPDL device-specific definitions */
#include "r_pdl_definitions.h"

void func(void)
{
    /* Select the LOCO for system 1 and the Main clock for system 2 */
    R_MCK_Control(
        PDL_MCK_1_REFERENCE_LOCO | PDL_MCK_2_REFERENCE_MAIN
    );
}
```

4.2.8. Low Power Consumption

1) R_LPC_Create

Synopsis

Configure the MCU low power conditions.

Prototype

```
bool R_LPC_Create(
    uint32_t data1, // Configuration options
    uint32_t data2, // Select deep standby interrupt
    uint32_t data3, // Select deep standby interrupt
    uint32_t data4, // Select deep standby interrupt
    uint16_t data5, // Main oscillator waiting times
    uint16_t data6, // Subclock oscillator waiting times
    uint16_t data7, // PLL waiting times
);
```

Description (1/4)

Load the registers that control module or CPU operation.

[data1]

Select the required settings.
 If multiple selections are required, use “|” to separate each selection.
 The default settings are shown in **bold**. Specify PDL_NO_DATA to use the defaults.

- Software and Deep Software Standby mode output port control

PDL_LPC_EXT_BUS_ON or PDL_LPC_EXT_BUS_HI_Z	Leave the external bus address and control signals active, or set them to the high-impedance state.
--	---
- I/O port retention control

PDL_LPC_IO_SAME or PDL_LPC_IO_DELAY	Select whether I/O port retention is cancelled when deep software standby mode is ended, or when CPU operation has resumed.
---	---
- Operating power control

PDL_LPC_HIGH_SPEED_MODE or PDL_LPC_LOW_SPEED_MODE_1 or PDL_LPC_LOW_SPEED_MODE_2	Select the operating power control mode.
--	--
- Sleep mode return clock source switching

PDL_LPC_SLEEP_RETURN_SWITCH_DISABLE or PDL_LPC_SLEEP_RETURN_SWITCH_HOCO or PDL_LPC_SLEEP_RETURN_SWITCH_MAIN	Control clock source switching at cancellation of sleep mode.
--	---
- Deep software standby control

PDL_LPC_DEEPCUT_DISABLE or PDL_LPC_DEEPCUT_RAM_USB or PDL_LPC_DEEPCUT_RAM_USB_LVD	At deep software standby mode extra power savings can be made by cutting the power to both RAM and USB or RAM, USB and LVD.
--	---

Description (2/4)

[data2]

Select the interrupt (IRQ0 to IRQ7) to cancel deep software standby mode.
The default settings are shown in **bold**. Specify PDL_NO_DATA to use the defaults.

- Deep software standby cancel control

PDL_LPC_CANCEL_IRQ0_DISABLE or PDL_LPC_CANCEL_IRQ0_FALLING or PDL_LPC_CANCEL_IRQ0_RISING	Prevent or allow an edge on the IRQ0-DS pin to cancel deep software standby mode.
PDL_LPC_CANCEL_IRQ1_DISABLE or PDL_LPC_CANCEL_IRQ1_FALLING or PDL_LPC_CANCEL_IRQ1_RISING	Prevent or allow an edge on the IRQ1-DS pin to cancel deep software standby mode.
PDL_LPC_CANCEL_IRQ2_DISABLE or PDL_LPC_CANCEL_IRQ2_FALLING or PDL_LPC_CANCEL_IRQ2_RISING	Prevent or allow an edge on the IRQ2-DS pin to cancel deep software standby mode.
PDL_LPC_CANCEL_IRQ3_DISABLE or PDL_LPC_CANCEL_IRQ3_FALLING or PDL_LPC_CANCEL_IRQ3_RISING	Prevent or allow an edge on the IRQ3-DS pin to cancel deep software standby mode.
PDL_LPC_CANCEL_IRQ4_DISABLE or PDL_LPC_CANCEL_IRQ4_FALLING or PDL_LPC_CANCEL_IRQ4_RISING	Prevent or allow an edge on the IRQ4-DS pin to cancel deep software standby mode.
PDL_LPC_CANCEL_IRQ5_DISABLE or PDL_LPC_CANCEL_IRQ5_FALLING or PDL_LPC_CANCEL_IRQ5_RISING	Prevent or allow an edge on the IRQ5-DS pin to cancel deep software standby mode.
PDL_LPC_CANCEL_IRQ6_DISABLE or PDL_LPC_CANCEL_IRQ6_FALLING or PDL_LPC_CANCEL_IRQ6_RISING	Prevent or allow an edge on the IRQ6-DS pin to cancel deep software standby mode.
PDL_LPC_CANCEL_IRQ7_DISABLE or PDL_LPC_CANCEL_IRQ7_FALLING or PDL_LPC_CANCEL_IRQ7_RISING	Prevent or allow an edge on the IRQ7-DS pin to cancel deep software standby mode.

[data3]

Select the interrupt (IRQ8 to IRQ15) to cancel deep software standby mode.
The default settings are shown in **bold**. Specify PDL_NO_DATA to use the defaults.

- Deep software standby cancel control

PDL_LPC_CANCEL_IRQ8_DISABLE or PDL_LPC_CANCEL_IRQ8_FALLING or PDL_LPC_CANCEL_IRQ8_RISING	Prevent or allow an edge on the IRQ8-DS pin to cancel deep software standby mode.
PDL_LPC_CANCEL_IRQ9_DISABLE or PDL_LPC_CANCEL_IRQ9_FALLING or PDL_LPC_CANCEL_IRQ9_RISING	Prevent or allow an edge on the IRQ9-DS pin to cancel deep software standby mode.
PDL_LPC_CANCEL_IRQ10_DISABLE or PDL_LPC_CANCEL_IRQ10_FALLING or PDL_LPC_CANCEL_IRQ10_RISING	Prevent or allow an edge on the IRQ10-DS pin to cancel deep software standby mode.
PDL_LPC_CANCEL_IRQ11_DISABLE or PDL_LPC_CANCEL_IRQ11_FALLING or PDL_LPC_CANCEL_IRQ11_RISING	Prevent or allow an edge on the IRQ11-DS pin to cancel deep software standby mode.
PDL_LPC_CANCEL_IRQ12_DISABLE or PDL_LPC_CANCEL_IRQ12_FALLING or PDL_LPC_CANCEL_IRQ12_RISING	Prevent or allow an edge on the IRQ12-DS pin to cancel deep software standby mode.
PDL_LPC_CANCEL_IRQ13_DISABLE or PDL_LPC_CANCEL_IRQ13_FALLING or PDL_LPC_CANCEL_IRQ13_RISING	Prevent or allow an edge on the IRQ13-DS pin to cancel deep software standby mode.
PDL_LPC_CANCEL_IRQ14_DISABLE or PDL_LPC_CANCEL_IRQ14_FALLING or PDL_LPC_CANCEL_IRQ14_RISING	Prevent or allow an edge on the IRQ14-DS pin to cancel deep software standby mode.
PDL_LPC_CANCEL_IRQ15_DISABLE or PDL_LPC_CANCEL_IRQ15_FALLING or PDL_LPC_CANCEL_IRQ15_RISING	Prevent or allow an edge on the IRQ15-DS pin to cancel deep software standby mode.

Description (3/4)

[data4]

Select the interrupt to cancel deep software standby mode.
The default settings are shown in **bold**. Specify PDL_NO_DATA to use the defaults.

- Deep software standby cancel control

PDL_LPC_CANCEL_LVD1_DISABLE or PDL_LPC_CANCEL_LVD1_FALLING or PDL_LPC_CANCEL_LVD1_RISING	Prevent or allow an edge on the LVD1 pin to cancel deep software standby mode.
PDL_LPC_CANCEL_LVD2_DISABLE or PDL_LPC_CANCEL_LVD2_FALLING or PDL_LPC_CANCEL_LVD2_RISING	Prevent or allow an edge on the LVD2 pin to cancel deep software standby mode.
PDL_LPC_CANCEL_RTCI_DISABLE or PDL_LPC_CANCEL_RTCI_ENABLE	Prevent or allow the RTC interval interrupt signal to cancel deep software standby mode.
PDL_LPC_CANCEL_RTCA_DISABLE or PDL_LPC_CANCEL_RTCA_ENABLE	Prevent or allow the RTC alarm interrupt signal to cancel deep software standby mode.
PDL_LPC_CANCEL_NMI_DISABLE or PDL_LPC_CANCEL_NMI_FALLING or PDL_LPC_CANCEL_NMI_RISING	Prevent or allow an edge on the NMI pin to cancel deep software standby mode.
PDL_LPC_CANCEL_IICD_DISABLE or PDL_LPC_CANCEL_IICD_FALLING or PDL_LPC_CANCEL_IICD_RISING	Prevent or allow an edge on the IIC SDA pin to cancel deep software standby mode.
PDL_LPC_CANCEL_IICC_DISABLE or PDL_LPC_CANCEL_IICC_FALLING or PDL_LPC_CANCEL_IICC_RISING	Prevent or allow an edge on the IIC SCL pin to cancel deep software standby mode.
PDL_LPC_CANCEL_USB_DISABLE or PDL_LPC_CANCEL_USB_ENABLE	Prevent or allow the USB Suspend/Resume interrupt signal to cancel deep software standby mode.
PDL_LPC_CANCEL_CAN_DISABLE or PDL_LPC_CANCEL_CAN_FALLING or PDL_LPC_CANCEL_CAN_RISING	Prevent or allow an edge on the CRX1-DS pin to cancel deep software standby mode.

[data5]

Select the main clock oscillator waiting times.
If no selections are required, specify PDL_NO_DATA.

- Software Standby waiting time

PDL_LPC_MAIN_2 or PDL_LPC_MAIN_4 or PDL_LPC_MAIN_8 or PDL_LPC_MAIN_16 or PDL_LPC_MAIN_32 or PDL_LPC_MAIN_64 or PDL_LPC_MAIN_512 or PDL_LPC_MAIN_1024 or PDL_LPC_MAIN_2048 or PDL_LPC_MAIN_4096 or PDL_LPC_MAIN_16384 or PDL_LPC_MAIN_32768 or PDL_LPC_MAIN_65536 or PDL_LPC_MAIN_131072 or PDL_LPC_MAIN_262144 or PDL_LPC_MAIN_524288	Select the oscillation settling time of the main clock oscillator before the CPU resumes after exiting from software standby mode. When updating this value, the main clock oscillator must be stopped.
--	--

Description (4/4)

[data6]

Select the sub clock oscillator waiting times.
If no selections are required, specify PDL_NO_DATA.

- Deep Software Standby waiting time

PDL_LPC_SUB_2 or PDL_LPC_SUB_4 or PDL_LPC_SUB_8 or PDL_LPC_SUB_16 or PDL_LPC_SUB_32 or PDL_LPC_SUB_64 or PDL_LPC_SUB_512 or PDL_LPC_SUB_1024 or PDL_LPC_SUB_2048 or PDL_LPC_SUB_4096 or PDL_LPC_SUB_16384 or PDL_LPC_SUB_32768 or PDL_LPC_SUB_65536 or PDL_LPC_SUB_131072 or PDL_LPC_SUB_262144 or PDL_LPC_SUB_524288	Select the oscillation settling time of the sub clock oscillator before the CPU resumes after exiting from software standby mode. When updating this value, the sub clock oscillator must be stopped.
--	--

[data7]

Select the PLL waiting times.
If no selections are required, specify PDL_NO_DATA.

- Deep Software Standby waiting time

PDL_LPC_PLL_16 or PDL_LPC_PLL_32 or PDL_LPC_PLL_64 or PDL_LPC_PLL_512 or PDL_LPC_PLL_1024 or PDL_LPC_PLL_2048 or PDL_LPC_PLL_4096 or PDL_LPC_PLL_16384 or PDL_LPC_PLL_32768 or PDL_LPC_PLL_65536 or PDL_LPC_PLL_131072 or PDL_LPC_PLL_262144 or PDL_LPC_PLL_524288 or PDL_LPC_PLL_1048576 or PDL_LPC_PLL_2097152 or PDL_LPC_PLL_4194304	Select the oscillation settling time of the PLL before the CPU resumes after exiting from software standby mode. When updating this value, the PLL circuit must be stopped.
--	--

Return value

True if all parameters are valid and exclusive; otherwise false.

Category

LPC

References

R_LPC_Control, R_CGC_Control, R_CGC_Set

Remarks

- If PDL_LPC_IO_DELAY is specified, use R_LPC_Control with the PDL_LPC_IO_RELEASE option to cancel the I/O port state retention.
- The IRQn-DS pins are the only IRQ pins that can be used to exit from deep software standby mode.
- When operating power control mode switching is in progress, do not call this function.
- When the flash memory is in program or erase mode, do not call this function if it will result in the power mode changing. This function will return false in this situation.
- During the period from the time of WAIT instruction issuance for a sleep mode transition, to return from sleep mode to normal operation, do not call this function.
- If the NMI pin is enabled for cancelling deep software standby mode, it cannot be disabled.
- Use R_CGC_Control to stop and start the clocks as required.
- When switching from normal power consumption mode to low power consumption mode, call R_CGC_Set to change the clock settings before calling this function.
- When PDL_LPC_SLEEP_RETURN_SWITCH_HOCO is selected, ensure the power to the HOCO is enabled before the transition to sleep mode is made.
- Sleep mode return clock source switching should only be enabled if using the LOCO or sub-clock during the transition to sleep mode.
- When the PLL is operating, low-speed operating mode 1 or 2 cannot be selected. This function will return false in this situation.
- The Low speed operating modes put restrictions on the allowable clock ranges for ICLK, FCLK, PCLKB and BCLK. This function will return false if any of these clocks are not within the range specified in the Hardware Manual.
- For more details of the "operating power control", please refer to the RX63N hardware manual
- If the frequency of the ICLK will be set to > 32MHz then PDL_LPC_HIGH_SPEED_MODE must be selected as the operating power control mode.
- Do not try to change operating mode if ROM Program Erase mode is set or a mode transition is already in progress. This function will return false if this is detected.

Program example

```

/* RPDL definitions */
#include "r_pdl_lpc.h"

/* RPDL device-specific definitions */
#include "r_pdl_definitions.h"

void func( void )
{
    /*Allow a falling edge on IRQ2-DS to cancel deep software standby*/
    R_LPC_Create(
        PDL_NO_DATA,
        PDL_LPC_CANCEL_IRQ2_FALLING,
        PDL_NO_DATA,
        PDL_NO_DATA,
        PDL_NO_DATA,
        PDL_NO_DATA,
        PDL_NO_DATA
    );
}

```

2) R_LPC_Control

Synopsis

Select a low power consumption mode.

Prototype

```
bool R_LPC_Control(
    uint32_t data // Mode selection
);
```

Description

Transition to one of the low power modes.

[data]

Control selection. All selections are optional. The default settings are shown in **bold**. If multiple selections are required, use “|” to separate each selection.

- Mode selection

PDL_LPC_MODE_SLEEP or PDL_LPC_MODE_ALL_MODULE_CLOCK_STOP or PDL_LPC_MODE_SOFTWARE_STANDBY or PDL_LPC_MODE_DEEP_SOFTWARE_STANDBY	Select the mode to be entered. Check the Remarks section for any restrictions.
--	--

- Operating power control

PDL_LPC_CHANGE_HIGH_SPEED or PDL_LPC_CHANGE_LOW_SPEED_1 or PDL_LPC_CHANGE_LOW_SPEED_2	Select the operating power control mode
---	---

- Sleep mode return clock source switching

PDL_LPC_SLEEP_RETURN_CHANGE_DISABLE or PDL_LPC_SLEEP_RETURN_CHANGE_HOCO or PDL_LPC_SLEEP_RETURN_CHANGE_MAIN	Control clock source switching at cancellation of sleep mode
---	--

- All-module clock stop cancellation modification

PDL_LPC_TMR_OFF or PDL_LPC_TMR_UNIT_0 or PDL_LPC_TMR_UNIT_1 or PDL_LPC_TMR_BOTH	Select whether the TMR units can be used to exit from All-module clock stop mode.
---	---

- I/O port retention cancellation

PDL_LPC_IO_RELEASE	Cancel the retention of I/O port pin states.
--------------------	--

Return value

True if all parameters are valid and exclusive; otherwise false.

Category

LPC

References

R_LPC_Create

Remarks

- Sleep mode is utilised by some peripheral drivers to turn off the CPU when required.
- When entering software standby or deep software standby mode, the oscillation stop detection function is disabled. The detection is re-enabled if software standby mode is interrupted.
- If the sub-clock oscillator is not be used, use R_CGC_Control to disable the oscillation circuit.
- On exit from deep software standby mode, the MCU is reset.
- If Sleep mode return clock source switching has been enabled, the only possible clock sources are the LOCO or sub-clock oscillator.
- Do not set up the DMACA and DTC to rewrite any registers related to WDT while the chip is in sleep mode.
- If IWDT is stopped, do not set up the DMACA and DTC to rewrite any registers related to IWDT while the chip is in sleep mode.
- If a condition for the independent watchdog timer to stop counting applied at the time of a transition to all module clock stop mode, using a reset from the independent watchdog timer to release the chip from all module clock stop mode is impossible because the independent watchdog timer is stopped.
- The peripheral Create functions bring modules out of the clock-stop state as required. The peripheral Destroy functions put modules into the clock-stop state as required. When All Module Clock-Stop mode is cancelled, the peripherals that were active when that mode was entered will be re-activated.
- When the flash memory is in program or erase mode, do not call this function if it will result in the power mode changing. This function will return false is this situation.
- When the PLL is operating, low-speed operating mode 1 or 2 cannot be selected. This function will return false is this situation.
- The Low speed operating modes put restrictions on the allowable clock ranges for ICLK, FCLK, PCLKB and BCLK. This function will return false if any of these clocks are not within the range specified in the Hardware Manual.
- If the frequency of ICLK is > 32MHz, then high-speed operating mode must be used, so do not change to a different operating mode.
- Do not try to change operating mode if ROM Program Erase mode is set or a mode transition is already in progress. This function will return false if this is detected.
- Before entering software standby or deep software standby mode, do not use option PDL_CGC_MAIN_FORCED_DISABLE in R_CGC_Control if main clock as RTC count source.

Program example

```

/* RPDL definitions */
#include "r_pdl_lpc.h"

/* RPDL device-specific definitions */
#include "r_pdl_definitions.h"

void func( void )
{
    /* Enter deep software standby mode */
    R_LPC_Control(
        PDL_LPC_MODE_DEEP_SOFTWARE_STANDBY
    );

    /* Clear the I/O port state retention */
    R_LPC_Control(
        PDL_LPC_IO_RELEASE
    );
}

```

3) R_LPC_WriteBackup

Synopsis

Write to the Backup registers.

Prototype

```
bool R_LPC_WriteBackup(
    uint8_t * data1, // Data pointer
    uint8_t data2   // Data count
);
```

Description

Write data into the backup registers.

[data1]

The data to be written to the backup area.

[data2]

The number of bytes to be written to the backup area. Valid from 1 to 32.

Return value

True if all parameters are valid; otherwise false.

Category

LPC

References

None.

Remarks

- The definition R_PDL_LPC_BACKUP_AREA_SIZE specifies the number of bytes that are available

Program example

```
/* RPDL definitions */
#include "r_pdl_lpc.h"

/* RPDL device-specific definitions */
#include "r_pdl_definitions.h"

void func( void )
{
    uint8_t data_to_save[R_PDL_LPC_BACKUP_AREA_SIZE];

    /* Write data into the backup registers */
    R_LPC_WriteBackup(
        data_to_save,
        R_PDL_LPC_BACKUP_AREA_SIZE
    );
}
```

4) R_LPC_ReadBackup

Synopsis

Read from the Backup registers.

Prototype

```
bool R_LPC_ReadBackup(
    uint8_t * data1, // Data pointer
    uint8_t data2    // Data count
);
```

Description

Read data from the backup registers.

[data1]

The storage area for the data read from the backup area.

[data2]

The number of bytes to be read from the backup area. Valid from 1 to 32.

Return value

True if all parameters are valid; otherwise false.

Category

LPC

References**Remarks**

- The definition R_PDL_LPC_BACKUP_AREA_SIZE specifies the number of bytes that are available

Program example

```
/* RPDL definitions */
#include "r_pdl_lpc.h"

/* RPDL device-specific definitions */
#include "r_pdl_definitions.h"

void func( void )
{
    uint8_t data_to_restore[R_PDL_LPC_BACKUP_AREA_SIZE];

    /* Read data from the backup registers */
    R_LPC_ReadBackup(
        data_to_restore,
        R_PDL_LPC_BACKUP_AREA_SIZE
    );
}
```

5) R_LPC_GetStatus

Synopsis Read the status flags.

Prototype `bool R_LPC_GetStatus(
 uint32_t * data1 // Data pointer
 uint8_t * data2 // Data pointer
);`

Description Read the Low power status flags.

[data1]

The status flags shall be stored in the format below.

b31 – b26	b25	b24
0	Deep Software Standby cancel request detection 0: No activity 1: CAN (RXD)	Operating Power Control Mode transition flag 0: Transition completed 1: During Transition

b23	b22 – b20	b19	b18	b17	b16
Event detection flags (0: not detected; 1: detected)					
An interrupt has caused an exit from deep software standby mode, followed by an internal reset	0	LVD2	LVD1	LVD0	Power-on reset

b15	b14	b13	b12	b11	b10	b9	b8
Deep Software Standby cancel request detection							
0: No activity							
1: The exit from deep software standby was caused by one of the following signals.							
USB	IIC (SCL)	IIC (SDA)	NMI	RTC alarm	RTC interval	LVD2	LVD1

b7	b6	b5	b4	b3	b2	b1	b0
Deep Software Standby cancel request detection							
0: No activity							
1: The exit from deep software standby was caused by one of the following signals.							
IRQ7-DS	IRQ6-DS	IRQ5-DS	IRQ4-DS	IRQ3-DS	IRQ2-DS	IRQ1-DS	IRQ0-DS

[data2]

The status flags shall be stored in the format below.

b7	b6	b5	b4	b3	b2	b1	b0
Deep Software Standby cancel request detection							
0: No activity							
1: The exit from deep software standby was caused by one of the following signals.							
IRQ15-DS	IRQ14-DS	IRQ13-DS	IRQ12-DS	IRQ11-DS	IRQ10-DS	IRQ9-DS	IRQ8-DS

Return value True.

Category LPC

References R_LPC_Create, R_LPC_Control

Remarks

- If a flag is set to 1, it shall be automatically cleared to 0 by this function (apart from the Operating Power Control Mode transition flag).

Program example

```
/* RPDL definitions */
#include "r_pdl_lpc.h"

/* RPDL device-specific definitions */
#include "r_pdl_definitions.h"

void func( void )
{
    uint32_t status_flags1;
    uint8_t status_flags2;

    /* Find out what caused the exit from deep software standby */
    R_LPC_GetStatus(
        &status_flags1,
        &status_flags2
    );
}
```

4.2.9. Register Write Protection

1) R_RWP_Control

Synopsis Control register write protection.

Prototype `bool R_RWP_Control(uint8_t data // Configuration selection);`

Description Control register write protection.

[data]
Write enable control
To set multiple options at the same time, use "|" to separate each value.

- Register write control

PDL_RWP_ENABLE_CGC_WRITE or PDL_RWP_DISABLE_CGC_WRITE	Enable or disable writing to CGC registers.
PDL_RWP_ENABLE_MODE_RESET_WRITE or PDL_RWP_DISABLE_MODE_RESET_WRITE	Enable or disable writing to Mode and Reset registers.
PDL_RWP_ENABLE_LVD_WRITE or PDL_RWP_DISABLE_LVD_WRITE	Enable or disable writing to LVD registers.
PDL_RWP_ENABLE_MPC_WRITE or PDL_RWP_DISABLE_MPC_WRITE	Enable or disable MPC Register access.

Return value True if the parameter is valid; otherwise false.

Category RWP

References

Remarks

- To allow for nested function calls, the access to the enabling / disabling of register protection is done using a reference counting method. Hence a call to disable a register access may only decrement a reference counter and not actually apply the write protection.
- Other RPD functions automatically enable and disable access to registers as required so this function is normally not required.

Program example

```

/* RPD definitions */
#include "r_pdl_rwp.h"

/* RPD device-specific definitions */
#include "r_pdl_definitions.h"

void func( void )
{
    /* Enable access to the LVD registers */
    R_RWP_Control(
        PDL_RWP_ENABLE_LVD_WRITE
    );
}
    
```

2) R_RWP_GetStatus

Synopsis Get the status of the register protection.

Prototype `bool R_RWP_GetStatus(
 uint8_t * data1, // Status flags pointer
 uint8_t * data2 // Status flags pointer
);`

Description Get the status of the register protection.

[data1]
The Protect Register (PRCR). If the value is not required, specify PDL_NO_PTR.

b7 – b4	b3	b2	b1	b0
0	LVD	0	Mode and Reset	CGC
	0: Write Disabled 1: Write Enabled		0: Write Disabled 1: Write Enabled	0: Write Disabled 1: Write Enabled

[data2]
The MPC Write Protect Register (PWPR). If the value is not required, specify PDL_NO_PTR.

b7	b6	b5 - b0
BOWI	PFSWE	0
0: Writing to the PFSWE bit is enabled 1: Writing to the PFSWE bit is disabled	0: Writing to the PFS register is disabled 1: Writing to the PFS register is enabled	

Return value True.

Category RWP

Reference None

Remarks

Program example

```

/* RPDL definitions */
#include "r_pdl_rwp.h"

/* RPDL device-specific definitions */
#include "r_pdl_definitions.h"

void func(void)
{
    uint8_t PRCR_value;
    uint8_t PWPR_value;

    /* Read the protection registers */
    R_RWP_GetStatus(
        &PRCR_value,
        &PWPR_value
    );
}

```

4.2.10. Bus Controller

1) R_BSC_Set

Synopsis

Configure the internal bus operation.

Prototype

```
bool R_BSC_Set(
    uint16_t data // Bus priority selection
);
```

Description

Configure the priority of the internal and external buses.

[data]

- Bus priority control. If multiple selections are required, use "|" to separate each selection. The default settings are shown in **bold**.

	Bus to be accessed	Priority
PDL_BSC_PRIORITY_RAM_MB2 or PDL_BSC_PRIORITY_RAM_CPU	RAM	Fixed to internal main bus 2, or toggled with the CPU bus.
PDL_BSC_PRIORITY_ROM_MB2 or PDL_BSC_PRIORITY_ROM_CPU	ROM	
PDL_BSC_PRIORITY_PB1_MB2 or PDL_BSC_PRIORITY_PB1_MB1	Peripheral 1	Fixed to internal main bus 2, or toggled with internal main bus 1.
PDL_BSC_PRIORITY_PB23_MB2 or PDL_BSC_PRIORITY_PB23_MB1	Peripheral 2 and 3	
PDL_BSC_PRIORITY_PB45_MB2 or PDL_BSC_PRIORITY_PB45_MB1	Peripheral 4 and 5	
PDL_BSC_PRIORITY_PB6_MB2 or PDL_BSC_PRIORITY_PB6_MB1	Peripheral 6	
PDL_BSC_PRIORITY_EB_MB2 or PDL_BSC_PRIORITY_EB_MB1	External	

Return value

True if all parameters are valid and exclusive; otherwise false.

Category

Bus Controller

Reference

None.

Remarks

- If it is necessary to call this function, call it once only. Ensure that both the DTC and DMAC are stopped.

Program example

```
/* RPDL definitions */
#include "r_pdl_bsc.h"

/* RPDL device-specific definitions */
#include "r_pdl_definitions.h"

void func(void)
{
    /* Toggle the priority to the Internal Peripheral Bus 1 between
       Main Bus 1 and Main Bus 2.*/
    R_BSC_Set(
        PDL_BSC_PRIORITY_PB1_MB1
    );
}
```

2) R_BSC_Create

Synopsis Configure the external bus operation.

Prototype

```
bool R_BSC_Create(
    uint32_t data1, // Bus control pin selection
    uint32_t data2, // Bus address pin selection
    uint16_t data3, // Recovery cycle insertion
    uint8_t data4,  // Error control
    void * func,   // Callback function
    uint8_t data5  // Interrupt priority level
);
```

Description (1/3) Configure the I/O pins, cycle insertion, error detection and register the callback function

[data1]
Configure the bus control signals. Use “|” to separate each selection.

- Chip select pin selection (only required for each external memory area that will be enabled).

PDL_BSC_CS0_P60 or PDL_BSC_CS0_PC7	Select the port pin to be used for signal CS0#.
PDL_BSC_CS1_P61 or PDL_BSC_CS1_P71 or PDL_BSC_CS1_PC6	Select the port pin to be used for signal CS1#.
PDL_BSC_CS2_P62 or PDL_BSC_CS2_P72 or PDL_BSC_CS2_PC5	Select the port pin to be used for signal CS2#.
PDL_BSC_CS3_P63 or PDL_BSC_CS3_P73 or PDL_BSC_CS3_PC4	Select the port pin to be used for signal CS3#.
PDL_BSC_CS4_P64 or PDL_BSC_CS4_P74 or PDL_BSC_CS4_P24	Select the port pin to be used for signal CS4#.
PDL_BSC_CS5_P65 or PDL_BSC_CS5_P75 or PDL_BSC_CS5_P25	Select the port pin to be used for signal CS5#.
PDL_BSC_CS6_P66 or PDL_BSC_CS6_P76 or PDL_BSC_CS6_P26	Select the port pin to be used for signal CS6#.
PDL_BSC_CS7_P67 or PDL_BSC_CS7_P77 or PDL_BSC_CS7_P27	Select the port pin to be used for signal CS7#.

- WAIT pin selection (only required if the WAIT# signal is to be used).

PDL_BSC_WAIT_P51 or PDL_BSC_WAIT_P55 or PDL_BSC_WAIT_P57 or PDL_BSC_WAIT_PC5	Select the port pin to be used for signal WAIT#.
---	--

- ALE signal control (only required if the ALE signal is to be used).

PDL_BSC_ALE_ENABLE	Enable the ALE signal on pin P54.
--------------------	-----------------------------------

- Address pins A16 to A23 pin selection (only required if any of A16 to A23 are to be used).

PDL_BSC_A16_A23_PC or PDL_BSC_A16_A23_P9	Select either Port C or Port 9 for address A16 to A23 pins.
---	---

Description (2/3)

[data2]

- Address output control.
The signals are **enabled** by default, unless the pin is allocated to a bus control signal.
If multiple selections are required, use “|” to separate each selection.
Specify PDL_NO_DATA for no change.

PDL_BSC_A7_A0_DISABLE	Disable the output of the A7 to A0 signals.
PDL_BSC_A8_DISABLE	Disable the output of the A8 signal.
PDL_BSC_A9_DISABLE	Disable the output of the A9 signal.
PDL_BSC_A10_DISABLE	Disable the output of the A10 signal.
PDL_BSC_A11_DISABLE	Disable the output of the A11 signal.
PDL_BSC_A12_DISABLE	Disable the output of the A12 signal.
PDL_BSC_A13_DISABLE	Disable the output of the A13 signal.
PDL_BSC_A14_DISABLE	Disable the output of the A14 signal.
PDL_BSC_A15_DISABLE	Disable the output of the A15 signal.
PDL_BSC_A16_DISABLE	Disable the output of the A16 signal.
PDL_BSC_A17_DISABLE	Disable the output of the A17 signal.
PDL_BSC_A18_DISABLE	Disable the output of the A18 signal.
PDL_BSC_A19_DISABLE	Disable the output of the A19 signal.
PDL_BSC_A20_DISABLE	Disable the output of the A20 signal.
PDL_BSC_A21_DISABLE	Disable the output of the A21 signal.
PDL_BSC_A22_DISABLE	Disable the output of the A22 signal.
PDL_BSC_A23_DISABLE	Disable the output of the A23 signal.

PDL_BSC_A23_A16_DISABLE can be used to disable the signals A23 to A16.

- SDRAM output control

PDL_BSC_SDRAM_PINS_DISABLE or PDL_BSC_SDRAM_PINS_ENABLE	Enable or disable the SDRAM Pins, except the DQM1 pin.
PDL_BSC_SDRAM_DQM1_DISABLE or PDL_BSC_SDRAM_DQM1_ENABLE	Enable or disable the DQM1 pin. This is ignored if SDRAM pins are not enabled.

[data3]

- Recovery cycle insertion control.
The controls are disabled by default. Specify PDL_NO_DATA to use the defaults.
If multiple selections are required, use “|” to separate each selection.

	Bus type	Bus access		Area	
		Current	Next		
PDL_BSC_RCV_SRRS_ENABLE	Separate	Read	Read	Same	
PDL_BSC_RCV_SRRD_ENABLE			Read	Different	
PDL_BSC_RCV_SRWS_ENABLE			Write	Write	Same
PDL_BSC_RCV_SRWD_ENABLE				Write	Different
PDL_BSC_RCV_SWRS_ENABLE		Write	Read	Same	
PDL_BSC_RCV_SWRD_ENABLE				Different	
PDL_BSC_RCV_SWWS_ENABLE			Write	Write	Same
PDL_BSC_RCV_SWWD_ENABLE				Write	Different
PDL_BSC_RCV_MRRS_ENABLE	Multiplexed	Read	Read	Same	
PDL_BSC_RCV_MRRD_ENABLE			Read	Different	
PDL_BSC_RCV_MRWS_ENABLE			Write	Write	Same
PDL_BSC_RCV_MRWD_ENABLE				Write	Different
PDL_BSC_RCV_MWRS_ENABLE		Write	Read	Same	
PDL_BSC_RCV_MWRD_ENABLE				Read	Different
PDL_BSC_RCV_MWWS_ENABLE			Write	Write	Same
PDL_BSC_RCV_MWWD_ENABLE				Write	Different

[data4]

- Error monitoring

PDL_BSC_ERROR_ILLEGAL_ADDRESS_DISABLE or PDL_BSC_ERROR_ILLEGAL_ADDRESS_ENABLE	Disable or enable illegal address access detection.
PDL_BSC_ERROR_TIME_OUT_DISABLE or PDL_BSC_ERROR_TIME_OUT_ENABLE	Disable or enable bus time-out detection.

[func]

The function to be called when a bus error occurs. Specify PDL_NO_FUNC if not required.

Description (3/3)	<p>[data5] The interrupt priority level. Select between 1 (lowest priority) and 15 (highest priority). This parameter will be ignored if PDL_NO_FUNC is specified for parameter func.</p>
Return value	True if all parameters are valid and exclusive; otherwise false.
Category	Bus Controller
Reference	R_BSC_Set, R_BSC_CreateArea, R_BSC_Control
Remarks	<ul style="list-style-type: none"> • If required, call R_BSC_Set before using this function. • Call this function after all calls of function R_BSC_CreateArea. • After calling this function, use, R_BSC_Control to start the external bus operation. • Multifunction Pin Control registers are modified by this function. • A callback function is executed by the interrupt processing function. This means that no other interrupt can be processed until the callback function has completed. • Some pins are not available on some device packages. This function will return false if a selected pin is not available. Please check the hardware manual.
Program example	<pre> /* RPD_L definitions */ #include "r_pdl_bsc.h" /* RPD_L device-specific definitions */ #include "r_pdl_definitions.h" /* Bus error handler */ void BusErrorFunc(void){} void func(void) { /* Select CS2 on pin P62, all address signals, enable interrupts and register the callback function */ R_BSC_Create(PDL_BSC_CS2_P62 PDL_BSC_A16_A23_PC, PDL_NO_DATA, PDL_NO_DATA, PDL_BSC_ERROR_ILLEGAL_ADDRESS_ENABLE \ PDL_BSC_ERROR_TIME_OUT_ENABLE, BusErrorFunc, 5); } </pre>

3) R_BSC_CreateArea

Synopsis

Configure an external bus area.

Prototype

```
bool R_BSC_CreateArea(
    uint8_t data1, // Area selection
    uint16_t data2, // Configuration selection
    uint8_t data3, // RRCV cycles
    uint8_t data4, // WRCV cycles
    uint8_t data5, // CSPRWAIT cycles
    uint8_t data6, // CSPWAIT cycles
    uint8_t data7, // CSRWAIT cycles
    uint8_t data8, // CSWAIT cycles
    uint8_t data9, // CSROFF cycles
    uint8_t data10, // CSWOFF cycles
    uint8_t data11, // WDOFF cycles
    uint8_t data12, // AWAIT cycles
    uint8_t data13, // RDON cycles
    uint8_t data14, // WRON cycles
    uint8_t data15, // WDON cycles
    uint8_t data16 // CSON cycles
);
```

Description (1/2)

Set up an external bus area.

[data1]
The address area n (where n = 0 to 7).

[data2]
Configure the operation of area CSn.
If multiple selections are required, use “|” to separate each selection.
The default settings are shown in **bold**.

- External bus width

PDL_BSC_WIDTH_8 or PDL_BSC_WIDTH_16 PDL_BSC_WIDTH_32	Select 8, 16 or 32 bit data bus width.
--	--
- Endian mode

PDL_BSC_ENDIAN_SAME or PDL_BSC_ENDIAN_OPPOSITE	Set the bus endian mode to be the same or opposite to that of the CPU.
--	--
- Multiplexed mode

PDL_BSC_SEPARATE or PDL_BSC_MULTIPLEXED	Select separate or multiplexed address and data pins.
---	---
- Write access mode

PDL_BSC_WRITE_BYTE or PDL_BSC_WRITE_SINGLE	Select byte or single write strobe mode.
--	--
- External wait control

PDL_BSC_WAIT_DISABLE or PDL_BSC_WAIT_ENABLE	Disable or enable external wait control (using the WAIT# signal).
---	---
- Page access control

PDL_BSC_PAGE_READ_DISABLE or PDL_BSC_PAGE_READ_NORMAL or PDL_BSC_PAGE_READ_CONTINUOUS	Disable or enable page read accesses using normal access compatible mode or continuous assertion mode.
PDL_BSC_PAGE_WRITE_DISABLE or PDL_BSC_PAGE_WRITE_ENABLE	Disable or enable page write accesses.

[data3]
The number of read recovery cycles (RRCV). Valid between 0 and 15.

[data4]
The number of write recovery cycles (WRCV). Valid between 0 and 15.

Description (2/2)**[data5]**

The number of wait cycles used for second and subsequent accesses during a page read sequence (CSPRWAIT). Valid between 0 and 7.

[data6]

The number of wait cycles used for second and subsequent accesses during a page write sequence (CSPWWAIT). Valid between 0 and 7.

[data7]

The number of wait cycles for the first access during a normal or page read sequence (CSRWAIT). Valid between 0 and 31.

[data8]

The number of wait cycles for the first access during a normal or page write sequence (CSWWAIT). Valid between 0 and 31.

[data9]

The number of cycles that the CS signal is left asserted after the read strobe is negated (CSROFF). Valid between 0 and 7.

[data10]

The number of cycles that the CS signal is left asserted after the write strobe is negated (CSWOFF). Valid between 0 and 7.

[data11]

The number of cycles that the data output is left asserted after the write strobe is negated (WDOFF). Valid between 0 and 7.

[data12]

The number of wait cycles to be inserted into a multiplexed address output cycle (AWAIT). Valid between 0 and 3.

[data13]

The number of cycles before the read strobe is asserted (RDON). Valid between 0 and 7.

[data14]

The number of cycles before the write strobe is asserted (WRON). Valid between 0 and 7.

[data15]

The number of cycles before the write data is output (WDON). Valid between 0 and 7.

[data16]

The number of cycles before the chip select is asserted (CSON). Valid between 0 and 7.

Return value

True if all parameters are valid and exclusive; otherwise false.

Category

Bus Controller

Reference

R_BSC_Create

Remarks

- Use this function to set up each required area and then call R_BSC_Create.
- The endian mode of the CPU is selected by the MDE bits in the MDES or MDEB registers.
- Multifunction Pin Control registers are modified by this function.
- The cycle count parameters are not checked for validity. Use the hardware manual to check these values.
- Setting single write strobe mode is prohibited in the 8-bit bus space.
- A 32-bit data bus width is only supported on the 176 and 177 pin device packages.
- A 32-bit data bus width cannot be specified unless A16 to A23 has been disabled.
- If a 32-bit data bus width has been selected then a multiplexed address and data cannot be used.
- Do not call this function while the external bus is being accessed.
- This function is not required when using 64-pin and 48-pin package.

Program example

```
/* RPDL definitions */
#include "r_pdl_bsc.h"

/* RPDL device-specific definitions */
#include "r_pdl_definitions.h"

void func(void)
{
    /* Configure CS2: 8-bit width, maximum cycle counts */
    R_BSC_CreateArea(
        2,
        PDL_BSC_WIDTH_8,
        15,
        15,
        7,
        7,
        31,
        31,
        7,
        7,
        7,
        7,
        3,
        7,
        7,
        7,
        7
    );
}
```

4) R_BSC_Destroy

Synopsis

Stop the External Bus Controller.

Prototype

```
bool R_BSC_Destroy(
    uint8_t data // Area selection
);
```

Description

Disable an external bus area.

[data]

Select the external bus area CSn (where n = 0 to 7) to be disabled.

Return value

True.

Category

Bus Controller

Reference

R_BSC_Control

Remarks

- The bus error interrupt request will not be disabled by this function. Use R_BSC_Control to disable it.
- Multifunction Pin Control registers are modified by this function.
- If the SDCLK is active it will be de-activated.
- This function is not required when using 64-pin and 48-pin package.

Program example

```
/* RPDL definitions */
#include "r_pdl_bsc.h"

/* RPDL device-specific definitions */
#include "r_pdl_definitions.h"

void func(void)
{
    /* Disable the CS4 area */
    R_BSC_Destroy(
        4
    );
}
```

5) R_BSC_Control

Synopsis

Modify the External Bus Controller operation.

Prototype

```
bool R_BSC_Control(
    uint16_t data // Control options
);
```

Description

Control the BSC operation

[data]

Control the BSC operation.

- Start / stop operation

PDL_BSC_ENABLE or PDL_BSC_DISABLE	Enable or disable BSC operation.
--------------------------------------	----------------------------------

- Error clearing

PDL_BSC_ERROR_CLEAR	Clear the bus-error status registers.
---------------------	---------------------------------------

- Disable bus error interrupt request

PDL_BSC_DISABLE_BUSERR_IRQ	Disable bus error interrupt requests.
----------------------------	---------------------------------------

- SDRAM initialization

PDL_BSC_SDRAM_INITIALIZATION	Perform SDRAM initialization.
------------------------------	-------------------------------

- Set Auto-Refresh register

PDL_BSC_SDRAM_AUTO_REFRESH_ENABLE	Set Auto-Refresh register.
-----------------------------------	----------------------------

- Clear Auto-Refresh register

PDL_BSC_SDRAM_AUTO_REFRESH_DISABLE	Clear Auto-Refresh register.
------------------------------------	------------------------------

- Set Self-Refresh register

PDL_BSC_SDRAM_SELF_REFRESH_ENABLE	Set Self-Refresh register.
-----------------------------------	----------------------------

- Clear Self-Refresh register

PDL_BSC_SDRAM_SELF_REFRESH_DISABLE	Clear Self-Refresh register.
------------------------------------	------------------------------

- Enable SDRAM

PDL_BSC_SDRAM_ENABLE	Enable SDRAM operation.
----------------------	-------------------------

- Disable SDRAM

PDL_BSC_SDRAM_DISABLE	Disable SDRAM operation.
-----------------------	--------------------------

Return value

True if success; False if invalid parameters are selected.

Category

Bus Controller

Reference

R_BSC_Create

Remarks

- Before enabling the BSC operation, call R_BSC_Create.
- This function can be called from the error handling function (assigned in R_BSC_Create).
- This function will clear the Interrupt Status Flag indirectly.
- Only one SDRAM control operation is allowed at one time.
- SDRAM is not supported by the 100 pin device package, SDRAM options will be ignored.
- The bus can not be enabled / disabled if ROM/Flash Program Erase mode is set or if an operating power mode transition is in progress. This function will return false if this is detected.

Program example

```
/* RPDL definitions */
#include "r_pdl_bsc.h"

/* RPDL device-specific definitions */
#include "r_pdl_definitions.h"

void func(void)
{
    /* Clear the bus error signals */
    R_BSC_Control(
        PDL_BSC_ERROR_CLEAR
    );
}
```

6) R_BSC_SDRAM_CreateArea

Synopsis Configure the SDRAM area.

Prototype

```
bool R_BSC_SDRAM_CreateArea(
    uint16_t data1, // Configuration selection
    uint16_t data2, // RFC cycles
    uint8_t data3, // REFW cycles
    uint8_t data4, // ARFI cycles
    uint8_t data5, // ARFC count
    uint8_t data6, // PRC cycles
    uint8_t data7, // CL cycles
    uint8_t data8, // WR cycles
    uint8_t data9, // RP cycles
    uint8_t data10, // RCD cycles
    uint8_t data11, // RAS cycles
    uint16_t data12 // SDRAM mode
);
```

Description (1/2) Set up the SDRAM area.

[data1]
 Configure the operation of SDRAM area.
 If multiple selections are required, use “|” to separate each selection.
 The default settings are shown in **bold**. Specify PDL_NO_DATA to use the defaults.

- SDRAM bus width

PDL_BSC_SDRAM_WIDTH_16 or PDL_BSC_SDRAM_WIDTH_8 or PDL_BSC_SDRAM_WIDTH_32	Select 16-bit, 8-bit or 32-bit data bus width
--	---
- Endian mode

PDL_BSC_SDRAM_ENDIAN_SAME or PDL_BSC_SDRAM_ENDIAN_OPPOSITE	Set the bus endian mode to be the same or opposite to that of the CPU.
--	--
- Continuous access mode

PDL_BSC_SDRAM_CONT_ACCESS_DISABLE or PDL_BSC_SDRAM_CONT_ACCESS_ENABLE	Disable or enable Continuous Access.
---	--------------------------------------
- Address multiplex selection

PDL_BSC_SDRAM_8_BIT_SHIFT or PDL_BSC_SDRAM_9_BIT_SHIFT or PDL_BSC_SDRAM_10_BIT_SHIFT or PDL_BSC_SDRAM_11_BIT_SHIFT	Select the size of shift in address multiplexing: 8-bit shift, 9-bit shift, 10-bit shift, or 11-bit shift.
--	--

[data2]
 The value to be set to RFC bits in SDRAM Refresh Control Register (SDRFCR). Valid between 0x0001 and 0x0FFF. Setting of 0x0000 is prohibited.

[data3]
 The value to be set to REFW bits in SDRAM Refresh Control Register (SDRFCR). Valid between 0x00 and 0x0F.

[data4]
 The value to be set to ARFI bits in SDRAM Initialization Register (SDIR). Valid between 0x00 and 0x0F.

[data5]
 The value to be set to ARFC bits in SDRAM Initialization Register (SDIR). Valid between 0x01 and 0x0F. Setting of 0x00 is prohibited.

[data6]
 The value to be set to PRC bits in SDRAM Initialization Register (SDIR). Valid between 0x00 and 0x07.

Description (2/2)	<p>[data7] The value to be set to CL bits in SDRAM Timing Register (SDTR). Valid between 0x01 and 0x03. Setting of 0x00 or more than 0x03 is prohibited.</p> <p>[data8] The value to be set to WR bit in SDRAM Timing Register (SDTR). Valid between 0x00 and 0x01.</p> <p>[data9] The value to be set to RP bits in SDRAM Timing Register (SDTR). Valid between 0x00 and 0x07.</p> <p>[data10] The value to be set to RCD bits in SDRAM Timing Register (SDTR). Valid between 0x00 and 0x03.</p> <p>[data11] The value to be set to RAS bits in SDRAM Timing Register (SDTR). Valid between 0x00 and 0x06.</p> <p>[data12] The value to be written to the SDRAM mode register. Only the lower 15 bits are valid. Please refer to hardware manual for restriction on SDRAM mode setting.</p>
Return value	True if all parameters are valid and exclusive and the SDCLK is not disabled; otherwise false.
Category	Bus Controller
Reference	R_BSC_Set, R_CGC_Set and R_CGC_Control.
Remarks	<ul style="list-style-type: none"> • Before using this function, ensure that function R_BSC_Create and then R_BSC_Control(PDL_BSC_ENABLE) has been called, so that the bus is enabled. • The endian mode of the CPU is selected by the MDE pin (low = little endian; high = big endian). • The cycle count parameters are not checked for validity. Use the hardware manual to check these values. • The exact values in parameters data2 to data11 are to be set to respective bit-field in SDRAM registers. For the corresponding cycle / count value, please refer to the hardware manual. • Multifunction Pin Control registers are modified by this function. • The SDRAM clock (SDCLK) must be configured and enabled using R_CGC_Set before calling this function. If the SDCLK has been disabled using the CGC functions this function will return false. If this function is successful it will activate the SDCLK. • For the packages with 100 pins or less there is no SDRAM area so this function will return false. • A 32-bit data bus width is only supported on the 176 and 177 pin device packages.

Program example

```
/* RPDL definitions */
#include "r_pdl_bsc.h"

/* RPDL device-specific definitions */
#include "r_pdl_definitions.h"

void func(void)
{
    /* Configure SDRAM: 8-bit width, 10-bit address shift */
    R_BSC_SDRAM_CreateArea(
        PDL_BSC_SDRAM_WIDTH_32| PDL_BSC_SDRAM_8_BIT_SHIFT,
        0x0FFFu,
        0x00u,
        0x00u,
        0x02u,
        0x00u,
        0x02u,
        0x01u,
        0x00u,
        0x00u,
        0x00u,
        0x0220u
    );
}
```

7) R_BSC_GetStatus

Synopsis Read the status registers of External Bus & SDRAM Controller.

Prototype

```
bool R_BSC_GetStatus(
    uint8_t * data1, // A pointer to the data1 storage location
    uint16_t * data2, // A pointer to the data2 storage location
    uint8_t * data3 // A pointer to the data3 storage location
);
```

Description Read the status registers of Bus & SDRAM Controller

[data1]
 The status flags shall be stored in the format.
 Specify PDL_NO_PTR if this information is not required.

b7	b6 – b4	b3 – b2	b1	b0
0	000b: CPU	0	Timeout	Illegal address access
	011b: DTC/DMAC		0: None 1: Generated	0: None 1: Detected
	110b: EDMAC			
	111b: EXDMAC			

[data2]
 The status flags shall be stored in the format.
 Specify PDL_NO_PTR if this information is not required.

b15 – b3	b2 – b0
The upper 13 bits of an address that was accessed when a bus error occurred (in units of 512 Kbytes).	0

[data3]
 The SDRAM status flags shall be stored in the format.
 Specify PDL_NO_PTR if this information is not required.

b7– b5	b4	b3	b2 – b1	b0
0	Transition / recovery	Initialization sequence	0	Mode register setting
	0: Inactive 1: In progress	0: Inactive 1: In progress		0: Inactive 1: In progress

Return value True.

Category Bus Controller

Reference R_BSC_Control

Remarks

- Call R_BSC_Control to clear the status registers after reading the status.

Program example

```
/* RPDL definitions */
#include "r_pdl_bsc.h"

/* RPDL device-specific definitions */
#include "r_pdl_definitions.h"

void func(void)
{
    uint8_t status1;
    uint16_t status2;

    /* Read the BSC status flags but not the SDRAM status */
    R_BSC_GetStatus(
        &status1,
        &status2,
        PDL_NO_PTR
    );
}
```

4.2.11. DMA Controller

1) R_DMAC_Create

Synopsis

Configure the DMA controller.

Prototype

```
bool R_DMAC_Create(
    uint8_t data1, // Channel selection
    uint32_t data2, // Configuration selection
    uint8_t data3, // Trigger selection
    void * data4, // Source start address
    void * data5, // Destination start address
    uint16_t data6, // Transfer count
    uint16_t data7, // Repeat or Block size
    int32_t data8, // Address offset
    uint32_t data9, // Source address extended repeat area
    uint32_t data10, // Destination address extended repeat area
    void * func, // Callback function
    uint8_t data11 // Interrupt priority level
);
```

Description (1/3)

Set up a DMA channel.

[data1]
The channel number n (where n = 0 to 3).

[data2]
Configure the operation of channel DMA. If multiple selections are required, use “|” to separate each selection. The default settings are shown in **bold**.

- Transfer mode selection

PDL_DMAC_NORMAL or PDL_DMAC_REPEAT or PDL_DMAC_BLOCK	Normal or Repeat or Block mode.
PDL_DMAC_SOURCE or PDL_DMAC_DESTINATION	If Repeat or Block mode is selected, the source or destination side can be selected as the Repeat or Block area. This selection is optional.

- Address direction selection

PDL_DMAC_SOURCE_ADDRESS_FIXED or PDL_DMAC_SOURCE_ADDRESS_PLUS or PDL_DMAC_SOURCE_ADDRESS_MINUS or PDL_DMAC_SOURCE_ADDRESS_OFFSET	Leave the source address unchanged, increment it, decrement it or modify it by the value specified in parameter data8. Address offset is valid only for n = 0.
PDL_DMAC_DESTINATION_ADDRESS_FIXED or PDL_DMAC_DESTINATION_ADDRESS_PLUS or PDL_DMAC_DESTINATION_ADDRESS_MINUS or PDL_DMAC_DESTINATION_ADDRESS_OFFSET	Leave the destination address unchanged, increment it, decrement it or modify it by the value specified in parameter data8. Address offset is valid only for n = 0.

- Transfer data size

PDL_DMAC_SIZE_8 or PDL_DMAC_SIZE_16 or PDL_DMAC_SIZE_32	Select 8, 16 or 32 bits for the data to be transferred.
---	---

- Interrupt generation (optional).

PDL_DMAC_IRQ_END	Transfer completion.
PDL_DMAC_IRQ_ESCAPE_END	Escape end.
PDL_DMAC_IRQ_REPEAT_SIZE_END	1-repeat size or 1-block data transfer completion.
PDL_DMAC_IRQ_EXT_SOURCE	Extended repeat area overflow on the source.
PDL_DMAC_IRQ_EXT_DESTINATION	Extended repeat area overflow on the destination.

Description (2/3)

- Start trigger forwarding

PDL_DMAC_TRIGGER_CLEAR or PDL_DMAC_TRIGGER_FORWARD	When the DMAC transfer is complete, clear the DMAC activation trigger or pass it on to the CPU.
--	---
- DTC trigger control

PDL_DMAC_DTC_TRIGGER_DISABLE or PDL_DMAC_DTC_TRIGGER_ENABLE	Disable or enable activation of the DTC when an event specified in the "Interrupt generation" options occurs.
---	---

[data3]

Select one activation source for channel DMA_n.

- Trigger selection

Name	Trigger cause
PDL_DMAC_TRIGGER_SW or PDL_DMAC_TRIGGER_CMT0 or PDL_DMAC_TRIGGER_CMT1 or PDL_DMAC_TRIGGER_CMT2 or PDL_DMAC_TRIGGER_CMT3 or	By software.
PDL_DMAC_TRIGGER_USB0_D0FIFO0 or PDL_DMAC_TRIGGER_USB0_D1FIFO0 or PDL_DMAC_TRIGGER_USB1_D0FIFO1 or PDL_DMAC_TRIGGER_USB1_D1FIFO1 or	Compare match on channel CMT _n (n = 0 to 3). FIFO interrupt from USB0. FIFO interrupt from USB1.
PDL_DMAC_TRIGGER_SPIO_RX or PDL_DMAC_TRIGGER_SPI1_RX or PDL_DMAC_TRIGGER_SPI2_RX or PDL_DMAC_TRIGGER_SPIO_TX or PDL_DMAC_TRIGGER_SPI1_TX or PDL_DMAC_TRIGGER_SPI2_TX or	Receive buffer full on SPI channel n (n = 0 to 2). Transmit buffer empty on SPI channel n (n = 0 to 2).
PDL_DMAC_TRIGGER_IRQ0 or PDL_DMAC_TRIGGER_IRQ1 or PDL_DMAC_TRIGGER_IRQ2 or PDL_DMAC_TRIGGER_IRQ3 or	Valid edge detected on pin IRQ _n (n = 0 to 3).
PDL_DMAC_TRIGGER_ADC10 or	Conversion completed on the 10-bit ADC unit.
PDL_DMAC_TRIGGER_ADC12 or	Conversion completed on the 12-bit ADC unit.
PDL_DMAC_TRIGGER_TPU0 or PDL_DMAC_TRIGGER_TPU1 or PDL_DMAC_TRIGGER_TPU2 or PDL_DMAC_TRIGGER_TPU3 or PDL_DMAC_TRIGGER_TPU4 or PDL_DMAC_TRIGGER_TPU5 or PDL_DMAC_TRIGGER_TPU6 or PDL_DMAC_TRIGGER_TPU7 or PDL_DMAC_TRIGGER_TPU8 or PDL_DMAC_TRIGGER_TPU9 or PDL_DMAC_TRIGGER_TPU10 or PDL_DMAC_TRIGGER_TPU11 or	Input capture or compare match on TPU channel n (n = 0 to 11).
PDL_DMAC_TRIGGER_MTU0 or PDL_DMAC_TRIGGER_MTU1 or PDL_DMAC_TRIGGER_MTU2 or PDL_DMAC_TRIGGER_MTU3 or PDL_DMAC_TRIGGER_MTU4 or	Input capture or compare match on MTU channel n (n = 0 to 4).
PDL_DMAC_TRIGGER_IIC0_RX or PDL_DMAC_TRIGGER_IIC1_RX or PDL_DMAC_TRIGGER_IIC2_RX or PDL_DMAC_TRIGGER_IIC3_RX or	Receive buffer full on I ² C channel n (n = 0 to 3).
PDL_DMAC_TRIGGER_IIC0_TX or PDL_DMAC_TRIGGER_IIC1_TX or PDL_DMAC_TRIGGER_IIC2_TX or PDL_DMAC_TRIGGER_IIC3_TX or	Transmit buffer empty on I ² C channel n (n = 0 to 3).

Description (3/3)		
	PDL_DMAM_TRIGGER_SCI0_RX or PDL_DMAM_TRIGGER_SCI1_RX or PDL_DMAM_TRIGGER_SCI2_RX or PDL_DMAM_TRIGGER_SCI3_RX or PDL_DMAM_TRIGGER_SCI4_RX or PDL_DMAM_TRIGGER_SCI5_RX or PDL_DMAM_TRIGGER_SCI6_RX or PDL_DMAM_TRIGGER_SCI7_RX or PDL_DMAM_TRIGGER_SCI8_RX or PDL_DMAM_TRIGGER_SCI9_RX or PDL_DMAM_TRIGGER_SCI10_RX or PDL_DMAM_TRIGGER_SCI11_RX or PDL_DMAM_TRIGGER_SCI12_RX or	Receive buffer full on SCI channel n (n = 0 to 12).
	PDL_DMAM_TRIGGER_SCI0_TX or PDL_DMAM_TRIGGER_SCI1_TX or PDL_DMAM_TRIGGER_SCI2_TX or PDL_DMAM_TRIGGER_SCI3_TX or PDL_DMAM_TRIGGER_SCI4_TX or PDL_DMAM_TRIGGER_SCI5_TX or PDL_DMAM_TRIGGER_SCI6_TX or PDL_DMAM_TRIGGER_SCI7_TX or PDL_DMAM_TRIGGER_SCI8_TX or PDL_DMAM_TRIGGER_SCI9_TX or PDL_DMAM_TRIGGER_SCI10_TX or PDL_DMAM_TRIGGER_SCI11_TX or PDL_DMAM_TRIGGER_SCI12_TX	Transmit buffer empty on SCI unit n (n = 0 to 12).

[data4]

The source start address.

[data5]

The destination start address.

[data6]

The number of transfers to take place.

For normal mode: valid between 0 and 65535 (0 = free running mode).

For repeat and block mode: valid between 0 and 1023 (0 = 1024 transfers).

[data7]

The repeat or block size for each transfer.

For repeat and block mode: valid between 0 and 1023 (0 = 1024 units).

Ignored in normal mode.

[data8]

The address offset value. The range is from +16,777,215 to -16,777,216.

This value is ignored if the offset function is not selected.

[data9]

The source address extended repeat value. The value can be any power of 2, from 2^1 to 2^{27} . Specify PDL_NO_DATA if the extended repeat function is not required for the source address.

[data10]

The destination address extended repeat value.

The value can be any power of 2, from 2^1 to 2^{27} .

Specify PDL_NO_DATA if the extended repeat function is not required for the destination address.

[func]

The function to be called when a DMA transfer completes.

Specify PDL_NO_FUNC if not required.

[data11]

The interrupt priority level. Select between 1 (lowest priority) and 15 (highest priority).

This parameter will be ignored if PDL_NO_FUNC is specified for parameter func.

Return value	True if all parameters are valid and exclusive; otherwise false.
Category	DMA controller
Reference	None.
Remarks	<ul style="list-style-type: none"> • If another peripheral will be used to trigger a DMA transfer, call this function before calling the Create function for the peripheral. • Some peripheral channels are not available on some device packages. Please check the hardware manual. • A callback function is executed by the interrupt processing function. This means that no other interrupt can be processed until the callback function has completed.

Program example

```

/* RPDL definitions */
#include "r_pdl_dmac.h"

/* RPDL device-specific definitions */
#include "r_pdl_definitions.h"

void func(void)
{
    /* Configure DMA channel 2 */
    R_DMAC_Create(
        2,
        PDL_DMAC_NORMAL | \
        PDL_DMAC_SOURCE_ADDRESS_PLUS | \
        PDL_DMAC_DESTINATION_ADDRESS_PLUS | \
        PDL_DMAC_SIZE_8,
        PDL_DMAC_TRIGGER_IRQ0,
        (void *)0x0000AA00,
        (void *)0x0000BB00,
        10,
        PDL_NO_DATA,
        PDL_NO_DATA,
        PDL_NO_DATA,
        PDL_NO_DATA,
        PDL_NO_FUNC,
        0
    );
}

```

2) R_DMAC_Destroy

Synopsis

Disable the DMA controller.

Prototype

```
bool R_DMAC_Destroy(
    uint8_t data // Channel number
);
```

Description

Shutdown the DMAC module.

[data]

The channel number n (where n = 0 to 3).

Return value

True if the shutdown succeeded; otherwise false.

Category

DMA controller

Reference

R_DMAC_Create.

Remarks

- If all channels have been suspended, the DMAC module will be shut down.
- Disabling the DMAC module will also shut down the DTC.
- If another peripheral is being used to trigger a DMA transfer, stop the triggers from that peripheral (using Control or Destroy for that peripheral) before calling this function.

Program example

```
/* RPDL definitions */
#include "r_pdl_dmac.h"

/* RPDL device-specific definitions */
#include "r_pdl_definitions.h"

void func(void)
{
    /* Shutdown DMAC channel 2 */
    R_DMAC_Destroy(
        2
    );
}
```

3) R_DMAC_Control

Synopsis Control the DMA controller.

Prototype

```
bool R_DMAC_Control (
    uint8_t data1, // Channel number
    uint16_t data2, // Control options
    void * data3, // Source start address
    void * data4, // Destination start address
    uint16_t data5, // Transfer count
    uint16_t data6, // Repeat or Block size
    int32_t data7, // Address offset
    uint32_t data8, // Source address extended repeat area
    uint32_t data9 // Destination address extended repeat area
);
```

Description (1/2) Change the state of a DMA controller channel.

[data1]
The channel number n (where n = 0 to 3).

[data2]
Control the channel operation.
If multiple selections are required, use “|” to separate each selection.

- Enable / suspend control

PDL_DMAC_ENABLE	Enable / re-enable DMA transfers.
PDL_DMAC_SUSPEND	Suspend DMA transfers.

- Software trigger control

PDL_DMAC_START or PDL_DMAC_START_RUN or PDL_DMAC_STOP	Start a DMA transfer. Start DMA transfers until stopped. Stop software-triggered transfers.
---	---

- Transfer end interrupt flag control

PDL_DMAC_CLEAR_DTIF	Clear the Transfer End flag.
PDL_DMAC_CLEAR_ESIF	Clear the Transfer Escape End flag.

- The values to be modified.

PDL_DMAC_UPDATE_SOURCE	Source address, using parameter data3.
PDL_DMAC_UPDATE_DESTINATION	Destination address, using parameter data4.
PDL_DMAC_UPDATE_COUNT	Transfer count, using parameter data5.
PDL_DMAC_UPDATE_SIZE	Repeat or Block size, using parameter data6.
PDL_DMAC_UPDATE_OFFSET	Address offset, using parameter data7.
PDL_DMAC_UPDATE_REPEAT_SOURCE	Source address extended repeat area, using parameter data8.
PDL_DMAC_UPDATE_REPEAT_DESTINATION	Destination address extended repeat area, using parameter data9.

[data3]
The new source address. Specify PDL_NO_PTR if not required.

[data4]
The new destination address. Specify PDL_NO_PTR if not required.

[data5]
The transfer count value. Specify PDL_NO_DATA if not required.

Description (2/2)**[data6]**

The repeat or block size for each transfer.
Valid between 0 and 1023 (0 = 1024 units).
Ignored in normal mode.
Specify PDL_NO_DATA if not required.

[data7]

The address offset value.
The range is from +16,777,215 to -16,777,216.
This value is ignored if the offset function is not selected.
Specify PDL_NO_DATA if not required.

[data8]

The source address extended repeat value.
The value can be any power of 2, from 2^1 to 2^{27} .
Specify PDL_NO_DATA if not required.

[data9]

The destination address extended repeat value.
The value can be any power of 2, from 2^1 to 2^{27} .
Specify PDL_NO_DATA if not required.

Return value

True if all parameters are valid and exclusive; otherwise false.

Category

DMA controller

Reference

R_DMACH_Create

Remarks

- The Software trigger control is valid only if the Software trigger option has been selected.
- This function must be called in order to start the DMAC.
- The Suspend / Enable and Start control is executed at the end of the function. If a channel has completed a transfer, parameters may be changed and the channel re-enabled in one function call.

Program example

```

/* RPDL definitions */
#include "r_pdl_dmac.h"

/* RPDL device-specific definitions */
#include "r_pdl_definitions.h"

#include <string.h>

const char source_string_1[]="Renesas RX63N";
volatile char destination_string_1[]=".....";

void func(void)
{
    /* Re-enable transfers on channel 2 */
    R_DMAC_Control(
        2,
        PDL_DMAC_ENABLE,
        PDL_NO_PTR,
        PDL_NO_PTR,
        PDL_NO_DATA,
        PDL_NO_DATA,
        PDL_NO_DATA,
        PDL_NO_DATA,
        PDL_NO_DATA
    );

    /* Reload and trigger channel 1 */
    R_DMAC_Control(
        1,
        PDL_DMAC_ENABLE | PDL_DMAC_START | \
        PDL_DMAC_UPDATE_SOURCE | PDL_DMAC_UPDATE_DESTINATION | \
        PDL_DMAC_UPDATE_COUNT | PDL_DMAC_UPDATE_SIZE,
        source_string_1,
        destination_string_1,
        1,
        (uint16_t)strlen(source_string_1),
        PDL_NO_DATA,
        PDL_NO_DATA,
        PDL_NO_DATA
    );
}

```

4) R_DMAM_GetStatus

Synopsis Check the status of a DMA channel.

Prototype

```
bool R_DMAM_GetStatus(
    uint8_t data1, // Channel number
    uint8_t * data2, // Status flags pointer
    uint32_t * data3, // Current source address pointer
    uint32_t * data4, // Current destination address pointer
    uint16_t * data5, // Current transfer count pointer
    uint16_t * data6 // Current Repeat or Block size count pointer
);
```

Description Return status flags and current channel registers.

[data1]
The channel number n (where n = 0 to 3).

[data2]
The status flags shall be stored in the following format.
Specify PDL_NO_PTR if the flags are not to be read.

b7 – b5	b4	b3	b2	b1	b0
0	Interrupt request (IR)	Transfer Escape End interrupt (ESIF)	Transfer End interrupt (DTIF)	Status (ACT)	Transfer enable (DTE)
		0: Idle 1: Generated	0: Idle 1: Generated	0: Idle 1: Operating	0: Disabled 1: Enabled

[data3]
Where the current source address shall be stored. Specify PDL_NO_PTR if it is not required.

[data4]
Where the current destination address shall be stored. Specify PDL_NO_PTR if it is not required.

[data5]
Where the current transfer count shall be stored. Specify PDL_NO_PTR if it is not required.

[data6]
Where the current repeat or block size count shall be stored. Specify PDL_NO_PTR if it is not required.

Return value True if all parameters are valid and exclusive; otherwise false.

Category DMA controller

Reference R_DMAM_Create

Remarks

- If the Interrupt request flag is set to 1, the flag will be cleared to 0 by this function.

Program example

```
/* RPDL definitions */
#include "r_pdl_dmac.h"

/* RPDL device-specific definitions */
#include "r_pdl_definitions.h"

void func(void)
{
    uint8_t StatusValue;
    uint32_t SourceAddr;

    /* Read the status and current source address for channel 2 */
    R_DMACH_GetStatus(
        2,
        &StatusValue,
        &SourceAddr,
        PDL_NO_PTR,
        PDL_NO_PTR,
        PDL_NO_PTR
    );
}
```

4.2.12. External DMA Controller

1) R_EXDMAC_Set

Synopsis	Configure the EXDMAC pins.								
Prototype	<pre>bool R_EXDMAC_Set(uint8_t data1, // Channel selection uint16_t data2 // Pin configuration);</pre>								
Description	<p>Set up the global EXDMAC options.</p> <p>[data1] The channel number n (where n = 0 or 1).</p> <p>[data2] Configure the EXDMAC pins for the channel. Use “ ” to separate each selection.</p> <ul style="list-style-type: none"> Valid when n = 0 <table border="1" style="width: 100%;"> <tr> <td style="width: 70%;">PDL_EXDMAC_PIN_EDREQ0_P22 or PDL_EXDMAC_PIN_EDREQ0_P55 or PDL_EXDMAC_PIN_EDREQ0_P80</td> <td>Select the pin for EDREQ0.</td> </tr> <tr> <td>PDL_EXDMAC_PIN_EDACK0_P23 or PDL_EXDMAC_PIN_EDACK0_P54 or PDL_EXDMAC_PIN_EDACK0_P81</td> <td>Select the pin for EDACK0.</td> </tr> </table> Valid when n = 1 <table border="1" style="width: 100%;"> <tr> <td style="width: 70%;">PDL_EXDMAC_PIN_EDREQ1_P24 or PDL_EXDMAC_PIN_EDREQ1_P57 or PDL_EXDMAC_PIN_EDREQ1_P82</td> <td>Select the pin for EDREQ1.</td> </tr> <tr> <td>PDL_EXDMAC_PIN_EDACK1_P25 or PDL_EXDMAC_PIN_EDACK1_P56 or PDL_EXDMAC_PIN_EDACK1_P83</td> <td>Select the pin for EDACK1.</td> </tr> </table> 	PDL_EXDMAC_PIN_EDREQ0_P22 or PDL_EXDMAC_PIN_EDREQ0_P55 or PDL_EXDMAC_PIN_EDREQ0_P80	Select the pin for EDREQ0.	PDL_EXDMAC_PIN_EDACK0_P23 or PDL_EXDMAC_PIN_EDACK0_P54 or PDL_EXDMAC_PIN_EDACK0_P81	Select the pin for EDACK0.	PDL_EXDMAC_PIN_EDREQ1_P24 or PDL_EXDMAC_PIN_EDREQ1_P57 or PDL_EXDMAC_PIN_EDREQ1_P82	Select the pin for EDREQ1.	PDL_EXDMAC_PIN_EDACK1_P25 or PDL_EXDMAC_PIN_EDACK1_P56 or PDL_EXDMAC_PIN_EDACK1_P83	Select the pin for EDACK1.
PDL_EXDMAC_PIN_EDREQ0_P22 or PDL_EXDMAC_PIN_EDREQ0_P55 or PDL_EXDMAC_PIN_EDREQ0_P80	Select the pin for EDREQ0.								
PDL_EXDMAC_PIN_EDACK0_P23 or PDL_EXDMAC_PIN_EDACK0_P54 or PDL_EXDMAC_PIN_EDACK0_P81	Select the pin for EDACK0.								
PDL_EXDMAC_PIN_EDREQ1_P24 or PDL_EXDMAC_PIN_EDREQ1_P57 or PDL_EXDMAC_PIN_EDREQ1_P82	Select the pin for EDREQ1.								
PDL_EXDMAC_PIN_EDACK1_P25 or PDL_EXDMAC_PIN_EDACK1_P56 or PDL_EXDMAC_PIN_EDACK1_P83	Select the pin for EDACK1.								
Return value	True if all parameters are valid and exclusive; otherwise false.								
Category	EXDMA Controller								
Reference	None								
Remarks	<ul style="list-style-type: none"> Before calling the R_EXDMAC_Create function, call this function to configure the relevant pins if required. Call this function multiple times, if more than one channel is to be configured. Pins which are not used may be omitted. EXDMAC is not available on 64-pin and 48-pin packages. 								

Program example	<pre>/* RPDL definitions */ #include "r_pdl_exdmac.h" /* RPDL device-specific definitions */ #include "r_pdl_definitions.h" void func(void) { /* Configure EDREQ0 on Pin P22 */ R_EXDMAC_Set(0, PDL_EXDMAC_PIN_EDREQ0_P22); }</pre>
------------------------	---

2) R_EXDMAC_Create

Synopsis Configure the EXDMA controller.

Prototype

```
bool R_EXDMAC_Create(
    uint8_t data1, // Channel selection
    uint32_t data2, // Configuration selection
    uint16_t data3, // Configuration selection
    uint8_t data4, // Configuration selection
    void * data5, // Source start address
    void * data6, // Destination start address
    uint16_t data7, // Transfer count
    uint16_t data8, // Repeat or Block size
    int32_t data9, // Address offset
    uint32_t data10, // Source address extended repeat area
    uint32_t data11, // Destination address extended repeat area
    void * func, // Callback function
    uint8_t data12 // Interrupt priority level
);
```

Description (1/3) Set up an EXDMAC channel.

[data1]
The channel number n (where n = 0 to 1).

[data2]
Configure the operation of channel EXDMACn.
Use “|” to separate each selection.

- Transfer mode selection

PDL_EXDMAC_NORMAL or PDL_EXDMAC_REPEAT or PDL_EXDMAC_BLOCK or PDL_EXDMAC_CLUSTER	Normal or Repeat or Block or Cluster mode.
PDL_EXDMAC_SOURCE or PDL_EXDMAC_DESTINATION	If Repeat, Block or Cluster mode is selected, the source or destination side can be selected as the Repeat or Block area. This selection is optional.

- Address direction selection

PDL_EXDMAC_SOURCE_ADDRESS_FIXED or PDL_EXDMAC_SOURCE_ADDRESS_PLUS or PDL_EXDMAC_SOURCE_ADDRESS_MINUS or PDL_EXDMAC_SOURCE_ADDRESS_OFFSET	Leave the source address unchanged, increment it, decrement it or modify it by the value specified in parameter data9. Address offset is valid only for n = 0.
PDL_EXDMAC_DESTINATION_ADDRESS_FIXED or PDL_EXDMAC_DESTINATION_ADDRESS_PLUS or PDL_EXDMAC_DESTINATION_ADDRESS_MINUS or PDL_EXDMAC_DESTINATION_ADDRESS_OFFSET	Leave the destination address unchanged, increment it, decrement it or modify it by the value specified in parameter data9. Address offset is valid only for n = 0.

- Address mode selection

PDL_EXDMAC_ADDRESS_MODE_READ or PDL_EXDMAC_ADDRESS_MODE_WRITE or PDL_EXDMAC_ADDRESS_MODE_DUAL	Select single address mode with the source or destination for address output, or dual address mode.
---	---

- Transfer data size

PDL_EXDMAC_SIZE_8 or PDL_EXDMAC_SIZE_16 or PDL_EXDMAC_SIZE_32	Select 8, 16 or 32 bits for the data to be transferred.
---	---

Description (2/3)

[data3]

Configure the trigger and output options.
Use “|” to separate each selection. The default settings are shown in **bold**.

- EDACKn pin output control

PDL_EXDMAC_EDACK_DISABLE or PDL_EXDMAC_EDACK_LOW or PDL_EXDMAC_EDACK_HIGH	Disable EDACKn output or select active low or active high operation.
PDL_EXDMAC_EDACK_SYNC or PDL_EXDMAC_EDACK_WAIT	If the EDACKn output is enabled, select negate timing with respect to the RD and WR outputs.
PDL_EXDMAC_EDACK_TOGGLE	If the EDACKn output is enabled, select to enable toggling of the EDACK pin during transfer to the SDRAM area in single address mode.

- Trigger selection

PDL_EXDMAC_TRIGGER_SW or PDL_EXDMAC_TRIGGER_RISING or PDL_EXDMAC_TRIGGER_FALLING or PDL_EXDMAC_TRIGGER_LOW or PDL_EXDMAC_TRIGGER_MTU1_TPU7	Select activation by software, a rising edge, falling edge or low level on the EDREQn pin or compare match from MTU1 or TPU7.
--	---

[data4]

Select the completion actions.
The default settings are shown in **bold**. Specify PDL_NO_DATA to use the defaults.

- Interrupt generation. These are all optional.

PDL_EXDMAC_IRQ_END	Transfer completion.
PDL_EXDMAC_IRQ_REPEAT_SIZE_END	1-repeat size or 1-block data transfer completion.
PDL_EXDMAC_IRQ_EXT_SOURCE	Extended repeat area overflow on the source.
PDL_EXDMAC_IRQ_EXT_DESTINATION	Extended repeat area overflow on the destination.

- DTC trigger control

PDL_EXDMAC_DTC_TRIGGER_DISABLE or PDL_EXDMAC_DTC_TRIGGER_ENABLE	Disable or enable activation of the DTC when an event specified in the “Interrupt generation” options occurs.
---	---

[data5]

The source start address.

[data6]

The destination start address.

[data7]

The number of transfers to take place.
For normal mode: valid between 0 and 65535 (0 = free running mode).
For repeat, block and cluster mode: valid between 0 and 1023 (0 = 1024 transfers).

[data8]

The repeat, block or cluster size for each transfer.
For repeat and block mode: valid between 0 and 1023 units (0 = 1024 transfers).
For cluster mode: valid between 0 and 7 units. (0 = 8 units)
Ignored in normal mode.

[data9]

The address offset value. The range is from +16,777,215 to -16,777,216.
This value is ignored if the offset function is not selected.

[data10]

The source address extended repeat value. The value can be any power of 2, from 2¹ to 2²⁷.
Specify PDL_NO_DATA if the extended repeat function is not required for the source address.

Description (3/3)	<p>[data11] The destination address extended repeat value. The value can be any power of 2, from 2^1 to 2^{27}. Specify PDL_NO_DATA if the extended repeat function is not required for the destination address.</p> <p>[func] The function to be called when a DMA transfer completes. Specify PDL_NO_FUNC if not required.</p> <p>[data12] The interrupt priority level. Select between 1 (lowest priority) and 15 (highest priority). This parameter will be ignored if PDL_NO_FUNC is specified for parameter func.</p>
Return value	True if all parameters are valid and exclusive; otherwise false.
Category	EXDMA controller
Reference	None.
Remarks	<ul style="list-style-type: none"> • If another peripheral will be used to trigger an EXDMAC transfer, call this function before calling the Create function for the peripheral. • A callback function is executed by the interrupt processing function. This means that no other interrupt can be processed until the callback function has completed. • If using any EXDMAC pins then R_EXDMAC_Set must be used before calling this function. • When an EXDMAC interrupt is generated the EXDMAC is disabled. It must be re-enabled before it can be re-triggered. • EXDMAC is not available on 64-pin and 48-pin packages.

Program example

```

/* RPDL definitions */
#include "r_pdl_exdmac.h"

/* RPDL device-specific definitions */
#include "r_pdl_definitions.h"

void func(void)
{
    /* Configure EXDMAC channel 0 */
    R_EXDMAC_Create(
        0,
        PDL_EXDMAC_NORMAL | \
        PDL_EXDMAC_SOURCE_ADDRESS_PLUS | \
        PDL_EXDMAC_DESTINATION_ADDRESS_PLUS | \
        PDL_EXDMAC_ADDRESS_MODE_DUAL | PDL_EXDMAC_SIZE_32,
        PDL_EXDMAC_TRIGGER_FALLING,
        PDL_NO_DATA,
        (void*)0x0000AA00,
        (void*)0x0000BB00,
        10,
        PDL_NO_DATA,
        PDL_NO_DATA,
        PDL_NO_DATA,
        PDL_NO_DATA,
        PDL_NO_FUNC,
        0
    );
}

```

3) R_EXDMAC_Destroy**Synopsis**

Disable the EXDMA controller.

Prototype

```
bool R_EXDMAC_Destroy(
    uint8_t data    // Channel number
);
```

Description

Shutdown the EXDMAC module.

[data]

The channel number n (where n = 0 to 1).

Return value

True if the shutdown succeeded; otherwise false.

Category

EXDMA controller

Reference

R_EXDMAC_Create

Remarks

- If all channels have been suspended, the EXDMAC module will be shut down.
- If the MTU is being used to trigger an EXDMA transfer, stop the triggers from that peripheral (using Control or Destroy for that peripheral) before calling this function.
- EXDMAC is not available on 64-pin and 48-pin packages.

Program example

```
/* RPDFL definitions */
#include "r_pdl_exdmac.h"

/* RPDFL device-specific definitions */
#include "r_pdl_definitions.h"

void func(void)
{
    /* Shutdown channel 1 */
    R_EXDMAC_Destroy(
        1
    );
}
```

4) R_EXDMAC_Control

Synopsis

Control the EXDMA controller.

Prototype

```
bool R_EXDMAC_Control (
    uint8_t data1, // Channel number
    uint16_t data2, // Control options
    void * data3, // Source start address
    void * data4, // Destination start address
    uint16_t data5, // Transfer count
    uint16_t data6, // Repeat or Block size
    int32_t data7, // Address offset
    uint32_t data8, // Source address extended repeat area
    uint32_t data9 // Destination address extended repeat area
);
```

Description (1/2)

Change the state of a DMA controller channel.

[data1]
The channel number n (where n = 0 to 1).

[data2]
Control the channel operation.
If multiple selections are required, use “|” to separate each selection.

- Enable / suspend control

PDL_EXDMAC_ENABLE	Enable / re-enable DMA transfers.
PDL_EXDMAC_SUSPEND	Suspend DMA transfers.

- Software trigger control

PDL_EXDMAC_START or PDL_EXDMAC_START_RUN or PDL_EXDMAC_STOP	Start an EXDMA transfer. Start EXDMA transfers until stopped. Stop software-triggered transfers
---	---

- Transfer end interrupt flag control

PDL_EXDMAC_CLEAR_DTIF	Clear the Transfer End flag.
PDL_EXDMAC_CLEAR_ESIF	Clear the Transfer Escape End flag.

- The values to be modified.

PDL_EXDMAC_UPDATE_SOURCE	Source address, using parameter data3.
PDL_EXDMAC_UPDATE_DESTINATION	Destination address, using parameter data4.
PDL_EXDMAC_UPDATE_COUNT	Transfer count, using parameter data5.
PDL_EXDMAC_UPDATE_SIZE	Repeat, block or cluster size, using parameter data6.
PDL_EXDMAC_UPDATE_OFFSET	Address offset, using parameter data7.
PDL_EXDMAC_UPDATE_REPEAT_SOURCE	Source address extended repeat area, using parameter data8.
PDL_EXDMAC_UPDATE_REPEAT_DESTINATION	Destination address extended repeat area, using parameter data9.

[data3]
The new source address. Specify PDL_NO_PTR if not required.

[data4]
The new destination address. Specify PDL_NO_PTR if not required.

[data5]
The transfer count value. Specify PDL_NO_DATA if not required.

[data6]
The repeat, block or cluster size for each transfer. Specify PDL_NO_DATA if not required.

[data7]
The address offset value. Specify PDL_NO_DATA if not required.

Description (2/2)**[data8]**

The source address extended repeat value. Specify PDL_NO_DATA if not required.

[data9]

The destination address extended repeat value. Specify PDL_NO_DATA if not required.

Return value

True if all parameters are valid and exclusive; otherwise false.

Category

EXDMA controller

Reference

R_EXDMAC_Create

Remarks

- The Software trigger control is valid only if the Software trigger option has been selected.
- This function must be called in order to start the EXDMAC.
- Refer to R_EXDMAC_Create for the valid parameter values.
- The Suspend / Enable and Start control is executed at the end of the function. If a channel has completed a transfer, parameters may be changed and the channel re-enabled in one function call.
- EXDMAC is not available on 64-pin and 48-pin packages.

Program example

```

/* RPDL definitions */
#include "r_pdl_exdmac.h"

/* RPDL device-specific definitions */
#include "r_pdl_definitions.h"

#include <string.h>

const char source_string_1[]="RX63N";
volatile char destination_string_1[]=".....";

void func(void)
{
    /* Re-enable transfers on channel 0 */
    R_EXDMAC_Control(
        0,
        PDL_EXDMAC_ENABLE,
        PDL_NO_PTR,
        PDL_NO_PTR,
        PDL_NO_DATA,
        PDL_NO_DATA,
        PDL_NO_DATA,
        PDL_NO_DATA,
        PDL_NO_DATA
    );

    /* Reload and trigger channel 1 */
    R_EXDMAC_Control(
        1,
        PDL_EXDMAC_ENABLE | PDL_EXDMAC_START | \
        PDL_EXDMAC_UPDATE_SOURCE | PDL_EXDMAC_UPDATE_DESTINATION | \
        PDL_EXDMAC_UPDATE_COUNT | PDL_EXDMAC_UPDATE_SIZE,
        (void*)source_string_1,
        (void*)destination_string_1,
        1,
        (uint16_t)strlen(source_string_1),
        PDL_NO_DATA,
        PDL_NO_DATA,
        PDL_NO_DATA
    );
}

```

5) R_EXDMAC_GetStatus

Synopsis Check the status of an EXDMAC channel.

Prototype

```
bool R_EXDMAC_GetStatus(
    uint8_t data1, // Channel number
    uint8_t * data2, // Status flags pointer
    uint32_t * data3, // Current source address pointer
    uint32_t * data4, // Current destination address pointer
    uint16_t * data5, // Current transfer count pointer
    uint16_t * data6 // Current Repeat or Block size count pointer
);
```

Description Return status flags and current channel registers.

[data1]
The channel number n (where n = 0 to 1).

[data2]
The status flags shall be stored in the following format.
Specify PDL_NO_PTR if the flags are not to be read.

b7	b6	b5	b4
0	Peripheral transfer request (PREQ) 0: No request 1: Requested	EDREQn transfer request (EREQ) 0: No request 1: Requested	Interrupt request (IR)

b3	b2	b1	b0
Transfer Escape End interrupt (ESIF) 0: Idle 1: Generated	Transfer End interrupt (DTIF) 0: Idle 1: Generated	Status (ACT) 0: Idle 1: Operating	Transfer enable (DTE) 0: Disabled 1: Enabled

[data3]
Where the current source address shall be stored. Specify PDL_NO_PTR if it is not required.

[data4]
Where the current destination address shall be stored. Specify PDL_NO_PTR if it is not required.

[data5]
Where the current transfer count shall be stored. Specify PDL_NO_PTR if it is not required.

[data6]
Where the current repeat, block or cluster size shall be stored. Specify PDL_NO_PTR if it is not required.

Return value True if all parameters are valid and exclusive; otherwise false.

Category EXDMA controller

Reference R_EXDMAC_Create

Remarks

- If the Interrupt request flag is set to 1, the flag will be cleared to 0 by this function.
- EXDMAC is not available on 64-pin and 48-pin packages.

Program example

```
/* RPDL definitions */
#include "r_pdl_exdmac.h"

/* RPDL device-specific definitions */
#include "r_pdl_definitions.h"

void func(void)
{
    uint8_t StatusValue;
    uint32_t SourceAddr;

    /* Read the status and current source address for channel 1 */
    R_EXDMAC_GetStatus(
        1,
        &StatusValue,
        &SourceAddr,
        PDL_NO_PTR,
        PDL_NO_PTR,
        PDL_NO_PTR
    );
}
```

4.2.13. Data Transfer Controller

1) R_DTC_Set

Synopsis

Set the Data Transfer Controller options.

Prototype

```
bool R_DTC_Set (
    uint8_t data1,    // Configuration options
    uint32_t * data2 // Vector table base address
);
```

Description

Set the global options for the Data Transfer Controller.

[data1]

Configuration selections.

If multiple selections are required, use “|” to separate each selection.

The default settings are shown in **bold**. Specify PDL_NO_DATA to use the defaults.

- Read skip control

PDL_DTC_READ_SKIP_DISABLE or PDL_DTC_READ_SKIP_ENABLE	Disable or enable skipping of transfer data read when the vector numbers match.
--	---

- Address size control

PDL_DTC_ADDRESS_FULL or PDL_DTC_ADDRESS_SHORT	Select 32-bit (full) or 24-bit (short) address mode.
--	--

[data2]

The first address of the area of on-chip RAM where the DTC vector table shall be stored.

The address must be on a 4 kB boundary i.e. have the format xxxxx000h.

Return value

True if all parameters are valid and exclusive; otherwise false.

Category

Data Transfer Controller

Reference

R_DTC_Create

Remarks

- Before calling R_DTC_Create, call this function.

Program example

```
/* RPDL definitions */
#include "r_pdl_dtc.h"

/* RPDL device-specific definitions */
#include "r_pdl_definitions.h"

/* Reserve an area for the DTC vector table */
#pragma address dtc_vector_table = 0x00001000
uint32_t dtc_vector_table [256];

void func(void)
{
    /* Configure the controller */
    R_DTC_Set(
        PDL_DTC_ADDRESS_SHORT,
        dtc_vector_table
    );
}
```

2) R_DTC_Create

Synopsis Configure the Data Transfer Controller for a transfer.

Prototype

```
bool R_DTC_Create(
    uint32_t data1, // Configuration selection
    uint32_t * data2, // Transfer data start address
    void * data3, // Source start address
    void * data4, // Destination start address
    uint16_t data5, // Transfer count
    uint8_t data6 // Block size
);
```

Description (1/4) Configure DTC activation for one trigger source.

[data1]
 Configuration selections.
 If multiple selections are required, use “|” to separate each selection.
 The default settings are shown in **bold**.

- Transfer mode selection

PDL_DTC_NORMAL or PDL_DTC_REPEAT or PDL_DTC_BLOCK	Normal or Repeat or Block mode.
PDL_DTC_SOURCE or PDL_DTC_DESTINATION	If Repeat or Block mode is selected, select the source or destination side to be the Repeat or Block area.

- Address direction selection

PDL_DTC_SOURCE_ADDRESS_FIXED or PDL_DTC_SOURCE_ADDRESS_PLUS or PDL_DTC_SOURCE_ADDRESS_MINUS	After a data transfer, leave the source address unchanged, increment it or decrement it.
PDL_DTC_DESTINATION_ADDRESS_FIXED or PDL_DTC_DESTINATION_ADDRESS_PLUS or PDL_DTC_DESTINATION_ADDRESS_MINUS	After a data transfer, leave the destination address unchanged, increment it or decrement it.

- Transfer data size

PDL_DTC_SIZE_8 or PDL_DTC_SIZE_16 or PDL_DTC_SIZE_32	Select 1, 2 or 4 bytes to be transferred in one operation.
--	--

- Chain transfer control

PDL_DTC_CHAIN_DISABLE or PDL_DTC_CHAIN_CONTINUOUS or PDL_DTC_CHAIN_0	Disable chain transfer operation, Perform continuous chain transfers or Perform a chain transfer when the transfer counter is changed from 1 to 0, or 1 to transfer size / block size.
---	--

- Interrupt generation

PDL_DTC_IRQ_COMPLETE or PDL_DTC_IRQ_TRANSFER	Select interrupt request generation when the transfer sequence completes, or for every transfer.
--	--

- Trigger selection

Name	Trigger cause
PDL_DTC_TRIGGER_CHAIN or	Chain transfer.
PDL_DTC_TRIGGER_SW or	By software.
PDL_DTC_TRIGGER_CMT0 or PDL_DTC_TRIGGER_CMT1 or PDL_DTC_TRIGGER_CMT2 or PDL_DTC_TRIGGER_CMT3 or	Compare match on channel CMTn (n = 0 to 3).
PDL_DTC_TRIGGER_USB0_D0FIFO0 or PDL_DTC_TRIGGER_USB0_D1FIFO0 or	FIFO interrupt from USB0.
PDL_DTC_TRIGGER_USB1_D0FIFO1 or PDL_DTC_TRIGGER_USB1_D1FIFO1 or	FIFO interrupt from USB1.

Description (2/4)		
	PDL_DTC_TRIGGER_SPI0_RX or	Receive buffer full on SPI channel n (n = 0 to 2).
	PDL_DTC_TRIGGER_SPI1_RX or	
	PDL_DTC_TRIGGER_SPI2_RX or	
	PDL_DTC_TRIGGER_SPI0_TX or	Transmit buffer empty on SPI channel n (n = 0 to 2).
	PDL_DTC_TRIGGER_SPI1_TX or	
	PDL_DTC_TRIGGER_SPI2_TX or	
	PDL_DTC_TRIGGER_IRQ0 or	Valid edge detected on pin IRQn (n = 0 to 15).
	PDL_DTC_TRIGGER_IRQ1 or	
	PDL_DTC_TRIGGER_IRQ2 or	
	PDL_DTC_TRIGGER_IRQ3 or	
	PDL_DTC_TRIGGER_IRQ4 or	
	PDL_DTC_TRIGGER_IRQ5 or	
	PDL_DTC_TRIGGER_IRQ6 or	
	PDL_DTC_TRIGGER_IRQ7 or	
	PDL_DTC_TRIGGER_IRQ8 or	
	PDL_DTC_TRIGGER_IRQ9 or	
	PDL_DTC_TRIGGER_IRQ10 or	
	PDL_DTC_TRIGGER_IRQ11 or	
	PDL_DTC_TRIGGER_IRQ12 or	
	PDL_DTC_TRIGGER_IRQ13 or	
	PDL_DTC_TRIGGER_IRQ14 or	
	PDL_DTC_TRIGGER_IRQ15 or	
	PDL_DTC_TRIGGER_ADC10 or	Conversion completed on the 10-bit ADC unit.
	PDL_DTC_TRIGGER_ADC12 or	Conversion completed on the 12-bit ADC unit.
	PDL_DTC_TRIGGER_TPU_TGI0A or	Input capture/compare match signals on TPU channel 0.
	PDL_DTC_TRIGGER_TPU_TGI0B or	
	PDL_DTC_TRIGGER_TPU_TGI0C or	
	PDL_DTC_TRIGGER_TPU_TGI0D or	Input capture/compare match signals on TPU channel 1.
	PDL_DTC_TRIGGER_TPU_TGI1A or	Input capture/compare match signals on TPU channel 2.
	PDL_DTC_TRIGGER_TPU_TGI1B or	
	PDL_DTC_TRIGGER_TPU_TGI2A or	Input capture/compare match signals on TPU channel 3.
	PDL_DTC_TRIGGER_TPU_TGI2B or	
	PDL_DTC_TRIGGER_TPU_TGI3A or	
	PDL_DTC_TRIGGER_TPU_TGI3B or	Input capture/compare match signals on TPU channel 4.
	PDL_DTC_TRIGGER_TPU_TGI3C or	
	PDL_DTC_TRIGGER_TPU_TGI3D or	Input capture/compare match signals on TPU channel 5.
	PDL_DTC_TRIGGER_TPU_TGI4A or	Input capture/compare match signals on TPU channel 6.
	PDL_DTC_TRIGGER_TPU_TGI4B or	
	PDL_DTC_TRIGGER_TPU_TGI5A or	Input capture/compare match signals on TPU channel 7.
	PDL_DTC_TRIGGER_TPU_TGI5B or	
	PDL_DTC_TRIGGER_TPU_TGI6A or	Input capture/compare match signals on TPU channel 8.
	PDL_DTC_TRIGGER_TPU_TGI6B or	
	PDL_DTC_TRIGGER_TPU_TGI6C or	Input capture/compare match signals on TPU channel 9.
	PDL_DTC_TRIGGER_TPU_TGI6D or	
	PDL_DTC_TRIGGER_TPU_TGI7A or	Input capture/compare match signals on TPU channel 10.
	PDL_DTC_TRIGGER_TPU_TGI7B or	
	PDL_DTC_TRIGGER_TPU_TGI8A or	Input capture/compare match signals on TPU channel 11.
	PDL_DTC_TRIGGER_TPU_TGI8B or	
	PDL_DTC_TRIGGER_TPU_TGI9A or	Input capture/compare match signals on MTU channel 0.
	PDL_DTC_TRIGGER_TPU_TGI9B or	
	PDL_DTC_TRIGGER_TPU_TGI9C or	Input capture/compare match signals on MTU channel 1.
	PDL_DTC_TRIGGER_TPU_TGI9D or	
	PDL_DTC_TRIGGER_TPU_TGI10A or	Input capture/compare match signals on MTU channel 2.
	PDL_DTC_TRIGGER_TPU_TGI10B or	
	PDL_DTC_TRIGGER_TPU_TGI11A or	
	PDL_DTC_TRIGGER_TPU_TGI11B or	
	PDL_DTC_TRIGGER_MTU_TGIA0 or	
	PDL_DTC_TRIGGER_MTU_TGIB0 or	
	PDL_DTC_TRIGGER_MTU_TGIC0 or	
	PDL_DTC_TRIGGER_MTU_TGID0 or	
	PDL_DTC_TRIGGER_MTU_TGIA1 or	
	PDL_DTC_TRIGGER_MTU_TGIB1 or	
	PDL_DTC_TRIGGER_MTU_TGIA2 or	
	PDL_DTC_TRIGGER_MTU_TGIB2 or	

Description (3/4)	
PDL_DTC_TRIGGER_MTU_TGIA3 or PDL_DTC_TRIGGER_MTU_TGIB3 or PDL_DTC_TRIGGER_MTU_TGIC3 or PDL_DTC_TRIGGER_MTU_TGID3 or	Input capture/compare match signals on MTU channel 3.
PDL_DTC_TRIGGER_MTU_TGIA4 or PDL_DTC_TRIGGER_MTU_TGIB4 or PDL_DTC_TRIGGER_MTU_TGIC4 or PDL_DTC_TRIGGER_MTU_TGID4 or	Input capture/compare match signals on MTU channel 4.
PDL_DTC_TRIGGER_MTU_TCIV4 or PDL_DTC_TRIGGER_MTU_TGIU5 or PDL_DTC_TRIGGER_MTU_TGIV5 or PDL_DTC_TRIGGER_MTU_TGIW5 or	Counter over or underflow on MTU channel 4. Input capture/compare match signals on MTU channel 5.
PDL_DTC_TRIGGER_CMIA0 or PDL_DTC_TRIGGER_CMIA1 or PDL_DTC_TRIGGER_CMIA2 or PDL_DTC_TRIGGER_CMIA3 or	Compare match A on TMR channel n (n = 0 to 3).
PDL_DTC_TRIGGER_CMIB0 or PDL_DTC_TRIGGER_CMIB1 or PDL_DTC_TRIGGER_CMIB2 or PDL_DTC_TRIGGER_CMIB3 or	Compare match B on TMR channel n (n = 0 to 3).
PDL_DTC_TRIGGER_IIC0_RX or PDL_DTC_TRIGGER_IIC1_RX or PDL_DTC_TRIGGER_IIC2_RX or PDL_DTC_TRIGGER_IIC3_RX or	Receive buffer full on I ² C channel n (n = 0 to 3).
PDL_DTC_TRIGGER_IIC0_TX or PDL_DTC_TRIGGER_IIC1_TX or PDL_DTC_TRIGGER_IIC2_TX or PDL_DTC_TRIGGER_IIC3_TX or	Transmit buffer empty on I ² C channel n (n = 0 to 3).
PDL_DTC_TRIGGER_DMCI0 or PDL_DTC_TRIGGER_DMCI1 or PDL_DTC_TRIGGER_DMCI2 or PDL_DTC_TRIGGER_DMCI3 or	Transfer complete on DMAC channel n (n = 0 to 3).
PDL_DTC_TRIGGER_EXDMCI0 or PDL_DTC_TRIGGER_EXDMCI1 or	Transfer complete on EXDMAC channel n (n = 0 or 1).
PDL_DTC_TRIGGER_RXI0 or PDL_DTC_TRIGGER_RXI1 or PDL_DTC_TRIGGER_RXI2 or PDL_DTC_TRIGGER_RXI3 or PDL_DTC_TRIGGER_RXI4 or PDL_DTC_TRIGGER_RXI5 or PDL_DTC_TRIGGER_RXI6 or PDL_DTC_TRIGGER_RXI7 or PDL_DTC_TRIGGER_RXI8 or PDL_DTC_TRIGGER_RXI9 or PDL_DTC_TRIGGER_RXI10 or PDL_DTC_TRIGGER_RXI11 or PDL_DTC_TRIGGER_RXI12 or	Receive buffer full on SCI channel n (n = 0 to 12).
PDL_DTC_TRIGGER_TXI0 or PDL_DTC_TRIGGER_TXI1 or PDL_DTC_TRIGGER_TXI2 or PDL_DTC_TRIGGER_TXI3 or PDL_DTC_TRIGGER_TXI4 or PDL_DTC_TRIGGER_TXI5 or PDL_DTC_TRIGGER_TXI6 or PDL_DTC_TRIGGER_TXI7 or PDL_DTC_TRIGGER_TXI8 or PDL_DTC_TRIGGER_TXI9 or PDL_DTC_TRIGGER_TXI10 or PDL_DTC_TRIGGER_TXI11 or PDL_DTC_TRIGGER_TXI12	Transmit buffer empty on SCI channel n (n = 0 to 12).

Description (4/4)	<p>[data2] The start address of the transfer data area. It must be a multiple of 4. For short address mode, 12 bytes are required to store the transfer data. For full address mode, 16 bytes are required.</p> <p>[data3] The source start address. The valid range depends on the address mode (short or full).</p> <p>[data4] The destination start address. The valid range depends on the address mode (short or full).</p> <p>[data5] The number of transfers to take place. For normal or block mode, valid between 0 and 65535 (0 = 65536 transfers). For repeat mode, valid between 0 and 255 (0 = 256 transfers).</p> <p>[data6] The size of each block transfer. Valid between 0 and 255 (0 = 256 units). Ignored in normal or repeat mode.</p>
Return value	True if all parameters are valid and exclusive; otherwise false.
Category	Data Transfer Controller
Reference	R_DTC_Set, R_DTC_Control
Remarks	<ul style="list-style-type: none"> • If address increment or decrement is selected, the address changes according to the number of bytes (1, 2 or 4) in each transfer. • Before calling this function, call R_DTC_Set. • Call this function before configuring the peripherals that will be involved in the data transfer. • Call this function once for each peripheral that will trigger a transfer, and for each chained transfer. • For chain transfers, each transfer data area in the chain must be contiguous. • When all calls to this function are complete, call R_DTC_Control to start the DTC. • Some of MTU (MTU0 to MTU5) and TPU (TPU6 to TPU11) trigger selections are sharing the same interrupt vectors. For details, please refer to device hardware manual.

Program example

```

/* RPDL definitions */
#include "r_pdl_dtc.h"

/* RPDL device-specific definitions */
#include "r_pdl_definitions.h"

/* Reserve 16 bytes (full address mode) for the CMT0-triggered transfer
data area */
/* Use a 32-bit type to make the address a multiple of 4 */
uint32_t dtc_cmt0_transfer_data[4];

void func(void)
{
    /* Configure the DTC for CMT0 */
    R_DTC_Create(
        PDL_DTC_NORMAL | PDL_DTC_SOURCE_ADDRESS_FIXED | \
        PDL_DTC_DESTINATION_ADDRESS_PLUS | PDL_DTC_SIZE_8 | \
        PDL_DTC_TRIGGER_CMT0,
        dtc_cmt0_transfer_data,
        0x0000AA00,
        0x0000BB00,
        100,
        0
    );
}

```

3) R_DTC_Destroy**Synopsis**

Disable the Data Transfer Controller.

Prototype

```
bool R_DTC_Destroy(
    void // No parameter is required
);
```

Description

Shutdown the Data Transfer Controller.

Return value

True.

Category

Data Transfer Controller

Reference

R_DTC_Control

Remarks

- This function will also shut down the DMAC.
- Before calling this function,
 - i. If another peripheral is being used to trigger a DTC transfer, stop the triggers from that peripheral (using Control or Destroy for that peripheral).
 - ii. Use R_DTC_Control to stop the DTC.
 - iii. Stop the DMAC.

Program example

```
/* RPDL definitions */
#include "r_pdl_dtc.h"

/* RPDL device-specific definitions */
#include "r_pdl_definitions.h"

void func(void)
{
    /* Shutdown the DTC (& DMAC) */
    R_DTC_Destroy(
    );
}
```

4) R_DTC_Control

Synopsis Control the Data Transfer Controller.

Prototype

```
bool R_DTC_Control (
    uint32_t data1, // Control options
    uint32_t * data2, // Transfer data start address
    void * data3, // Source start address
    void * data4, // Destination start address
    uint16_t data5, // Transfer count
    uint8_t data6 // Block size
);
```

Description Modify the operation of the Data Transfer Controller.

[data1]
Control the operation.

- Stop / Start control

PDL_DTC_STOP or PDL_DTC_START	Enable / re-enable or suspend DTC transfers.
-------------------------------	--

- The transfer registers to be modified, using the selected parameters.

PDL_DTC_UPDATE_SOURCE	The Source Address register, using parameter data3.
PDL_DTC_UPDATE_DESTINATION	The Transfer Address register, using parameter data4.
PDL_DTC_UPDATE_COUNT	The Transfer Count register, using parameter data5.
PDL_DTC_UPDATE_BLOCK_SIZE	The Block Size register, using parameter data6.

- Transfer trigger control
When the transfer count specified in R_DTC_Create is completed, the DTC will ignore further interrupts from that trigger source.
If you require the interrupt to trigger another transfer, specify the trigger used in the relevant call of R_DTC_Create.

[data2]
If transfer registers are to be modified, specify the start address of the transfer data area (the same as that declared in R_DTC_Create).
If no registers are to be modified, specify PDL_NO_PTR.

[data3]
The new source start address. The valid range depends on the address mode (short or full).
Specify PDL_NO_PTR if not required.

[data4]
The new destination start address. The valid range depends on the address mode (short or full).
Specify PDL_NO_PTR if not required.

[data5]
The new number of transfers to take place.
For normal or block mode, valid between 0 and 65535 (0 = 65536 transfers).
For repeat mode, valid between 0 and 255 (0 = 256 transfers).
Specify PDL_NO_DATA if not required.

[data6]
The new size of each block transfer. Valid between 0 and 255 (0 = 256 units).
Ignored in normal or repeat mode.
Specify PDL_NO_DATA if not required.

Return value True if all parameters are valid and exclusive; otherwise false.

Category Data Transfer Controller

Reference R_DTC_Create

Remarks

- This function must be called in order to start the DTC (R_DTC_Create must be called at least once before starting the DTC).
- Start the DTC before generating a transfer trigger.

Program example

```
/* RPDL definitions */
#include "r_pdl_dtc.h"

/* RPDL device-specific definitions */
#include "r_pdl_definitions.h"

void func(void)
{
    /* Start the controller */
    R_DTC_Control(
        PDL_DTC_START,
        PDL_NO_PTR,
        PDL_NO_PTR,
        PDL_NO_PTR,
        PDL_NO_DATA,
        PDL_NO_DATA
    );

    /* Update the parameters for CMT0-triggered transfers */
    R_DTC_Control(
        PDL_DTC_UPDATE_DESTINATION | PDL_DTC_UPDATE_COUNT,
        dtc_cmt0_transfer_data,
        PDL_NO_PTR,
        0x0000BB00,
        100,
        PDL_NO_DATA
    );
}
```

5) R_DTC_GetStatus

Synopsis

Check the status of the Data Transfer Controller.

Prototype

```
bool R_DTC_GetStatus(
    uint32_t * data1, // Transfer data start address
    uint16_t * data2, // Status flags pointer
    uint32_t * data3, // Current source address pointer
    uint32_t * data4, // Current destination address pointer
    uint16_t * data5, // Current transfer count pointer
    uint8_t * data6  // Current block size count pointer
);
```

Description

Return status flags and current channel registers.

[data1]

The start address of the transfer data area.

If all parameters data3, data4, data5 and data6 are not required, specify PDL_NO_PTR.

[data2]

The status flags shall be stored in the following format.

Specify PDL_NO_PTR if the status flags are not required.

b15	b14 – b8	b7 - b0
0: Idle	0	The trigger vector (valid only when bit b15 = 1)
1: A transfer is in progress		

[data3]

Where the current source address shall be stored. Ignored if data1 is set to PDL_NO_PTR. If this value is not required, specify PDL_NO_PTR.

[data4]

Where the current destination address shall be stored. Ignored if data1 is set to PDL_NO_PTR. If this value is not required, specify PDL_NO_PTR.

[data5]

Where the current transfer count shall be stored. Ignored if data1 is set to PDL_NO_PTR. If this value is not required, specify PDL_NO_PTR.

[data6]

Where the current block size count shall be stored. Ignored if data1 is set to PDL_NO_PTR. If this value is not required, specify PDL_NO_PTR.

Return value

True if all parameters are valid and exclusive; otherwise false.

Category

Data Transfer Controller

Reference

R_DTC_Create

Remarks

- The start address of the transfer data area is the same as that declared in R_DTC_Create.

Program example

```
/* RPDL definitions */
#include "r_pdl_dtc.h"

/* RPDL device-specific definitions */
#include "r_pdl_definitions.h"

/* Declared in the R_DTC_Create example */
extern uint32_t dtc_cmt0_transfer_data[];

void func(void)
{
    uint16_t StatusValue;
    uint32_t SourceAddr;

    /* Read the status and current source address for the CMT0 transfer
    */
    R_DTC_GetStatus(
        dtc_cmt0_transfer_data,
        &StatusValue,
        &SourceAddr,
        PDL_NO_PTR,
        PDL_NO_PTR,
        PDL_NO_PTR
    );
}
```

4.2.14. Multi-Function Timer Pulse Unit

1) R_MTU2_Set

Synopsis

Configure the Multi-function Timer Pulse Unit.

Prototype

```
bool R_MTU2_Set(
    uint8_t data1, // Channel selection
    uint32_t data2, // Configuration for a channel
    uint16_t data3 // Configuration for MTCLK pins
);
```

Description (1/2)

Set up the global MTU options.

[data1]

The channel number n (where n = 0 to 5).

[data2]

Pin configuration for the channel. Use “|” to separate each selection.

- Valid when n = 0

PDL_MTU2_PIN_0A_P34 or PDL_MTU2_PIN_0A_PB3	Select the P34 or PB3 pin for MTIOC0A.
PDL_MTU2_PIN_0B_P13 or PDL_MTU2_PIN_0B_P15 or PDL_MTU2_PIN_0B_PA1	Select the P13, P15 or PA1 pin for MTIOC0B.
PDL_MTU2_PIN_0C_P32 or PDL_MTU2_PIN_0C_PB1	Select the P32 or PB1 pin for MTIOC0C.
PDL_MTU2_PIN_0D_P33 or PDL_MTU2_PIN_0D_PA3	Select the P33 or PA3 pin for MTIOC0D.

- Valid when n = 1

PDL_MTU2_PIN_1A_P20 or PDL_MTU2_PIN_1A_PE4	Select the P20 or PE4 pin for MTIOC1A.
PDL_MTU2_PIN_1B_P21 or PDL_MTU2_PIN_1B_PB5	Select the P21 or PB5 pin for MTIOC1B.

- Valid when n = 2

PDL_MTU2_PIN_2A_P26 or PDL_MTU2_PIN_2A_PB5	Select the P26 or PB5 pin for MTIOC2A.
PDL_MTU2_PIN_2B_P27 or PDL_MTU2_PIN_2B_PE5	Select the P27 or PE5 pin for MTIOC2B.

- Valid when n = 3

PDL_MTU2_PIN_3A_P14 or PDL_MTU2_PIN_3A_P17 or PDL_MTU2_PIN_3A_PC1 or PDL_MTU2_PIN_3A_PC7	Select the P14, P17, PC1 or PC7 pin for MTIOC3A.
PDL_MTU2_PIN_3B_P17 or PDL_MTU2_PIN_3B_P22 or PDL_MTU2_PIN_3B_P80 or PDL_MTU2_PIN_3B_PB7 or PDL_MTU2_PIN_3B_PC5	Select the P17, P22, P80, PB7 or PC5 pin for MTIOC3B.
PDL_MTU2_PIN_3C_P16 or PDL_MTU2_PIN_3C_P56 or PDL_MTU2_PIN_3C_PC0 or PDL_MTU2_PIN_3C_PC6 or PDL_MTU2_PIN_3C_PJ3	Select the P16, P56, PC0, PC6 or PJ3 pin for MTIOC3C.
PDL_MTU2_PIN_3D_P16 or PDL_MTU2_PIN_3D_P23 or PDL_MTU2_PIN_3D_P81 or PDL_MTU2_PIN_3D_PB6 or PDL_MTU2_PIN_3D_PC4	Select the P16, P23, P81, PB6 or PC4 pin for MTIOC3D.

Description (2/2)	<ul style="list-style-type: none"> Valid when n = 4 <table border="1" style="width: 100%; border-collapse: collapse;"> <tr> <td style="width: 50%; padding: 2px;">PDL_MTU2_PIN_4A_P24 or PDL_MTU2_PIN_3D_P82 or PDL_MTU2_PIN_4A_PA0 or PDL_MTU2_PIN_4A_PB3 or PDL_MTU2_PIN_4A_PE2</td> <td style="width: 50%; padding: 2px;">Select the P24,P82, PA0, PB3 or PE2 pin for MTIOC4A.</td> </tr> <tr> <td style="padding: 2px;">PDL_MTU2_PIN_4B_P30 or PDL_MTU2_PIN_4B_P54 or PDL_MTU2_PIN_4B_PC2 or PDL_MTU2_PIN_4B_PD1 or PDL_MTU2_PIN_4B_PE3</td> <td style="padding: 2px;">Select the P30, P54, PC2, PD1 or PE3 pin for MTIOC4B.</td> </tr> <tr> <td style="padding: 2px;">PDL_MTU2_PIN_4C_P25 or PDL_MTU2_PIN_4C_P83 or PDL_MTU2_PIN_4C_PB1 or PDL_MTU2_PIN_4C_PE1 or PDL_MTU2_PIN_4C_PE5</td> <td style="padding: 2px;">Select the P25, P83, PB1, PE1 or PE5 pin for MTIOC4C.</td> </tr> <tr> <td style="padding: 2px;">PDL_MTU2_PIN_4D_P31 or PDL_MTU2_PIN_4D_P55 or PDL_MTU2_PIN_4D_PC3 or PDL_MTU2_PIN_4D_PD2 or PDL_MTU2_PIN_4D_PE4</td> <td style="padding: 2px;">Select the P31, P55, PC3, PD2 or PE4 pin for MTIOC4D.</td> </tr> </table> Valid when n = 5 <table border="1" style="width: 100%; border-collapse: collapse;"> <tr> <td style="width: 50%; padding: 2px;">PDL_MTU2_PIN_5U_P12 or PDL_MTU2_PIN_5U_PA4 or PDL_MTU2_PIN_5U_PD7</td> <td style="width: 50%; padding: 2px;">Select the P12, PA4 or PD7 pin for MTIOC5U.</td> </tr> <tr> <td style="padding: 2px;">PDL_MTU2_PIN_5V_P11 or PDL_MTU2_PIN_5V_PA6 or PDL_MTU2_PIN_5V_PD6</td> <td style="padding: 2px;">Select the P11, PA6 or PD6 pin for MTIOC5V.</td> </tr> <tr> <td style="padding: 2px;">PDL_MTU2_PIN_5W_P10 or PDL_MTU2_PIN_5W_PB0 or PDL_MTU2_PIN_5W_PD5</td> <td style="padding: 2px;">Select the P10, PB0 or PD5 pin for MTIOC5W.</td> </tr> </table> <p>[data3] MTCLK Pin configuration. Use “ ” to separate each selection. Specify PDL_NO_DATA if no MTCLK pin is required.</p> <ul style="list-style-type: none"> Valid when n = 0, 1, 2, 3 or 4 <table border="1" style="width: 100%; border-collapse: collapse;"> <tr> <td style="width: 50%; padding: 2px;">PDL_MTU2_PIN_CLKA_P14 or PDL_MTU2_PIN_CLKA_P24 or PDL_MTU2_PIN_CLKA_PA4 or PDL_MTU2_PIN_CLKA_PC6</td> <td style="width: 50%; padding: 2px;">Select the P14, P24, PA4 or PC6 pin for MTCLKA.</td> </tr> <tr> <td style="padding: 2px;">PDL_MTU2_PIN_CLKB_P15 or PDL_MTU2_PIN_CLKB_P25 or PDL_MTU2_PIN_CLKB_PA6 or PDL_MTU2_PIN_CLKB_PC7</td> <td style="padding: 2px;">Select the P15, P25, PA6 or PC7 pin for MTCLKB.</td> </tr> </table> Valid when n = 0 or 2 <table border="1" style="width: 100%; border-collapse: collapse;"> <tr> <td style="width: 50%; padding: 2px;">PDL_MTU2_PIN_CLKC_P22 or PDL_MTU2_PIN_CLKC_PA1 or PDL_MTU2_PIN_CLKC_PC4</td> <td style="width: 50%; padding: 2px;">Select the P22, PA1 or PC4 pin for MTCLKC.</td> </tr> <tr> <td style="padding: 2px;">PDL_MTU2_PIN_CLKD_P23 or PDL_MTU2_PIN_CLKD_PA3 or PDL_MTU2_PIN_CLKD_PC5</td> <td style="padding: 2px;">Select the P23, PA3 or PC5 pin for MTCLKD. When n = 2, required in Phase Counting Mode only,</td> </tr> </table> 	PDL_MTU2_PIN_4A_P24 or PDL_MTU2_PIN_3D_P82 or PDL_MTU2_PIN_4A_PA0 or PDL_MTU2_PIN_4A_PB3 or PDL_MTU2_PIN_4A_PE2	Select the P24,P82, PA0, PB3 or PE2 pin for MTIOC4A.	PDL_MTU2_PIN_4B_P30 or PDL_MTU2_PIN_4B_P54 or PDL_MTU2_PIN_4B_PC2 or PDL_MTU2_PIN_4B_PD1 or PDL_MTU2_PIN_4B_PE3	Select the P30, P54, PC2, PD1 or PE3 pin for MTIOC4B.	PDL_MTU2_PIN_4C_P25 or PDL_MTU2_PIN_4C_P83 or PDL_MTU2_PIN_4C_PB1 or PDL_MTU2_PIN_4C_PE1 or PDL_MTU2_PIN_4C_PE5	Select the P25, P83, PB1, PE1 or PE5 pin for MTIOC4C.	PDL_MTU2_PIN_4D_P31 or PDL_MTU2_PIN_4D_P55 or PDL_MTU2_PIN_4D_PC3 or PDL_MTU2_PIN_4D_PD2 or PDL_MTU2_PIN_4D_PE4	Select the P31, P55, PC3, PD2 or PE4 pin for MTIOC4D.	PDL_MTU2_PIN_5U_P12 or PDL_MTU2_PIN_5U_PA4 or PDL_MTU2_PIN_5U_PD7	Select the P12, PA4 or PD7 pin for MTIOC5U.	PDL_MTU2_PIN_5V_P11 or PDL_MTU2_PIN_5V_PA6 or PDL_MTU2_PIN_5V_PD6	Select the P11, PA6 or PD6 pin for MTIOC5V.	PDL_MTU2_PIN_5W_P10 or PDL_MTU2_PIN_5W_PB0 or PDL_MTU2_PIN_5W_PD5	Select the P10, PB0 or PD5 pin for MTIOC5W.	PDL_MTU2_PIN_CLKA_P14 or PDL_MTU2_PIN_CLKA_P24 or PDL_MTU2_PIN_CLKA_PA4 or PDL_MTU2_PIN_CLKA_PC6	Select the P14, P24, PA4 or PC6 pin for MTCLKA.	PDL_MTU2_PIN_CLKB_P15 or PDL_MTU2_PIN_CLKB_P25 or PDL_MTU2_PIN_CLKB_PA6 or PDL_MTU2_PIN_CLKB_PC7	Select the P15, P25, PA6 or PC7 pin for MTCLKB.	PDL_MTU2_PIN_CLKC_P22 or PDL_MTU2_PIN_CLKC_PA1 or PDL_MTU2_PIN_CLKC_PC4	Select the P22, PA1 or PC4 pin for MTCLKC.	PDL_MTU2_PIN_CLKD_P23 or PDL_MTU2_PIN_CLKD_PA3 or PDL_MTU2_PIN_CLKD_PC5	Select the P23, PA3 or PC5 pin for MTCLKD. When n = 2, required in Phase Counting Mode only,
PDL_MTU2_PIN_4A_P24 or PDL_MTU2_PIN_3D_P82 or PDL_MTU2_PIN_4A_PA0 or PDL_MTU2_PIN_4A_PB3 or PDL_MTU2_PIN_4A_PE2	Select the P24,P82, PA0, PB3 or PE2 pin for MTIOC4A.																						
PDL_MTU2_PIN_4B_P30 or PDL_MTU2_PIN_4B_P54 or PDL_MTU2_PIN_4B_PC2 or PDL_MTU2_PIN_4B_PD1 or PDL_MTU2_PIN_4B_PE3	Select the P30, P54, PC2, PD1 or PE3 pin for MTIOC4B.																						
PDL_MTU2_PIN_4C_P25 or PDL_MTU2_PIN_4C_P83 or PDL_MTU2_PIN_4C_PB1 or PDL_MTU2_PIN_4C_PE1 or PDL_MTU2_PIN_4C_PE5	Select the P25, P83, PB1, PE1 or PE5 pin for MTIOC4C.																						
PDL_MTU2_PIN_4D_P31 or PDL_MTU2_PIN_4D_P55 or PDL_MTU2_PIN_4D_PC3 or PDL_MTU2_PIN_4D_PD2 or PDL_MTU2_PIN_4D_PE4	Select the P31, P55, PC3, PD2 or PE4 pin for MTIOC4D.																						
PDL_MTU2_PIN_5U_P12 or PDL_MTU2_PIN_5U_PA4 or PDL_MTU2_PIN_5U_PD7	Select the P12, PA4 or PD7 pin for MTIOC5U.																						
PDL_MTU2_PIN_5V_P11 or PDL_MTU2_PIN_5V_PA6 or PDL_MTU2_PIN_5V_PD6	Select the P11, PA6 or PD6 pin for MTIOC5V.																						
PDL_MTU2_PIN_5W_P10 or PDL_MTU2_PIN_5W_PB0 or PDL_MTU2_PIN_5W_PD5	Select the P10, PB0 or PD5 pin for MTIOC5W.																						
PDL_MTU2_PIN_CLKA_P14 or PDL_MTU2_PIN_CLKA_P24 or PDL_MTU2_PIN_CLKA_PA4 or PDL_MTU2_PIN_CLKA_PC6	Select the P14, P24, PA4 or PC6 pin for MTCLKA.																						
PDL_MTU2_PIN_CLKB_P15 or PDL_MTU2_PIN_CLKB_P25 or PDL_MTU2_PIN_CLKB_PA6 or PDL_MTU2_PIN_CLKB_PC7	Select the P15, P25, PA6 or PC7 pin for MTCLKB.																						
PDL_MTU2_PIN_CLKC_P22 or PDL_MTU2_PIN_CLKC_PA1 or PDL_MTU2_PIN_CLKC_PC4	Select the P22, PA1 or PC4 pin for MTCLKC.																						
PDL_MTU2_PIN_CLKD_P23 or PDL_MTU2_PIN_CLKD_PA3 or PDL_MTU2_PIN_CLKD_PC5	Select the P23, PA3 or PC5 pin for MTCLKD. When n = 2, required in Phase Counting Mode only,																						

Return value

True if all parameters are valid and exclusive; otherwise false.

Category

Multi-function Timer Pulse Unit

Reference

R_MTU2_Create

Remarks

- Before calling R_MTU2_Create, call this function to configure the relevant pins.
- Make sure no more than one peripheral function is assigned to a single pin.
- Make sure the configuration of MTCLK pins is consistent for all the channels.
- There are some pin restrictions when not using the 176 pin device package.

Program example

```
#include "r_pdl_mtu2.h"

void func(void)
{
    /* Configure the MTU pins */
    R_MTU2_Set(
        0,
        PDL_MTU2_PIN_0A_P34,
        PDL_MTU2_PIN_CLKA_P14
    );
}
```

2) R_MTU2_Create

Synopsis Configure an MTU channel.

Prototype

```
bool R_MTU2_Create(
    uint8_t data1, // Channel selection
    R_MTU2_Create_structure * data2 // A pointer to the structure
);
```

R_MTU2_Create_structure members:

```
uint32_t channel_mode // Configuration selection
uint32_t counter_operation // Configuration selection
uint32_t ADC_trigger_operation // Configuration selection
uint16_t buffer_operation // Configuration selection
uint32_t TGR_A_B_operation // Configuration selection
uint32_t TGR_C_D_operation // Configuration selection
uint32_t TGR_U_V_W_operation // Configuration selection
uint16_t noise_filter_operation // Configuration selection
uint16_t TCNT_TCNTU_value // Register value
uint16_t TGRA_TCNTV_value // Register value
uint16_t TGRB_TCNTW_value // Register value
uint16_t TGRC_TGRU_value // Register value
uint16_t TGRD_TGRV_value // Register value
uint16_t TGRE_TGRW_value // Register value
uint16_t TGRF_TADCORA_value // Register value
uint16_t TADCORB_value // Register value
uint16_t TADCOBRA_value // Register value
uint16_t TADCOBRB_value // Register value
void * func1 // Callback function
void * func2 // Callback function
void * func3 // Callback function
void * func4 // Callback function
uint8_t interrupt_priority_1 // Interrupt priority level
void * func5 // Callback function
void * func6 // Callback function
uint8_t interrupt_priority_2 // Interrupt priority level
void * func7 // Callback function
void * func8 // Callback function
uint8_t interrupt_priority_3 // Interrupt priority level
```

Description (1/9) Set up a 16-bit MTU2 channel.

[data1]
The channel number n (where n = 0 to 5).

[channel_mode]
Configure the channel mode.
If multiple selections are required, use “|” to separate each selection.
The default settings are shown in **bold**.

- Operation mode. Valid for n = 0 to 4, unless stated otherwise.

PDL_MTU2_MODE_NORMAL or	Normal operation.
PDL_MTU2_MODE_PWM1 or	Pulse Width Modulation (PWM) mode 1.
PDL_MTU2_MODE_PWM2 or	Pulse Width Modulation (PWM) mode 2. Valid for n = 0, 1, and 2.
PDL_MTU2_MODE_PHASE1 or PDL_MTU2_MODE_PHASE2 or PDL_MTU2_MODE_PHASE3 or PDL_MTU2_MODE_PHASE4 or	Phase counting mode 1, 2, 3 or 4. Valid for n = 1 and 2.
PDL_MTU2_MODE_PWM_RS or	Reset-synchronised PWM mode. Valid for n = 3.
PDL_MTU2_MODE_PWM_COMP1 or PDL_MTU2_MODE_PWM_COMP2 or PDL_MTU2_MODE_PWM_COMP3	Complementary PWM mode 1, 2 or 3. Valid for n = 3. Select Normal operation when configuring channel 4.

Description (2/9)

- Synchronous mode. Valid for n = 0 to 4.

PDL_MTU2_SYNC_DISABLE or PDL_MTU2_SYNC_ENABLE	Disable or enable synchronous presetting / clearing.
--	--

- DMAC / DTC event trigger control. Valid for n = 0 to 4 unless stated otherwise.

PDL_MTU2_TGRA_DMAC_DTC_TRIGGER_DISABLE or PDL_MTU2_TGRA_DMAC_TRIGGER_ENABLE or PDL_MTU2_TGRA_DTC_TRIGGER_ENABLE	TGRA compare match or input capture.
PDL_MTU2_TGRB_DTC_TRIGGER_DISABLE or PDL_MTU2_TGRB_DTC_TRIGGER_ENABLE	TGRB compare match or input capture.
PDL_MTU2_TGRC_DTC_TRIGGER_DISABLE or PDL_MTU2_TGRC_DTC_TRIGGER_ENABLE	TGRC compare match or input capture. Valid for n = 0, 3 and 4.
PDL_MTU2_TGRD_DTC_TRIGGER_DISABLE or PDL_MTU2_TGRD_DTC_TRIGGER_ENABLE	TGRD compare match or input capture. Valid for n = 0, 3 and 4.
PDL_MTU2_TCIV_DTC_TRIGGER_DISABLE or PDL_MTU2_TCIV_DTC_TRIGGER_ENABLE	Counter overflow or underflow. Valid for n = 4.

- DTC event trigger control. Valid for n = 5.

PDL_MTU2_TGRU_DTC_TRIGGER_DISABLE or PDL_MTU2_TGRU_DTC_TRIGGER_ENABLE	TGRU compare match or input capture.
PDL_MTU2_TGRV_DTC_TRIGGER_DISABLE or PDL_MTU2_TGRV_DTC_TRIGGER_ENABLE	TGRV compare match or input capture.
PDL_MTU2_TGRW_DTC_TRIGGER_DISABLE or PDL_MTU2_TGRW_DTC_TRIGGER_ENABLE	TGRW compare match or input capture.

[counter_operation]

Configure the counter operation.

If multiple selections are required, use “|” to separate each selection.

The default settings are shown in **bold**. Specify PDL_NO_DATA to use the defaults.

- TCNT counter clock source selection. Valid for n = 0 to 4 unless stated otherwise. Not effective for n = 1 and 2 in Phase Counting Mode.

PDL_MTU2_CLK_PCLK_DIV_1 or PDL_MTU2_CLK_PCLK_DIV_4 or PDL_MTU2_CLK_PCLK_DIV_16 or PDL_MTU2_CLK_PCLK_DIV_64 or PDL_MTU2_CLK_PCLK_DIV_256 or PDL_MTU2_CLK_PCLK_DIV_1024 or PDL_MTU2_CLK_MTCLKA or PDL_MTU2_CLK_MTCLKB or PDL_MTU2_CLK_MTCLKC or PDL_MTU2_CLK_MTCLKD or PDL_MTU2_CLK_CASCADE	The internal clock signal PCLKB ÷ 1, 4, 16 or 64. PCLKB ÷ 256. Valid for n = 1, 3 and 4. PCLKB ÷ 1024. Valid for n = 2, 3 and 4. MTCLKA pin input. Valid for n = 0 to 4. MTCLKB pin input. Valid for n = 0 to 4. MTCLKC pin input. Valid for n = 0 or 2. MTCLKD pin input. Valid for n = 0. The overflow / underflow signal from channel (n+1). Valid for n = 1.
--	---

- TCNT counter clock edge selection. Valid for n = 0 to 4. Not effective for n = 1 and 2 in Phase Counting Mode.

PDL_MTU2_CLK_RISING or PDL_MTU2_CLK_FALLING or PDL_MTU2_CLK_BOTH	The TCNT counter clock signal shall be counted on rising, falling or both edges.
---	--

- TCNT counter clearing. Valid for n = 0 to 4 unless stated otherwise.

PDL_MTU2_CLEAR_DISABLE or PDL_MTU2_CLEAR_TGRA or PDL_MTU2_CLEAR_TGRB or PDL_MTU2_CLEAR_SYNC or PDL_MTU2_CLEAR_TGRC or PDL_MTU2_CLEAR_TGRD	Clearing is disabled. Cleared by TGRA compare match or input capture. Cleared by TGRB compare match or input capture. Cleared by counter clearing on another channel configured for synchronous operation. Cleared by TGRC compare match or input capture. Valid for n = 0, 3 and 4. Cleared by TGRD compare match or input capture. Valid for n = 0, 3 and 4.
--	---

Description (3/9)

- Counter clock source selection. Valid for n = 5.

PDL_MTU2_CLKU_PCLK_DIV_1 or PDL_MTU2_CLKU_PCLK_DIV_4 or PDL_MTU2_CLKU_PCLK_DIV_16 or PDL_MTU2_CLKU_PCLK_DIV_64	Counter TCNTU is supplied by the internal clock signal PCLKB ÷ 1, 4, 16 or 64.
PDL_MTU2_CLKV_PCLK_DIV_1 or PDL_MTU2_CLKV_PCLK_DIV_4 or PDL_MTU2_CLKV_PCLK_DIV_16 or PDL_MTU2_CLKV_PCLK_DIV_64	Counter TCNTV is supplied by the internal clock signal PCLKB ÷ 1, 4, 16 or 64.
PDL_MTU2_CLKW_PCLK_DIV_1 or PDL_MTU2_CLKW_PCLK_DIV_4 or PDL_MTU2_CLKW_PCLK_DIV_16 or PDL_MTU2_CLKW_PCLK_DIV_64	Counter TCNTW is supplied by the internal clock signal PCLKB ÷ 1, 4, 16 or 64.

- Counter clearing (U, V and W counters). Valid for n = 5.

PDL_MTU2_CLEAR_TGRU_DISABLE or PDL_MTU2_CLEAR_TGRU_ENABLE	Disable or enable clearing of TCNTU by TGRU compare match or input capture.
PDL_MTU2_CLEAR_TGRV_DISABLE or PDL_MTU2_CLEAR_TGRV_ENABLE	Disable or enable clearing of TCNTV by TGRV compare match or input capture.
PDL_MTU2_CLEAR_TGRW_DISABLE or PDL_MTU2_CLEAR_TGRW_ENABLE	Disable or enable clearing of TCNTW by TGRW compare match or input capture.

[ADC_trigger_operation]

Configure the ADC trigger operation.

If multiple selections are required, use “|” to separate each selection.

The default settings are shown in **bold**. Specify PDL_NO_DATA to use the defaults.

- ADC conversion trigger control. Valid for n = 0 to 4 unless stated otherwise.

PDL_MTU2_ADC_TRIG_TGRA_DISABLE or PDL_MTU2_ADC_TRIG_TGRA_ENABLE	Disable or enable ADC start requests on a TGRA compare match or input capture.
PDL_MTU2_ADC_TRIG_TROUGH_DISABLE or PDL_MTU2_ADC_TRIG_TROUGH_ENABLE	Disable or enable ADC start requests on a TCNT underflow. Valid for n = 4 in complementary PWM mode.

- Control ADC trigger interrupt skipping. Valid for n = 4 in complementary PWM mode.

PDL_MTU2_ADC_TRIG_A_TROUGH_INT_SKIP_DISABLE or PDL_MTU2_ADC_TRIG_A_TROUGH_INT_SKIP_ENABLE	Disable or link interrupt skipping to ADC trigger TRGnAN on a TCNT underflow.
PDL_MTU2_ADC_TRIG_B_TROUGH_INT_SKIP_DISABLE or PDL_MTU2_ADC_TRIG_B_TROUGH_INT_SKIP_ENABLE	Disable or link interrupt skipping to ADC trigger TRGnBN on a TCNT underflow.
PDL_MTU2_ADC_TRIG_A_CREST_INT_SKIP_DISABLE or PDL_MTU2_ADC_TRIG_A_CREST_INT_SKIP_ENABLE	Disable or link interrupt skipping to ADC trigger TRGnAN on a TGRA compare match.
PDL_MTU2_ADC_TRIG_B_CREST_INT_SKIP_DISABLE or PDL_MTU2_ADC_TRIG_B_CREST_INT_SKIP_ENABLE	Disable or link interrupt skipping to ADC trigger TRGnBN on a TGRA compare match.

Description (4/9)

- Control ADC triggers. Valid for n = 4 in complementary PWM mode unless stated otherwise.

PDL_MTU2_ADC_TRIG_A_DOWN_DISABLE or PDL_MTU2_ADC_TRIG_A_DOWN_ENABLE	Disable or enable ADC trigger TRGnAN requests during down-count operation.
PDL_MTU2_ADC_TRIG_B_DOWN_DISABLE or PDL_MTU2_ADC_TRIG_B_DOWN_ENABLE	Disable or enable ADC trigger TRGnBN requests during down-count operation.
PDL_MTU2_ADC_TRIG_A_UP_DISABLE or PDL_MTU2_ADC_TRIG_A_UP_ENABLE	Disable or enable ADC trigger TRGnAN requests during up-count operation. This option can be selected in other modes.
PDL_MTU2_ADC_TRIG_B_UP_DISABLE or PDL_MTU2_ADC_TRIG_B_UP_ENABLE	Disable or enable ADC trigger TRGnBN requests during up-count operation. This option can be selected in other modes.

[buffer_operation]

Configure the buffer operation.

If multiple selections are required, use “|” to separate each selection.

The default settings are shown in **bold**. Specify PDL_NO_DATA to use the defaults.

- Control the cycle set buffer transfer timing. Valid for n = 4.

PDL_MTU2_CSB_DISABLE or PDL_MTU2_CSB_CREST or PDL_MTU2_CSB_TROUGH or PDL_MTU2_CSB_BOTH	Select no transfer, transfer on crest detection, transfer on trough detection or transfer on crest and trough detection.
---	--

PDL_MTU2_CSB_TROUGH and PDL_MTU2_CSB_BOTH are available only in complementary PWM mode.

- Buffer operation

PDL_MTU2_BUFFER_AC_DISABLE or PDL_MTU2_BUFFER_AC_ENABLE	Disable or enable buffer operation for registers TGRA and TGRC. Valid for n = 0, 3 and 4.
PDL_MTU2_BUFFER_BD_DISABLE or PDL_MTU2_BUFFER_BD_ENABLE	Disable or enable buffer operation for registers TGRB and TGRD. Valid for n = 0, 3 and 4.
PDL_MTU2_BUFFER_EF_DISABLE or PDL_MTU2_BUFFER_EF_ENABLE	Disable or enable buffer operation for registers TGRE and TGRF. Valid for n = 0.

- Buffer data transfer

PDL_MTU2_BUFFER_AC_CM_A or PDL_MTU2_BUFFER_AC_TCNT_CLR	Transfer the data from TGRC to TGRA when a compare match A occurs or when TCNT is cleared in each channel. Valid for n = 0, 3 and 4.
PDL_MTU2_BUFFER_BD_CM_B or PDL_MTU2_BUFFER_BD_TCNT_CLR	Transfer the data from TGRD to TGRB when a compare match B occurs or when TCNT is cleared in each channel. Valid for n = 0, 3 and 4.
PDL_MTU2_BUFFER_EF_CM_E or PDL_MTU2_BUFFER_EF_TCNT_CLR	Transfer the data from TGRF to TGRE when a compare match E occurs or when TCNT is cleared in either channel. Valid for n = 0.

Transfer on TCNT clear is available only in PWM mode 1 or 2.

Description (5/9)**[TGR_A_B_operation]**

Configure the operation for general registers TGRA and TGRB. Valid for n = 0 to 4.

If multiple selections are required, use “|” to separate each selection.

The default settings are shown in **bold**. Specify PDL_NO_DATA to use the defaults.

- Input capture / output compare control for register TGRA

PDL_MTU2_A_OC_DISABLED or PDL_MTU2_A_OC_LOW or PDL_MTU2_A_OC_LOW_CM_HIGH or PDL_MTU2_A_OC_LOW_CM_INV or PDL_MTU2_A_OC_HIGH_CM_LOW or PDL_MTU2_A_OC_HIGH or PDL_MTU2_A_OC_HIGH_CM_INV or	MTIOCnA output disabled. MTIOCnA output low. MTIOCnA initial output low; goes high at compare match. MTIOCnA initial output low; toggles at compare match. MTIOCnA initial output high; goes low at compare match. MTIOCnA output high. MTIOCnA initial output high; toggles at compare match.
PDL_MTU2_A_IC_RISING_EDGE or PDL_MTU2_A_IC_FALLING_EDGE or PDL_MTU2_A_IC_BOTH_EDGES or	Input capture at MTIOCnA rising edge. Input capture at MTIOCnA falling edge. Input capture at MTIOCnA both edges.
PDL_MTU2_A_IC_COUNT or	Input capture at channel (n+1) up-count or down-count. Valid only for n = 0.
PDL_MTU2_A_IC_CM_IC	Input capture at channel (n-1) TGRA compare match or input capture. Valid only for n = 1.

- Input capture / output compare control for register TGRB.

PDL_MTU2_B_OC_DISABLED or PDL_MTU2_B_OC_LOW or PDL_MTU2_B_OC_LOW_CM_HIGH or PDL_MTU2_B_OC_LOW_CM_INV or PDL_MTU2_B_OC_HIGH_CM_LOW or PDL_MTU2_B_OC_HIGH or PDL_MTU2_B_OC_HIGH_CM_INV or	MTIOCnB output disabled. MTIOCnB output low. MTIOCnB initial output low; goes high at compare match. MTIOCnB initial output low; toggles at compare match. MTIOCnB initial output high; goes low at compare match. MTIOCnB output high. MTIOCnB initial output high; toggles at compare match.
PDL_MTU2_B_IC_RISING_EDGE or PDL_MTU2_B_IC_FALLING_EDGE or PDL_MTU2_B_IC_BOTH_EDGES or	Input capture at MTIOCnB rising edge. Input capture at MTIOCnB falling edge. Input capture at MTIOCnB both edges.
PDL_MTU2_B_IC_COUNT or	Input capture at channel (n+1) up-count or down-count. Valid only for n = 0.
PDL_MTU2_B_IC_CM_IC	Input capture at channel (n-1) TGRB compare match or input capture. Valid only for n = 1.

- Cascade input capture control. Valid in cascade mode for n = 1.

Channel n forms the higher 16 bits and channel (n+1) forms the lower 16 bits.

PDL_MTU2_CASCADE_AL_IC_EXC_H or PDL_MTU2_CASCADE_AL_IC_INC_H	Exclude or include pin MTIOCnA in the TGRA input capture conditions for channel (n+1).
PDL_MTU2_CASCADE_BL_IC_EXC_H or PDL_MTU2_CASCADE_BL_IC_INC_H	Exclude or include pin MTIOCnB in the TGRB input capture conditions for channel (n+1).
PDL_MTU2_CASCADE_AH_IC_EXC_L or PDL_MTU2_CASCADE_AH_IC_INC_L	Exclude or include pin MTIOC(n+1)A in the TGRA input capture conditions for channel n.
PDL_MTU2_CASCADE_BH_IC_EXC_L or PDL_MTU2_CASCADE_BH_IC_INC_L	Exclude or include pin MTIOC(n+1)B in the TGRB input capture conditions for channel n.

Description (6/9)

[TGR_C_D_operation]

Configure the operation for general registers TGRC and TGRD. Valid for n = 0, 3 and 4. If multiple selections are required, use “|” to separate each selection. The default settings are shown in **bold**. Specify PDL_NO_DATA to use the defaults.

- Input capture / output compare control for register TGRC.

PDL_MTU2_C_OC_DISABLED or PDL_MTU2_C_OC_LOW or PDL_MTU2_C_OC_LOW_CM_HIGH or PDL_MTU2_C_OC_LOW_CM_INV or PDL_MTU2_C_OC_HIGH_CM_LOW or PDL_MTU2_C_OC_HIGH or PDL_MTU2_C_OC_HIGH_CM_INV or	MTIOcnC output disabled. MTIOcnC output low. MTIOcnC initial output low; goes high at compare match. MTIOcnC initial output low; toggles at compare match. MTIOcnC initial output high; goes low at compare match. MTIOcnC output high. MTIOcnC initial output high; toggles at compare match.
PDL_MTU2_C_IC_RISING_EDGE or PDL_MTU2_C_IC_FALLING_EDGE or PDL_MTU2_C_IC_BOTH_EDGES or	Input capture at MTIOcnC rising edge. Input capture at MTIOcnC falling edge. Input capture at MTIOcnC both edges.
PDL_MTU2_C_IC_COUNT	Input capture at channel (n+1) up-count or down-count. Valid only for n = 0.

- Input capture / output compare control for register TGRD.

PDL_MTU2_D_OC_DISABLED or PDL_MTU2_D_OC_LOW or PDL_MTU2_D_OC_LOW_CM_HIGH or PDL_MTU2_D_OC_LOW_CM_INV or PDL_MTU2_D_OC_HIGH_CM_LOW or PDL_MTU2_D_OC_HIGH or PDL_MTU2_D_OC_HIGH_CM_INV or	MTIOcnD output disabled. MTIOcnD output low. MTIOcnD initial output low; goes high at compare match. MTIOcnD initial output low; toggles at compare match. MTIOcnD initial output high; goes low at compare match. MTIOcnD output high. MTIOcnD initial output high; toggles at compare match.
PDL_MTU2_D_IC_RISING_EDGE or PDL_MTU2_D_IC_FALLING_EDGE or PDL_MTU2_D_IC_BOTH_EDGES or	Input capture at MTIOcnD rising edge. Input capture at MTIOcnD falling edge. Input capture at MTIOcnD both edges.
PDL_MTU2_D_IC_COUNT	Input capture at channel (n+1) up-count or down-count. Valid only for n = 0.

Description (7/9)

[TGR_U_V_W_operation]

Configure the input capture / compare match control for general registers TGRU, TRGV and TGRW. Valid for n = 5.

The default settings are shown in **bold**. Specify PDL_NO_DATA to use the defaults.

- Input capture / compare match control for register TGRU.

PDL_MTU2_U_CM or	Compare match.
PDL_MTU2_U_IC_RISING_EDGE or PDL_MTU2_U_IC_FALLING_EDGE or PDL_MTU2_U_IC_BOTH_EDGES or	Input capture at MTICnU rising edge. Input capture at MTICnU falling edge. Input capture at MTICnU both edges.
PDL_MTU2_U_IC_PWM_LOW_TROUGH or PDL_MTU2_U_IC_PWM_LOW_CREST or PDL_MTU2_U_IC_PWM_LOW_BOTH or	Input capture at trough, crest or both for low pulse width measurement.
PDL_MTU2_U_IC_PWM_HIGH_TROUGH or PDL_MTU2_U_IC_PWM_HIGH_CREST or PDL_MTU2_U_IC_PWM_HIGH_BOTH	Input capture at trough, crest or both for high pulse width measurement.

- Input capture / compare match control for register TRGV.

PDL_MTU2_V_CM or	Compare match.
PDL_MTU2_V_IC_RISING_EDGE or PDL_MTU2_V_IC_FALLING_EDGE or PDL_MTU2_V_IC_BOTH_EDGES or	Input capture at MTICnV rising edge. Input capture at MTICnV falling edge. Input capture at MTICnV both edges.
PDL_MTU2_V_IC_PWM_LOW_TROUGH or PDL_MTU2_V_IC_PWM_LOW_CREST or PDL_MTU2_V_IC_PWM_LOW_BOTH or	Input capture at trough, crest or both for low pulse width measurement.
PDL_MTU2_V_IC_PWM_HIGH_TROUGH or PDL_MTU2_V_IC_PWM_HIGH_CREST or PDL_MTU2_V_IC_PWM_HIGH_BOTH	Input capture at trough, crest or both for high pulse width measurement.

- Input capture / compare match control for register TGRW.

PDL_MTU2_W_CM or	Compare match.
PDL_MTU2_W_IC_RISING_EDGE or PDL_MTU2_W_IC_FALLING_EDGE or PDL_MTU2_W_IC_BOTH_EDGES or	Input capture at MTICnW rising edge. Input capture at MTICnW falling edge. Input capture at MTICnW both edges.
PDL_MTU2_W_IC_PWM_LOW_TROUGH or PDL_MTU2_W_IC_PWM_LOW_CREST or PDL_MTU2_W_IC_PWM_LOW_BOTH or	Input capture at trough, crest or both for low pulse width measurement.
PDL_MTU2_W_IC_PWM_HIGH_TROUGH or PDL_MTU2_W_IC_PWM_HIGH_CREST or PDL_MTU2_W_IC_PWM_HIGH_BOTH	Input capture at trough, crest or both for high pulse width measurement.

Description (8/9)

[noise_filter_operation]

Noise filter control for register NFCRn (n = 0 to 5)
 The default settings are shown in **bold**. Specify PDL_NO_DATA to use the defaults.

- Noise filter control for register NFCRn

PDL_MTU2_NF_A_U_DISABLE or PDL_MTU2_NF_A_U_ENABLE	Enable or disable noise filter for MTIOCnA (n = 0 to 4) or TIOC5U (n = 5).
PDL_MTU2_NF_B_V_DISABLE or PDL_MTU2_NF_B_V_ENABLE	Enable or disable noise filter for MTIOCnB (n = 0 to 4) or TIOC5V (n = 5).
PDL_MTU2_NF_C_W_DISABLE or PDL_MTU2_NF_C_W_ENABLE	Enable or disable noise filter for MTIOCnC (n = 0, 3 or 4) or TIOC5W (n = 5). Not valid for n=1 or 2.
PDL_MTU2_NF_D_DISABLE or PDL_MTU2_NF_D_ENABLE	Enable or disable noise filter for MTIOCnD (n = 0, 3 or 4). Not valid for n = 1, 2 or 5.

- Noise filter clock select for register NFCRn

PDL_MTU2_NF_PCLK_DIV_1 or PDL_MTU2_NF_PCLK_DIV_8 or PDL_MTU2_NF_PCLK_DIV_32 or PDL_MTU2_NF_PCLK_DIV_SRC	Set the clock of the noise filter as PCLKB ÷ 1, 8, 32 or the count source.
---	--

[TCNT_TCNTU_value]

For n = 0 to 4: The timer counter TCNT value.
 For n = 5: The timer counter TCNTU value.

[TGRA_TCNTV_value]

For n = 0 to 4: The register TGRA value.
 For n = 5: The timer counter TCNTV value.

[TGRB_TCNTW_value]

For n = 0 to 4: The register TGRB value.
 For n = 5: The timer counter TCNTW value.

[TGRC_TGRU_value]

For n = 0, 3 or 4: The register TGRC value.
 For n = 5: The register TGRU value.
 Ignored for n = 1 or 2.

[TGRD_TGRV_value]

For n = 0, 3 or 4: The register TGRD value.
 For n = 5: The register TGRV value.
 Ignored for n = 1 or 2.

[TGRE_TGRW_value]

For n = 0: The register TGRE value.
 For n = 5: The register TGRW value.
 Ignored for n = 1, 2, 3 or 4.

[TGRF_TADCORA_value]

For n = 0: The register TGRF value.
 For n = 4: The register TADCORA value.
 Ignored for n = 1, 2, 3 or 5.

[TADCORB_value]

The register TADCORB value (ignored for n ≠ 4).

[TADCOBRA_value]

The register TADCOBRA value (ignored for n ≠ 4).

[TADCOBRB_value]

The register TADCOBRB value (ignored for n ≠ 4).

Description (9/9)	<p>[func1] For n = 0 to 4: The function to be called when a TGRA event occurs. For n = 5: The function to be called when a TGRU event occurs. Specify PDL_NO_FUNC if not required.</p> <p>[func2] For n = 0 to 4: The function to be called when a TGRB event occurs. For n = 5: The function to be called when a TGRV event occurs. Specify PDL_NO_FUNC if not required.</p> <p>[func3] For n = 0, 3 or 4: The function to be called when a TGRC event occurs. For n = 5: The function to be called when a TGRW event occurs. Specify PDL_NO_FUNC if not required.</p> <p>[func4] For n = 0, 3 or 4: The function to be called when a TGRD event occurs. Specify PDL_NO_FUNC if not required.</p> <p>[interrupt_priority_1] The interrupt priority level for TGR(A to D or U to W) events. Select between 1 (lowest priority) and 15 (highest priority). This parameter will be ignored if PDL_NO_FUNC is specified for all parameters func(1 to 4).</p> <p>[func5] For n = 0: The function to be called when a TGRE event occurs. Specify PDL_NO_FUNC if not required.</p> <p>[func6] For n = 0: The function to be called when a TGRF event occurs. Specify PDL_NO_FUNC if not required.</p> <p>[interrupt_priority_2] The interrupt priority level for TGRE and TGRF. Select between 1 (lowest priority) and 15 (highest priority). This parameter will be ignored if PDL_NO_FUNC is specified for all parameters func(5 and 6).</p> <p>[func7] For n = 0 to 3: The function to be called when an overflow occurs. For n = 4: The function to be called when an overflow or underflow occurs. Specify PDL_NO_FUNC if not required.</p> <p>[func8] For n = 1 or 2: The function to be called when an underflow occurs. Specify PDL_NO_FUNC if not required.</p> <p>[interrupt_priority_3] The interrupt priority level for overflow or underflow events. Select between 1 (lowest priority) and 15 (highest priority). This parameter will be ignored if PDL_NO_FUNC is specified for all parameters func(7 to 8).</p>
Return value	True if all parameters are valid and exclusive; otherwise false.
Category	Multi-function Timer Pulse Unit
Reference	R_MTU2_Set, R_MTU2_ControlChannel, R_MTU2_ControlUnit

Remarks

- If an external clock input pin (MTCLKx) or I/O pin (MTIOCnx) is made active, this function will configure that pin for input or output and disable other functions on that pin.
- Call R_MTU2_Set before calling this function to select the pins to be used.
- Either R_MTU2_ControlChannel or R_MTU2_ControlUnit must be used to start the timers.
- If a callback function is specified, this function will enable the relevant CPU interrupt. Please see the notes on callback function usage in §6.
- A callback function is executed by the interrupt processing function. This means that no other interrupt can be processed until the callback function has completed.
- If the channel is configured for phase counting mode, the counter clock source setting is ignored.
- If buffer operation is selected for registers TGRA and TGRC, input capture / output compare is not valid for register TGRC.
- If buffer operation is selected for registers TGRB and TGRD, input capture / output compare is not valid for register TGRD.
- If synchronous mode is required, at least two channels must be enabled for synchronous operation.
- A companion function, R_MTU2_Create_load_defaults, can be used to load the default values into the structure.
- If the channel operation mode will be changed, ensure that the timer is stopped (use R_MTU2_ControlChannel or R_MTU2_ControlUnit).
- If noise filter is enabled, wait for 2 cycles of the selected noise filter clock before starting the timer (use R_MTU2_ControlChannel or R_MTU2_ControlUnit).
- If using Complementary PWM mode with Synchronous Clearing and Waveform Retention enabled, then be aware of the cautions specified in the Usage Notes section of the hardware manual.
- If setting a value to MTU5.TCNT and MTU5.TGR registers, then be aware of the cautions specified in the Usage Notes section of the hardware manual.

Program example

```

/* RPDFL definitions */
#include "r_pdl_mtu2.h"

/* RPDFL device-specific definitions */
#include "r_pdl_definitions.h"

void func(void)
{
    /* Allocate a copy of the structure for the selected channel */
    R_MTU2_Create_structure ch4_parameters;

    /* Load the defaults */
    R_MTU2_Create_load_defaults(&ch4_parameters);

    /* Set the non-default options for channel 4 */
    ch4_parameters.channel_mode = PDL_MTU2_MODE_NORMAL | \
        PDL_MTU2_SYNC_ENABLE | PDL_MTU2_TGRA_DTC_TRIGGER_ENABLE;
    ch4_parameters.counter_operation = PDL_MTU2_CLK_PCLK_DIV_4;
    ch4_parameters.buffer_operation = PDL_MTU2_BUFFER_AC_CM_A;
    ch4_parameters.TGR_C_D_operation = PDL_MTU2_C_OC_HIGH_CM_LOW;
    ch4_parameters.TCNT_TCNTU_value = 0;
    ch4_parameters.TGRA_TCNTV_value = 199;
    ch4_parameters.TGRB_TCNTW_value = 99;
    ch4_parameters.TGRC_TGRU_value = 50;
    ch4_parameters.TGRD_TGRV_value = 100;
    ch4_parameters.TGRE_TGRW_value = 0;
    ch4_parameters.TGRF_TADCORA_value = 0;

    R_MTU2_Create(
        4,
        &ch4_parameters
    );
}

```

3) R_MTU2_Destroy

Synopsis

Disable a Multi-function Timer Pulse Unit.

Prototype

```
bool R_MTU2_Destroy(  
    uint8_t data // Unit selection  
);
```

Description

Shut down a timer pulse unit

[data]

The multi-function timer pulse unit n (where n = 0).
Unit 0 comprises channels 0 to 5.

Return value

True if the unit selection is valid; otherwise false.

Category

Multi-function Timer Pulse Unit

Reference

None.

Remarks

- The unit is put into the stop state to reduce power consumption.

Program example

```
#include "r_pdl_mtu2.h"  
  
void func(void)  
{  
    /* Shutdown MTU2 channels 0 to 5 */  
    R_MTU2_Destroy(  
        0  
    );  
}
```

4) R_MTU2_ControlChannel

Synopsis Control an MTU channel.

Prototype

```
bool R_MTU2_ControlChannel(
    uint8_t data1, // Channel selection
    R_MTU2_ControlChannel_structure * data2 // A pointer to the structure
);
```

R_MTU2_ControlChannel_structure members:

```
uint8_t control_setting // Control settings
uint16_t register_selection // Register selection
uint16_t TCNT_TCNTU_value // Register value
uint16_t TGRA_TCNTV_value // Register value
uint16_t TGRB_TCNTW_value // Register value
uint16_t TGRC_TGRU_value // Register value
uint16_t TGRD_TGRV_value // Register value
uint16_t TGRE_TGRW_value // Register value
uint16_t TGRF_value // Register value
uint16_t TADCOBRA_value // Register value
uint16_t TADCOBRB_value // Register value
```

Description (1/2) Modify a timer channel's registers.

[data1]
The channel number n (where n = 0 to 5).

[control_setting]
The channel settings to be modified.
If multiple selections are required, use “|” to separate each selection.
Specify PDL_NO_DATA if no change is required.

- Counter stop / start. Valid for n = 0 to 4.

PDL_MTU2_STOP	Stop the count operation.
PDL_MTU2_START	Start the count operation.

- Counter stop / Start. Valid for n = 5.

PDL_MTU2_STOP_U	Stop the count operation.
PDL_MTU2_STOP_V	
PDL_MTU2_STOP_W	
PDL_MTU2_START_U	Start the count operation.
PDL_MTU2_START_V	
PDL_MTU2_START_W	

[register_selection]
The channel registers to be modified.
If multiple selections are required, use “|” to separate each selection.
Specify PDL_NO_DATA if no register change is required.

- The registers to be modified.
For n = 0 to 4.

PDL_MTU2_REGISTER_COUNTER	Timer counter register (TCNT).
PDL_MTU2_REGISTER_TGRA	General register A.
PDL_MTU2_REGISTER_TGRB	General register B.
PDL_MTU2_REGISTER_TGRC	General register C. Valid for n = 0, 3 or 4.
PDL_MTU2_REGISTER_TGRD	General register D. Valid for n = 0, 3 or 4.
PDL_MTU2_REGISTER_TGRE	General register E. Valid for n = 0.
PDL_MTU2_REGISTER_TGRF	General register F. Valid for n = 0.
PDL_MTU2_REGISTER_TADCOBRA	ADC start request cycle set buffer A. Valid for n = 4.
PDL_MTU2_REGISTER_TADCOBRB	ADC start request cycle set buffer B. Valid for n = 4.

Description (2/2)

For n = 5.

PDL_MTU2_REGISTER_COUNTER_U	Timer counter U register (TCNTU).
PDL_MTU2_REGISTER_COUNTER_V	Timer counter V register (TCNTV).
PDL_MTU2_REGISTER_COUNTER_W	Timer counter W register (TCNTW).
PDL_MTU2_REGISTER_TGRU	General register U.
PDL_MTU2_REGISTER_TGRV	General register V.
PDL_MTU2_REGISTER_TGRW	General register W.

[TCNT_TCNTU_value]

For n = 0 to 4: The timer counter TCNT value.

For n = 5: The timer counter TCNTU value.

This will be ignored if the register is not selected.

[TGRA_TCNTV_value]

For n = 0 to 4: The register TGRA value.

For n = 5: The timer counter TCNTV value.

This will be ignored if the register is not selected.

[TGRB_TCNTW_value]

For n = 0 to 4: The register TGRB value.

For n = 5: The timer counter TCNTW value.

This will be ignored if the register is not selected.

[TGRC_TGRU_value]

For n = 0, 3 or 4: The register TGRC value.

For n = 5: The register TGRU value.

This will be ignored if the register is not selected.

[TGRD_TGRV_value]

For n = 0, 3 or 4: The register TGRD value.

For n = 5: The register TGRV value.

This will be ignored if the register is not selected.

[TGRE_TGRW_value]

For n = 0: The register TGRE value.

For n = 5: The register TGRW value.

This will be ignored if the register is not selected.

[TGRF_value]

For n = 0: The general register TGRF value.

This will be ignored if the register is not selected.

[TADCOBRA_value]

For n = 4: ADC start request cycle set buffer A.

This will be ignored if the register is not selected.

[TADCOBRB_value]

For n = 4: ADC start request cycle set buffer B.

This will be ignored if the register is not selected.

Return value

True if the channel number is valid; otherwise false.

Category

Multi-function Timer Pulse Unit

Reference

R_MTU2_Create, R_MTU2_ControlUnit

Remarks

- Before calling this function, use R_MTU2_Create to configure the channel operation.
- Either this function or R_MTU2_ControlUnit must be used to start the timers.
- The Stop operation is executed at the start of this function.
The Start operation is executed at the end.
Therefore, both options can be selected together with other changes in one function call.
- If noise filter is enabled, before starting the timer make sure at least 2 cycles of the selected noise filter clock has elapsed after the timer configuration (use R_MTU2_Create).

Program example

```
/* RPDL definitions */
#include "r_pdl_mtu2.h"

/* RPDL device-specific definitions */
#include "r_pdl_definitions.h"

void func(void)
{
    /* Allocate a copy of the structure for the selected channel */
    R_MTU2_ControlChannel_structure ch3_parameters;

    /* Set the control options for channel 3 */
    ch3_parameters.control_setting = PDL_MTU2_START;
    ch3_parameters.register_selection = PDL_MTU2_REGISTER_COUNTER |
PDL_MTU2_REGISTER_TGRB;
    ch3_parameters.TCNT_TCNTU_value = 0xFFDD;
    ch3_parameters.TGRB_TCNTW_value = 0x0020;

    /* Modify the operation of channel 3 */
    R_MTU2_ControlChannel(
        3,
        &ch3_parameters
    );
}
```

5) R_MTU2_ControlUnit

Synopsis Control a Multi-function Timer Pulse Unit.

Prototype

```
bool R_MTU2_ControlUnit(
    uint8_t data1, // Unit selection
    R_MTU2_ControlUnit_structure * data2 // A pointer to the structure
);
```

R_MTU2_ControlUnit_structure members:

```
uint16_t simultaneous_control // Control selection
uint32_t output_control // Control selection
uint32_t buffer_control // Control selection
uint16_t brushless_DC_motor_control // Control selection
uint32_t general_control // Control selection
uint8_t register_selection // Register selection
uint16_t TDDR_value // Register value
uint16_t TCDR_value // Register value
uint16_t TCBR_value // Register value
```

Description (1/4) Modify a timer unit's registers.

[data1]
The unit number n (where n = 0).

[simultaneous_control]
Simultaneous stop / start control. All selections are optional.
If multiple selections are required, use "|" to separate each selection.
Specify PDL_NO_DATA if no change is required.

- Counter stop control

PDL_MTU2_STOP_CH_0	Stop the count operation for the selected channels.
PDL_MTU2_STOP_CH_1	
PDL_MTU2_STOP_CH_2	
PDL_MTU2_STOP_CH_3	
PDL_MTU2_STOP_CH_4	

- Counter start control

PDL_MTU2_START_CH_0	Start the count operation for the selected channels.
PDL_MTU2_START_CH_1	
PDL_MTU2_START_CH_2	
PDL_MTU2_START_CH_3	
PDL_MTU2_START_CH_4	

Description (2/4)**[output_control]**

The output control settings to be modified. All settings are optional.
If multiple selections are required, use “|” to separate each selection.

- Output control.
To apply output control, make sure the operation of the corresponding channel is stopped.

Select one option for each output.

PDL_MTU2_OUT_P_PHASE_1_ENABLE or PDL_MTU2_OUT_P_PHASE_1_DISABLE	MTIOC3B
PDL_MTU2_OUT_N_PHASE_1_ENABLE or PDL_MTU2_OUT_N_PHASE_1_DISABLE	MTIOC3D
PDL_MTU2_OUT_P_PHASE_2_ENABLE or PDL_MTU2_OUT_P_PHASE_2_DISABLE	MTIOC4A
PDL_MTU2_OUT_N_PHASE_2_ENABLE or PDL_MTU2_OUT_N_PHASE_2_DISABLE	MTIOC4C
PDL_MTU2_OUT_P_PHASE_3_ENABLE or PDL_MTU2_OUT_P_PHASE_3_DISABLE	MTIOC4B.
PDL_MTU2_OUT_N_PHASE_3_ENABLE or PDL_MTU2_OUT_N_PHASE_3_DISABLE	MTIOC4D

Or all six phase outputs can be controlled together by selecting one of each:

PDL_MTU2_OUT_P_PHASE_ALL_ENABLE or PDL_MTU2_OUT_P_PHASE_ALL_DISABLE	All P phase outputs.
PDL_MTU2_OUT_N_PHASE_ALL_ENABLE or PDL_MTU2_OUT_N_PHASE_ALL_DISABLE	All N phase outputs.

- Output inversion control (applies only to reset-synchronised or complementary PWM modes).
Each phase output can be configured for
a) initial high level, active low level or
b) initial low level, active high level.
If dead time is not generated, the options for negative phases will be ignored as their output are always the inversion of the positive phases.

All six phase outputs can be controlled together by selecting one of each:

PDL_MTU2_OUT_P_PHASE_ALL_HIGH_LOW or PDL_MTU2_OUT_P_PHASE_ALL_LOW_HIGH	Positive-phase outputs.
PDL_MTU2_OUT_N_PHASE_ALL_HIGH_LOW or PDL_MTU2_OUT_N_PHASE_ALL_LOW_HIGH	Negative-phase outputs.

Or independently by selecting one option for each required output.

PDL_MTU2_OUT_P_PHASE_1_HIGH_LOW or PDL_MTU2_OUT_P_PHASE_1_LOW_HIGH	MTIOC3B
PDL_MTU2_OUT_N_PHASE_1_HIGH_LOW or PDL_MTU2_OUT_N_PHASE_1_LOW_HIGH	MTIOC3D
PDL_MTU2_OUT_P_PHASE_2_HIGH_LOW or PDL_MTU2_OUT_P_PHASE_2_LOW_HIGH	MTIOC4A
PDL_MTU2_OUT_N_PHASE_2_HIGH_LOW or PDL_MTU2_OUT_N_PHASE_2_LOW_HIGH	MTIOC4C
PDL_MTU2_OUT_P_PHASE_3_HIGH_LOW or PDL_MTU2_OUT_P_PHASE_3_LOW_HIGH	MTIOC4B
PDL_MTU2_OUT_N_PHASE_3_HIGH_LOW or PDL_MTU2_OUT_N_PHASE_3_LOW_HIGH	MTIOC4D

- Write access control (applies only to reset-synchronised or complementary PWM modes).

PDL_MTU2_OUT_LOCK_ENABLE	Prevent further changes to the phase output control.
--------------------------	--

- Toggle output control (applies only to reset-synchronised or complementary PWM modes).

PDL_MTU2_OUT_TOGGLE_ENABLE or PDL_MTU2_OUT_TOGGLE_DISABLE	Enable or disable toggle output synchronised with the PWM cycle.
--	--

Description (3/4)

[buffer_control]

The buffer control settings to be modified. All settings are optional. If multiple selections are required, use “|” to separate each selection.

- Output level buffer control (applies only to reset-synchronised or complementary PWM modes).

Set the output control to be transferred to the output:

PDL_MTU2_OUT_BUFFER_P_PHASE_1_LOW or PDL_MTU2_OUT_BUFFER_P_PHASE_1_HIGH	MTIOC3B
PDL_MTU2_OUT_BUFFER_N_PHASE_1_LOW or PDL_MTU2_OUT_BUFFER_N_PHASE_1_HIGH	MTIOC3D
PDL_MTU2_OUT_BUFFER_P_PHASE_2_LOW or PDL_MTU2_OUT_BUFFER_P_PHASE_2_HIGH	MTIOC4A
PDL_MTU2_OUT_BUFFER_N_PHASE_2_LOW or PDL_MTU2_OUT_BUFFER_N_PHASE_2_HIGH	MTIOC4C
PDL_MTU2_OUT_BUFFER_P_PHASE_3_LOW or PDL_MTU2_OUT_BUFFER_P_PHASE_3_HIGH	MTIOC4B
PDL_MTU2_OUT_BUFFER_N_PHASE_3_LOW or PDL_MTU2_OUT_BUFFER_N_PHASE_3_HIGH	MTIOC4D

- Set the transfer timing

In complementary PWM modes:

PDL_MTU2_OUT_BUFFER_TRANSFER_DISABLE or PDL_MTU2_OUT_BUFFER_TRANSFER_CREST or PDL_MTU2_OUT_BUFFER_TRANSFER_TROUGH or PDL_MTU2_OUT_BUFFER_TRANSFER_BOTH	Disable or enable on detection of crest, trough or both
--	---

In Reset-synchronised PWM mode:

PDL_MTU2_OUT_BUFFER_TRANSFER_DISABLE or PDL_MTU2_OUT_BUFFER_TRANSFER_CLEAR	Disable or enable on counter clear.
--	-------------------------------------

- Buffer transfer to temporary transfer control. Applicable for complementary PWM modes.

PDL_MTU2_BUFFER_TRANSFER_DISABLE or PDL_MTU2_BUFFER_TRANSFER_ENABLE or PDL_MTU2_BUFFER_TRANSFER_LINK	Disable transfers, enable without linking to interrupt skipping or enable and link to interrupt skipping.
--	---

[brushless_DC_motor_control]

Brushless DC motor control settings. All settings are optional. If multiple selections are required, use “|” to separate each selection. Applies only to reset-synchronised or complementary PWM modes

- Brushless DC motor waveform control

PDL_MTU2_BDCM_ENABLE or PDL_MTU2_BDCM_DISABLE	Enable or disable brushless DC motor control
PDL_MTU2_BDCM_P_PHASE_ENABLE or PDL_MTU2_BDCM_P_PHASE_DISABLE	Enable or disable PWM outputs on the positive-phase output pins.
PDL_MTU2_BDCM_N_PHASE_ENABLE or PDL_MTU2_BDCM_N_PHASE_DISABLE	Enable or disable PWM outputs on the negative-phase output pins.
PDL_MTU2_BDCM_OPS_FB or	Use input capture signals for output switch control, or
PDL_MTU2_BDCM_OPS_000 or PDL_MTU2_BDCM_OPS_001 or PDL_MTU2_BDCM_OPS_010 or PDL_MTU2_BDCM_OPS_011 or PDL_MTU2_BDCM_OPS_100 or PDL_MTU2_BDCM_OPS_101 or PDL_MTU2_BDCM_OPS_110 or PDL_MTU2_BDCM_OPS_111	Set the outputs according to table 23.39 in the hardware manual.

Description (4/4)	<p>[general_control] General control settings. All settings are optional. If multiple selections are required, use “ ” to separate each selection.</p> <ul style="list-style-type: none"> Interrupt skipping control <table border="1" style="width: 100%; border-collapse: collapse;"> <tr> <td style="width: 60%; padding: 2px;"> PDL_MTU2_INT_SKIP_TROUGH_DISABLE or PDL_MTU2_INT_SKIP_TROUGH_1 or PDL_MTU2_INT_SKIP_TROUGH_2 or PDL_MTU2_INT_SKIP_TROUGH_3 or PDL_MTU2_INT_SKIP_TROUGH_4 or PDL_MTU2_INT_SKIP_TROUGH_5 or PDL_MTU2_INT_SKIP_TROUGH_6 or PDL_MTU2_INT_SKIP_TROUGH_7 </td> <td style="padding: 2px;"> Disable TCNT underflow (TCIV) interrupt skipping, or set the skip count between 1 and 7. </td> </tr> <tr> <td style="padding: 2px;"> PDL_MTU2_INT_SKIP_CREST_DISABLE or PDL_MTU2_INT_SKIP_CREST_1 or PDL_MTU2_INT_SKIP_CREST_2 or PDL_MTU2_INT_SKIP_CREST_3 or PDL_MTU2_INT_SKIP_CREST_4 or PDL_MTU2_INT_SKIP_CREST_5 or PDL_MTU2_INT_SKIP_CREST_6 or PDL_MTU2_INT_SKIP_CREST_7 </td> <td style="padding: 2px;"> Disable TGRA compare match (TGIA) interrupt skipping, or set the skip count between 1 and 7. </td> </tr> </table> Dead time generation control (applies only to complementary PWM modes). <table border="1" style="width: 100%; border-collapse: collapse;"> <tr> <td style="width: 60%; padding: 2px;"> PDL_MTU2_DEAD_TIME_DISABLE or PDL_MTU2_DEAD_TIME_ENABLE </td> <td style="padding: 2px;"> Disable or enable dead time generation. </td> </tr> </table> Waveform retention control (applies only to complementary PWM modes). <table border="1" style="width: 100%; border-collapse: collapse;"> <tr> <td style="width: 60%; padding: 2px;"> PDL_MTU2_WAVEFORM_RETAIN_DISABLE or PDL_MTU2_WAVEFORM_RETAIN_ENABLE </td> <td style="padding: 2px;"> Disable or enable waveform output retention. </td> </tr> </table> Compare match clearing control (applies only to complementary PWM mode 1). <table border="1" style="width: 100%; border-collapse: collapse;"> <tr> <td style="width: 60%; padding: 2px;"> PDL_MTU2_CNT_CLEAR_CM_A_DISABLE or PDL_MTU2_CNT_CLEAR_CM_A_ENABLE </td> <td style="padding: 2px;"> Disable or enable counter clearing on TGRA compare match. </td> </tr> </table> Reset-synchronised or complementary PWM control <table border="1" style="width: 100%; border-collapse: collapse;"> <tr> <td style="width: 60%; padding: 2px;"> PDL_MTU2_PWM_RS_COMP_ENABLE </td> <td style="padding: 2px;"> Enable reset-synchronised or complementary PWM mode. </td> </tr> </table> Register protection <table border="1" style="width: 100%; border-collapse: collapse;"> <tr> <td style="width: 60%; padding: 2px;"> PDL_MTU2_ACCESS_DISABLE PDL_MTU2_ACCESS_ENABLE </td> <td style="padding: 2px;"> Control access to the registers and counters in channels 3 and 4. </td> </tr> </table> <p>[register_selection] The unit registers to be modified. If multiple selections are required, use “ ” to separate each selection.</p> <ul style="list-style-type: none"> The registers to be modified. These apply only to complementary PWM mode. <table border="1" style="width: 100%; border-collapse: collapse;"> <tr> <td style="width: 60%; padding: 2px;"> PDL_MTU2_REGISTER_DEAD_TIME </td> <td style="padding: 2px;"> Update the dead time data register (TDDR). </td> </tr> <tr> <td style="padding: 2px;"> PDL_MTU2_REGISTER_CYCLE_DATA </td> <td style="padding: 2px;"> Update the cycle data register (TCDR). </td> </tr> <tr> <td style="padding: 2px;"> PDL_MTU2_REGISTER_CYCLE_BUFFER </td> <td style="padding: 2px;"> Update the cycle buffer register (TCBR). </td> </tr> </table> <p>[TDDR_value] The dead time data register value. This will be ignored if the register is not selected.</p> <p>[TCDR_value] The cycle data register value. This will be ignored if the register is not selected.</p> <p>[TCBR_value] The cycle buffer register value. This will be ignored if the register is not selected.</p>	PDL_MTU2_INT_SKIP_TROUGH_DISABLE or PDL_MTU2_INT_SKIP_TROUGH_1 or PDL_MTU2_INT_SKIP_TROUGH_2 or PDL_MTU2_INT_SKIP_TROUGH_3 or PDL_MTU2_INT_SKIP_TROUGH_4 or PDL_MTU2_INT_SKIP_TROUGH_5 or PDL_MTU2_INT_SKIP_TROUGH_6 or PDL_MTU2_INT_SKIP_TROUGH_7	Disable TCNT underflow (TCIV) interrupt skipping, or set the skip count between 1 and 7.	PDL_MTU2_INT_SKIP_CREST_DISABLE or PDL_MTU2_INT_SKIP_CREST_1 or PDL_MTU2_INT_SKIP_CREST_2 or PDL_MTU2_INT_SKIP_CREST_3 or PDL_MTU2_INT_SKIP_CREST_4 or PDL_MTU2_INT_SKIP_CREST_5 or PDL_MTU2_INT_SKIP_CREST_6 or PDL_MTU2_INT_SKIP_CREST_7	Disable TGRA compare match (TGIA) interrupt skipping, or set the skip count between 1 and 7.	PDL_MTU2_DEAD_TIME_DISABLE or PDL_MTU2_DEAD_TIME_ENABLE	Disable or enable dead time generation.	PDL_MTU2_WAVEFORM_RETAIN_DISABLE or PDL_MTU2_WAVEFORM_RETAIN_ENABLE	Disable or enable waveform output retention.	PDL_MTU2_CNT_CLEAR_CM_A_DISABLE or PDL_MTU2_CNT_CLEAR_CM_A_ENABLE	Disable or enable counter clearing on TGRA compare match.	PDL_MTU2_PWM_RS_COMP_ENABLE	Enable reset-synchronised or complementary PWM mode.	PDL_MTU2_ACCESS_DISABLE PDL_MTU2_ACCESS_ENABLE	Control access to the registers and counters in channels 3 and 4.	PDL_MTU2_REGISTER_DEAD_TIME	Update the dead time data register (TDDR).	PDL_MTU2_REGISTER_CYCLE_DATA	Update the cycle data register (TCDR).	PDL_MTU2_REGISTER_CYCLE_BUFFER	Update the cycle buffer register (TCBR).
PDL_MTU2_INT_SKIP_TROUGH_DISABLE or PDL_MTU2_INT_SKIP_TROUGH_1 or PDL_MTU2_INT_SKIP_TROUGH_2 or PDL_MTU2_INT_SKIP_TROUGH_3 or PDL_MTU2_INT_SKIP_TROUGH_4 or PDL_MTU2_INT_SKIP_TROUGH_5 or PDL_MTU2_INT_SKIP_TROUGH_6 or PDL_MTU2_INT_SKIP_TROUGH_7	Disable TCNT underflow (TCIV) interrupt skipping, or set the skip count between 1 and 7.																				
PDL_MTU2_INT_SKIP_CREST_DISABLE or PDL_MTU2_INT_SKIP_CREST_1 or PDL_MTU2_INT_SKIP_CREST_2 or PDL_MTU2_INT_SKIP_CREST_3 or PDL_MTU2_INT_SKIP_CREST_4 or PDL_MTU2_INT_SKIP_CREST_5 or PDL_MTU2_INT_SKIP_CREST_6 or PDL_MTU2_INT_SKIP_CREST_7	Disable TGRA compare match (TGIA) interrupt skipping, or set the skip count between 1 and 7.																				
PDL_MTU2_DEAD_TIME_DISABLE or PDL_MTU2_DEAD_TIME_ENABLE	Disable or enable dead time generation.																				
PDL_MTU2_WAVEFORM_RETAIN_DISABLE or PDL_MTU2_WAVEFORM_RETAIN_ENABLE	Disable or enable waveform output retention.																				
PDL_MTU2_CNT_CLEAR_CM_A_DISABLE or PDL_MTU2_CNT_CLEAR_CM_A_ENABLE	Disable or enable counter clearing on TGRA compare match.																				
PDL_MTU2_PWM_RS_COMP_ENABLE	Enable reset-synchronised or complementary PWM mode.																				
PDL_MTU2_ACCESS_DISABLE PDL_MTU2_ACCESS_ENABLE	Control access to the registers and counters in channels 3 and 4.																				
PDL_MTU2_REGISTER_DEAD_TIME	Update the dead time data register (TDDR).																				
PDL_MTU2_REGISTER_CYCLE_DATA	Update the cycle data register (TCDR).																				
PDL_MTU2_REGISTER_CYCLE_BUFFER	Update the cycle buffer register (TCBR).																				
Return value	True if all parameters are valid and exclusive; otherwise false.																				
Category	Multi-function Timer Pulse Unit																				

Reference

R_MTU2_ControlChannel

Remarks

- Either this function or R_MTU2_ControlChannel must be used to start the timers.
- The Stop operation is executed at the start of this function.
The Start operation is executed at the end.
Therefore, both options can be selected together with other changes in one function call.
- The register access enable operation is executed at the start of this function.
The register access disable operation is executed at the end.
Therefore, both options can be selected together with other changes in one function call.
- If noise filter is enabled, before starting the timer make sure at least 2 cycles of the selected noise filter clock has elapsed after the timer configuration (use R_MTU2_Create).
- When generating PWM waveforms in complementary PWM mode 1 to complementary PWM mode 3, set the timer cycle data registers (TCDR) and timer dead time data registers (TDDR) to values that satisfy the following condition:
Timer cycle data register value > Timer dead time data register value × 2 + 2

Program example

```

/* RPDL definitions */
#include "r_pdl_mtu2.h"

/* RPDL device-specific definitions */
#include "r_pdl_definitions.h"

void func(void)
{
    /* Allocate a copy of the structure for the selected channel */
    R_MTU2_ControlUnit_structure unit0_parameters;

    unit0_parameters.simultaneous_control = PDL_MTU2_STOP_CH_0;
    unit0_parameters.output_control =
PDL_MTU2_OUT_P_PHASE_ALL_HIGH_LOW;
    unit0_parameters.general_control = PDL_MTU2_DEAD_TIME_ENABLE;
    unit0_parameters.register_selection = PDL_MTU2_REGISTER_DEAD_TIME
| PDL_MTU2_REGISTER_CYCLE_DATA;
    unit0_parameters.TDDR_value = 0xFFDD;
    unit0_parameters.TCDR_value = 0x0100;

    /* Modify the operation of unit 0 */
    R_MTU2_ControlUnit(
        0,
        &unit0_parameters
    );
}

```

6) R_MTU2_ReadChannel

Synopsis

Read from MTU channel registers.

Prototype

```
bool R_MTU2_ReadChannel(
    uint8_t data1, // Channel selection
    uint8_t * data2, // A pointer to the data storage location
    uint16_t * data3, // A pointer to the data storage location
    uint16_t * data4, // A pointer to the data storage location
    uint16_t * data5, // A pointer to the data storage location
    uint16_t * data6, // A pointer to the data storage location
    uint16_t * data7, // A pointer to the data storage location
    uint16_t * data8, // A pointer to the data storage location
    uint16_t * data9 // A pointer to the data storage location
);
```

Description (1/2)

Read any of the timer's counter, compare or status flag registers.

[data1]
The channel number n (where n = 0 to 5).

[data2]
The status flags shall be stored in the format below.
The input capture / compare match flags will be set to 1 if the condition has been detected.
Specify PDL_NO_PTR if the flags are not to be read.

For n = 0

b7							b6		b5	b4	b3	b2		b1	b0
Detection														Count direction	
Overflow	Input capture / compare match														
V	F	E	D	C	B		A								0: down 1: up

For n = 1 or 2

b7							b6		b5 – b3			b2		b1	b0
Detection														Count direction	
Underflow	Overflow	-			Input capture / compare match										
U	V	0			B		A								0: down 1: up

For n = 3

b7							b6		b5	b4	b3	b2		b1	b0
Detection														Count direction	
-	Overflow	-	Input capture / compare match												
0	V	0	D	C	B		A								0: down 1: up

For n = 4

b7							b6		b5	b4	b3	b2		b1	b0
Detection														Count direction	
-	Over or underflow	-	Input capture / compare match												
0	V	0	D	C	B		A								0: down 1: up

For n = 5

b7 – b3							b2		b1	b0			
Detection													
Input capture / compare match													
0							W		V		U		

Description (2/2)	<p>[data3] For n = 0 to 4: A pointer to where the TNCT register value shall be stored. For n = 5: A pointer to where the TNCTU register value shall be stored. Specify PDL_NO_PTR if it is not required.</p> <p>[data4] For n = 0 to 4: A pointer to where the TGRA register value shall be stored. For n = 5: A pointer to where the TNCTV register value shall be stored. Specify PDL_NO_PTR if it is not required.</p> <p>[data5] For n = 0 to 4: A pointer to where the TGRB register value shall be stored. For n = 5: A pointer to where the TNCTW register value shall be stored. Specify PDL_NO_PTR if it is not required.</p> <p>[data6] For n = 0, 3 or 4: A pointer to where the TGRC register value shall be stored. For n = 5: A pointer to where the TGRU register value shall be stored. Specify PDL_NO_PTR if it is not required.</p> <p>[data7] For n = 0, 3 or 4: A pointer to where the TGRD register value shall be stored. For n = 5: A pointer to where the TGRV register value shall be stored. Specify PDL_NO_PTR if it is not required.</p> <p>[data8] For n = 0: A pointer to where the TGRE register value shall be stored. For n = 5: A pointer to where the TGRW register value shall be stored. Specify PDL_NO_PTR if it is not required.</p> <p>[data9] For n = 0: A pointer to where the TGRF register value shall be stored. Specify PDL_NO_PTR if it is not required.</p>
Return value	True if all parameters are valid and exclusive; otherwise false.
Category	Multi-function Timer Pulse Unit
Reference	None.
Remarks	<ul style="list-style-type: none"> If the flags are read, any detection flag that has been set to 1 shall be automatically cleared to 0 by this function.

Program example

```
/* RPDL definitions */
#include "r_pdl_mtu2.h"

/* RPDL device-specific definitions */
#include "r_pdl_definitions.h"

uint8_t Flags;
uint16_t General_A;
uint16_t General_D;

void func(void)
{
    /* Read the status flags and registers of channel 3 */
    R_MTU2_ReadChannel(
        3,
        &Flags,
        PDL_NO_PTR,
        &General_A,
        PDL_NO_PTR,
        PDL_NO_PTR,
        &General_D,
        PDL_NO_PTR,
        PDL_NO_PTR
    );
}
```

7) R_MTU2_ReadUnit

Synopsis

Read from MTU registers.

Prototype

```
bool R_MTU2_ReadUnit(
    uint8_t data1,    // Unit selection
    uint16_t * data2, // A pointer to the data storage location
    uint8_t * data3   // A pointer to the data storage location
);
```

Description

Read any of the timer unit's counter registers

[data1]

The unit number n (where n = 0).

[data2]

A pointer to where the Timer subcounter register (TCNTS) value shall be stored. Specify PDL_NO_PTR if it is not required.

[data3]

Where the Timer Interrupt Skipping Counter register (TITCNT) value shall be stored. Specify PDL_NO_PTR if it is not required.

Return value

True if all parameters are valid and exclusive; otherwise false.

Category

Multi-function Timer Pulse Unit

Reference

None.

Remarks

- None.

Program example

```
/* RPDL definitions */
#include "r_pdl_mtu2.h"

/* RPDL device-specific definitions */
#include "r_pdl_definitions.h"

uint16_t Sub_count;
uint8_t Skip_count;

void func(void)
{
    /* Read the counter registers for unit 0 */
    R_MTU2_ReadUnit(
        0,
        &Sub_count,
        &Skip_count
    );
}
```

4.2.15. Port Output Enable

1) R_POE_Set

Synopsis

Configure the Port Output Enable module.

Prototype

```
bool R_POE_Set(
    uint32_t data1, // Input configuration selection
    uint16_t data2, // Input POEn# pin selection
    uint16_t data3  // Output configuration selection
);
```

Description (1/2)

Initialise the POE pins.

[data1]

Configure the input pin detection for pins POE0 to POE3 and POE8. If multiple selections are required, use “|” to separate each selection. All settings are optional. Specify PDL_NO_DATA if none are required.

PDL_POE_0_MODE_EDGE or PDL_POE_0_MODE_LOW_8 or PDL_POE_0_MODE_LOW_16 or PDL_POE_0_MODE_LOW_128	For each pin POE0 to POE3 and POE8 select falling edge or low level for 16 samples at PCLKB ÷ 8, 16 or 128.
PDL_POE_1_MODE_EDGE or PDL_POE_1_MODE_LOW_8 or PDL_POE_1_MODE_LOW_16 or PDL_POE_1_MODE_LOW_128	
PDL_POE_2_MODE_EDGE or PDL_POE_2_MODE_LOW_8 or PDL_POE_2_MODE_LOW_16 or PDL_POE_2_MODE_LOW_128	
PDL_POE_3_MODE_EDGE or PDL_POE_3_MODE_LOW_8 or PDL_POE_3_MODE_LOW_16 or PDL_POE_3_MODE_LOW_128	
PDL_POE_8_MODE_EDGE or PDL_POE_8_MODE_LOW_8 or PDL_POE_8_MODE_LOW_16 or PDL_POE_8_MODE_LOW_128	

[data2]

Allocate the pins for signals POE0# to POE3# and POE8#. If multiple selections are required, use “|” to separate each selection. All settings are optional. Specify PDL_NO_DATA if none are required.

PDL_POE_0_PORT_C_4 or PDL_POE_0_PORT_D_7	Pin POE0# input selection
PDL_POE_1_PORT_B_5 or PDL_POE_1_PORT_D_6	Pin POE1# input selection
PDL_POE_2_PORT_3_4 or PDL_POE_2_PORT_A_6 or PDL_POE_2_PORT_D_5	Pin POE2# input selection
PDL_POE_3_PORT_3_3 or PDL_POE_3_PORT_B_3 or PDL_POE_3_PORT_D_4	Pin POE3# input selection
PDL_POE_8_PORT_1_7 or PDL_POE_8_PORT_3_0 or PDL_POE_8_PORT_D_3 or PDL_POE_8_PORT_E_3	Pin POE8# input selection

Description (2/2)

[data3]

Configure pin output control.
 If multiple selections are required, use “|” to separate each selection.
 All settings are optional. Specify PDL_NO_DATA if none are required.

- High impedance request detection

PDL_POE_HI_Z_REQ_8_ENABLE	If a request is detected on pin POE8, place the MTU channel 0 I/O pins in the high impedance state.
PDL_POE_HI_Z_REQ_MTI0C0A	Select the MTU channel 0 I/O pins that shall be controlled by the high impedance request, software control or the oscillation stop detection flag.
PDL_POE_HI_Z_REQ_MTI0C0B	
PDL_POE_HI_Z_REQ_MTI0C0C	
PDL_POE_HI_Z_REQ_MTI0C0D	

PDL_POE_HI_Z_REQ_OSTSTE	Select the MTI0C0A, MTI0C0B, MTI0C0C, MTI0C0D, MTI0C3B, MTI0C3D, MTI0C4A, MTI0C4B, MTI0C4C, and MTI0C4D pins in high-impedance on detection that oscillation has stopped.
-------------------------	---

- Output short detection

PDL_POE_SHORT_3_4_HI_Z	If a short is detected, place the all the selected MTU channel 3 and 4 pins in the high impedance state.
PDL_POE_SHORT_MTI0C4BD_A	Select the MTU channel I/O pin pairs that shall be controlled by the short detection response, software control or the oscillation stop detection flag.
PDL_POE_SHORT_MTI0C4AC_A	
PDL_POE_SHORT_MTI0C3BD_A	

Return value

True if all parameters are valid and exclusive; otherwise false.

Category

Port Output Enable

Reference

R_POE_Control, R_POE_GetStatus, R_MTU2_Set

Remarks

- Do not select MTU pins that are not used.
- Using R_POE_GetStatus to get the oscillation stop detection flag.

Program example

```

/* RPDL definitions */
#include "r_pdl_poe.h"

/* RPDL device-specific definitions */
#include "r_pdl_definitions.h"

void func(void)
{
    /* Configure POE pins 0 and 3 */
    R_POE_Set(
        PDL_POE_0_MODE_EDGE | PDL_POE_3_MODE_LOW_128,
        PDL_POE_0_PORT_D_7 | PDL_POE_3_PORT_D_4,
        PDL_NO_DATA
    );
}
    
```

2) R_POE_Create

Synopsis

Configure the Port Output Enable event handling.

Prototype

```
bool R_POE_Create(
    uint8_t data1, // Input configuration selection
    void * func1, // Callback function
    void * func2, // Callback function
    uint8_t data2 // Interrupt priority level
);
```

Description

Enable interrupts and register callback functions.

[data1]

Interrupt selection.
If multiple selections are required, use “|” to separate each selection.
The default settings are shown in **bold**. Specify PDL_NO_DATA to use the defaults.

- High impedance request response

PDL_POE_IRQ_HI_Z_0_3_DISABLE or PDL_POE_IRQ_HI_Z_0_3_ENABLE	Disable or enable an interrupt on detection of any high impedance request on pins POE0 to POE3.
---	---

- Output short detection response

PDL_POE_IRQ_SHORT_3_4_DISABLE or PDL_POE_IRQ_SHORT_3_4_ENABLE	Disable or enable an interrupt on detection of a short on any MTU channel 3 or 4 two-phase output pair.
---	---

[func1]

The function to be called when an enabled request on pins POE0 to POE3 or an output short on MTU channels 3 or 4 occurs.
Specify PDL_NO_FUNC if not required.

[func2]

The function to be called when a request on pin POE8 occurs.
Specify PDL_NO_FUNC if not required.

[data2]

The interrupt priority level. Select between 1 (lowest priority) and 15 (highest priority).
This parameter will be ignored if PDL_NO_FUNC is specified for all parameters func1 and func2.

Return value

True if all parameters are valid and exclusive; otherwise false.

Category

Port Output Enable

Reference

R_POE_Set, R_POE_GetStatus

Remarks

- Use R_POE_GetStatus to determine the interrupt cause.
- A callback function is executed by the interrupt processing function. This means that no other interrupt can be processed until the callback function has completed.

Program example

```
/* RPDL definitions */
#include "r_pdl_poe.h"

/* RPDL device-specific definitions */
#include "r_pdl_definitions.h"

void POE0_handler(void){}

void func(void)
{
    /* Assign the callback function for pin POE0 */
    R_POE_Create(
        PDL_POE_IRQ_HI_Z_0_3_ENABLE,
        POE0_handler,
        PDL_NO_FUNC,
        1
    );
}
```

3) R_POE_Control

Synopsis

Control the Port Output Enable module.

Prototype

```
bool R_POE_Control (
    uint8_t data1, // Control options
    uint16_t data2, // Control options
    uint8_t data3 // Control options
);
```

Description

Change the state of output pins, status flags and interrupt control.

[data1]

Manual high impedance control.

If multiple selections are required, use “|” to separate each selection.

All settings are optional. Specify PDL_NO_DATA if no control is required.

- MTU channel high impedance control

PDL_POE_MTU3_MTU4_HI_Z_ON or PDL_POE_MTU3_MTU4_HI_Z_OFF	Control the high impedance state of the MTU3 and MTU4 outputs.
PDL_POE_MTU0_HI_Z_ON or PDL_POE_MTU0_HI_Z_OFF	Control the high impedance state of the MTU0 outputs.

[data2]

Event flag control.

If multiple selections are required, use “|” to separate each selection.

All settings are optional. Specify PDL_NO_DATA if no control is required.

PDL_POE_FLAG_POE0_CLEAR	Select the flags to be cleared.
PDL_POE_FLAG_POE1_CLEAR	
PDL_POE_FLAG_POE2_CLEAR	
PDL_POE_FLAG_POE3_CLEAR	
PDL_POE_FLAG_POE8_CLEAR	
PDL_POE_FLAG_OSTSTF_CLEAR	
PDL_POE_FLAG_SHORT_3_4_CLEAR	

[data3]

Interrupt control.

If multiple selections are required, use “|” to separate each selection.

All settings are optional. Specify PDL_NO_DATA if no control is required.

- High impedance request response

PDL_POE_IRQ_HI_Z_0_3_DISABLE	Control interrupts on detection of any high impedance request on pins POE0 to POE3.
PDL_POE_IRQ_HI_Z_0_3_ENABLE	
PDL_POE_IRQ_HI_Z_8_DISABLE	Control interrupts on detection of a high impedance request on pin POE8.
PDL_POE_IRQ_HI_Z_8_ENABLE	

- Output short detection response

PDL_POE_IRQ_SHORT_3_4_DISABLE	Control interrupts on detection of a short on any MTU channel 3 or 4 two-phase output pair.
PDL_POE_IRQ_SHORT_3_4_ENABLE	

Return value

True if all parameters are valid and exclusive; otherwise false.

Category

Port Output Enable

Reference

R_POE_Create

Remarks

- Call R_POE_Create before using this function.
- Clearing a level-triggered event flag will fail if the trigger is still asserted.
- Interrupt disabling is processed at the start of the function and enabling is processed at the end. This allows a flag to be cleared and the interrupt re-enabled in one function call.

Program example

```
/* RPDL definitions */
#include "r_pdl_poe.h"

/* RPDL device-specific definitions */
#include "r_pdl_definitions.h"

void func(void)
{
    /* Select high impedance on the MTU0 I/O pins */
    R_POE_Control(
        PDL_POE_MTU0_HI_Z_ON,
        PDL_NO_DATA,
        PDL_NO_DATA
    );
}
```

4) R_POE_GetStatus

Synopsis Check the status of the Port Output Enable module.

Prototype `bool R_POE_GetStatus(
 uint16_t * data // Status flags pointer
);`

Description Return the status flags.

[data]
 The status flags shall be stored in the following format.

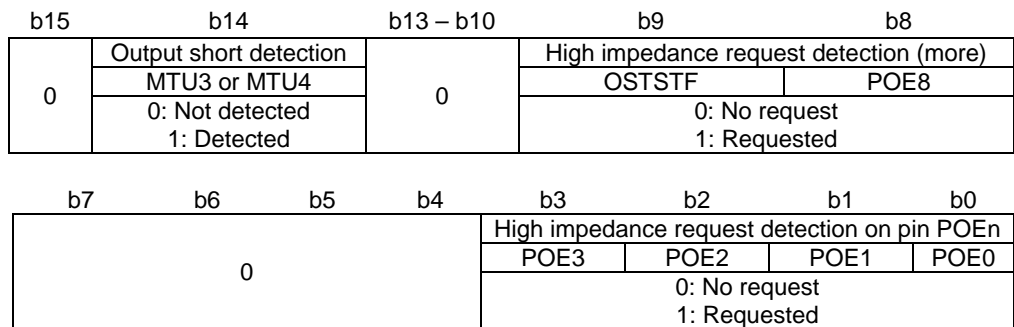

Return value True.

Category Port Output Enable

Reference R_POE_Control

Remarks • Use R_POE_Control to clear the flags.

Program example

```

/* RPDL definitions */
#include "r_pdl_poe.h"

/* RPDL device-specific definitions */
#include "r_pdl_definitions.h"

void func(void)
{
    uint16_t StatusFlags;

    /* Read the POE status */
    R_POE_GetStatus(
        & StatusFlags
    );
}
    
```

4.2.16. 16-bit Timer Pulse Unit

1) R_TPU_Set

Synopsis

Configure the Timer Pulse Unit pins.

Prototype

```
bool R_TPU_Set(
    uint8_t data1, // Channel selection
    uint32_t data2 // Pin configuration
);
```

Description (1/2)

Initialise the TPU pins.

[data1]

The channel number n (where n = 0 to 11).

[data2]

Configure the TPU input and output pins for the channel. Use "|" to separate each selection.

- Valid when n = 0

PDL_TPU_PIN_A0_P86 or PDL_TPU_PIN_A0_PA0	Select the P86 or PA0 pin for TIOCA0.
PDL_TPU_PIN_B0_P17 or PDL_TPU_PIN_B0_PA1	Select the P17 or PA1 pin for TIOCB0.
PDL_TPU_PIN_C0_P32	Select the P32 pin for TIOCC0.
PDL_TPU_PIN_D0_P33 or PDL_TPU_PIN_D0_PA3	Select the P33 or PA3 pin for TIOCD0.

- Valid when n = 1

PDL_TPU_PIN_A1_P56 or PDL_TPU_PIN_A1_PA4	Select the P56 or PA4 pin for TIOCA1.
PDL_TPU_PIN_B1_P16 or PDL_TPU_PIN_B1_PA5	Select the P16 or PA5 pin for TIOCB1.

- Valid when n = 2

PDL_TPU_PIN_A2_P87 or PDL_TPU_PIN_A2_PA6	Select the P87 or PA6 pin for TIOCA2.
PDL_TPU_PIN_B2_P15 or PDL_TPU_PIN_B2_PA7	Select the P15 or PA7 pin for TIOCB2.

- Valid when n = 3

PDL_TPU_PIN_A3_P21 or PDL_TPU_PIN_A3_PB0	Select the P21 or PB0 pin for TIOCA3.
PDL_TPU_PIN_B3_P20 or PDL_TPU_PIN_B3_PB1	Select the P20 or PB1 pin for TIOCB3.
PDL_TPU_PIN_C3_P22 or PDL_TPU_PIN_C3_PB2	Select the P22 or PB2 pin for TIOCC3.
PDL_TPU_PIN_D3_P23 or PDL_TPU_PIN_D3_PB3	Select the P23 or PB3 pin for TIOCD3.

- Valid when n = 4

PDL_TPU_PIN_A4_P25 or PDL_TPU_PIN_A4_PB4	Select the P25 or PB4 pin for TIOCA4.
PDL_TPU_PIN_B4_P24 or PDL_TPU_PIN_B4_PB5	Select the P24 or PB5 pin for TIOCB4.

- Valid when n = 5

PDL_TPU_PIN_A5_P13 or PDL_TPU_PIN_A5_PB6	Select the P13 or PB6 pin for TIOCA5.
PDL_TPU_PIN_B5_P14 or PDL_TPU_PIN_B5_PB7	Select the P14 or PB7 pin for TIOCB5.

Description (2/2)			
• Valid when n = 6	PDL_TPU_PIN_A6_PC6	Select the PC6 pin for TIOCA6.	
	PDL_TPU_PIN_B6_PC7	Select the PC7 pin for TIOCB6.	
	PDL_TPU_PIN_C6_PC4	Select the PC4 pin for TIOCC6.	
	PDL_TPU_PIN_D6_PC5	Select the PC5 pin for TIOCD6.	
• Valid when n = 7	PDL_TPU_PIN_A7_PD0	Select the PD0 pin for TIOCA7.	
	PDL_TPU_PIN_B7_PD1	Select the PD1 pin for TIOCB7.	
• Valid when n = 8	PDL_TPU_PIN_A8_PD2	Select the PD2 pin for TIOCA8.	
	PDL_TPU_PIN_B8_PD3	Select the PD3 pin for TIOCB8.	
• Valid when n = 9	PDL_TPU_PIN_A9_PE2	Select the PE2 pin for TIOCA9.	
	PDL_TPU_PIN_B9_PE3	Select the PE3 pin for TIOCB9.	
	PDL_TPU_PIN_C9_PE0	Select the PE0 pin for TIOCC9.	
	PDL_TPU_PIN_D9_PE1	Select the PE1 pin for TIOCD9.	
• Valid when n = 10	PDL_TPU_PIN_A10_PE4	Select the PE4 pin for TIOCA10.	
	PDL_TPU_PIN_B10_PE5	Select the PE5 pin for TIOCB10.	
• Valid when n = 11	PDL_TPU_PIN_A11_PE6	Select the PE6 pin for TIOCA11.	
	PDL_TPU_PIN_B11_PE7	Select the PE7 pin for TIOCB11.	
• Valid when n = 0,1,2,3,4,5	PDL_TPU_PIN_CLKA_P14 or PDL_TPU_PIN_CLKA_PC2	Select the P14 or PC2 pin for TCLKA.	
	• Valid when n = 0,1,2,5	PDL_TPU_PIN_CLKB_P15 or PDL_TPU_PIN_CLKB_PA3 or PDL_TPU_PIN_CLKB_PC3	Select the P15, PA3 or PC3 pin for TCLKB.
• Valid when n = 0,2,4,5		PDL_TPU_PIN_CLKC_P16 or PDL_TPU_PIN_CLKC_PB2 or PDL_TPU_PIN_CLKC_PC0	Select the P16, PB2 or PC0 pin for TCLKC.
		PDL_TPU_PIN_CLKD_P17 or PDL_TPU_PIN_CLKD_PB3 or PDL_TPU_PIN_CLKD_PC1	Select the P17, PB3 or PC1 pin for TCLKD.
• Valid when n = 6,7,8,9,10,11	PDL_TPU_PIN_CLKE_PC4	Select the PC4 pin for TCLKE.	
	• Valid when n = 6,7,8,11	PDL_TPU_PIN_CLKF_PC5	Select the PC5 pin for TCLKF.
• Valid when n = 6,8,10,11		PDL_TPU_PIN_CLKG_PD1	Select the PD1 pin for TCLKG.
	PDL_TPU_PIN_CLKH_PD3	Select the PD3 pin for TCLKH.	

Return value	True if all parameters are valid and exclusive; otherwise false.
---------------------	--

Category	Timer Pulse Unit
-----------------	------------------

Reference	R_TPU_Create
------------------	--------------

Remarks

- Before calling R_TPU_Create, call this function to configure the relevant pins.
- Not more than one peripheral function can be assigned to a single pin.
- Make sure the configuration of TCLK pins is consistent for all the channels.
- Device packages with 100 or fewer pins do not have all of the pin options.

Program example

```
/* RPD_L definitions */
#include "r_pdl_tpu.h"

/* RPD_L device-specific definitions */
#include "r_pdl_definitions.h"

void func(void)
{
    /* Configure TPU TIOCA0 and TCLKA */
    R_TPU_Set(
        0,
        PDL_TPU_PIN_A0_P86 | PDL_TPU_PIN_CLKA_P14
    );
}
```

2) R_TPU_Create

Synopsis

Configure a Timer Pulse Unit channel.

Prototype

```
bool R_TPU_Create(
    uint8_t data1, // Channel selection
    uint32_t data2, // Configuration selection
    uint32_t data3, // Configuration selection
    uint32_t data4, // Configuration selection
    uint32_t data5, // Configuration selection
    uint16_t data6, // Register value
    uint16_t data7, // Register value
    uint16_t data8, // Register value
    uint16_t data9, // Register value
    uint16_t data10, // Register value
    void * func1, // Callback function
    void * func2, // Callback function
    void * func3, // Callback function
    void * func4, // Callback function
    uint8_t data11, // Interrupt priority level
    void * func5, // Callback function
    void * func6, // Callback function
    uint8_t data12 // Interrupt priority level
);
```

Description (1/6)

Set up a 16-bit TPU channel.

[data1]
The channel number n (where n = 0 to 11).

[data2]
Configure the channel mode.
If multiple selections are required, use “|” to separate each selection.
The default settings are shown in **bold**. Specify PDL_NO_DATA to use the defaults.

• Operation mode

PDL_TPU_MODE_NORMAL or PDL_TPU_MODE_PWM1 or PDL_TPU_MODE_PWM2 or	Normal operation. Pulse Width Modulation (PWM) mode 1 or 2.
PDL_TPU_MODE_PHASE1 or PDL_TPU_MODE_PHASE2 or PDL_TPU_MODE_PHASE3 or PDL_TPU_MODE_PHASE4	Phase counting mode 1, 2, 3 or 4. Valid for n = 1, 2, 4, 5, 7, 8, 10 and 11.

• Timer start/stop

PDL_TPU_START or PDL_TPU_STOP	Start or stop the count operation.
---	------------------------------------

• Synchronous mode

PDL_TPU_SYNC_DISABLE or PDL_TPU_SYNC_ENABLE	Disable or enable synchronous operation.
---	--

• Noise Filter for TIOCA

PDL_TPU_TIOCA_NF_DISABLE or PDL_TPU_TIOCA_NF_ENABLE	Disable or enable noise filter for TIOCA.
---	---

• Noise Filter for TIOCB

PDL_TPU_TIOCB_NF_DISABLE or PDL_TPU_TIOCB_NF_ENABLE	Disable or enable noise filter for TIOCB.
---	---

• Noise Filter for TIOCC (valid for n = 0, 3, 6 and 9).

PDL_TPU_TIOCC_NF_DISABLE or PDL_TPU_TIOCC_NF_ENABLE	Disable or enable noise filter for TIOCC.
---	---

Description (2/6)

- Noise Filter for TIOCD (valid for n = 0, 3, 6 and 9).

PDL_TPU_TIOCD_NF_DISABLE or PDL_TPU_TIOCD_NF_ENABLE	Disable or enable noise filter for TIOCD.
--	---

- Noise filter clock select

PDL_TPU_NF_CLK_PCLK_DIV_1 or PDL_TPU_NF_CLK_PCLK_DIV_8 or PDL_TPU_NF_CLK_PCLK_DIV_32 or PDL_TPU_NF_CLK_COUNTING	The noise filter clock signal $PCLK \div 1, 8, 32$, or the same as the TPU counting clock.
--	---

- DMAC and / or DTC trigger control for TGRA

PDL_TPU_TGRA_DMAC_DTC_TRIGGER_DISABLE or PDL_TPU_TGRA_DMAC_TRIGGER_ENABLE or PDL_TPU_TGRA_DTC_TRIGGER_ENABLE	Disable or enable activation of the DMAC or DTC when a TGRA compare match occurs.
---	---

- DTC trigger control for TGRB

PDL_TPU_TGRB_DTC_TRIGGER_DISABLE or PDL_TPU_TGRB_DTC_TRIGGER_ENABLE	Enable activation of the DTC when a TGRB compare match occurs.
--	--

- DTC trigger control for TGRC (valid for n = 0, 3, 6 and 9).

PDL_TPU_TGRC_DTC_TRIGGER_DISABLE or PDL_TPU_TGRC_DTC_TRIGGER_ENABLE	Enable activation of the DTC when a TGRB compare match occurs.
--	--

- DTC trigger control for TGRD (valid for n = 0, 3, 6 and 9).

PDL_TPU_TGRD_DTC_TRIGGER_DISABLE or PDL_TPU_TGRD_DTC_TRIGGER_ENABLE	Enable activation of the DTC when a TGRB compare match occurs.
--	--

[data3]

Configure the counter operation.

If multiple selections are required, use “|” to separate each selection.

The default settings are shown in **bold**. Specify PDL_NO_DATA to use the defaults.

- Counter clock source selection

PDL_TPU_CLK_PCLK_DIV_1 or PDL_TPU_CLK_PCLK_DIV_4 or PDL_TPU_CLK_PCLK_DIV_16 or PDL_TPU_CLK_PCLK_DIV_64 or PDL_TPU_CLK_PCLK_DIV_256 or PDL_TPU_CLK_PCLK_DIV_1024 or PDL_TPU_CLK_PCLK_DIV_4096 or PDL_TPU_CLK_TCLKA or PDL_TPU_CLK_TCLKB or PDL_TPU_CLK_TCLKC or PDL_TPU_CLK_TCLKD or PDL_TPU_CLK_TCLKE or PDL_TPU_CLK_TCLKF or PDL_TPU_CLK_TCLKG or PDL_TPU_CLK_TCLKH or PDL_TPU_CLK_TPU	The internal clock signal $PCLK \div 1, 4, 16$ or 64. PCLK $\div 256$. Valid for n = 1, 3, 5, 7, 9 and 11. PCLK $\div 1024$. Valid for n = 2, 3, 4, 8, 9 and 10. PCLK $\div 4096$. Valid for n = 3 and 9. TCLKA pin input. Valid for n = 0 to 5. TCLKB pin input. Valid for n = 0, 1 and 2. TCLKC pin input. Valid for n = 0, 2, 4 and 5. TCLKD pin input. Valid for n = 0 and 5. TCLKE pin input. Valid for n = 6 to 11. TCLKF pin input. Valid for n = 6, 7 and 8. TCLKG pin input. Valid for n = 6, 8, 10, and 11. TCLKH pin input. Valid for n = 6 and 11. The overflow / underflow signal from TPU(n+1). Valid for n = 1, 4, 7, and 10.
--	--

- Counter clock edge selection

PDL_TPU_CLK_FALLING or PDL_TPU_CLK_RISING or PDL_TPU_CLK_BOTH	The clock signal shall be counted on falling, rising or both edges.
--	---

Description (3/6)

• Counter clearing

PDL_TPU_CLEAR_DISABLE or	Clearing is disabled.
PDL_TPU_CLEAR_CM_A or	Cleared after a TGRA compare match occurs.
PDL_TPU_CLEAR_CM_B or	Cleared after a TGRB compare match occurs.
PDL_TPU_CLEAR_CM_C or	Cleared after a TGRC compare match occurs. Valid for n = 0, 3, 6 and 9.
PDL_TPU_CLEAR_CM_D or	Cleared after a TGRD compare match occurs. Valid for n = 0, 3, 6 and 9.
PDL_TPU_CLEAR_CM_SYNC	Cleared by counter clearing on another channel configured for synchronous operation.

• Buffer operation (valid for channels 0, 3, 6 and 9)

PDL_TPU_BUFFER_AC_DISABLE or PDL_TPU_BUFFER_AC_ENABLE	Disable or enable buffer operation for registers TGRA and TGRC.
PDL_TPU_BUFFER_BD_DISABLE or PDL_TPU_BUFFER_BD_ENABLE	Disable or enable buffer operation for registers TGRB and TGRD.

• ADC trigger control

PDL_TPU_ADC_TRIG_DISABLE or PDL_TPU_ADC_TRIG_ENABLE	Disable or enable ADC conversion start requests on a TGRA input capture / compare match. Not valid for n= 5 and 6.
---	---

[data4]

Configure the operation for general registers A and B.

If multiple selections are required, use “|” to separate each selection.

The default settings are shown in **bold**. Specify PDL_NO_DATA to use the defaults.

• Input capture / output compare control for register TGRA

PDL_TPU_A_OC_DISABLED or PDL_TPU_A_OC_LOW or PDL_TPU_A_OC_LOW_CM_HIGH or PDL_TPU_A_OC_LOW_CM_INV or PDL_TPU_A_OC_HIGH_CM_LOW or PDL_TPU_A_OC_HIGH or PDL_TPU_A_OC_HIGH_CM_INV or	TIOCA _n output disabled. TIOCA _n output low. TIOCA _n initial output low; goes high at compare match. TIOCA _n initial output low; toggles at compare match. TIOCA _n initial output high; goes low at compare match. TIOCA _n output high. TIOCA _n initial output high; toggles at compare match.
PDL_TPU_A_IC_RISING_EDGE or PDL_TPU_A_IC_FALLING_EDGE or PDL_TPU_A_IC_BOTH_EDGES or	Input capture at TIOCA _n rising edge. Input capture at TIOCA _n falling edge. Input capture at TIOCA _n both edges.
PDL_TPU_A_IC_TPU_COUNT_CLK or	Input capture at TPU(n+1) count clock count-up or count-down. Invalid if TPU(n+1) uses PCLK ÷ 1. Valid for n = 0, 3, 6 and 9.
PDL_TPU_A_IC_TPU_CM_IC	Input capture at TPU(n-1) TGRA compare match or input compare. Valid for n = 1, 4, 7 and 10.

Description (4/6)

- Input capture / output compare control for register TGRB

PDL_TPU_B_OC_DISABLED or PDL_TPU_B_OC_LOW or PDL_TPU_B_OC_LOW_CM_HIGH or PDL_TPU_B_OC_LOW_CM_INV or PDL_TPU_B_OC_HIGH_CM_LOW or PDL_TPU_B_OC_HIGH or PDL_TPU_B_OC_HIGH_CM_INV or	TIOCBn output disabled. TIOCBn output low. TIOCBn initial output low; goes high at compare match. TIOCBn initial output low; toggles at compare match. TIOCBn initial output high; goes low at compare match. TIOCBn output high. TIOCBn initial output high; toggles at compare match.
PDL_TPU_B_IC_RISING_EDGE or PDL_TPU_B_IC_FALLING_EDGE or PDL_TPU_B_IC_BOTH_EDGES or	Input capture at TIOCBn or TIOCA n rising edge. Input capture at TIOCBn or TIOCA n falling edge. Input capture at TIOCBn or TIOCA n both edges. See below for TIOCBn or TIOCA n pin selection.
PDL_TPU_B_IC_TPU_COUNT_CLK or	Input capture at TPU(n+1) count clock count-up or count-down. Invalid if TPU(n+1) uses PCLK ÷ 1. Valid for n = 0, 3, 6 and 9.
PDL_TPU_B_IC_TPU_CM_IC	Input capture at TPU(n-1) TGRC compare match or input compare. Valid for n = 1, 4, 7 and 10.

- TGRB input capture input selection

PDL_TPU_B_IC_TIOCB or PDL_TPU_B_IC_TIOCA	Input capture using pin TIOCBn or TIOCA n.
--	--

[data5]

Configure the operation for general registers C and D (valid for n = 0, 3, 6 and 9).
If multiple selections are required, use “|” to separate each selection.
The default settings are shown in **bold**. Specify PDL_NO_DATA to use the defaults.

- Input capture / output compare control for register TGRC.

PDL_TPU_C_OC_DISABLED or PDL_TPU_C_OC_LOW or PDL_TPU_C_OC_LOW_CM_HIGH or PDL_TPU_C_OC_LOW_CM_INV o PDL_TPU_C_OC_HIGH_CM_LOW or PDL_TPU_C_OC_HIGH or PDL_TPU_C_OC_HIGH_CM_INV or	TIOCCn output disabled. TIOCCn output low. TIOCCn initial output low; goes high at compare match. TIOCCn initial output low; toggles at compare match. TIOCCn initial output high; goes low at compare match. TIOCCn output high. TIOCCn initial output high; toggles at compare match.
PDL_TPU_C_IC_RISING_EDGE or PDL_TPU_C_IC_FALLING_EDGE or PDL_TPU_C_IC_BOTH_EDGES or	Input capture at TIOCCn rising edge. Input capture at TIOCCn falling edge. Input capture at TIOCCn both edges.
PDL_TPU_C_IC_TPU_COUNT_CLK	Input capture at TPU(n+1) count clock count-up or count-down. Invalid if TPU(n+1) uses PCLK ÷ 1.

Description (5/6)

- Input capture / output compare control for register TGRD.

PDL_TPU_D_OC_DISABLED or PDL_TPU_D_OC_LOW or PDL_TPU_D_OC_LOW_CM_HIGH or PDL_TPU_D_OC_LOW_CM_INV or PDL_TPU_D_OC_HIGH_CM_LOW or PDL_TPU_D_OC_HIGH or PDL_TPU_D_OC_HIGH_CM_INV or	TIOCDn output disabled. TIOCDn output low. TIOCDn initial output low; goes high at compare match. TIOCDn initial output low; toggles at compare match. TIOCDn initial output high; goes low at compare match. TIOCDn output high. TIOCDn initial output high; toggles at compare match.
PDL_TPU_D_IC_RISING_EDGE or PDL_TPU_D_IC_FALLING_EDGE or PDL_TPU_D_IC_BOTH_EDGES or	Input capture at TIOCDn or TIOCCn rising edge. Input capture at TIOCDn or TIOCCn falling edge. Input capture at TIOCDn or TIOCCn both edges. See below for TIOCDn or TIOCCn pin selection.
PDL_TPU_D_IC_TPU_COUNT_CLK	Input capture at TPU(n+1) count clock count-up or count-down. Invalid if TPU(n+1) uses PCLK ÷ 1.

- TGRD input capture input selection

PDL_TPU_D_IC_TIOCD or PDL_TPU_D_IC_TIOCC	Input capture using pin TIOCDn or TIOCCn.
---	---

[data6]

The timer counter value.

[data7]

The register TGRA value.

[data8]

The register TGRB value.

[data9]

The register TGRC value (ignored for n ≠ 0, 3, 6 or 9).

[data10]

The register TGRD value (ignored for n ≠ 0, 3, 6 or 9).

[func1]

The function to be called when a TGRA event occurs. Specify PDL_NO_FUNC if not required.

[func2]

The function to be called when a TGRB event occurs. Specify PDL_NO_FUNC if not required.

[func3]

The function to be called when a TGRC event occurs. Specify PDL_NO_FUNC if not required.

[func4]

The function to be called when a TGRD event occurs. Specify PDL_NO_FUNC if not required.

[data11]

The interrupt priority level for TGRx events.

Select between 1 (lowest priority) and 15 (highest priority).

This parameter will be ignored if PDL_NO_FUNC is specified for all parameters func1, func2, func3 and func4.

[func5]

The function to be called when an overflow occurs. Specify PDL_NO_FUNC if not required.

[func6]

The function to be called when an underflow occurs. Specify PDL_NO_FUNC if not required.

Description (6/6)	[data12] The interrupt priority level for overflow or underflow events. Select between 1 (lowest priority) and 15 (highest priority). This parameter will be ignored if PDL_NO_FUNC is specified for both parameters func5 and func6.
Return value	True if all parameters are valid and exclusive; otherwise false.
Category	Timer Pulse Unit
Reference	R_TPU_Set, R_TPU_Destroy, R_TPU_ControlChannel, R_TPU_ControlUnit
Remarks	<ul style="list-style-type: none"> • If a callback function is specified, this function will enable the relevant CPU interrupt. Please see the notes on callback function usage in §6. • A callback function is executed by the interrupt processing function. This means that no other interrupt can be processed until the callback function has completed. • If the channel is configured for phase counting mode, the counter clock source setting is ignored. For more details of the phase counting mode, please refer to the RX63N hardware manual 24.3.6. • If buffer operation is selected for registers TGRA and TGRC, input capture / output compare is not valid for register TGRC. • If buffer operation is selected for registers TGRB and TGRD, input capture / output compare is not valid for register TGRD. • If synchronous mode is required, at least two channels must be enabled for synchronous operation. • Calling this function, TPU will start automatically. • Channels 6 to 11 are not available for device packages with 100 or fewer pins.

Program example

```

/* RPDFL definitions */
#include "r_pdl_tpu.h"

/* RPDFL device-specific definitions */
#include "r_pdl_definitions.h"

void TPU0_1V_callback(void);

void func(void)
{
    /* Configure TPU0: PCLK, clear after a compare match A */
    R_TPU_Create(
        0,
        PDL_TPU_MODE_NORMAL,
        PDL_TPU_CLK_PCLK_DIV_1 | PDL_TPU_CLEAR_CM_A,
        PDL_NO_DATA,
        PDL_NO_DATA,
        199,
        99,
        55,
        66,
        88,
        PDL_NO_FUNC,
        PDL_NO_FUNC,
        PDL_NO_FUNC,
        PDL_NO_FUNC,
        0,
        TPU0_1V_callback,
        PDL_NO_FUNC,
        0
    );
}

```

3) R_TPU_Destroy**Synopsis**

Disable a timer unit.

Prototype

```
bool R_TPU_Destroy(
    uint8_t data // Unit selection
);
```

Description

Shut down a timer pulse unit

[data]

The timer pulse unit n (where n = 0 or 1).
Unit 0 comprises channels TPU0 to TPU5.
Unit 1 comprises channels TPU6 to TPU11.

Return value

True if the unit selection is valid; otherwise false.

Category

Timer Pulse Unit

Reference

R_TPU_Create

Remarks

- The timer pulse unit is put into the stop state to reduce power consumption.
- Unit 1 is not available for device packages with 100 or fewer pins.

Program example

```
#include "r_pdl_tpu.h"

void func(void)
{
    /* Shutdown TPU unit 0 (channels 0 to 5) */
    R_TPU_Destroy(
        0
    );
}
```

4) R_TPU_ControlChannel

Synopsis

Control a timer channel.

Prototype

```
bool R_TPU_ControlChannel(
    uint8_t data1, // Channel selection
    uint8_t data2, // Register selection
    uint16_t data3, // Register value
    uint16_t data4, // Register value
    uint16_t data5, // Register value
    uint16_t data6, // Register value
    uint16_t data7 // Register value
);
```

Description

Modify a timer channel's registers.

[data1]
The channel number n (where n = 0 to 11).

[data2]
The channel settings to be modified.
If multiple selections are required, use “|” to separate each selection.

- Counter stop / re-start

PDL_TPU_STOP or PDL_TPU_START	Disable or re-enable the counter clock source.
-------------------------------	--

- The registers to be modified.

PDL_TPU_COUNTER	Update the timer counter register (TCNT).
PDL_TPU_TGRA	Update the general register A (TGRA).
PDL_TPU_TGRB	Update the general register A (TGRB).
PDL_TPU_TGRC	Update the general register A (TGRC). (Only supported for n = 0, 3, 6 or 9.)
PDL_TPU_TGRD	Update the general register A (TGRD). (Only supported for n = 0, 3, 6 or 9.)

[data3]
The counter value. This will be ignored if the register is not selected.

[data4]
The general register A value. This will be ignored if the register is not selected.

[data5]
The general register B value. This will be ignored if the register is not selected.

[data6]
The general register C value. This will be ignored if the register is not selected.

[data7]
The general register D value. This will be ignored if the register is not selected.

Return value

True if all parameters are valid and exclusive; otherwise false.

Category

Timer Pulse Unit

Reference

R_TPU_Set, R_TPU_Create, R_TPU_ControlUnit

Remarks

- Channels 6 to 11 are not available for device packages with 100 or fewer pins.
- The Stop operation is executed at the start of this function. The Start operation is executed at the end. Therefore, both options can be selected together with other changes in one function call.

Program example

```
/* RPDL definitions */
#include "r_pdl_tpu.h"

/* RPDL device-specific definitions */
#include "r_pdl_definitions.h"

void func(void)
{
    /* Load the counter on channel TPU channel 0 */
    R_TPU_ControlChannel(
        0,
        PDL_TPU_COUNTER,
        0xFFDD,
        0,
        0,
        0,
        0
    );
}
```

5) R_TPU_ControlUnit

Synopsis

Control a timer unit.

Prototype

```
bool R_TPU_ControlUnit(
    uint8_t data1, // Unit selection
    uint16_t data2 // Simultaneous control
);
```

Description

Simultaneous start/stop specified channels.

[data1]

The unit number n (where n = 0, 1).

[data2]

Simultaneous stop / start control. All selections are optional.

If multiple selections are required, use "|" to separate each selection.

- Counter stop/start control for unit 0

PDL_TPU_STOP_CH_0 or PDL_TPU_START_CH_0	Stop or start the count operation for the selected channels 0.
PDL_TPU_STOP_CH_1 or PDL_TPU_START_CH_1	Stop or start the count operation for the selected channels 1.
PDL_TPU_STOP_CH_2 or PDL_TPU_START_CH_2	Stop or start the count operation for the selected channels 2.
PDL_TPU_STOP_CH_3 or PDL_TPU_START_CH_3	Stop or start the count operation for the selected channels 3.
PDL_TPU_STOP_CH_4 or PDL_TPU_START_CH_4	Stop or start the count operation for the selected channels 4.
PDL_TPU_STOP_CH_5 or PDL_TPU_START_CH_5	Stop or start the count operation for the selected channels 5.

- Counter stop/start control for unit 1

PDL_TPU_STOP_CH_6 or PDL_TPU_START_CH_6	Stop or start the count operation for the selected channels 6.
PDL_TPU_STOP_CH_7 or PDL_TPU_START_CH_7	Stop or start the count operation for the selected channels 7.
PDL_TPU_STOP_CH_8 or PDL_TPU_START_CH_8	Stop or start the count operation for the selected channels 8.
PDL_TPU_STOP_CH_9 or PDL_TPU_START_CH_9	Stop or start the count operation for the selected channels 9.
PDL_TPU_STOP_CH_10 or PDL_TPU_START_CH_10	Stop or start the count operation for the selected channels 10.
PDL_TPU_STOP_CH_11 or PDL_TPU_START_CH_11	Stop or start the count operation for the selected channels 11.

Return value

True if all parameters are valid and exclusive; otherwise false.

Category

Timer Pulse Unit

Reference

R_TPU_Set, R_TPU_Create, R_TPU_ControlUnit

Remarks

- Channels 6 to11 are not available for device packages with 100 or fewer pins.

Program example

```
/* RPDL definitions */
#include "r_pdl_tpu.h"

/* RPDL device-specific definitions */
#include "r_pdl_definitions.h"

void func(void)
{
    /* Enable the counter on TPU channel 0, 4 */
    /* Disable the counter on TPU channel 1, 5 */
    R_TPU_ControlUnit(
        0,
        PDL_TPU_START_CH_0 | PDL_TPU_START_CH_4 | \
        PDL_TPU_STOP_CH_1 | PDL_TPU_STOP_CH_5
    );
}
```

6) R_TPU_Read

Synopsis

Read from timer channel registers.

Prototype

```
bool R_TPU_Read(
    uint8_t data1, // Channel selection
    uint8_t * data2, // A pointer to the data storage location
    uint16_t * data3, // A pointer to the data storage location
    uint16_t * data4, // A pointer to the data storage location
    uint16_t * data5, // A pointer to the data storage location
    uint16_t * data6, // A pointer to the data storage location
    uint16_t * data7 // A pointer to the data storage location
);
```

Description

Read any of the timer's counter, compare or status flag registers.

[data1]

The channel number n (where n = 0 to 11).

[data2]

The status flags shall be stored in the format below.

The input capture / compare match flags A to D will be set to 1 if the condition has been detected. Specify PDL_NO_PTR if the flags are not to be read.

For n = 0, 3, 6 or 9

b7	b6	b5	b4	b3	b2	b1	b0
0	0	Overflow detection	Input capture / compare match detection			0	
		V	D	C	B	A	

For n = 1, 2, 4, 5, 7, 8, 10 or 11

b7	b6	b5	b4	b3	b2	b1	b0
0	Underflow detection	Overflow detection	Input capture / compare match detection			Count direction	
	U	V	0	0	B	A	0 = Counter counts down 1 = Counter counts up

[data3]

A pointer to where the counter value shall be stored. Specify PDL_NO_PTR if it is not required.

[data4]

Where the general register A value shall be stored. Specify PDL_NO_PTR if it is not required.

[data5]

Where the general register B value shall be stored. Specify PDL_NO_PTR if it is not required.

[data6]

Where the general register C value shall be stored. Specify PDL_NO_PTR if it is not required.

[data7]

Where the general register D value shall be stored. Specify PDL_NO_PTR if it is not required.

Return value

True if all parameters are valid and exclusive; otherwise false.

Category

Timer Pulse Unit

Reference

None

Remarks

- If the flags are read, any detection flag that has been set to 1 shall be automatically cleared to 0 by this function.
- Channels 6 to 11 are not available for device packages with 100 or fewer pins.

Program example

```
/* RPDL definitions */
#include "r_pdl_tpu.h"

/* RPDL device-specific definitions */
#include "r_pdl_definitions.h"

uint8_t Flags;
uint16_t General_A;
uint16_t General_D;

void func(void)
{
    /* Read the status flags and registers A and D for channel TPU0 */
    R_TPU_Read(
        0,
        &Flags,
        PDL_NO_PTR,
        &General_A,
        PDL_NO_PTR,
        PDL_NO_PTR,
        &General_D
    );
}
```

4.2.17. Programmable Pulse Generator

1) R_PPG_Create

Synopsis Configure a PPG group.

Prototype

```
bool R_PPG_Create(
    uint32_t data1, // Output pin selection
    uint16_t data2, // Configuration selection
    uint8_t data3   // Output values
);
```

Description (1/2) Set up a 4-bit PPG group.

[data1]
 Select the outputs to be enabled.
 If multiple selections are required, use “|” to separate each selection.
 Select only outputs within one group.

PDL_PPG_PO0_PIN_P20	Group 0	Unit 0	
PDL_PPG_PO1_PIN_P21			
PDL_PPG_PO2_PIN_P22			
PDL_PPG_PO3_PIN_P23	Group 1		
PDL_PPG_PO4_PIN_P24			
PDL_PPG_PO5_PIN_P25			
PDL_PPG_PO6_PIN_P26	Group 2		
PDL_PPG_PO7_PIN_P27			
PDL_PPG_PO8_PIN_P30			
PDL_PPG_PO9_PIN_P31			
PDL_PPG_PO10_PIN_P32	Group 3		
PDL_PPG_PO11_PIN_P33			
PDL_PPG_PO12_PIN_P34			
PDL_PPG_PO13_PIN_P13 or PDL_PPG_PO13_PIN_P15			
PDL_PPG_PO14_PIN_P16			
PDL_PPG_PO15_PIN_P14 or PDL_PPG_PO15_PIN_P17	Group 4	Unit 1	
PDL_PPG_PO16_PIN_P73 or PDL_PPG_PO16_PIN_PA0			
PDL_PPG_PO17_PIN_PA1 or PDL_PPG_PO17_PIN_PC0			
PDL_PPG_PO18_PIN_PA2 or PDL_PPG_PO18_PIN_PC1 or PDL_PPG_PO18_PIN_PE1			
PDL_PPG_PO19_PIN_P74 or PDL_PPG_PO19_PIN_PA3			
PDL_PPG_PO20_PIN_P75 or PDL_PPG_PO20_PIN_PA4			Group 5
PDL_PPG_PO21_PIN_PA5 or PDL_PPG_PO21_PIN_PC2			
PDL_PPG_PO22_PIN_P76 or PDL_PPG_PO22_PIN_PA6			
PDL_PPG_PO23_PIN_P77 or PDL_PPG_PO23_PIN_PA7 or PDL_PPG_PO23_PIN_PE2			

Description (2/2)		
PDL_PPG_PO24_PIN_PB0 or PDL_PPG_PO24_PIN_PC3	Group 6	Unit 1
PDL_PPG_PO25_PIN_PB1 or PDL_PPG_PO25_PIN_PC4		
PDL_PPG_PO26_PIN_PB0 or PDL_PPG_PO26_PIN_PB2 or PDL_PPG_PO26_PIN_PE3		
PDL_PPG_PO27_PIN_PB1 or PDL_PPG_PO27_PIN_PB3		
PDL_PPG_PO28_PIN_PB2 or PDL_PPG_PO28_PIN_PB4 or PDL_PPG_PO28_PIN_PE4	Group 7	
PDL_PPG_PO29_PIN_PB5 or PDL_PPG_PO29_PIN_PC5		
PDL_PPG_PO30_PIN_PB6 or PDL_PPG_PO30_PIN_PC6		
PDL_PPG_PO31_PIN_PB7 or PDL_PPG_PO31_PIN_PC7		

[data2]

Operation control

If multiple selections are required, use “|” to separate each selection.

- Output trigger selection

PDL_PPG_TRIGGER_MTU0 or PDL_PPG_TRIGGER_MTU1 or PDL_PPG_TRIGGER_MTU2 or PDL_PPG_TRIGGER_MTU3 or	Select Compare Match on MTU channel 0 to 3 as the output trigger.
PDL_PPG_TRIGGER_TPU0 or PDL_PPG_TRIGGER_TPU1 or PDL_PPG_TRIGGER_TPU2 or PDL_PPG_TRIGGER_TPU3	Select Compare Match on TPU channel 0 to 3 as the output trigger (valid only for groups 4 to 7).

- Non-overlap control

PDL_PPG_NORMAL or PDL_PPG_NON_OVERLAP	Select overlapping (Compare Match A) or non-overlapping (Compare Match A or B) operation.
---	---

- Invert control

PDL_PPG_DIRECT or PDL_PPG_INVERT	Select direct or inverted output.
--	-----------------------------------

[data3]

The initial and next output values for the enabled pins, using the following format.

Group	b7 b6 b5 b4				b3 b2 b1 b0			
	Next pulse output values				Initial output values			
0	PO3	PO2	PO1	PO0	PO3	PO2	PO1	PO0
1	PO7	PO6	PO5	PO4	PO7	PO6	PO5	PO4
2	PO11	PO10	PO9	PO8	PO11	PO10	PO9	PO8
3	PO15	PO14	PO13	PO12	PO15	PO14	PO13	PO12
4	PO19	PO18	PO17	PO16	PO19	PO18	PO17	PO16
5	PO23	PO22	PO21	PO20	PO23	PO22	PO21	PO20
6	PO27	PO26	PO25	PO24	PO27	PO26	PO25	PO24
7	PO31	PO30	PO29	PO28	PO31	PO30	PO29	PO28

Return value

True if all parameters are valid and exclusive; otherwise false.

Category

Programmable Pulse Generator

Reference

None.

Remarks

- If more than one group must be configured, use multiple calls of this function.
- The applicable PPG unit 0 or 1 is brought out of the stop state.
- If both Group 0 and Group 1, Group 2 and Group 3, Group 4 and Group 5, or Group 6 and Group 7 need to be configured, odd group must be configured before even group.
- This function disables the alternative modes on each PO pin that is enabled.

Program example

```
#include "r_pdl_ppg.h"

/* RPD_L device-specific definitions */
#include "r_pdl_definitions.h"

void func(void)
{
    /* Configure PPG outputs PO4 and PO6 (group 1) */
    R_PPG_Create(
        PDL_PPG_PO4_PIN_P24 | PDL_PPG_PO6_PIN_P26,
        PDL_PPG_TRIGGER_MTU2,
        0x15
    );
}
```

2) R_PPG_Destroy

Synopsis

Disable PPG outputs.

Prototype

```
bool R_PPG_Destroy(
    uint32_t data // Output pin selection
);
```

Description (1/2)

Disable the pulse output on the selected pins.

[data]

Select the outputs to be disabled.

If multiple selections are required, use “|” to separate each selection.

Select only outputs within one group.

PDL_PPG_PO0_PIN_P20	Group 0	Unit 0
PDL_PPG_PO1_PIN_P21		
PDL_PPG_PO2_PIN_P22		
PDL_PPG_PO3_PIN_P23	Group 1	
PDL_PPG_PO4_PIN_P24		
PDL_PPG_PO5_PIN_P25		
PDL_PPG_PO6_PIN_P26	Group 2	
PDL_PPG_PO7_PIN_P27		
PDL_PPG_PO8_PIN_P30		
PDL_PPG_PO9_PIN_P31	Group 3	
PDL_PPG_PO10_PIN_P32		
PDL_PPG_PO11_PIN_P33		
PDL_PPG_PO12_PIN_P34	Group 3	
PDL_PPG_PO13_PIN_P13 or PDL_PPG_PO13_PIN_P15		
PDL_PPG_PO14_PIN_P16		
PDL_PPG_PO15_PIN_P14 or PDL_PPG_PO15_PIN_P17	Group 4	
PDL_PPG_PO16_PIN_P73 or PDL_PPG_PO16_PIN_PA0		
PDL_PPG_PO17_PIN_PA1 or PDL_PPG_PO17_PIN_PC0		
PDL_PPG_PO18_PIN_PA2 or PDL_PPG_PO18_PIN_PC1 or PDL_PPG_PO18_PIN_PE1	Group 4	
PDL_PPG_PO19_PIN_P74 or PDL_PPG_PO19_PIN_PA3		
PDL_PPG_PO20_PIN_P75 or PDL_PPG_PO20_PIN_PA4		
PDL_PPG_PO21_PIN_PA5 or PDL_PPG_PO21_PIN_PC2	Group 5	
PDL_PPG_PO22_PIN_P76 or PDL_PPG_PO22_PIN_PA6		
PDL_PPG_PO23_PIN_P77 or PDL_PPG_PO23_PIN_PA7 or PDL_PPG_PO23_PIN_PE2		
PDL_PPG_PO24_PIN_PB0 or PDL_PPG_PO24_PIN_PC3	Group 6	
PDL_PPG_PO25_PIN_PB1 or PDL_PPG_PO25_PIN_PC4		
PDL_PPG_PO26_PIN_P80 or PDL_PPG_PO26_PIN_PB2 or PDL_PPG_PO26_PIN_PE3		
PDL_PPG_PO27_PIN_P81 or PDL_PPG_PO27_PIN_PB3	Group 6	Unit 1

Description (2/2)	PDL_PPG_PO28_PIN_PB2 or PDL_PPG_PO28_PIN_PB4 or PDL_PPG_PO28_PIN_PE4	Group 7	Unit 1
	PDL_PPG_PO29_PIN_PB5 or PDL_PPG_PO29_PIN_PC5		
	PDL_PPG_PO30_PIN_PB6 or PDL_PPG_PO30_PIN_PC6		
	PDL_PPG_PO31_PIN_PB7 or PDL_PPG_PO31_PIN_PC7		

Return value	True if the unit selection is valid; otherwise false.
Category	Programmable Pulse Generator
Reference	R_PPG_Create
Remarks	<ul style="list-style-type: none"> If all the outputs in a unit become disabled, that unit will be put into the stop state to reduce power consumption.

Program example

```
#include "r_pdl_ppg.h"

/* RPD_L device-specific definitions */
#include "r_pdl_definitions.h"

void func(void)
{
    /* Disable outputs PO24 and PO26 */
    R_PPG_Destroy(
        PDL_PPG_PO24_PIN_PB0 | PDL_PPG_PO26_PIN_PE3
    );
}
```

3) R_PPG_Control

Synopsis Control a PPG group.

Prototype

```
bool R_PPG_Control(
    uint32_t data1, // Group selection
    uint8_t data2   // Next output values
);
```

Description Set the next output for a PPG group.

[data1]
 Select the group(s) to be modified.
 If multiple selections are required, use “|” to separate each selection.

- Group selection

PDL_PPG_GROUP_0 or PDL_PPG_GROUP_1 or PDL_PPG_GROUP_2 or PDL_PPG_GROUP_3 or PDL_PPG_GROUP_4 or PDL_PPG_GROUP_5 or PDL_PPG_GROUP_6 or PDL_PPG_GROUP_7	If a pair of groups (0-1, 2-3, 4-5 or 6-7) is using the same output trigger, both groups may be selected.
---	---

[data2]
 The next output values (either for a single group, or a pair of groups), using the format:

Group pair	Group 1, 3, 5 or 7				Group 0, 2, 4 or 6			
	b7	b6	b5	b4	b3	b2	b1	b0
1 & 0	PO7	PO6	PO5	PO4	PO3	PO2	PO1	PO0
3 & 2	PO15	PO14	PO13	PO12	PO11	PO10	PO9	PO8
5 & 4	PO23	PO22	PO21	PO20	PO19	PO18	PO17	PO16
7 & 6	PO31	PO30	PO29	PO28	PO27	PO26	PO25	PO24

Return value True if all parameters are valid and exclusive; otherwise false.

Category Programmable Pulse Generator

Reference R_PPG_Create

Remarks • None.

Program example

```
/* RPDL definitions */
#include "r_pdl_ppg.h"

/* RPDL device-specific definitions */
#include "r_pdl_definitions.h"

void func(void)
{
    /* Load the next output values on group 6 */
    R_PPG_Control(
        PDL_PPG_GROUP_6,
        0x07
    );
}
```

4.2.18. 8-bit Timer

1) R_TMR_Set

Synopsis

Configure the optional TMR pins.

Prototype

```
bool R_TMR_Set(
    uint8_t data1,    // Channel selection
    uint32_t data2    // Pin configuration
);
```

Description

Set up the global TMR options.

[data1]

The channel number n (where n = 0, 1, 2 or 3).

[data2]

Configure the TMR input and output pins for the channel. Use “|” to separate each selection.

- Valid when n = 0

PDL_TMR_TMR0_TMO0_P22 or PDL_TMR_TMR0_TMO0_PB3	Select the pins for TMO0
PDL_TMR_TMR0_TMC10_P01 or PDL_TMR_TMR0_TMC10_P21 or PDL_TMR_TMR0_TMC10_PB1	Select the pins for TMC10
PDL_TMR_TMR0_TMR10_P00 or PDL_TMR_TMR0_TMR10_P20 or PDL_TMR_TMR0_TMR10_PA4	Select the pins for TMR10

- Valid when n = 1

PDL_TMR_TMR1_TMO1_P17 or PDL_TMR_TMR1_TMO1_P26	Select the pins for TMO1
PDL_TMR_TMR1_TMC11_P02 or PDL_TMR_TMR1_TMC11_P12 or PDL_TMR_TMR1_TMC11_P54 or PDL_TMR_TMR1_TMC11_PC4	Select the pins for TMC11
PDL_TMR_TMR1_TMR11_P24 or PDL_TMR_TMR1_TMR11_PB5	Select the pins for TMR11

- Valid when n = 2

PDL_TMR_TMR2_TMO2_P16 or PDL_TMR_TMR2_TMO2_PC7	Select the pins for TMO2
PDL_TMR_TMR2_TMC12_P15 or PDL_TMR_TMR2_TMC12_P31 or PDL_TMR_TMR2_TMC12_PC6	Select the pins for TMC12
PDL_TMR_TMR2_TMR12_P14 or PDL_TMR_TMR2_TMR12_PC5	Select the pins for TMR12

- Valid when n = 3

PDL_TMR_TMR3_TMO3_P13 or PDL_TMR_TMR3_TMO3_P32 or PDL_TMR_TMR3_TMO3_P55	Select the pins for TMO3
PDL_TMR_TMR3_TMC13_P11 or PDL_TMR_TMR3_TMC13_P27 or PDL_TMR_TMR3_TMC13_P34 or PDL_TMR_TMR3_TMC13_PA6	Select the pins for TMC13
PDL_TMR_TMR3_TMR13_P10 or PDL_TMR_TMR3_TMR13_P30 or PDL_TMR_TMR3_TMR13_P33	Select the pins for TMR13

Return value

True if all parameters are valid and exclusive; otherwise false.

Category

Timer TMR

Reference

R_TMR_CreateChannel, R_TMR_CreateUnit

Remarks

- Before calling any R_TMR_Create function, call this function to configure the relevant pins.
- Call this function multiple times, if more than one channel is to be configured.
- Pins which are not used for the TMR functions may be omitted.

Program example

```
#include "r_pdl_tmr.h"

/* RPDL device-specific definitions */
#include "r_pdl_definitions.h"

void func(void)
{
    /* Configure the applicable TMR pins */
    R_TMR_Set(
        0,
        PDL_TMR_TMR0_TMO0_PB3 | PDL_TMR_TMR0_TMC10_PB1 | \
        PDL_TMR_TMR0_TMR10_PA4
    );
}
```

2) R_TMR_CreateChannel

Synopsis

Configure a timer TMR channel.

Prototype

```
bool R_TMR_CreateChannel(
    uint8_t data1, // Channel selection
    uint32_t data2, // Configuration selection
    uint8_t data3, // Configuration selection
    uint8_t data4, // Register value
    uint8_t data5, // Register value
    uint8_t data6, // Register value
    void * func1, // Callback function
    void * func2, // Callback function
    void * func3, // Callback function
    uint8_t data7 // Interrupt priority level
);
```

Description (1/2)

Set up an 8-bit timer TMR channel.

[data1]
The channel number n (where n = 0, 1, 2 or 3).

[data2]
Configure the channel. If multiple selections are required, use “|” to separate each selection. The default settings are shown in **bold**. Specify PDL_NO_DATA to use the defaults.

- Counter clock source selection

PDL_TMR_CLK_OFF or	The clock input is disabled.
PDL_TMR_CLK_EXT_RISING or PDL_TMR_CLK_EXT_FALLING or PDL_TMR_CLK_EXT_BOTH or	The external clock signal TMCIn is used. Select rising, falling or both edges detected.
PDL_TMR_CLK_PCLK_DIV_1 or PDL_TMR_CLK_PCLK_DIV_2 or PDL_TMR_CLK_PCLK_DIV_8 or PDL_TMR_CLK_PCLK_DIV_32 or PDL_TMR_CLK_PCLK_DIV_64 or PDL_TMR_CLK_PCLK_DIV_1024 or PDL_TMR_CLK_PCLK_DIV_8192 or	The internal clock signal PCLKB ÷ 1, 2, 8, 32, 64, 1024 or 8192.
PDL_TMR_CLK_TMR1_OVERFLOW or PDL_TMR_CLK_TMR3_OVERFLOW or	The overflow signal from TMR(n+1). Valid for n = 0 or 2.
PDL_TMR_CLK_TMR0_CM_A or PDL_TMR_CLK_TMR2_CM_A	The compare match A signal from TMR(n-1). Valid for n = 1 or 3.

- Counter clearing

PDL_TMR_CLEAR_DISABLE or	Clearing is disabled.
PDL_TMR_CLEAR_CM_A or	Cleared after a compare match A occurs.
PDL_TMR_CLEAR_CM_B or	Cleared after a compare match B occurs.
PDL_TMR_CLEAR_RESET_RISING or	Cleared by a rising edge on the external reset pin TMRIn.
PDL_TMR_CLEAR_RESET_HIGH	Cleared when the external reset pin TMRIn is high.

- ADC trigger control

PDL_TMR_ADC_TRIGGER_DISABLE or PDL_TMR_ADC_TRIGGER_ENABLE	Disable or enable ADC conversion start requests on a compare match A signal. Only applicable for channels TMR0 or TMR2.
---	--

- Compare Match A DTC trigger control

PDL_TMR_CM_A_DTC_TRIGGER_DISABLE or PDL_TMR_CM_A_DTC_TRIGGER_ENABLE	Disable or enable activation of the DTC when a Compare Match A occurs.
---	--

- Compare Match B DTC trigger control

PDL_TMR_CM_B_DTC_TRIGGER_DISABLE or PDL_TMR_CM_B_DTC_TRIGGER_ENABLE	Disable or enable activation of the DTC when a Compare Match B occurs.
---	--

Description (2/2)	<p>[data3] Configure the output control. If multiple selections are required, use “ ” to separate each selection. The default settings are shown in bold. Specify PDL_NO_DATA to use the defaults.</p> <ul style="list-style-type: none"> Output control for pin TMO_n <table border="1" style="width: 100%; border-collapse: collapse;"> <tr> <td style="width: 50%; padding: 2px;"> PDL_TMR_OUTPUT_IGNORE_CM_A or PDL_TMR_OUTPUT_LOW_CM_A or PDL_TMR_OUTPUT_HIGH_CM_A or PDL_TMR_OUTPUT_INV_CM_A </td> <td style="width: 50%; padding: 2px;"> No change if a compare match A occurs. 0 is output if a compare match A occurs. 1 is output if a compare match A occurs. The output toggles if a compare match A occurs. </td> </tr> <tr> <td style="width: 50%; padding: 2px;"> PDL_TMR_OUTPUT_IGNORE_CM_B or PDL_TMR_OUTPUT_LOW_CM_B or PDL_TMR_OUTPUT_HIGH_CM_B or PDL_TMR_OUTPUT_INV_CM_B </td> <td style="width: 50%; padding: 2px;"> No change if a compare match B occurs. 0 is output if a compare match B occurs. 1 is output if a compare match B occurs. The output toggles if a compare match B occurs. </td> </tr> </table>	PDL_TMR_OUTPUT_IGNORE_CM_A or PDL_TMR_OUTPUT_LOW_CM_A or PDL_TMR_OUTPUT_HIGH_CM_A or PDL_TMR_OUTPUT_INV_CM_A	No change if a compare match A occurs. 0 is output if a compare match A occurs. 1 is output if a compare match A occurs. The output toggles if a compare match A occurs.	PDL_TMR_OUTPUT_IGNORE_CM_B or PDL_TMR_OUTPUT_LOW_CM_B or PDL_TMR_OUTPUT_HIGH_CM_B or PDL_TMR_OUTPUT_INV_CM_B	No change if a compare match B occurs. 0 is output if a compare match B occurs. 1 is output if a compare match B occurs. The output toggles if a compare match B occurs.
PDL_TMR_OUTPUT_IGNORE_CM_A or PDL_TMR_OUTPUT_LOW_CM_A or PDL_TMR_OUTPUT_HIGH_CM_A or PDL_TMR_OUTPUT_INV_CM_A	No change if a compare match A occurs. 0 is output if a compare match A occurs. 1 is output if a compare match A occurs. The output toggles if a compare match A occurs.				
PDL_TMR_OUTPUT_IGNORE_CM_B or PDL_TMR_OUTPUT_LOW_CM_B or PDL_TMR_OUTPUT_HIGH_CM_B or PDL_TMR_OUTPUT_INV_CM_B	No change if a compare match B occurs. 0 is output if a compare match B occurs. 1 is output if a compare match B occurs. The output toggles if a compare match B occurs.				
	<p>[data4] The counter value.</p>				
	<p>[data5] The compare match A value.</p>				
	<p>[data6] The compare match B value.</p>				
	<p>[func1] The function to be called when an overflow occurs. Use PDL_NO_FUNC if not required.</p>				
	<p>[func2] The function to be called when a Compare match A occurs. Use PDL_NO_FUNC if not required.</p>				
	<p>[func3] The function to be called when a Compare match B occurs. Use PDL_NO_FUNC if not required.</p>				
	<p>[data7] The interrupt priority level. Select between 1 (lowest priority) and 15 (highest priority). This parameter will be ignored if PDL_NO_FUNC is specified for all parameters func1, func2 and func3.</p>				
Return value	True if all parameters are valid and exclusive; otherwise false.				
Category	Timer TMR				
Reference	R_TMR_Set				
Remarks	<ul style="list-style-type: none"> Please use R_TMR_Set to select the input (TMCIn, TMRIn) and output (TMO_n) pins as required. This function will return false if a pin is enabled but is not set properly. A closed clock loop will be created if: <ul style="list-style-type: none"> The overflow signal from TMR1 is selected for TMR0 and the compare match A signal from TMR0 is selected for TMR1, or The overflow signal from TMR3 is selected for TMR2 and the compare match A signal from TMR2 is selected for TMR3. Either case should be avoided. If a callback function is specified, this function will enable the relevant interrupt. Please see the notes on callback function usage in §6. A callback function is executed by the interrupt processing function. This means that no other interrupt can be processed until the callback function has completed. 				

Program example

```
/* RPDL definitions */
#include "r_pdl_tmr.h"

/* RPDL device-specific definitions */
#include "r_pdl_definitions.h"

void func(void)
{
    /* Configure TMR0: PCLKB, clear after a compare match A */
    R_TMR_CreateChannel(
        0,
        PDL_TMR_CLK_PCLK_DIV_1 | PDL_TMR_CLEAR_CM_A,
        PDL_NO_DATA,
        0,
        199,
        99,
        PDL_NO_FUNC,
        PDL_NO_FUNC,
        PDL_NO_FUNC,
        0
    );
}
```

3) R_TMR_CreateUnit

Synopsis

Configure a timer TMR unit.

Prototype

```
bool R_TMR_CreateUnit(
    uint8_t data1, // Unit selection
    uint32_t data2, // Configuration selection
    uint8_t data3, // Output control
    uint16_t data4, // Register value
    uint16_t data5, // Register value
    uint16_t data6, // Register value
    void * func1, // Callback function
    void * func2, // Callback function
    void * func3, // Callback function
    uint8_t data7 // Interrupt priority level
);
```

Description (1/2)

Set up a timer TMR unit in 16-bit count mode.

[data1]
The unit number n (where n = 0 or 1).

[data2]
Configure the unit. If multiple selections are required, use “|” to separate each selection. The default settings are shown in **bold**. Specify PDL_NO_DATA to use the defaults.

- Counter clock source selection

PDL_TMR_CLK_OFF or PDL_TMR_CLK_EXT_RISING or PDL_TMR_CLK_EXT_FALLING or PDL_TMR_CLK_EXT_BOTH or	The clock input is disabled. The external clock signal TMC1x (x = 1 or 3 for n = 0 or 1) is used, with rising, falling or both edges detected.
PDL_TMR_CLK_PCLK_DIV_1 or PDL_TMR_CLK_PCLK_DIV_2 or PDL_TMR_CLK_PCLK_DIV_8 or PDL_TMR_CLK_PCLK_DIV_32 or PDL_TMR_CLK_PCLK_DIV_64 or PDL_TMR_CLK_PCLK_DIV_1024 or PDL_TMR_CLK_PCLK_DIV_8192	The internal clock signal PCLKB ÷ 1, 2, 8, 32, 64, 1024 or 8192.

- Counter clearing

PDL_TMR_CLEAR_DISABLE or	Clearing is disabled.
PDL_TMR_CLEAR_CM_A or	Cleared after a compare match A occurs.
PDL_TMR_CLEAR_CM_B or	Cleared after a compare match B occurs.
PDL_TMR_CLEAR_RESET_RISING or	Cleared by a rising edge on the external reset pin TMRIn.
PDL_TMR_CLEAR_RESET_HIGH	Cleared when the external reset pin TMR1x (x = 0 or 2 for n = 0 or 1) is high.

- ADC trigger control

PDL_TMR_ADC_TRIGGER_DISABLE or PDL_TMR_ADC_TRIGGER_ENABLE	Disable or enable ADC conversion start requests on a compare match A signal.
---	--

- Compare Match A DTC trigger control

PDL_TMR_CM_A_DTC_TRIGGER_DISABLE or PDL_TMR_CM_A_DTC_TRIGGER_ENABLE	Disable or enable activation of the DTC when a Compare Match A occurs.
---	--

- Compare Match B DTC trigger control

PDL_TMR_CM_B_DTC_TRIGGER_DISABLE or PDL_TMR_CM_B_DTC_TRIGGER_ENABLE	Disable or enable activation of the DTC when a Compare Match B occurs.
---	--

Description (2/2)

[data3]

Configure the output control. If multiple selections are required, use “|” to separate each selection.
The default settings are shown in **bold**.

- Output control for pin TMO_y (y = 0 or 2 for n = 0 or 1)

PDL_TMR_OUTPUT_IGNORE_CM_A or PDL_TMR_OUTPUT_LOW_CM_A or PDL_TMR_OUTPUT_HIGH_CM_A or PDL_TMR_OUTPUT_INV_CM_A	No change if a compare match A occurs. 0 is output if a compare match A occurs. 1 is output if a compare match A occurs. The output toggles if a compare match A occurs.
PDL_TMR_OUTPUT_IGNORE_CM_B or PDL_TMR_OUTPUT_LOW_CM_B or PDL_TMR_OUTPUT_HIGH_CM_B or PDL_TMR_OUTPUT_INV_CM_B	No change if a compare match B occurs. 0 is output if a compare match B occurs. 1 is output if a compare match B occurs. The output toggles if a compare match B occurs.

[data4]

The 16-bit counter value.

[data5]

The 16-bit compare match A value.

[data6]

The 16-bit compare match B value.

[func1]

The function to be called when an overflow occurs.
Use PDL_NO_FUNC if not required.

[func2]

The function to be called when a Compare match A occurs.
Use PDL_NO_FUNC if not required.

[func3]

The function to be called when a Compare match B occurs.
Use PDL_NO_FUNC if not required.

[data7]

The interrupt priority level. Select between 1 (lowest priority) and 15 (highest priority).
This parameter will be ignored if PDL_NO_FUNC is specified for all parameters func1, func2 and func3.

Return value

True if all parameters are valid and exclusive; otherwise false.

Category

Timer TMR

Reference

R_TMR_Set

Remarks

- Please use R_TMR_Set to select the input (TMCIn, TMRIn) and output (TMO_n) pins as required. This function will return false if a pin is enabled but is not set properly.
- If a callback function is specified, this function will enable the relevant interrupt. Please see the notes on callback function usage in §6.
- A callback function is executed by the interrupt processing function. This means that no other interrupt can be processed until the callback function has completed.

Program example

```
#include "r_pdl_tmr.h"

/* RPDL device-specific definitions */
#include "r_pdl_definitions.h"

void func(void)
{
    /* Configure TMR unit 0: PCLKB, clear after a compare match A */
    R_TMR_CreateUnit(
        0,
        PDL_TMR_CLK_PCLK_DIV_1 | PDL_TMR_CLEAR_CM_A,
        0,
        0,
        199,
        99,
        PDL_NO_FUNC,
        PDL_NO_FUNC,
        PDL_NO_FUNC,
        0
    );
}
```

4) R_TMR_CreatePeriodic

Synopsis

Select periodic operation.

Prototype

```
bool R_TMR_CreatePeriodic(
    uint8_t data1, // 8-bit (channel) or 16-bit (unit) selection
    uint32_t data2, // Configuration selection
    double data3, // Period or frequency
    double data4, // Pulse width or duty cycle
    void * func1, // Callback function
    void * func2, // Callback function
    uint8_t data5 // Interrupt priority level
);
```

Description (1/2)

Set up a TMR timer channel or unit for periodic operation and start the timer.

[data1]

PDL_TMR_TMR0 or PDL_TMR_TMR1 or PDL_TMR_TMR2 or PDL_TMR_TMR3 or PDL_TMR_UNIT0 or PDL_TMR_UNIT1	The channel n (n = 0, 1, 2 or 3) or unit (n = 0 or 1) to be configured.
---	---

[data2]

Configure the timer. If multiple selections are required, use “|” to separate each selection. The default settings are shown in **bold**.

- Period or frequency calculation

PDL_TMR_PERIOD or PDL_TMR_FREQUENCY	The parameters data3 and data4 will contain either period and pulse width or frequency and duty cycle.
--	--

- Output pin control

PDL_TMR_OUTPUT_HIGH or PDL_TMR_OUTPUT_LOW or PDL_TMR_OUTPUT_OFF	Start with a high-level or low-level output, or no output on pin TMO _n . For 16-bit operation the pin shall be TMO2 when n = 1.
--	---

- ADC trigger control

PDL_TMR_ADC_TRIGGER_OFF or PDL_TMR_ADC_TRIGGER_ON	Disable or enable TMR-triggered ADC conversion start requests. Applicable only for channels TMR0 or TMR2, or either TMR unit.
---	--

- Pulse DTC trigger control

PDL_TMR_PULSE_DTC_TRIGGER_DISABLE or PDL_TMR_PULSE_DTC_TRIGGER_ENABLE	Disable or enable activation of the DTC at the pulse width interval.
---	--

- Period DTC trigger control

PDL_TMR_PERIOD_DTC_TRIGGER_DISABLE or PDL_TMR_PERIOD_DTC_TRIGGER_ENABLE	Disable or enable activation of the DTC at the periodic interval.
---	---

[data3]

The period (in seconds) or frequency (in Hz).

[data4]

The pulse width (in seconds) or duty cycle (%).

[func1]

The function to be called at the pulse width interval. Use PDL_NO_FUNC if not required.

[func2]

The function to be called at the periodic interval. Use PDL_NO_FUNC if not required.

Description (2/2)

[data5]

The interrupt priority level. Select between 1 (lowest priority) and 15 (highest priority). This parameter will be ignored if PDL_NO_FUNC is specified for both parameters func1 and func2.

Return value

True if all parameters are valid and exclusive; otherwise false.

Category

Timer TMR

Reference

R_CGC_Control, R_TMR_CreateChannel, R_TMR_CreateUnit

Remarks

- Function R_CGC_Set must be called (with the current clock source selected) before using this function.
- This function is an alternative to R_TMR_CreateChannel and R_TMR_CreateUnit.
- Please use R_TMR_Set to select the output (TMO_n) pin as required. This function will return false if a pin is enabled but is not set properly.
- If a callback function is specified, this function will enable the relevant interrupt. Please see the notes on callback function use in §6.
- The timing limits depend on the peripheral module clock, PCLKB.

	Equation	f _{PCLKB} (MHz)				
		50	48	12.5	12	8
Timer resolution	$\frac{1}{f_{PCLKB}}$	20ns	20.8ns	80ns	83.3ns	125ns
Period_{MIN}	$\frac{2}{f_{PCLKB}}$	40ns	41.7ns	160ns	166.7ns	250ns
Period_{MAX_CHANNEL}_L	$\frac{2^{21}}{f_{PCLKB}}$	41.9ms	43.7ms	167.7ms	174.8ms	262ms
Period_{MAX_UNIT}	$\frac{2^{29}}{f_{PCLKB}}$	10.7s	11.2s	42.9s	44.7s	67.1s
Width_{MIN}		Period _{MIN}				
Width_{MAX_CHANNEL}		Period _{MAX_CHANNEL}				
Width_{MAX_UNIT}		Period _{MAX_UNIT}				
f_{MAX}	$\frac{f_{PCLKB}}{2}$	25 MHz	24 MHz	6.25 MHz	6 MHz	4 MHz
f_{MIN_CHANNEL}	$\frac{f_{PCLKB}}{2^{21}}$	23.8 Hz	22.9 Hz	5.96 Hz	5.7 Hz	3.81 Hz
f_{MIN_UNIT}	$\frac{f_{PCLKB}}{2^{29}}$	0.0931 Hz	0.0894 Hz	0.0232 Hz	0.0224 Hz	0.0149 Hz

- If the requested period is not a multiple of the timer resolution, the actual time period will be more than the requested time period.
- The actual duty cycle will be less than the requested duty cycle if the resulting pulse width is not a multiple of the timer resolution.
- A callback function is executed by the interrupt processing function. This means that no other interrupt can be processed until the callback function has completed.

Program example

```
/* RPDL definitions */
#include "r_pdl_tmr.h"

/* RPDL device-specific definitions */
#include "r_pdl_definitions.h"

void func(void)
{
    /* Configure pin TMO1 for 500ns period, 200ns pulse width */
    R_TMR_CreatePeriodic(
        PDL_TMR_TMR1,
        PDL_TMR_PERIOD | PDL_TMR_OUTPUT_HIGH,
        500E-9,
        200E-9,
        PDL_NO_FUNC,
        PDL_NO_FUNC,
        0
    );

    /* Configure pin TMO1 for 5MHz frequency, 60% duty cycle */
    R_TMR_CreatePeriodic(
        PDL_TMR_TMR1,
        PDL_TMR_FREQUENCY | PDL_TMR_OUTPUT_HIGH,
        5E6,
        60,
        PDL_NO_FUNC,
        PDL_NO_FUNC,
        0
    );
}
```

5) R_TMR_CreateOneShot

Synopsis Configure and use a one-shot timer.

Prototype

```
bool R_TMR_CreateOneShot(
    uint8_t data1, // 8-bit (channel) or 16-bit (unit) timer selection
    uint32_t data2, // Configuration selection
    double data3, // Period
    void * func, // Callback function
    uint8_t data4 // Interrupt priority level
);
```

Description Set up a TMR timer channel or unit for one-shot operation and start the timer.

[data1]

PDL_TMR_TMR0 or PDL_TMR_TMR1 or PDL_TMR_TMR2 or PDL_TMR_TMR3 or PDL_TMR_UNIT0 or PDL_TMR_UNIT1	The channel n (n = 0, 1, 2 or 3) or unit n (n = 0 or 1) to be configured.
---	---

[data2]
Configure the timer. Use “|” to separate each selection. The default settings are shown in **bold**. Specify PDL_NO_DATA to use the defaults.

- Output pin control

PDL_TMR_OUTPUT_HIGH or PDL_TMR_OUTPUT_LOW or PDL_TMR_OUTPUT_OFF	For the duration of the one-shot period, generate a high-level output, low-level output or no output on pin TMO _n . For 16-bit operation the pin shall be TMO2 when n = 1.
--	--

- DTC trigger control

PDL_TMR_PULSE_DTC_TRIGGER_DISABLE or PDL_TMR_PULSE_DTC_TRIGGER_ENABLE	Disable or enable activation of the DTC when the one-shot period ends.
---	--

- Control the CPU during the one-shot operation.

PDL_TMR_CPU_ON or PDL_TMR_CPU_OFF	Allow the CPU to run normally while the one-shot operates. Stop the CPU when the one-shot timer starts. The CPU will re-start when any valid interrupt occurs.
---	---

[data3]
The one-shot time period (in seconds).

[func]
The function to be called when the one-shot period ends. Specify PDL_NO_FUNC for this function to wait for the timer to complete before returning. You should always specify a function if PDL_TMR_CPU_OFF is selected, to ensure that an interrupt will re-start the CPU.

[data4]
The interrupt priority level. Select between 1 (lowest priority) and 15 (highest priority). This parameter will be ignored if PDL_NO_FUNC is specified for parameter func.

Return value True if all parameters are valid and exclusive; otherwise false.

Category Timer TMR

Reference R_CGC_Control, R_TMR_CreateChannel, R_TMR_CreateUnit

Remarks

- Function R_CGC_Set must be called (with the current clock source selected) before using this function.
- This function is an alternative to R_TMR_CreateChannel and R_TMR_CreateUnit.
- Please use R_TMR_Set to select the output (TMO_n) pin as required. This function will return false if a pin is enabled but is not set properly.
- This function stops the timer on completion, so no other TMR function calls are required.
- If a callback function is specified, this function will enable the relevant interrupt. Please see the notes on callback function usage in §6.
- If no callback function is specified, this function waits for the CMIB flag to indicate that the one-shot time delay is complete. If the timer's control registers are directly modified by the user, this function may lock up.
- A callback function is executed by the interrupt processing function. This means that no other interrupt can be processed until the callback function has completed.
- The timer period limits depend on the peripheral module clock, PCLKB.

	Equation	f _{PCLKB} (MHz)				
		50	48	12.5	12	8
T _{MIN}	$\frac{1}{f_{PCLKB}}$	20ns	20.83ns	80ns	83.3ns	125ns
T _{MAX_CHANNEL}	$\frac{2^{21}}{f_{PCLKB}}$	41.9ms	43.7ms	167.7ms	174.8ms	262ms
T _{MAX_UNIT}	$\frac{2^{29}}{f_{PCLKB}}$	10.7s	11.2s	42.9s	44.7s	67.1s

Program example

```
#include "r_pdl_tmr.h"

/* RPD_L device-specific definitions */
#include "r_pdl_definitions.h"

void func(void)
{
    /* Output a pulse and wait for 40ms */
    R_TMR_CreateOneShot(
        PDL_TMR_TMR0,
        PDL_TMR_OUTPUT_HIGH,
        40E-3,
        PDL_NO_FUNC,
        0
    );
}
```

6) R_TMR_Destroy

Synopsis

Disable a TMR timer unit.

Prototype

```
bool R_TMR_Destroy(
    uint8_t data // Unit selection
);
```

Description

Shut down a TMR timer unit.

[data]

The timer unit n (where n = 0 or 1).
Unit 0 comprises channels TMR0 and TMR1.
Unit 1 comprises channels TMR2 and TMR3.

Return value

True.

Category

Timer TMR

Reference

None.

Remarks

- The timer unit is put into the stop state to reduce power consumption.

Program example

```
/* RPDL definitions */
#include "r_pdl_tmr.h"

/* RPDL device-specific definitions */
#include "r_pdl_definitions.h"

void func(void)
{
    /* Shutdown channels 0 and 1 */
    R_TMR_Destroy(
        0
    );
}
```

7) R_TMR_ControlChannel

Synopsis

Write to timer channel registers.

Prototype

```
bool R_TMR_ControlChannel(
    uint8_t data1, // Channel selection
    uint32_t data2, // Configuration selection
    uint8_t data3, // Register value
    uint8_t data4, // Register value
    uint8_t data5 // Register value
);
```

Description

Modify a timer channel's operation, counter and compare registers.

[data1]

The channel number n (where n = 0, 1, 2 or 3).

[data2]

The channel settings to be modified.

If multiple selections are required, use “|” to separate each selection.

- Counter stop / re-start

PDL_TMR_STOP or PDL_TMR_START	Disable or re-enable the counter clock source.
----------------------------------	--

- The counter or compare registers to be modified.

PDL_TMR_COUNTER	Update the timer counter register (TCNT).
PDL_TMR_TIME_CONSTANT_A	Update the timer compare match A register (TCORA).
PDL_TMR_TIME_CONSTANT_B	Update the timer compare match B register (TCORB).

[data3]

The counter value. This will be ignored if the register is not selected.

[data4]

The compare match A value. This will be ignored if the register is not selected.

[data5]

The compare match B value. This will be ignored if the register is not selected.

Return value

True if all parameters are valid and exclusive; otherwise false.

Category

Timer TMR

Reference

R_TMR_CreateChannel

Remarks

- None.

Program example

```
/* RPDL definitions */
#include "r_pdl_tmr.h"

/* RPDL device-specific definitions */
#include "r_pdl_definitions.h"

void func(void)
{
    /* Load the counter on channel TMR0 */
    R_TMR_ControlChannel(
        0,
        PDL_TMR_COUNTER,
        0xFF,
        PDL_NO_DATA,
        PDL_NO_DATA
    );
}
```

8) R_TMR_ControlUnit

Synopsis

Write to timer unit registers.

Prototype

```
bool R_TMR_ControlUnit(
    uint8_t data1, // Unit selection
    uint32_t data2, // Configuration selection
    uint16_t data3, // Register value
    uint16_t data4, // Register value
    uint16_t data5 // Register value
);
```

Description

Modify a timer unit's counter and compare registers.

[data1]

The unit number n (where n = 0 or 1).

[data2]

The channel settings to be modified.

If multiple selections are required, use “|” to separate each selection.

- Counter stop / re-start

PDL_TMR_STOP or PDL_TMR_START	Disable or re-enable the counter clock source.
-------------------------------	--

- The counter or compare registers to be modified.

PDL_TMR_COUNTER	Update the timer counter register (TCNT).
PDL_TMR_TIME_CONSTANT_A	Update the timer compare match A register (TCORA).
PDL_TMR_TIME_CONSTANT_B	Update the timer compare match B register (TCORB).

[data3]

The 16-bit counter value. This will be ignored if the register is not selected.

[data4]

The 16-bit compare match A value. This will be ignored if the register is not selected.

[data5]

The 16-bit compare match B value. This will be ignored if the register is not selected.

Return value

True if all parameters are valid and exclusive; otherwise false.

Category

Timer TMR

Reference

R_TMR_CreateUnit

Remarks

- For unit 0, the upper byte is the value for TMR0 and the lower byte is the value for TMR1. For unit 1, the upper byte is the value for TMR2 and the lower byte is the value for TMR3.

Program example

```
/* RPDL definitions */
#include "r_pdl_tmr.h"

/* RPDL device-specific definitions */
#include "r_pdl_definitions.h"

void func(void)
{
    /* Load the unit 1 counter and constants */
    R_TMR_ControlUnit(
        1,
        PDL_TMR_COUNTER | PDL_TMR_TIME_CONSTANT_A | \
        PDL_TMR_TIME_CONSTANT_B,
        0xAAFF,
        0x100,
        0x5600
    );
}
```

9) R_TMR_ControlPeriodic

Synopsis Control periodic operation.

Prototype

```
bool R_TMR_ControlPeriodic(
    uint8_t data1, // 8-bit (channel) or 16-bit (unit) selection
    uint32_t data2, // Configuration selection
    double data3, // The new period or frequency
    double data4 // The new pulse width or duty cycle
);
```

Description Modify a periodic timer operation.

[data1]

PDL_TMR_TMR0 or PDL_TMR_TMR1 or PDL_TMR_TMR2 or PDL_TMR_TMR3 or PDL_TMR_UNIT0 or PDL_TMR_UNIT 1	The channel n (n = 0, 1, 2 or 3) or unit (n = 0 or 1) to be configured.
--	---

[data2]

Select the options to be modified. Use “|” to separate each selection.

- Period or frequency calculation

PDL_TMR_PERIOD or PDL_TMR_FREQUENCY	The parameters data3 and data4 will contain either period and pulse width or frequency and duty cycle.
--	--

- Output pin control

PDL_TMR_OUTPUT_ENABLE or PDL_TMR_OUTPUT_DISABLE	Enable or disable the periodic output on pin TMO _n . For 16-bit operation the pin shall be TMO2 when n = 1.
--	--

- ADC trigger control

PDL_TMR_ADC_TRIGGER_OFF or PDL_TMR_ADC_TRIGGER_ON	Disable or enable periodic ADC conversion start requests. Applicable only for channels TMR0 or TMR2, or units 0 or 1.
--	---

- Counter stop / start

PDL_TMR_STOP or PDL_TMR_START	Disable or re-enable the counter clock source.
----------------------------------	--

[data3]

The new period or frequency. This will be ignored if a timing change is not requested.

[data4]

The new pulse width or duty cycle (%). This will be ignored if a timing change is not requested.

Return value True if all parameters are valid and exclusive; otherwise false.

Category Timer TMR

Reference R_TMR_CreatePeriodic

Remarks • See the remarks for R_TMR_CreatePeriodic.

Program example

```
/* RPDL definitions */
#include "r_pdl_tmr.h"

/* RPDL device-specific definitions */
#include "r_pdl_definitions.h"

void func(void)
{
    /* Change timer TMR1 to 600ns period, 100ns pulse width */
    R_TMR_ControlPeriodic(
        PDL_TMR_TMR1,
        PDL_TMR_PERIOD,
        600E-9,
        100E-9
    );
}
```

10) R_TMR_ReadChannel**Synopsis**

Read from timer channel registers.

Prototype

```
bool R_TMR_ReadChannel(
    uint8_t data1, // Channel selection
    uint8_t * data2, // A pointer to the data storage location
    uint8_t * data3, // A pointer to the data storage location
    uint8_t * data4, // A pointer to the data storage location
    uint8_t * data5 // A pointer to the data storage location
);
```

Description

Read any of the timer's counter, compare or status flag registers.

[data1]

The channel number *n* (where *n* = 0, 1, 2 or 3).

[data2]

The status flags shall be stored in the format below.
The flag will be set to 1 if the condition has been detected.
Specify PDL_NO_PTR if the flags are not to be read.

b7 – b4	b2	b1	b0
0	Overflow	Compare match B	Compare match A

[data3]

A pointer to where the counter value shall be stored. Specify PDL_NO_PTR if it is not required.

[data4]

Where the compare match A value shall be stored. Specify PDL_NO_PTR if it is not required.

[data5]

Where the compare match B value shall be stored. Specify PDL_NO_PTR if it is not required.

Return value

True.

Category

Timer TMR

Reference

R_TMR_CreateChannel

Remarks

- If the status flags are read, any flag that has been set to 1 shall be automatically cleared to 0 by this function.

Program example

```
#include "r_pdl_tmr.h"

/* RPD_L device-specific definitions */
#include "r_pdl_definitions.h"

uint8_t Flags;
uint8_t Counter;
uint8_t CompareMatchA;
uint8_t CompareMatchB;

void func(void)
{
    /* Read the status flags and registers for TMR0 */
    R_TMR_ReadChannel(
        0,
        &Flags,
        &Counter,
        &CompareMatchA,
        &CompareMatchB
    );
}
```

11) R_TMR_ReadUnit

Synopsis

Read from timer unit registers.

Prototype

```
bool R_TMR_ReadUnit(
    uint8_t data1, // Unit selection
    uint8_t * data2, // A pointer to the data storage location
    uint16_t * data3, // A pointer to the data storage location
    uint16_t * data4, // A pointer to the data storage location
    uint16_t * data5 // A pointer to the data storage location
);
```

Description

Read any of the timer’s counter, compare or status flag registers.

[data1]
The unit number n (where n = 0 or 1).

[data2]
The status flags shall be stored in the format below.
A flag will be set to 1 if the condition has been detected.
Specify PDL_NO_PTR if the flags are not to be read.

The unit 0 status flags shall be stored in the format:

	b7	b6	b5	b4	b3	b2	b1	b0
0	TMR0				0	TMR1		
	Overflow	Compare match B	Compare match A	Overflow		Compare match B	Compare match A	

The unit 1 status flags shall be stored in the format:

	b7	b6	b5	b4	b3	b2	b1	b0
0	TMR2				0	TMR3		
	Overflow	Compare match B	Compare match A	Overflow		Compare match B	Compare match A	

[data3]
Where the counter value shall be stored. Specify PDL_NO_PTR if it is not required.

[data4]
Where the compare match A value shall be stored. Specify PDL_NO_PTR if it is not required.

[data5]
Where the compare match B value shall be stored. Specify PDL_NO_PTR if it is not required.

Return value

True.

Category

Timer TMR

Reference

R_TMR_CreateUnit

Remarks

- If the status flags are read, any flag that has been set to 1 shall be automatically cleared to 0 by this function.

Program example

```
/* RPDL definitions */
#include "r_pdl_tmr.h"

/* RPDL device-specific definitions */
#include "r_pdl_definitions.h"

uint8_t Flags;
uint16_t Counter;
uint16_t CompareMatchA;
uint16_t CompareMatchB;

void func(void)
{
    /* Read the status flags and registers for TMR unit 0 */
    R_TMR_ReadUnit(
        0,
        &Flags,
        &Counter,
        &CompareMatchA,
        &CompareMatchB
    );
}
```

4.2.19. Compare Match Timer

1) R_CMT_Create

Synopsis Configure a CMT channel.

Prototype

```
bool R_CMT_Create(
    uint8_t data1, // Timer channel selection
    uint16_t data2, // Configuration selection
    double data3, // Period, frequency or register data
    void * func, // Callback function
    uint8_t data4 // Interrupt priority level
);
```

Description Set up a Compare Match Timer channel.

[data1]
The channel number n (where n = 0, 1, 2 or 3).

[data2]
Configure the timer. To set multiple options at the same time, use “|” to separate each value. The default settings are shown in **bold**.

- Clock calculation

PDL_CMT_PERIOD or	The parameter data3 will specify the timer period. The counter clock source and compare match value will be calculated by this function.
PDL_CMT_FREQUENCY or	The parameter data3 will specify the timer frequency. The counter clock source and compare match value will be calculated by this function.
PDL_CMT_PCLK_DIV_8 or PDL_CMT_PCLK_DIV_32 or PDL_CMT_PCLK_DIV_128 or PDL_CMT_PCLK_DIV_512	Select the internal clock signal PCLKB ÷ 8, 32, 128 or 512 as the counter clock source. The parameter data3 will be the register CMCOR value.

- Counter start control

PDL_CMT_START or PDL_CMT_STOP	Enable or disable the starting of the timer count operation.
---	--

- DMAC / DTC trigger control

PDL_CMT_DMTC_TRIGGER_DISABLE or PDL_CMT_DMTC_TRIGGER_ENABLE or PDL_CMT_DTC_TRIGGER_ENABLE	Disable or enable activation of the DMAC or DTC when a compare match occurs.
--	--

[data3]
The data to be used for the register value calculations.

<u>Data use</u>	<u>Parameter type</u>
The timer period in seconds or	double
The timer frequency in Hz or	double
The value to be put in register CMCOR	uint16_t

[func]
The function to be called at the periodic interval. Specify PDL_NO_FUNC if not required.

[data4]
The interrupt priority level. Select between 1 (lowest priority) and 15 (highest priority). This parameter will be ignored if PDL_NO_FUNC is specified for parameter func.

Return value True if all parameters are valid and exclusive; otherwise false.

Category Compare Match Timer

Reference R_CGC_Set

Remarks

- Function R_CGC_Set must be called (with the current clock source selected) before using this function.
- If a callback function is specified, this function will enable the relevant interrupt. Please see the notes on callback function use in §6.
- A callback function is executed by the interrupt processing function. This means that no other interrupt can be processed until the callback function has completed.
- Ensure that the timer channel is stopped before calling this function.
- The timing limits depend on the frequency of the peripheral module clock, PCLKB.

	Equation	f _{PCLKB} (MHz)					
		50	48	12.5	12	32	8
Period _{MIN}	$\frac{8}{f_{PCLKB}}$	160ns	167ns	640ns	667ns	250ns	1.0μs
Period _{MA} x	$\frac{2^{25}}{f_{PCLKB}}$	671ms	699ms	2.68s	2.79s	1.05s	4.19s
f _{MAX}	$\frac{f_{PCLKB}}{8}$	6.25 MHz	6.0 MHz	1.56 MHz	1.5 MHz	4.0 MHz	1.0 MHz
f _{MIN}	$\frac{f_{PCLKB}}{2^{25}}$	1.49 Hz	1.43 Hz	0.37 Hz	0.357 Hz	0.95 Hz	0.24 Hz

- If the requested period is not a multiple of the minimum period, the actual time period will be more than the requested time period.

Program example

```

/* RPD_L definitions */
#include "r_pdl_cmt.h"

/* RPD_L device-specific definitions */
#include "r_pdl_definitions.h"

void func(void)
{
    /* Configure CMT channel 0 for 10μs operation */
    R_CMT_Create(
        0,
        PDL_CMT_PERIOD,
        10E-6,
        PDL_NO_FUNC,
        0
    );

    /* Configure CMT channel 1 for 1kHz operation */
    R_CMT_Create(
        1,
        PDL_CMT_FREQUENCY,
        1E3,
        PDL_NO_FUNC,
        0
    );

    /* Configure CMT channel 2 using register values */
    R_CMT_Create(
        2,
        PDL_CMT_PCLK_DIV_32,
        0x55AA,
        PDL_NO_FUNC,
        0
    );
}

```

2) R_CMT_CreateOneShot

Synopsis

Configure a CMT channel as a one-shot event.

Prototype

```
bool R_CMT_CreateOneShot(
    uint8_t data1, // Timer channel selection
    uint16_t data2, // Configuration selection
    double data3, // Period
    void * func, // Callback function
    uint8_t data4 // Interrupt priority level
);
```

Description

Set up a Compare Match Timer channel and start the timer.

[data1]

The channel number n (where n = 0, 1, 2 or 3).

[data2]

Configure the timer.

The default settings are shown in **bold**. Specify PDL_NO_DATA to use the defaults.

- Control the CPU during the one-shot operation.

PDL_CMT_CPU_ON or	Allow the CPU to run normally while the one-shot operates.
PDL_CMT_CPU_OFF	Stop the CPU when the one-shot timer starts. The CPU will re-start when any valid interrupt occurs.

- DMAC / DTC trigger control

PDL_CMT_DMAC_DTC_TRIGGER_DISABLE or	Disable or enable activation of the DMAC or DTC when a compare match occurs.
PDL_CMT_DMAC_TRIGGER_ENABLE or PDL_CMT_DTC_TRIGGER_ENABLE	

[data3]

The one-shot time period (in seconds).

[func]

The function to be called when the one-shot period ends.

If you specify PDL_NO_FUNC, this function will wait for the timer to complete before returning. You should always specify a function if PDL_CMT_CPU_OFF is selected to ensure that an interrupt will re-start the CPU.

[data4]

The interrupt priority level. Select between 1 (lowest priority) and 15 (highest priority). This parameter will be ignored if PDL_NO_FUNC is specified for parameter func.

Return value

True if all parameters are valid and exclusive; otherwise false.

Category

Compare Match Timer

Reference

R_CGC_Set

Remarks

- Function R_CGC_Set must be called (with the current clock source selected) before using this function.
- Function R_CMT_Create is not required.
- Ensure that the timer channel is stopped before calling this function. Note that the timer is stopped automatically when the one-shot period is reached.
- If a callback function is specified, this function will enable the relevant interrupt. Please see the notes on callback function use in §6.
- A callback function is executed by the interrupt processing function. This means that no other interrupt can be processed until the callback function has completed.
- The timing limits depend on the peripheral module clock, PCLKB.

Equation	f _{PCLKB} (MHz)						
	50	48	12.5	12	32	8	
T _{MIN} $\frac{8}{f_{PCLK}}$	160ns	166.67ns	640ns	666.67ns	250ns	1μs	
T _{MA} $\frac{2^{25}}{f_{PCLK}}$	671ms	699ms	2.68s	2.79s	1.05s	4.19s	

- If the requested period is not a multiple of the minimum period, the actual time period will be more than the requested time period.

Program example

```

/* RPDL definitions */
#include "r_pdl_cmt.h"

/* RPDL device-specific definitions */
#include "r_pdl_definitions.h"

void func(void)
{
    /* Use CMT channel 0 for a 1ms pause */
    R_CMT_CreateOneShot(
        0,
        PDL_NO_DATA,
        1E-3,
        PDL_NO_FUNC,
        0
    );
}

```

3) R_CMT_Destroy

Synopsis

Disable a CMT unit.

Prototype

```
bool R_CMT_Destroy(
    uint8_t data // Unit selection
);
```

Description

Shut down a CMT unit.

[data]

The timer unit n (where n = 0 or 1).
Unit 0 comprises channels CMT0 and CMT1.
Unit 1 comprises channels CMT2 and CMT3.

Return value

True if the unit selection is valid; otherwise false.

Category

Compare Match Timer

Reference

R_CMT_Create

Remarks

- The timer unit is put into the stop state to reduce power consumption.

Program example

```
/* RPDL definitions */
#include "r_pdl_cmt.h"

/* RPDL device-specific definitions */
#include "r_pdl_definitions.h"

void func(void)
{
    /* Shutdown channels 0 and 1 */
    R_CMT_Destroy(
        0
    );
}
```

4) R_CMT_Control

Synopsis Control CMT operation.

Prototype

```
bool R_CMT_Control(
    uint8_t data1, // Channel selection
    uint16_t data2, // Configuration selection
    double data3 // Period, frequency or register data
);
```

Description Modify the operation of a CMT channel.

[data1]
The channel number n (where n = 0, 1, 2 or 3).

[data2]
Configure the timer channel. To set multiple options at the same time, use “|” to separate each value.

- Counter stop / re-start

PDL_CMT_STOP	Disable the counter clock source.
PDL_CMT_START	Enable the counter clock source.

- Value change request

PDL_CMT_PERIOD or PDL_CMT_FREQUENCY or PDL_CMT_CONSTANT or PDL_CMT_COUNTER	The parameter data3 will contain the new period, frequency, constant register (CMCOR) or counter register (CMCNT) value.
---	--

[data3]
The new period, frequency or register value. This will be ignored if a value change is not requested.

Data use	Parameter type
The timer period in seconds or	double
The timer frequency in Hz or	double
The value to be put in the selected register	uint16_t

Return value True if all parameters are valid and exclusive; otherwise false.

Category Compare Match Timer

Reference R_CMT_Create

Remarks

- R_CMT_Create must be used first to configure the channel.
- The Stop operation is executed at the start of this function. The Start operation is executed at the end. Therefore, both options can be selected together with a value change in one function call. To avoid register access conflicts or invalid calls to the callback function, use this method when changing any value.
- If the CMCNT register value is changed to the same value as the CMCOR register, the CMCNT register will be set to 0.

Program example

```
/* RPDL definitions */
#include "r_pdl_cmt.h"

/* RPDL device-specific definitions */
#include "r_pdl_definitions.h"

void func(void)
{
    /* Change channel 2 to 1ms period */
    R_CMT_Control(
        2,
        PDL_CMT_STOP | PDL_CMT_PERIOD | PDL_CMT_START,
        1E-3
    );
}
```

5) R_CMT_Read

Synopsis

Read CMT channel status and registers.

Prototype

```
bool R_CMT_Read(
    uint8_t data1,    // Channel selection
    uint8_t * data2,  // A pointer to the data storage location
    uint16_t * data3  // A pointer to the data storage location
);
```

Description

Read and store the counter value and status flag.

[data1]

The channel number n (where n = 0, 1, 2 or 3).

[data2]

The compare match status flag shall be stored in the following format.
Specify PDL_NO_PTR if the flag is not to be read.

b7 – b1	b0
0	0: Idle 1: Compare match condition detected

[data3]

A pointer to where the counter value shall be stored. Specify PDL_NO_PTR if it is not required.

Return value

True if all parameters are valid; otherwise false.

Category

Compare Match Timer

Reference

R_CMT_Create

Remarks

- If the flag is read and is set to 1, it shall be automatically cleared to 0 by this function.

Program example

```
/* RPDL definitions */
#include "r_pdl_cmt.h"

/* RPDL device-specific definitions */
#include "r_pdl_definitions.h"

uint8_t Flags;
uint16_t Counter;

void func(void)
{
    /* Read the channel 2 values */
    R_CMT_Read(
        2,
        &Flags,
        &Counter
    );
}
```

4.2.20. Real-time Clock

1) R_RTC_Create

Synopsis Configure the Real-time clock.

Prototype

```
bool R_RTC_Create(
    uint32_t data1, // Configuration selection
    uint8_t data2, // Pin selection
    uint32_t data3, // Current time
    uint32_t data4, // Current date
    uint8_t data5, // Capture 0 configuration
    uint8_t data6, // Capture 1 configuration
    uint8_t data7, // Capture 2 configuration
    uint16_t data8, // Periodic configuration
    uint32_t data9, // Alarm time
    uint32_t data10, // Alarm date
    void * func1, // Callback function
    uint8_t data11, // Interrupt priority level
    void * func2, // Callback function
    uint8_t data12 // Interrupt priority level
);
```

Description (1/4) Set up and start the Real-time clock.

[data1]

Configure the clock options.

To set multiple options at the same time, use “|” to separate each value.

The default settings are shown in **bold**. Specify PDL_NO_DATA to use the default if not enabling the alarm.

- 12 or 24 hour mode

PDL_RTC_24_HOUR_MODE or PDL_RTC_12_HOUR_MODE	Select 12 or 24 hour mode.
--	----------------------------

- Alarm enabling

PDL_RTC_ALARM_HOUR_ENABLE	All three can be enabled using: PDL_RTC_ALARM_TIME_ENABLE
PDL_RTC_ALARM_MINUTE_ENABLE	
PDL_RTC_ALARM_SECOND_ENABLE	
PDL_RTC_ALARM_YEAR_ENABLE	All four can be enabled using: PDL_RTC_ALARM_DATE_ENABLE
PDL_RTC_ALARM_MONTH_ENABLE	
PDL_RTC_ALARM_DAY_ENABLE	
PDL_RTC_ALARM_DOW_ENABLE	

- Clock output control

PDL_RTC_OUTPUT_DISABLE or PDL_RTC_OUTPUT_ENABLE	Disable or enable the 1 Hz clock output on the RTCOUT pin.
---	--

[data2]

Specify pins that will be used.

If pin P32 is specified for both RTCOUT and RTCIC2 at the same time this function will return false.

Select PDL_NO_DATA if no pins are required.

To set multiple options at the same time, use “|” to separate each value.

- RTCOUT Pin

PDL_RTC_PIN_RTCOUT_P16 or PDL_RTC_PIN_RTCOUT_P32	If using the RTCOUT pin then select the port to use for it.
---	---

- Capture Pins

PDL_RTC_PIN_RTCIC0_P30	Specify any capture pins which will be used.
PDL_RTC_PIN_RTCIC1_P31	
PDL_RTC_PIN_RTCIC2_P32	

Description (2/4)

[data3]

The current day of the week (DOW) and time in hours, minutes and seconds. BCD format is used. The format is dependent upon if using 12 hour or 24 hour mode.

24 Hour Mode:

b31 – b24	b23 – b16	b15 – b8	b7 – b0
Day of week Valid from 0 to 6. 0 = Sunday. Specify 0xFF for automatic calculation using the values in data3.	Hours Valid from 0 to 23.	Minutes Valid from 0 to 59.	Seconds Valid from 0 to 59.

12 Hour Mode:

b31 – b24	b23	b22 – b16	b15 – b8	b7 – b0
Day of week Valid from 0 to 6. 0 = Sunday. Specify 0xFF for automatic calculation using the values in data3.	PM 0 = AM 1 = PM	Hours Valid from 1 to 12.	Minutes Valid from 0 to 59.	Seconds Valid from 0 to 59.

[data4]

The current year, month and day. BCD format is used. If not required, specify PDL_NO_DATA.

b31 – b16	b15 – b8	b7 – b0
Year Valid from 0 to 9999.	Month Valid from 1 to 12.	Day Valid from 1 to the number of days in the month.

[data5]

Configure the Capture 0 (RTCIC0 pin) options. To set multiple options at the same time, use “|” to separate each value. The default settings are shown in **bold**.

• Edge

PDL_RTC_CAPTURE_EDGE_NONE or PDL_RTC_CAPTURE_EDGE_RISING or PDL_RTC_CAPTURE_EDGE_FALLING or PDL_RTC_CAPTURE_EDGE_BOTH	Select the edge that will trigger a capture event.
---	--

• Time Capture Noise Filter Control

PDL_RTC_CAPTURE_FILTER_OFF or PDL_RTC_CAPTURE_FILTER_ON_DIV_1 or PDL_RTC_CAPTURE_FILTER_ON_DIV_32	Configure the capture noise filter. If enabling select the sampling period relative to the count source.
--	--

[data6]

Configure the Capture 1 (RTCIC1 pin) options. To set multiple options at the same time, use “|” to separate each value. The default settings are shown in **bold**.

• Edge

PDL_RTC_CAPTURE_EDGE_NONE or PDL_RTC_CAPTURE_EDGE_RISING or PDL_RTC_CAPTURE_EDGE_FALLING or PDL_RTC_CAPTURE_EDGE_BOTH	Select the edge that will trigger a capture event.
---	--

• Time Capture Noise Filter Control

PDL_RTC_CAPTURE_FILTER_OFF or PDL_RTC_CAPTURE_FILTER_ON_DIV_1 or PDL_RTC_CAPTURE_FILTER_ON_DIV_32	Configure the capture noise filter. If enabling select the sampling period relative to the count source.
--	--

Description (3/4)

[data7]

Configure the Capture 2 (RTCIC2 pin) options.
 To set multiple options at the same time, use “|” to separate each value.
 The default settings are shown in **bold**.
 The RTCIC2 pin is not required when using 64-pin package, specify PDL_NO_DATA.

- Edge

PDL_RTC_CAPTURE_EDGE_NONE or PDL_RTC_CAPTURE_EDGE_RISING or PDL_RTC_CAPTURE_EDGE_FALLING or PDL_RTC_CAPTURE_EDGE_BOTH	Select the edge that will trigger a capture event.
---	--

- Time Capture Noise Filter Control

PDL_RTC_CAPTURE_FILTER_OFF or PDL_RTC_CAPTURE_FILTER_ON_DIV_1 or PDL_RTC_CAPTURE_FILTER_ON_DIV_32	Configure the capture noise filter. If enabling select the sampling period relative to the count source.
--	--

[data8]

Configure the clock periodic interrupt.
 The default setting is shown in **bold**.

- Periodic interrupt selection

PDL_RTC_PERIODIC_DISABLE or PDL_RTC_PERIODIC_256_HZ or PDL_RTC_PERIODIC_128_HZ or PDL_RTC_PERIODIC_64_HZ or PDL_RTC_PERIODIC_32_HZ or PDL_RTC_PERIODIC_16_HZ or PDL_RTC_PERIODIC_8_HZ or PDL_RTC_PERIODIC_4_HZ or PDL_RTC_PERIODIC_2_HZ or PDL_RTC_PERIODIC_1_HZ or PDL_RTC_PERIODIC_2S	The frequency or interval for periodic interrupt requests. When main clock is selected as count source, PDL_RTC_PERIODIC_256_HZ is generated every 1/128 second.
--	--

[data9]

The alarm day of the week and time in hours, minutes and seconds. BCD format is used.
 If not required, specify PDL_NO_DATA.
 The format is dependent upon if using 12 hour or 24 hour mode.

24 Hour Mode:

b31 – b24	b23 – b16	b15 – b8	b7 – b0
Day of week Valid from 0 to 6. 0 = Sunday. Specify 0xFF for automatic calculation using the values in data5.	Hours Valid from 0 to 23.	Minutes Valid from 0 to 59.	Seconds Valid from 0 to 59.

12 Hour Mode:

b31 – b24	b23	b22 – b16	b15 – b8	b7 – b0
Day of week Valid from 0 to 6. 0 = Sunday. Specify 0xFF for automatic calculation using the values in data3.	PM 0 = AM 1 = PM	Hours Valid from 1 to 12.	Minutes Valid from 0 to 59.	Seconds Valid from 0 to 59.

[data10]

The alarm year, month and day. BCD format is used. If not required, specify PDL_NO_DATA.

b31 – b16	b15 – b8	b7 – b0
Year Valid from 0 to 9999.	Month Valid from 1 to 12.	Day Valid from 1 to the number of days in the month.

[func1]

The function to be called when an alarm occurs. Specify PDL_NO_FUNC if not required.

[data11]

The alarm interrupt priority level. Select between 1 (lowest priority) and 15 (highest priority). This parameter will be ignored if PDL_NO_FUNC is specified for parameter func1.

Description (4/4)	<p>[func2] The function to be called at the periodic interval. Specify PDL_NO_FUNC if not required.</p> <p>[data12] The periodic interrupt priority level. Select between 1 (lowest priority) and 15 (highest priority). This parameter will be ignored if PDL_NO_FUNC is specified for parameter func2.</p>
Return value	True if all parameters are valid and exclusive; otherwise false.
Category	Real-time clock
Reference	R_CGC_Set, R_CGC_Control, R_MCU_OFS
Remarks	<ul style="list-style-type: none"> • The check for days in the month allows for leap years. • If entering software standby or deep software standby mode soon after starting the RTC, use R_RTC_Read first to confirm that the values are correct. • If capture is enabled for a capture pin that has not been selected this function will return false. • The oscillation accuracy of the sub-clock is affected when an on-chip debugger emulator is connected and the sub-clock drive setting is low. • Before calling this function the count source must be must be enabled and stabilized. Refer R_CGC_Set and R_CGC_Control for count source and stabilization time configuration. • In order to use the Vbatt back-up mode for the sub-clock, it is necessary to use R_MCU_OFS to enable the LVD channel 0. Before calling this function, check the LVD channel 0 detection flag. (Please refer to the example 5.15.3.3) • This function is not required when using 48-pin package. • The options PDL_RTC_PIN_RTOUT_P32 and PDL_RTC_PIN_RTCIC2_P32 are not required when using 64-pin package. Specify PDL_NO_DATA for the data7. • This function is called to use RTC after setting option PDL_CGC_RTC_TO_BE_USED in R_CGC_Control at cold start. • This function is not required when using 48-pin package.

Program example

```

/* RPDL definitions */
#include "r_pdl_rtc.h"

/* RPDL device-specific definitions */
#include "r_pdl_definitions.h"

void alarm_function(void){}

void func(void)
{
    /* Configure the clock for an alarm at 12 noon every day */
    /* Using default 24 hour mode.*/
    R_RTC_Create(
        PDL_RTC_ALARM_HOUR_ENABLE | \
        PDL_RTC_ALARM_MINUTE_ENABLE | \
        PDL_RTC_ALARM_SECOND_ENABLE,
        PDL_NO_DATA,
        0xFF114200,      // Automatic day of week; 11:42:00
        0x20100916,     // 16-Sep-2010
        PDL_NO_DATA,
        PDL_NO_DATA,
        PDL_NO_DATA,
        PDL_NO_DATA,
        0x00120000,     // Alarm at 12 noon
        PDL_NO_DATA,
        alarm_function,
        15,
        PDL_NO_FUNC,
        PDL_NO_DATA
    );
}

```

2) R_RTC_Destroy

Synopsis

Shut down the Real-time clock.

Prototype

```
bool R_RTC_Destroy(  
    void  
);
```

Description

Stop the RTC counter and disable the subclock to the RTC.

Return value

True

Category

RTC

Reference

None.

Remarks

- This function is not required when using 48-pin package.

Program example

```
/* RPDL definitions */  
#include "r_pdl_rtc.h"  
  
/* RPDL device-specific definitions */  
#include "r_pdl_definitions.h"  
  
void func(void)  
{  
    /* Shutdown the RTC */  
    R_RTC_Destroy();  
}
```

3) R_RTC_Control

Synopsis Modify the Real-time clock operation.

```

Prototype
bool R_RTC_Control(
    uint32_t data1, // Control selection
    uint16_t data2, // Update selection
    uint32_t data3, // Current time
    uint32_t data4, // Current date
    uint32_t data5, // Alarm time
    uint32_t data6, // Alarm date
    uint16_t data7, // Error Adjustment
    uint8_t data8, // Capture 0 configuration
    uint8_t data9, // Capture 1 configuration
    uint8_t data10, // Capture 2 configuration
    uint16_t data11 // Periodic configuration
);
    
```

Description (1/4) Change clock settings and update the time or date.

[data1]

Change the clock operation.

To set multiple options at the same time, use “|” to separate each value.

If no change is required, specify PDL_NO_DATA.

- 12 or 24 hour mode

PDL_RTC_24_HOUR_MODE or PDL_RTC_12_HOUR_MODE	Select 12 or 24 hour mode.
---	----------------------------

- Alarm control

PDL_RTC_ALARM_HOUR_DISABLE or PDL_RTC_ALARM_HOUR_ENABLE	All three can be controlled using: PDL_RTC_ALARM_TIME_DISABLE or PDL_RTC_ALARM_TIME_ENABLE
PDL_RTC_ALARM_MINUTE_DISABLE or PDL_RTC_ALARM_MINUTE_ENABLE	
PDL_RTC_ALARM_SECOND_DISABLE or PDL_RTC_ALARM_SECOND_ENABLE	
PDL_RTC_ALARM_YEAR_DISABLE or PDL_RTC_ALARM_YEAR_ENABLE	All four can be controlled using: PDL_RTC_ALARM_DATE_DISABLE or PDL_RTC_ALARM_DATE_ENABLE
PDL_RTC_ALARM_MONTH_DISABLE or PDL_RTC_ALARM_MONTH_ENABLE	
PDL_RTC_ALARM_DAY_DISABLE or PDL_RTC_ALARM_DAY_ENABLE	
PDL_RTC_ALARM_DOW_DISABLE or PDL_RTC_ALARM_DOW_ENABLE	

- Clock output control

PDL_RTC_OUTPUT_DISABLE or PDL_RTC_OUTPUT_ENABLE	Disable or enable the 1 Hz clock output on the RTCOUT pin.
--	--

- Clock control

PDL_RTC_CLOCK_STOP or PDL_RTC_CLOCK_START	Stop or re-start the clock.
--	-----------------------------

- 30-second adjustment control

PDL_RTC_ADJUST_START	Start the 30-second adjustment process.
----------------------	---

- Reset control

PDL_RTC_RESET_START	Start the reset process.
---------------------	--------------------------

Description (2/4)

[data2]

Select the values to be changed.

To set multiple options at the same time, use “|” to separate each value.

If no change is required, specify PDL_NO_DATA.

- Select the time counters to be updated, using values supplied in parameter data3.

PDL_RTC_UPDATE_CURRENT_HOUR	All three can be selected using: PDL_RTC_UPDATE_CURRENT_TIME
PDL_RTC_UPDATE_CURRENT_MINUTE	
PDL_RTC_UPDATE_CURRENT_SECOND	

- Select the date counters to be updated, using values supplied in parameters data3 and data4.

PDL_RTC_UPDATE_CURRENT_YEAR	All four can be selected using: PDL_RTC_UPDATE_CURRENT_DATE. Parameter data3 is used for the day of the week.
PDL_RTC_UPDATE_CURRENT_MONTH	
PDL_RTC_UPDATE_CURRENT_DAY	
PDL_RTC_UPDATE_CURRENT_DOW	

- Select the alarm time counters to be updated, using values supplied in parameter data5.

PDL_RTC_UPDATE_ALARM_HOUR	All three can be selected using PDL_RTC_UPDATE_ALARM_TIME.
PDL_RTC_UPDATE_ALARM_MINUTE	
PDL_RTC_UPDATE_ALARM_SECOND	

- Select the alarm date counters to be updated, using values supplied in parameters data5 and data6.

PDL_RTC_UPDATE_ALARM_YEAR	All four can be selected using PDL_RTC_UPDATE_ALARM_DATE. Parameter data5 is used for the day of the week.
PDL_RTC_UPDATE_ALARM_MONTH	
PDL_RTC_UPDATE_ALARM_DAY	
PDL_RTC_UPDATE_ALARM_DOW	

[data3]

The new day of the week and time. Ignored if not selected above.

See R_RTC_Create for the format.

[data4]

The new year, month and day. Ignored if not selected above.

See R_RTC_Create for the format.

[data5]

The new alarm day of the week and time. Ignored if not selected above.

See R_RTC_Create for the format.

[data6]

The new alarm year, month and day. Ignored if not selected above.

See R_RTC_Create for the format.

Description (3/4)**[data7]**

Configure the Error Adjustment options.

To set multiple options at the same time, use “|” to separate each value.

If no change is required, specify PDL_NO_DATA.

This setting will be ignored when the main clock is selected as the RTC count source.

- Auto Error Adjustment

PDL_RTC_ERROR_AUTO_ADJUST_DISABLE or PDL_RTC_ERROR_AUTO_ADJUST_ENABLE	Enable or disable automatic error adjustment.
--	---

- Auto Error Adjustment Period

PDL_RTC_ERROR_AUTO_ADJUST_PERIOD_60S or PDL_RTC_ERROR_AUTO_ADJUST_PERIOD_10S	Select the automatic error adjustment period.
---	---

- Auto Error Adjustment Addition or Subtraction selection

PDL_RTC_ERROR_ADJUST_PLUS or PDL_RTC_ERROR_ADJUST_MINUS	Select if the adjustment value will be added or subtracted from the count.
--	--

- Update the Error Adjustment value

PDL_RTC_ERROR_UPDATE_ERROR_ADJUST_VALUE	Select to specify a new error adjustment value.
---	---

- Error Adjustment Value

Valid Range 0 to 3Fh	New automatic error adjustment value, ignored if not selected above.
----------------------	--

[data8]

Configure the Capture 0 (RTCIC0 pin) options.

To set multiple options at the same time, use “|” to separate each value.

- Edge

PDL_RTC_CAPTURE_EDGE_NONE or PDL_RTC_CAPTURE_EDGE_RISING or PDL_RTC_CAPTURE_EDGE_FALLING or PDL_RTC_CAPTURE_EDGE_BOTH	Select the edge that will trigger a capture event.
--	--

- Time Capture Noise Filter Control

PDL_RTC_CAPTURE_FILTER_OFF or PDL_RTC_CAPTURE_FILTER_ON_DIV_1 or PDL_RTC_CAPTURE_FILTER_ON_DIV_32	Configure the capture noise filter. If enabling select the sampling period relative to the count source.
---	--

[data9]

Configure the Capture 1 (RTCIC1 pin) options.

To set multiple options at the same time, use “|” to separate each value.

- Edge

PDL_RTC_CAPTURE_EDGE_NONE or PDL_RTC_CAPTURE_EDGE_RISING or PDL_RTC_CAPTURE_EDGE_FALLING or PDL_RTC_CAPTURE_EDGE_BOTH	Select the edge that will trigger a capture event.
--	--

- Time Capture Noise Filter Control

PDL_RTC_CAPTURE_FILTER_OFF or PDL_RTC_CAPTURE_FILTER_ON_DIV_1 or PDL_RTC_CAPTURE_FILTER_ON_DIV_32	Configure the capture noise filter. If enabling select the sampling period relative to the count source.
---	--

Description (4/4)

[data10]

Configure the Capture 2 (RTCIC2 pin) options.
 To set multiple options at the same time, use “|” to separate each value.
 The RTCIC2 pin is not required when using 64-pin package, specify PDL_NO_DATA.
 If not required, specify PDL_NO_DATA.

- Edge

PDL_RTC_CAPTURE_EDGE_NONE or PDL_RTC_CAPTURE_EDGE_RISING or PDL_RTC_CAPTURE_EDGE_FALLING or PDL_RTC_CAPTURE_EDGE_BOTH	Select the edge that will trigger a capture event.
--	--

- Time Capture Noise Filter Control

PDL_RTC_CAPTURE_FILTER_OFF or PDL_RTC_CAPTURE_FILTER_ON_DIV_1 or PDL_RTC_CAPTURE_FILTER_ON_DIV_32	Configure the capture noise filter. If enabling select the sampling period relative to the count source.
---	--

[data11]

Configure the clock periodic interrupt.

- Periodic interrupt selection

PDL_RTC_PERIODIC_DISABLE or PDL_RTC_PERIODIC_256_HZ or PDL_RTC_PERIODIC_128_HZ or PDL_RTC_PERIODIC_64_HZ or PDL_RTC_PERIODIC_32_HZ or PDL_RTC_PERIODIC_16_HZ or PDL_RTC_PERIODIC_8_HZ or PDL_RTC_PERIODIC_4_HZ or PDL_RTC_PERIODIC_2_HZ or PDL_RTC_PERIODIC_1_HZ or PDL_RTC_PERIODIC_2S	The frequency or interval for periodic interrupt requests.
---	--

Return value

True if all parameters are valid and exclusive; otherwise false.

Category

Real-time clock

Reference

R_RTC_Create, R_RTC_Read, R_CGC_Control, R_CGC_Set

Remarks

- Refer to R_RTC_Create for the time and date formats.
- If the current time or date values are updated, the clock is stopped during the update.
- If the day of week is updated using automatic calculation, the most recent year, month and date will be used.
- The range checking for either day value uses the most recent year and month values.
- If entering software standby or deep software standby mode soon after modifying the RTC values, use R_RTC_Read first to confirm that the values are correct.
- If the output of the RTCOUT pin is enabled or disabled, the clock is stopped during the update.
- If capture is enabled for a capture pin that has not been selected in R_RTC_Create this function will return false.
- This function is called after R_RTC_Create or R_RTC_CreateWarm
- This function is not required when using 48-pin package.
- The RTCIC2 pin is not required when using 64-pin package, specify PDL_NO_DATA for data10.

Program example

```
/* RPDL definitions */
#include "r_pdl_rtc.h"

/* RPDL device-specific definitions */
#include "r_pdl_definitions.h"

void func(void)
{
    /* Disable the alarm calendar, and update the alarm time */
    R_RTC_Control(
        PDL_RTC_ALARM_DATE_DISABLE,
        PDL_RTC_UPDATE_ALARM_TIME,
        PDL_NO_DATA,
        PDL_NO_DATA,
        0x00105300,    // Alarm at 10:53.
        PDL_NO_DATA,
        PDL_NO_DATA,
        PDL_NO_DATA,
        PDL_NO_DATA,
        PDL_NO_DATA,
        PDL_NO_DATA,
        PDL_NO_DATA
    );

    /* Change the day to the 23rd */
    R_RTC_Control(
        PDL_NO_DATA,
        PDL_RTC_UPDATE_CURRENT_DOW | PDL_RTC_UPDATE_CURRENT_DAY,
        0xFF000000,
        0x00000023,
        PDL_NO_DATA,
        PDL_NO_DATA,
        PDL_NO_DATA,
        PDL_NO_DATA,
        PDL_NO_DATA,
        PDL_NO_DATA,
        PDL_NO_DATA,
        PDL_NO_DATA
    );
}
```

4) R_RTC_Read

Synopsis

Read the Real-time clock status flags and counters.

Prototype

```
bool R_RTC_Read(
    uint8_t data1, // Specify what to read
    uint8_t * data2, // A pointer to the flags storage location
    uint32_t * data3, // A pointer to the data storage location
    uint32_t * data4 // A pointer to the data storage location
);
```

Description

Read the Clock counters registers and status flags.

[data1]

Specify what to read.

The option PDL_RTC_READ_CAPTURE_2 is not required when using 64-pin package.

PDL_RTC_READ_CURRENT or PDL_RTC_READ_ALARM or PDL_RTC_READ_CAPTURE_0 or PDL_RTC_READ_CAPTURE_1 or PDL_RTC_READ_CAPTURE_2	Specify which time to read.
--	-----------------------------

[data2]

The format of data2 is dependent upon data1.

Format if data1 = PDL_RTC_READ_CURRENT

The clock status shall be stored in the following format.

Specify PDL_NO_PTR if the flags are not to be read.

b7	b6	b5	b4
Mode	Interrupt requests		
0: 12 hour 1: 24 hour	Carry	Periodic	Alarm
	0: Idle 1: Occurred		

b3	b2	b1	b0
0	Status		
	30-second adjustment	Reset	Clock
	0: Normal operation 1: Adjustment in progress	0: Normal operation 1: Reset in progress	0: Stopped 1: Running

Format if data1 = PDL_RTC_READ_ALARM

The enable bits for the alarm shall be stored in the following format.

1 = enabled, meaning the unit is part of the alarm setting.

0 = disabled, meaning the unit is ignored.

Specify PDL_NO_PTR if the flags are not to be read.

b7	b6	b5	b4	b3	b2	b1	b0
0	Year	Month	Day	Day of week	Hours	Minutes	Seconds

Format if data1 = PDL_RTC_READ_CAPTURE_x

Specify PDL_NO_PTR if the flags are not to be read.

b7 – b1	b0
0	1: Event detected. 0: No event detected

[data3]

The day of the week and time. Specify PDL_NO_PTR if it is not required.

See R_RTC_Create for the format.

[data4]

The year, month and day. Specify PDL_NO_PTR if it is not required.

See R_RTC_Create for the format.

Return value	True if all parameters are valid; otherwise false.
Category	Real-time clock
Reference	R_RTC_Create
Remarks	<ul style="list-style-type: none"> • If an interrupt request flag is set to 1, it shall be automatically cleared to 0 by this function. • Refer to R_RTC_Create for the time and date formats. • If the Carry flag is read as 1, the current time and date were updated during the read process and should be re-read. • The year and day of week is not recorded when using the capture registers and will therefore be read back as zero. • The year returned will be in the range 0 to 99. The hundreds and thousands units are not stored. • After reading a capture time the event detected flag will be automatically cleared. • To read the correct value after return from a reset, period in software standby mode, deep software standby mode, or back-up state, wait for 1/128 second while the RTC clock is operating. • This function is not required when using 48-pin package.

Program example

```

/* RPDL definitions */
#include "r_pdl_rtc.h"

/* RPDL device-specific definitions */
#include "r_pdl_definitions.h"

uint8_t Flags;
uint32_t CurrentTime;

void func(void)
{
    /* Read the current time and flags */
    R_RTC_Read(
        PDL_RTC_READ_CURRENT,
        &Flags,
        &CurrentTime,
        PDL_NO_PTR
    );
}

```

5) R_RTC_CreateWarm

Synopsis

Reconfigure RTC interrupt setting at warm start up.

Prototype

```
bool R_RTC_CreateWarm(
    void * func1,      // Callback function
    uint8_t data1,    // Interrupt priority level
    void * func2,      // Callback function
    uint8_t data2     // Interrupt priority level
);
```

Description

Reconfigure RTC interrupt setting at warm start up.

[func1]

The function to be called when an alarm occurs. Specify PDL_NO_FUNC if not required.

[data1]

The alarm interrupt priority level. Select between 1 (lowest priority) and 15 (highest priority). This parameter will be ignored if PDL_NO_FUNC is specified for parameter func1.

[func2]

The function to be called at the periodic interval. Specify PDL_NO_FUNC if not required.

[data2]

The periodic interrupt priority level. Select between 1 (lowest priority) and 15 (highest priority). This parameter will be ignored if PDL_NO_FUNC is specified for parameter func2.

Return value

True if all parameters are valid and exclusive; otherwise false.

Category

Real-time clock

Reference

R_CGC_Set, R_CGC_Control, R_MCU_GetStatus

Remarks

- The function is called only at warm start up.
- This function is not required when using 48-pin package.

Program example

```
/* RPDL definitions */
#include "r_pdl_rtc.h"

/* RPDL device-specific definitions */
#include "r_pdl_definitions.h"

void alarm_function(void){}

void func(void)
{
    /* Reconfigure RTC interrupt.*/
    R_RTC_CreateWarm(
        alarm_function,
        15,
        PDL_NO_FUNC,
        PDL_NO_DATA
    );
}
```

4.2.21. Watchdog Timer

1) R_WDT_Set

Synopsis

Configure the Watchdog timer.

Prototype

```
bool R_WDT_Set(
    uint32_t data // Configuration selection
);
```

Description

Set up and start the Watchdog timer.

[data]

Configure the timer. To set multiple options at the same time, use “|” to separate each value. The default settings are shown in **bold**.

• Time-out selection

PDL_WDT_TIMEOUT_1024 or PDL_WDT_TIMEOUT_4096 or PDL_WDT_TIMEOUT_8192 or PDL_WDT_TIMEOUT_16384	Time out period specified in cycles of the divided clock as specified in the Clock Selection below.
---	---

• Clock selection

PDL_WDT_PCLK_DIV_4 or PDL_WDT_PCLK_DIV_64 or PDL_WDT_PCLK_DIV_128 or PDL_WDT_PCLK_DIV_512 or PDL_WDT_PCLK_DIV_2048 or PDL_WDT_PCLK_DIV_8192	The division ratio for the internal clock signal PCLKB.
---	---

• MCU reset control

PDL_WDT_TIMEOUT_RESET or PDL_WDT_TIMEOUT_NMI	When the WDT times out, select if either a Reset or an NMI interrupt will be generated.
--	---

• Window Start Position

PDL_WDT_WIN_START_25 or PDL_WDT_WIN_START_50 or PDL_WDT_WIN_START_75 or PDL_WDT_WIN_START_100	The window start position specified as a percentage of the down counter. 0% is when the down counter would underflow. Selecting 100% is equivalent to no window start position.
---	---

• Window End Position

PDL_WDT_WIN_END_0 or PDL_WDT_WIN_END_25 or PDL_WDT_WIN_END_50 or PDL_WDT_WIN_END_75	The window end position specified as a percentage of the down counter. 0% is when the down counter would underflow. Hence specifying 0% is equivalent to no window end position.
---	--

Return value

True if all parameters are valid and exclusive; otherwise false.

Category

Watchdog Timer

Reference

R_INTC_CreateExtInterrupt, R_MCU_OFS

Remarks

- If using the Initial Setting Memory (using R_MCU_OFS) to enable the WDT from reset this function will have no effect.
- If configuring to use a NMI handler then R_INTC_CreateExtInterrupt must be used to enable the NMI for WDT.
- The timing limits depend on the frequency of the peripheral module clock, PCLKB.

$$\text{Period} = \frac{n \times \text{cycles}}{f_{PCLKB}} \text{ or } \text{Frequency} = \frac{f_{PCLKB}}{n \times \text{cycles}}$$

Where:

n = 4, 64, 128, 512, 2048, or 8192.

cycles = 1024, 4096, 8192, 16384.

Example periods are given below for $f_{PCLKB} = 50\text{MHz}$.

	Time out cycles			
	1024	4096	8192	16384
Period PCLK÷4	81.9 μs	328 μs	735 μs	1.31 ms
Period PCLK÷64	1.31 ms	5.24 ms	11.8 ms	21.0 ms
Period PCLK÷128	2.62 ms	10.5 ms	23.5 ms	41.9 ms
Period PCLK÷512	10.5 ms	41.9 ms	94.1 ms	168 ms
Period PCLK÷2048	41.9 ms	168 ms	377 ms	671 ms
Period PCLK÷8192	168 ms	671 ms	1.51s	2.68s

Program example

```

/* RPDL definitions */
#include "r_pdl_wdt.h"

/* RPDL device-specific definitions */
#include "r_pdl_definitions.h"

void func(void)
{
    /* Configure the watchdog timer for PCLKB/4,
    Timeout cycles = 4096, no windowing and reset operation.*/
    R_WDT_Set(
        PDL_WDT_PCLK_DIV_4 | PDL_WDT_TIMEOUT_4096 | \
        PDL_WDT_TIMEOUT_RESET
    );

    /* Configure the watchdog timer for PCLKB/128,
    Timeout cycles = 8192, windowing (50% to 25%) and reset
    operation.*/
    R_WDT_Set(
        PDL_WDT_PCLK_DIV_128 | PDL_WDT_TIMEOUT_8192 | \
        PDL_WDT_TIMEOUT_RESET | PDL_WDT_WIN_START_50 | \
        PDL_WDT_WIN_END_25
    );
}

```

2) R_WDT_Control

Synopsis

Control the Watchdog operation.

Prototype

```
bool R_WDT_Control(
    uint8_t data // Control selection
);
```

Description

Modify the operation of the Watchdog timer.

[data]

Control the Watchdog timer.

- Counter update

PDL_WDT_RESET_COUNTER	Refresh the counter.
-----------------------	----------------------

Return value

True if all parameters are valid and exclusive; otherwise false.

Category

Watchdog Timer

Reference

R_WDT_Set

Remarks

- R_WDT_Set must be called first to configure the timer unless using Initial Setting Memory (using R_MCU_OFS) to enable the WDT from reset.

Program example

```
/* RPDL definitions */
#include "r_pdl_wdt.h"

/* RPDL device-specific definitions */
#include "r_pdl_definitions.h"

void func(void)
{
    /* Prevent the watchdog timer from overflowing */
    R_WDT_Control(
        PDL_WDT_RESET_COUNTER
    );
}
```

3) R_WDT_Read

Synopsis

Read the Watchdog timer status.

Prototype

```
bool R_WDT_Read(
    uint16_t * data // A pointer to the data storage location
);
```

Description

Read and store the status flags and current counter value.

[data]

The timer status shall be stored in the following format.

b15	b14	b13 – b0
Refresh Error Flag 1: Refresh error 0: No refresh error	Underflow Flag 1: Underflow 0: No underflow	Down Counter Value

Return value

True.

Category

Watchdog Timer

Reference**Remarks**

- If the Underflow flag is set to 1, it shall be automatically cleared to 0 by this function.
- If the Refresh flag is set to 1, it shall be automatically cleared to 0 by this function.

Program example

```
/* RPDL definitions */
#include "r_pdl_wdt.h"

/* RPDL device-specific definitions */
#include "r_pdl_definitions.h"

uint16_t WDT_Status;

void func(void)
{
    /* Read the timer values */
    R_WDT_Read(
        &WDT_Status
    );
}
```

4.2.22. Independent Watchdog Timer

1) R_IWDT_Set

Synopsis

Configure the Independent Watchdog operation.

Prototype

```
bool R_IWDT_Set(
    uint32_t data // Configuration selection
);
```

Description

Select the operation of the Independent Watchdog timer and start it.

[data]

Configure the timer options. Use "|" to separate each value.

• Counter selection

PDL_IWDT_TIMEOUT_1024 or PDL_IWDT_TIMEOUT_4096 or PDL_IWDT_TIMEOUT_8192 or PDL_IWDT_TIMEOUT_16384	The number of cycles of the selected clock before the reset occurs.
PDL_IWDT_CLOCK_OCO_1 or PDL_IWDT_CLOCK_OCO_16 or PDL_IWDT_CLOCK_OCO_32 or PDL_IWDT_CLOCK_OCO_64 or PDL_IWDT_CLOCK_OCO_128 or PDL_IWDT_CLOCK_OCO_256	Clock division ratio selection The IWDTCLK clock ÷ 1, 16, 32, 64, 128 or 256.

• Time out control

PDL_IWDT_TIMEOUT_NMI or PDL_IWDT_TIMEOUT_RESET	If the IWDT times out, select if a Reset or an NMI Interrupt will be generated.
--	---

• Window Start Position

PDL_IWDT_WIN_START_25 or PDL_IWDT_WIN_START_50 or PDL_IWDT_WIN_START_75 or PDL_IWDT_WIN_START_100	The window start position specified as a percentage of the down counter. 0% is when the down-counter would underflow. Selecting 100% is equivalent to no window start position.
---	---

• Window End Position

PDL_IWDT_WIN_END_0 or PDL_IWDT_WIN_END_25 or PDL_IWDT_WIN_END_50 or PDL_IWDT_WIN_END_75	The window end position specified as a percentage of the down counter. 0% is when the down-counter would underflow. Hence specifying 0% is equivalent to no window end position.
---	--

• Sleep Mode Count Stop

PDL_IWDT_STOP_DISABLE or PDL_IWDT_STOP_ENABLE	Enable or disable Count stop mode. If the Count Stop mode is enabled the IWDT counter is stopped at a transition to sleep mode, software standby mode, deep software standby mode, or all-module clock stop mode.
---	--

Return value

True if all parameters are valid and exclusive; otherwise false.

Category

Independent Watchdog Timer

Reference

R_MCU_OFS, R_CGC_Set, R_CGC_Control, R_INTC_CreateExtInterrupt

Remarks

- If using the Initial Setting Memory (using R_MCU_OFS) to enable the IWDT from reset, this function will have no affect and can be omitted.
- The IWDTCLK must be enabled using R_CGC_Set or R_CGC_Control.
- If configuring to use a NMI handler then R_INTC_CreateExtInterrupt must be used to enable the NMI for IWDT.
- Call R_CGC_Set to set PCLKB clock frequency >= 4 times IWDTCLK clock frequency after division.

Program example

```
/* RPDL definitions */
#include "r_pdl_iwdt.h"

/* RPDL device-specific definitions */
#include "r_pdl_definitions.h"

void func(void)
{
    /* Configure the IWDT */
    R_IWDT_Set(
        PDL_IWDT_TIMEOUT_16384 | PDL_IWDT_CLOCK_OCO_256
    );
}
```

2) R_IWDT_Control

Synopsis

Control the Independent Watchdog operation.

Prototype

```
bool R_IWDT_Control(
    uint8_t data // Control selection
);
```

Description

Modify the operation of the Independent Watchdog timer.

[data]

Control the timer.

- Counter start / refresh

PDL_IWDT_REFRESH	Start or refresh the counter by re-loading the timeout value.
------------------	---

Return value

True if the parameter is valid; otherwise false.

Category

Independent Watchdog Timer

Reference

R_IWDT_Set

Remarks

- R_IWDT_Set must be used first to configure the timer unless using Initial Setting Memory (using R_MCU_OFS) to enable the IWDT from reset.

Program example

```
/* RPDL definitions */
#include "r_pdl_iwdt.h"

/* RPDL device-specific definitions */
#include "r_pdl_definitions.h"

void func(void)
{
    /* Refresh the IWDT */
    R_IWDT_Control(
        PDL_IWDT_REFRESH
    );
}
```

3) R_IWDT_Read

Synopsis

Read the watchdog timer status and counter.

Prototype

```
bool R_IWDT_Read(
    uint16_t * data // A pointer to the data storage location
);
```

Description

Read and store the status flags and current counter value.

[data]

The timer status shall be stored in the following format.

b15	b14	b13 – b0
Refresh Error	Underflow	Down Counter Value
0: No refresh error 1: Refresh error	0: No underflow 1: Underflow	

Return value

True.

Category

Independent Watchdog Timer

Reference

None.

Remarks

- If the Underflow flag is set to 1, it shall be automatically cleared to 0 by this function.
- If the Refresh flag is set to 1, it shall be automatically cleared to 0 by this function.

Program example

```
/* RPDL definitions */
#include "r_pdl_iwdt.h"

/* RPDL device-specific definitions */
#include "r_pdl_definitions.h"

uint16_t Status;

void func(void)
{
    /* Read the timer status */
    R_IWDT_Read(
        &Status
    );
}
```

4.2.23. Serial Communication Interface

1) R_SCI_Set

Synopsis

Configure the SCI pin selection for SCI channels where there is a choice of SCI pins.

Prototype

```
bool R_SCI_Set(
    uint8_t data1, // Channel selection
    uint16_t data2 // I/O configuration for channels 0 to 12
);
```

Description (1/5)

Configure I/O pins for all SCI channels. There is no default option.

[data1]

The channel number n (where n = 0 to 12).

[data2]

Configure the I/O pins for channels 0 to 12 (required only if the pins are used for the SCI function). Use “|” to separate each selection.

- Valid when n = 0

PDL_SCI_PIN_SCI0_RXD0_P21 or PDL_SCI_PIN_SCI0_RXD0_P33	SCI0	RXD0
PDL_SCI_PIN_SCI0_SMISO0_P21 or PDL_SCI_PIN_SCI0_SMISO0_P33		SMISO0
PDL_SCI_PIN_SCI0_SSCL0_P21 or PDL_SCI_PIN_SCI0_SSCL0_P33		SSCL0
PDL_SCI_PIN_SCI0_TXD0_P20 or PDL_SCI_PIN_SCI0_TXD0_P32		TXD0
PDL_SCI_PIN_SCI0_SMOSI0_P20 or PDL_SCI_PIN_SCI0_SMOSI0_P32		SMOSI0
PDL_SCI_PIN_SCI0_SSDA0_P20 or PDL_SCI_PIN_SCI0_SSDA0_P32		SSDA0
PDL_SCI_PIN_SCI0_SCK0_P22 or PDL_SCI_PIN_SCI0_SCK0_P34		SCK0
PDL_SCI_PIN_SCI0_CTS0_P23 or PDL_SCI_PIN_SCI0_CTS0_PJ3		CTS0
PDL_SCI_PIN_SCI0_RTS0_P23 or PDL_SCI_PIN_SCI0_RTS0_PJ3		RTS0
PDL_SCI_PIN_SCI0_SS0_P23 or PDL_SCI_PIN_SCI0_SS0_PJ3		SS0

Description (2/5)

- Valid when n = 1

PDL_SCI_PIN_SCI1_RXD1_P15 or PDL_SCI_PIN_SCI1_RXD1_P30 or PDL_SCI_PIN_SCI1_RXD1_PF2	SCI1	RXD1
PDL_SCI_PIN_SCI1_SMISO1_P15 or PDL_SCI_PIN_SCI1_SMISO1_P30 or PDL_SCI_PIN_SCI1_SMISO1_PF2		SMISO1
PDL_SCI_PIN_SCI1_SSCL1_P15 or PDL_SCI_PIN_SCI1_SSCL1_P30 or PDL_SCI_PIN_SCI1_SSCL1_PF2		SSCL1
PDL_SCI_PIN_SCI1_TXD1_P16 or PDL_SCI_PIN_SCI1_TXD1_P26 or PDL_SCI_PIN_SCI1_TXD1_PF0		TXD1
PDL_SCI_PIN_SCI1_SMOSI1_P16 or PDL_SCI_PIN_SCI1_SMOSI1_P26 or PDL_SCI_PIN_SCI1_SMOSI1_PF0		SMOSI1
PDL_SCI_PIN_SCI1_SSDA1_P16 or PDL_SCI_PIN_SCI1_SSDA1_P26 or PDL_SCI_PIN_SCI1_SSDA1_PF0		SSDA1
PDL_SCI_PIN_SCI1_SCK1_P17 or PDL_SCI_PIN_SCI1_SCK1_P27 or PDL_SCI_PIN_SCI1_SCK1_PF1		SCK1
PDL_SCI_PIN_SCI1_CTS1_P14 or PDL_SCI_PIN_SCI1_CTS1_P31		CTS1
PDL_SCI_PIN_SCI1_RTS1_P14 or PDL_SCI_PIN_SCI1_RTS1_P31		RTS1
PDL_SCI_PIN_SCI1_SS1_P14 or PDL_SCI_PIN_SCI1_SS1_P31		SS1

- Valid when n = 2

PDL_SCI_PIN_SCI2_RXD2_P12 or PDL_SCI_PIN_SCI2_RXD2_P52	SCI2	RXD2
PDL_SCI_PIN_SCI2_SMISO2_P12 or PDL_SCI_PIN_SCI2_SMISO2_P52		SMISO2
PDL_SCI_PIN_SCI2_SSCL2_P12 or PDL_SCI_PIN_SCI2_SSCL2_P52		SSCL2
PDL_SCI_PIN_SCI2_TXD2_P13 or PDL_SCI_PIN_SCI2_TXD2_P50		TXD2
PDL_SCI_PIN_SCI2_SMOSI2_P13 or PDL_SCI_PIN_SCI2_SMOSI2_P50		SMOSI2
PDL_SCI_PIN_SCI2_SSDA2_P13 or PDL_SCI_PIN_SCI2_SSDA2_P50		SSDA2
PDL_SCI_PIN_SCI2_SCK2_P11 or PDL_SCI_PIN_SCI2_SCK2_P51		SCK2
PDL_SCI_PIN_SCI2_CTS2_P54		CTS2
PDL_SCI_PIN_SCI2_RTS2_P54		RTS2
PDL_SCI_PIN_SCI2_SS2_P54		SS2

Description (3/5)

- Valid when n = 3

PDL_SCI_PIN_SCI3_RXD3_P16 or PDL_SCI_PIN_SCI3_RXD3_P25	SCI3	RXD3
PDL_SCI_PIN_SCI3_SMISO3_P16 or PDL_SCI_PIN_SCI3_SMISO3_P25		SMISO3
PDL_SCI_PIN_SCI3_SSCL3_P16 or PDL_SCI_PIN_SCI3_SSCL3_P25		SSCL3
PDL_SCI_PIN_SCI3_TXD3_P17 or PDL_SCI_PIN_SCI3_TXD3_P23		TXD3
PDL_SCI_PIN_SCI3_SMOSI3_P17 or PDL_SCI_PIN_SCI3_SMOSI3_P23		SMOSI3
PDL_SCI_PIN_SCI3_SSDA3_P17 or PDL_SCI_PIN_SCI3_SSDA3_P23		SSDA3
PDL_SCI_PIN_SCI3_SCK3_P15 or PDL_SCI_PIN_SCI3_SCK3_P24		SCK3
PDL_SCI_PIN_SCI3_CTS3_P26		CTS3
PDL_SCI_PIN_SCI3_RTS3_P26		RTS3
PDL_SCI_PIN_SCI3_SS3_P26		SS3

- Valid when n = 4

PDL_SCI_PIN_SCI4_RXD4_PB0	SCI4	RXD4
PDL_SCI_PIN_SCI4_SMISO4_PB0		SMISO4
PDL_SCI_PIN_SCI4_SSCL4_PB0		SSCL4
PDL_SCI_PIN_SCI4_TXD4_PB1		TXD4
PDL_SCI_PIN_SCI4_SMOSI4_PB1		SMOSI4
PDL_SCI_PIN_SCI4_SSDA4_PB1		SSDA4
PDL_SCI_PIN_SCI4_SCK4_PB3		SCK4
PDL_SCI_PIN_SCI4_CTS4_PB2		CTS4
PDL_SCI_PIN_SCI4_RTS4_PB2		RTS4
PDL_SCI_PIN_SCI4_SS4_PB2		SS4

- Valid when n = 5

PDL_SCI_PIN_SCI5_RXD5_PA2 or PDL_SCI_PIN_SCI5_RXD5_PA3 or PDL_SCI_PIN_SCI5_RXD5_PC2	SCI5	RXD5
PDL_SCI_PIN_SCI5_SMISO5_PA2 or PDL_SCI_PIN_SCI5_SMISO5_PA3 or PDL_SCI_PIN_SCI5_SMISO5_PC2		SMISO5
PDL_SCI_PIN_SCI5_SSCL5_PA2 or PDL_SCI_PIN_SCI5_SSCL5_PA3 or PDL_SCI_PIN_SCI5_SSCL5_PC2		SSCL5
PDL_SCI_PIN_SCI5_TXD5_PA4 or PDL_SCI_PIN_SCI5_TXD5_PC3		TXD5
PDL_SCI_PIN_SCI5_SMOSI5_PA4 or PDL_SCI_PIN_SCI5_SMOSI5_PC3		SMOSI5
PDL_SCI_PIN_SCI5_SSDA5_PA4 or PDL_SCI_PIN_SCI5_SSDA5_PC3		SSDA5
PDL_SCI_PIN_SCI5_SCK5_PA1 or PDL_SCI_PIN_SCI5_SCK5_PC1 or PDL_SCI_PIN_SCI5_SCK5_PC4		SCK5
PDL_SCI_PIN_SCI5_CTS5_PA6 or PDL_SCI_PIN_SCI5_CTS5_PC0		CTS5
PDL_SCI_PIN_SCI5_RTS5_PA6 or PDL_SCI_PIN_SCI5_RTS5_PC0		RTS5
PDL_SCI_PIN_SCI5_SS5_PA6 or PDL_SCI_PIN_SCI5_SS5_PC0		SS5

Description (4/5)

- Valid when n = 6

PDL_SCI_PIN_SCI6_RXD6_P01 or PDL_SCI_PIN_SCI6_RXD6_P33 or PDL_SCI_PIN_SCI6_RXD6_PB0	SCI6	RXD6
PDL_SCI_PIN_SCI6_SMISO6_P01 or PDL_SCI_PIN_SCI6_SMISO6_P33 or PDL_SCI_PIN_SCI6_SMISO6_PB0		SMISO6
PDL_SCI_PIN_SCI6_SSCL6_P01 or PDL_SCI_PIN_SCI6_SSCL6_P33 or PDL_SCI_PIN_SCI6_SSCL6_PB0		SSCL6
PDL_SCI_PIN_SCI6_TXD6_P00 or PDL_SCI_PIN_SCI6_TXD6_P32 or PDL_SCI_PIN_SCI6_TXD6_PB1		TXD6
PDL_SCI_PIN_SCI6_SMOSI6_P00 or PDL_SCI_PIN_SCI6_SMOSI6_P32 or PDL_SCI_PIN_SCI6_SMOSI6_PB1		SMOSI6
PDL_SCI_PIN_SCI6_SSDA6_P00 or PDL_SCI_PIN_SCI6_SSDA6_P32 or PDL_SCI_PIN_SCI6_SSDA6_PB1		SSDA6
PDL_SCI_PIN_SCI6_SCK6_P02 or PDL_SCI_PIN_SCI6_SCK6_P34 or PDL_SCI_PIN_SCI6_SCK6_PB3		SCK6
PDL_SCI_PIN_SCI6_CTS6_PB2 or PDL_SCI_PIN_SCI6_CTS6_PJ3		CTS6
PDL_SCI_PIN_SCI6_RTS6_PB2 or PDL_SCI_PIN_SCI6_RTS6_PJ3		RTS6
PDL_SCI_PIN_SCI6_SS6_PB2 or PDL_SCI_PIN_SCI6_SS6_PJ3		SS6

- Valid when n = 7

PDL_SCI_PIN_SCI7_RXD7_P92	SCI7	RXD7
PDL_SCI_PIN_SCI7_SMISO7_P92		SMISO7
PDL_SCI_PIN_SCI7_SSCL7_P92		SSCL7
PDL_SCI_PIN_SCI7_TXD7_P90		TXD7
PDL_SCI_PIN_SCI7_SMOSI7_P90		SMOSI7
PDL_SCI_PIN_SCI7_SSDA7_P90		SSDA7
PDL_SCI_PIN_SCI7_SCK7_P91		SCK7
PDL_SCI_PIN_SCI7_CTS7_P93		CTS7
PDL_SCI_PIN_SCI7_RTS7_P93		RTS7
PDL_SCI_PIN_SCI7_SS7_P93		SS7

- Valid when n = 8

PDL_SCI_PIN_SCI8_RXD8_PC6	SCI8	RXD8
PDL_SCI_PIN_SCI8_SMISO8_PC6		SMISO8
PDL_SCI_PIN_SCI8_SSCL8_PC6		SSCL8
PDL_SCI_PIN_SCI8_TXD8_PC7		TXD8
PDL_SCI_PIN_SCI8_SMOSI8_PC7		SMOSI8
PDL_SCI_PIN_SCI8_SSDA8_PC7		SSDA8
PDL_SCI_PIN_SCI8_SCK8_PC5		SCK8
PDL_SCI_PIN_SCI8_CTS8_PC4		CTS8
PDL_SCI_PIN_SCI8_RTS8_PC4		RTS8
PDL_SCI_PIN_SCI8_SS8_PC4		SS8

- Valid when n = 9

PDL_SCI_PIN_SCI9_RXD9_PB6	SCI9	RXD9
PDL_SCI_PIN_SCI9_SMISO9_PB6		SMISO9
PDL_SCI_PIN_SCI9_SSCL9_PB6		SSCL9
PDL_SCI_PIN_SCI9_TXD9_PB7		TXD9
PDL_SCI_PIN_SCI9_SMOSI9_PB7		SMOSI9
PDL_SCI_PIN_SCI9_SSDA9_PB7		SSDA9
PDL_SCI_PIN_SCI9_SCK9_PB5		SCK9
PDL_SCI_PIN_SCI9_CTS9_PB4		CTS9
PDL_SCI_PIN_SCI9_RTS9_PB4		RTS9
PDL_SCI_PIN_SCI9_SS9_PB4		SS9

Description (5/5)

- Valid when n = 10

PDL_SCI_PIN_SCI10_RXD10_P81	SCI10	RXD10
PDL_SCI_PIN_SCI10_SMISO10_P81		SMISO10
PDL_SCI_PIN_SCI10_SSCL10_P81		SSCL10
PDL_SCI_PIN_SCI10_TXD10_P82		TXD10
PDL_SCI_PIN_SCI10_SMOSI10_P82		SMOSI10
PDL_SCI_PIN_SCI10_SSDA10_P82		SSDA10
PDL_SCI_PIN_SCI10_SCK10_P80		SCK10
PDL_SCI_PIN_SCI10_CTS10_P83		CTS10
PDL_SCI_PIN_SCI10_RTS10_P83		RTS10
PDL_SCI_PIN_SCI10_SS10_P83		SS10

- Valid when n = 11

PDL_SCI_PIN_SCI11_RXD11_P76	SCI11	RXD11
PDL_SCI_PIN_SCI11_SMISO11_P76		SMISO11
PDL_SCI_PIN_SCI11_SSCL11_P76		SSCL11
PDL_SCI_PIN_SCI11_TXD11_P77		TXD11
PDL_SCI_PIN_SCI11_SMOSI11_P77		SMOSI11
PDL_SCI_PIN_SCI11_SSDA11_P77		SSDA11
PDL_SCI_PIN_SCI11_SCK11_P75		SCK11
PDL_SCI_PIN_SCI11_CTS11_P74		CTS11
PDL_SCI_PIN_SCI11_RTS11_P74		RTS11
PDL_SCI_PIN_SCI11_SS11_P74		SS11

- Valid when n = 12

PDL_SCI_PIN_SCI12_RXD12_PE2	SCI12	RXD12
PDL_SCI_PIN_SCI12_SMISO12_PE2		SMISO12
PDL_SCI_PIN_SCI12_SSCL12_PE2		SSCL12
PDL_SCI_PIN_SCI12_TXD12_PE1		TXD12
PDL_SCI_PIN_SCI12_SMOSI12_PE1		SMOSI12
PDL_SCI_PIN_SCI12_SSDA12_PE1		SSDA12
PDL_SCI_PIN_SCI12_SCK12_PE0		SCK12
PDL_SCI_PIN_SCI12_CTS12_PE3		CTS12
PDL_SCI_PIN_SCI12_RTS12_PE3		RTS12
PDL_SCI_PIN_SCI12_SS12_PE3		SS12

Return value

True if all parameters are valid and exclusive; otherwise false.

Category

SCI

Reference

R_SCI_Create

Remarks

- Before calling R_SCI_Create, call this function to configure the relevant pins.
- Please refer to the "Multifunction Pin Controller (MPC)" section in the RX63N Hardware Manual for details of SCI pin selection.
- Pins which are not used for the SCI functions may be omitted.
- This function configures each specified SCI pin. It also disables the alternative modes on those pins.
- Device packages with 145 or fewer pins do not have all of the pin options.

Program example

```
#include "r_pdl_sci.h"

void func(void)
{
    /* Configure RXD1 and TXD1 pins*/
    R_SCI_Set(
        1,
        PDL_SCI_PIN_SCI11_RXD1_P15 | PDL_SCI_PIN_SCI11_TXD1_P16
    );
}
```

2) R_SCI_Create

Synopsis

SCI channel setup.

Prototype

```
bool R_SCI_Create(
    uint8_t data1, // Channel selection
    uint32_t data2, // Channel configuration
    uint32_t data3, // Bit rate or register value
    uint8_t data4, // Interrupt priority level
    uint8_t data5 // Interrupt priority level
);
```

Description (1/4)

Set up the selected SCI channel.

[data1]

Select channel SCIn (where n = 0 to 12).

[data2]

Configure the channel. If multiple selections are required, use “|” to separate each selection. The default settings are shown in **bold**.

• Operation mode

PDL_SCI_ASYNC or PDL_SCI_SYNC or PDL_SCI_SMART or PDL_SCI_ASYNC_MP	Choose between Asynchronous, Clock synchronous (includes SPI and IIC), Smart Card Interface or Multi-Processor Asynchronous operation.
---	--

• Transmit / Receive connections (Not applicable in IIC Mode, option will be ignored.)

PDL_SCI_TX_CONNECTED or PDL_SCI_TX_DISCONNECTED	The TXDn output is required / not required.
PDL_SCI_RX_CONNECTED or PDL_SCI_RX_DISCONNECTED	The RXDn input is required / not required.

• Data transfer format (Not applicable in IIC Mode, option will be ignored.)

PDL_SCI_LSB_FIRST or PDL_SCI_MSB_FIRST	Select least or most significant bit first.
--	---

Options which are available in Asynchronous mode or Multi-Processor Asynchronous mode

• Noise Filter

PDL_SCI_RX_FILTER_DISABLE or PDL_SCI_RX_FILTER_ENABLE	Enable or disable the Digital Noise Filter on the RXDn pin.
---	---

• Hardware Flow Control

PDL_SCI_HW_FLOW_NONE or PDL_SCI_HW_FLOW_CTS or PDL_SCI_HW_FLOW_RTS	Select the Hardware Flow Control Option. Note: CTS and RTS functions cannot both be used as they share the same pin.
---	--

• Data clock source selection

PDL_SCI_CLK_INT_IO or PDL_SCI_CLK_INT_OUT or PDL_SCI_CLK_EXT or PDL_SCI_CLK_TMR	Select the on-chip baud rate generator. SCKn pin: available as an I/O pin. SCKn pin: SCI bit clock output. Input a clock of 8 or 16 times the desired bit rate to the SCKn pin. See parameter data3 for the multiplier selection. For SCI5, select Timer output TMO0, TMO1. For SCI6, select Timer output TMO2, TMO3. For SCI12, select Timer output TMO0, TMO1. The SCKn pin is set to high-impedance.
---	---

• Data length

PDL_SCI_8_BIT_LENGTH or PDL_SCI_7_BIT_LENGTH	8- or 7-bit data length.
--	--------------------------

• Parity mode

PDL_SCI_PARITY_NONE or PDL_SCI_PARITY_EVEN or PDL_SCI_PARITY_ODD	No parity bit, even parity bit or odd parity bit. Note: Do not set parity bit for Multi-Processor Asynchronous mode.
---	--

Description (2/4)

- Stop bit length

PDL_SCI_STOP_1 or PDL_SCI_STOP_2	One or two stop bits.
---	-----------------------

The option "PDL_SCI_8N1" can be used to select 8-bit data length, no parity and one stop bit.

Options which are available in all Clock Synchronous modes (including IIC and SPI)

- SPI mode selection

PDL_SCI_SPI_MODE	SPI Mode selected: Use the R_SCI_SPI_Transfer function, not R_SCI_Send or R_SCI_Receive.
-------------------------	--

- IIC mode selection

PDL_SCI_IIC_MODE	IIC Mode selected: Use the functions R_SCI_IIC_Read and R_SCI_IIC_Write, not R_SCI_Send or R_SCI_Receive.
-------------------------	---

Options which are available in Clock Synchronous and SPI mode

- Data clock source selection

PDL_SCI_CLK_INT_OUT or	Select the On-chip baud rate generator. The SCKn pin outputs the bit clock. (In SPI Mode this is Master mode.)
PDL_SCI_CLK_EXT	Input the clock to the SCKn pin. (In SPI Mode this is Slave mode.)

- SPI Clock Polarity Inversion.

PDL_SCI_CLOCK_POLARITY_INVERTED	The SCK clock is inverted.
--	----------------------------

- SPI Clock Phase Delay

PDL_SCI_CLOCK_PHASE_DELAYED	The SCK clock is delayed.
------------------------------------	---------------------------

Options which are available in Clock Synchronous mode (Not SPI or IIC)

- Hardware Flow Control

PDL_SCI_HW_FLOW_NONE or PDL_SCI_HW_FLOW_CTS or PDL_SCI_HW_FLOW_RTS	Select the Hardware Flow Control Option. Notes: <ul style="list-style-type: none"> • CTS can only be selected if using an internal clock source for SCLK. • RTS can only be selected if using external clock source for SCLK.
---	---

Options which are available in SPI mode

- SPI SS Pin

PDL_SCI_SPI_SS_DISABLE or	The SS pin is not used (Single master environment).
PDL_SCI_SPI_SS_ENABLE	The SS pin is used. Note: This option is not available if using SPI Master mode, if selected the function will return false.

- Data inversion

PDL_SCI_INVERSION_OFF or PDL_SCI_INVERSION_ON	Control data inversion (transmission and reception).
--	--

Description (3/4)

Options which are available in IIC mode

- Noise Filter Clock Select

PDL_SCI_IIC_FILTER_DISABLED or	The noise filter is disabled.
PDL_SCI_IIC_FILTER_CLOCK_DIV1 or PDL_SCI_IIC_FILTER_CLOCK_DIV2 or PDL_SCI_IIC_FILTER_CLOCK_DIV4 or PDL_SCI_IIC_FILTER_CLOCK_DIV8	The clock signal ÷ 1, 2, 4 or 8 is used with the noise filter.

- SSDA Delay Output Select (Delay on SDA Pin relative to SCL pin.)

PDL_SCI_IIC_DELAY_SDA_0_1 or	0 to 1 cycle delay
PDL_SCI_IIC_DELAY_SDA_1_2 or	1 to 2 cycle delay
PDL_SCI_IIC_DELAY_SDA_2_3 or	2 to 3 cycle delay
... (sequence continues)	...
PDL_SCI_IIC_DELAY_SDA_29_30 or	29 to 30 cycle delay
PDL_SCI_IIC_DELAY_SDA_30_31	30 to 31 cycle delay

Options which are available in Smart Card Interface mode

- Data inversion

PDL_SCI_INVERSION_OFF or PDL_SCI_INVERSION_ON	Control data inversion (transmission and reception).
---	--

- Base clock pulse cycle count

PDL_SCI_BCP_32 or PDL_SCI_BCP_64 or PDL_SCI_BCP_93 or PDL_SCI_BCP_128 or PDL_SCI_BCP_186 or PDL_SCI_BCP_256 or PDL_SCI_BCP_372 or PDL_SCI_BCP_512	The number of base clock cycles in a 1-bit data transfer period.
---	--

- Parity selection

PDL_SCI_PARITY_EVEN or PDL_SCI_PARITY_ODD	Select even or odd parity bit.
---	--------------------------------

- Block transfer mode selection

PDL_SCI_BLOCK_MODE_OFF or PDL_SCI_BLOCK_MODE_ON	Control Block transfer mode.
---	------------------------------

- GSM mode selection

PDL_SCI_GSM_MODE_OFF or PDL_SCI_GSM_MODE_ON	Control GSM mode.
---	-------------------

- SCKn pin output control

Note how the default option changes depending upon the mode. In Normal Mode the default is an I/O Pin. In GSM Mode the default is Fixed Low.

	Normal mode	GSM mode
PDL_SCI_SCK_OUTPUT_OFF or	I/O pin	Not applicable
PDL_SCI_SCK_OUTPUT_LOW or	Not applicable.	Fixed low.
PDL_SCI_SCK_OUTPUT_ON or	Outputs the bit clock.	
PDL_SCI_SCK_OUTPUT_HIGH	Not applicable	Fixed high.

Remarks

- Function R_CGC_Set must be called (with the current clock source selected) before using this function.
- Function R_SCI_Set must be called before any use of this function.
- This function configures each SCI pin that is required for operation. It also disables the alternative modes on those pins.
- In Async and Async MP modes the Tx pin is initially set to the Mark state. The R_SCI_Control function can subsequently be used to set the Space state.
- SPI Multi-Master mode is not supported. Hence, in SPI Master mode the SS pin cannot be enabled.
- Device packages with 100 or fewer pins do not have all of the SCI channels.
- If the option of using a delayed clock phase is selected in synchronous mode then a delay is required following the final receive interrupt before the operation can be completed. This delay is implemented as a software loop in the SCI RXI interrupt routine. See source file Interrupt_SCI.c for details.
- The range of achievable bit rates (bps) is listed below.

Mode	Data clock source	Limit	f _{PCLKB}				
			50 MHz	32 MHz	12.5 MHz	12 MHz	8 MHz
Asynchronous	Internal	Minimum	96	62	24	23	16
		Maximum	3,125,000	2,000,000	781,250	750,000	500,000
	External	Maximum	1,562,500	1,000,000	390,625	375,000	250,000
Synchronous	Internal	Minimum	763	489	191	184	123
		Maximum	6,250,000	4,000,000	1,562,500	1,500,000	1,000,000
	External	Maximum	8,333,333	5,333,333	2,083,333	2,000,000	1,333,333
Smart card	Internal	Minimum	3	2	1	1	1
		Maximum	781,250	500,000	195,312	187,500	125,000

Program example

```

/* RPDL definitions */
#include "r_pdl_sci.h"

/* RPDL device-specific definitions */
#include "r_pdl_definitions.h"

void func(void)
{
    /* Configure SCI0 for asynchronous, 8N1, 38400 baud */
    R_SCI_Create(
        0,
        PDL_SCI_ASYNC | PDL_SCI_8N1,
        38400,
        1,
        0
    );

    /* Configure SCI1 for asynchronous, 8N1, register values supplied */
    R_SCI_Create(
        1,
        PDL_SCI_ASYNC | PDL_SCI_8N1,
        BIT_31 | PDL_SCI_PCLK_DIV_1 | PDL_SCI_CYCLE_BIT_16 | \
        (115200 & 0x00FFFF00) | 0x50,
        1,
        0
    );
}

```

3) R_SCI_Destroy**Synopsis**

Shut down a SCI channel.

Prototype

```
bool R_SCI_Destroy(
    uint8_t data // Channel selection
);
```

Description

Stop data flow and shutdown the selected SCI channel.

[data]

Select channel SCIn (where n = 0 to 12).

Return value

True if all parameters are valid; otherwise false.

Category

SCI

Reference

None.

Remarks

- The SCI channel is put into the power-down state.
- Device packages with 100 or fewer pins do not have all of the SCI channels.

Program example

```
/* RPDL definitions */
#include "r_pdl_sci.h"

/* RPDL device-specific definitions */
#include "r_pdl_definitions.h"

void func(void)
{
    /* Shutdown SCI channel 1 */
    R_SCI_Destroy(
        1
    );
}
```

4) R_SCI_Send

Synopsis

Transmit data on a SCI channel.

Prototype

```
bool R_SCI_Send(
    uint8_t data1, // Channel selection
    uint16_t data2, // Channel configuration (and Target Station ID)
    uint8_t * data3, // Data start address
    uint16_t data4, // Data count
    void * func // Callback function
);
```

Description

Transmit data on the specified serial channel.

[data1]

Select channel SCIn (where n = 0 to 12).

[data2]

Control options.

The default options are shown in **bold**. Specify PDL_NO_DATA to use the defaults.

- DMAC / DTC trigger control.

PDL_SCI_DMTC_TRIGGER_DISABLE or PDL_SCI_DMTC_TRIGGER_ENABLE or PDL_SCI_DTC_TRIGGER_ENABLE	Disable or enable activation of the DMAC or DTC when a data byte is transmitted.
--	--

- ID transmission control (valid only in Multi-processor mode).

PDL_SCI_MP_ID_CYCLE	Transmit the upper byte as the ID byte. The valid ID range is 0 to 255.
----------------------------	--

[data3]

The start address of the data to be sent.

Specify PDL_NO_PTR for the ID cycle in Multi-processor mode.

If the DMAC or DTC shall be used to transfer the data, specify PDL_NO_PTR.

[data4]

For sending binary data, set this to the number of bytes to be sent.

The valid range is 1 to 65535.

Set this to 0 for transmission of a null-terminated character string.

For the ID cycle in Multi-processor mode, specify 0.

If the DMAC or DTC shall be used to transfer the data, specify PDL_NO_DATA.

[func]

Specify PDL_NO_FUNC or a callback function name, depending on the required transfer method.

Use R_SCI_Control to terminate this operation early.

R_SCI_GetStatus can be used to find out how many characters have been transmitted.

Transfer method	Parameter
Polling	PDL_NO_FUNC. This function will continue until the required number of bytes has been sent.
Interrupts	The function to be called when the last byte has been sent.
DMAC	Either the function to be called when each byte is sent, or PDL_NO_FUNC if the callback function specified in R_DMTC_Create will be used.
DTC	The function to be called at the interval specified in R_DTC_Create.

Return value

True if all parameters are valid and the operation completed without errors;

False if a parameter was out of range or if the channel was already transmitting or if an error occurred during transmission.

Category

SCI

Reference

R_SCI_Control, R_SCI_GetStatus

Remarks

- The compiler adds a null character to the end of string constants.
- If a callback function is specified, transmission interrupts are used. Please see the notes on callback function usage in §6.
- If polling mode is used, the TXI and TEND flags will be used to manage the data transmission.
If the SCI channel's control registers are directly modified by the user, this function may lock up.
- The maximum number of characters to be transmitted is 65535.
- A callback function is executed by the interrupt processing function. This means that no other interrupt can be processed until the callback function has completed.
- If reception is enabled and receive errors occur, transmission will be blocked until the errors are cleared.
- In Multi-processor mode, R_SCI_Send is to be called in pair: the first one is to send ID (ID cycle); the second one is to send data (Data cycle). For ID transmission, it will be sent by internal polling operation. For Data transmission, it will be the same as normal Asynchronous mode.
For a usage example of Multi-processor mode, please refer to section 5.17.7.
- For ID cycle, the DMAC / DTC trigger control and the callback function will be ignored.
- Do not use this function in SPI mode, use R_SCI_SPI_Transfer.
- Do not use this function in IIC mode, use R_SCI_IIC_Write.
- When using interrupts to manage the transfer, if the channel is operating in synchronous mode, transmit only and with an external clock, the TXD pin may need to be held active for longer (up to half a bit period) to avoid violating the data hold time for the receiving device. If a delay is required, the user should refer to the comments in the Transmit End interrupt processing routines (in the file interrupt_SCI.c in the i_src folder) and implement the delay in a way that is suitable for their application.
- If using the DMAC or DTC this module does not know when the transmission has ended. Therefore when it has completed the user must call the R_SCI_Control function with option PDL_SCI_STOP_TX to manually disable the transmission.
- If a callback function is specified and the interrupt priority level is zero this function will return false.
- Device packages with 100 or fewer pins do not have all of the SCI channels.

Program example

```
/* RPDL definitions */
#include "r_pdl_sci.h"

/* RPDL device-specific definitions */
#include "r_pdl_definitions.h"

void func( void )
{
    uint8_t data_store[100];

    /* Send a string on channel 1 */
    R_SCI_Send(
        1,
        PDL_NO_DATA,
        "Renesas RX",
        0,
        PDL_NO_FUNC
    );

    /* Send 50 bytes of binary data on channel 1 */
    R_SCI_Send(
        1,
        PDL_NO_DATA,
        data_store,
        50,
        PDL_NO_FUNC
    );

    /* Send the ID byte (0x0A, shifted into the upper byte) */
    R_SCI_Send(
        2,
        PDL_SCI_MP_ID_CYCLE | 0x0A00,
        PDL_NO_PTR,
        0,
        PDL_NO_FUNC
    );
}
```

5) R_SCI_Receive

Synopsis

Receive data on a SCI channel.

Prototype

```
bool R_SCI_Receive(
    uint8_t data1, // Channel selection
    uint16_t data2, // Channel configuration (and Station ID of receiving device)
    uint8_t * data3, // Data start address
    uint16_t data4, // Receive threshold
    void * func1, // Callback function
    void * func2 // Callback function
);
```

Description

Enable SCI reception and acquire any incoming data.

[data1]

Select channel SCIn (where n = 0 to 12).

[data2]

Control options.

The default options are shown in **bold**. Specify PDL_NO_DATA to use the defaults.

- DMAC / DTC trigger control

PDL_SCI_DMTC_TRIGGER_DISABLE or PDL_SCI_DMTC_TRIGGER_ENABLE or PDL_SCI_DTC_TRIGGER_ENABLE	Disable or enable activation of the DMAC or DTC when a data byte is received.
--	---

- Continuous receive mode (valid only in asynchronous mode)

PDL_SCI_RX_CONTINUOUS_DISABLE or PDL_SCI_RX_CONTINUOUS_ENABLE	Disable or enable the continuous receive when interrupt is used as the receive method.
---	--

- ID reception control (valid only in Multi-processor mode).

PDL_SCI_MP_ID_CYCLE	Use the upper byte as the station ID. The valid ID range is 0 to 255.
---------------------	---

[data3]

The start address of the storage area for the expected data.

Specify PDL_NO_PTR if no data shall be processed by this function e.g. if the DMAC or DTC shall be used to process the received data, or for ID cycle in Multi-processor mode.

[data4]

The number of bytes that must be received before the function completes or the callback function is called.

Specify 0 for the ID cycle in Multi-processor mode.

If the DMAC or DTC shall be used to handle the received data, specify PDL_NO_DATA.

[func1]

Specify PDL_NO_FUNC or a callback function name, depending on the required transfer method.

Transfer method	Parameter
Polling	PDL_NO_FUNC. This function will continue until the required number of bytes has been received.
Interrupts	The function to be called when the number of received bytes reaches the threshold number.
DMAC	Either the function to be called when each byte is received, or PDL_NO_FUNC if the callback function specified in R_DMTC_Create will be used.
DTC	The function to be called at the interval specified in R_DTC_Create.

[func2]

The function to be called if a receive error occurs. Specify PDL_NO_FUNC to ignore errors.

Return value	True if all parameters are valid and the operation completed; false if a parameter was out of range.
Category	SCI
Reference	R_SCI_Control, R_SCI_GetStatus, R_SCI_Create, R_SCI_Send
Remarks	<ul style="list-style-type: none"> • The maximum number of characters to be received is 65535. • Wait until a transmission on the same channel is complete before calling this function. • If callback function func1 is specified, reception interrupts are used. Please see the notes on callback function usage in §6. • If polling mode is used, the RXI flag will be used to manage the data reception. If the SCI channel's control registers are directly modified by the user, this function may lock up. • If no error callback function func2 is specified, the error flags are cleared automatically to allow the reception process to complete. • Callback functions are executed by the interrupt processing function. This means that no other interrupt can be processed until a callback function has completed. • In Multi-processor mode, R_SCI_Receive is to be called in a pair: the first one is to receive ID (ID cycle); the second one is to receive data (Data cycle). For ID reception, it could be done by reception interrupt (by specifying func1), or by internal polling operation (without specifying func1). For Data reception, it will be the same as normal Asynchronous mode. For a usage example of Multi-processor mode, please refer to section 5.17.6. • For the ID cycle, the DMAC / DTC trigger control will be ignored. • In synchronous mode, if both the Tx Data and the Rx Data pins have been enabled (when R_SCI_Create was called), then a reception must be performed in conjunction with a corresponding transmission. This is achieved by calling R_SCI_Receive (in non-polling mode) and then R_SCI_Send. Please refer to the usage example in Section 5.17.5. • Do not use this function in SPI mode; use R_SCI_SPI_Transfer. • Do not use this function in IIC mode; use R_SCI_IIC_Read. • If using the DMAC or DTC this module does not know when the reception has ended. Therefore when it has completed the user must call the R_SCI_Control function with option PDL_SCI_STOP_RX to manually disable the reception. • If a callback function func 1 is specified and the interrupt priority level is zero, this function will return false. • If PDL_SCI_RX_CONTINUOUS_ENABLE is selected, when next group of data is received after callback function, the data will be store to the top of receive buffer (data3). • Device packages with 100 or fewer pins do not have all of the SCI channels.

Program example

```
/* PDL functions */
#include "r_pdl_sci.h"

/* RPDL device-specific definitions */
#include "r_pdl_definitions.h"

volatile uint8_t SCI1ReceiveBuffer[10];

/* SCI channel 1 receive data handler */
void SCI1RxFunc(void){}

/* SCI channel 1 error handler */
void SCI1ErrFunc(void){}

void func( void )
{
    uint8_t temp;

    /* Wait for 1 character to be received on channel 0 */
    R_SCI_Receive(
        0,
        PDL_NO_DATA,
        &temp,
        1,
        PDL_NO_FUNC,
        PDL_NO_FUNC
    );

    /* Start the reception of 9 characters on channel 1 */
    R_SCI_Receive(
        1,
        PDL_NO_DATA,
        SCI1ReceiveBuffer,
        9,
        SCI1RxFunc,
        SCI1ErrFunc
    );
}
```

6) R_SCI_SPI_Transfer

Synopsis

Perform an SPI transfer on an SCI channel.

Prototype

```
bool R_SCI_SPI_Transfer(
    uint8_t data1, // Channel selection
    uint16_t data2, // Channel configuration
    uint16_t data3, // Number of bytes to transfer
    uint8_t * data4, // Data transmit buffer
    void * func1, // Callback function, Transmit Done
    uint8_t * data5, // Data receive buffer
    void * func2, // Callback function, Receive Done
    void * func3 // Callback function, Error
);
```

Description (1/2)

Perform an SPI transfer. This may be sending, receiving or both sending and receiving data.

[data1]

Select channel SCIn (where n = 0 to 12).

[data2]

Control options.

The default options are shown in **bold**. Specify PDL_NO_DATA to use the defaults.

- DMAC / DTC trigger control

PDL_SCI_SPI_TX_DMTC_TRIGGER_DISABLE or PDL_SCI_SPI_TX_DMTC_TRIGGER_ENABLE or PDL_SCI_SPI_TX_DTC_TRIGGER_ENABLE	Disable or enable activation of the DMAC or DTC when a data byte is transmitted.
---	--

- DMAC / DTC trigger control

PDL_SCI_SPI_RX_DMTC_TRIGGER_DISABLE or PDL_SCI_SPI_RX_DMTC_TRIGGER_ENABLE or PDL_SCI_SPI_RX_DTC_TRIGGER_ENABLE	Disable or enable activation of the DMAC or DTC when a data byte is received.
---	---

[data3]

The number of bytes that must be transferred (either transmitted, received or both) before the function completes or the callback function is called.

If the DMAC or DTC shall be used to handle the received data, specify PDL_NO_DATA.

[data4]

The start address of the storage area for the expected data.

Specify PDL_NO_PTR if not transmitting data or if no data shall be processed by this function e.g. if the DMAC or DTC shall be used to process the received data.

[func1]

Transmit callback. Specify PDL_NO_FUNC or a callback function name, depending on the required transfer method.

Transfer method	Parameter
Polling	PDL_NO_FUNC. This function will continue until the required number of bytes has been sent.
Interrupts	The function to be called when the last byte has been sent.
DMAC	Either the function to be called when each byte is sent, or PDL_NO_FUNC if the callback function specified in R_DMTC_Create will be used.
DTC	The function to be called at the interval specified in R_DTC_Create.

[data5]

The start address of the storage area for the expected data.

Specify PDL_NO_PTR if not receiving data or if no data shall be processed by this function e.g. if the DMAC or DTC shall be used to process the received data.

Description (2/2)**[func2]**

Receive callback. Specify PDL_NO_FUNC or a callback function name, depending on the required transfer method.

Transfer method	Parameter
Polling	PDL_NO_FUNC. This function will continue until the required number of bytes has been received.
Interrupts	The function to be called when the number of received bytes reaches the threshold number.
DMAC	Either the function to be called when each byte is received, or PDL_NO_FUNC if the callback function specified in R_DMACE_Create will be used.
DTC	The function to be called at the interval specified in R_DTC_Create.

[func3]

The function to be called if a receive error occurs. Specify PDL_NO_FUNC to ignore errors.

Return value

In Polling Mode:

True if all parameters are valid and the operation completed OK; false if a parameter was out of range or an error was detected.

In Non-Polling mode:

True if all parameters are valid; false if a parameter was out of range.

Category

SCI

Reference

R_SCI_Control, R_SCI_GetStatus

Remarks

- The maximum number of characters to be received or transmitted is 65535.
- Wait until a transmission on the same channel is complete before calling this function.
- If no error callback function (func3) is specified, the error flags are cleared automatically to allow the reception process to complete.
- Callback functions are executed by the interrupt processing function. This means that no other interrupt can be processed until a callback function has completed.
- In SPI master mode the slave(s) SS pin must be asserted before calling this function. A general I/O pin can be used for this, see the I/O Port API.
- If using the DMAC or DTC this module does not know when the transfer has ended. Therefore when the transfer has completed the user must call the R_SCI_Control function with options PDL_SCI_STOP_TX / PDL_SCI_STOP_RX to manually disable the transmission / reception as appropriate.
- If a callback function is specified and the interrupt priority level is zero this function will return false.
- If using this function to perform a full duplex transfer then the transfer mode for transmit and receive can be set independently. If using the polling transfer mode for only one direction this function must not be called from an interrupt handler so that interrupts can still be serviced for the non-polling transfer direction.
- Device packages with 100 or fewer pins do not have all of the SCI channels.

Program example

```
/* PDL functions */
#include "r_pdl_sci.h"

/* RPDL device-specific definitions */
#include "r_pdl_definitions.h"

volatile uint8_t SCI1RxBuffer[10];
const uint8_t SCI1TxBuffer[10] =
    {'1','2','3','4','5','6','7','8','9','10'};

/* SCI channel 1 receive data handler */
void SCI1RxFunc(void){}

/* SCI channel 1 error handler */
void SCI1ErrFunc(void){}

void func( void )
{
    /* Wait while send 5 characters on channel 0 */
    R_SCI_SPI_Transfer (
        0,
        PDL_NO_DATA,
        5,
        "12345",
        PDL_NO_FUNC,
        PDL_NO_DATA,
        PDL_NO_FUNC,
        PDL_NO_FUNC
    );

    /* Start the transmission and reception of 9 characters on channel 1
    */
    R_SCI_Receive(
        1,
        PDL_NO_DATA,
        SCI1RxBuffer,
        9,
        SCI1RxFunc,
        SCI1ErrFunc
    );
}
```

7) R_SCI_IIC_Write

Synopsis Perform an IIC master write on an SCI channel.

Prototype

```
bool R_SCI_IIC_Write(
    uint8_t data1, // Channel selection
    uint16_t data2, // Channel configuration
    uint16_t data3, // Slave Address
    uint16_t data4, // Number of bytes to transfer
    uint8_t * data5, // Buffer
    void * func // Callback function.
);
```

Description (1/2) Perform an IIC master write.

[data1]
Select channel SCIn (where n = 0 to 12).

[data2]
Control options.
The default options are shown in **bold**. Specify PDL_NO_DATA to use the defaults.

- DMAC / DTC trigger control

PDL_SCI_IIC_DMTC_TRIGGER_DISABLE or PDL_SCI_IIC_DMTC_TRIGGER_ENABLE or PDL_SCI_IIC_DTC_TRIGGER_ENABLE	Disable or enable activation of the DMAC or DTC for the data stage.
--	---

- Slave Address Size

PDL_SCI_IIC_7_BIT_SLAVE_ADDRESS or PDL_SCI_IIC_10_BIT_SLAVE_ADDRESS	Specify the slave address width.
---	----------------------------------

- Repeated Start

PDL_SCI_IIC_RESTART	The transfer will start with a re-start rather than the default behaviour of a start condition.
---------------------	---

- Stop Condition selection

PDL_SCI_IIC_NOSTOP	By default the transfer will end with a stop condition. Select this option to prevent the stop condition being generated.
--------------------	---

[data3]
Slave address, either 7 or 10 bits, use the format as specified here:

b15 - b8	b7 - b1	b0
-	7-bit address	-

b15 - b11	b10 - b1	b0
-	10-bit address	-

[data4]
The number of data bytes that must be transferred before the function completes or the callback function is called.
If the DMAC or DTC shall be used to handle the received data, specify PDL_NO_DATA.

[data5]
The start address of the buffer that contains the data to be written.
Specify PDL_NO_PTR if not transmitting data or if no data shall be processed by this function e.g. if the DMAC or DTC shall be used to send the data.

Description (2/2)**[func]**

Specify PDL_NO_FUNC or a callback function name, depending on the required transfer method.

Transfer method	Parameter
Polling	PDL_NO_FUNC. This function will continue until the required number of bytes has been transferred or an error occurs.
Interrupts	The function to be called when the transfer has completed or an error detected.
DMAC	Either the function to be called when each byte is transferred, or PDL_NO_FUNC if the callback function specified in R_DMAC_Create will be used.
DTC	The function to be called at the interval specified in R_DTC_Create.

Return value

In Polling Mode:

True if all parameters are valid and the operation completed OK; false if a parameter was out of range or an error was detected.

In Non-Polling mode:

True if all parameters are valid; false if a parameter was out of range.

Category

SCI

Reference

R_DMAC_Create, R_DTC_Create, R_SCI_Control

Remarks

- The maximum number of characters to be transmitted is 65535.
- Wait until a transmission on the same channel is complete before calling this function.
- Callback functions are executed by the interrupt processing function. This means that no other interrupt can be processed until a callback function has completed.
- This function, unless configured not to, will by default automatically start a transfer by generating a Start condition and finish with a Stop condition. However, if using DMAC or DTC the Stop condition will not be generated automatically, so use the R_SCI_Control function to manually generate a stop.
- If a callback function is specified and the interrupt priority level is zero this function will return false.
- The SCI IIC module is always configured to use Reception and Transmission interrupts (IICINTM bit = 1) rather than ACK/NACK interrupts. This means that if using the DMAC or DTC to transmit then all data will be transmitted even if the slave device fails to ACK.
- Device packages with 100 or fewer pins do not have all of the SCI channels.

Program example

```

/* PDL functions */
#include "r_pdl_sci.h"

/* RPDL device-specific definitions */
#include "r_pdl_definitions.h"

#define CHANNEL_SCI_IIC 9
#define SLAVE_ADDRESS 0xA0

/* Buffer for IIC data */
extern uint8_t IIC_Buffer[10];

void func( void )
{
    /* Wait while send 10 bytes */
    R_SCI_IIC_Write(
        CHANNEL_SCI_IIC,
        PDL_NO_DATA,
        SLAVE_ADDRESS,
        10,
        IIC_Buffer,
        PDL_NO_FUNC
    );
}

```

8) R_SCI_IIC_Read

Synopsis Perform an IIC master read on an SCI channel.

Prototype

```
bool R_SCI_IIC_Read(
    uint8_t data1, // Channel selection
    uint16_t data2, // Channel configuration
    uint16_t data3, // Slave Address
    uint16_t data4, // Number of bytes to transfer
    uint8_t * data5, // Buffer
    void * func // Callback function.
);
```

Description (1/2) Perform an IIC master read.

[data1]
Select channel SCIn (where n = 0 to 12).

[data2]
Control options.
The default options are shown in **bold**. Specify PDL_NO_DATA to use the defaults.

- DMAC / DTC trigger control

PDL_SCI_IIC_DMTC_TRIGGER_DISABLE or PDL_SCI_IIC_DMTC_TRIGGER_ENABLE or PDL_SCI_IIC_DTC_TRIGGER_ENABLE	Disable or enable activation of the DMAC or DTC for the data stage.
--	---

- Slave Address Size

PDL_SCI_IIC_7_BIT_SLAVE_ADDRESS or PDL_SCI_IIC_10_BIT_SLAVE_ADDRESS	Specify the slave address width.
---	----------------------------------

- Repeated Start

PDL_SCI_IIC_RESTART	The transfer will start with a re-start rather than the default behaviour of a start condition.
---------------------	---

- Stop Condition selection

PDL_SCI_IIC_NOSTOP	By default the transfer will end with a stop condition. Select this option to prevent the stop condition being generated.
--------------------	---

[data3]
Slave address, either 7 or 10 bits, use the format as specified here:

b15 - b8	b7 - b1	b0
-	7-bit address	-

b15 - b11	b10 - b1	b0
-	10-bit address	-

[data4]
The number of data bytes that must be transferred before the function completes or the callback function is called.
If the DMAC or DTC shall be used to handle the received data, specify PDL_NO_DATA.

[data5]
The start address of the buffer that will receive the data.
Specify PDL_NO_PTR if no data shall be processed by this function e.g. if the DMAC or DTC shall be used to process the received data.

Description (2/2)**[func]**

Specify PDL_NO_FUNC or a callback function name, depending on the required transfer method.

Transfer method	Parameter
Polling	PDL_NO_FUNC. This function will continue until the required number of bytes has been transferred or an error occurs.
Interrupts	The function to be called when the transfer has completed or an error detected.
DMAC	Either the function to be called when each byte is transferred, or PDL_NO_FUNC if the callback function specified in R_DMACE_Create will be used.
DTC	The function to be called at the interval specified in R_DTC_Create.

Return value

In Polling Mode:

True if all parameters are valid and the operation completed OK; false if a parameter was out of range or an error was detected.

In Non-Polling mode:

True if all parameters are valid; false if a parameter was out of range.

Category

SCI

Reference

R_SCI_GetStatus, R_SCI_IIC_ReadLastByte, R_SCI_Control

Remarks

- The maximum number of characters to be received is 65535.
- Wait until a transmission on the same channel is complete before calling this function.
- Callback functions are executed by the interrupt processing function. This means that no other interrupt can be processed until a callback function has completed.
- This function, unless configured not to, will by default automatically start a transfer by generating a Start condition and finish with a Stop condition. However, if using DMAC or DTC the Stop condition will not be generated automatically, so use the R_SCI_IIC_ReadLastByte or R_SCI_Control function to manually generate a stop.
- The last byte of a master read will automatically be NACK'd. However, if using DMAC or DTC this will not happen. If a NACK is required then use the DMAC / DTC to read all the data except for the last byte and then use function R_SCI_IIC_ReadLastByte to read the last byte.
- If a callback function is specified and the interrupt priority level is zero this function will return false.
- Device packages with 100 or fewer pins do not have all of the SCI channels.

Program example

```

/* PDL functions */
#include "r_pdl_sci.h"

/* R_PDL device-specific definitions */
#include "r_pdl_definitions.h"

#define CHANNEL_SCI_IIC 9
#define SLAVE_ADDRESS 0xA0

/* Buffer for IIC data */
extern uint8_t IIC_Buffer[10];

void func( void )
{
    /* Wait while read 10 bytes */
    R_SCI_IIC_Read(
        CHANNEL_SCI_IIC,
        PDL_NO_DATA,
        SLAVE_ADDRESS,
        10,
        IIC_Buffer,
        PDL_NO_FUNC
    );
}

```

9) R_SCI_IIC_ReadLastByte

Synopsis

Read the last byte of an IIC read transfer.

Prototype

```
bool R_SCI_IIC_ReadLastByte (
    uint8_t data1,    // Channel selection
    uint8_t * data2  // Buffer to receive byte.
);
```

Description

If R_SCI_IIC_Read has been used to start an IIC read where the DMAC or DTC will read all the data except for the last byte this function can be used to read the last byte. A NACK will then be generated, followed by a stop condition (unless the original transfer request asked for the stop condition to be omitted).

[data1]

Select channel SCIn (where n = 0 to 12).

[data2]

The address of the buffer that will receive the byte.

Return value

True.

Category

SCI

Reference

R_SCI_IIC_Read

Remarks

- Device packages with 100 or fewer pins do not have all of the SCI channels.

Program example

```
/* PDL functions */
#include "r_pdl_sci.h"

/* RPDLC device-specific definitions */
#include "r_pdl_definitions.h"

#define CHANNEL_SCI_IIC 9

/* Buffer for IIC data */
extern uint8_t IIC_Buffer[10];

void func( void )
{
    /* Read the last byte of the IIC read operation */
    R_SCI_IIC_ReadLastByte(
        CHANNEL_SCI_IIC,
        &IIC_Buffer[9]
    );
}
```

10) R_SCI_Control

Synopsis Control the SCI channel.

Prototype

```
bool R_SCI_Control(
    uint8_t data1, // Channel selection
    uint16_t data2 // Channel control
);
```

Description Control the SCI channel.

[data1]
Select channel SCIn (where n = 0 to 12).

[data2] (Not IIC Mode)
Control the channel. If multiple selections are required, use “|” to separate each selection.

- Select the process to be stopped.

PDL_SCI_STOP_TX	Stop the transmission process. If a reception process is active, the transmit output will not become idle until the reception process has stopped.
PDL_SCI_STOP_RX	Stop the reception process. If a transmission process is active, the receive error flags may be set erroneously. These can be ignored and will be cleared when a new reception process is started.

The option “PDL_SCI_STOP_TX_AND_RX” can be used to select both processes.

If both processes are selected, transmission and reception will stop immediately.

- Generate a Space or Mark signal when idle.
(Only applicable in Async and Async Multi-Processor Modes.)

PDL_SCI_OUTPUT_SPACE	Set the idle output to Space (logic 0). This can be used to generate a Break condition.
PDL_SCI_OUTPUT_MARK	Set the idle output to Mark (logic 1).

- Error flag control

PDL_SCI_CLEAR_RECEIVE_ERROR_FLAGS	Try to clear the receive error flags.
-----------------------------------	---------------------------------------

- Manual SCK control

PDL_SCI_GSM_SCK_STOP or PDL_SCI_GSM_SCK_START	Disable or enable the clock output (can be used while GSM mode is enabled).
--	---

[data2] (IIC Mode only)

Control the channel.

- Stop condition generation

PDL_SCI_IIC_STOP	A stop will be output on the bus.
------------------	-----------------------------------

- Clock Synchronisation

PDL_SCI_IIC_CLOCK_SYNC_DISABLE or PDL_SCI_IIC_CLOCK_SYNC_ENABLE	Disable or enable the IIC clock synchronisation. Note: Clock synchronisation is enabled by default as required for normal operation.
--	---

Return value True if all parameters are valid; otherwise false.

Category SCI

Reference

Remarks

- Device packages with 100 or fewer pins do not have all of the SCI channels.

Program example

```
/* RPDL definitions */
#include "r_pdl_sci.h"

/* RPDL device-specific definitions */
#include "r_pdl_definitions.h"

void func(void)
{
    /* Terminate SCI reception on channel 0 */
    R_SCI_Control(
        0,
        PDL_SCI_STOP_RX
    );
}
```

11) R_SCI_GetStatus

Synopsis

Check the status of an SCI channel.

Prototype

```
bool R_SCI_GetStatus(
    uint8_t data1, // Channel selection
    uint8_t * data2, // Status flags
    uint8_t * data3, // Last byte received
    uint16_t * data4, // Bytes transmitted
    uint16_t * data5 // Bytes received
);
```

Description

Acquires the channel status and the byte counts

[data1]

Select channel SCIn (where n = 0 to 12).

[data2]

The status flags shall be stored in one of the following formats depending on the current mode:
(Note: Some bits are Not Applicable (NA) in all modes – see descriptions.)

Asynchronous or Synchronous modes: (Not IIC Mode)

	b7-b6	b5	b4	b3	b2	b1	b0
0	Reception error detection			Transmit status	0	RxD pin level (NA to SPI mode)	
	Overrun	Framing (Async. mode only)	Parity (Async. mode only)				
	0: No error 1: Detected	0: No error 1: Detected	0: No error 1: Detected	0: Active 1: Idle	0: Low 1: High		

Smart card mode:

	b7 – b6	b5	b4	b3	b2	b1	b0
0	Error detection			Transmit status	0	RxD pin level	
	Overrun	Error signal	Parity				
	0: No error 1: Detected	0: No error 1: Detected	0: No error 1: Detected	0: Active 1: Idle	0: Low 1: High		

IIC Mode:

	b7 – b1	b0
0	ACK / NACK flag	
	This is updated every time an ACK or NACK is received.	
	0: ACK received 1: NACK received	

[data3]

The storage location for the last byte that was received. Specify PDL_NO_PTR if this information is not required.

[data4]

The storage location for the number of characters that are have been transmitted in the current transmission. Specify PDL_NO_PTR if this information is not required.

NOTE: If using DMAC or DTC specify PDL_NO_PTR as this information is not available.

[data5]

The storage location for the number of characters that are have been received in the current reception process. Specify PDL_NO_PTR if this information is not required.

NOTE: If using DMAC or DTC specify PDL_NO_PTR as this information is not available.

Return value

True if all parameters are valid and the operation completed; false if a parameter was out of range or the RX pin has not been selected by using the R_SCI_Set and/or R_SCI_Receive functions.

Category

SCI

Reference

R_SCI_Set, R_SCI_Receive

Remarks

- The error flags are not modified by this function. They are cleared when a new reception process is started.
- Device packages with 100 or fewer pins do not have all of the SCI channels.

Program example

```
/* RPDL definitions */
#include "r_pdl_sci.h"

/* RPDL device-specific definitions */
#include "r_pdl_definitions.h"

uint8_t StatusValue;
uint16_t TxChars;
uint16_t RxChars;

void func(void)
{
    /* Read the status of SCI channel 0 */
    R_SCI_GetStatus(
        0,
        &StatusValue,
        PDL_NO_PTR,
        &TxChars,
        &RxChars
    );
}
```

4.2.24. I²C Bus Interface

1) R_IIC_Create

Synopsis	I ² C channel setup.
-----------------	---------------------------------

Prototype	<pre> bool R_IIC_Create(uint8_t data1, // Channel selection uint32_t data2, // Channel configuration uint32_t data3, // Detection configuration uint16_t data4, // Slave address uint16_t data5, // Slave address uint16_t data6, // Slave address uint32_t data7, // Transfer rate control uint32_t data8 // Rise and fall time correction); </pre>
------------------	--

Description (1/3)	Set up the selected I ² C channel.
--------------------------	---

[data1]
Select channel IICn (where n = 0 to 3).

[data2]
Configure the channel. If multiple selections are required, use “|” to separate each selection. The default settings are shown in **bold**.

- Bus mode selection

PDL_IIC_MODE_IIC or PDL_IIC_MODE_SMBUS or PDL_IIC_MODE_IIC_FMP	Choose between I ² C Bus or SMBus mode. For channel 0, I ² C Fast Mode Plus is also available.
---	--

- Internal reference clock

PDL_IIC_INT_PCLK_DIV_1 or PDL_IIC_INT_PCLK_DIV_2 or PDL_IIC_INT_PCLK_DIV_4 or PDL_IIC_INT_PCLK_DIV_8 or PDL_IIC_INT_PCLK_DIV_16 or PDL_IIC_INT_PCLK_DIV_32 or PDL_IIC_INT_PCLK_DIV_64 or PDL_IIC_INT_PCLK_DIV_128	The reference clock source (derived from PCLKB), used inside the I ² C module.
--	---

- Timeout detection control

PDL_IIC_TIMEOUT_DISABLE or PDL_IIC_TIMEOUT_LOW or PDL_IIC_TIMEOUT_HIGH or PDL_IIC_TIMEOUT_BOTH	Disable timeout detection, or enable for SCL stuck at a low level high level or both low and high level.
---	--

- Timeout mode

PDL_IIC_TIMEOUT_LONG or PDL_IIC_TIMEOUT_SHORT	Select 16-bit (long) or 14-bit (short) mode.
--	--

- SDA output delay count

PDL_IIC_SDA_DELAY_0 or PDL_IIC_SDA_DELAY_1 or PDL_IIC_SDA_DELAY_2 or PDL_IIC_SDA_DELAY_3 or PDL_IIC_SDA_DELAY_4 or PDL_IIC_SDA_DELAY_5 or PDL_IIC_SDA_DELAY_6 or PDL_IIC_SDA_DELAY_7	Select the number of cycles for the SDA output delay counter.
---	---

- SDA output delay clock source

PDL_IIC_SDA_DELAY_DIV_1 or PDL_IIC_SDA_DELAY_DIV_2	Select the clock source (internal reference clock ÷ 1 or 2) for the SDA output delay counter.
---	---

Description (2/3)

- Noise filter control

PDL_IIC_NF_DISABLE or PDL_IIC_NF_1 or PDL_IIC_NF_2 or PDL_IIC_NF_3 or PDL_IIC_NF_4	Select the number of stages in the noise filter.
---	--

[data3]

Detection settings. Specify PDL_NO_DATA to use the defaults.

- NACK Transmission Arbitration Lost Detection control

PDL_IIC_NTALD_DISABLE or PDL_IIC_NTALD_ENABLE	Disable or enable arbitration to be lost when an ACK is detection during transmission of a NACK in receive mode.
---	--

- Slave Arbitration Lost Detection control

PDL_IIC_SALD_DISABLE or PDL_IIC_SALD_ENABLE	Disable or enable arbitration to be lost when a mismatch occurs during slave data transmission.
---	---

- Slave address detection control

PDL_IIC_SLAVE_0_DISABLE or PDL_IIC_SLAVE_0_ENABLE_7 or PDL_IIC_SLAVE_0_ENABLE_10	Disable or enable detection of slave address 0 in 7-bit or 10-bit format.
PDL_IIC_SLAVE_1_DISABLE or PDL_IIC_SLAVE_1_ENABLE_7 or PDL_IIC_SLAVE_1_ENABLE_10	Disable or enable detection of slave address 1 in 7-bit or 10-bit format.
PDL_IIC_SLAVE_2_DISABLE or PDL_IIC_SLAVE_2_ENABLE_7 or PDL_IIC_SLAVE_2_ENABLE_10	Disable or enable detection of slave address 2 in 7-bit or 10-bit format.
PDL_IIC_SLAVE_GCA_DISABLE or PDL_IIC_SLAVE_GCA_ENABLE	Disable or enable detection of the General Call address.

- Device-ID detection control

PDL_IIC_DEVICE_ID_DISABLE or PDL_IIC_DEVICE_ID_ENABLE	Disable or enable detection of the Device-ID address (1111 100b).
---	---

- Host Address detection control

PDL_IIC_HOST_ADDRESS_DISABLE or PDL_IIC_HOST_ADDRESS_ENABLE	Disable or enable detection of the SMBus host address.
---	--

[data4]

Slave address 0. Ignored if slave address 0 detection is disabled.

[data5]

Slave address 1. Ignored if slave address 1 detection is disabled.

[data6]

Slave address 2. Ignored if slave address 2 detection is disabled.

[data7]

Transfer rate control.

Either:

The maximum bit rate in bits per second.

For Master mode, the clock division values will be calculated using a 50% duty cycle.

For Slave mode, the rate will be used to calculate the clock stretching period.

Or:

b31	b30 - b13	b12 - b8	b7 - b5	b4 - b0
1	-	Bit rate high-level register (ICBRH) value.	-	Bit rate low-level register (ICBRL) value.

Description (3/3)

[data8]

Rise and fall time compensation.

If the transfer rate is specified in bits per second, the high-level and low-level durations can be adjusted to allow for application-dependent rise and fall times. If unsure, use 0.

b31 - b16	b15 - b0
The SCL rise time in nanoseconds. Valid from 0 to 65535.	The SCL fall time in nanoseconds. Valid from 0 to 65535.

Return value

True if all parameters are valid, exclusive and achievable; otherwise false.

Category

I²C

Reference

R_CGC_Set

Remarks

- Function R_CGC_Set must be called (with the current clock source selected) before using this function.
- This function configures each I²C pin that is required for operation. It also disables the alternative modes on those pins.
- This function will return false if fast mode plus mode is selected for a channel other than channel 0.
- Device packages with 100 or fewer pins do not have all of IIC channels. This function will return false in this case.
- The 7 or 10-bit slave addresses should use the format:

b15 - b8	b7 - b1	b0
-	7-bit address	-
b15 - b11	b10 - b1	b0
-	10-bit address	-

- The timing limits depend on the frequency of the internal reference clock (IRC).

$$Transfer_rate = \frac{1}{t_{rise} + t_{fall} + (ICBRH + 1)t_{IRC} + (ICBRL + 1)t_{IRC}}$$

The maximum transfer rate is given when ICBRH = ICBRL = 0; the minimum when ICBRH = ICBRL = 31.

The absolute limits (with zero rise and fall times) are:

f _{IRC}	f _{PCLKB} (MHz)					
	50	48	12.5	12	32	8
f _{PCLKB} ÷ 1	781 kbps to 25.0 Mbps	750 kbps to 24.0 Mbps	195 kbps to 6.25 Mbps	187.5 kbps to 6.0 Mbps	500 kbps to 16.0 Mbps	125 kbps to 4.00 Mbps
f _{PCLKB} ÷ 2	391 kbps to 12.5 Mbps	375 kbps to 12.0 Mbps	97.7 kbps to 3.13 Mbps	93.75 kbps to 3.0 Mbps	250 kbps to 8.00 Mbps	62.5 kbps to 2.00 Mbps
f _{PCLKB} ÷ 4	195 kbps to 6.25 Mbps	187.5 kbps to 6.0 Mbps	48.8 kbps to 1.56 Mbps	46.875 kbps to 1.5 Mbps	125 kbps to 4.00 Mbps	31.3 kbps to 1.00 Mbps
f _{PCLKB} ÷ 8	97.7 kbps to 3.13 Mbps	93.75 kbps to 3.0 Mbps	24.4 kbps to 781 kbps	23.4 kbps to 750 kbps	62.5 kbps to 2.00 Mbps	15.6 kbps to 500 kbps
f _{PCLKB} ÷ 16	48.8 kbps to 1.56 Mbps	46.875 kbps to 1.5 Mbps	12.2 kbps to 391 kbps	11.71 kbps to 375 kbps	31.3 kbps to 1.00 Mbps	7.81 kbps to 250 kbps
f _{PCLKB} ÷ 32	24.4 kbps to 781 kbps	23.4 kbps to 750 kbps	6.10 kbps to 195 kbps	5.86 kbps to 187.5 kbps	15.6 kbps to 500 kbps	3.91 kbps to 125 kbps
f _{PCLKB} ÷ 64	12.2 kbps to 391 kbps	11.71 kbps to 375 kbps	3.05 kbps to 97.7 kbps	2.93 kbps to 93.75 kbps	7.81 kbps to 250 kbps	1.95 kbps to 62.5 kbps
f _{PCLKB} ÷ 128	6.10 kbps to 195 kbps	5.86 kbps to 187.5 kbps	1.53 kbps to 48.8 kbps	1.46 kbps to 46.875 kbps	3.91 kbps to 125 kbps	977 bps to 31.3 kbps

The actual rise and fall times will not be zero.

Using the limits from the I²C specification:

Rise time: (rate ≤ 100 kbps): 1000 ns; (100 kbps < rate ≤ 400 kbps): 300 ns; (400 kbps < rate ≤ 1 Mbps): 120 ns

Fall time: (rate ≤ 400 kbps): 300 ns; (400 kbps < rate ≤ 1 Mbps): 120 ns

Maximum rate: 1 Mbps

The achievable transfer rates are:

IRC	f _{PCLKB} (MHz)					
	50	48	12.5	12	32	8
PCLKB ÷ 1	658 kbps to 1 Mbps	635.6 kbps to 1 Mbps	175 kbps to 1 Mbps	168.5 kbps to 1 Mbps	446 kbps to 1 Mbps	116 kbps to 1 Mbps
PCLKB ÷ 2	316 kbps to 1 Mbps	306 kbps to 1 Mbps	86.7 kbps to 1 Mbps	83.6 kbps to 1 Mbps	217 kbps to 1 Mbps	57.8 kbps to 1 Mbps
PCLKB ÷ 4	175 kbps to 1 Mbps	168.5 kbps to 1 Mbps	45.9 kbps to 1 Mbps	44.2 kbps to 1 Mbps	116 kbps to 1 Mbps	30.0 kbps to 806 kbps
PCLKB ÷ 8	86.7 kbps to 1 Mbps	83.6 kbps to 1 Mbps	23.7 kbps to 658 kbps	22.7 kbps to 635.6 kbps	57.8 kbps to 1 Mbps	15.3 kbps to 446 kbps
PCLKB ÷ 16	45.9 kbps to 1 Mbps	44.2 kbps to 1 Mbps	12.0 kbps to 316 kbps	11.5 kbps to 306.1 kbps	30.0 kbps to 806 kbps	7.73 kbps to 217 kbps
PCLKB ÷ 32	23.7 kbps to 658 kbps	22.7 kbps to 635.6 kbps	6.06 kbps to 175 kbps	5.8 kbps to 168.5 kbps	15.3 kbps to 446 kbps	3.89 kbps to 116 kbps
PCLKB ÷ 64	12.0 kbps to 316 kbps	11.5 kbps to 306.1 kbps	3.04 kbps to 86.7 kbps	2.9 kbps to 83.6 kbps	7.73 kbps to 217 kbps	1.95 kbps to 57.8 kbps
PCLKB ÷ 128	6.06 kbps to 175 kbps	5.82 kbps to 168.5 kbps	1.52 kbps to 45.9 kbps	1.5 kbps to 44.2 kbps	3.89 kbps to 116 kbps	975 bps to 30.0 kbps

Program example

```
/* RPDL definitions */
#include "r_pdl_iic.h"

/* RPDL device-specific definitions */
#include "r_pdl_definitions.h"

void func(void)
{
    /* Select I2C mode at 100kHz, 100ns rise and fall times */
    R_IIC_Create(
        0,
        PDL_IIC_MODE_IIC | PDL_IIC_INT_PCLK_DIV_8,
        PDL_NO_DATA,
        PDL_NO_DATA,
        PDL_NO_DATA,
        PDL_NO_DATA,
        100E3,
        (100 << 16) | 100
    );

    /* Select I2C mode with two slave addresses */
    R_IIC_Create(
        0,
        PDL_IIC_MODE_IIC,
        PDL_IIC_SLAVE_0_ENABLE_7 | PDL_IIC_SLAVE_1_ENABLE_7,
        0x0020,
        0x0056,
        PDL_NO_DATA,
        100E3,
        (300 << 16) | 200
    );
}
```

2) R_IIC_Destroy

Synopsis

Disable an I²C channel.

Prototype

```
bool R_IIC_Destroy(
    uint8_t data // Channel selection
);
```

Description

Shut down the selected I²C channel.

[data]

Select channel IICn (where n = 0 to 3).

Return value

True if the parameter is valid; otherwise false.

Category

I²C

Reference

R_IIC_Create

Remarks

- The I²C module is put into the power-down state.
- Device packages with 100 or fewer pins do not have all of IIC channels. This function will return false in this case.

Program example

```
/* RPDL definitions */
#include "r_pdl_iic.h"

/* RPDL device-specific definitions */
#include "r_pdl_definitions.h"

void func(void)
{
    /* Shutdown IIC channel 0 */
    R_IIC_Destroy(
        0
    );
}
```

3) R_IIC_MasterSend

Synopsis

Write data to a slave device.

Prototype

```
bool R_IIC_MasterSend(
    uint8_t data1, // Channel selection
    uint16_t data2, // Channel configuration
    uint16_t data3, // Slave address
    uint8_t * data4, // Data start address
    uint16_t data5, // Data count
    void * func, // Callback function
    uint8_t data6 // Interrupt priority level
);
```

Description(1/2)

Transmit data on the specified channel.

[data1]

Select channel IICn (where n = 0 to 3).

[data2]

Configure the channel. If multiple selections are required, use “|” to separate each selection. The default settings are shown in **bold**. Specify PDL_NO_DATA to use the defaults.

- Start / Repeated Start condition control

PDL_IIC_START_ENABLE or PDL_IIC_START_DISABLE	Choose whether or not to issue a Start or Repeated Start condition at the beginning of the transfer.
--	--

- Stop condition control

PDL_IIC_STOP_ENABLE or PDL_IIC_STOP_DISABLE	Choose whether or not to issue a Stop condition at the end of the transfer.
--	---

- Slave address size override

PDL_IIC_10_BIT_SLAVE_ADDRESS	Specify this option if 10-bit address mode is to be used instead of 7-bit mode when the slave address is ≤ FFh.
------------------------------	---

- DMAC / DTC trigger control

PDL_IIC_DMAC_DTC_TRIGGER_DISABLE or PDL_IIC_DMAC_TRIGGER_ENABLE or PDL_IIC_DTC_TRIGGER_ENABLE	Disable or enable activation of the DMAC or DTC when a data byte is transmitted.
--	--

[data3]

The address of the slave device. Ignored if the Start condition is disabled.

[data4]

The start address of the data to be sent. If the DMAC or DTC shall be used to transfer the data, specify PDL_NO_PTR.

[data5]

The number of bytes to be sent. If the DMAC or DTC shall be used to transfer the data, specify PDL_NO_DATA.

[func]

Specify PDL_NO_FUNC or a callback function name, depending on the required transfer method.

Transfer method	Parameter
Polling	PDL_NO_FUNC. This function will continue until the required number of bytes has been sent (or another event occurs).
Interrupts	The function to be called when bus activity has stopped.
DMAC	Either the function to be called when each byte is sent, or PDL_NO_FUNC if the callback function specified in R_DMAC_Create will be used.
DTC	The function to be called at the interval specified in R_DTC_Create.

Description (2/2)	[data6] The interrupt priority level. Select between 1 (lowest priority) and 15 (highest priority). This parameter will be ignored if PDL_NO_FUNC is specified for parameter func.
Return value	True if all parameters are valid, exclusive and achievable and a normal transfer completed; otherwise false.
Category	I ² C
Reference	R_IIC_Create, R_IIC_GetStatus
Remarks	<ul style="list-style-type: none"> • If a callback function is specified, transmission interrupts are used. Please see the notes on callback function usage in §6. • If the Start condition is enabled and the previous transfer did not issue a Stop condition, a Repeated Start condition shall be generated. • If the Start condition is disabled, the slave address will not be transmitted. • If no callback function is specified for transmission completion, this function will monitor the status flags to manage the data transmission. If the I²C channel's registers are modified directly by the user, this function may lock up. • If false is returned, use R_IIC_GetStatus to check if an unexpected event on I²C bus was the cause of the failure. If the transfer has ended prematurely, use R_IIC_Control to issue a Stop condition. • False will be returned if the DMAC channel has not been allocated using R_DMAC_Create. • False will be returned if the bus is busy due to another master on the bus. • Device packages with 100 or fewer pins do not have all of IIC channels. This function will return false in this case.

Program example

```

/* RPDL definitions */
#include "r_pdl_iic.h"

/* RPDL device-specific definitions */
#include "r_pdl_definitions.h"

const uint8_t data_array[5] = {0x23, 0x48, 0x59, 0x60, 0xFE};

void func(void)
{
    /* Send 5 bytes to device 0x0A0 on channel 0, using polling */
    R_IIC_MasterSend(
        0,
        PDL_NO_DATA,
        0x0A0,
        data_array,
        5,
        PDL_NO_FUNC,
        0
    );
}

```

4) R_IIC_MasterReceive

Synopsis

Read data from a slave device.

Prototype

```
bool R_IIC_MasterReceive(
    uint8_t data1, // Channel selection
    uint16_t data2, // Channel configuration
    uint16_t data3, // Slave address
    uint8_t * data4, // Data start address
    uint16_t data5, // Receive threshold
    void * func, // Callback function
    uint8_t data6 // Interrupt priority level
);
```

Description

Read data over an I²C channel and store it.

[data1]

Select channel IIC_n (where n = 0 to 3).

[data2]

Configure the channel.

The default setting is shown in **bold**. Specify PDL_NO_DATA to use the defaults.

- Slave address size override

PDL_IIC_10_BIT_SLAVE_ADDRESS	Specify this option if 10-bit address mode is to be used instead of 7-bit mode when the slave address is ≤ FFh.
------------------------------	---

- DMAC / DTC trigger control

PDL_IIC_DMACE_TRIGGER_DISABLE or PDL_IIC_DMACE_TRIGGER_ENABLE or PDL_IIC_DTC_TRIGGER_ENABLE	Disable or enable activation of the DMAC or DTC when a data byte is received.
---	---

[data3]

The address of the slave device.

[data4]

The start address of the storage area for the expected data.

Specify PDL_NO_PTR if no data shall be processed by this function e.g. if the DMAC or DTC shall be used to process the received data.

[data5]

The number of bytes that must be received before the function completes or the callback function is called.

If the DMAC or DTC shall be used to handle the received data, specify PDL_NO_DATA.

[func]

Specify PDL_NO_FUNC or a callback function name, depending on the required transfer method.

Transfer method	Parameter
Polling	PDL_NO_FUNC. This function will continue until the required number of bytes has been received (or another event occurs).
Interrupts	The function to be called when bus activity has stopped.
DMAC	Either the function to be called when each byte is received, or PDL_NO_FUNC if the callback function specified in R_DMACE_Create will be used.
DTC	The function to be called at the interval specified in R_DTC_Create.

[data6]

The interrupt priority level. Select between 1 (lowest priority) and 15 (highest priority).

This parameter will be ignored if PDL_NO_FUNC is specified for parameter func.

Return value

True if all parameters are valid, exclusive and achievable; otherwise false.

Category	I ² C
Reference	R_IIC_Create, R_IIC_GetStatus, R_IIC_MasterReceiveLast
Remarks	<ul style="list-style-type: none"> • If a callback function is specified, reception interrupts are used. • Please see the notes on callback function usage in §6. • If the previous transfer did not issue a Stop condition, a Repeated Start condition shall be generated. • The last byte to be read shall be completed with a NACK signal. • If no callback function is specified, this function will operate in polling mode. The status flags will be used to manage the data reception. If the I²C channel's control registers are directly modified by the user, this function may lock up. If an error occurs during this polling process, the function will terminate. • If the DMAC or DTC is used, use R_IIC_MasterReceiveLast to complete the transfer. • Use R_IIC_GetStatus to determine if the transfer was successful. • False will be returned if the DMAC channel has not been allocated using R_DMAC_Create. • False will be returned if the bus is busy due to another master on the bus. • Device packages with 100 or fewer pins do not have all of IIC channels. This function will return false in this case.

Program example

```

/* RPDL definitions */
#include "r_pdl_iic.h"

/* RPDL device-specific definitions */
#include "r_pdl_definitions.h"

volatile uint8_t data_array[5];

void func(void)
{
    /* Read 5 bytes from device 0xAA on channel 0, using polling */
    R_IIC_MasterReceive(
        0,
        PDL_NO_DATA,
        0xAA,
        data_array,
        5,
        PDL_NO_FUNC,
        0
    );
}

```

5) R_IIC_MasterReceiveLast

Synopsis

Complete a DMAC or DTC-based read process.

Prototype

```
bool R_IIC_MasterReceiveLast(
    uint8_t data1, // Channel selection
    uint8_t * data2 // Data storage address
);
```

Description

Read one data byte with NACK and stop.

[data1]

Select channel IICn (where n = 0 to 3).

[data2]

The storage location for the data byte.

Return value

True if all parameters are valid and the function completed; otherwise false.

Category

I²C

Reference

R_IIC_GetStatus

Remarks

- This function must only be used to terminate a Read process that has used the DMAC or DTC.
- Use R_IIC_GetStatus to determine if the transfer was successful.
- Please specify one byte less in the Transfer Count when using with the DMAC or DTC.
- Device packages with 100 or fewer pins do not have all of IIC channels. This function will return false in this case.

Program example

```
/* RPDL definitions */
#include "r_pdl_iic.h"

/* RPDL device-specific definitions */
#include "r_pdl_definitions.h"

volatile uint8_t data_array[5];

void func(void)
{
    /* Read 1 byte on channel 0 and stop */
    R_IIC_MasterReceiveLast(
        0,
        &data_array[4]
    );
}
```

6) R_IIC_SlaveMonitor

Synopsis

Monitor the bus.

Prototype

```
bool R_IIC_SlaveMonitor(
    uint8_t data1, // Channel selection
    uint16_t data2, // Channel configuration
    uint8_t * data3, // Receive data start address
    uint16_t data4, // Receive threshold
    void * func, // Callback function
    uint8_t data5 // Interrupt priority level
);
```

Description

Monitor the bus until an address match occurs and store any data received. Register the storage area and transfer method for data received on the selected I²C channel.

[data1]

Select channel IIC_n (where n = 0 to 3).

[data2]

Select the operation options.

The default setting is shown in **bold**. Specify PDL_NO_DATA to use the default.

- DMAC / DTC trigger control

PDL_IIC_RX_DMACE_TRIGGER_DISABLE or PDL_IIC_RX_DMACE_TRIGGER_ENABLE or PDL_IIC_RX_DTC_TRIGGER_ENABLE	Disable or enable activation of the DMAC or DTC when a byte is received.
PDL_IIC_TX_DMACE_TRIGGER_DISABLE or PDL_IIC_TX_DMACE_TRIGGER_ENABLE or PDL_IIC_TX_DTC_TRIGGER_ENABLE	Disable or enable activation of the DMAC or DTC for data transmission.

[data3]

The start address of the storage area for any received data.

If the DMAC or DTC shall be used to handle the received data, specify PDL_NO_PTR.

[data4]

The number of bytes in the storage area.

If the DMAC or DTC shall be used to handle the received data, specify PDL_NO_DATA.

[func]

Specify PDL_NO_FUNC or a callback function name, depending on the required transfer method.

Transfer method	Parameter
Polling	PDL_NO_FUNC. If not using the DMAC or DTC this function will continue until a Stop or Re-Start condition is detected or the master tries to read data from this slave. If using the DMAC or DTC the function will return after detecting a slave address match so that the DTC/DMAC can complete the transfer.
Interrupts	The function to be called when a Stop or Re-Start condition is detected or the master tries to read data from this slave.
DMAC or DTC	The function to be called when a Stop or Re-Start is detected.

[data5]

The interrupt priority level. Select between 1 (lowest priority) and 15 (highest priority).

This parameter will be ignored if PDL_NO_FUNC is specified for parameter func.

Return value

True if all parameters are valid, exclusive and achievable; otherwise false.

Category

I²C

Reference

R_IIC_Create, R_IIC_GetStatus, R_IIC_SlaveSend

Remarks

- If a callback function is specified, interrupts are used. Use R_IIC_GetStatus in the callback function to identify the activity that has occurred. Please see the notes on callback function usage in §6.
- If using polling mode. When the function returns use R_IIC_GetStatus to identify the activity that has occurred.
- Call this function for each transfer required even if the master has ended the previous transfer with a repeat start.
- If the DMAC or DTC is not being used to perform a slave transmission then if a slave transmission is required function R_IIC_SlaveSend must be called to send the data.
Note: If R_IIC_GetStatus reports that the slave is in transmit mode then a slave transmission is required.
- If the master sends more data than is expected and the DMAC / DTC trigger is disabled, this function will issue a NACK to the master.
- If using the DMAC or DTC for transferring data then ensure they are configured correctly before calling this function.
- False will be returned if the DMAC channel has not been allocated using R_DMAC_Create.
- Normally bus activity for other slaves is ignored with no CPU involvement. However, in the specific case where a callback function is specified and the DTC or DMAC is specified for data transmission, then any stop condition on the bus will cause the callback function to be called before any data has been transferred. This function should then be called again to continue monitoring the bus.
- Device packages with 100 or fewer pins do not have all of IIC channels. This function will return false in this case.

Program example

```

/* RPDL definitions */
#include "r_pdl_iic.h"

/* RPDL device-specific definitions */
#include "r_pdl_definitions.h"

volatile uint8_t data_array[5];

void func(void)
{
    /* Monitor channel 0, using polling */
    R_IIC_SlaveMonitor(
        0,
        PDL_NO_DATA,
        data_array,
        5,
        PDL_NO_FUNC,
        0
    );
}

```

7) R_IIC_SlaveSend

Synopsis

Write data to a master device.

Prototype

```
bool R_IIC_SlaveSend(
    uint8_t data1, // Channel selection
    uint8_t * data2, // Data start address
    uint16_t data3 // Data count
);
```

Description

Transmit data on the specified channel.

[data1]

Select channel IICn (where n = 0 to 3).

[data2]

The start address of the data to be sent.

[data3]

The number of bytes available to be sent.

Return value

True if all parameters are valid, exclusive and achievable; otherwise false.

If this function is not called from the R_IIC_SlaveMonitor callback function, it will complete when a stop condition is detected.

Category

I²C

Reference

R_IIC_SlaveMonitor

Remarks

- Use this function after using R_IIC_SlaveMonitor and detecting that a slave transmission is required.
- If a callback function was specified in the call to R_IIC_SlaveMonitor then this transfer shall be completed using interrupts and the callback function shall be called when the transfer ends.
- If a callback function was not specified in the call to R_IIC_SlaveMonitor then this function will not return until the transfer has ended.
- If the master requires more data than is supplied this function shall loop back to the start of the data.
- Device packages with 100 or fewer pins do not have all of IIC channels. This function will return false in this case.

Program example

```
/* RPDL definitions */
#include "r_pdl_iic.h"

/* RPDL device-specific definitions */
#include "r_pdl_definitions.h"

const uint8_t data_array[5] = {0x23, 0x48, 0x59, 0x60, 0xFE};

void func(void)
{
    /* Assign 5 bytes to be read by a master on channel 0 */
    R_IIC_SlaveSend(
        0,
        data_array,
        5
    );
}
```

8) R_IIC_Control

SynopsisI²C channel control.**Prototype**

```
bool R_IIC_Control(
    uint8_t data1, // Channel selection
    uint8_t data2  // Control options
);
```

DescriptionModify the operation of the selected I²C channel.**[data1]**Select channel IIC_n (where n = 0 to 3).**[data2]**

Control the channel. If multiple selections are required, use "|" to separate each selection.

• Stop generation

PDL_IIC_STOP	Issue a Stop condition.
--------------	-------------------------

• NACK generation

PDL_IIC_NACK	Set the Acknowledge bit to the NACK state.
--------------	--

• Pin control

PDL_IIC_SDA_LOW or PDL_IIC_SDA_HI_Z	Set the SDA pin to low level or high-impedance.
--	---

PDL_IIC_SCL_LOW or PDL_IIC_SCL_HI_Z	Set the SCL pin to low level or high-impedance.
--	---

• Extra clock cycle generation

PDL_IIC_CYCLE_SCL	Generate an extra clock cycle on the SCL pin. This can be used in Master mode to try and unlock a slave device that is holding the SDA signal low.
-------------------	--

• Reset control

PDL_IIC_RESET	Carry out an internal reset of the I ² C module (the settings are preserved).
---------------	--

Return value

True if all parameters are valid, exclusive and achievable; otherwise false.

CategoryI²C**Reference**

R_IIC_Create

Remarks

- Device packages with 100 or fewer pins do not have all of IIC channels. This function will return false in this case.

Program example

```
/* RPDL definitions */
#include "r_pdl_iic.h"

/* RPDL device-specific definitions */
#include "r_pdl_definitions.h"

void func(void)
{
    /* Issue a Stop condition on channel 0 */
    R_IIC_Control(
        0,
        PDL_IIC_STOP
    );
}
```

9) R_IIC_GetStatus

Synopsis

Read the status for an I²C channel.

Prototype

```
bool R_IIC_GetStatus(
    uint8_t data1, // Channel selection
    uint32_t * data2, // Status flags
    uint16_t * data3, // Transmitted bytes
    uint16_t * data4 // Received bytes
);
```

Description

Read the status registers for the selected I²C channel.

[data1]
Select channel IICn (where n = 0 to 3).

[data2]
The status flags shall be stored in the format below.
Specify PDL_NO_PTR if this information is not required.

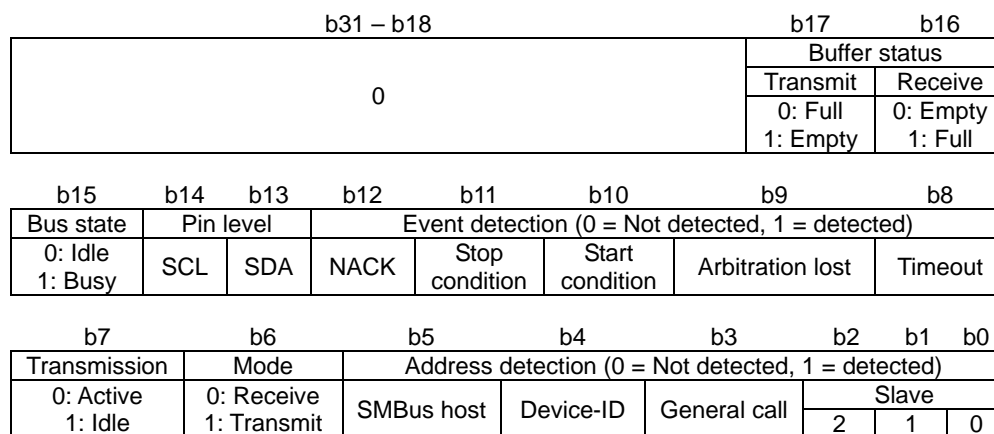

[data3]
The address for storing the number of bytes that are have been transmitted in the current transfer. Specify PDL_NO_PTR if this information is not required.

[data4]
The address for storing for the number of bytes that are have been received in the current transfer. Specify PDL_NO_PTR if this information is not required.

Return value

True if all parameters are valid; otherwise false.

Category

I²C

Reference

R_IIC_Create

Remarks

- The flags are not modified by this function. The event detection flags are cleared as required by the driver for correct operation. The transfer count values are cleared when a new transfer is started.
- If using the DTC or DMAC to transfer data the transfer count values will not be valid. The R_DTC_GetStatus or R_DMAC_GetStatus functions can be used to calculate the transfer count. Note: If the DTC/DMAC transfer does not fully complete then the count reported by the DTC/DMAC for a slave transmission will be one greater than the actual number of bytes read by the master.
- 'Transmit' mode is set when the master has started a master read transfer.
- Device packages with 100 or fewer pins do not have all of IIC channels. This function will return false in this case.

Program example

```
/* RPDL definitions */
#include "r_pdl_iic.h"

/* RPDL device-specific definitions */
#include "r_pdl_definitions.h"

void func(void)
{
    uint32_t status_flags;
    uint16_t tx_count;

    /* Read the status of channel 0 */
    R_IIC_GetStatus(
        0,
        &status_flags,
        &tx_count,
        PDL_NO_PTR
    );
}
```

4.2.25. Serial Peripheral Interface

1) R_SPI_Set

Synopsis

Configure the SPI pin selection.

Prototype

```
bool R_SPI_Set(
    uint8_t data1, // Channel selection
    uint32_t data2, // Pin selection
    uint32_t data3 // Pin selection
);
```

Description (1/2)

Set up the global SPI options.

[data1]

Select channel SPIn (where n = 0, 1 or 2).

[data2]

Configure the SPI input and output pins for channel 0. Use “|” to separate each selection. Settings for RSPCKA, MOSIA and MISOA are compulsory, if channel 0 is selected. Specify PDL_NO_DATA if channel 0 is not selected.

- Pin selection for channel 0

PDL_SPI_RSPCKA_PA5 or PDL_SPI_RSPCKA_PB0 or PDL_SPI_RSPCKA_PC5	Select the RSPCKA pin.
PDL_SPI_MOSIA_P16 or PDL_SPI_MOSIA_PA6 or PDL_SPI_MOSIA_PC6	Select the MOSIA pin.
PDL_SPI_MISOA_P17 or PDL_SPI_MISOA_PA7 or PDL_SPI_MISOA_PC7	Select the MISOA pin.
PDL_SPI_SSLA0_PA4 or PDL_SPI_SSLA0_PC4	Select the SSLA0 pin (optional).
PDL_SPI_SSLA1_PA0 or PDL_SPI_SSLA1_PC0	Select the SSLA1 pin (optional).
PDL_SPI_SSLA2_PA1 or PDL_SPI_SSLA2_PC1	Select the SSLA2 pin (optional).
PDL_SPI_SSLA3_PA2 or PDL_SPI_SSLA3_PC2	Select the SSLA3 pin (optional).

[data3]

Configure the SPI input and output pins for channel 1 and 2. Use “|” to separate each selection. Settings for RSPCKB, MOSIB and MISOB are compulsory, if channel 1 is selected. Specify PDL_NO_DATA if channel 1 and 2 are not selected.

- Pin selection for channel 1

PDL_SPI_RSPCKB_P27 or PDL_SPI_RSPCKB_PE1 or PDL_SPI_RSPCKB_PE5	Select the RSPCKB pin.
PDL_SPI_MOSIB_P26 or PDL_SPI_MOSIB_PE2 or PDL_SPI_MOSIB_PE6	Select the MOSIB pin.
PDL_SPI_MISOB_P30 or PDL_SPI_MISOB_PE3 or PDL_SPI_MISOB_PE7	Select the MISOB pin.
PDL_SPI_SSLB0_P31 or PDL_SPI_SSLB0_PE4	Select the SSLB0 pin (optional).
PDL_SPI_SSLB1_P50 or PDL_SPI_SSLB1_PE0	Select the SSLB1 pin (optional).
PDL_SPI_SSLB2_P51 or PDL_SPI_SSLB2_PE1	Select the SSLB2 pin (optional).
PDL_SPI_SSLB3_P52 or PDL_SPI_SSLB3_PE2	Select the SSLB3 pin (optional).

Description (2/2)**[data3]**

- Additional pin selection for channel 2

PDL_SPI_SSLC0_PD4	Select the SSLC0 pin (optional).
PDL_SPI_SSLC1_PD5	Select the SSLC1 pin (optional).
PDL_SPI_SSLC2_PD6	Select the SSLC2 pin (optional).
PDL_SPI_SSLC3_PD7	Select the SSLC3 pin (optional).

Return value

True if all parameters are valid; otherwise false.

Category

SPI

Reference

R_SPI_Create

Remarks

- Before calling R_SPI_Create, call this function to configure the relevant pins.
- Pins which are not used for the SPI functions may be omitted.
- Channel 2 is not available on 100-pin, 64-pin, and 48-pin packages.
- If channel 2 is selected, pins for RSPCKC, MOSIC and MISOC will be enabled.
- Same pin cannot be used for different pin functions.

Program example

```

/* RPDL definitions */
#include "r_pdl_spi.h"

/* RPDL device-specific definitions */
#include "r_pdl_definitions.h"

void func(void)
{
    /* Configure the applicable SPI pins */
    R_SPI_Set(
        0,
        PDL_SPI_RSPCKA_PA5 | PDL_SPI_MOSIA_PA6 | PDL_SPI_MISOA_PA7 | \
        PDL_SPI_SSLA0_PA4 | PDL_SPI_SSLA1_PA0 | \
        PDL_SPI_SSLA2_PA1 | PDL_SPI_SSLA3_PA2,
        PDL_NO_DATA
    );
}

```

2) R_SPI_Create

Synopsis

Configure an SPI channel.

Prototype

```
bool R_SPI_Create(
    uint8_t data1, // Channel selection
    uint32_t data2, // Channel configuration
    uint32_t data3, // Data format
    uint32_t data4, // Extended timing control
    uint32_t data5 // Bit rate or register value
);
```

Description (1/3)

Set up the selected SPI channel.

[data1]
Select channel SPIn (where n = 0, 1 or 2).

[data2]
Configure the channel mode and connection settings.
If multiple selections are required, use “|” to separate each selection.
The default settings are shown in **bold**.

- Connection mode

PDL_SPI_MODE_SPI_MASTER or PDL_SPI_MODE_SPI_MULTI_MASTER or PDL_SPI_MODE_SPI_SLAVE or PDL_SPI_MODE_SYNC_MASTER or PDL_SPI_MODE_SYNC_SLAVE	The required SPI (four-wire) or Clock synchronous (three-wire operation) connection type.
---	---

- Reception control

PDL_SPI_FULL_DUPLEX or PDL_SPI_TRANSMIT_ONLY	Enable or disable reception operations.
--	---

- Pin control.

If output signal SSLx (where x = 0, 1, 2 or 3) is used, call function R_SPI_Set to select the respective output pin.

PDL_SPI_PIN_SSL0_LOW or PDL_SPI_PIN_SSL0_HIGH or	Select active-low or active-high for output signal SSL0.
PDL_SPI_PIN_SSL1_LOW or PDL_SPI_PIN_SSL1_HIGH or	Select active-low or active-high for output signal SSL1.
PDL_SPI_PIN_SSL2_LOW or PDL_SPI_PIN_SSL2_HIGH or	Select active-low or active-high for output signal SSL2.
PDL_SPI_PIN_SSL3_LOW or PDL_SPI_PIN_SSL3_HIGH or	Select active-low or active-high for output signal SSL3.
PDL_SPI_PIN_MOSI_IDLE_LAST or PDL_SPI_PIN_MOSI_IDLE_LOW or PDL_SPI_PIN_MOSI_IDLE_HIGH	The MOSI output state when no SSLn pin is active.

Description (2/3)

[data3]

Configure the data format. If multiple selections are required, use “|” to separate each selection. The default settings are shown in **bold**.

- Buffer size

PDL_SPI_BUFFER_64 or PDL_SPI_BUFFER_128	Select a buffer size of 64 bits (up to four 16-bit frames) or 128 bits (up to four 32-bit frames).
---	--

- Frame configuration selection (refer to Table 38.4 in the hardware manual).

Selection	Number of command transfers	Number of frames in each command transfer	Number of transfer frames
PDL_SPI_FRAME_1_1 or PDL_SPI_FRAME_1_2 or PDL_SPI_FRAME_1_3 or PDL_SPI_FRAME_1_4 or PDL_SPI_FRAME_2_1 or PDL_SPI_FRAME_2_2 or PDL_SPI_FRAME_3 or PDL_SPI_FRAME_4 or PDL_SPI_FRAME_5 or PDL_SPI_FRAME_6 or PDL_SPI_FRAME_7 or PDL_SPI_FRAME_8	1 1 1 1 2 2 3 4 5 6 7 8	1 2 3 4 1 2 1 1 1 1 1 1	1 2 3 4 2 4 3 4 5 6 7 8

- Parity bit control

PDL_SPI_PARITY_NONE or PDL_SPI_PARITY_EVEN or PDL_SPI_PARITY_ODD	Disable or enable the addition of the parity bit.
---	---

[data4]

Extended timing control (optional).
All items apply only to Master mode.
If multiple selections are required, use “|” to separate each selection.
The default settings are shown in **bold**. Specify PDL_NO_DATA if not required.

- Extended clock delay

PDL_SPI_CLOCK_DELAY_1 or PDL_SPI_CLOCK_DELAY_2 or PDL_SPI_CLOCK_DELAY_3 or PDL_SPI_CLOCK_DELAY_4 or PDL_SPI_CLOCK_DELAY_5 or PDL_SPI_CLOCK_DELAY_6 or PDL_SPI_CLOCK_DELAY_7 or PDL_SPI_CLOCK_DELAY_8	The number of bit clock periods between the assertion of the SSL pin and the start of RSPCK oscillation. Ignored in Slave mode.
---	---

- Extended SSL negation delay

PDL_SPI_SSL_DELAY_1 or PDL_SPI_SSL_DELAY_2 or PDL_SPI_SSL_DELAY_3 or PDL_SPI_SSL_DELAY_4 or PDL_SPI_SSL_DELAY_5 or PDL_SPI_SSL_DELAY_6 or PDL_SPI_SSL_DELAY_7 or PDL_SPI_SSL_DELAY_8	The number of bit clock periods between the end of RSPCK oscillation and the negation of the active SSL pin. Ignored in Slave mode.
---	---

- Extended next-access delay

PDL_SPI_NEXT_DELAY_1 or PDL_SPI_NEXT_DELAY_2 or PDL_SPI_NEXT_DELAY_3 or PDL_SPI_NEXT_DELAY_4 or PDL_SPI_NEXT_DELAY_5 or PDL_SPI_NEXT_DELAY_6 or PDL_SPI_NEXT_DELAY_7 or PDL_SPI_NEXT_DELAY_8	The number of bit clock periods (plus two cycles of the peripheral clock) between the end of one frame and the start of the next frame. Ignored in Slave mode.
---	--

Description (3/3) **[data5]**
 The format must be either:

- The maximum required bit rate.

Or:

- | | | |
|-----|-----------|--------------------------|
| b31 | b30 to b8 | b7 – b0 |
| 1 | 0 | The SPBR register value. |

If only Slave mode will be used, specify PDL_NO_DATA.

Return value True if all parameters are valid; otherwise false.

Category SPI

Reference R_CGC_Set, R_SPI_Set, R_SPI_Command

- Remarks**
- Function R_CGC_Set must be called (with the current clock source selected) before using this function.
 - Channel 2 is not available on 100-pin, 64-pin, and 48-pin packages.
 - R_IO_PORT_Set can be used to select between CMOS and Open-drain output.
 - Function R_SPI_Set must be called before any use of this function.
 - The actual bit rate will be reduced if division > 1 is specified in R_SPI_Command.

Program example

```

/* RPDL definitions */
#include "r_pdl_spi.h"

/* RPDL device-specific definitions */
#include "r_pdl_definitions.h"

void func(void)
{
    /* Configure SPI channel 0 */
    R_SPI_Create(
        0,
        PDL_SPI_MODE_SPI_MASTER | PDL_SPI_PIN_SSL0_LOW,
        PDL_SPI_FRAME_1_1,
        PDL_NO_DATA,
        2E6
    );
}
    
```

3) R_SPI_Destroy**Synopsis**

Shutdown an SPI channel.

Prototype

```
bool R_SPI_Destroy(
    uint8_t data // Channel selection
);
```

Description

Shutdown the selected SPI channel.

[data]

Select channel SPIn (where n = 0, 1 or 2).

Return value

True if all parameters are valid; otherwise false.

Category

SPI

Reference

None.

Remarks

- The SPI channel is put into the power-down state.
- Channel 2 is not available on 100-pin, 64-pin, and 48-pin packages.

Program example

```
/* RPDL definitions */
#include "r_pdl_spi.h"

/* RPDL device-specific definitions */
#include "r_pdl_definitions.h"

void func(void)
{
    /* Shutdown SPI channel 0 */
    R_SPI_Destroy(
        0
    );
}
```

4) R_SPI_Command

Synopsis Configure an SPI command.

Prototype

```
bool R_SPI_Command(
    uint8_t data1, // Channel selection
    uint8_t data2, // Command selection
    uint32_t data3, // Command options
    uint8_t data4 // Extended timing control
);
```

Description (1/2) Select the options for a command.

[data1]
Select channel SPIn (where n = 0, 1 or 2).

[data2]
Select command n (where n = 0 to 7).

[data3]
Select the command options. If multiple selections are required, use “|” to separate each selection. The default settings are shown in **bold**.

- Clock phase and polarity

	Idle clock	Data sampling edge
PDL_SPI_CLOCK_MODE_0 or PDL_SPI_CLOCK_MODE_1 or PDL_SPI_CLOCK_MODE_2 or PDL_SPI_CLOCK_MODE_3	Low	Rising
	High	Falling

- Clock division

PDL_SPI_DIV_1 or PDL_SPI_DIV_2 or PDL_SPI_DIV_4 or PDL_SPI_DIV_8	Use the bit rate (specified for R_SPI_Create) ÷ 1, 2, 4 or 8. Ignored in Slave mode.
--	---

- SSL assertion

PDL_SPI_ASSERT_SSL0 or PDL_SPI_ASSERT_SSL1 or PDL_SPI_ASSERT_SSL2 or PDL_SPI_ASSERT_SSL3	The SSL pin to be asserted during the frame transfer. Ignored in Slave mode.
--	---

- SSL negation

PDL_SPI_SSL_NEGATE or PDL_SPI_SSL_KEEP	Negate or retain the SSL signal after the frame transfer. Ignored in Slave mode.
--	---

- Frame data length

PDL_SPI_LENGTH_8 or PDL_SPI_LENGTH_9 or PDL_SPI_LENGTH_10 or PDL_SPI_LENGTH_11 or PDL_SPI_LENGTH_12 or PDL_SPI_LENGTH_13 or PDL_SPI_LENGTH_14 or PDL_SPI_LENGTH_15 or PDL_SPI_LENGTH_16 or PDL_SPI_LENGTH_20 or PDL_SPI_LENGTH_24 or PDL_SPI_LENGTH_32	The number of bits in the frame transfer. If a buffer size of 64 bits was selected when R_SPI_Create was called, the number of bits must not exceed 16.
--	--

- Data transfer format

PDL_SPI_MSB_FIRST or PDL_SPI_LSB_FIRST	Select least- or most-significant bit first.
--	--

Description (2/2)	<p>[data4] Extended timing control. If multiple selections are required, use “ ” to separate each selection. The default settings are shown in bold. For Slave mode, select PDL_NO_DATA.</p> <ul style="list-style-type: none"> Extended timing selection <table border="1" style="width: 100%;"> <tr> <td style="width: 50%;">PDL_SPI_CLOCK_DELAY_MINIMUM or PDL_SPI_CLOCK_DELAY_EXTENDED</td> <td>Select the minimum or extended delay between the assertion of the SSL pin and the start of RSPCK oscillation.</td> </tr> </table> SSL negation delay <table border="1" style="width: 100%;"> <tr> <td style="width: 50%;">PDL_SPI_SSL_DELAY_MINIMUM or PDL_SPI_SSL_DELAY_EXTENDED</td> <td>Select the minimum or extended delay between the end of RSPCK oscillation and the negation of the active SSL pin.</td> </tr> </table> Next-access delay <table border="1" style="width: 100%;"> <tr> <td style="width: 50%;">PDL_SPI_NEXT_DELAY_MINIMUM or PDL_SPI_NEXT_DELAY_EXTENDED</td> <td>Select the minimum or extended delay between the end of one frame and the start of the next frame.</td> </tr> </table> 	PDL_SPI_CLOCK_DELAY_MINIMUM or PDL_SPI_CLOCK_DELAY_EXTENDED	Select the minimum or extended delay between the assertion of the SSL pin and the start of RSPCK oscillation.	PDL_SPI_SSL_DELAY_MINIMUM or PDL_SPI_SSL_DELAY_EXTENDED	Select the minimum or extended delay between the end of RSPCK oscillation and the negation of the active SSL pin.	PDL_SPI_NEXT_DELAY_MINIMUM or PDL_SPI_NEXT_DELAY_EXTENDED	Select the minimum or extended delay between the end of one frame and the start of the next frame.
PDL_SPI_CLOCK_DELAY_MINIMUM or PDL_SPI_CLOCK_DELAY_EXTENDED	Select the minimum or extended delay between the assertion of the SSL pin and the start of RSPCK oscillation.						
PDL_SPI_SSL_DELAY_MINIMUM or PDL_SPI_SSL_DELAY_EXTENDED	Select the minimum or extended delay between the end of RSPCK oscillation and the negation of the active SSL pin.						
PDL_SPI_NEXT_DELAY_MINIMUM or PDL_SPI_NEXT_DELAY_EXTENDED	Select the minimum or extended delay between the end of one frame and the start of the next frame.						
Return value	True if all parameters are valid; otherwise false.						
Category	SPI						
Reference	R_SPI_Create						
Remarks	<ul style="list-style-type: none"> For Slave mode operation, configure command 0. When Clock-synchronous Slave mode is used, avoid selecting mode 0 or mode 2. If parity is enabled while in Master mode, both the frame data length and data transfer format should be the same for each command. Channel 2 is not available on 100-pin, 64-pin, and 48-pin packages. 						

Program example

```

/* RPDL definitions */
#include "r_pdl_spi.h"

/* RPDL device-specific definitions */
#include "r_pdl_definitions.h"

void func(void)
{
    /* Configure SPI channel 0 commands 0 and 1 */
    R_SPI_Command(
        0,
        0,
        PDL_SPI_CLOCK_MODE_0 | PDL_SPI_ASSERT_SSL0 | \
        PDL_SPI_LENGTH_8 | PDL_SPI_MSB_FIRST,
        PDL_NO_DATA
    );

    R_SPI_Command(
        0,
        1,
        PDL_SPI_CLOCK_MODE_1 | PDL_SPI_ASSERT_SSL1 | \
        PDL_SPI_LENGTH_8 | PDL_SPI_LSB_FIRST,
        PDL_NO_DATA
    );
}

```

5) R_SPI_Transfer

Synopsis

Transfer data over an SPI channel.

Prototype

```
bool R_SPI_Transfer(
    uint8_t data1, // Channel selection
    uint8_t data2, // DMAC / DTC control
    uint32_t * data3, // Transmit data start address
    uint32_t * data4, // Receive data start address
    uint16_t data5, // Sequence loop count
    void * func1, // Callback function
    uint8_t data6, // Interrupt priority level
    void * func2, // Callback function
    uint8_t data7 // Interrupt priority level
);
```

Description(1/2)

In Master mode, transfer the data to and / or from the Slave device.
 In Slave mode, transfer the data under control of the Master device.

[data1]
 Select channel SPIn (where n = 0, 1 or 2).

[data2]
 Select the automatic data transfer options.
 The default setting is shown in **bold**. Specify PDL_NO_DATA to use the default.

- DMAC / DTC trigger control

PDL_SPI_DMTC_TRIGGER_DISABLE or PDL_SPI_DMTC_TRIGGER_ENABLE or PDL_SPI_DTC_TRIGGER_ENABLE	Disable or enable activation of the DMAC or DTC for data transmission and reception.
--	--

[data3]
 The start address of the data to be transmitted. The data must be stored as 32-bit values. Specify PDL_NO_PTR if no data is to be transmitted (or if the data content is not important), or if the DMAC or DTC shall be used to handle the data transfer.

[data4]
 The start address of the data to be received. The data will be stored as 32-bit values. Specify PDL_NO_PTR if no data is to be received, or if the DMAC or DTC shall be used to handle the data transfer.

[data5]
 The number of times that the command sequence will be executed.
 The value should not be zero if the DMAC and DTC trigger are disabled.

[func1]
 Specify PDL_NO_FUNC or a callback function name, depending on the required transfer method.

Transfer method	Parameter
Polling	PDL_NO_FUNC. R_SPI_Transfer will handle the data transfer until completion.
Interrupts	The function to be called when the transfer has completed.
DMAC or DTC	The function to be called when the DMAC or DTC passes on the transfer interrupt.

[data6]
 The interrupt priority level for data transmission. Select between 1 (lowest priority) and 15 (highest priority).
 This parameter will be ignored if PDL_NO_FUNC is specified for parameter func1.

[func2]
 The function to be called if an error occurs. Specify PDL_NO_FUNC to ignore errors.

Description(2/2)	<p>[data7] The interrupt priority level for error detection. Select between 1 (lowest priority) and 15 (highest priority). This parameter will be ignored if PDL_NO_FUNC is specified for parameter func2. Use the same error interrupt priority level as R_SCI_Create parameter data5.</p>
Return value	True if all parameters are valid; otherwise false.
Category	SPI
Reference	R_SPI_Create
Remarks	<ul style="list-style-type: none"> • The amount of data for must match the total number of transfer frames (refer to parameter data3 in R_SPI_Create). • If a callback function is specified and DMAC / DTC control is not used, interrupts are used to handle the data transfer. Please see the notes on callback function usage in §6. • If an error interrupt function is specified for parameter func 2 while PDL_NO_FUNC is specified for parameter func 1, the error flag is polled without using an interrupt, and the error interrupt function will be called when an error occurs. • After using this function, use R_SPI_GetStatus to check for and clear any error flags. • Channel 2 is not available on 100-pin, 64-pin, and 48-pin packages.

Program example

```

/* RPDL definitions */
#include "r_pdl_spi.h"

/* RPDL device-specific definitions */
#include "r_pdl_definitions.h"

void func(void)
{
    uint32_t transmit_data[8];
    uint32_t receive_data[8];

    /* Transmit and receive all enabled frames once */
    R_SPI_Transfer(
        0,
        PDL_NO_DATA,
        transmit_data,
        receive_data,
        1,
        PDL_NO_FUNC,
        0,
        PDL_NO_FUNC,
        0
    );
}

```

6) R_SPI_Control

Synopsis Control an SPI channel.

Prototype

```
bool R_SPI_Control(
    uint8_t data1, // Channel selection
    uint8_t data2, // Control options
    uint32_t data3 // Extended timing control
);
```

Description Modify the operation of the selected SPI channel.

[data1]
Select channel SPIn (where n = 0, 1 or 2).

[data2]
Control the channel. If multiple selections are required, use “|” to separate each selection. All items are optional. Specify PDL_NO_DATA if not required.

- Channel control

PDL_SPI_DISABLE	Disable and partially initialise the SPI channel.
-----------------	---
- Loopback control

PDL_SPI_LOOPBACK_DISABLE or PDL_SPI_LOOPBACK_DIRECT or PDL_SPI_LOOPBACK_REVERSED	Disable or enable loopback in direct or reversed mode.
--	--

[data3]
Extended timing control (optional). All items apply only to Master mode. Specify PDL_NO_DATA if not required. If multiple selections are required, use “|” to separate each selection.

- Extended clock delay

PDL_SPI_CLOCK_DELAY_1 or PDL_SPI_CLOCK_DELAY_2 or PDL_SPI_CLOCK_DELAY_3 or PDL_SPI_CLOCK_DELAY_4 or PDL_SPI_CLOCK_DELAY_5 or PDL_SPI_CLOCK_DELAY_6 or PDL_SPI_CLOCK_DELAY_7 or PDL_SPI_CLOCK_DELAY_8	The number of bit clock periods between the assertion of the SSL pin and the start of RSPCK oscillation. Ignored in Slave mode.
---	---
- Extended SSL negation delay

PDL_SPI_SSL_DELAY_1 or PDL_SPI_SSL_DELAY_2 or PDL_SPI_SSL_DELAY_3 or PDL_SPI_SSL_DELAY_4 or PDL_SPI_SSL_DELAY_5 or PDL_SPI_SSL_DELAY_6 or PDL_SPI_SSL_DELAY_7 or PDL_SPI_SSL_DELAY_8	The number of bit clock periods between the end of RSPCK oscillation and the negation of the active SSL pin. Ignored in Slave mode.
---	---
- Extended next-access delay

PDL_SPI_NEXT_DELAY_1 or PDL_SPI_NEXT_DELAY_2 or PDL_SPI_NEXT_DELAY_3 or PDL_SPI_NEXT_DELAY_4 or PDL_SPI_NEXT_DELAY_5 or PDL_SPI_NEXT_DELAY_6 or PDL_SPI_NEXT_DELAY_7 or PDL_SPI_NEXT_DELAY_8	The number of bit clock periods (plus two cycles of the peripheral clock) between the end of one frame and the start of the next frame. Ignored in Slave mode.
---	--

Return value True if all parameters are valid; otherwise false.

Category SPI

Reference

R_SPI_Create

Remarks

- If a channel is disabled using PDL_SPI_DISABLE, call R_SPI_Create to resume channel operations.
- Channel 2 is not available on 100-pin, 64-pin, and 48-pin packages.

Program example

```
/* RPDL definitions */
#include "r_pdl_spi.h"

/* RPDL device-specific definitions */
#include "r_pdl_definitions.h"

void func(void)
{
    /* Enable direct loopback mode */
    R_SPI_Control(
        0,
        PDL_SPI_LOOPBACK_DIRECT,
        PDL_NO_DATA
    );

    /* Change the extended timings */
    R_SPI_Control(
        0,
        PDL_NO_DATA,
        PDL_SPI_CLOCK_DELAY_8 | PDL_SPI_SSL_DELAY_5
    );
}
```

7) R_SPI_GetStatus

Synopsis Check the status of an SPI channel.

Prototype

```
bool R_SPI_GetStatus(
    uint8_t data1, // Channel selection
    uint16_t * data2, // Status flags
    uint16_t * data3 // Sequence count
);
```

Description Acquires the SPI channel status.

[data1]
Select channel SPIn (where n = 0 , 1 or 2).

[data2]
The status flags shall be stored in the format below.
Specify PDL_NO_PTR if this information is not required

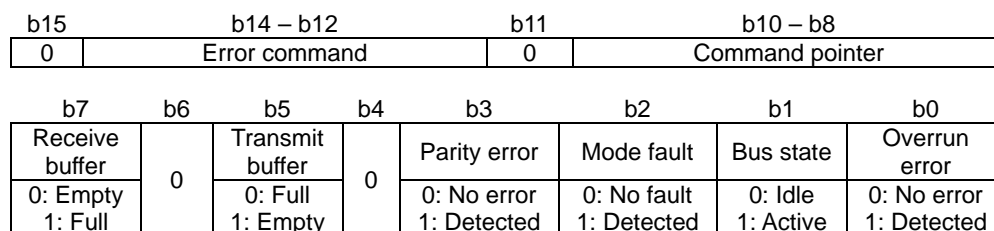

[data3]
The storage location for the number of sequence loops that have been completed in the current transfer. Specify PDL_NO_PTR if this information is not required.

Return value True if all parameters are valid; otherwise false.

Category SPI

Reference None.

Remarks

- If the status flags are read and an error or fault flag is set to 1, the flag will be cleared to 0 by this function.
- Channel 2 is not available on 100-pin, 64-pin, and 48-pin packages.

Program example

```
/* RPDL definitions */
#include "r_pdl_spi.h"

/* RPDL device-specific definitions */
#include "r_pdl_definitions.h"

void func(void)
{
    uint16_t StatusValue;

    /* Read the status of channel 0 */
    R_SPI_GetStatus(
        0,
        &StatusValue,
        PDL_NO_PTR
    );
}
```

4.2.26. IEBus Controller

1) R_IEB_Set

Synopsis

Configure the IEBus pin selection.

Prototype

```
bool R_IEB_Set(
    uint8_t data    // Pin selection
);
```

Description

Set up the IEBus options.

[data]

Configure the IEBus module. Use “|” to separate each selection.

- IERXD pin selection

PDL_IEB_PIN_IERXD_P16 or PDL_IEB_PIN_IERXD_PC2	Select the IERXD pin (optional).
---	----------------------------------

- IETXD pin selection

PDL_IEB_PIN_IETXD_P17 or PDL_IEB_PIN_IETXD_PC3	Select the IETXD pin.
---	-----------------------

Return value

True if all parameters are valid, exclusive and achievable; otherwise false.

Category

IEBus

Reference

R_IEB_Create

Remarks

- Before calling R_IEB_Create, call this function to specify the relevant pins.

Program example

```
/* RPDL definitions */
#include "r_pdl_ieb.h"

/* RPDL device-specific definitions */
#include "r_pdl_definitions.h"

void func(void)
{
    /* Use port 1 for the IEBus pins */
    R_IEB_Set(
        PDL_IEB_PIN_IERXD_P16 | PDL_IEB_PIN_IETXD_P17
    );
}
```

2) R_IEB_Create

Synopsis

Configure the IEBus channel.

Prototype

```
bool R_IEB_Create(
    uint8_t data1, // Channel selection
    uint32_t data2, // Channel configuration
    uint16_t data3, // Unit address
    uint8_t data4 // Interrupt priority level
);
```

Description

Set up the selected IEBus channel.

[data1]
Select channel n (where n = 0 only).

[data2]
Configure the channel mode and connection settings.
If multiple selections are required, use “|” to separate each selection.
The default settings are shown in **bold**.

- Module clock frequency division

PDL_IEB_CLOCK_INTEGER or PDL_IEB_CLOCK_VGA or	Select between integer type e.g. 12.0 MHz and VGA-derived type e.g. 12.58 MHz for the IEBus clock (IECLK) frequency. The division applied to IECLK will be determined by this function.
PDL_IEB_CLOCK_IECLK_DIV_2 or PDL_IEB_CLOCK_IECLK_DIV_3 or PDL_IEB_CLOCK_IECLK_DIV_4 or PDL_IEB_CLOCK_IECLK_DIV_5 or PDL_IEB_CLOCK_IECLK_DIV_6 or PDL_IEB_CLOCK_IECLK_DIV_7	Alternatively, the division applied to IECLK can be specified directly.

- Communication mode

PDL_IEB_MODE_0 or PDL_IEB_MODE_1	The communication mode.
--	-------------------------

- Reception control

PDL_IEB_RX_ENABLE or PDL_IEB_RX_DISABLE	Enable or disable reception.
---	------------------------------

- Input / Output polarity control

PDL_IEB_POLARITY_LOW or PDL_IEB_POLARITY_HIGH	Select active-low or active-high polarity.
---	--

- Digital filter control

PDL_IEB_FILTER_IECLK_DIV_1 or PDL_IEB_FILTER_IECLK_DIV_2 or PDL_IEB_FILTER_IECLK_DIV_3 or PDL_IEB_FILTER_IECLK_DIV_4 or PDL_IEB_FILTER_DISABLE	Disable or enable the digital filter using the IEBus clock (IECLK) ÷ 1, 2, 3 or 4.
---	---

[data3]
The unit address, valid from 0000h to 0FFFh.

[data4]
The interrupt priority level. Select between 0 (disabled) and 15 (highest priority).

Return value

True if all parameters are valid and pins have been selected; otherwise false.

Category

IEBus

Reference

R_CGC_Set, R_IEB_Set

Remarks

- Functions R_CGC_Set and R_IEB_Set must be called before any use of this function.
- If the digital filter clock division of 2, 3, or 4 is selected, it must be an integer of the IECLK ÷ 6.0 (or 6.29375 for the VGA type).
- If automatic calculation of the module clock division is selected, a tolerance of ±1.5% is used when checking the IECLK frequency.

Program example

```
/* RPDL definitions */
#include "r_pdl_ieb.h"

/* RPDL device-specific definitions */
#include "r_pdl_definitions.h"

void func(void)
{
    /* Configure IEBus channel 0 */
    R_IEB_Create(
        0,
        PDL_IEB_MODE_0 | PDL_IEB_POLARITY_HIGH,
        0x0123,
        15
    );
}
```

3) R_IEB_Destroy

Synopsis

Shutdown an IEBus channel.

Prototype

```
bool R_IEB_Destroy(  
    uint8_t data // Channel selection  
);
```

Description

Shutdown the selected IEBus channel.

[data]

Select channel n (where n = 0 only).

Return value

True if all parameters are valid; otherwise false.

Category

IEBus

Reference

None.

Remarks

- The IEBus module is put into the power-down state.

Program example

```
/* RPDL definitions */  
#include "r_pdl_ieb.h"  
  
/* RPDL device-specific definitions */  
#include "r_pdl_definitions.h"  
  
void func(void)  
{  
    /* Shutdown IEB channel 0 */  
    R_IEB_Destroy(  
        0  
    );  
}
```

4) R_IEB_MasterSend

Synopsis Transmit data over an IEBus channel.

Prototype

```
bool R_IEB_MasterSend(
    uint8_t data1, // Channel selection
    uint16_t data2, // Communication configuration
    uint16_t data3, // Slave address
    uint8_t * data4, // Data storage start address
    uint8_t data5, // Data length
    void * func // Callback function
);
```

Description Transmit data on the specified channel.

[data1]
Select channel n (where n = 0 only).

[data2]
Configure the channel mode and connection settings.
If multiple selections are required, use “|” to separate each selection.
The default settings are shown in **bold**.

- Communication type

PDL_IEB_NORMAL or PDL_IEB_BROADCAST	Select Normal (one-to-one) or Broadcast (one-to-many).
--	--

- Data type and control

PDL_IEB_COMMAND or PDL_IEB_DATA	The slave shall interpret the data field as a command or data.
--	--

- Re-transmission count

PDL_IEB_RETRY_0 or PDL_IEB_RETRY_1 or PDL_IEB_RETRY_2 or PDL_IEB_RETRY_3 or PDL_IEB_RETRY_4 or PDL_IEB_RETRY_5 or PDL_IEB_RETRY_6 or PDL_IEB_RETRY_7	The number of re-transmissions to be attempted if arbitration is lost.
---	--

[data3]
The slave address, valid from 0000h to 0FFFh.

[data4]
The start address of the data to be transmitted in the data field.

[data5]
The number of data field bytes to be transmitted. Valid from 1 to 16 (mode 0) or 32 (mode 1).

[func]
Specify **PDL_NO_FUNC** or a callback function, depending on the required transfer method.

Transfer method	Parameter
Polling	PDL_NO_FUNC . This function will handle the data transfer until completion or an error occurs.
Interrupts	The function to be called when the transfer has completed or an error has occurred. Parameter data4 in R_IEB_Create must not be 0.

Return value True if all parameters are valid, exclusive and achievable, the channel was available and a normal transfer completed (when polling); otherwise false.

Category IEBus

Reference R_IEB_Create

Remarks

- If a callback function is specified, interrupts are used. The callback function may be called more than once during a transfer. Use R_IEB_GetStatus in the callback function to identify the activity that has occurred. Please see the notes on callback function usage in §6.
- In polling mode this function will use the status flags to monitor the data transmission. If the IEBus channel's registers are modified directly by the user, this function may lock up.

Program example

```
/* RPDL definitions */
#include "r_pdl_ieb.h"

/* RPDL device-specific definitions */
#include "r_pdl_definitions.h"

void func(void)
{
    uint8_t iebus_data[32];
    uint8_t iebus_data_length = 10;

    /* Send data to slave 456h */
    R_IEB_MasterSend(
        0,
        PDL_IEB_DATA,
        0x0456,
        iebus_data,
        iebus_data_length,
        PDL_NO_FUNC
    );
}
```

5) R_IEB_MasterReceive

Synopsis Receive data over an IEBus channel.

Prototype

```
bool R_IEB_MasterReceive(
    uint8_t data1, // Channel selection
    uint16_t data2, // Communication configuration
    uint16_t data3, // Slave address
    uint8_t * data4, // Data storage start address
    uint8_t * data5, // Data length storage address
    void * func // Callback function
);
```

Description Receive data on the specified channel.

[data1]
Select channel n (where n = 0 only).

[data2]
Configure the channel mode and connection settings.
If multiple selections are required, use “|” to separate each selection.
The default settings are shown in **bold**.

- Data type and control

PDL_IEB_STATUS or PDL_IEB_LOCKED_ADDRESS_UPPER or PDL_IEB_LOCKED_ADDRESS_LOWER or PDL_IEB_DATA	The slave shall send the specified data in the data field.
PDL_IEB_UNLOCK	After sending the status, the slave will unlock. Optional, applicable only if Status is selected above.

- Re-transmission count

PDL_IEB_RETRY_0 or PDL_IEB_RETRY_1 or PDL_IEB_RETRY_2 or PDL_IEB_RETRY_3 or PDL_IEB_RETRY_4 or PDL_IEB_RETRY_5 or PDL_IEB_RETRY_6 or PDL_IEB_RETRY_7	The number of re-transmissions to be attempted if arbitration is lost.
--	--

[data3]
The slave address, valid from 0000h to 0FFFh.

[data4]
The start address of the area for storing the data to be received in the data field.

[data5]
The address of the area for storing the number of bytes that were received in the data field.

[func]
Specify PDL_NO_FUNC or a callback function, depending on the required transfer method.

Transfer method	Parameter
Polling	PDL_NO_FUNC. This function will handle the data transfer until completion or another event occurs.
Interrupts	The function to be called whenever a transfer has completed or another event has occurred. Parameter data4 in R_IEB_Create must not be 0.

Return value True if all parameters are valid, exclusive and achievable, the channel was available and a normal transfer completed (when polling); otherwise false.

Category IEBus

Reference R_IEB_Create

Remarks

- If a callback function is specified, interrupts are used. The callback function may be called more than once during a transfer. Use R_IEB_GetStatus in the callback function to identify the activity that has occurred. Please see the notes on callback function usage in §6.
- In polling mode this function will use the status flags to monitor the data reception. If the IEBus channel's registers are modified directly by the user, this function may lock up.

Program example

```
/* RPDL definitions */
#include "r_pdl_ieb.h"

/* RPDL device-specific definitions */
#include "r_pdl_definitions.h"

/* Callback function */
void CallBackFunc( void ){}

void func(void)
{
    uint8_t iebus_data[32];
    uint8_t iebus_data_length;

    /* Read data from slave 345h */
    R_IEB_MasterReceive(
        0,
        PDL_IEB_DATA,
        0x0345,
        iebus_data,
        &iebus_data_length,
        CallBackFunc
    );
}
```

6) R_IEB_SlaveMonitor

Synopsis

Monitor the IEBus.

Prototype

```
bool R_IEB_SlaveMonitor(
    uint8_t data1, // Channel selection
    uint8_t * data2, // Data storage start address
    uint8_t * data3, // Data length storage address
    void * func // Callback function
);
```

Description

Monitor the bus until an address match occurs and store any data received.

[data1]

Select channel n (where n = 0 only).

[data2]

The start address of the area for storing the data to be received in the data field.

[data3]

The address of the area for storing the number of bytes that were received in the data field.

[func]

Specify PDL_NO_FUNC or a callback function, depending on the required transfer method.

Transfer method	Parameter
Polling	PDL_NO_FUNC. This function will continue until data is received or another event occurs.
Interrupts	The function to be called whenever data is received or another event occurs. Parameter data4 in R_IEB_Create must not be 0.

Return value

True if all parameters are valid, exclusive and achievable; otherwise false.

Category

IEBus

Reference

R_IEB_Create, R_IEB_GetStatus

Remarks

- If a callback function is specified, interrupts are used. The callback function may be called more than once during a transfer. Please see the notes on callback function usage in §6.
- Use 9) to identify the activity that has occurred.
- In polling mode this function will use the status flags to monitor the IEBus activity. If the IEBus channel's registers are modified directly by the user, this function may lock up.

Program example

```
/* RPDL definitions */
#include "r_pdl_ieb.h"

/* RPDL device-specific definitions */
#include "r_pdl_definitions.h"

void func(void)
{
    uint8_t iebus_data[32];
    uint8_t iebus_data_length;

    /* Monitor channel 0, using polling */
    R_IEB_SlaveMonitor(
        0,
        iebus_data,
        &iebus_data_length,
        PDL_NO_FUNC
    );
}
```

7) R_IEB_SlaveWrite

Synopsis

Prepare data for sending to a master unit.

Prototype

```
bool R_IEB_SlaveWrite(
    uint8_t data1,    // Channel selection
    uint8_t * data2, // Data storage start address
    uint8_t data3    // Data length
);
```

Description

Store data for transmission when requested by a master.

[data1]

Select channel n (where n = 0 only).

[data2]

The start address of the data to be transmitted in the data field.

[data3]

The number of data field bytes to be transmitted. Valid from 1 to 16 (mode 0) or 32 (mode 1).

Return value

True if all parameters are valid, otherwise false.

Category

IEBus

Reference

R_IEB_SlaveMonitor

Remarks

- If interrupts are required, use R_IEB_SlaveMonitor to manage the data transfer.

Program example

```
/* RPDL definitions */
#include "r_pdl_ieb.h"

/* RPDL device-specific definitions */
#include "r_pdl_definitions.h"

void func(void)
{
    uint8_t iebus_data[32];
    uint8_t iebus_data_length;

    /* Prepare data for transmission when requested */
    R_IEB_SlaveWrite(
        0,
        iebus_data,
        iebus_data_length
    );
}
```

8) R_IEB_Control

Synopsis

Change the IEBus channel configuration.

Prototype

```
bool R_IEB_Control(
    uint8_t data1, // Channel selection
    uint32_t data2, // Channel control
    uint16_t data3 // Unit address
);
```

Description

Set up the selected IEBus channel.

[data1]

Select channel n (where n = 0 only).

[data2]

Modify the channel mode and connection settings.

If multiple selections are required, use “|” to separate each selection.

- Connection mode

PDL_IEB_MODE_0 or PDL_IEB_MODE_1	The communication mode.
-------------------------------------	-------------------------

- Reception control

PDL_IEB_RX_ENABLE or PDL_IEB_RX_DISABLE	Enable or disable reception.
--	------------------------------

- Input / Output polarity control

PDL_IEB_POLARITY_LOW or PDL_IEB_POLARITY_HIGH	Select active-low or active-high polarity.
--	--

- Digital filter control

PDL_IEB_FILTER_IECLK_DIV_1 or PDL_IEB_FILTER_IECLK_DIV_2 or PDL_IEB_FILTER_IECLK_DIV_3 or PDL_IEB_FILTER_IECLK_DIV_4 or PDL_IEB_FILTER_DISABLE	Disable or enable the digital filter using the IEBus clock (IECLK) ÷ 1, 2, 3 or 4.
--	--

- Reset control

PDL_IEB_RESET_ENABLE or PDL_IEB_RESET_DISABLE	Enable or disable the IEBus module reset signal.
--	--

- Slave state control

PDL_IEB_SLAVE_TX_HALTED or PDL_IEB_SLAVE_TX_ENABLED	Set the slave transmission status bit in the slave status.
--	--

- Broadcast receive error interrupt control

PDL_IEB_BROADCAST_ERROR_ENABLE or PDL_IEB_BROADCAST_ERROR_DISABLE	Enable or disable interrupts due to broadcast reception errors.
--	---

- Internal command control

PDL_IEB_CANCEL_LOCK or PDL_IEB_CANCEL_TRANSFER	Cancel the lock required from other units (not applicable in slave operation). Stop the current transfer.
---	--

- Unit address update control

PDL_IEB_UPDATE_ADDRESS	Replace the unit address using parameter data3.
------------------------	---

[data3]

The unit address, valid from 0000h to 0FFFh.

Return value

True if all parameters are valid; otherwise false.

Category

IEBus

Reference**Remarks**

- The validity of the digital filter division (when ÷ 2, 3, or 4 is selected) is not checked.

Program example

```
/* RPD_L definitions */
#include "r_pdl_ieb.h"

/* RPD_L device-specific definitions */
#include "r_pdl_definitions.h"

void func(void)
{
    /* Change the IEBus mode to 1 and the unit address to 078h */
    R_IEB_Control(
        0,
        PDL_IEB_MODE_1 | PDL_IEB_UPDATE_ADDRESS,
        0x0078
    );
}
```

9) R_IEB_GetStatus

Synopsis Check the status of an IEBus channel.

Prototype

```
bool R_IEB_GetStatus(
    uint8_t data1, // Channel selection
    uint16_t * data2, // General status flags
    uint8_t * data3, // Transmit status flags
    uint32_t * data4, // Receive status flags
    uint16_t * data5, // Unit address
    uint16_t * data6 // Unit address
);
```

Description (1/2) Acquires the IEBus channel status.

[data1]
Select channel n (where n = 0 only).

[data2]
The General status flags shall be stored in the format below.
Specify PDL_NO_PTR if this information is not required.

b15 – b11		b10 - b8	
0		The division applied to the IECLK clock signal	
b7	b6	b5	b4
Internal command execution	Master communication	Slave communication	
0: Idle 1: Active	0: Idle 1: Active	Transmission	Reception
		0: Idle 1: Active	0: Idle 1: Active
b3	b2	b1	b0
0: Unlocked 1: Locked	0	Communication type	General broadcast
		0: Broadcast 1: Normal	0: None 1: Detected

[data3]
The Transmit status flags shall be stored in the format below.
Specify PDL_NO_PTR if this information is not required.

b7	b6	b5	b4
0	Master address	Completion	0
	0: Not sent 1: Sent	0: Not occurred 1: Occurred	
b3	b2	b1	b0
Arbitration loss	Timing error	Overflow	Acknowledge
0: Not occurred 1: Occurred	0: Not occurred 1: Occurred	0: Not occurred 1: Occurred	0: NAK not detected 1: NAK detected

Description (2/2)

[data4]

The Receive status flags shall be stored in the format below.
Specify PDL_NO_PTR if this information is not required.

b31 – b24		b23 – b16	
0		The received message length	
b15 – b12		b11 – b8	
0		The received command (valid only in slave or broadcast reception)	
b7	b6	b5	b4
Busy	Reception	Normal completion	Broadcast error
0: Data is not ready 1: Data is ready	0: Not started 1: Started	0: Not occurred 1: Occurred	0: Not occurred 1: Occurred
b3	b2	b1	b0
Overrun	Timing error	Overflow	Parity error
0: Not occurred 1: Occurred	0: Not occurred 1: Occurred	0: Not occurred 1: Occurred	0: Not occurred 1: Occurred

[data5]

The last master unit address received during reception.
Specify PDL_NO_PTR if this information is not required.

[data6]

The address of the master unit that has issued a lock request.
Specify PDL_NO_PTR if this information is not required.

Return value

True if all parameters are valid; otherwise false.

Category

IEBus

Reference

None

Remarks

- Any Transmit and Receive status flags that are read as 1 are cleared to 0 by this function. In the Receive case this will allow the slave to receive more data.

Program example

```

/* RPDL definitions */
#include "r_pdl_ieb.h"

/* RPDL device-specific definitions */
#include "r_pdl_definitions.h"

void func(void)
{
    uint16_t StatusValue;

    /* Read the status of channel 0 */
    R_IEB_GetStatus(
        0,
        &StatusValue,
        PDL_NO_PTR,
        PDL_NO_PTR,
        PDL_NO_PTR,
        PDL_NO_PTR
    );
}

```

4.2.27. CRC calculator

1) R_CRC_Create

Synopsis

Configure the CRC calculator.

Prototype

```
bool R_CRC_Create(
    uint8_t data // Configuration
);
```

Description

Enable the CRC and set the operating conditions.

[data]

Calculation options. To set multiple options at the same time, use "|" to separate each value.

• Polynomial selection

PDL_CRC_POLY_CRC_8 or	$X^8 + X^2 + X + 1$
PDL_CRC_POLY_CRC_16 or	$X^{16} + X^{15} + X^2 + 1$
PDL_CRC_POLY_CRC_CCITT	$X^{16} + X^{12} + X^5 + 1$

• Bit order

PDL_CRC_LSB_FIRST or PDL_CRC_MSB_FIRST	Select LSB or MSB-first operation.
---	------------------------------------

Return value

True if all parameters are valid and exclusive; otherwise false.

Category

CRC

References

None.

Remarks

- None.

Program example

```
/* RPDL definitions */
#include "r_pdl_crc.h"

/* RPDL device-specific definitions */
#include "r_pdl_definitions.h"

void func(void)
{
    /* Set up the CRC in 8-bit mode with LSB first */
    R_CRC_Create(
        PDL_CRC_POLY_CRC_8 | PDL_CRC_LSB_FIRST
    );
}
```

2) R_CRC_Destroy

Synopsis

Shut down the CRC calculator.

Prototype

```
bool R_CRC_Destroy(  
    void // No parameter is required  
);
```

Description

Put the CRC calculator into the Power-down state, with minimal power consumption.

Return value

True.

Category

CRC

Reference

R_CRC_Create

Remarks

- None.

Program example

```
/* RPDL definitions */  
#include "r_pdl_crc.h"  
  
/* RPDL device-specific definitions */  
#include "r_pdl_definitions.h"  
  
void func( void )  
{  
    /* Shut down the CRC */  
    R_CRC_Destroy(  
        );  
}
```

3) R_CRC_Write**Synopsis**

Write data into the CRC calculation register.

Prototype

```
bool R_CRC_Write(
    uint8_t data    // The data to be used for the calculation
);
```

Description

Write the data into the data input register.

[data]

The data to be written into the register.

Return value

True.

Category

CRC

Reference

R_CRC_Create

Remarks

- None.

Program example

```
/* RPD_L definitions */
#include "r_pdl_crc.h"

/* RPD_L device-specific definitions */
#include "r_pdl_definitions.h"

void func(void)
{
    /* Write F0h into the CRC calculation register */
    R_CRC_Write(
        0xF0
    );
}
```

4) R_CRC_Read

Synopsis

Read the CRC calculation result.

Prototype

```
bool R_CRC_Read(
    uint8_t data1,    // Control
    uint16_t * data2 // Data storage location
);
```

Description

Reads and stores the CRC calculation result.

[data1]

Control the behaviour of the CRC unit.

The default setting is shown in **bold**. Specify PDL_NO_DATA to use the default.

- Result register clearing

PDL_CRC_CLEAR_RESULT or PDL_CRC_RETAIN_RESULT	Clear or retain the value in the result register.
--	---

[data2]

The address of the location where the result shall be stored.

For the 8-bit polynomial, the results are stored in the lower-order byte.

Return value

True.

Category

CRC

Reference

R_CRC_Create, R_CRC_Write

Remarks

- None.

Program example

```
/* RPDL definitions */
#include "r_pdl_crc.h"

/* RPDL device-specific definitions */
#include "r_pdl_definitions.h"

void func(void)
{
    uint16_t CRCresult;

    /* Read the CRC result and clear it */
    R_CRC_Read(
        PDL_CRC_RETAIN_RESULT,
        &CRCresult
    );
}
```

4.2.28. 12-bit Analog to Digital Converter

1) R_ADC_12_Create

Synopsis

Configure the 12-bit ADC unit.

Prototype

```
bool R_ADC_12_Create(
    uint8_t data1, // Unit selection
    uint32_t data2, // Channel
    uint32_t data3, // Configuration
    uint16_t data4, // Trigger selection
    uint32_t data5, // Value addition mode options
    double data6, // Sampling time for analog inputs (excluding temperature sensor)
    double data7, // Sampling time for temperature sensor
    void * func, // Callback function
    uint8_t data8 // Interrupt priority level
);
```

Description (1/4)

Set the ADC mode and operating condition.

[data1]

Select the ADC unit to be configured. This must always be 0.

[data2]

Channel selection. To set multiple channels at the same time, use “|” to separate each value. Set PDL_NO_DATA if reading the temperature sensor or an internal reference voltage rather than analog pins.

- Input channel selection

PDL_ADC_12_CHANNEL_0
PDL_ADC_12_CHANNEL_1
PDL_ADC_12_CHANNEL_2
PDL_ADC_12_CHANNEL_3
PDL_ADC_12_CHANNEL_4
PDL_ADC_12_CHANNEL_5
PDL_ADC_12_CHANNEL_6
PDL_ADC_12_CHANNEL_7
PDL_ADC_12_CHANNEL_8
PDL_ADC_12_CHANNEL_9
PDL_ADC_12_CHANNEL_10
PDL_ADC_12_CHANNEL_11
PDL_ADC_12_CHANNEL_12
PDL_ADC_12_CHANNEL_13
PDL_ADC_12_CHANNEL_14
PDL_ADC_12_CHANNEL_15
PDL_ADC_12_CHANNEL_16
PDL_ADC_12_CHANNEL_17
PDL_ADC_12_CHANNEL_18
PDL_ADC_12_CHANNEL_19
PDL_ADC_12_CHANNEL_20

Carry out a conversion on each of the selected channels AN0 to AN20.

Description (2/4)**[data3]**

Conversion options. To set multiple options at the same time, use “|” to separate each value. The default settings are shown in **bold**.

• Scan mode

PDL_ADC_12_SCAN_SINGLE or PDL_ADC_12_SCAN_CONTINUOUS	Select Single scan or Continuous scan mode. See the Remarks section, Continuous mode is only available when reading the analog inputs.
---	--

• Clock division

PDL_ADC_12_DIV_1 or PDL_ADC_12_DIV_2 or PDL_ADC_12_DIV_4 or PDL_ADC_12_DIV_8	Use the peripheral clock, PCLK ÷ 1, 2, 4 or 8.
---	--

• Data alignment

PDL_ADC_12_DATA_ALIGNMENT_LEFT or PDL_ADC_12_DATA_ALIGNMENT_RIGHT	The alignment of the 12-bit ADC conversion result within the 16-bit register. Ignored for channels using value addition mode (the 14-bit result is always left-aligned).
---	--

• Result register clearing

PDL_ADC_12_RETAIN_RESULT or PDL_ADC_12_CLEAR_RESULT	Retain or clear the value in each result register after it has been read.
---	---

• Input source

PDL_ADC_12_INPUT_AN or PDL_ADC_12_INPUT_TS or PDL_ADC_12_INPUT_REF	Select input from analog channels, the temperature sensor, or the internal reference voltage.
---	---

• DMAC / DTC trigger control

PDL_ADC_12_DMACE_TRIGGER_DISABLE or PDL_ADC_12_DMACE_TRIGGER_ENABLE or PDL_ADC_12_DTC_TRIGGER_ENABLE	Disable or enable activation of the DMAC or DTC when a scan cycle completes.
---	--

• Sampling time (excluding temperature sensor)

PDL_ADC_12_SAMPLING_TIME_CALCULATE or PDL_ADC_12_SAMPLING_TIME_SPECIFY	Select whether parameter data7 is used to calculate the ADSSTR01 value, or contains the value to be stored in register ADSSTR01.
---	--

• Sampling time for temperature sensor

PDL_ADC_12_SAMPLING_TIME_TEMP_CALCULATE or PDL_ADC_12_SAMPLING_TIME_TEMP_SPECIFY	Select whether parameter data6 is used to calculate the ADSSTR23 value, or contains the value to be stored in register ADSSTR23.
---	--

Description (3/4)

[data4]

Trigger control selection. To set multiple options at the same time, use “|” to separate each value.

- Trigger selection

PDL_ADC_12_TRIGGER_SOFTWARE or	Software trigger.
PDL_ADC_12_TRIGGER_ADTRG0 or	A pulse input on the ADTRG0# pin.
PDL_ADC_12_TRIGGER_MTU0_ICCM_A or	Input capture / compare match A from MTU0.
PDL_ADC_12_TRIGGER_MTU0_ICCM_B or	Input capture / compare match B from MTU0.
PDL_ADC_12_TRIGGER_MTU0_MTU4_ICCM or	Input capture / compare match from MTU0 to MTU4.
PDL_ADC_12_TRIGGER_TPU0_TPU4_ICCM_A or	Input capture / compare match A from TPU0 to TPU4.
PDL_ADC_12_TRIGGER_MTU0_CM_E or	Compare match E from MTU0.
PDL_ADC_12_TRIGGER_MTU0_CM_F or	Compare match F from MTU0.
PDL_ADC_12_TRIGGER_MTU4_CM or	Compare match from MTU4.
PDL_ADC_12_TRIGGER_TPU0_ICCM_A or	Input capture / compare match A from TPU0.
PDL_ADC_12_TRIGGER_TMR0 or	Compare match from TMR0.
PDL_ADC_12_TRIGGER_TMR2	Compare match from TMR2.

- Pin selection (required only if the pin is used as the trigger).

PDL_ADC_12_PIN_ADTRG0_P07 or PDL_ADC_12_PIN_ADTRG0_P16 or PDL_ADC_12_PIN_ADTRG0_P25	Select the pin for ADTRG0#.
---	-----------------------------

[data5]

Value addition mode control. If multiple selections are required, use “|” to separate each selection. Specify PDL_NO_DATA if not required.

- Value addition mode selection

PDL_ADC_12_VALUE_ADD_CHANNEL_0	Enable value addition mode on each of the selected channels AN0 to AN20. Only enabled channels may be selected.
PDL_ADC_12_VALUE_ADD_CHANNEL_1	
PDL_ADC_12_VALUE_ADD_CHANNEL_2	
PDL_ADC_12_VALUE_ADD_CHANNEL_3	
PDL_ADC_12_VALUE_ADD_CHANNEL_4	
PDL_ADC_12_VALUE_ADD_CHANNEL_5	
PDL_ADC_12_VALUE_ADD_CHANNEL_6	
PDL_ADC_12_VALUE_ADD_CHANNEL_7	
PDL_ADC_12_VALUE_ADD_CHANNEL_8	
PDL_ADC_12_VALUE_ADD_CHANNEL_9	
PDL_ADC_12_VALUE_ADD_CHANNEL_10	
PDL_ADC_12_VALUE_ADD_CHANNEL_11	
PDL_ADC_12_VALUE_ADD_CHANNEL_12	
PDL_ADC_12_VALUE_ADD_CHANNEL_13	
PDL_ADC_12_VALUE_ADD_CHANNEL_14	
PDL_ADC_12_VALUE_ADD_CHANNEL_15	
PDL_ADC_12_VALUE_ADD_CHANNEL_16	
PDL_ADC_12_VALUE_ADD_CHANNEL_17	
PDL_ADC_12_VALUE_ADD_CHANNEL_18	
PDL_ADC_12_VALUE_ADD_CHANNEL_19	
PDL_ADC_12_VALUE_ADD_CHANNEL_20	
PDL_ADC_12_VALUE_ADD_TS	Enable value addition mode for the temperature sensor.
PDL_ADC_12_VALUE_ADD_REF	Enable value addition mode for the reference voltage.

Description (3/4)	<ul style="list-style-type: none"> Value addition count selection <table border="1" data-bbox="440 255 1445 367"> <tr> <td data-bbox="440 255 938 367"> PDL_ADC_12_VALUE_ADD_TIME_1 or PDL_ADC_12_VALUE_ADD_TIME_2 or PDL_ADC_12_VALUE_ADD_TIME_3 or PDL_ADC_12_VALUE_ADD_TIME_4 </td> <td data-bbox="948 282 1422 340"> The number of conversions applied to each channel selected for value addition mode. </td> </tr> </table> 	PDL_ADC_12_VALUE_ADD_TIME_1 or PDL_ADC_12_VALUE_ADD_TIME_2 or PDL_ADC_12_VALUE_ADD_TIME_3 or PDL_ADC_12_VALUE_ADD_TIME_4	The number of conversions applied to each channel selected for value addition mode.
PDL_ADC_12_VALUE_ADD_TIME_1 or PDL_ADC_12_VALUE_ADD_TIME_2 or PDL_ADC_12_VALUE_ADD_TIME_3 or PDL_ADC_12_VALUE_ADD_TIME_4	The number of conversions applied to each channel selected for value addition mode.		
[data6]	<p>This parameter is ignored if data3 does not specify PDL_ADC_12_SAMPLING_TIME_CALCULATE or PDL_ADC_12_SAMPLING_TIME_SPECIFY. If PDL_ADC_12_SAMPLING_TIME_CALCULATE is selected then specify the required sampling time in seconds. This must not be less than 4 μs. If PDL_ADC_12_SAMPLING_TIME_SPECIFY is selected, specify the value to be written to the ADSSTR01.SST1 bits. Range = 10 to 255.</p>		
[data7]	<p>This parameter is ignored if data3 does not specify PDL_ADC_12_SAMPLING_TIME_TEMP_CALCULATE or PDL_ADC_12_SAMPLING_TIME_TEMP_SPECIFY. If PDL_ADC_12_SAMPLING_TIME_TEMP_CALCULATE is selected then specify the required sampling time in seconds. This must not be less than 4 μs. If PDL_ADC_12_SAMPLING_TIME_TEMP_SPECIFY is selected, specify the value to be written to the ADSSTR23.SST2 bits. Range = 10 to 255.</p>		
[func]	<p>The function to be called when the ADC conversion scan cycle is complete. Specify PDL_NO_FUNC if no callback function is required.</p>		
[data8]	<p>The interrupt priority level. Select between 1 (lowest priority) and 15 (highest priority). This parameter will be ignored if PDL_NO_FUNC is specified for parameter func.</p>		
Return value	<p>True if all parameters are valid and exclusive; otherwise false.</p>		
Category	<p>12-bit ADC</p>		
References	<p>R_CGC_Set</p>		
Remarks	<ul style="list-style-type: none"> Interrupts are enabled automatically if a callback function is specified. Please see the notes on callback function usage in §6. If an external trigger is used, the low-level pulse width must be at least 1.5 PCLK cycles. This function brings the converter unit out of the power-down state. A callback function is executed by the interrupt processing function. This means that no other interrupt can be processed until the callback function has completed. There are some pin restrictions when using the 100, 64, 48 pins device packages. Function R_CGC_Set must be called (with the current clock source selected) before using this function. Allow 10 ms to elapse from the completion of this function to the start of the first conversion. For more details of the MTU or TMR trigger options, please refer to the RX63N hardware manual. This function will return false if an invalid / unachievable sampling time is specified When the temperature sensor output or the A/D internal reference voltage is selected, single scan mode must be selected. Some channels are not available in some device packages. List of available channels of each device package: <ul style="list-style-type: none"> Package 177, 176, 145, 144 pins : AN000 to AN020. Package 100 pins : AN000 to AN013. Package 64 pins : AN000 to AN004, AN006, AN008 to AN013. Package 48 pins : AN000 to AN002, AN006, AN009 to AN012. 		

Program example

```
/* RPDL definitions */
#include "r_pdl_adc_12.h"

/* RPDL device-specific definitions */
#include "r_pdl_definitions.h"

/* ADC callback function */
void ADCIntFunc(void);

void func(void)
{
    /* Set up the ADC in single mode using AN0 and AN2 */
    R_ADC_12_Create(
        0,
        PDL_ADC_12_CHANNEL_0 | PDL_ADC_12_CHANNEL_2,
        PDL_ADC_12_SCAN_SINGLE | PDL_ADC_12_DIV_1,
        PDL_ADC_12_TRIGGER_SOFTWARE,
        PDL_NO_DATA,
        PDL_NO_DATA,
        PDL_NO_DATA,
        ADCIntFunc,
        2
    );
}
```

2) R_ADC_12_Destroy

Synopsis

Shut down the ADC unit.

Prototype

```
bool R_ADC_12_Destroy(
    uint8_t data // ADC unit selection
);
```

Description

Put the ADC into the Power-down state, with minimal power consumption.

[data]

Select the ADC unit to be shut down. This must always be 0.

Return value

True if a valid unit is selected; otherwise false.

Category

12-bit ADC

Reference

R_ADC_12_Create

Remarks

- This function includes a 1 ms delay to allow the ADC to stop any current scan cycle.

Program example

```
/* RPDL definitions */
#include "r_pdl_adc_12.h"

/* RPDL device-specific definitions */
#include "r_pdl_definitions.h"

void func( void )
{
    /* Shut down the ADC unit */
    R_ADC_12_Destroy(
        0
    );
}
```

3) R_ADC_12_Control

Synopsis

Start or stop an ADC unit.

Prototype

```
bool R_ADC_12_Control(
    uint8_t data    // Conversion unit control
);
```

Description

Controls start / stop operation of the specified ADC.

[data]

To select multiple options at the same time, use "|" to separate each value.

- On / off control

PDL_ADC_12_0_ON or	Start a software-triggered conversion or re-enable the trigger.
PDL_ADC_12_0_OFF	Stop the conversion (and disable all triggers).

- Control the CPU during the ADC conversion.

PDL_ADC_12_CPU_OFF	Stop the CPU when the scan conversion process starts. The CPU will re-start when any valid interrupt occurs.
--------------------	---

Return value

True if all parameters are valid and exclusive; otherwise false.

Category

12-bit ADC

Reference

R_ADC_12_Create

Remarks

- For single scan mode, the ADC will stop automatically when the conversion is complete.
- Do not select CPU Off unless there is any interrupt to wake up the CPU.

Program example

```
/* RPDL definitions */
#include "r_pdl_adc_12.h"

/* RPDL device-specific definitions */
#include "r_pdl_definitions.h"

void func(void)
{
    /* Start the ADC conversion process */
    R_ADC_12_Control(
        PDL_ADC_12_0_ON
    );
}
```

4) R_ADC_12_Read

Synopsis

Read the ADC conversion results.

Prototype

```
bool R_ADC_12_Read(
    uint8_t data1,    // ADC unit selection
    uint16_t * data2 // Pointer to the buffer where the converted values are to be stored
);
```

Description

Reads the conversion values for an ADC unit.

[data1]

Select the ADC unit to be used. This must always be 0.

[data2]

Specify a pointer to an array where the results shall be stored.

Return value

True if a valid unit is selected; otherwise false.

Category

12-bit ADC

Reference

R_ADC_12_Create

Remarks

- If the unit is configured to be reading the analog input channels then ensure that the storage area has room for all 21 channels. Only active channels will be read and the value stored in the appropriate array location.
If the unit is configured to read the temperature sensor or the reference voltage then only a single 16-bit storage is required.
- The data alignment is controlled using the R_ADC_12_Create function.
- If no callback function is used, this function waits for the S12ADIO flag to indicate that conversion is complete before reading the results. If the ADC unit's control registers are directly modified by the user, this function may lock up.

Program example

```
/* RPDL definitions */
#include "r_pdl_adc_12.h"

/* RPDL device-specific definitions */
#include "r_pdl_definitions.h"

void func(void)
{
    uint16_t ADCresult[21];

    /* Read the ADC */
    R_ADC_12_Read(
        0,
        ADCresult
    );
}
```

4.2.29. 10-bit Analog to Digital Converter

1) R_ADC_10_Set

Synopsis

Select the I/O pins for 10-bit ADC.

Prototype

```
bool R_ADC_10_Set(
    uint16_t data // ADC pin selection
);
```

Description

Select the I/O pins for 10-bit ADC.

[data]

Select the pin set options. To set multiple options at the same time, use "|" to separate each value.

• Pin selection

PDL_ADC_10_PIN_AN0_PE2	Select PE2 for AN0.
PDL_ADC_10_PIN_AN1_PE3	Select PE3 for AN1.
PDL_ADC_10_PIN_AN2_PE4	Select PE4 for AN2.
PDL_ADC_10_PIN_AN3_PE5	Select PE5 for AN3.
PDL_ADC_10_PIN_AN4_PE6	Select PE6 for AN4.
PDL_ADC_10_PIN_AN5_PE7	Select PE7 for AN5.
PDL_ADC_10_PIN_AN6_PD6	Select PD6 for AN6.
PDL_ADC_10_PIN_AN7_PD7	Select PD7 for AN7.
PDL_ADC_10_PIN_ANEX0_PE0	Select PE0 for ANEX0.
PDL_ADC_10_PIN_ANEX1_PE1	Select PE1 for ANEX1.
PDL_ADC_10_PIN_ADTRG_P13 or PDL_ADC_10_PIN_ADTRG_P17	Select P13 or P17 for ADTRG.

Return value

True if all parameters are valid and exclusive; otherwise false.

Category

10-bit ADC

Reference

R_ADC_10_Create

Remarks

- If there are I/O pins to be used, call this function before calling R_ADC_10_Create.
- This module is not available on the 48 pin and 64 pin package

Program example

```
/* RPDL definitions */
#include "r_pdl_adc_10.h"

/* RPDL device-specific definitions */
#include "r_pdl_definitions.h"

void func( void )
{
    /* Set analog channel AN0 */
    R_ADC_10_Set(
        PDL_ADC_10_PIN_AN0_PE2
    );
}
```

2) R_ADC_10_Create

Synopsis Configure a 10-bit ADC unit.

Prototype

```
bool R_ADC_10_Create(
    uint8_t data1, // ADC unit selection
    uint32_t data2, // ADC configuration
    uint32_t data3, // ADC conversion clock frequency
    float data4, // ADC input sampling time
    void * func, // Callback function
    uint8_t data5 // Interrupt priority level
);
```

Description (1/2) Set the ADC's mode and operating condition.

[data1]
Select the ADC unit (0 only) to be configured.

[data2]
Conversion options. To set multiple options at the same time, use “|” to separate each value. The default settings are shown in **bold**. Specify PDL_NO_DATA to use the defaults.

- Scan mode

PDL_ADC_10_MODE_SINGLE or PDL_ADC_10_MODE_CONTINUOUS_SCAN or PDL_ADC_10_MODE_ONE_CYCLE_SCAN	Select Single mode, Continuous scan mode or One-cycle scan mode.
--	--

- Input channel selection

PDL_ADC_10_CHANNELS_OPTION_1 or	Any mode: For unit 0, channel AN0.
PDL_ADC_10_CHANNELS_OPTION_2 or	Single mode: For unit 0, channel AN1. Scan mode: For unit 0, channels AN0 and AN1.
PDL_ADC_10_CHANNELS_OPTION_3 or	Single mode: For unit 0, channel AN2. Scan mode: For unit 0, channels AN0, AN1 and AN2.
PDL_ADC_10_CHANNELS_OPTION_4 or	Single mode: For unit 0, channel AN3. Scan mode: For unit 0, channels AN0, AN1, AN2 and AN3.
PDL_ADC_10_CHANNELS_OPTION_5 or	Single mode: For unit 0, channel AN4. Scan mode: For unit 0, channels AN0, AN1, AN2, AN3 and AN4.
PDL_ADC_10_CHANNELS_OPTION_6 or	Single mode: For unit 0, channel AN5. Scan mode: For unit 0, channels AN0, AN1, AN2, AN3, AN4 and AN5.
PDL_ADC_10_CHANNELS_OPTION_7 or	Single mode: For unit 0, channel AN6. Scan mode: For unit 0, channels AN0, AN1, AN2, AN3, AN4, AN5 and AN6.
PDL_ADC_10_CHANNELS_OPTION_8	Single mode: For unit 0, channel AN7. Scan mode: For unit 0, channels AN0, AN1, AN2, AN3, AN4, AN5, AN6 and AN7.

Description (2/2)

- Trigger selection

PDL_ADC_10_TRIGGER_SOFTWARE or	Software trigger.
PDL_ADC_10_TRIGGER_MTU0_MTU4_CMIC_A or	Compare-match/input-capture A from MTU0 to MTU4.
PDL_ADC_10_TRIGGER_TMR0_CM or	Compare-match from TMR0.
PDL_ADC_10_TRIGGER_ADTRG or	Trigger from ADTRG#.
PDL_ADC_10_TRIGGER_MTU0_CMIC_A or	Compare-match/input-capture A from MTU0.
PDL_ADC_10_TRIGGER_TPU0_TPU4_CMIC_A or	Compare-match/input-capture A from TPU0 to TPU4.
PDL_ADC_10_TRIGGER_MTU4_CM or	Compare-match from MTU4.
PDL_ADC_10_TRIGGER_TPU0_CMIC_A	Compare-match input-capture A from TPU0.

- Data alignment selection

PDL_ADC_10_DATA_ALIGNMENT_LEFT or PDL_ADC_10_DATA_ALIGNMENT_RIGHT	The alignment of the 10-bit ADC conversion result within the 16-bit register. Left: padded at the MSB end. Right: padded at the LSB end.
---	--

- DMAC / DTC trigger control

PDL_ADC_10_DMDC_DTC_TRIGGER_DISABLE or PDL_ADC_10_DMDC_TRIGGER_ENABLE or PDL_ADC_10_DTC_TRIGGER_ENABLE	Disable or enable activation of the DMAC or DTC when a conversion or scan cycle completes.
---	--

- Sampling time calculation

PDL_ADC_10_ADSSTR_CALCULATE or PDL_ADC_10_ADSSTR_SPECIFY	Select whether parameter data4 is used to calculate the ADSSTR register value, or contains the value to be stored in ADSSTR.
--	--

- Self-Diagnostic

PDL_ADC_10_SELF_DIAGNOSTIC_DISABLE or PDL_ADC_10_SELF_DIAGNOSTIC_VREF_0 or PDL_ADC_10_SELF_DIAGNOSTIC_VREF_0_5 or PDL_ADC_10_SELF_DIAGNOSTIC_VREF_1	Disable or enable Self-diagnostic function of Vref x 0 voltage value, or Vref x 1/2 voltage value, or Vref x 1 voltage value.
---	---

- Extended analog input

PDL_ADC_10_ANEX_DISABLE or PDL_ADC_10_INPUT_ANEX1	Disable extended analog input Select ANEX1 as the input source
---	---

[data3]

The desired frequency of the conversion clock (ADCLK) in Hertz.
Up to four frequencies are available, as a division of the peripheral clock. Please see the Remarks.

[data4]

The data to be used for the sampling state register value calculations.
The data should be at least 02h if PDL_ADC_10_ADSSTR_SPECIFY is selected.

<u>Data use</u>	<u>Parameter type</u>
The timer period in seconds or	float
The value to be put in register ADSSTR	uint8_t

[func]

The function to be called when the ADC conversion or scan cycle is complete.
Specify PDL_NO_FUNC if no callback function is required.

[data5]

The interrupt priority level. Select between 1 (lowest priority) and 15 (highest priority).
This parameter will be ignored if PDL_NO_FUNC is specified for parameter func.

Return value

True if all parameters are valid and exclusive; otherwise false.

Category

10-bit ADC

References

R_CGC_Set, R_ADC_10_Control, R_ADC_10_Read

Remarks

- This function configures the selected pin(s) for ADC operation by setting the direction to input and turning off the input buffer. The port control settings for any ADC pins that subsequently become inactive are not modified.
- This function brings the selected converter unit out of the power-down state.
- Interrupts are enabled automatically if a callback function is specified. Please see the notes on callback function usage in §6.
- A callback function is executed by the interrupt processing function. This means that no other interrupt can be processed until the callback function has completed.
- Function R_CGC_Set must be called (with the current clock source selected) before using this function.
- The available values for the conversion clock are $PCLK \div 8, 4, 2$ or 1 . If the desired frequency is not an exact match, the actual frequency will be the next highest frequency. The timing limits depend on the peripheral module clock, PCLK. Use the table below with the appropriate frequency for f_{PCLK} .

Parameter	Limit	Equation	f_{PCLK} (MHz)					
			50	48	32	12.5	12	8
Conversion clock (ADCLK) / MHz	Minimum	$(f_{PCLK} \div 8, 4, 2, 1) \geq 4.0$	6.25	6.00	4.00	6.25	6.00	4.00
	Maximum	f_{PCLK}	50.00	48.00	12.5 0	50.0 0	12.00	48.0
Conversion time / μs	Maximum	$25 \div ADCLK$	4.00	4.17	6.25	4.00	4.17	6.25
	Minimum		0.5	0.52	0.78	2.00	2.08	3.13
Sampling time	Minimum	-	0.5 μs					
	Maximum	$255 \div ADCLK$	e.g. 5.1 μs at 50 MHz					
Total conversion time / μs	Minimum	Conversion time + sampling time	1	1.02	1.28	2.5	2.58	3.63

- If any of Self-Diagnostic-enabled options is selected, please do not select the Scan mode, Input channel selection and Trigger selection. Their default settings will be used. The user is expected to call R_ADC_10_Control and R_ADC_10_Read to get the conversion result. Please refer to Section 5.21 for a usage example.
- Simultaneous use of the ADC and DAC peripherals may affect ADC conversion accuracy. Please refer to the Hardware Manual for countermeasures.
- The ANEX1 is used when an external operational amplifier is connected to perform A/D conversion for the multiple analog values.
- This module is not available on the 48 pin and 64 pin package

Program example

```
/* RPDL definitions */
#include "r_pdl_adc_10.h"

/* RPDL device-specific definitions */
#include "r_pdl_definitions.h"

/* ADC unit 0 callback function */
void ADC0IntFunc(void){}

void func(void)
{
    /* Set up ADC 0 at 48 MHz in single mode using AN1 with 0.6 μs sampling
time */
    R_ADC_10_Create(
        0,
        PDL_ADC_10_CHANNELS_OPTION_2,
        48E6,
        0.6E-6,
        ADC0IntFunc,
        2
    );

    /* Set up ADC 0 at 48 MHz in single mode using AN1 */
    R_ADC_10_Create(
        0,
        PDL_ADC_10_CHANNELS_OPTION_2 | PDL_ADC_10_ADSSTR_SPECIFY,
        48E6,
        0x40,
        ADC0IntFunc,
        2
    );
}
```

3) R_ADC_10_Destroy

Synopsis

Shut down an ADC unit.

Prototype

```
bool R_ADC_10_Destroy(
    uint8_t data // ADC unit selection
);
```

Description

Put the ADC into the Power-down state, with minimal power consumption.

[data]

Select the ADC unit (0 only) to be shut down.

Return value

True if a valid unit is selected; otherwise false.

Category

10-bit ADC

Reference

None

Remarks

- This function waits for the ADST flag to indicate that the converter has stopped. If the ADC unit's control registers are directly modified by the user, this function may lock up.
- If the D/A A/D synchronous conversion is enabled, the 10-bit ADC should not be shut down, as it will halt the D/A conversion too.
- This module is not available on the 48 pin and 64 pin package

Program example

```
/* RPD_L definitions */
#include "r_pdl_adc_10.h"

/* RPD_L device-specific definitions */
#include "r_pdl_definitions.h"

void func( void )
{
    /* Shut down ADC unit 0 */
    R_ADC_10_Destroy(
        0
    );
}
```

4) R_ADC_10_Control

Synopsis	Start or stop an ADC unit.				
Prototype	<pre>bool R_ADC_10_Control(uint16_t data // Conversion unit control);</pre>				
Description	<p>Controls start / stop operation of the specified ADC.</p> <p>[data] To select multiple units at the same time, use “ ” to separate each value.</p> <ul style="list-style-type: none"> On / off control (compulsory option) <table border="1" style="width: 100%;"> <tr> <td style="width: 40%;">PDL_ADC_10_0_ON or PDL_ADC_10_0_OFF</td> <td>Start or stop ADC unit 0 conversion.</td> </tr> </table> Control the CPU during the ADC conversion. The default setting is shown in bold. <table border="1" style="width: 100%;"> <tr> <td style="width: 40%;">PDL_ADC_10_CPU_ON or PDL_ADC_10_CPU_OFF</td> <td>Allow the CPU to run normally during the conversion. Stop the CPU when the conversion starts. The CPU will re-start when any valid interrupt occurs.</td> </tr> </table> 	PDL_ADC_10_0_ON or PDL_ADC_10_0_OFF	Start or stop ADC unit 0 conversion.	PDL_ADC_10_CPU_ON or PDL_ADC_10_CPU_OFF	Allow the CPU to run normally during the conversion. Stop the CPU when the conversion starts. The CPU will re-start when any valid interrupt occurs.
PDL_ADC_10_0_ON or PDL_ADC_10_0_OFF	Start or stop ADC unit 0 conversion.				
PDL_ADC_10_CPU_ON or PDL_ADC_10_CPU_OFF	Allow the CPU to run normally during the conversion. Stop the CPU when the conversion starts. The CPU will re-start when any valid interrupt occurs.				
Return value	True if all parameters are valid and exclusive; otherwise false.				
Category	10-bit ADC				
Reference	None				
Remarks	<ul style="list-style-type: none"> For single or one-cycle scan modes, the ADC will stop automatically when the conversion is complete. The time delay between starting conversions on multiple units is minimised, but has to use separate instructions. This function minimises the delay between starts by using an interrupt to prevent other interrupts from occurring during the start sequence. If the user has disabled interrupts (cleared the ‘I’ bit in the PSW register) in their own code, this function will lock up. For true simultaneous starting of ADC units, select an appropriate hardware trigger e.g. timer TMR. Do not select CPU Off unless there is any interrupt to wake up the CPU. This module is not available on the 48 pin and 64 pin package. 				

Program example

```

/* RPDL definitions */
#include "r_pdl_adc_10.h"

/* RPDL device-specific definitions */
#include "r_pdl_definitions.h"

void func(void)
{
    /* Start ADC unit 0 */
    R_ADC_10_Control(
        PDL_ADC_10_0_ON
    );
}
    
```

5) R_ADC_10_Read

Synopsis

Read the ADC conversion results.

Prototype

```
bool R_ADC_10_Read(
    uint8_t data1,    // ADC unit selection
    uint16_t * data2 // Pointer to the buffer where the converted values are to be stored
);
```

Description

Reads the conversion values for an ADC unit.

[data1]

Select the ADC unit (0 only) to be read.

[data2]

Specify a pointer to a variable or array where the results shall be stored.

Return value

True if a valid unit is selected; otherwise false.

Category

10-bit ADC

Reference

R_ADC_10_Create

Remarks

- From 1 to 8 conversion results will be read and stored. The number depends on the settings for "Input channel selection" and "Scan mode" when R_ADC_10_Create is used to configure the ADC unit.
- The 10-bit data alignment is controlled using the R_ADC_10_Create function.
- Ensure that the buffer is big enough for the requested number of values.
- If no callback function is used, this function waits for the ADI flag to indicate that conversion is complete before reading the results. If the ADC unit's control registers are directly modified by the user, this function may lock up.
- This module is not available on the 48 pin and 64 pin package

Program example

```
/* RPDFL definitions */
#include "r_pdl_adc_10.h"

/* RPDFL device-specific definitions */
#include "r_pdl_definitions.h"

void func(void)
{
    uint16_t ADCresult[2];

    /* Read the ADC values for unit 0 */
    R_ADC_10_Read(
        0,
        ADCresult
    );
}
```

4.2.30. 10-bit Digital to Analog Converter

1) R_DAC_10_Create

Synopsis

Configure the 10-bit DAC module.

Prototype

```
bool R_DAC_10_Create(
    uint8_t data1, // Configuration
    uint16_t data2, // Output value
    uint16_t data3 // Output value
);
```

Description

Enable the DAC module and set the operating conditions.

[data1]

Configuration options. To set multiple options at the same time, use “|” to separate each value. The default settings are shown in **bold**.

- Channel enable

PDL_DAC_10_CHANNEL_0	Enable channel 0
PDL_DAC_10_CHANNEL_1	Enable channel 1

- Data alignment selection

PDL_DAC_10_ALIGN_LEFT or PDL_DAC_10_ALIGN_RIGHT	The alignment of the 10-bit output data within the 16-bit parameters data2 and data3. Left: padded at the MSB end. Right: padded at the LSB end.
---	--

- D/A A/D Synchronous Start Control

PDL_DAC_10_ADC_SYNC_CONV_DISABLE or PDL_DAC_10_ADC_SYNC_CONV_ENABLE	Disable or enable the D/A A/D synchronous conversion.
---	---

[data2]

The value to be written to the channel 0 output register. Ignored if the channel is not enabled.

[data3]

The value to be written to the channel 1 output register. Ignored if the channel is not enabled.

Return value

True if all parameters are valid and exclusive; otherwise false.

Category

DAC

References

None.

Remarks

- This function configures the relevant pin of selected channel for DAC operation.
- This function brings the converter module out of the power-down state.
- Channel 0 is not available on 100-pin and 64-pin packages.
- If the D/A A/D synchronous conversion is enabled, the 10-bit ADC should not be shut down, as it will halt the D/A conversion too.
- User should ensure that the 10-bit A/D converter remains stopped, when setting the D/A A/D synchronous conversion.
- DAC_10 is not available on 48-pin package.

Program example

```
/* RPDL definitions */
#include "r_pdl_dac_10.h"

/* RPDL device-specific definitions */
#include "r_pdl_definitions.h"

void func(void)
{
    /* Set up DAC channel 1 with default operation, mid voltage */
    R_DAC_10_Create(
        PDL_DAC_10_CHANNEL_1,
        0,
        1024 / 2
    );
}
```

2) R_DAC_10_Destroy

Synopsis

Disable a DAC channel.

Prototype

```
bool R_DAC_10_Destroy(
    uint8_t data // Channel selection
);
```

Description

Disable the channel output.

[data1]

Disable selection. To set multiple options at the same time, use "|" to separate each value.

PDL_DAC_10_CHANNEL_0	Disable channel 0
PDL_DAC_10_CHANNEL_1	Disable channel 1

Return value

True if the parameter is valid; otherwise false.

Category

DAC

Reference

None.

Remarks

- Once both channels are disabled, the module is put into the power-down state.
- Channel 0 is not available on 100-pin and 64-pin packages.
- DAC 10 is not available on 48-pin package.

Program example

```
/* RPDL definitions */
#include "r_pdl_dac_10.h"

/* RPDL device-specific definitions */
#include "r_pdl_definitions.h"

void func( void )
{
    /* Shut down DAC channel 1 */
    R_DAC_10_Destroy(
        PDL_DAC_10_CHANNEL_1
    );
}
```

3) R_DAC_10_Write

Synopsis

Write data to a DAC channel.

Prototype

```
bool R_DAC_10_Write(
    uint8_t data1, // Channel selection
    uint16_t data2, // Output value
    uint16_t data3 // Output value
);
```

Description

Write data to the selected DAC channel(s).

[data1]

Select the DAC channel output to be modified.

PDL_DAC_10_CHANNEL_0	Select channel 0
PDL_DAC_10_CHANNEL_1	Select channel 1

[data2]

The value to be written to the channel 0 output register. Ignored if the channel is not selected.

[data3]

The value to be written to the channel 1 output register. Ignored if the channel is not selected.

Return value

True if all parameters are valid; otherwise false.

Category

DAC

Reference

R_DAC_10_Create

Remarks

- Refer to the data alignment that was selected when R_DAC_10_Create was called.
- Channel 0 is not available on 100-pin and 64-pin packages.
- DAC_10 is not available on 48-pin package.

Program example

```
/* RPDL definitions */
#include "r_pdl_dac_10.h"

/* RPDL device-specific definitions */
#include "r_pdl_definitions.h"

void func(void)
{
    /* Write new data to DAC channel 1 */
    R_DAC_10_Write(
        PDL_DAC_10_CHANNEL_1,
        0,
        100
    );
}
```

4.2.31. Temperature Sensor

1) R_TS_Create

Synopsis	Configure the Temperature Sensor.
Prototype	<pre>bool R_TS_Create(void // No parameter is required);</pre>
Description	Enable the Temperature Sensor.
Return value	True.
Category	TS
References	None.
Remarks	<ul style="list-style-type: none">R_ADC_12_Create must be called (to configure the temperature sensor as the target of A/D conversion) before use this function.
Program example	<pre>/* RPDL definitions */ #include "r_pdl_ts.h" /* RPDL device-specific definitions */ #include "r_pdl_definitions.h" void func(void) { /* Enable TS */ R_TS_Create(); }</pre>

2) R_TS_Destroy

Synopsis

Shut down the Temperature Sensor.

Prototype

```
bool R_TS_Destroy(  
    void // No parameter is required  
);
```

Description

Put the Temperature Sensor into the Power-down state, with minimal power consumption.

Return value

True.

Category

TS

Reference

R_TS_Create, R_TS_Control

Remarks

- If R_TS_Control is called, must wait for A/D conversion to finish, before calling this function.

Program example

```
/* RPDL definitions */  
#include "r_pdl_ts.h"  
  
/* RPDL device-specific definitions */  
#include "r_pdl_definitions.h"  
  
void func( void )  
{  
    /* Shut down the Temperature Sensor */  
    R_TS_Destroy();  
}
```

3) R_TS_Control

Synopsis

Control the Temperature Sensor.

Prototype

```
bool R_TS_Control(
    uint8_t data    // Temperature Sensor Output control selection
);
```

Description

Enable or disable the Temperature Sensor output.

[data]

Control the Temperature Sensor output. The default setting is shown in **bold**.

PDL_TS_OUTPUT_DISABLE or PDL_TS_OUTPUT_ENABLE	Enable or Disable the Temperature Sensor.
---	---

Return value

True if success; otherwise false.

Category

TS

Reference

R_TS_Create

Remarks

- R_TS_Create must be called and wait for at least 30 μ s before calling this function.

Program example

```
/* RPDFL definitions */
#include "r_pdl_ts.h"

/* RPDFL device-specific definitions */
#include "r_pdl_definitions.h"

void func( void )
{
    /* Enable the Temperature Sensor */
    R_TS_Control(
        PDL_TS_OUTPUT_ENABLE
    );
}
```

5. Usage Examples

This chapter shows programming examples for each driver in this library.

5.1. Clock Generation Circuit

Figure 5-1 shows an example of configuring the clock generation circuit.

After a power-on reset, both the PLL and the main clock oscillator (which drives the PLL circuit) are switched off. The MCU is using the LOCO as the clock source.

The calls to `R_CGC_Set` configure the LOCO dividers and enable the main clock oscillator and the PLL circuit. After an appropriate time to allow for the crystal-based main clock oscillator and the PLL circuit to stabilise, a call to `R_CGC_Control` is used to select the PLL circuit as the clock source.

```
#include "r_pdl_cgc.h"
#include "r_pdl_cmt.h"

/* RPDL device-specific definitions */
#include "r_pdl_definitions.h"

void main(void)
{
    /* Set the LOCO clock settings (the clock source used after a power-on reset) */
    /* ICLK = 125 kHz, PCLKA = 125 kHz, PCLKB = 125 kHz, FCLK = 125 kHz */
    /* BCLK = IECLK = UCLK = not used */
    R_CGC_Set(
        PDL_CGC_CLK_LOCO,
        PDL_CGC_BCLK_DISABLE | PDL_CGC_SDCLK_DISABLE | PDL_CGC_RTC_SRC_SUB,
        125E3,
        125E3,
        125E3,
        125E3,
        125E3,
        PDL_NO_DATA,
        PDL_NO_DATA,
        PDL_NO_DATA,
        PDL_NO_DATA
    );

    /* Configure main clock operation using a 12.0 MHz crystal */
    /* ICLK = 3 MHz, PCLKA = 3 MHz, PCLKB = 3 MHz, FCLK = 3 MHz */
    /* BCLK = IECLK = UCLK = not used */
    R_CGC_Set(
        PDL_CGC_CLK_MAIN,
        PDL_CGC_BCLK_DISABLE | PDL_CGC_SDCLK_DISABLE,
        12E6,
        3E6,
        3E6,
        3E6,
        3E6,
        PDL_NO_DATA,
        PDL_NO_DATA,
        PDL_NO_DATA,
        PDL_NO_DATA
    );

    /* Configure PLL operation. The PLL will be set to 192 MHz */
    /* ICLK = 96 MHz, PCLKA = 96 MHz, PCLKB = 48 MHz, FCLK = 48 MHz */
    /* BCLK = 48 MHz, BCLK(pin) = 24 MHz. */
    /* IECLK = UCLK = not used */
    R_CGC_Set(
        PDL_CGC_CLK_PLL,
        PDL_CGC_BCLK_DIV_2 | PDL_CGC_SDCLK_DISABLE,
        192E6,
        96E6,
        96E6,
        48E6,
        48E6,
        48E6,
        PDL_NO_DATA,
        PDL_NO_DATA,
        PDL_NO_DATA
    );
}
```

```
);

/* Allow time for the main clock and PLL oscillator to stabilise. This example */
/* uses the CMT timer (running from the LOCO) to generate a 100 us delay */

/* Generate the 100 us delay */
R_CMT_CreateOneShot(
    0,
    PDL_NO_DATA,
    100E-6,
    PDL_NO_FUNC,
    0
);

/* Select the PLL as the clock source */
R_CGC_Control(
    PDL_CGC_CLK_PLL,
    PDL_NO_DATA,
    PDL_CGC_RTC_TO_BE_USED
);

while(1);
}
```

Figure 5-1: Example of Clock configuration and control

5.2. Interrupt control

Figure 5-2 shows an example of external interrupt use.

Pin IRQ2 on port pin P32 is used to detect a falling edge and generates an interrupt. The interrupt handler inverts the edge detection and disables further interrupts.

Pin IRQ12 on port pin P44 is used to detect a falling edge and utilises the digital filter.

Pin IRQ4 on port pin P07 is used to detect a low-level signal and generates an interrupt.

```

/* Peripheral driver function prototypes */
#include "r_pdl_intc.h"

/* RPDL device-specific definitions */
#include "r_pdl_definitions.h"

/* Callback function prototypes */
void SW1_handler (void);
void SW2_handler (void){}
void SW3_handler (void){}

void main(void)
{
    /* Set the CPU's Interrupt Priority Level to 0 */
    R_INTC_Write(
        PDL_INTC_REG_IPL,
        0
    );

    /* Select the pins for SW1, SW2 and SW3 */
    R_INTC_SetExtInterrupt(
        PDL_INTC_IRQ2_P32,
        PDL_INTC_IRQ12_P44 | PDL_INTC_IRQ15_P07
    );

    /* Configure the SW1 interrupt */
    R_INTC_CreateExtInterrupt(
        PDL_INTC_IRQ2,
        PDL_INTC_FALLING,
        SW1_handler,
        7
    );

    /* Configure the SW2 interrupt */
    R_INTC_CreateExtInterrupt(
        PDL_INTC_IRQ12,
        PDL_INTC_FILTER_DIV_32 | PDL_INTC_FALLING,
        SW2_handler,
        7
    );

    /* Configure the SW3 interrupt */
    R_INTC_CreateExtInterrupt(
        PDL_INTC_IRQ15,
        PDL_INTC_LOW,
        SW3_handler,
        7
    );
}

void SW1_handler(void)
{
    uint8_t irq_status = 0u;

    R_INTC_GetExtInterruptStatus(
        PDL_INTC_IRQ2,
        &irq_status
    );
}

```

```
/* Falling edge detected? */  
if ((irq_status & 0x0C) == 0x04)  
{  
    /* Disable and invert the edge interrupt */  
    R_INTC_ControlExtInterrupt(  
        PDL_INTC_IRQ2,  
        PDL_INTC_RISING | PDL_INTC_DISABLE  
    );  
}  
else if ((irq_status & 0x0C) == 0x08)  
{  
    /* Disable and invert the edge interrupt */  
    R_INTC_ControlExtInterrupt(  
        PDL_INTC_IRQ2,  
        PDL_INTC_FALLING | PDL_INTC_DISABLE  
    );  
}  
}
```

Figure 5-2: Example of External Interrupt

5.3. I/O Port

Figure 5-3 shows examples of I/O port configuration, reading and writing.

```

/* Peripheral driver function prototypes */
#include "r_pdl_io_port.h"

/* RPD_L device-specific definitions */
#include "r_pdl_definitions.h"

void main(void)
{
    uint8_t result;
    uint16_t register_value;

    /* Set all reserved I/O port pins to the recommended state */
    R_IO_PORT_NotAvailable();

    /* Configure port 4 as an input */
    R_IO_PORT_Set(
        PDL_IO_PORT_4_0 | PDL_IO_PORT_4_1 | PDL_IO_PORT_4_2 | PDL_IO_PORT_4_3 | \
        PDL_IO_PORT_4_4 | PDL_IO_PORT_4_5 | PDL_IO_PORT_4_6 | PDL_IO_PORT_4_7,
        PDL_IO_PORT_INPUT
    );

    /* Configure port pin P21 as an N-channel open-drain output */
    R_IO_PORT_Set(
        PDL_IO_PORT_2_1,
        PDL_IO_PORT_OUTPUT | PDL_IO_PORT_TYPE_NMOS
    );

    /* Read the value of all the pins on port 4 */
    R_IO_PORT_Read(
        PDL_IO_PORT_4,
        &result
    );

    /* Set pin P21 to output high */
    R_IO_PORT_Write(
        PDL_IO_PORT_2_1,
        1
    );

    /* Invert pin P21 */
    R_IO_PORT_Modify(
        PDL_IO_PORT_2_1,
        PDL_IO_PORT_XOR,
        1
    );

    /* And the value on port 4 with 55h */
    R_IO_PORT_Modify(
        PDL_IO_PORT_4,
        PDL_IO_PORT_AND,
        0x55
    );

    /* Read the control registers for port PC */
    R_IO_PORT_ReadControl(
        PDL_IO_PORT_C,
        PDL_IO_PORT_TYPE,
        &register_value
    );
}

```

```
    /* Read the direction for pin P03 */
    R_IO_PORT_ReadControl(
        PDL_IO_PORT_0_3,
        PDL_IO_PORT_DIRECTION,
        &register_value
    );

    /* Set the lower 4 bits on port P1 to output */
    R_IO_PORT_ModifyControl(
        PDL_IO_PORT_1,
        PDL_IO_PORT_DIRECTION | PDL_IO_PORT_OR,
        0x0F
    );

    /* Enable the pull-up on pin PA3 */
    R_IO_PORT_ModifyControl(
        PDL_IO_PORT_A_3,
        PDL_IO_PORT_PULL_UP | PDL_IO_PORT_OR,
        1
    );
}
```

Figure 5-3: Examples of I/O Port Operations

5.4. Voltage Detection Circuit

Figure 5-4 shows an example of Voltage detection circuit usage.

An NMI is generated if the supply voltage drops below 2.95V.

```

/* Peripheral driver function prototypes */
#include "r_pdl_lvd.h"
#include "r_pdl_intc.h"

/* PDL device-specific definitions */
#include "r_pdl_definitions.h"

static void Callback_NMI(void);

void main(void)
{
    /* Initialise the system clocks */
    NOTE: The code to initialise the system clock using R_CGC_Set is omitted here.

    /* Configure the NMI to be triggered by the LVD1 signal only (no NMI pin) */
    R_INTC_CreateExtInterrupt(
        PDL_INTC_NMI,
        PDL_INTC_LVD1_ENABLE,
        Callback_NMI,
        PDL_NO_DATA
    );

    /* Setup VDET1 to callback if VCC drops below 2.95V */
    R_LVD_Create(
        PDL_LVD_INTERRUPT_NMI_DETECT_FALL | PDL_LVD_FILTER_DISABLE,
        PDL_NO_DATA
    );
}

/* NMI Callback function */
static void Callback_NMI(void)
{
    uint8_t status = 0;

    /* Read the NMI status */
    R_INTC_GetExtInterruptStatus(
        PDL_INTC_NMI,
        &status
    );

    /* Did an LVD1 trigger occur */
    if ((status & BIT_6) != 0)
    {
        /* Clear the LVD monitor 1 flag */
        R_LVD_Control(
            PDL_LVD_CLEAR_DETECTION,
            PDL_NO_DATA
        );

        /* Clear the NMI LVD1 flag */
        R_INTC_ControlExtInterrupt(
            PDL_INTC_NMI,
            PDL_INTC_CLEAR_LVD1_FLAG
        );
    }
}

```

Figure 5-4: Example of Voltage Detection Circuit use

5.5. Frequency Measurement Circuit

5.5.1. Using System 1

Figure 5-5 shows an example of using MCK system 1 and the MTU module to monitor the low-speed on-chip oscillator (LOCO) by comparing it with the main clock oscillator.

```

/* Peripheral driver function prototypes */
#include "r_pdl_mck.h"
#include "r_pdl_cgc.h"
#include "r_pdl_mtu2.h"

/* RPDL device-specific definitions */
#include "r_pdl_definitions.h"

/* Callback function */
static void Read_the_MCK(void);

volatile bool mck_completed;
volatile uint16_t system_clock_count;

#define EXPECTED_F_MAIN 12E6
#define EXPECTED_F_LOCO 125E3

void main(void)
{
    uint16_t reference_count;
    double f_system_clock;
    double f_reference_clock;
    volatile double measured_frequency;
    /* MTU parameters that are structures */
    R_MTU2_Create_structure mtu_create_parameters;
    R_MTU2_ControlChannel_structure mtu_control_parameters;

    /* Configure the LOCO settings */
    R_CGC_Set(
        PDL_CGC_CLK_LOCO,
        PDL_CGC_BCLK_DISABLE | PDL_CGC_SDCLK_DISABLE,
        EXPECTED_F_LOCO,
        EXPECTED_F_LOCO,
        EXPECTED_F_LOCO,
        EXPECTED_F_LOCO,
        EXPECTED_F_LOCO,
        PDL_NO_DATA,
        PDL_NO_DATA,
        PDL_NO_DATA
    );

    /* Configure main clock operation */
    R_CGC_Set(
        PDL_CGC_CLK_MAIN,
        PDL_CGC_BCLK_DISABLE | PDL_CGC_SDCLK_DISABLE,
        EXPECTED_F_MAIN,
        EXPECTED_F_MAIN / 4,
        EXPECTED_F_MAIN / 4,
        EXPECTED_F_MAIN / 4,
        EXPECTED_F_MAIN / 4,
        PDL_NO_DATA,
        PDL_NO_DATA,
        PDL_NO_DATA
    );

    /* Select the main clock oscillator as the system clock */
    R_CGC_Control(
        PDL_CGC_CLK_MAIN,
        PDL_NO_DATA,
        PDL_NO_DATA
    );
}

```

```

);
f_system_clock = EXPECTED_F_MAIN;

/* Select the LOCO as the reference clock for system 1 */
R_MCK_Control(
    PDL_MCK_1_REFERENCE_LOCO | PDL_MCK_2_DISABLE
);
f_reference_clock = EXPECTED_F_LOCO;

/* Set the channel 0 counter value to the mid-point of the channel 1 counter */
reference_count = (uint16_t)((UINT16_MAX / 2) / (f_system_clock /
f_reference_clock));

/* Configure MTU channel 0 */

/* Load the MTU Create defaults */
R_MTU2_Create_load_defaults(&mtu_create_parameters);

/* Set the channel 0 options */
/* Normal operation */
mtu_create_parameters.channel_mode = PDL_MTU2_MODE_NORMAL;
/* Counter input is the MTCLKD input, counter cleared by compare match A */
mtu_create_parameters.counter_operation = PDL_MTU2_CLK_MTCLKD |
PDL_MTU2_CLEAR_TGRA;
/* Compare match A, output disabled */
mtu_create_parameters.TGR_A_B_operation = PDL_MTU2_A_OC_DISABLED;
/* Set the reference count as the compare match A value */
mtu_create_parameters.TGRA_TCNTV_value = (uint16_t)(reference_count - 1);

/* Configure channel 0 */
R_MTU2_Create(
    0,
    &mtu_create_parameters
);

/* Configure MTU channel 1 */

/* Load the MTU Create defaults */
R_MTU2_Create_load_defaults(&mtu_create_parameters);

/* Set the channel 1 options */
/* Normal operation */
mtu_create_parameters.channel_mode = PDL_MTU2_MODE_NORMAL;
/* Counter input is PCLK, counter cleared by input capture A */
mtu_create_parameters.counter_operation = PDL_MTU2_CLK_PCLK_DIV_1 |
PDL_MTU2_CLEAR_TGRA;
/* Input capture is compare match A of channel 0 */
mtu_create_parameters.TGR_A_B_operation = PDL_MTU2_A_IC_CM_IC;
/* Set the callback function */
mtu_create_parameters.funcl = Read_the_MCK;
mtu_create_parameters.interrupt_priority_1 = 5;

/* Configure channel 1 */
R_MTU2_Create(
    1,
    &mtu_create_parameters
);

mck_completed = false;

/* Set Control options to start the timers */
mtu_control_parameters.control_setting = PDL_MTU2_START;
mtu_control_parameters.register_selection = PDL_NO_DATA;

/* Start MTU channel 0 */
R_MTU2_ControlChannel(
    0,
    &mtu_control_parameters

```

```

);

/* Start MTU channel 1 */
R_MTU2_ControlChannel(
    1,
    &mtu_control_parameters
);

/* Discard the first reading */
while (mck_completed == false);
mck_completed = false;

while(1)
{
    /* Is a new reading ready? */
    if (mck_completed == true)
    {
        /* Calculate the frequency of the less-stable clock. */
        /* Examples of both equations are given below. */

        /* Calculate the frequency of the reference clock */
        measured_frequency = (f_system_clock / system_clock_count) *
reference_count;

        /* Calculate the frequency of the system clock */
        measured_frequency = (f_reference_clock * system_clock_count) /
reference_count;

        /* Process the result here */
        nop();

        /* Allow a new reading to be taken */
        mck_completed = false;
    }
}

static void Read_the_MCK(void)
{
    /* Is it safe to update the stored timer value? */
    if (mck_completed == false)
    {
        /* Read TGRA from timer 1 */
        R_MTU2_ReadChannel(
            1,
            PDL_NO_PTR,
            PDL_NO_PTR,
            &system_clock_count,
            PDL_NO_PTR,
            PDL_NO_PTR,
            PDL_NO_PTR,
            PDL_NO_PTR,
            PDL_NO_PTR
        );

        /* Signal that the reading is updated */
        mck_completed = true;
    }
}

```

Figure 5-5: Example of clock monitoring using MCK system 1

5.5.2. Using System 2

Figure 5-6 shows an example of using MCK system 2 and the TPU module to monitor the high-speed on-chip oscillator (HOCO) by comparing it with the main clock oscillator.

```

/* Peripheral driver function prototypes */
#include "r_pdl_mck.h"
#include "r_pdl_cgc.h"
#include "r_pdl_tpu.h"

/* RPDL device-specific definitions */
#include "r_pdl_definitions.h"

/* Callback function */
static void Read_the_MCK(void);

volatile bool mck_completed;
volatile uint16_t system_clock_count;

#define EXPECTED_F_MAIN 12E6
#define EXPECTED_F_HOCO 50E6

void main(void)
{
    uint16_t reference_count;
    double f_system_clock;
    double f_reference_clock;
    volatile double measured_frequency;

    /* Configure the HOCO settings */
    R_CGC_Set(
        PDL_CGC_CLK_HOCO,
        PDL_CGC_BCLK_DISABLE | PDL_CGC_SDCLK_DISABLE,
        EXPECTED_F_HOCO,
        EXPECTED_F_HOCO,
        EXPECTED_F_HOCO,
        EXPECTED_F_HOCO,
        EXPECTED_F_HOCO,
        PDL_NO_DATA,
        PDL_NO_DATA,
        PDL_NO_DATA
    );

    /* Configure main clock operation */
    R_CGC_Set(
        PDL_CGC_CLK_MAIN,
        PDL_CGC_BCLK_DISABLE | PDL_CGC_SDCLK_DISABLE,
        EXPECTED_F_MAIN,
        EXPECTED_F_MAIN / 4,
        EXPECTED_F_MAIN / 4,
        EXPECTED_F_MAIN / 4,
        EXPECTED_F_MAIN / 4,
        PDL_NO_DATA,
        PDL_NO_DATA,
        PDL_NO_DATA
    );

    /* Select the HOCO as the system clock */
    R_CGC_Control(
        PDL_CGC_CLK_HOCO,
        PDL_NO_DATA,
        PDL_NO_DATA
    );
    f_system_clock = EXPECTED_F_HOCO;

    /* Select the main clock as the reference clock for system 2 */
    R_MCK_Control(
        PDL_MCK_1_DISABLE | PDL_MCK_2_REFERENCE_MAIN

```

```

);
f_reference_clock = EXPECTED_F_MAIN;
/* Set the channel 0 counter value to the mid-point of the channel 1 counter */
reference_count = (uint16_t)((UINT16_MAX / 2) / (f_system_clock /
f_reference_clock));

/* Configure TPU channel 0 */
/* Normal operation */
/* Counter input is the TCLKD input, counter cleared by compare match A */
/* Compare match A, output disabled */
/* Set the reference count as the compare match A value */
R_TPU_Create(
    0,
    PDL_TPU_MODE_NORMAL,
    PDL_TPU_CLK_TCLKD | PDL_TPU_CLEAR_CM_A,
    PDL_TPU_A_OC_DISABLED,
    PDL_NO_DATA,
    PDL_NO_DATA,
    (uint16_t)(reference_count - 1),
    PDL_NO_DATA,
    PDL_NO_DATA,
    PDL_NO_DATA,
    PDL_NO_FUNC,
    PDL_NO_FUNC,
    PDL_NO_FUNC,
    PDL_NO_FUNC,
    0,
    PDL_NO_FUNC,
    PDL_NO_FUNC,
    0
);

/* Configure TPU channel 1 */
/* Normal operation */
/* Counter input is PCLK, counter cleared by input capture A */
/* Input capture is compare match A of channel 0 */
R_TPU_Create(
    1,
    PDL_TPU_MODE_NORMAL,
    PDL_TPU_CLK_PCLK_DIV_1 | PDL_TPU_CLEAR_CM_A,
    PDL_TPU_A_IC_TPU_CM_IC,
    PDL_NO_DATA,
    PDL_NO_DATA,
    PDL_NO_DATA,
    PDL_NO_DATA,
    PDL_NO_DATA,
    PDL_NO_DATA,
    PDL_NO_DATA,
    Read_the_MCK,
    PDL_NO_FUNC,
    PDL_NO_FUNC,
    PDL_NO_FUNC,
    5,
    PDL_NO_FUNC,
    PDL_NO_FUNC,
    0
);

mck_completed = false;

/* Start TPU channel 0 */
R_TPU_ControlChannel(
    0,
    PDL_TPU_START,
    PDL_NO_DATA,
    PDL_NO_DATA,
    PDL_NO_DATA,
    PDL_NO_DATA,
    PDL_NO_DATA
);

```



```

);

/* Start TPU channel 1 */
R_TPU_ControlChannel(
    1,
    PDL_TPU_START,
    PDL_NO_DATA,
    PDL_NO_DATA,
    PDL_NO_DATA,
    PDL_NO_DATA,
    PDL_NO_DATA
);

/* Discard the first reading */
while (mck_completed == false);
mck_completed = false;

while(1)
{
    /* Is a new reading ready? */
    if (mck_completed == true)
    {
        /* Calculate the frequency of the less-stable clock. */
        /* Examples of both equations are given below. */

        /* Calculate the frequency of the reference clock */
        measured_frequency = (f_system_clock / system_clock_count) *
reference_count;

        /* Calculate the frequency of the system clock */
        measured_frequency = (f_reference_clock * system_clock_count) /
reference_count;

        /* Process the result here */
        nop();

        /* Allow a new reading to be taken */
        mck_completed = false;
    }
}

static void Read_the_MCK(void)
{
    /* Is it safe to update the stored timer value? */
    if (mck_completed == false)
    {
        /* Read TGRA from timer 1 */
        R_TPU_Read(
            1,
            PDL_NO_PTR,
            PDL_NO_PTR,
            &system_clock_count,
            PDL_NO_PTR,
            PDL_NO_PTR,
            PDL_NO_PTR
        );

        /* Signal that the reading is updated */
        mck_completed = true;
    }
}

```

Figure 5-6: Example of clock monitoring using MCK system 2

5.6. Low Power Consumption

5.6.1. Software Standby Mode

Figure 5-7 shows an example of entering Software Standby mode through Low Power Consumption control.

```

/* Peripheral driver function prototypes */
#include "r_pdl_cgc.h"
#include "r_pdl_lpc.h"
#include "r_pdl_intc.h"

/* RPDFL device-specific definitions */
#include "r_pdl_definitions.h"

static void SW1_handler(void);

void main(void)
{
    /* Set Switch1 (SW1) interrupt */
    R_INTC_SetExtInterrupt(
        PDL_INTC_IRQ2_P32, PDL_NO_DATA
    );

    /* Enable the switch SW1 interrupt */
    R_INTC_CreateExtInterrupt(
        PDL_INTC_IRQ2,
        PDL_INTC_FALLING,
        SW1_handler,
        7
    );

    /* Select the default options */
    R_LPC_Create(
        PDL_NO_DATA,
        PDL_NO_DATA,
        PDL_NO_DATA,
        PDL_NO_DATA,
        PDL_NO_DATA,
        PDL_NO_DATA,
        PDL_NO_DATA
    );

    /* Refer section 1.3.5 of the API manual. */
    /* If the sub-clock oscillator will not be used, use R_CGC_Control to disable
    the oscillation circuit */

    /* For deep Software Standby mode : the sub-clock oscillator is not fitted,
    MUST call R_CGC_Control once to disable the sub-clock oscillation circuit
    before calling R_LPC_Control */
    R_CGC_Control(PDL_NO_DATA, PDL_NO_DATA, PDL_CGC_SUB_CLOCK_DISABLE);

    /* Enter software standby mode */
    R_LPC_Control(
        PDL_LPC_MODE_SOFTWARE_STANDBY
    );

    /* Normal execution will resume after switch SW1 is pressed */
    while(1)
}

static void SW1_handler(void)
{
}

```

Figure 5-7: Example of Software Standby Mode

5.6.2. Deep Software Standby Mode

Figure 5-8 shows an example of entering Deep Software Standby mode through Low Power Consumption control.

```

/* PDL functions */
#include "r_pdl_cgc.h"
#include "r_pdl_lpc.h"
#include "r_pdl_intc.h"

/* PDL device-specific definitions */
#include "r_pdl_definitions.h"

void NMI_handler_lpc(void);

void main(void)
{
    const uint8_t data_to_save[] = "Hello_World_1234567890_abcdefghi";
    uint8_t data_to_restore[R_PDL_LPC_BACKUP_AREA_SIZE];
    uint32_t status_flags1;
    uint32_t status_flags2;

    /* Read the LPC status */
    R_LPC_GetStatus(
        &status_flags1,
        &status_flags2
    );

    /* Check if this is an exit from deep software standby (BIT_23 = 1) */
    if( (status_flags1 & 0x00800000) != 0)
    {
        /* Read data from the backup registers */
        R_LPC_ReadBackup(
            data_to_restore,
            R_PDL_LPC_BACKUP_AREA_SIZE
        );

        /* Have exited deep standby, sample finishes here. */
        while(1);
    }

    /* Configure the NMI pin */
    R_INTC_CreateExtInterrupt(
        PDL_INTC_NMI,
        PDL_INTC_FALLING,
        NMI_handler_lpc,
        7
    );

    /* Allow a falling edge on NMI to cancel deep software standby */
    R_LPC_Create(
        PDL_NO_DATA,
        PDL_NO_DATA,
        PDL_NO_DATA,
        PDL_LPC_CANCEL_NMI_FALLING,
        PDL_NO_DATA,
        PDL_NO_DATA,
        PDL_NO_DATA
    );

    /* Write data into the backup registers */
    R_LPC_WriteBackup(
        data_to_save,
        R_PDL_LPC_BACKUP_AREA_SIZE
    );

    /* Refer section 1.3.5 of the API manual. */
    /* If the sub-clock oscillator will not be used, use R_CGC_Control to disable
    the oscillation circuit */

```

```
/* For deep Software Standby mode : the sub-clock oscillator is not fitted,
MUST call R_CGC_Control once to disable the sub-clock oscillation circuit
before calling R_LPC_Control */
R_CGC_Control(
    PDL_NO_DATA,
    PDL_NO_DATA,
    PDL_CGC_SUB_CLOCK_DISABLE
);

/* Enter deep software standby mode */
R_LPC_Control(
    PDL_LPC_MODE_DEEP_SOFTWARE_STANDBY
);

/* An internal reset will occur when exiting from deep software standby */
/* The program counter will not return to here */
while(1);
}

void NMI_handler_lpc(void)
{
    nop();
}
```

Figure 5-8: Example of Deep Software Standby Mode

5.7. Bus Controller

5.7.1. External bus, CS area

Figure 5-9 shows an example of external bus controller usage to chip select areas.

```

/* Peripheral driver function prototypes */
#include "r_pdl_bsc.h"
#include "r_pdl_cgc.h"

/* RPD_L device-specific definitions */
#include "r_pdl_definitions.h"

/* Main clock frequency (Hz) */
#define FREQ_MAIN 12E6

/* Callback function prototype */
void BSC_error_handler(void);

void main(void)
{
    volatile uint8_t * cs0_location_8;
    volatile uint8_t * cs1_location_8;
    volatile uint16_t * cs2_location_16;
    volatile uint16_t * cs3_location_16;
    volatile uint32_t * cs7_location_32;

    /* Point to respective external memory areas */
    cs7_location_32 = ( uint32_t *)0x01000000ul;
    cs3_location_16 = ( uint16_t *)0x05000000ul;
    cs2_location_16 = ( uint16_t *)0x06000000ul;
    cs1_location_8 = ( uint8_t *)0x07000000ul;
    cs0_location_8 = ( uint8_t *)0xFF000000ul;

    /* Configure clocks.
    Run from PLL and enable the External Bus clock (BCLK) */

    /* Prepare the main clock settings */
    R_CGC_Set(
        PDL_CGC_CLK_MAIN,
        PDL_CGC_BCLK_ENABLE | PDL_CGC_SDCLK_DISABLE,
        FREQ_MAIN,
        FREQ_MAIN/4,
        FREQ_MAIN/4,
        FREQ_MAIN/4,
        FREQ_MAIN/4,
        FREQ_MAIN/4,
        FREQ_MAIN/4,
        PDL_NO_DATA,
        PDL_NO_DATA
    );

    /* Prepare the PLL clock settings */
    R_CGC_Set(
        PDL_CGC_CLK_PLL,
        PDL_CGC_BCLK_ENABLE | PDL_CGC_SDCLK_DISABLE,
        192E6,
        96E6,
        48E6,
        48E6,
        24E6,
        24E6,
        PDL_NO_DATA,
        PDL_NO_DATA
    );

    /* Select the PLL as the clock source */
    R_CGC_Control(

```

```
PDL_CGC_CLK_PLL,  
PDL_NO_DATA,  
PDL_NO_DATA  
);  
  
/* Configure area 0 */  
R_BSC_CreateArea(  
    0,  
    PDL_BSC_WIDTH_8,  
    15,  
    15,  
    7,  
    7,  
    31,  
    31,  
    7,  
    7,  
    7,  
    3,  
    7,  
    7,  
    7,  
    7  
);  
  
/* Configure area 1 */  
R_BSC_CreateArea(  
    1,  
    PDL_BSC_WIDTH_8 | PDL_BSC_WRITE_BYTE,  
    0,  
    0,  
    0,  
    0,  
    0,  
    0,  
    0,  
    0,  
    0,  
    0,  
    0,  
    0,  
    0,  
    0,  
    0  
);  
  
/* Configure area 2 */  
R_BSC_CreateArea(  
    2,  
    PDL_BSC_WIDTH_16 | PDL_BSC_WRITE_SINGLE,  
    0,  
    0,  
    0,  
    0,  
    0,  
    0,  
    0,  
    0,  
    0,  
    0,  
    0,  
    0,  
    0,  
    0,  
    0  
);  
  
/* Configure area 3 */  
R_BSC_CreateArea(  
    3,
```

```

        PDL_BSC_WIDTH_16,
        15,
        15,
        7,
        7,
        31,
        31,
        7,
        7,
        7,
        3,
        7,
        7,
        7,
        7
    );

    /* Configure area CS7 */
    R_BSC_CreateArea(
        7,
        PDL_BSC_WIDTH_32,
        15,
        15,
        7,
        7,
        31,
        31,
        7,
        7,
        7,
        3,
        7,
        7,
        7,
        7
    );

    /* Configure the bus controller */
    R_BSC_Create(
        PDL_BSC_CS0_P60 | PDL_BSC_CS1_PC6 | PDL_BSC_CS2_P62 | PDL_BSC_CS3_P63 |
        PDL_BSC_CS7_P67 | PDL_BSC_WAIT_P55 | PDL_BSC_ALE_ENABLE,
        PDL_BSC_A9_DISABLE | PDL_BSC_A23_A16_DISABLE,
        PDL_BSC_RCV_SRRS_ENABLE,
        PDL_BSC_ERROR_ILLEGAL_ADDRESS_ENABLE | PDL_BSC_ERROR_TIME_OUT_ENABLE,
        BSC_error_handler,
        5
    );

    /* Enable the bus controller */
    R_BSC_Control(
        PDL_BSC_ENABLE
    );

    /* Write to external areas */
    *cs0_location_8 = 0x23u;
    *cs1_location_8 = 0xAAu;
    *cs2_location_16 = 0x3344u;
    *cs3_location_16 = 0xAA55u;
    *cs7_location_32 = 0x12345678u;

    /* Disable area CS1 */
    R_BSC_Destroy(
        1
    );
}

```

```
/* BSC error callback function */  
void BSC_error_handler(void)  
{  
    /* Clear the error signals */  
    R_BSC_Control(  
        PDL_BSC_ERROR_CLEAR  
    );  
}
```

Figure 5-9: Example of using the Bus Controller

5.7.2. External bus, SDRAM area

Figure 5-10 shows an example of accessing SDRAM.

```

/* PDL functions */
#include "r_pdl_bsc.h"
#include "r_pdl_cgc.h"

/* PDL device-specific definitions */
#include "r_pdl_definitions.h"

/* SDRAM size */
#define SDRAM_NUM_BYTES (16*1024*1024)

/* Main clock frequency (Hz) */
#define FREQ_MAIN 12E6

void main(void)
{
    uint16_t * sdr_location_16;
    uint32_t index;

    /* Configure clocks. Run from PLL and enable the SDRAM clock (SDCLK) */

    /* Prepare the main clock settings */
    R_CGC_Set(
        PDL_CGC_CLK_MAIN,
        PDL_CGC_SDCLK_ENABLE | PDL_CGC_BCLK_DISABLE,
        FREQ_MAIN,
        FREQ_MAIN/4,
        FREQ_MAIN/4,
        FREQ_MAIN/4,
        FREQ_MAIN/4,
        FREQ_MAIN/4,
        PDL_NO_DATA,
        PDL_NO_DATA
    );

    /* Prepare the PLL clock settings */
    R_CGC_Set(
        PDL_CGC_CLK_PLL,
        PDL_CGC_SDCLK_ENABLE | PDL_CGC_BCLK_DISABLE,
        192E6,
        96E6,
        48E6,
        48E6,
        24E6,
        24E6,
        PDL_NO_DATA,
        PDL_NO_DATA
    );

    /* Select the PLL as the clock source */
    R_CGC_Control(
        PDL_CGC_CLK_PLL,
        PDL_NO_DATA,
        PDL_NO_DATA
    );

    /* Point to start of SDRAM */
    sdr_location_16 = (uint16_t *)0x08000000ul;

    /* Configure the bus controller for SDRAM */
    R_BSC_Create(
        PDL_NO_DATA,
        PDL_BSC_A23_A16_DISABLE |
        PDL_BSC_SDRAM_PINS_ENABLE |
        PDL_BSC_SDRAM_DQM1_ENABLE,

```

```

        PDL_BSC_RCV_SRRS_ENABLE,
        PDL_BSC_ERROR_ILLEGAL_ADDRESS_ENABLE |
            PDL_BSC_ERROR_TIME_OUT_ENABLE,
        PDL_NO_FUNC,
        0
    );

    /* Enable the bus operation */
    /* NOTE: This must be done before calling R_BSC_SDRAM_CreateArea */
    R_BSC_Control(
        PDL_BSC_ENABLE
    );

    /* Configure the SDRAM area */
    R_BSC_SDRAM_CreateArea(
        PDL_BSC_SDRAM_WIDTH_16 | PDL_BSC_SDRAM_8_BIT_SHIFT,
        0x0176u,          // RFC = 375 cycles
        0x04u,           // REFW = 5 cycle
        0x00u,           // ARFI = 3 cycles
        0x0Fu,           // ARFC = 15 times
        0x00u,           // PRC = 3 cycles
        0x02u,           // CL = 2 cycles
        0x00u,           // WR = 1 cycles
        0x01u,           // RP = 2 cycle
        0x00u,           // RCD = 1 cycle
        0x00u,           // RAS = 1 cycle
        0x0220u          // SDMOD = 0x220u;
    );

    /* Perform SDRAM initialization */
    R_BSC_Control(PDL_BSC_SDRAM_INITIALIZATION);

    /* Start Auto-Refresh */
    R_BSC_Control(PDL_BSC_SDRAM_AUTO_REFRESH_ENABLE);

    /* Enable SDRAM operation */
    R_BSC_Control(PDL_BSC_SDRAM_ENABLE);

    /* Write pattern to SDRAM */
    for (index=0; index < (SDRAM_NUM_BYTES/2); index+=2)
    {
        *(sdr_location_16 + index) = 0xAAAAu;
        *(sdr_location_16 + index + 1) = 0x5555u;
    }

    /* Read SDRAM and check contents are as expected */
    for (index=0; index < (SDRAM_NUM_BYTES/2); index+=2)
    {
        if(*(sdr_location_16 + index) != 0xAAAAu)
        {
            /* Error */
            while(1);
        }
        if(*(sdr_location_16 + index + 1) != 0x5555u)
        {
            /* Error */
            while(1);
        }
    }

    while(1);
}

```

Figure 5-10: Example of using the Bus Controller to access SDRAM

5.8. DMA controller

The following example shows the use of triggers by software and IRQ pin edge detection.

Channel 0 will copy the string "Renesas RX63N" into the destination area when a falling edge occurs on pin IRQ2 (P32). Channel 1 will copy the string "Hello, World" into the destination area as soon as it is enabled.

```

/* PDL functions and definitions */
#include "r_pdl_dmac.h"
#include "r_pdl_intc.h"
#include "r_pdl_io_port.h"

/* RPDL device-specific definitions */
#include "r_pdl_definitions.h"

/* Required for this example */
#include <string.h>

/* Callback function prototype */
void DMAC0_transfer_end_handler(void);

/* Data source and destination declarations */
const char source_string_1[]="Renesas RX63N";
const char source_string_2[]="Hello, World";
volatile uint8_t destination_string_1[]=".....";
volatile uint8_t destination_string_2[]=".....";

void main(void)
{
    uint8_t StatusValue;
    uint32_t SourceAddr;
    uint32_t DestAddr;
    uint16_t TransferCount;
    uint16_t SizeCount;

    /* Set the CPU's Interrupt Priority Level to 0 */
    R_INTC_Write(
        PDL_INTC_REG_IPL,
        0
    );

    /* Enable control of LED2 */
    R_IO_PORT_Set(
        PDL_IO_PORT_1_0,
        PDL_IO_PORT_OUTPUT
    );

    /* Configure channel 0 */
    R_DMAM_Create(
        0,
        PDL_DMAM_BLOCK | PDL_DMAM_SOURCE_ADDRESS_PLUS | \
        PDL_DMAM_DESTINATION_ADDRESS_PLUS | \
        PDL_DMAM_SIZE_8 | PDL_DMAM_IRQ_END,
        PDL_DMAM_TRIGGER_IRQ2,
        source_string_1,
        destination_string_1,
        1,
        (uint16_t)strlen(source_string_1),
        PDL_NO_DATA,
        PDL_NO_DATA,
        PDL_NO_DATA,
        DMAC0_transfer_end_handler,
        7
    );

    /* Configure channel 1 */
    R_DMAM_Create(

```

```

        1,
        PDL_DMAC_BLOCK | PDL_DMAC_SOURCE_ADDRESS_PLUS | \
        PDL_DMAC_DESTINATION_ADDRESS_PLUS | PDL_DMAC_SIZE_8,
        PDL_DMAC_TRIGGER_SW,
        source_string_2,
        destination_string_2,
        1,
        (uint16_t)strlen(source_string_2),
        PDL_NO_DATA,
        PDL_NO_DATA,
        PDL_NO_DATA,
        PDL_NO_FUNC,
        0
    );

    /* Set IRQ2 pin to P32 */
    R_INTC_SetExtInterrupt(PDL_INTC_IRQ2_P32, PDL_NO_DATA);

    /* Enable the SW1 (IRQ2) interrupt */
    R_INTC_CreateExtInterrupt(
        PDL_INTC_IRQ2,
        PDL_INTC_FALLING | PDL_INTC_DMAC_TRIGGER_ENABLE,
        PDL_NO_FUNC,
        0
    );

    /* Enable channel 0 */
    R_DMAC_Control(
        0,
        PDL_DMAC_ENABLE,
        PDL_NO_PTR,
        PDL_NO_PTR,
        PDL_NO_DATA,
        PDL_NO_DATA,
        PDL_NO_DATA,
        PDL_NO_DATA,
        PDL_NO_DATA,
        PDL_NO_DATA
    );

    /* Enable and start channel 1 */
    R_DMAC_Control(
        1,
        PDL_DMAC_ENABLE | PDL_DMAC_START,
        PDL_NO_PTR,
        PDL_NO_PTR,
        PDL_NO_DATA,
        PDL_NO_DATA,
        PDL_NO_DATA,
        PDL_NO_DATA,
        PDL_NO_DATA,
        PDL_NO_DATA
    );

    /* Read the status for channel 0 */
    R_DMAC_GetStatus(
        0,
        &StatusValue,
        &SourceAddr,
        &DestAddr,
        &TransferCount,
        &SizeCount
    );

    while (1);
}

void DMAC0_transfer_end_handler(void)
{
    /* Invert the LED2 port pin */

```

```
R_IO_PORT_Modify(  
    PDL_IO_PORT_1_0,  
    PDL_IO_PORT_XOR,  
    1  
);  
  
/* Stop channel 0 */  
R_DMACE_Control(  
    0,  
    PDL_DMACE_SUSPEND,  
    PDL_NO_PTR,  
    PDL_NO_PTR,  
    PDL_NO_DATA,  
    PDL_NO_DATA,  
    PDL_NO_DATA,  
    PDL_NO_DATA,  
    PDL_NO_DATA,  
    PDL_NO_DATA  
);  
  
/* Shutdown channel 0 */  
R_DMACE_Destroy(  
    0  
);  
}
```

Figure 5-11: Two examples of DMACE use

5.9. Data Transfer Controller

5.9.1. Block transfer mode

Figure 5-12 shows an example of Data Transfer Controller usage with a single block transfer.

```

/* Peripheral driver function prototypes */
#include "r_pdl_dtc.h"
#include "r_pdl_io_port.h"
#include "r_pdl_intc.h"

/* RPDLC device-specific definitions */
#include "r_pdl_definitions.h"

/* Required for this example */
#include <string.h>

/* Reserve an area for the DTC vector table */
#pragma address dtc_vector_table = 0x00001000
uint32_t dtc_vector_table[256];

/* Reserve 16 bytes for the IRQ2-triggered transfer data area */
uint32_t dtc_irq_transfer_data[4];

/* Data source and destination declarations */
const char source_string_1[]="Renesas RX63N";
volatile uint8_t destination_string_1[]=".....";

/* Callback function prototype */
void IRQ2_handler(void);

void main(void)
{
    /* Set the CPU's Interrupt Priority Level to 0 */
    R_INTC_Write(
        PDL_INTC_REG_IPL,
        0
    );

    /* Enable control of LED2 */
    R_IO_PORT_Set(
        PDL_IO_PORT_1_0,
        PDL_IO_PORT_OUTPUT
    );

    /* Set the DTC options */
    R_DTC_Set(
        PDL_NO_DATA,
        dtc_vector_table
    );

    /* Configure the DTC for IRQ2 */
    R_DTC_Create(
        PDL_DTC_BLOCK | PDL_DTC_DESTINATION | \
        PDL_DTC_SOURCE_ADDRESS_PLUS | PDL_DTC_DESTINATION_ADDRESS_PLUS | \
        PDL_DTC_SIZE_8 | \
        PDL_DTC_IRQ_COMPLETE | \
        PDL_DTC_TRIGGER_IRQ2,
        dtc_irq_transfer_data,
        source_string_1,
        destination_string_1,
        1,
        (uint8_t)(strlen((char *)source_string_1))
    );

    /* Set IRQ2 pin to P32 */

```

```

R_INTC_SetExtInterrupt(PDL_INTC_IRQ2_P32, PDL_NO_DATA);

/* Enable the SW1 (IRQ2) interrupt */
R_INTC_CreateExtInterrupt(
    PDL_INTC_IRQ2,
    PDL_INTC_FALLING | PDL_INTC_DTC_TRIGGER_ENABLE,
    IRQ2_handler,
    7
);

/* Start the DTC */
R_DTC_Control(
    PDL_DTC_START,
    PDL_NO_PTR,
    PDL_NO_PTR,
    PDL_NO_PTR,
    PDL_NO_DATA,
    PDL_NO_DATA
);
/* Wait for user key press of SW1 */

while (1);
}

void IRQ2_handler(void)
{
    uint16_t StatusValue;
    uint32_t SourceAddr;
    uint32_t DestAddr;
    uint16_t TransferCount;

    /* Read the status and current source address for the IRQ2 transfer */
    R_DTC_GetStatus(
        dtc_irq_transfer_data,
        &StatusValue,
        &SourceAddr,
        &DestAddr,
        &TransferCount,
        PDL_NO_DATA
    );

    /* Invert the LED2 port pin */
    R_IO_PORT_Modify(
        PDL_IO_PORT_1_0,
        PDL_IO_PORT_XOR,
        1
    );

    /* Re-enable IRQ2 as a DTC trigger */
    R_DTC_Control(
        PDL_DTC_TRIGGER_IRQ2,
        PDL_NO_PTR,
        PDL_NO_PTR,
        PDL_NO_PTR,
        PDL_NO_DATA,
        PDL_NO_DATA
    );
}

```

Figure 5-12: Example of DTC use

5.9.2. Chain transfer operation

Figure 5-13 shows an example of Data Transfer Controller operation, using chain transfer of blocks.

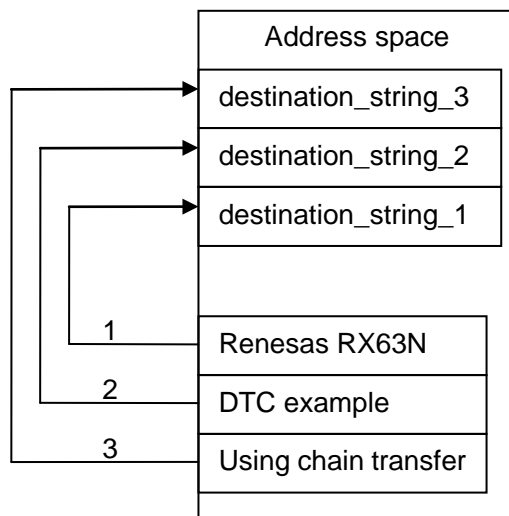

Transfer 1 is triggered by a software interrupt and copies data from ROM into RAM.
 On completion of transfer 1, transfer 2 is started.
 On completion of transfer 2, transfer 3 is started.

```

/* Peripheral driver function prototypes */
#include "r_pdl_dtc.h"
#include "r_pdl_intc.h"

/* RPDLC device-specific definitions */
#include "r_pdl_definitions.h"

/* Required for this example */
#include <string.h>

/* Reserve an area for the DTC vector table */
#pragma address dtc_vector_table = 0x00001000
uint32_t dtc_vector_table[256];

/* Reserve three contiguous groups of 16 bytes (full address mode) for the transfer data
areas */
uint32_t dtc_sw_transfer_data[4 * 3];

const char source_string_1[] = "Renesas RX63N";
const char source_string_2[] = "DTC example";
const char source_string_3[] = "using chain transfer";
volatile char destination_string_1[] = ".....";
volatile char destination_string_2[] = ".....";
volatile char destination_string_3[] = ".....";

void main(void)
{
    /* Enable software interrupts */
    R_INTC_CreateSoftwareInterrupt(
        PDL_INTC_DTC_SW_TRIGGER_ENABLE,
        PDL_NO_FUNC,
        0
    );

    /* Configure the controller */
    R_DTC_Set(
        PDL_DTC_ADDRESS_FULL,
        dtc_vector_table
    );
}

```



```

/* Configure the DTC for Software trigger */
R_DTC_Create(
    PDL_DTC_BLOCK | PDL_DTC_SOURCE | \
    PDL_DTC_SOURCE_ADDRESS_PLUS | PDL_DTC_DESTINATION_ADDRESS_PLUS | \
    PDL_DTC_SIZE_8 | PDL_DTC_CHAIN_0 | PDL_DTC_TRIGGER_SW,
    dtc_sw_transfer_data,
    source_string_1,
    destination_string_1,
    1,
    (uint8_t)strlen(source_string_1)
);

/* Configure the DTC for chain transfer */
R_DTC_Create(
    PDL_DTC_BLOCK | PDL_DTC_SOURCE | \
    PDL_DTC_SOURCE_ADDRESS_PLUS | PDL_DTC_DESTINATION_ADDRESS_PLUS | \
    PDL_DTC_SIZE_8 | PDL_DTC_CHAIN_0 | PDL_DTC_TRIGGER_CHAIN,
    dtc_sw_transfer_data + 4,
    source_string_2,
    destination_string_2,
    1,
    (uint8_t)strlen(source_string_2)
);

/* Configure the DTC for chain transfer */
R_DTC_Create(
    PDL_DTC_BLOCK | PDL_DTC_SOURCE | \
    PDL_DTC_SOURCE_ADDRESS_PLUS | PDL_DTC_DESTINATION_ADDRESS_PLUS | \
    PDL_DTC_SIZE_8 | PDL_DTC_TRIGGER_CHAIN,
    dtc_sw_transfer_data + 8,
    source_string_3,
    destination_string_3,
    1,
    (uint8_t)strlen(source_string_3)
);

/* Start the controller */
R_DTC_Control(
    PDL_DTC_START,
    PDL_NO_PTR,
    PDL_NO_PTR,
    PDL_NO_PTR,
    PDL_NO_DATA,
    PDL_NO_DATA
);

/* Generate a software interrupt request */
R_INTC_Write(
    PDL_INTC_REG_SWINTR,
    1
);
}

```

Figure 5-13: Example of DTC chain transfer

5.10. Port Output Enable

Figure 5-14 shows a usage example of Port Output Enable function.

```

/* PDL functions */
#include "r_pdl_poe.h"

/* PDL device-specific definitions */
#include "r_pdl_definitions.h"

void POE0_3_handler(void);
void POE8_handler(void);

void main(void)
{
    /* Configure POE pins*/
    R_POE_Set(
        PDL_POE_0_MODE_EDGE | PDL_POE_1_MODE_LOW_8 | \
        PDL_POE_2_MODE_LOW_16 | PDL_POE_3_MODE_LOW_128 | \
        PDL_POE_8_MODE_LOW_8,
        PDL_POE_0_PORT_D_7 | PDL_POE_1_PORT_D_6 | \
        PDL_POE_2_PORT_D_5 | PDL_POE_3_PORT_D_4 | \
        PDL_POE_8_PORT_D_3,
        PDL_POE_HI_Z_REQ_8_ENABLE | PDL_POE_HI_Z_REQ_OSTSTE | \
        PDL_POE_HI_Z_REQ_MTIIOC0A | PDL_POE_HI_Z_REQ_MTIIOC0B | \
        PDL_POE_HI_Z_REQ_MTIIOC0C | PDL_POE_HI_Z_REQ_MTIIOC0D
    );

    R_POE_Create(
        PDL_POE_IRQ_HI_Z_0_3_ENABLE | PDL_POE_IRQ_SHORT_3_4_DISABLE,
        POE0_3_handler,
        POE8_handler,
        15
    );

    while(1);
}

void POE0_3_handler(void)
{
    uint16_t StatusFlags;

    /* Read the POE status */
    R_POE_GetStatus(&StatusFlags);
    /* POE0 request? */
    if ((StatusFlags & BIT_0) != 0x0u)
    {
        /* Prevent further interrupts and try to clear the flag */
        R_POE_Control(
            PDL_NO_DATA,
            PDL_POE_FLAG_POE0_CLEAR,
            PDL_POE_IRQ_HI_Z_0_3_ENABLE
        );
    }
}

```

```
void POE8_handler(void)
{
    uint16_t StatusFlags;

    /* Read the POE status */
    R_POE_GetStatus(&StatusFlags);
    /* Prevent further interrupts and try to clear the flag */
    R_POE_Control(
        PDL_NO_DATA,
        PDL_POE_FLAG_POE8_CLEAR,
        PDL_POE_IRQ_HI_Z_8_DISABLE
    );
}
```

Figure 5-14: Example of Port Output Enable function

5.11. Timer Pulse Unit

Figure 5-15 shows an example of Timer Pulse Unit usage.

```

/* Peripheral driver function prototypes */
#include "r_pdl_tpu.h"
#include "r_pdl_cgc.h"

/* RPDL device-specific definitions */
#include "r_pdl_definitions.h"

void main(void)
{
    uint8_t Flags;
    uint16_t General_A;
    uint16_t General_D;

    /* Initialise the system clocks */
    NOTE: The code to initialise the system clock using R_CGC_Set is omitted here.
    Please refer to 5.1 Clock Generation Circuit.

    /* Configure TPU pins*/
    R_TPU_Set(
        0,
        PDL_TPU_PIN_A0_PA0 | PDL_TPU_PIN_B0_P17
    );

    /* Configure channel 0 for dual-waveform (A and B) output */
    R_TPU_Create(
        0,
        0,
        PDL_TPU_CLK_PCLK_DIV_1 | PDL_TPU_CLEAR_CM_B,
        PDL_TPU_A_OC_LOW_CM_INV | PDL_TPU_B_OC_HIGH_CM_INV,
        0,
        0,
        200 - 1,
        400 - 1,
        0,
        0,
        PDL_NO_FUNC,
        PDL_NO_FUNC,
        PDL_NO_FUNC,
        PDL_NO_FUNC,
        0,
        PDL_NO_FUNC,
        PDL_NO_FUNC,
        0
    );

    /* Read the status flags and registers A and D for channel 0 */
    R_TPU_Read(
        0,
        &Flags,
        PDL_NO_PTR,
        &General_A,
        PDL_NO_PTR,
        PDL_NO_PTR,
        &General_D
    );

    /* Modify channel 0 */
    R_TPU_ControlChannel(
        0,
        PDL_TPU_COUNTER,
        0xFFDD,
        PDL_NO_DATA,
        PDL_NO_DATA,

```

```

        PDL_NO_DATA,
        PDL_NO_DATA
    );

    /* Shutdown channels 0 to 5 */
    R_TPU_Destroy(
        0
    );
}
    
```

Figure 5-15: Example of Timer pulse Unit use

The counter is reset when it reaches 399. The 0 value is a valid state so the output toggle frequency is $50 \text{ MHz} \div 400$.

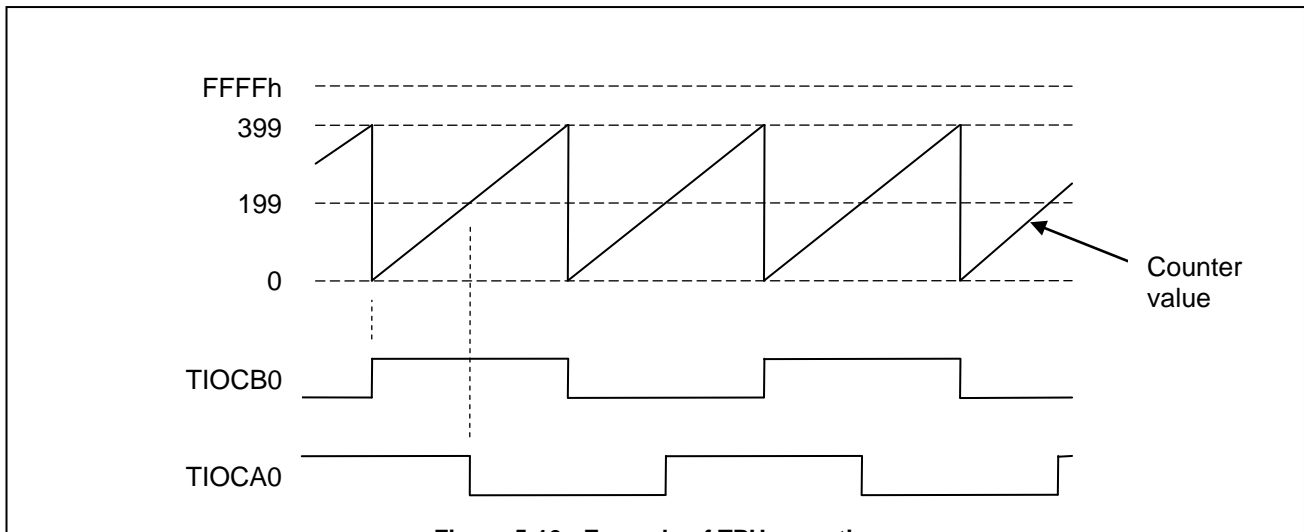

Figure 5-16: Example of TPU operation

5.12. Watchdog Timer

Here the watchdog is configured to generate an NMI interrupt when the counter underflows. Notice how the NMI is enabled for WDT interrupts.

```

/* Peripheral driver function prototypes */
#include "r_pdl_intc.h"
#include "r_pdl_wdt.h"

/* PDL device-specific definitions */
#include "r_pdl_definitions.h"

static void NMI_handler(void);

void main(void)
{
    /* Enable the NMI interrupt for WDT */
    R_INTC_CreateExtInterrupt(
        PDL_INTC_NMI,
        PDL_INTC_WDT_ENABLE,
        NMI_handler,
        7
    );

    /* Configure WDT with a 25% to 75% window, no reset - hence generate NMI. */
    R_WDT_Set(
        PDL_WDT_TIMEOUT_1024 | PDL_WDT_PCLK_DIV_2048 |
        PDL_WDT_WIN_START_75 | PDL_WDT_WIN_END_25 |
        PDL_WDT_TIMEOUT_NMI
    );

    /* Main program loop */
    while(1)
    {
        /* Refresh the watchdog */
        R_WDT_Control(
            PDL_WDT_RESET_COUNTER
        );

        /* User code is omitted here. */
    }
}

static void NMI_handler(void)
{
    uint16_t Status;

    /* Read the WDT status */
    R_WDT_Read(
        &Status
    );

    /* Has an underflow occurred? */
    if ((Status & BIT_14) != 0x0u)
    {
        /* Handle the watchdog underflow here */
        while(1);
    }

    /* Has a refresh error occurred? */
    if ((Status & BIT_15) != 0x0u)
    {
        /* Handle the watchdog refresh error here */
        while(1);
    }
}

```

Figure 5-17: Example of Watchdog Timer use

5.13. 8-bit Timer

5.13.1. Periodic operation

Timer channel 0 is configured to provide pulses on pin TMO0, with a pulse width of 500 μ s and an on-time of 200 μ s.

```

/* Peripheral driver function prototypes */
#include "r_pdl_tmr.h"
#include "r_pdl_cgc.h"
#include "r_pdl_intc.h"

/* RPD_L device-specific definitions */
#include "r_pdl_definitions.h"

void main(void)
{
    /* Initialise the system clocks */
    NOTE: The code to initialise the system clock using 4.2.1.1) is omitted here.
    Please refer to 5.1 Clock Generation Circuit.

    /* Select the PLL as the clock source */
    R_CGC_Control(
        PDL_CGC_CLK_PLL,
        PDL_NO_DATA,
        PDL_NO_DATA
    );

    /* Set the CPU's Interrupt Priority Level to 0 */
    R_INTC_Write(
        PDL_INTC_REG_IPL,
        0
    );

    /* Configure TMR0 input and output pins */
    R_TMR_Set(
        0,
        PDL_TMR_TMR0_TMO0_PB3 | PDL_TMR_TMR0_TMCI0_PB1 | PDL_TMR_TMR0_TMRIO_PA4
    );

    /* Configure TMR0 for 500 $\mu$ s pulse width, 200 $\mu$ s on-time */
    R_TMR_CreatePeriodic(
        PDL_TMR_TMR0,
        PDL_TMR_PERIOD | PDL_TMR_OUTPUT_HIGH,
        500E-6,
        200E-6,
        PDL_NO_FUNC,
        PDL_NO_FUNC,
        0
    );

    /* The same operation, using frequency and duty cycle */
    R_TMR_CreatePeriodic(
        PDL_TMR_TMR0,
        PDL_TMR_FREQUENCY | PDL_TMR_OUTPUT_HIGH,
        2E6,
        40,
        PDL_NO_FUNC,
        PDL_NO_FUNC,
        0
    );
}

```

Figure 5-18: Example of Pulse Output code

For full flexibility, the `R_TMR_CreateChannel()` function can be used.

In this example, Timer channel 0 is configured to provide pulses on pin TMO0, with a pulse width of 200 ticks of PCLKB and a duty cycle of 50%.

Note that the output transitions and counter clearing occur after the compare match has occurred. So the values for compare match A and compare match B should be 1 less than the required count.

```

/* Peripheral driver function prototypes */
#include "r_pdl_tmr.h"
#include "r_pdl_definitions.h"

void main(void)
{
    /* Configure TMR0 input and output pins */
    R_TMR_Set(
        0,
        PDL_TMR_TMR0_TMO0_PB3
    );
    /* Configure TMR0 to clear on a compare match A, output 1 at a compare match A and
    output 0 at a compare match B */
    R_TMR_CreateChannel(
        0,
        PDL_TMR_CLK_PCLK_DIV_1 | PDL_TMR_CLEAR_CM_A,
        PDL_TMR_OUTPUT_HIGH_CM_A | PDL_TMR_OUTPUT_LOW_CM_B,
        0,
        (200 - 1),
        (200 / 2) - 1,
        PDL_NO_FUNC,
        PDL_NO_FUNC,
        PDL_NO_FUNC,
        0
    );
}

```

Figure 5-19: Example of Pulse Output code

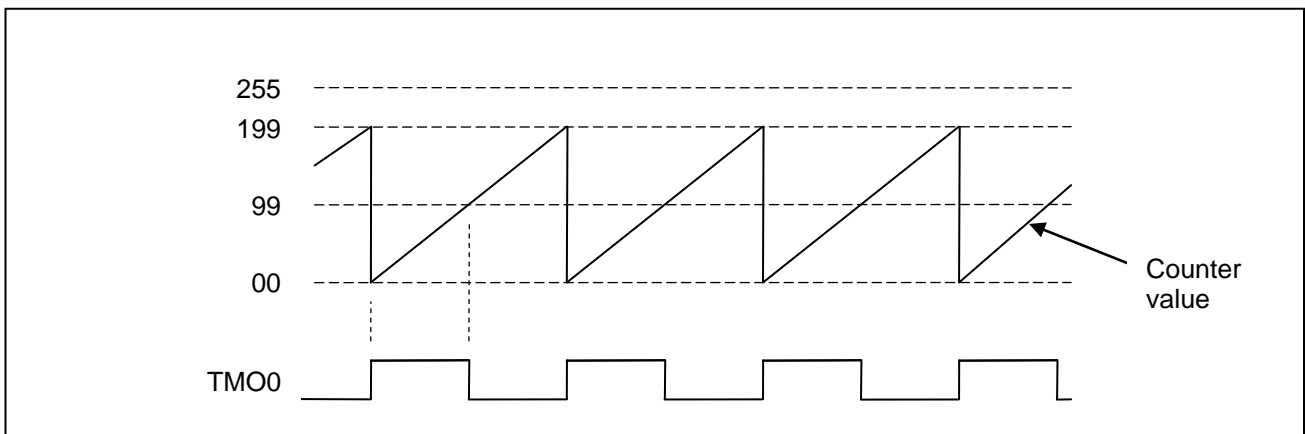

Figure 5-20: Example of pulse output operation

5.14. Compare Match Timer

Figure 5-21 shows an example of Compare Match Timer usage. One channel is used to generate interrupts at regular intervals.

```

/* Peripheral driver function prototypes */
#include "r_pdl_cmt.h"
#include "r_pdl_cgc.h"
#include "r_pdl_io_port.h"
#include "r_pdl_intc.h"

/* RPDL device-specific definitions */
#include "r_pdl_definitions.h"

/* Callback function prototype */
void CMT0_handler(void);
void CMT1_handler(void);

void main(void)
{
    uint8_t  Flags;
    uint16_t Counter;
    uint32_t delay_counter = 0;

    /* Initialise the system clocks */
    NOTE: The code to initialise the system clock using R_CGC_Set is omitted here.
    Please refer to 5.1 Clock Generation Circuit.

    /* Select the MAIN as the clock source */
    R_CGC_Control(PDL_CGC_CLK_MAIN, PDL_NO_DATA, PDL_NO_DATA);

    /* Set the CPU's Interrupt Priority Level to 0 */
    R_INTC_Write(PDL_INTC_REG_IPL, 0);

    /* Configure a port pin for output */
    R_IO_PORT_Set(PDL_IO_PORT_0_5, PDL_IO_PORT_OUTPUT);
    R_IO_PORT_Set(PDL_IO_PORT_1_0, PDL_IO_PORT_OUTPUT);

    R_IO_PORT_Write(PDL_IO_PORT_0_5, 1);      /* off LED1 */
    R_IO_PORT_Write(PDL_IO_PORT_1_0, 0);      /* on LED2 */

    /* Configure CMT channel 0 for 1kHz operation, but not start CMT first */
    R_CMT_Create(
        0,
        PDL_CMT_FREQUENCY | PDL_CMT_STOP,
        1E3,
        CMT0_handler,
        7);

    /* Configure CMT channel 1 in 0.1sec period and start CMT*/
    R_CMT_Create(
        1,
        PDL_CMT_PERIOD,
        1E-1,
        CMT1_handler,
        7);

    /* Change the frequency to 10kHz */
    R_CMT_Control(0, PDL_CMT_FREQUENCY, 10E3);

    R_CMT_Read(0, PDL_NO_PTR, PDL_NO_PTR);
    R_CMT_Read(1, &Flags, &Counter);

    /* Wait for 2sec */
    R_CMT_CreateOneShot(0, PDL_NO_DATA, 2.0, PDL_NO_FUNC, 0);

    R_CMT_Control(0, PDL_CMT_START, 0); /* Now start CMT0 */

```

```
R_CMT_Control(1, PDL_CMT_STOP, 0); /* Now stop CMT1 */  
  
while(1);  
}  
  
void CMT0_handler(void)  
{  
    /* Invert the port pin */  
    R_IO_PORT_Modify(PDL_IO_PORT_0_5, PDL_IO_PORT_XOR, 1);  
}  
  
void CMT1_handler(void)  
{  
    /* Toggle the LED1 state */  
    R_IO_PORT_Modify(PDL_IO_PORT_1_0, PDL_IO_PORT_XOR, 1);  
}
```

Figure 5-21: Example of Compare Match Timer use

5.15. Real-time Clock

5.15.1. Use case of RTC (configuration and use case)

These examples show initialization procedure of simple RTC use case.

- 1) Configuration CGC and RTC counting by sub-clock

Figure 5-22 shows an example of sub clock is used as count source and main clock used as system clock before using the Real-time clock.

```

/* PDL functions */
#include "r_pdl_cgc.h"
#include "r_pdl_cmt.h"
#include "r_pdl_rtc.h"

/* PDL device-specific definitions */
#include "r_pdl_definitions.h"

void main(void)
{
    volatile uint32_t date,time;
    volatile uint8_t st_flg;

    /* Configure main clock operation using a 12.0 MHz crystal */
    /* ICLK = 3 MHz, PCLKA = 3 MHz , PCLKB = 3 MHz , FCLK = 3 MHz */
    /* BCLK = 3 MHz, BCLK (pin) = 1.5 MHz, IECLK = not used, UCLK = not used */
    R_CGC_Set(
        PDL_CGC_CLK_MAIN,
        PDL_CGC_BCLK_DIV_2 | PDL_CGC_SDCLK_DISABLE | PDL_CGC_RTC_SRC_SUB,
        12E6,
        3E6,
        3E6,
        3E6,
        3E6,
        3E6,
        PDL_NO_DATA,
        PDL_NO_DATA,
        PDL_NO_DATA
    );

    /* Configure sub-clock operation. The sub-clock will be set to 32.768kHz */
    R_CGC_Set(
        PDL_CGC_CLK_SUB_CLOCK,
        PDL_CGC_BCLK_DISABLE | PDL_CGC_SDCLK_DISABLE,
        32768,
        32768,
        32768,
        32768,
        32768,
        PDL_NO_DATA,
        PDL_NO_DATA,
        PDL_NO_DATA,
        PDL_CGC_SUB_32768
    );

    /* Generate the 2s delay before enabling RTC by CGC_Control */
    R_CMT_CreateOneShot(0,PDL_NO_DATA,2,PDL_NO_FUNC,0);

    /* Select main clock as system clock and set RTC is used */
    R_CGC_Control(
        PDL_CGC_CLK_MAIN,
        PDL_NO_DATA,
        PDL_CGC_RTC_TO_BE_USED
    );

    R_RTC_Create(
        PDL_NO_DATA,

```

```
PDL_NO_DATA,  
0x04140710, /* WED 14:07:10 */  
0x20140402, /* 20140402 */  
PDL_RTC_CAPTURE_FILTER_OFF,  
PDL_RTC_CAPTURE_FILTER_OFF,  
PDL_NO_DATA,  
PDL_NO_DATA,  
PDL_NO_DATA,  
PDL_NO_DATA,  
PDL_NO_FUNC,  
PDL_NO_DATA,  
PDL_NO_FUNC,  
PDL_NO_DATA  
);  
  
while(1)  
{  
    R_RTC_Read(  
        PDL_RTC_READ_CURRENT,  
        PDL_NO_PTR,  
        &time,  
        &date  
    );  
}
```

Figure 5-22: Example of configuration CGC and RTC counting by sub-clock

2) Configuration CGC and RTC counting by main clock

Figure 5-23 shows an example of main clock is used as count source and PLL used as system clock before using the Real-time clock.

```

/* PDL functions */
#include "r_pdl_cgc.h"
#include "r_pdl_cmt.h"
#include "r_pdl_rtc.h"

/* PDL device-specific definitions */
#include "r_pdl_definitions.h"

void main(void)
{
    volatile uint32_t date,time;
    volatile uint8_t st_flg;

    /* Configure main clock operation using a 12.0 MHz crystal */
    /* ICLK = 3 MHz, PCLKA = 3 MHz , PCLKB = 3 MHz , FCLK = 3 MHz */
    /* BCLK = 3 MHz, BCLK (pin) = 1.5 MHz, IECLK = not used, UCLK = not used */
    R_CGC_Set(
        PDL_CGC_CLK_MAIN,
        PDL_CGC_BCLK_DIV_2 | PDL_CGC_SDCLK_DISABLE | PDL_CGC_RTC_SRC_MAIN,
        12E6,
        3E6,
        3E6,
        3E6,
        3E6,
        3E6,
        PDL_NO_DATA,
        PDL_NO_DATA,
        PDL_NO_DATA
    );

    /* Configure PLL operation. The PLL will be set to 192 MHz */
    /* ICLK = 96 MHz, PCLKB = 96 MHz, PCLKB = 48 MHz, FCLK = 48 MHz */
    /* BCLK = 48 MHz, BCLK (pin) = 24 MHz, IECLK = not used, UCLK = not used */
    R_CGC_Set(
        PDL_CGC_CLK_PLL,
        PDL_CGC_BCLK_DIV_2 | PDL_CGC_SDCLK_DISABLE,
        192E6,
        96E6,
        48E6,
        48E6,
        48E6,
        48E6,
        PDL_NO_DATA,
        PDL_NO_DATA,
        PDL_NO_DATA
    );

    /* Configure sub-clock operation. The sub-clock will be set to 32.768kHz */
    R_CGC_Set(
        PDL_CGC_CLK_SUB_CLOCK,
        PDL_CGC_BCLK_DISABLE | PDL_CGC_SDCLK_DISABLE,
        32768,
        32768,
        32768,
        32768,
        32768,
        PDL_NO_DATA,
        PDL_NO_DATA,
        PDL_NO_DATA,
        PDL_CGC_SUB_32768
    );

    /* Generate the 2s delay before enabling RTC by CGC_Control */
    R_CMT_CreateOneShot(0,PDL_NO_DATA,2,PDL_NO_FUNC,0);
}

```

```
/* Select PLL clock as system clock and set RTC is used */
R_CGC_Control(
    PDL_CGC_CLK_PLL,
    PDL_NO_DATA,
    PDL_CGC_RTC_TO_BE_USED
);

R_RTC_Create(
    PDL_NO_DATA,
    PDL_NO_DATA,
    0x04140710, /* WED 14:07:10 */
    0x20140402, /* 20140402 */
    PDL_RTC_CAPTURE_FILTER_OFF,
    PDL_RTC_CAPTURE_FILTER_OFF,
    PDL_NO_DATA,
    PDL_NO_DATA,
    PDL_NO_DATA,
    PDL_NO_DATA,
    PDL_NO_FUNC,
    PDL_NO_DATA,
    PDL_NO_FUNC,
    PDL_NO_DATA
);

while(1)
{
    R_RTC_Read(
        PDL_RTC_READ_CURRENT,
        PDL_NO_PTR,
        &time,
        &date
    );
}
}
```

Figure 5-23: Example of configuration CGC and RTC counting by main clock

3) Use using capture pin

Figure 5-24 shows an example of using the RTC with a capture pin. The main clock is used as RTC count source and HOCO is used as system clock.

```

/* PDL functions */
#include "r_pdl_cgc.h"
#include "r_pdl_cmt.h"
#include "r_pdl_rtc.h"

/* PDL device-specific definitions */
#include "r_pdl_definitions.h"

uint8_t flags;
uint32_t time;
uint32_t date;

void main(void)
{
    volatile bool bDetected = false;

    /* Configure main clock operation using a 12.0 MHz crystal */
    /* ICLK = 3 MHz, PCLKA = 3 MHz , PCLKB = 3 MHz , FCLK = 3 MHz */
    /* BCLK = IECLK = not used, UCLK = 4 MHz, BCLK(pin) not used */
    R_CGC_Set(
        PDL_CGC_CLK_MAIN,
        PDL_CGC_BCLK_DISABLE | PDL_CGC_SDCLK_DISABLE | PDL_CGC_RTC_SRC_MAIN,
        12E6,
        3E6,
        3E6,
        3E6,
        3E6,
        PDL_NO_DATA,
        PDL_NO_DATA,
        PDL_NO_DATA,
        PDL_NO_DATA
    );

    /* Prepare the HOCO settings and Initialse Main clock as RTC count source */
    R_CGC_Set(
        PDL_CGC_CLK_HOCO,
        PDL_CGC_BCLK_DISABLE | PDL_CGC_SDCLK_DISABLE,
        50E6,
        50E6,
        50E6,
        50E6, /* PCLKB clock >= the frequency of the count source clock. */
        50E6,
        PDL_NO_DATA,
        PDL_NO_DATA,
        PDL_NO_DATA,
        PDL_NO_DATA
    );

    /* Select the hoco as the system clock source */
    R_CGC_Control(
        PDL_CGC_CLK_HOCO,
        PDL_NO_DATA,
        PDL_CGC_RTC_TO_BE_USED
    );

    /* Set the current time and enable the alarm */
    R_RTC_Create(
        PDL_RTC_24_HOUR_MODE,
        PDL_RTC_PIN_RTCIC2_P32,
        0xFF114250, /* Automatic day of week, 11:42:50 */
        0x20131118, /* 18-Nov-2013 */
        PDL_NO_DATA, /* Capture 0 */
        PDL_NO_DATA, /* Capture 1 */
    );
}

```

```
PDL_RTC_CAPTURE_EDGE_FALLING |
PDL_RTC_CAPTURE_FILTER_ON_DIV_1, /* Capture 2 */
PDL_NO_DATA, /* Periodic Setup */
PDL_NO_DATA, /* Alarm time */
PDL_NO_DATA, /* Alarm date */
PDL_NO_FUNC, /* Alarm callback */
PDL_NO_DATA, /* Alarm priority */
PDL_NO_FUNC, /* Periodic callback */
PDL_NO_DATA /* Periodic priority */
);

while (1)
{
    /* Read Capture status until see that an edge has been detected. */
    R_RTC_Read(PDL_RTC_READ_CAPTURE_2,
               &flags, &time, &date);

    if(1 == (flags & BIT_0))
    {
        bDetected = true;
        /* NOTE: Variables time and date now hold
           the time when the edge was detected. */
    }
}
}
```

Figure 5-24: Example of using RTC with a capture pin

5.15.2. Initialization in case of RTC is not used

- 1) Initialize RTC with providing sub-clock (use-case sub clock is available)

Figure 5-25 shows an example of initialization in case of RTC is not used and sub clock is available.

```

/* PDL functions */
#include "r_pdl_cgc.h"
#include "r_pdl_cmt.h"
#include "r_pdl_rtc.h"

/* PDL device-specific definitions */
#include "r_pdl_definitions.h"

void main(void)
{
    volatile uint32_t date,time;
    volatile uint8_t st_flg;

    /* Prepare the HOCO clock settings and sub clock as RTC count source */
    R_CGC_Set(
        PDL_CGC_CLK_HOCO,
        PDL_CGC_BCLK_DISABLE | PDL_CGC_SDCLK_DISABLE | PDL_CGC_RTC_SRC_SUB,
        50E6,
        50E6,
        50E6, /* PCLKB clock >= the frequency of the count source clock. */
        50E6,
        PDL_NO_DATA,
        PDL_NO_DATA,
        PDL_NO_DATA,
        PDL_NO_DATA
    );

    /* Configure sub-clock operation. The sub-clock will be set to 32.768kHz */
    R_CGC_Set(
        PDL_CGC_CLK_SUB_CLOCK,
        PDL_CGC_BCLK_DISABLE | PDL_CGC_SDCLK_DISABLE,
        32768,
        32768,
        32768,
        32768,
        32768,
        PDL_NO_DATA,
        PDL_NO_DATA,
        PDL_NO_DATA,
        PDL_CGC_SUB_32768
    );

    /* Generate the 2s delay before enabling RTC by CGC_Control */
    R_CMT_CreateOneShot(0, PDL_NO_DATA, 2, PDL_NO_FUNC, 0);

    /* Select HOCO clock as system clock and set RTC is not used */
    R_CGC_Control(
        PDL_CGC_CLK_HOCO,
        PDL_NO_DATA,
        PDL_CGC_RTC_NOT_USE
    );

    while(1);
}

```

Figure 5-25: Example of initialization of not using RTC with available sub clock

2) Initialize RTC with providing main-clock (use-case main clock is available)

Figure 5-26 shows an example of initialization in case of RTC is not used and main clock is available.

```

/* PDL functions */
#include "r_pdl_cgc.h"
#include "r_pdl_cmt.h"
#include "r_pdl_rtc.h"

/* PDL device-specific definitions */
#include "r_pdl_definitions.h"

void main(void)
{
    volatile uint32_t date,time;
    volatile uint8_t st_flg;

    /* Prepare the HOCO clock settings and main clock as RTC count source */
    R_CGC_Set(
        PDL_CGC_CLK_HOCO,
        PDL_CGC_BCLK_DISABLE | PDL_CGC_SDCLK_DISABLE | PDL_CGC_RTC_SRC_MAIN,
        50E6,
        50E6,
        50E6, /* PCLKB clock >= the frequency of the count source clock. */
        50E6,
        50E6,
        PDL_NO_DATA,
        PDL_NO_DATA,
        PDL_NO_DATA,
        PDL_NO_DATA
    );

    /* Prepare the main clock settings */
    R_CGC_Set(
        PDL_CGC_CLK_MAIN,
        PDL_CGC_BCLK_DISABLE | PDL_CGC_SDCLK_DISABLE,
        12E6,
        12E6/4,
        12E6/4,
        12E6/4,
        12E6/4,
        PDL_NO_DATA,
        PDL_NO_DATA,
        PDL_NO_DATA,
        PDL_NO_DATA
    );

    /* Generate the 2s delay before enabling RTC by CGC_Control */
    R_CMT_CreateOneShot(0, PDL_NO_DATA, 2, PDL_NO_FUNC, 0);

    /* Select HOCO clock as system clock and set RTC is not used */
    R_CGC_Control(
        PDL_CGC_CLK_HOCO,
        PDL_NO_DATA,
        PDL_CGC_RTC_NOT_USE
    );

    while(1);
}

```

Figure 5-26: Example of initialization of not using RTC with available main clock

3) Initialize RTC without providing clock

Figure 5-27 shows an example of initialization in case of RTC is not used and RTC count source is not defined.

```

/* PDL functions */
#include "r_pdl_cgc.h"
#include "r_pdl_cmt.h"
#include "r_pdl_rtc.h"

/* PDL device-specific definitions */
#include "r_pdl_definitions.h"

void main(void)
{
    volatile uint32_t date,time;
    volatile uint8_t st_flg;

    /* Prepare the HOCO clock settings and set RTC count source NONE */

    /* Prepare the main clock settings */
    R_CGC_Set(
        PDL_CGC_CLK_MAIN,
        PDL_CGC_BCLK_DISABLE | PDL_CGC_SDCLK_DISABLE | PDL_CGC_RTC_SRC_NONE,
        12E6,
        12E6/4,
        12E6/4,
        12E6/4,
        12E6/4,
        PDL_NO_DATA,
        PDL_NO_DATA,
        PDL_NO_DATA,
        PDL_NO_DATA
    );

    /* Generate the 2s delay before enabling RTC by CGC_Control */
    R_CMT_CreateOneShot(0,PDL_NO_DATA,2,PDL_NO_FUNC,0);

    /* Select main clock as system clock and set RTC is not used */
    R_CGC_Control(
        PDL_CGC_CLK_MAIN,
        PDL_NO_DATA,
        PDL_CGC_RTC_NOT_USE
    );

    while(1);
}

```

Figure 5-27: Example of initialization of not using RTC without providing clock

5.15.3. Use case of RTC over reset and power consumption

1) Wake up from sleep mode

Figure 5-28 shows an example of using the RTC is used and wake up from sleep mode. The HOCO-clock is used as system and main clock as RTC count source.

```

#include <stdio.h>
#include <string.h>

/* PDL functions */
#include "r_pdl_cgc.h"
#include "r_pdl_lpc.h"
#include "r_pdl_intc.h"
#include "r_pdl_io_port.h"
#include "r_pdl_cmt.h"
#include "r_pdl_mcu.h"
#include "r_pdl_rtc.h"
#include "r_pdl_sci.h"

/* PDL device-specific definitions */
#include "r_pdl_definitions.h"

#define RSK_SCI_CHANNEL 0

static void SetClocks(void);
static void Alarm_handler(void);
static void SW1_handler(void);

volatile bool bEnterSleepMode = false;

void main(void)
{
    uint8_t flags;
    uint32_t time;
    uint32_t date;
    uint32_t time_previous = 0;
    uint8_t buffer[50];
    uint16_t status=0;

    /* Sets system clock */
    SetClocks();

    /* Create async for debug output */
    R_SCI_Set(
        RSK_SCI_CHANNEL,
        PDL_SCI_PIN_SCI0_RXD0_P21 | PDL_SCI_PIN_SCI0_TXD0_P20
    );

    R_SCI_Create(
        RSK_SCI_CHANNEL,
        PDL_SCI_ASYNC,
        9600,
        1,
        0);

    /* Check warm/cold start flag (CWSF = 1):
    Call R_RTC_CreateWarm to start up the RTC if warm/cold start flag is detected
    (power ON from warm start) */

    /* Get Reset Status Flag */
    R_MCU_GetStatus(
        PDL_NO_PTR,
        &status,
        PDL_NO_PTR,
        PDL_NO_PTR
    );
}

```

```

/* RSTSR1.CWSF : Warm start ? */
/* RTC is running ? */
if (((status & BIT_8) == (uint16_t)(BIT_8)) && ((RTC.RCR2.BIT.START) != 0))
{
    /* If warm-start is detected and RTC is running, then warm start */
    R_SCI_Send(RSK_SCI_CHANNEL, PDL_NO_DATA,
        "\r\nRTC Start in Warm start mode: Control to change time\r\n", 0, PDL_NO_FUNC);

    /* Warm wake up : Read time */
    R_RTC_Read(PDL_RTC_READ_CURRENT, &flags, &time, &date);

    sprintf((char*)buffer, "RTC Time before changing = %d%d:%d%d:%d%d \r\n",
        (int)(time & 0xF00000) >> 20,
        (int)(time & 0x0F0000) >> 16,
        (int)(time & 0x00F000) >> 12,
        (int)(time & 0x000F00) >> 8,
        (int)(time & 0x0000F0) >> 4,
        (int)(time & 0x00000F) >> 0);

    R_SCI_Send(RSK_SCI_CHANNEL, PDL_NO_DATA, buffer, 0, PDL_NO_FUNC);

    R_RTC_CreateWarm(
        Alarm_handler, /* Alarm handler */
        15, /* Alarm priority */
        PDL_NO_FUNC, /* Periodic Handler */
        PDL_NO_DATA /* Periodic priority */
    );

    R_RTC_Read(
        PDL_RTC_READ_CURRENT,
        PDL_NO_PTR,
        &time,
        &date
    );

    /* Configure the clock */
    R_RTC_Control(
        PDL_NO_DATA,
        PDL_RTC_UPDATE_ALARM_TIME,
        PDL_NO_DATA,
        PDL_NO_DATA,
        (time + 0x10), /* Alarm in another 10 seconds */
        PDL_NO_DATA,
        PDL_NO_DATA, /* Error Adjust */
        PDL_NO_DATA, /* Capture */
        PDL_NO_DATA, /* Capture */
        PDL_NO_DATA, /* Capture */
        PDL_NO_DATA /* Periodic */
    );
}
else
{
    /* If Cold-start is detected the RTC clock should be re-started */

    R_SCI_Send(RSK_SCI_CHANNEL, PDL_NO_DATA,
        "\r\nRTC Start in Cold start mode: Initailize RTC\r\n", 0, PDL_NO_FUNC);

    if (R_RTC_Create(
        PDL_RTC_ALARM_TIME_ENABLE | PDL_RTC_ALARM_DATE_ENABLE,
        PDL_NO_DATA,
        0xFF114250, /* Automatic day of week, 11:42:50 */
        0x20131118, /* 18-Nov-2013 */
        PDL_NO_DATA, /* Capture 0 */
        PDL_NO_DATA, /* Capture 1 */
        PDL_NO_DATA, /* Capture 2 */
        PDL_NO_DATA, /* Periodic */
        0xFF114300, /* Alarm in 10 seconds */
    ))

```

```

        0x20131118, /* 18-Nov-2013 */
        Alarm_handler,
        15,
        PDL_NO_FUNC,
        PDL_NO_DATA
    ) == false)
    {
        R_SCI_Send(RSK_SCI_CHANNEL, PDL_NO_DATA,
            "\r\nRTC_Create error in Cold start mode\r\n", 0, PDL_NO_FUNC);
        while(1);
    }

    /* After the complete initialization, Set the warm start indicator */
    R_MCU_Control(
        PDL_MCU_WARM_START
    );
}

/* Set Switch1 interrupt */
R_INTC_SetExtInterrupt(
    PDL_INTC_IRQ2_P32, PDL_NO_DATA
);

/* Enable the SW1 interrupt */
R_INTC_CreateExtInterrupt(
    PDL_INTC_IRQ2,
    PDL_INTC_FALLING,
    SW1_handler,
    7
);

R_LPC_Create(
    PDL_LPC_HIGH_SPEED_MODE,
    PDL_NO_DATA,
    PDL_NO_DATA,
    PDL_NO_DATA,
    PDL_NO_DATA,
    PDL_NO_DATA,
    PDL_NO_DATA
);

R_RTC_Read(
    PDL_RTC_READ_CURRENT,
    PDL_NO_PTR,
    &time,
    &date
);

/* Enter sleep mode after alarm in 10sec. */
while (bEnterSleepMode == false);

/* Enter sleep mode. An internal reset will occur. */
if(false == R_LPC_Control(PDL_LPC_MODE_SLEEP))
{
    while(1);
}

/* It is correct to be here if have just woken from sleep mode. */
while(1)
{
    /* Read time */
    R_RTC_Read(PDL_RTC_READ_CURRENT, &flags, &time, &date);

    /* If no carry error output the time */
    if (0 == (flags & BIT_6))
    {
        /* Has time changed */
        if ((time & 0xFFFFF) != (time_previous & 0xFFFFF))

```

```

        {
            time_previous = time;
            sprintf((char*)buffer, "Time = %d%d:%d%d:%d%d \r\n",
                (int)(time & 0xF00000) >> 20,
                (int)(time & 0x0F0000) >> 16,
                (int)(time & 0x00F000) >> 12,
                (int)(time & 0x000F00) >> 8,
                (int)(time & 0x0000F0) >> 4,
                (int)(time & 0x00000F) >> 0);

            R_SCI_Send(
                RSK_SCI_CHANNEL,
                PDL_NO_DATA,
                buffer,
                0,
                PDL_NO_FUNC);
        }
    }
}

static void SetClocks(void)
{
    /* Prepare the LOCO settings */
    R_CGC_Set(
        PDL_CGC_CLK_LOCO,
        PDL_CGC_BCLK_DISABLE | PDL_CGC_SDCLK_DISABLE | \
        PDL_CGC_RTC_SRC_MAIN,
        125E3,
        125E3,
        125E3,
        125E3,
        125E3,
        PDL_NO_DATA,
        PDL_NO_DATA,
        PDL_NO_DATA,
        PDL_NO_DATA
    );

    /* Configure main clock operation using a 12.0 MHz crystal */
    R_CGC_Set(
        PDL_CGC_CLK_MAIN,
        PDL_CGC_BCLK_DISABLE | PDL_CGC_SDCLK_DISABLE,
        12E6,
        3E6,
        3E6,
        3E6,
        3E6,
        PDL_NO_DATA,
        PDL_NO_DATA,
        PDL_NO_DATA,
        PDL_NO_DATA
    );

    /* Configure the HOCO settings */
    R_CGC_Set(
        PDL_CGC_CLK_HOCO,
        PDL_CGC_BCLK_DISABLE | PDL_CGC_SDCLK_DISABLE,
        50E6,
        50E6,
        50E6,
        50E6,
        50E6,
        PDL_NO_DATA,
        PDL_NO_DATA,
        PDL_NO_DATA,
        PDL_NO_DATA
    );
}

```

```

/* Sub-clock */
R_CGC_Set(
    PDL_CGC_CLK_SUB_CLOCK,
    PDL_CGC_BCLK_DISABLE | PDL_CGC_SDCLK_DISABLE,
    32768,          /* Frequency of selected clock source */
    (32768 / 1),   /* Frequency of System clock (ICLK) */
    (32768 / 1),   /* Frequency of Peripheral A clock (PCLKA) */
    (32768 / 1),   /* Frequency of Peripheral B clock (PCLKB) */
    (32768 / 1),   /* Frequency of Flash memory clock (FCLK) */
    PDL_NO_DATA,   /* Frequency of External bus clock */
    PDL_NO_DATA,   /* Frequency of IEBUS */
    PDL_NO_DATA,   /* Frequency of USB clock */
    PDL_CGC_SUB_65536 /* Sub-clock stabilization time */
);

/* Wait for the Subclock stabilisation time (2 seconds minimum) */
/* NOTE: As currently running from the LOCO the R_CMT_CreateOneShot
max time limit is > 2 Secs. */
R_CMT_CreateOneShot(
    0,
    PDL_NO_DATA,
    2.0,
    PDL_NO_FUNC,
    0
);

/* Select the HOCO as the clock source */
R_CGC_Control(
    PDL_CGC_CLK_HOCO,
    PDL_NO_DATA,
    PDL_CGC_RTC_TO_BE_USED
);
}

void Alarm_handler(void)
{
    uint8_t flags;
    uint32_t time;
    uint32_t date;
    uint8_t buffer[50];

    /* Read time */
    R_RTC_Read(PDL_RTC_READ_CURRENT, &flags, &time, &date);

    sprintf((char*)buffer, "Time = %d:%d:%d:%d \r\n",
        (int)(time & 0xF00000) >> 20,
        (int)(time & 0x0F0000) >> 16,
        (int)(time & 0x00F000) >> 12,
        (int)(time & 0x000F00) >> 8,
        (int)(time & 0x0000F0) >> 4,
        (int)(time & 0x00000F) >> 0);

    R_SCI_Send(RSK_SCI_CHANNEL, PDL_NO_DATA, buffer, 0, PDL_NO_FUNC);

    /* Configure the clock */
    R_RTC_Control(
        PDL_NO_DATA,
        PDL_RTC_UPDATE_ALARM_TIME,
        PDL_NO_DATA,
        PDL_NO_DATA,
        (time + 0x10), /* Alarm in another 10 seconds */
        PDL_NO_DATA,
        PDL_NO_DATA, /* Error Adjust */
        PDL_NO_DATA, /* Capture */
        PDL_NO_DATA, /* Capture */
        PDL_NO_DATA, /* Capture */
        PDL_NO_DATA, /* Capture */
    );
}

```



```
        PDL_NO_DATA /* Periodic */
    );

    /* Enter into sleep mode? */
    if(true != bEnterSleepMode)
    {
        bEnterSleepMode = true;
    }
}

void SW1_handler(void)
{
    nop();
}
```

Figure 5-28: Example of using RTC is used and wake up from sleep mode

2) Wake up from deep standby mode

Figure 5-29 shows an example of using the RTC wake up from deep standby mode. The HOCO is used as system and and sub-clock as RTC count source.

```

#include <stdio.h>
#include <string.h>

/* PDL functions */
#include "r_pdl_cgc.h"
#include "r_pdl_lpc.h"
#include "r_pdl_intc.h"
#include "r_pdl_io_port.h"
#include "r_pdl_cmt.h"
#include "r_pdl_mcu.h"
#include "r_pdl_rtc.h"
#include "r_pdl_sci.h"

/* PDL device-specific definitions */
#include "r_pdl_definitions.h"

#define RSK_SCI_CHANNEL 0

static void SetClocks(void);
static void Alarm_handler(void);

volatile bool bDeepStdbyExit = false;
volatile bool bDeepStdbyEnter = false;

void main(void)
{
    uint32_t status_flags1;
    uint8_t status_flags2;
    uint16_t status=0;
    uint8_t flags;
    uint32_t time;
    uint32_t date;
    uint8_t buffer[50];

    /* Sets system clock */
    SetClocks();

    /* If this is us exiting from deep sleep */
    if (SYSTEM.RSTSR0.BIT.DPSRSTF == 1)
    {
        bDeepStdbyExit = true;
        SYSTEM.RSTSR0.BIT.DPSRSTF = 0;
    }

    /* Create async for debug output */
    R_SCI_Set(
        RSK_SCI_CHANNEL,
        PDL_SCI_PIN_SCI0_RXD0_P21 | PDL_SCI_PIN_SCI0_TXD0_P20
    );

    R_SCI_Create(
        RSK_SCI_CHANNEL,
        PDL_SCI_ASYNC,
        9600,
        1,
        0);

    /* Check warm/cold start flag (CWSF = 1):
    Call R_RTC_CreateWarm to start up the RTC if warm/cold start flag is detected
    (power ON from warm start) */

    /* Get Reset Status Flag */
    R_MCU_GetStatus(

```

```

    PDL_NO_PTR,
    &status,
    PDL_NO_PTR,
    PDL_NO_PTR
);

/* RSTSR1.CWSF : Warm start ? */
/* RTC is running ? */
if (((status & BIT_8) == (uint16_t)(BIT_8)) && ((RTC.RCR2.BIT.START) != 0))
{
    /* If warm-start is detected and RTC is running, then warm start */
    R_SCI_Send(RSK_SCI_CHANNEL, PDL_NO_DATA,
        "\r\nRTC Start in Warm start mode: Control to change time\r\n", 0, PDL_NO_FUNC);

    /* Warm wake up : Read time */
    R_RTC_Read(PDL_RTC_READ_CURRENT, &flags, &time, &date);

    sprintf((char*)buffer, "RTC Time before changing = %d%d:%d%d:%d%d \r\n",
        (int)(time & 0xF0000) >> 20,
        (int)(time & 0x0F0000) >> 16,
        (int)(time & 0x00F000) >> 12,
        (int)(time & 0x000F00) >> 8,
        (int)(time & 0x0000F0) >> 4,
        (int)(time & 0x00000F) >> 0);

    R_SCI_Send(RSK_SCI_CHANNEL, PDL_NO_DATA, buffer, 0, PDL_NO_FUNC);

    R_RTC_CreateWarm(
        Alarm_handler, /* Alarm handler */
        15, /* Alarm priority */
        PDL_NO_FUNC, /* Periodic Handler */
        PDL_NO_DATA /* Periodic priority */
    );

    R_RTC_Read(
        PDL_RTC_READ_CURRENT,
        PDL_NO_PTR,
        &time,
        &date
    );

    /* Configure the clock */
    R_RTC_Control(
        PDL_NO_DATA,
        PDL_RTC_UPDATE_ALARM_TIME,
        PDL_NO_DATA,
        PDL_NO_DATA,
        (time + 0x10), /* Alarm in another 10 seconds */
        PDL_NO_DATA,
        PDL_NO_DATA, /* Error Adjust */
        PDL_NO_DATA, /* Capture */
        PDL_NO_DATA, /* Capture */
        PDL_NO_DATA, /* Capture */
        PDL_NO_DATA /* Periodic */
    );
}
else
{
    /* If Cold-start is detected the RTC clock should be re-started */
    R_SCI_Send(RSK_SCI_CHANNEL, PDL_NO_DATA,
        "\r\nRTC Start in Cold start mode: Initailize RTC\r\n", 0, PDL_NO_FUNC);

    if (R_RTC_Create(
        PDL_RTC_ALARM_TIME_ENABLE | PDL_RTC_ALARM_DATE_ENABLE,
        PDL_NO_DATA,
        0xFF114250, /* Automatic day of week, 11:42:50 */
        0x20131118, /* 18-Nov-2013 */
        PDL_NO_DATA, /* Capture 0 */

```

```

        PDL_NO_DATA, /* Capture 1 */
        PDL_NO_DATA, /* Capture 2 */
        PDL_NO_DATA, /* Periodic */
        0xFF114300, /* Alarm in 10 seconds */
        0x20131118, /* 18-Nov-2013 */
        Alarm_handler,
        15,
        PDL_NO_FUNC,
        PDL_NO_DATA
    ) == false)
    {
        R_SCI_Send(RSK_SCI_CHANNEL, PDL_NO_DATA,
            "\r\nRTC_Create error in Cold start mode\r\n", 0, PDL_NO_FUNC);
        while(1);
    }

    /* After the complete initialization, Set the warm start indicator */
    R_MCU_Control(
        PDL_MCU_WARM_START
    );
}

/* Find out what caused the exit from deep software standby */
/* NOTE: THE E1 USES IRQ0-DS AND IRQ1-DS PINS AND THEREFORE THESE BITS WILL BE SET
IN status_flags1 IF USING THE E1. */
R_LPC_GetStatus(
    &status_flags1, &status_flags2
);

if(true == bDeepStdbyExit)
{
    /* This is us exiting from deep sleep */

    /* An interrupt has caused an exit from deep software standby mode, followed by
an internal reset */

    if(0 == (status_flags1 & BIT_23))
    {
        /* Flag should have been set. */
        while(1);
    }

    /* It is correct to be here if have just woken from deep sleep. */
    while(1)
    {
        /* Read time */
        R_RTC_Read(PDL_RTC_READ_CURRENT, &flags, &time, &date);

        sprintf((char*)buffer, "Time = %d%d:%d%d:%d%d \r\n",
            (int)(time & 0xF0000) >> 20,
            (int)(time & 0x0F000) >> 16,
            (int)(time & 0x00F00) >> 12,
            (int)(time & 0x000F0) >> 8,
            (int)(time & 0x0000F) >> 4,
            (int)(time & 0x00000F) >> 0);

        R_SCI_Send(
            RSK_SCI_CHANNEL,
            PDL_NO_DATA,
            buffer,
            0,
            PDL_NO_FUNC);
    }
}

/* This call should cancel the settings made in above call to R_LPC_Create */
/* Allow RTC interval interrupt signal wake us up from deep software standby. */

```

```

R_LPC_Create(
    PDL_LPC_HIGH_SPEED_MODE | PDL_LPC_IO_DELAY | PDL_LPC_EXT_BUS_HI_Z,
    PDL_NO_DATA,
    PDL_NO_DATA,
    PDL_LPC_CANCEL_RTCA_ENABLE,
    PDL_NO_DATA,
    PDL_NO_DATA,
    PDL_NO_DATA
);

R_RTC_Read(
    PDL_RTC_READ_CURRENT,
    PDL_NO_PTR,
    &time,
    &date
);

/* Enter deep standby mode after alarm in 10sec */
while (bDeepStdbyEnter == false);

/* Enter deep software standby mode. An internal reset will occur. */
if(false == R_LPC_Control(PDL_LPC_MODE_DEEP_SOFTWARE_STANDBY))
{
    while(1);
}

while(1);
}

static void SetClocks(void)
{
    /* Prepare the LOCO settings */
    R_CGC_Set(
        PDL_CGC_CLK_LOCO,
        PDL_CGC_BCLK_DISABLE | PDL_CGC_SDCLK_DISABLE | \
        PDL_CGC_RTC_SRC_SUB | PDL_CGC_SUB_CLOCK_CL_STANDARD,
        125E3,
        125E3,
        125E3,
        125E3,
        125E3,
        PDL_NO_DATA,
        PDL_NO_DATA,
        PDL_NO_DATA,
        PDL_NO_DATA
    );

    /* Configure the HOCO settings */
    R_CGC_Set(
        PDL_CGC_CLK_HOCO,
        PDL_CGC_BCLK_DISABLE | PDL_CGC_SDCLK_DISABLE,
        50E6,
        50E6,
        50E6,
        50E6,
        50E6,
        PDL_NO_DATA,
        PDL_NO_DATA,
        PDL_NO_DATA,
        PDL_NO_DATA
    );

    /* Sub-clock */
    R_CGC_Set(
        PDL_CGC_CLK_SUB_CLOCK,
        PDL_CGC_BCLK_DISABLE | PDL_CGC_SDCLK_DISABLE,
        32768, /* Frequency of selected clock source */
        (32768 / 1), /* Frequency of System clock (ICLK) */
    );
}

```

```

    (32768 / 1), /* Frequency of Peripheral A clock (PCLKA) */
    (32768 / 1), /* Frequency of Peripheral B clock (PCLKB) */
    (32768 / 1), /* Frequency of Flash memory clock (FCLK) */
    PDL_NO_DATA, /* Frequency of External bus clock */
    PDL_NO_DATA, /* Frequency of IEBUS */
    PDL_NO_DATA, /* Frequency of USB clock */
    PDL_CGC_SUB_65536 /* Sub-clock stabilization time */
);

/* Wait for the Subclock stabilisation time (2 seconds minimum) */
/* NOTE: As currently running from the LOCO the R_CMT_CreateOneShot
max time limit is > 2 Secs. */
R_CMT_CreateOneShot(
    0,
    PDL_NO_DATA,
    2.0,
    PDL_NO_FUNC,
    0
);

/* Select the HOCO as the clock source */
R_CGC_Control(
    PDL_CGC_CLK_HOCO,
    PDL_NO_DATA,
    PDL_CGC_RTC_TO_BE_USED
);
}

void Alarm_handler(void)
{
    uint8_t flags;
    uint32_t time;
    uint32_t date;
    uint8_t buffer[50];

    /* Read time */
    R_RTC_Read(PDL_RTC_READ_CURRENT, &flags, &time, &date);

    sprintf((char*)buffer, "Time = %d:%d:%d \r\n",
        (int)(time & 0xF0000) >> 20,
        (int)(time & 0x0F000) >> 16,
        (int)(time & 0x00F00) >> 12,
        (int)(time & 0x000F0) >> 8,
        (int)(time & 0x0000F) >> 4,
        (int)(time & 0x00000F) >> 0);

    R_SCI_Send(RSK_SCI_CHANNEL, PDL_NO_DATA, buffer, 0, PDL_NO_FUNC);

    /* Configure the clock */
    R_RTC_Control(
        PDL_NO_DATA,
        PDL_RTC_UPDATE_ALARM_TIME,
        PDL_NO_DATA,
        PDL_NO_DATA,
        (time+0x10), /* Alarm in another 10 seconds */
        PDL_NO_DATA,
        PDL_NO_DATA, /* Error Adjust */
        PDL_NO_DATA, /* Capture */
        PDL_NO_DATA, /* Capture */
        PDL_NO_DATA, /* Capture */
        PDL_NO_DATA /* Periodic */
    );

    /* Enter deep standby mode ? */
    if(true != bDeepStdbyEnter)
    {
        bDeepStdbyEnter = true;
    }
}

```

```
}  
  
}
```

Figure 5-29: Example of using RTC is used and wake up from deep standby mode

3) With Vbatt mode

Figure 5-30 shows an example of using the RTC with Vbatt mode. The sub clock is used as system and RTC count source.

```
#include <stdio.h>
#include <string.h>

/* PDL functions */
#include "r_pdl_cgc.h"
#include "r_pdl_cmt.h"
#include "r_pdl_mcu.h"
#include "r_pdl_rtc.h"
#include "r_pdl_sci.h"
#include "r_pdl_mcu_ofs.h"

/* PDL device-specific definitions */
#include "r_pdl_definitions.h"

R_MCU_OFS(PDL_MCU_OFS_IWDT_HALTED,
PDL_MCU_OFS_WDT_HALTED,
PDL_MCU_OFS_LVD_0_ENABLE,
PDL_MCU_OFS_CGC_HOCO_DISABLE
);
#define RSK_SCI_CHANNEL 0

static void SetClocks(void);

void main(void)
{
    uint8_t flags;
    uint32_t time;
    uint32_t time_previous = 0;
    uint32_t date;
    uint8_t buffer[50];
    static uint16_t status=0;

    SetClocks();

    /* Set LED1 (P05) as output port */
    PORT0.PDR.BIT.B5 = 1;

    /* Create async for debug output */
    R_SCI_Set(
        RSK_SCI_CHANNEL,
        PDL_SCI_PIN_SCI0_RXD0_P21 | PDL_SCI_PIN_SCI0_TXD0_P20
    );

    R_SCI_Create(
        RSK_SCI_CHANNEL,
        PDL_SCI_ASYNC,
        9600,
        1,
        0);

    R_SCI_Send(RSK_SCI_CHANNEL, PDL_NO_DATA,
        "\r\nRTC ready\r\n", 0, PDL_NO_FUNC);

    /* Get Reset Status Flag */
    R_MCU_GetStatus(
        PDL_NO_PTR,
        &status,
        PDL_NO_PTR,
        PDL_NO_PTR
    );

    /* Check Voltage-Monitoring 0 Reset Detect Flag:
    Do not call R_RTC_Create again if LVD0 reset is detected
    (recovering from Vbatt mode) */
```



```

if ((status & BIT_1) == 0)
{
    R_SCI_Send(RSK_SCI_CHANNEL, PDL_NO_DATA,
        "\r\nVcc voltage drop not detected!\r\n", 0, PDL_NO_FUNC);

    /* Then Cold-start */
    if (R_RTC_Create(
        PDL_NO_DATA,
        PDL_NO_DATA, /* Pin settings */
        0xFF163350, /* Automatic day of week, 16:33:50 */
        0x20110518, /* 18-May-2011 */
        PDL_NO_DATA, /* Capture 0 */
        PDL_NO_DATA, /* Capture 1 */
        PDL_NO_DATA, /* Capture 2 */
        PDL_NO_DATA, /* Periodic */
        PDL_NO_DATA, /* Alarm */
        PDL_NO_DATA, /* Alarm date */
        PDL_NO_FUNC, /* Alarm handler */
        PDL_NO_DATA, /* Alarm priority */
        PDL_NO_FUNC, /* Periodic Handler */
        PDL_NO_DATA /* Periodic priority */
    ) == false)
    {
        while (1);
    }

    /* After complete initialization, Set the warm start indicator */
    R_MCU_Control(
        PDL_MCU_WARM_START
    );
}
else
{
    R_SCI_Send(RSK_SCI_CHANNEL, PDL_NO_DATA,
        "\r\nVcc voltage drop detected!\r\n", 0, PDL_NO_FUNC);

    /* RSTSRL.CWSF : Warm start ? */
    /* RTC is running ? */
    if (((status & BIT_8) == (uint16_t)(BIT_8)) && ((RTC.RCR2.BIT.START) != 0))
    {
        /* If warm-start is detected and RTC is running, then warm start */

        R_SCI_Send(RSK_SCI_CHANNEL, PDL_NO_DATA,
            "\r\nVcc voltage drop and cold warm up!\r\n", 0, PDL_NO_FUNC);

        R_RTC_CreateWarm(
            PDL_NO_FUNC, /* Alarm handler */
            PDL_NO_DATA, /* Alarm priority */
            PDL_NO_FUNC, /* Periodic Handler */
            PDL_NO_DATA /* Periodic priority */
        );
    }
    else
    {
        /* If Cold-start is also detected or warm-startup but RTC is stopped */
        /* the RTC clock should be re-started */
        R_SCI_Send(RSK_SCI_CHANNEL, PDL_NO_DATA,
            "\r\nVcc voltage drop and cold start up!\r\n", 0, PDL_NO_FUNC);

        R_RTC_Create(
            PDL_NO_DATA,
            PDL_NO_DATA, /* Pin settings */
            0xFF163350, /* Automatic day of week, 16:33:50 */
            0x20110518, /* 18-May-2011 */
            PDL_NO_DATA, /* Capture 0 */
            PDL_NO_DATA, /* Capture 1 */
            PDL_NO_DATA, /* Capture 2 */

```

```

        PDL_NO_DATA, /* Periodic */
        PDL_NO_DATA, /* Alarm */
        PDL_NO_DATA, /* Alarm date */
        PDL_NO_FUNC, /* Alarm handler */
        PDL_NO_DATA, /* Alarm priority */
        PDL_NO_FUNC, /* Periodic Handler */
        PDL_NO_DATA /* Periodic priority */
    );
}
}

while (1)
{
    /* Read time */
    R_RTC_Read(
        PDL_RTC_READ_CURRENT,
        &flags,
        &time,
        &date);

    /* If no carry error output the time */
    if (0 == (flags & BIT_6))
    {
        /* Has time changed */
        if ((time & 0xFFFFF) != (time_previous & 0xFFFFF))
        {
            time_previous = time;

            sprintf((char*)buffer, "Time = %d%d:%d%d:%d%d \r\n",
                (int)(time & 0xF0000) >> 20,
                (int)(time & 0x0F000) >> 16,
                (int)(time & 0x00F00) >> 12,
                (int)(time & 0x000F0) >> 8,
                (int)(time & 0x0000F) >> 4,
                (int)(time & 0x00000F) >> 0);

            R_SCI_Send(
                RSK_SCI_CHANNEL,
                PDL_NO_DATA,
                buffer,
                0,
                PDL_NO_FUNC);
        }
    }
}

static void SetClocks(void)
{
    /* Prepare the LOCO settings */
    R_CGC_Set(
        PDL_CGC_CLK_LOCO,
        PDL_CGC_BCLK_DISABLE | PDL_CGC_SDCLK_DISABLE | \
        PDL_CGC_RTC_SRC_SUB | PDL_CGC_SUB_CLOCK_CL_STANDARD,
        125E3,
        125E3,
        125E3,
        125E3,
        125E3,
        PDL_NO_DATA,
        PDL_NO_DATA,
        PDL_NO_DATA,
        PDL_NO_DATA
    );

    /* Sub-clock */

```

```
R_CGC_Set(  
    PDL_CGC_CLK_SUB_CLOCK,  
    PDL_CGC_BCLK_DISABLE | PDL_CGC_SDCLK_DISABLE,  
    32768,  
    32768,  
    32768,  
    32768, /* PCLKB clock >= the frequency of the count source clock */  
    32768,  
    PDL_NO_DATA,  
    PDL_NO_DATA,  
    PDL_NO_DATA,  
    PDL_CGC_SUB_32768 /* SUB clock oscillator waiting time */  
);  
  
/* Wait for the Subclock stabilisation time (2 seconds minimum) */  
/* NOTE: As currently running from the LOCO the R_CMT_CreateOneShot  
max time limit is > 2 Secs. */  
R_CMT_CreateOneShot(  
    0,  
    PDL_NO_DATA,  
    2.0,  
    PDL_NO_FUNC,  
    0  
);  
  
/* Select the sub-clock as the clock source */  
R_CGC_Control(  
    PDL_CGC_CLK_SUB_CLOCK,  
    PDL_NO_DATA,  
    PDL_CGC_RTC_TO_BE_USED  
);  
}
```

Figure 5-30: Example of using the RTC is used with Vbatt mode

5.16. Independent Watchdog Timer

Figure 5-31 shows an example of Independent Watchdog timer usage.

At start-up the underflow is checked to identify if the reset was caused by the Independent Watchdog timer. The watchdog timer is then configured for a 1024-count timeout period and started. Because the watchdog timer is not refreshed, after two seconds (this depends on the frequency of the on-chip oscillator) the MCU is reset and the underflow condition is detected.

```

/* Peripheral driver function prototypes */
#include "r_pdl_iwdt.h"
#include "r_pdl_cgc.h"

/* PDL device-specific definitions */
#include "r_pdl_definitions.h"

void main(void)
{
    uint16_t Status;
    /* Initialise the system clocks */
    NOTE: The code to initialise the system clock using R_CGC_Set is omitted here.
    Please refer to 5.1 Clock Generation Circuit.
    /* Configure the IWDTLOCO settings */
    R_CGC_Set(
        PDL_CGC_CLK_IWDTLOCO,
        125E3,
        PDL_NO_DATA,
        PDL_NO_DATA,
        PDL_NO_DATA,
        PDL_NO_DATA,
        PDL_NO_DATA,
        PDL_NO_DATA,
        PDL_NO_DATA,
        PDL_NO_DATA,
        PDL_NO_DATA
    );

    /* Read the timer status */
    R_IWDT_Read(
        &Status
    );

    /* Has an underflow occurred? */
    if ((Status & BIT_14) != 0x0u)
    {
        /* Handle the watchdog-induced reset here */
    }

    /* Configure the IWDT */
    R_IWDT_Set(
        PDL_IWDT_TIMEOUT_1024 | PDL_IWDT_CLOCK_OCO_256
    );

    /* Start the IWDT */
    R_IWDT_Control(
        PDL_IWDT_REFRESH
    );

    while(1)
    {
        /* Read the timer status */
        R_IWDT_Read(
            &Status
        );
    }
}

```

Figure 5-31: Example of Independent Watchdog Timer use

5.17. Serial Communication Interface

5.17.1. SCI Asynchronous Using Polling.

This shows the setting of SCI channel 0 and the transmission and reception of data using polling.

```

/* Peripheral driver function prototypes */
#include "r_pdl_sci.h"
#include "r_pdl_cgc.h"

/* RPD_L device-specific definitions */
#include "r_pdl_definitions.h"

void main(void)
{
    volatile uint8_t rx_buffer[5];

    /* Initialise the system clocks */
    NOTE: The code to initialise the system clock using R_CGC_Set is omitted here.
    Please refer to 5.1 Clock Generation Circuit.

    /* Select the PLL as the clock source */
    R_CGC_Control(
        PDL_CGC_CLK_PLL,
        PDL_NO_DATA,
        PDL_NO_DATA
    );

    /* Set pin options */
    R_SCI_Set(
        0,
        PDL_SCI_PIN_SCI0_RXD0_P21 | PDL_SCI_PIN_SCI0_TXD0_P20
    );

    /* Set up SCI channel 0: Async, 8N1, 38400 baud */
    R_SCI_Create(
        0,
        PDL_SCI_ASYNC | PDL_SCI_8N1,
        38400,
        1,
        0
    );

    /* Wait while send message */
    R_SCI_Send(
        0,
        PDL_NO_DATA,
        "\r\nHello. Type 5 characters and I will echo them back.\r\n",
        0,
        PDL_NO_FUNC
    );

    /* Wait for 5 characters to be read. */
    R_SCI_Receive(
        0,
        PDL_NO_DATA,
        rx_buffer,
        5,
        PDL_NO_FUNC,
        PDL_NO_FUNC
    );

    /* Echo the 5 characters back. */
    R_SCI_Send(
        0,
        PDL_NO_DATA,
        rx_buffer,
        5,

```

```
        PDL_NO_FUNC  
    );  
}
```

Figure 5-32: Example of SCI asynchronous operation using polling.

5.17.2. SCI Asynchronous Using Interrupts.

This shows the setting of SCI channel 0 and the transmission and reception of data using interrupts.

```

/* Peripheral driver function prototypes */
#include "r_pdl_sci.h"
#include "r_pdl_cgc.h"

/* RPD_L device-specific definitions */
#include "r_pdl_definitions.h"

void SCIRx(void);
void SCITx(void);

volatile bool data_received;
volatile bool data_sent;

void main(void)
{
    volatile uint8_t rx_buffer[5];

    /* Initialise the system clocks */
    NOTE: The code to initialise the system clock using R_CGC_Set is omitted here.
    Please refer to 5.1 Clock Generation Circuit.

    /* Select the PLL as the clock source */
    R_CGC_Control(
        PDL_CGC_CLK_PLL,
        PDL_NO_DATA,
        PDL_NO_DATA
    );

    /* Initialise flags */
    data_sent = false;
    data_received = false;

    /* Set pin options */
    R_SCI_Set(
        0,
        PDL_SCI_PIN_SCI0_RXD0_P21 | PDL_SCI_PIN_SCI0_TXD0_P20
    );

    /* Set up SCI channel 0: Async, 8N1, 38400 baud */
    R_SCI_Create(
        0,
        PDL_SCI_ASYNC | PDL_SCI_8N1,
        38400,
        1,
        0
    );

    /* Send message - register callback to say when sent */
    R_SCI_Send(
        0,
        PDL_NO_DATA,
        "\r\nHello. Type 5 characters and I will echo them back.\r\n",
        0,
        SCITx
    );

    /* Wait for message to be sent */
    while(false == data_sent);

    /* Start a pending read of 5 characters */
    R_SCI_Receive(
        0,
        PDL_NO_DATA,
        rx_buffer,
        5,

```

```
        SCIrxd,
        PDL_NO_FUNC
    );

    /* Wait for characters to be received */
    while(false == data_received);

    /* Echo the 5 characters back. */
    R_SCI_Send(
        0,
        PDL_NO_DATA,
        rx_buffer,
        5,
        PDL_NO_FUNC
    );
}

/* Callback function for Rx */
void SCIrxd(void)
{
    data_received = true;
}

/* Callback function for Tx */
void SCITxd(void)
{
    data_sent = true;
}
```

Figure 5-33: Example of SCI Asynchronous operation using interrupts.

5.17.3. SCI Asynchronous Using DMAC.

This shows the setting of SCI channel 0 and transmission of data using the DMAC.

```

/* Peripheral driver function prototypes */
#include "r_pdl_sci.h"
#include "r_pdl_cgc.h"
#include "r_pdl_dmac.h"
/* RPD_L device-specific definitions */
#include "r_pdl_definitions.h"

#include <stddef.h>
#include <string.h>

const uint8_t* string = "Hello from Renesas RX63N SCI DMAC\r\n";

void main(void)
{
    uint8_t SCI_status;

    /* Initialise the system clocks */
    NOTE: The code to initialise the system clock using R_CGC_Set is omitted here.
    Please refer to 5.1 Clock Generation Circuit.

    /* Set up SCIO : Async, 8N1, 19200 baud */
    R_SCI_Create
    (
        0,
        PDL_SCI_ASYNC | PDL_SCI_8N1,
        19200,
        1,
        0
    );

    /* Configure channel 3 of DMAC to be triggered by SCIO Tx */
    R_DMAC_Create(
        3,
        PDL_DMAC_REPEAT | PDL_DMAC_SOURCE_ADDRESS_PLUS |
        PDL_DMAC_DESTINATION_ADDRESS_FIXED | PDL_DMAC_SIZE_8,
        PDL_DMAC_TRIGGER_SCI0_TX,
        string, /* Source */
        (const char *)&SCIO.TDR, /* Destination */
        1,
        (uint16_t)strlen((char *)string),
        PDL_NO_DATA,
        PDL_NO_DATA,
        PDL_NO_DATA,
        PDL_NO_FUNC,
        0
    );

    /* Enable DMAC */
    R_DMAC_Control
    (
        3,
        PDL_DMAC_ENABLE,
        PDL_NO_PTR,
        PDL_NO_PTR,
        PDL_NO_DATA,
        PDL_NO_DATA,
        PDL_NO_DATA,
        PDL_NO_DATA,
        PDL_NO_DATA,
        PDL_NO_DATA
    );

    /* Start transmission */
    R_SCI_Send
    (
        0,

```

```

    PDL_SCI_DMACH_TRIGGER_ENABLE,
    PDL_NO_PTR, PDL_NO_DATA, /* No data as using DMAC */
    PDL_NO_FUNC
);

/*****
IMPORTANT: The SCI module does not know when the DMAC has finished,
therefore we must tell it using the R_SCI_Control function.
*****/

/* Wait for the SCI transmission to end */
do
{
    R_SCI_GetStatus
    (
        0,
        &SCI_status,
        PDL_NO_PTR,
        PDL_NO_PTR,
        PDL_NO_PTR
    );
    /* While the 'Transmit status' (BIT_2) is not reporting idle. */
}while ((SCI_status & 0x04) == 0);

/* Stop the SCI */
R_SCI_Control
(
    0,
    PDL_SCI_STOP_TX
);
}

```

Figure 5-34: Example of SCI Asynchronous operation using DMAC.

5.17.4. Synchronous Transmission and Reception

This shows the configuration of SCI channel 0 as the clock master and channel 2 as the slave.

The master transmits data to the slave.

The slave receive function call uses interrupts to call a callback function on completion.

```

/* Peripheral driver function prototypes */
#include "r_pdl_sci.h"
#include "r_pdl_cgc.h"
#include "r_pdl_intc.h"

/* RPDL device-specific definitions */
#include "r_pdl_definitions.h"

/* SCI channel selection */
#define MASTER_CHANNEL 0
#define SLAVE_CHANNEL 2

/* Rx complete flag */
volatile uint8_t data_received;

/* Callback function prototype */
static void SCI9RxFunc(void);

void main(void)
{
    volatile uint8_t rx_buffer[5];

    /* Initialise the system clocks */
    NOTE: The code to initialise the system clock using R_CGC_Set is omitted here.
    Please refer to 5.1 Clock Generation Circuit.

    /* Select the PLL as the clock source */
    R_CGC_Control(
        PDL_CGC_CLK_PLL,
        PDL_NO_DATA,
        PDL_NO_DATA
    );

    /* Set pin options */
    R_SCI_Set(
        0,
        PDL_SCI_PIN_SCI0_TXD0_P20 | PDL_SCI_PIN_SCI0_SCK0_P22
    );

    R_SCI_Set(
        2,
        PDL_SCI_PIN_SCI2_RXD2_P52 | PDL_SCI_PIN_SCI2_SCK2_P51
    );

    /* Create Master Channel */
    R_SCI_Create(
        MASTER_CHANNEL,
        PDL_SCI_SYNC | PDL_SCI_RX_DISCONNECTED |
        PDL_SCI_CLK_INT_OUT,
        19200,
        1,
        0
    );

    /* Create Channel slave */
    /* NOTE: Even though using an external clock the driver needs to know
    the expected baud rate (Bit 31 is set to signify not generating baud) */
    R_SCI_Create(
        SLAVE_CHANNEL,
        PDL_SCI_SYNC | PDL_SCI_TX_DISCONNECTED |
        PDL_SCI_CLK_EXT,
        0x80000000 | 19200,

```

```
        1,  
        0  
    );  
  
    /* Set flag to wait on */  
    data_received = false;  
  
    /* Setup a read on channel slave */  
    R_SCI_Receive(  
        SLAVE_CHANNEL,  
        PDL_NO_DATA,  
        rx_buffer,  
        5,  
        SCI9RxFunc,  
        PDL_NO_FUNC  
    );  
  
    /* Send the data from the master */  
    R_SCI_Send(  
        MASTER_CHANNEL,  
        PDL_NO_DATA,  
        "12345",  
        5,  
        PDL_NO_FUNC  
    );  
  
    /* Wait for channel slave to receive */  
    while(data_received == false);  
  
    /* Process the received data here */  
}  
  
/* SCI channel 9 receive complete handler */  
static void SCI9RxFunc(void)  
{  
    /* Set flag */  
    data_received = true;  
}
```

Figure 5-35: Example of Synchronous Transmission and Reception code

5.17.5. Synchronous Full Duplex Operation

This shows the configuration of SCI channel 0 as a clock master with both Rx and Tx data pins enabled. Data is received at the same time as data is transmitted.

```

/* Peripheral driver function prototypes */
#include "r_pdl_sci.h"
#include "r_pdl_cgc.h"
#include "r_pdl_intc.h"

/* RPD_L device-specific definitions */
#include "r_pdl_definitions.h"

/* SCI channel selection */
#define MASTER_CHANNEL 0

#define DATA_LENGTH 5

/* Rx complete flag */
volatile uint8_t data_received;

/* Callback function prototype */
static void SCI_Rx_Callback(void);

void main(void)
{
    volatile uint8_t rx_buffer[5];

    /* Initialise the system clocks */
    NOTE: The code to initialise the system clock using R_CGC_Set is omitted here.
    Please refer to 5.1 Clock Generation Circuit.

    /* Select the PLL as the clock source */
    R_CGC_Control(
        PDL_CGC_CLK_PLL,
        PDL_NO_DATA,
        PDL_NO_DATA
    );

    /* Set Master (Channel 0) pin options */
    R_SCI_Set(
        0,
        PDL_SCI_PIN_SCI0_RXD0_P21 |
        PDL_SCI_PIN_SCI0_TXD0_P20 |
        PDL_SCI_PIN_SCI0_SCK0_P22
    );

    /* Create Clock Master channel for Rx and Tx */
    R_SCI_Create(
        MASTER_CHANNEL,
        PDL_SCI_SYNC | PDL_SCI_CLK_INT_OUT |
        PDL_SCI_TX_CONNECTED | PDL_SCI_RX_CONNECTED,
        19200,
        1,
        0
    );

    /* Set flag to wait on */
    data_received = false;

    /* Setup master to receive. (Non polling)
    NOTE: No clocks pulses will be generated until R_SCI_Send is called. */
    R_SCI_Receive(
        MASTER_CHANNEL,
        PDL_NO_DATA,
        rx_buffer,
        DATA_LENGTH,

```

```
        SCI_Rx_Callback,  
        PDL_NO_FUNC  
    );  
  
    /* Dummy send so the Slave Tx and Master Rx will happen. */  
    R_SCI_Send(  
        MASTER_CHANNEL,  
        PDL_NO_DATA,  
        "Dummy",  
        DATA_LENGTH,  
        PDL_NO_FUNC  
    );  
  
    /* Wait for Rx to finish */  
    while(data_received == false);  
  
    /* Process the received data here */  
    while(1);  
}  
  
/* Callback function for Rx */  
static void SCI_Rx_Callback(void)  
{  
    data_received = true;  
}
```

Figure 5-36: Example of Synchronous Full Duplex operation

5.17.6. SCI Reception in Asynchronous Multi-Processor mode

This shows the setting of SCI channel 9 and the Multi-Processor mode reception of data using interrupts and polling.

```

/* PDL functions */
#include "r_pdl_sci.h"
#include "r_pdl_cgc.h"
#include "r_pdl_io_port.h"

/* PDL device-specific definitions */
#include "r_pdl_definitions.h"

void SCIRx(void);
void SCIEr(void);

#define NUM_DATA 50
volatile uint8_t data_received;
volatile uint8_t error_happen;
volatile uint8_t receive_data[NUM_DATA];

void main(void)
{
    uint8_t i;
    bool id_received;

    /* Initialise the system clocks */
    NOTE: The code to initialise the system clock using R_CGC_Set is omitted here.
    Please refer to 5.1 Clock Generation Circuit.

    /* Select the PLL as the clock source */
    R_CGC_Control(
        PDL_CGC_CLK_PLL,
        PDL_NO_DATA,
        PDL_NO_DATA
    );

    for (i=0; i<NUM_DATA; i++)
    {
        receive_data[i] = 0;
    }

    /* Set pin options */
    R_SCI_Set(
        9,
        PDL_SCI_PIN_SCI9_TXD9_PB7 | PDL_SCI_PIN_SCI9_RXD9_PB6
    );

    /* Configure the RS232 port, specify Async MP mode */
    R_SCI_Create(
        9,
        PDL_SCI_8N1 | PDL_SCI_ASYNC_MP,
        57600,
        15,
        0
    );

    /* ----- */
    /* Async MP mode, data Reception, by CPU ISR */
    /* ----- */

    data_received = false;
    error_happen = false;

    /* Wait by CPU ISR, until receive matching Station ID (0x0A) */
    R_SCI_Receive(
        9,
        0x0A00 | PDL_SCI_MP_ID_CYCLE,
        PDL_NO_PTR,

```

```

        0,
        SCIr,
        SCIEr
    );

    while (data_received == false);

    data_received = false;

    /* Receive data (ID = 0x0A) by CPU ISR */
    R_SCI_Receive(
        9,
        PDL_NO_DATA,
        receive_data,
        10,
        SCIr,
        SCIEr
    );

    while (data_received == false);

    /* ----- */
    /* Async MP mode, data Reception, by polling */
    /* ----- */
    id_received = false;

    /* Wait by polling, until receive matching Station ID (0x01) */
    id_received = R_SCI_Receive(
        9,
        0x0100 | PDL_SCI_MP_ID_CYCLE,
        PDL_NO_PTR,
        0,
        PDL_NO_FUNC,
        SCIEr
    );

    if (id_received == true)
    {
        /* Receive data (ID = 0x01) by polling */
        R_SCI_Receive(
            9,
            PDL_NO_DATA,
            receive_data,
            10,
            PDL_NO_FUNC,
            SCIEr
        );
    }
}

void SCIr(void)
{
    data_received = true;
}

void SCIEr(void)
{
    error_happen = true;
}

```

Figure 5-37: Example of SCI Reception code in Asynchronous Multi-Processor mode

5.17.7. SCI Transmission in Asynchronous Multi-Processor mode

This shows the setting of SCI channel 9 and the Multi-Processor mode transmission of data using interrupts and polling.

```

/* PDL functions */
#include "r_pdl_sci.h"
#include "r_pdl_cgc.h"

/* PDL device-specific definitions */
#include "r_pdl_definitions.h"

void SCItx(void);

uint8_t* send_data0 = "\n\rWelcome to the Renesas RX63N.\n\r";
uint8_t* send_data = "testing ASYNC MP mode";
bool tx_end;

void main(void)
{
    /* Initialise the system clocks */
    NOTE: The code to initialise the system clock using R_CGC_Set is omitted here.
    Please refer to 5.1 Clock Generation Circuit.

    /* Select the PLL as the clock source */
    R_CGC_Control(
        PDL_CGC_CLK_PLL,
        PDL_NO_DATA,
        PDL_NO_DATA
    );

    /* Set pin options */
    R_SCI_Set(
        9,
        PDL_SCI_PIN_SCI9_TXD9_PB7 | PDL_SCI_PIN_SCI9_RXD9_PB6
    );

    /* Configure the RS232 port, specify Async MP mode */
    R_SCI_Create(
        9,
        PDL_SCI_8N1 | PDL_SCI_ASYNC_MP,
        57600,
        15,
        0
    );

    /* ----- */
    /* Async MP mode, data Transmission, by CPU ISR */
    /* ----- */

    NOTE: The receiving side must be ready before this ID is transmitted.

    /* Send Target Station ID (0x0A), by internal polling */
    R_SCI_Send(
        9,
        0x0A00 | PDL_SCI_MP_ID_CYCLE,
        PDL_NO_PTR,
        0,
        PDL_NO_FUNC
    );

    tx_end = false;

    /* Send data to Target Station (ID = 0x0A), using interrupts */
    R_SCI_Send(
        9,
        PDL_NO_DATA,
        send_data0,
        0,
        SCItx

```

```
);

while(tx_end == false);

/* ----- */
/* Async MP mode, data Transmission, by polling */
/* ----- */

NOTE: The receiving side must be ready before this ID is transmitted.

/* Send Target Station ID (0x01) by internal polling */
R_SCI_Send(
    9,
    0x0100 | PDL_SCI_MP_ID_CYCLE,
    PDL_NO_PTR,
    0,
    PDL_NO_FUNC
);

/* Send data to Target Station (ID = 0x01), by polling */
R_SCI_Send(
    9,
    PDL_NO_DATA,
    send_data,
    0,
    PDL_NO_FUNC
);
}

void SCITx(void)
{
    tx_end = true;
}
```

Figure 5-38: Example of SCI Transmission code in Asynchronous Multi-Processor mode

5.17.8. SCI in SPI Mode

This shows the setting of SCI channel 6 in to SPI master mode and the transmission of data using interrupts.

```

/* PDL functions */
#include "r_pdl_sci.h"
#include "r_pdl_cgc.h"
/* PDL device-specific definitions */
#include "r_pdl_definitions.h"

static void SCItx(void);
volatile bool data_sent = false;

void main(void)
{
    /* Initialise the system clocks */
    NOTE: The code to initialise the system clock using R_CGC_Set is omitted here.
    Please refer to 5.1 Clock Generation Circuit.

    R_CGC_Control(
        PDL_CGC_CLK_PLL,
        PDL_NO_DATA,
        PDL_NO_DATA
    );

    /* Set Channel 6 pin options */
    R_SCI_Set(
        6,
        PDL_SCI_PIN_SCI6_SMISO6_P01 | PDL_SCI_PIN_SCI6_SMOSI6_P00 | \
        PDL_SCI_PIN_SCI6_SCK6_P02 | PDL_SCI_PIN_SCI6_SS6_PB2
    );

    /* Create SPI master */
    R_SCI_Create(
        6,
        PDL_SCI_SYNC |
        PDL_SCI_SPI_MODE |
        PDL_SCI_RX_DISCONNECTED |
        PDL_SCI_CLK_INT_OUT,
        19200,
        1,
        0
    );

    /* Start sending data */
    R_SCI_SPI_Transfer(
        6,
        PDL_NO_DATA,
        5,
        "12345",
        SCItx,
        PDL_NO_DATA,
        PDL_NO_FUNC,
        PDL_NO_FUNC
    );

    /* Wait for data to be sent */
    while(data_sent == false);

    /* Close this channel */
    R_SCI_Destroy(6);
}

static void SCItx(void)
{
    data_sent = true;
}

```

Figure 5-39: Example of SCI in SPI mode

5.17.9. SCI in IIC Mode

This shows the setting of SCI channel 2 in to IIC mode and then a write and read to an IIC EEPROM.

```

/* PDL functions */
#include "r_pdl_sci.h"
#include "r_pdl_cgc.h"
#include "r_pdl_cmt.h"

/* PDL device-specific definitions */
#include "r_pdl_definitions.h"

/* SCI IIC Channel */
#define CHANNEL_SCI_IIC 2
/* IIC Slave address of EEPROM */
#define SLAVE_ADDRESS 0xA0
/* Address in EEPROM where we will write a byte */
#define EEPROM_ADDRESS 0x01
/* Value to be written to the EEPROM */
#define EEPROM_VALUE 0xAA

void main(void)
{
    /* Data Buffer */
    volatile uint8_t IIC_Buffer[10];

    /* Initialise the system clocks */
    NOTE: The code to initialise the system clock using R_CGC_Set is omitted here.
    Please refer to 5.1 Clock Generation Circuit.

    /* Select the PLL as the clock source */
    R_CGC_Control(
        PDL_CGC_CLK_PLL,
        PDL_NO_DATA,
        PDL_NO_DATA
    );

    /* Set Channel 2 pin options */
    R_SCI_Set(
        2,
        PDL_SCI_PIN_SCI2_SSCL2_P12 | PDL_SCI_PIN_SCI2_SSDA2_P13
    );

    /* Configure the SCI IIC Channel */
    R_SCI_Create(
        CHANNEL_SCI_IIC,
        PDL_SCI_SYNC |
        PDL_SCI_IIC_MODE |
        PDL_SCI_IIC_DELAY_SDA_20_21,
        9600,
        1,
        0
    );

    /* Set up data buffer for the write. */
    /* Address in EEPROM */
    IIC_Buffer[0] = EEPROM_ADDRESS;
    /* Data to write */
    IIC_Buffer[1] = EEPROM_VALUE;

    /* IIC write */
    R_SCI_IIC_Write(
        CHANNEL_SCI_IIC,
        PDL_NO_DATA,
        SLAVE_ADDRESS,
        2,
        IIC_Buffer,
        PDL_NO_FUNC
    );
};

```

```
/* Wait for 5ms while the EEPROM updates */
R_CMT_CreateOneShot(
    0,
    0,
    5E-3,
    PDL_NO_FUNC,
    0
);

/* Confirm this write worked by reading back the data from the EEPROM. */
/* 1. Set current EEPROM address */
IIC_Buffer[0] = EEPROM_ADDRESS;
R_SCI_IIC_Write(
    CHANNEL_SCI_IIC,
    PDL_NO_DATA,
    SLAVE_ADDRESS,
    1,
    IIC_Buffer,
    PDL_NO_FUNC
);

/* 2. Read data from current address */
R_SCI_IIC_Read(
    CHANNEL_SCI_IIC,
    PDL_NO_DATA,
    SLAVE_ADDRESS,
    1,
    IIC_Buffer,
    PDL_NO_FUNC
);

/* Confirm the value written is the same as the value read */
if(IIC_Buffer[0] != EEPROM_VALUE)
{
    /* User Handle Error */
}
}
```

Figure 5-40: Example of SCI in IIC mode

5.17.10. SCI in IIC Mode using DMAC

This shows the setting of SCI channel 2 in to IIC mode and then a write to an IIC EEPROM using the DMAC.

```

/* PDL functions */
#include "r_pdl_sci.h"
#include "r_pdl_cgc.h"
#include "r_pdl_dmac.h"

/* PDL device-specific definitions */
#include "r_pdl_definitions.h"

static void Callback(void);

/* SCI IIC Channel */
#define CHANNEL_SCI_IIC 2
/* IIC Slave address of EEPROM */
#define SLAVE_ADDRESS 0xA0
/* Address in EEPROM where we will write a byte */
#define EEPROM_ADDRESS 0x01

volatile bool data_sent = false;

void main(void)
{
    /* Data Buffer */
    volatile uint8_t IIC_Buffer[10];

    /* Initialise the system clocks */
    NOTE: The code to initialise the system clock using R_CGC_Set is omitted here.
    Please refer to 5.1 Clock Generation Circuit.

    /* Set Channel 2 pin options */
    R_SCI_Set(
        2,
        PDL_SCI_PIN_SCI2_SSCL2_P12 | PDL_SCI_PIN_SCI2_SSDA2_P13
    );

    /* Configure the SCI IIC Channel */
    R_SCI_Create(
        CHANNEL_SCI_IIC,
        PDL_SCI_SYNC |
        PDL_SCI_IIC_MODE |
        PDL_SCI_IIC_DELAY_SDA_20_21,
        9600,
        1,
        0
    );

    /* Setup data to write to EEPROM */
    /* Address in EEPROM */
    IIC_Buffer[0] = EEPROM_ADDRESS;
    /* Data to store in EEPROM */
    IIC_Buffer[1] = 1;
    IIC_Buffer[2] = 2;
    IIC_Buffer[3] = 3;
    IIC_Buffer[4] = 4;
    IIC_Buffer[5] = 5;

    /* Setup DMAC to write data to IIC */
    /* Configure channel 3 of DMAC to be triggered by SCI2 Tx */
    R_DMAM_Create(
        3,
        PDL_DMAM_REPEAT | PDL_DMAM_SOURCE_ADDRESS_PLUS | \
        PDL_DMAM_DESTINATION_ADDRESS_FIXED | PDL_DMAM_SIZE_8 | PDL_DMAM_IRQ_END,
        PDL_DMAM_TRIGGER_SCI2_TX,
        IIC_Buffer, /* Source */
        (uint8_t *)&SCI2.TDR, /* Dest */
        1,

```

```

        6,                /* Data length (Address in EEPROM + 5 Data) */
        PDL_NO_DATA,
        PDL_NO_DATA,
        PDL_NO_DATA,
        Callback,        /* Callback done function */
        7                /* Interrupt priority */
    );

    /* Enable DMAC channel 3 */
    R_DMAC_Control(
        3,
        PDL_DMACE_ENABLE,
        PDL_NO_PTR,
        PDL_NO_PTR,
        PDL_NO_DATA,
        PDL_NO_DATA,
        PDL_NO_DATA,
        PDL_NO_DATA,
        PDL_NO_DATA
    );

    /* Clear flag */
    data_sent = false;
    /* Start IIC Write */
    R_SCI_IIC_Write(
        CHANNEL_SCI_IIC,
        PDL_SCI_IIC_DMACE_TRIGGER_ENABLE,
        SLAVE_ADDRESS,
        PDL_NO_DATA, /* No data length as using DMAC */
        PDL_NO_DATA, /* No buffer as using DMAC */
        PDL_NO_FUNC
    );

    /* Wait for write to complete */
    while(false == data_sent){;}

    /* Because using DMAC need to manually send a stop to end the transfer */
    R_SCI_Control(
        CHANNEL_SCI_IIC,
        PDL_SCI_IIC_STOP
    );
}

/* Callback done */
static void Callback(void)
{
    data_sent = true;
}

```

Figure 5-41: Example of SCI in IIC mode using DMAC

5.17.11. SCI in IIC Mode using DTC

This shows the setting of SCI channel 2 in to IIC mode and then a read from an IIC EEPROM using the DTC.

```

/* PDL functions */
#include "r_pdl_sci.h"
#include "r_pdl_cgc.h"
#include "r_pdl_dtc.h"

/* PDL device-specific definitions */
#include "r_pdl_definitions.h"

static void CallbackRx(void);

/* SCI IIC Channel */
#define CHANNEL_SCI_IIC 2
/* IIC Slave address of EEPROM */
#define SLAVE_ADDRESS 0xA0
/* Address in EEPROM where we will write a byte */
#define EEPROM_ADDRESS 0x01

/* Flag */
volatile uint8_t data_received;

/* Reserve an area for the DTC vector table */
#pragma address dtc_vector_table = 0x00001000
uint32_t dtc_vector_table[256];

void main(void)
{
    /* Data Buffer */
    volatile uint8_t IIC_Buffer[10];

    /* DTC needs to write dummy data to SCI.TDR when reading. */
    uint8_t IIC_Dummy_value = 0xFF;

    /* Reserve 16 bytes (full address mode) for the transfer data areas */
    uint32_t dtc_iic1_tx_transfer_data[4];
    uint32_t dtc_iic1_rx_transfer_data[4];

    /* Initialise the system clocks */
    NOTE: The code to initialise the system clock using R_CGC_Set is omitted here.
    Please refer to 5.1 Clock Generation Circuit.

    /* Select the PLL as the clock source */
    R_CGC_Control(
        PDL_CGC_CLK_PLL,
        PDL_NO_DATA,
        PDL_NO_DATA
    );

    /* Set Channel 2 pin options */
    R_SCI_Set(
        2,
        PDL_SCI_PIN_SCI2_SSCL2_P12 | PDL_SCI_PIN_SCI2_SSDA2_P13
    );

    /* Setup the SCI IIC channel */
    R_SCI_Create(
        CHANNEL_SCI_IIC,
        PDL_SCI_SYNC | PDL_SCI_IIC_MODE | PDL_SCI_IIC_DELAY_SDA_20_21,
        9600,
        1,
        0
    );

    /* Configure the DTC controller */
    R_DTC_Set(
        PDL_DTC_ADDRESS_FULL,

```



```

    dtc_vector_table
);

/* Set current EEPROM address */
IIC_Buffer[0] = EEPROM_ADDRESS;
/* Use blocking function for this, DTC will be used for the data part. */
R_SCI_IIC_Write(
    CHANNEL_SCI_IIC,
    PDL_SCI_IIC_NOSTOP,
    SLAVE_ADDRESS,
    1,
    IIC_Buffer,
    PDL_NO_FUNC
);

/* Set flag */
data_received = false;

/* Read data from current EEPROM address using DTC */
/* Start with an IIC Re-start */
/* DTC on Rx */
R_DTC_Create(
    PDL_DTC_NORMAL | PDL_DTC_DESTINATION_ADDRESS_PLUS | \
    PDL_DTC_SOURCE_ADDRESS_FIXED | PDL_DTC_SIZE_8 | PDL_DTC_IRQ_COMPLETE | \
    PDL_DTC_TRIGGER_RXI2,
    dtc_iicl_rx_transfer_data,
    (uint8_t *)&SCI2.RDR, /* Source */
    IIC_Buffer, /* Destination */
    /* Data length is one less than we want to read as
    use R_SCI_IIC_ReadLastByte */
    4,
    PDL_NO_DATA
);

/* DTC on Tx (To write the dummy data out.) */
/* Data length is 2 less than we want to read as first dummy byte
is written out by R_SCI_IIC_Read function and last one when we use
R_SCI_IIC_ReadLastByte. */
R_DTC_Create(
    PDL_DTC_NORMAL | PDL_DTC_SOURCE_ADDRESS_FIXED |
    PDL_DTC_DESTINATION_ADDRESS_FIXED | PDL_DTC_SIZE_8 | \
    PDL_DTC_IRQ_COMPLETE | PDL_DTC_TRIGGER_TXI2,
    dtc_iicl_tx_transfer_data,
    &IIC_Dummy_value, /* Source */
    (uint8_t *)&SCI2.TDR, /* Destination */
    3, /* Data length */
    PDL_NO_DATA
);

/* Enable the DTC */
R_DTC_Control(
    PDL_DTC_START,
    PDL_NO_PTR,
    PDL_NO_PTR,
    PDL_NO_PTR,
    PDL_NO_DATA,
    PDL_NO_DATA
);

/* Start the IIC Read */
R_SCI_IIC_Read(
    CHANNEL_SCI_IIC,
    PDL_SCI_IIC_RESTART | PDL_SCI_IIC_DTC_TRIGGER_ENABLE,
    SLAVE_ADDRESS,
    PDL_NO_DATA, /* No data length as using DTC */
    PDL_NO_DATA, /* No buffer as using DTC */
    CallbackRx
);

```

```
    /* Wait for rx */
    while(data_received == false){;}

    /* Because using DMAC need to manually get the last byte.
    This will also generate the stop condition. */
    R_SCI_IIC_ReadLastByte(
        CHANNEL_SCI_IIC,
        &IIC_Buffer[4]
    );
}

/* Callback function for Rx */
static void CallbackRx(void)
{
    data_received = true;
}
```

Figure 5-42: Example of SCI in IIC mode using DTC

5.18. I²C Bus Interface

In the following examples, the bus activity will be illustrated using the following format.

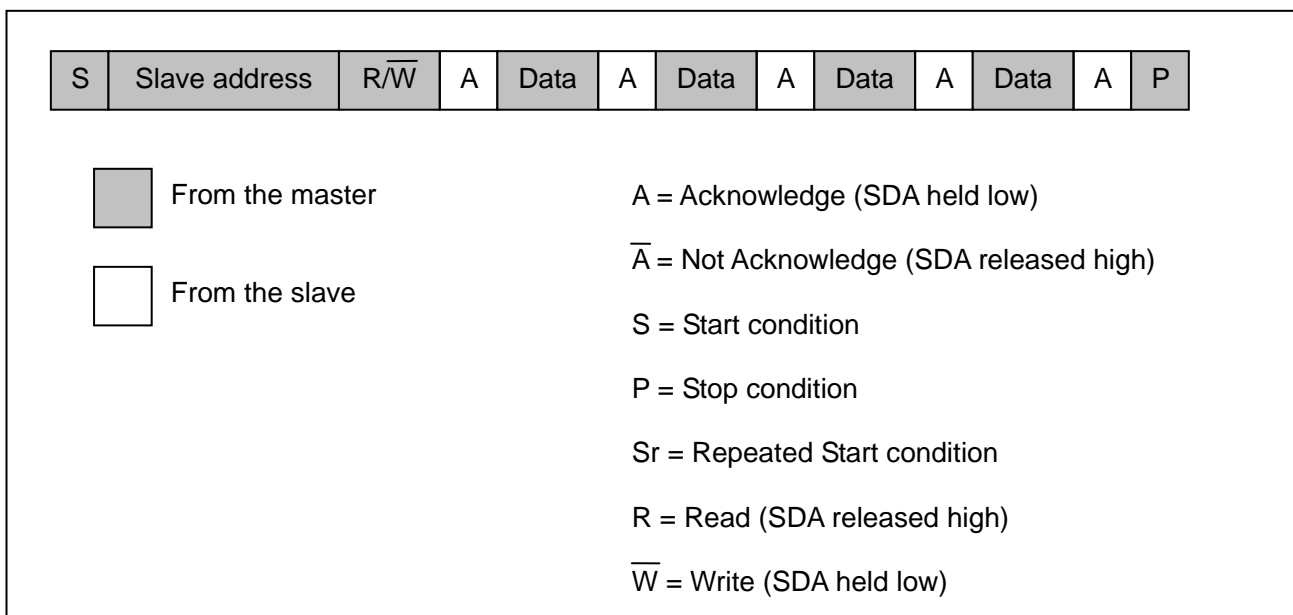

Figure 5-43: I²C bus activity notation

5.18.1. Master mode

In this example an EEPROM device has been connected to channel 0.

The EEPROM responds to the 7-bit slave address 1010xxx_b.

During a read process the bits “xxx” can be any value.

During a write process:

- i) The bits “xxx” represent the EEPROM memory address bits a10, a9 and a8.
- ii) The first byte after the slave address is the EEPROM memory address bits a7 to a0.

The EEPROM has a write cycle time of 5 ms.

The following examples illustrate the use of Master mode.

1) Configuration and transmission

The MCU's I²C channel 0 will be configured for Master operation and used to send 4 bytes to a slave.

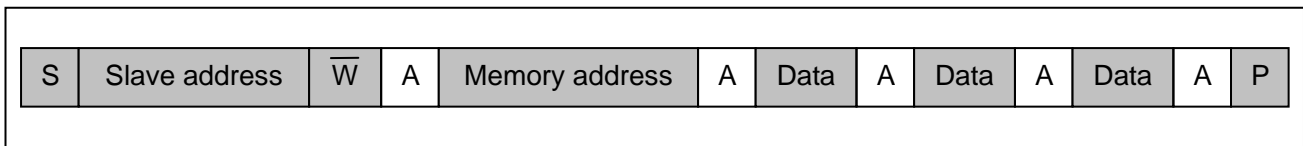

Figure 5-44: The bus activity, showing 4 bytes being transmitted to the EEPROM

```

/* Peripheral driver function prototypes */
#include "r_pdl_iic.h"
#include "r_pdl_cgc.h"
#include "r_pdl_cmt.h"

/* RPDL device-specific definitions */
#include "r_pdl_definitions.h"

#define EEPROM_ADDRESS 0xA0

void main(void)
{
    const uint8_t eeprom_data_array_1[5] = {0x00, 0x01, 0x02, 0x03, 0x04};
    uint8_t data_storage[5];
    uint32_t status_flags = 0;
    uint16_t TxChars;
    uint16_t RxChars;

    /* Initialise the system clocks */
    NOTE: The code to initialise the system clock using R_CGC_Set is omitted here.
    Please refer to 5.1 Clock Generation Circuit.

    /* Select I2C mode at 100kHz, 300ns rise time, 200ns fall time */
    R_IIC_Create(
        0,
        PDL_IIC_MODE_IIC | PDL_IIC_INT_PCLK_DIV_8,
        PDL_NO_DATA,
        PDL_NO_DATA,
        PDL_NO_DATA,
        PDL_NO_DATA,
        100E3,
        (300 << 16) | 200
    );

    /* Send the sub address and 3 bytes to the EEPROM, using polling */
    if (R_IIC_MasterSend(
        0,
        PDL_NO_DATA,
        EEPROM_ADDRESS,
        eeprom_data_array_1,
        4,
        PDL_NO_FUNC,
        0
    ) == false)
    {
        /* Read the channel and transfer status */
        R_IIC_GetStatus(
            0,
            &status_flags,
            &TxChars,
            PDL_NO_PTR
        );
        /* Review the flags and transmit count to decide on the next action */
    }
    else

```

```

{
    /* Wait for 5ms while the EEPROM updates */
    R_CMT_CreateOneShot(
        0,
        0,
        5E-3,
        PDL_NO_FUNC,
        0
    );
}

```

Figure 5-45: Configure the I²C channel and write 3 data bytes to the first locations

2) Reception

Continuing from above; The I²C in master is now used to read 4 bytes from a slave device from the current memory address.

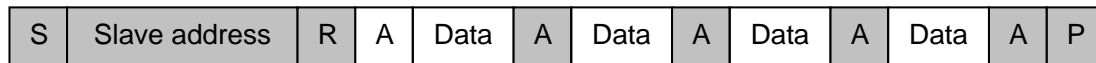

Figure 5-46: The bus activity, showing 4 bytes being transmitted by the EEPROM

```

/* Read data from the EEPROM, using polling */
if (R_IIC_MasterReceive(
    0,
    PDL_NO_DATA,
    EEPROM_ADDRESS,
    data_storage,
    4,
    PDL_NO_FUNC,
    0
) == false)
{
    /* Read the channel and transfer status */
    R_IIC_GetStatus(
        0,
        &status_flags,
        PDL_NO_PTR,
        &RxChars
    );
    /* Review the flags and transmit count to decide on the next action */
}

```

Figure 5-47: An example of reading data from the EEPROM

3) Repeated Start

Continuing from above; The memory address pointer of an EEPROM will be modified, and then a Repeat Start condition used to change to read the byte at that memory location in the EEPROM.

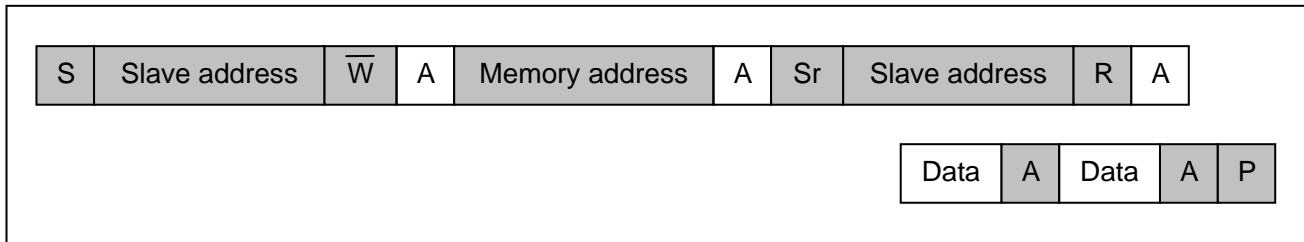

Figure 5-48: The bus activity, showing the Repeated Start condition when switching to the Read process

```

/* Send 1 byte to the EEPROM to update the sub address bits and do not stop */
R_IIC_MasterSend(
    0,
    PDL_IIC_STOP_DISABLE,
    EEPROM_ADDRESS,
    eeprom_data_array_1,
    1,
    PDL_NO_FUNC,
    0
);

/* Read data from the EEPROM. A repeated start will occur. */
R_IIC_MasterReceive(
    0,
    PDL_NO_DATA,
    EEPROM_ADDRESS,
    data_storage,
    2,
    PDL_NO_FUNC,
    0
);

```

Figure 5-49: Set the EEPROM sub address and then read 2 bytes.

5.18.2. Master mode with DMAC

In the following example, data is written to an EEPROM in two bursts. DMAC channel 3 is used to handle the data transfer. The same EEPROM address locations are then read out in two bursts. DMAC channel 2 is used to handle the data transfer.

```

/* PDL functions */
#include "r_pdl_cgc.h"
#include "r_pdl_iic.h"
#include "r_pdl_cmt.h"
#include "r_pdl_dmac.h"

/* PDL device-specific definitions */
#include "r_pdl_definitions.h"

static void write_eeprom_data(void);
static void read_eeprom_data(void);
void iic_tx_dmac_end_handler(void);
void iic_rx_dmac_end_handler(void);

#define EEPROM_MEMORY_ADDRESS_UPPER 0x00
#define EEPROM_MEMORY_ADDRESS_LOWER 0x00
#define EEPROM_ADDRESS (0x00A0 | EEPROM_MEMORY_ADDRESS_UPPER)

#define IIC_CHANNEL 0

volatile uint8_t bus_busy;
volatile uint8_t data_storage[20];

void main(void)
{
    #define ARRAY_1_SIZE 6 /* 5 Data bytes + 1 address */
    #define ARRAY_2_SIZE 11 /* 10 Data bytes + 1 address */
    const uint8_t eeprom_data_array_1[ARRAY_1_SIZE] = {EEPROM_MEMORY_ADDRESS_LOWER,
        0x11, 0x22, 0x33, 0x44, 0x55};
    const uint8_t eeprom_data_array_2[ARRAY_2_SIZE] = {EEPROM_MEMORY_ADDRESS_LOWER + 5,
        0x06, 0x07, 0x08, 0x09, 0x0A, 0x0B, 0x0C, 0x0D, 0x0E, 0x0F};
    uint8_t i;

    /* Initialise the system clocks */
    NOTE: The code to initialise the system clock using R_CGC_Set is omitted here.
    Please refer to 5.1 Clock Generation Circuit.

    /* Set up a DMAC channel for IIC transmission */
    R_DMAC_Create(
        3,
        PDL_DMAC_NORMAL | PDL_DMAC_SIZE_8 |
        PDL_DMAC_SOURCE_ADDRESS_PLUS |
        PDL_DMAC_DESTINATION_ADDRESS_FIXED |
        PDL_DMAC_IRQ_END,
        PDL_DMAC_TRIGGER_IIC0_TX,
        eeprom_data_array_1,
        (uint8_t *)&RIIC0.ICDRT,
        ARRAY_1_SIZE,
        PDL_NO_DATA,
        PDL_NO_DATA,
        PDL_NO_DATA,
        PDL_NO_DATA,
        iic_tx_dmac_end_handler,
        7
    );

    /* Set up a DMAC channel for IIC reception*/
    /* This will read back the bytes previously written except the last one
    which will be read using R_IIC_MasterReceiveLast */
    R_DMAC_Create(
        2,
        PDL_DMAC_NORMAL | PDL_DMAC_SIZE_8 |
        PDL_DMAC_SOURCE_ADDRESS_FIXED |

```

```

        PDL_DMAC_DESTINATION_ADDRESS_PLUS |
        PDL_DMAC_IRQ_END,
        PDL_DMAC_TRIGGER_IIC0_RX,
        (uint8_t *)&RIIC0.ICDRR,
        data_storage,
        ARRAY_1_SIZE-2, /* Array size written - sub address byte - last byte */
        PDL_NO_DATA,
        PDL_NO_DATA,
        PDL_NO_DATA,
        PDL_NO_DATA,
        iic_rx_dmac_end_handler,
        7
    );

    /* Select I2C mode at 100kHz, 300ns rise time, 200ns fall time */
    R_IIC_Create(
        IIC_CHANNEL,
        PDL_IIC_MODE_IIC | PDL_IIC_INT_PCLK_DIV_8,
        0,
        0,
        0,
        0,
        100E3,
        (300 << 16) | 200
    );

    /* Write the data into the EEPROM */
    write_eeprom_data();

    /* Prepare the next data for writing to the EEPROM */
    R_DMAC_Control(
        3,
        PDL_DMAC_SUSPEND | PDL_DMAC_ENABLE | \
        PDL_DMAC_UPDATE_SOURCE | PDL_DMAC_UPDATE_COUNT | PDL_DMAC_CLEAR_DTIF,
        eeprom_data_array_2,
        PDL_NO_PTR,
        ARRAY_2_SIZE,
        PDL_NO_DATA,
        PDL_NO_DATA,
        PDL_NO_DATA,
        PDL_NO_DATA,
        PDL_NO_DATA
    );

    /* Write the data into the EEPROM */
    write_eeprom_data();

    /* Clear the data storage area */
    for (i = 0; i < 20; i++) data_storage[i] = 0x00;

    /* Reset the EEPROM sub-address to 0, using polling */
    R_IIC_MasterSend(
        IIC_CHANNEL,
        PDL_IIC_STOP_DISABLE,
        EEPROM_ADDRESS,
        eeprom_data_array_1,
        1,
        PDL_NO_FUNC,
        0
    );

    /* Read data from the EEPROM using the DMAC */
    read_eeprom_data();

    /* Prepare to read the next data */
    /* This will read back the bytes previously written except the last one
    which will be read using R_IIC_MasterReceiveLast */
    R_DMAC_Control(
        2,

```



```

        PDL_DMAMC_SUSPEND | PDL_DMAMC_ENABLE | \
        PDL_DMAMC_UPDATE_DESTINATION | PDL_DMAMC_UPDATE_COUNT,
        PDL_NO_PTR,
        &data_storage[ARRAY_1_SIZE-1],
        ARRAY_2_SIZE-2, /* Array size written - sub address byte - last byte */
        PDL_NO_DATA,
        PDL_NO_DATA,
        PDL_NO_DATA,
        PDL_NO_DATA
    );

    /* Read data from the EEPROM using the DMAC */
    read_eeprom_data();
}

static void write_eeprom_data(void)
{
    bus_busy = true;
    /* Send data to the EEPROM using the DMAC */
    if(false == R_IIC_MasterSend(
        IIC_CHANNEL,
        PDL_IIC_DMAMC_TRIGGER_ENABLE,
        EEPROM_ADDRESS,
        PDL_NO_PTR,
        0,
        PDL_NO_FUNC,
        0))
    {
        while(1);
    }
    while (bus_busy == true);

    /* Wait for 5ms while the EEPROM updates */
    R_CMT_CreateOneShot(
        0,
        0,
        5E-3,
        PDL_NO_FUNC,
        0
    );
}

static void read_eeprom_data(void)
{
    bus_busy = true;
    /* Read data from the EEPROM using the DMAC */
    if(false == R_IIC_MasterReceive(
        IIC_CHANNEL,
        PDL_IIC_DMAMC_TRIGGER_ENABLE,
        EEPROM_ADDRESS,
        PDL_NO_PTR,
        0,
        PDL_NO_FUNC,
        0
    ))
    {
        while(1);
    }
    while (bus_busy == true);
}

void iic_tx_dmac_end_handler(void)
{
    uint32_t status_flags = 0;

    /* Wait for the transmission to complete */
    do
    {

```

```
        R_IIC_GetStatus(  
            IIC_CHANNEL,  
            &status_flags,  
            PDL_NO_PTR,  
            PDL_NO_PTR  
        );  
    } while((status_flags & 0x0080u) == 0x0u);  
  
    /* Issue a Stop condition */  
    R_IIC_Control(  
        IIC_CHANNEL,  
        PDL_IIC_STOP  
    );  
  
    bus_busy = false;  
}  
  
void iic_rx_dmac_end_handler(void)  
{  
    uint32_t DestAddr = 0;  
  
    /* Read the next destination address for the current transfer */  
    R_DMxAC_GetStatus(  
        2,  
        PDL_NO_PTR,  
        PDL_NO_PTR,  
        &DestAddr,  
        PDL_NO_PTR,  
        PDL_NO_PTR  
    );  
  
    /* Read one more byte with NACK condition and stop */  
    R_IIC_MasterReceiveLast(  
        IIC_CHANNEL,  
        (uint8_t *)DestAddr  
    );  
  
    bus_busy = false;  
}
```

Figure 5-50: An example of writing data to and reading data from an EEPROM, using two DMAC channels

5.18.3. Master mode with DTC

In the following example, data is written to an EEPROM in two bursts. The DTC is used to handle the data transfer. The same EEPROM address locations are then read out in two bursts. The DTC is used to handle the data transfer.

```

/* Peripheral driver function prototypes */
#include "r_pdl_iic.h"
#include "r_pdl_cgc.h"
#include "r_pdl_cmt.h"
#include "r_pdl_dtc.h"

/* RPDL device-specific definitions */
#include "r_pdl_definitions.h"

static void write_eeprom_data(void);
static void read_eeprom_data(void);
void iic_tx_end_handler(void);
void iic_rx_end_handler(void);

#define EEPROM_MEMORY_ADDRESS_UPPER 0x00
#define EEPROM_MEMORY_ADDRESS_LOWER 0x00
#define EEPROM_ADDRESS (0x00A0 | EEPROM_MEMORY_ADDRESS_UPPER)

#define IIC_CHANNEL 0

volatile uint8_t bus_busy;
volatile uint8_t data_storage[20];

/* Reserve an area for the DTC vector table */
#pragma address dtc_vector_table = 0x00002000
uint32_t dtc_vector_table[256];

/* Reserve 16 bytes (full address mode) for the transfer data areas */
uint32_t dtc_iic1_tx_transfer_data[4];
uint32_t dtc_iic1_rx_transfer_data[4];

void main(void)
{
    #define ARRAY_1_SIZE 6 /* 5 Data + 1 address */
    #define ARRAY_2_SIZE 11 /* 10 Data + 1 address */
    const uint8_t eeprom_data_array_1[ARRAY_1_SIZE] = {EEPROM_MEMORY_ADDRESS_LOWER,
        0x11, 0x22, 0x33, 0x44, 0x55};
    const uint8_t eeprom_data_array_2[ARRAY_2_SIZE] = {EEPROM_MEMORY_ADDRESS_LOWER + 5,
        0x66, 0x77, 0x88, 0x99, 0xAA, 0xBB, 0xCC, 0xDD, 0xEE, 0xFF};
    uint8_t i;

    /* Initialise the system clocks */
    NOTE: The code to initialise the system clock using R_CGC_Set is omitted here.
    Please refer to 5.1 Clock Generation Circuit.

    /* Configure the DTC controller */
    R_DTC_Set(
        PDL_DTC_ADDRESS_FULLL,
        dtc_vector_table
    );

    /* Set up a DTC channel for IIC transmission */
    R_DTC_Create(
        PDL_DTC_NORMAL | \
        PDL_DTC_SOURCE_ADDRESS_PLUS | \
        PDL_DTC_DESTINATION_ADDRESS_FIXED | \
        PDL_DTC_SIZE_8 | \
        PDL_DTC_IRQ_COMPLETE | \
        PDL_DTC_TRIGGER_IIC0_TX ,
        dtc_iic1_tx_transfer_data,
        eeprom_data_array_1,
        (uint8_t *)&RIIC0.ICDRT,
        ARRAY_1_SIZE,

```

```

        PDL_NO_DATA
    );

    /* Set up a DTC channel for IIC reception */
    /* This will read back the bytes previously written except the last one
    which will be read using R_IIC_MasterReceiveLast */
    R_DTC_Create(
        PDL_DTC_NORMAL | \
        PDL_DTC_SOURCE_ADDRESS_FIXED | PDL_DTC_DESTINATION_ADDRESS_PLUS | \
        PDL_DTC_SIZE_8 | \
        PDL_DTC_IRQ_COMPLETE | \
        PDL_DTC_TRIGGER_IIC0_RX,
        dtc_iic1_rx_transfer_data,
        (uint8_t *)&RIIC0.ICDRR,
        data_storage,
        ARRAY_1_SIZE-2, /* Array size written - sub address byte - last byte */
        PDL_NO_DATA
    );

    /* Select I2C mode at 100kHz, 300ns rise time, 200ns fall time */
    R_IIC_Create(
        IIC_CHANNEL,
        PDL_IIC_MODE_IIC | PDL_IIC_INT_PCLK_DIV_8,
        0,
        0,
        0,
        0,
        100E3,
        (300 << 16) | 200
    );

    /* Enable the DTC */
    R_DTC_Control(
        PDL_DTC_START,
        PDL_NO_PTR,
        PDL_NO_PTR,
        PDL_NO_PTR,
        PDL_NO_DATA,
        PDL_NO_DATA
    );

    /* Write the data into the EEPROM */
    write_eeprom_data();

    /* Prepare the next data to write to the EEPROM */
    R_DTC_Control(
        PDL_DTC_UPDATE_SOURCE | PDL_DTC_UPDATE_COUNT,
        dtc_iic1_tx_transfer_data,
        eeprom_data_array_2,
        PDL_NO_PTR,
        ARRAY_2_SIZE,
        PDL_NO_DATA
    );

    /* Write the data into the EEPROM */
    write_eeprom_data();

    /* Clear the data storage area */
    for (i = 0; i < 20; i++) data_storage[i] = 0x00;

    /* Reset the EEPROM sub-address to 0, using polling */
    R_IIC_MasterSend(
        IIC_CHANNEL,
        PDL_IIC_STOP_DISABLE,
        EEPROM_ADDRESS,
        eeprom_data_array_1,
        1,
        PDL_NO_FUNC,

```

```

        0
    );

    /* Read data from the EEPROM using the DTC */
    read_eeprom_data();

    /* Prepare to read the next data */
    R_DTC_Control(
        PDL_DTC_UPDATE_DESTINATION | PDL_DTC_UPDATE_COUNT,
        dtc_iic1_rx_transfer_data,
        PDL_NO_PTR,
        &data_storage[ARRAY_1_SIZE-1],
        ARRAY_2_SIZE-2, /* Array size written - sub address byte - last byte */
        PDL_NO_DATA
    );

    /* Read data from the EEPROM using the DTC */
    read_eeprom_data();
}

static void write_eeprom_data(void)
{
    bus_busy = true;

    /* Send data to the EEPROM using the DTC */
    R_IIC_MasterSend(
        IIC_CHANNEL,
        PDL_IIC_DTC_TRIGGER_ENABLE,
        EEPROM_ADDRESS,
        PDL_NO_PTR,
        0,
        iic_tx_end_handler,
        7
    );

    while (bus_busy == true)
    {
        uint32_t iic_flags;
        uint16_t flags;
        uint32_t src;
        uint32_t dest;
        uint16_t counter;

        R_DTC_GetStatus(dtc_iic1_tx_transfer_data,
                        &flags,
                        &src,
                        &dest,
                        &counter,
                        PDL_NO_PTR);

        R_IIC_GetStatus(
            IIC_CHANNEL,
            &iic_flags,
            PDL_NO_PTR,
            PDL_NO_PTR
        );
    }

    /* Wait for 5ms while the EEPROM updates */
    R_CMT_CreateOneShot(
        0,
        0,
        5E-3,
        PDL_NO_FUNC,
        0
    );
}

```

```

static void read_eeprom_data(void)
{
    bus_busy = true;
    /* Read data from the EEPROM using the DTC */
    R_IIC_MasterReceive(
        IIC_CHANNEL,
        PDL_IIC_DTC_TRIGGER_ENABLE,
        EEPROM_ADDRESS,
        PDL_NO_PTR,
        0,
        iic_rx_end_handler,
        7
    );
    while (bus_busy == true);
}

void iic_tx_end_handler(void)
{
    uint32_t status_flags = 0;

    /* Wait for the transmission to complete */
    do
    {
        R_IIC_GetStatus(
            IIC_CHANNEL,
            &status_flags,
            PDL_NO_PTR,
            PDL_NO_PTR
        );
    } while((status_flags & 0x0080u) == 0x00u);

    /* Issue a Stop condition */
    R_IIC_Control(
        IIC_CHANNEL,
        PDL_IIC_STOP
    );

    bus_busy = false;
}

void iic_rx_end_handler(void)
{
    uint32_t DestAddr = 0;

    /* Read the next destination address for the current transfer */
    R_DTC_GetStatus(
        dtc_iic1_rx_transfer_data,
        PDL_NO_PTR,
        PDL_NO_PTR,
        &DestAddr,
        PDL_NO_PTR,
        PDL_NO_PTR
    );

    /* Read one more byte with NACK condition and stop */
    R_IIC_MasterReceiveLast(
        IIC_CHANNEL,
        (uint8_t *)DestAddr
    );

    bus_busy = false;
}

```

Figure 5-51: An example of writing data to and reading data from an EEPROM, using the DTC

5.18.4. Slave mode

In this example the MCU behaves as a virtual slave memory device on channel 0. It will respond to 7-bit address 0001001b. The sample is interrupt driven after the initial setup.

```

/* Peripheral driver function prototypes */
#include "r_pdl_iic.h"
#include "r_pdl_cgc.h"
#include "r_pdl_cmt.h"

/* RPDL device-specific definitions */
#include "r_pdl_definitions.h"

/* Define the size of the virtual memory */
#define STORAGE_SIZE 0x100
#define RX_BUFFER_SIZE (STORAGE_SIZE + 1)

#define SLAVE_CHANNEL 0
#define SLAVE_ADDRESS 0xA0

static void slave_callback(void);
static void StoreData(uint16_t count);

/* Current memory address */
volatile uint8_t data_storage_index = 0;
volatile uint8_t data_storage[STORAGE_SIZE];
volatile uint8_t Rx_Buffer[RX_BUFFER_SIZE];

void main(void)
{
    /* Initialise the system clocks */
    NOTE: The code to initialise the system clock using R_CGC_Set is omitted here.
    Please refer to 5.1 Clock Generation Circuit.

    /* Select IIC mode at 100kHz, 300ns rise time, 200ns fall time */
    R_IIC_Create(
        SLAVE_CHANNEL,
        PDL_IIC_MODE_IIC | PDL_IIC_INT_PCLK_DIV_8,
        PDL_IIC_SLAVE_0_ENABLE_7,
        SLAVE_ADDRESS,
        PDL_NO_DATA,
        PDL_NO_DATA,
        100E3,
        (300 << 16) | 200
    );

    /* Start monitor the channel */
    R_IIC_SlaveMonitor(
        SLAVE_CHANNEL,
        PDL_NO_DATA,
        Rx_Buffer,
        RX_BUFFER_SIZE,
        slave_callback,
        7
    );

    /* The rest is interrupt driven */
    while(1);
}

/* R_IIC_SlaveMonitor or R_IIC_SlaveSend callback */
static void slave_callback(void)
{
    uint32_t status_flags = 0;
    uint16_t tx_count = 0;
    uint16_t rx_count = 0;
    bool bStartMonitor = true;

```

```

    /* Read the status */
    R_IIC_GetStatus(
        SLAVE_CHANNEL,
        &status_flags,
        &tx_count,
        &rx_count
    );

    /* Has the master just completed a write? */
    if(rx_count != 0)
    {
        StoreData(rx_count);

        /*Start monitoring again.*/
        bStartMonitor = true;
    }
    /* Has the master just completed a read? */
    else if(tx_count != 0)
    {
        /*Increment the current index by the amount the master read*/
        data_storage_index += tx_count;

        /*Start monitoring again.*/
        bStartMonitor = true;
    }
    /* Is the master starting a read?
    Check this by seeing if in transmit mode. */
    else if(0 != (status_flags & BIT_6))
    {
        /* Send data to master based on current address */
        R_IIC_SlaveSend(
            SLAVE_CHANNEL,
            &data_storage[data_storage_index],
            (uint16_t)(STORAGE_SIZE - data_storage_index)
        );

        /* Don't start monitoring again until the R_IIC_SlaveSend completes. */
        bStartMonitor = false;
    }

    if(true == bStartMonitor)
    {
        /* Continue monitoring */
        R_IIC_SlaveMonitor(
            SLAVE_CHANNEL,
            PDL_NO_DATA,
            Rx_Buffer,
            RX_BUFFER_SIZE,
            slave_callback,
            7
        );
    }
}

/* The master has sent us data (now in the Rx_Buffer),
store it in the data_storage array. */
static void StoreData(uint16_t count)
{
    uint16_t index = 0;

    /* Update data_storage_index */
    data_storage_index = Rx_Buffer[index];
    count--;
    index++;

    /*Store any data*/
    while(count != 0)

```



```
{
    data_storage[data_storage_index] = Rx_Buffer[index];
    count--;
    index++;
    data_storage_index++;
    if(data_storage_index == STORAGE_SIZE)
    {
        /* Wrap around */
        data_storage_index = 0;
    }
}
```

Figure 5-52: Virtual IIC Slave memory

5.19. Serial Peripheral Interface

5.19.1. Using one slave (1)

This is an example of Serial Peripheral Interface usage where one SPI master communicates with one SPI slave.

The RSK evaluation board is used to connect the two SPI channels together.

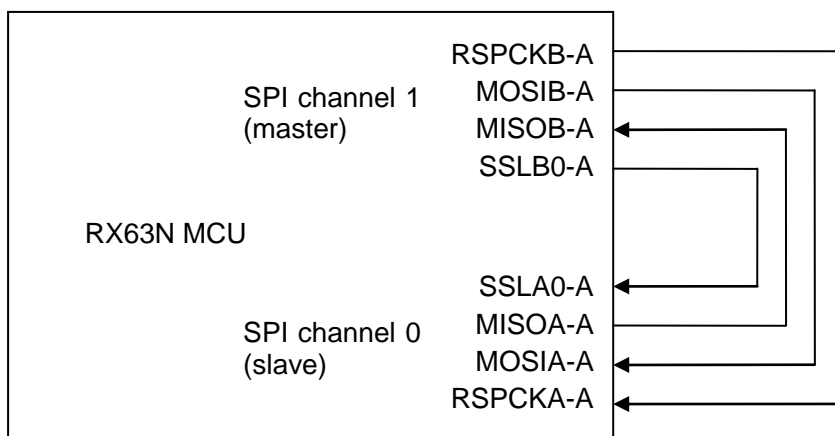

Figure 5-53 shows how four 32-bit words are transmitted and received simultaneously by the master and slave. The received data is then checked to confirm that the transfer was successful.

```

/* Peripheral driver function prototypes */
#include "r_pdl_cgc.h"
#include "r_pdl_spi.h"

/* PDL device-specific definitions */
#include "r_pdl_definitions.h"

void spi_slave_callback(void);

volatile bool slave_transfer_complete;

#define SLAVE_CHANNEL 0
#define MASTER_CHANNEL 1

void main(void)
{
    const uint32_t master_0_tx_data[4] = \
    {
        0x00000001,
        0x98765432,
        0xABCDEF34,
        0x12345678
    };
    uint32_t master_0_rx_data[4] = \
    {
        0x00000000,
        0x00000000,
        0x00000000,
        0x00000000
    };

    const uint32_t slave_0_tx_data[4] = \
    {
        0x32323232,
        0x3456789A,
        0xDEADBEEF,
        0xFEEEDCEDE
    };
}

```

```

uint32_t slave_0_rx_data[4] = \
{
    0x00000000,
    0x00000000,
    0x00000000,
    0x00000000
};

uint8_t i;

/* Initialise the system clocks */
NOTE: The code to initialise the system clock using R_CGC_Set is omitted here.
Please refer to 5.1 Clock Generation Circuit.

/* Configure SPI Pin */
R_SPI_Set(
    SLAVE_CHANNEL,
    PDL_SPI_RSPCKA_PB0 | PDL_SPI_MOSIA_PA6 | PDL_SPI_MISOA_PA7 | \
    PDL_SPI_SSLA0_PA4,
    PDL_NO_DATA
);

/* Configure SPI Pin */
R_SPI_Set(
    MASTER_CHANNEL,
    PDL_NO_DATA,
    PDL_SPI_RSPCKB_PE5 | PDL_SPI_MOSIB_PE6 | PDL_SPI_MISOB_PE3 | \
    PDL_SPI_SSLB0_PE4
);

/* Configure the master SPI channel */
R_SPI_Create(
    MASTER_CHANNEL,
    PDL_SPI_MODE_SPI_MASTER | PDL_SPI_PIN_SSL0_LOW,
    PDL_SPI_FRAME_1_4,
    PDL_NO_DATA,
    2E6
);

/* Configure the slave SPI channel */
R_SPI_Create(
    SLAVE_CHANNEL,
    PDL_SPI_MODE_SPI_SLAVE,
    PDL_SPI_FRAME_1_4,
    PDL_NO_DATA,
    PDL_NO_DATA
);

/* Configure the Master */
R_SPI_Command(
    MASTER_CHANNEL,
    0,
    PDL_SPI_CLOCK_MODE_0 | PDL_SPI_LENGTH_32 | PDL_SPI_LSB_FIRST | \
    PDL_SPI_ASSERT_SSL0,
    PDL_NO_DATA
);

/* Configure the slave */
R_SPI_Command(
    SLAVE_CHANNEL,
    0,
    PDL_SPI_CLOCK_MODE_0 | PDL_SPI_LENGTH_32 | PDL_SPI_LSB_FIRST,
    PDL_NO_DATA
);

/* Prepare the Slave for data transfer */
R_SPI_Transfer(

```

```

        SLAVE_CHANNEL,
        PDL_NO_DATA,
        slave_0_tx_data,
        slave_0_rx_data,
        1,
        spi_slave_callback,
        15,
        PDL_NO_FUNC,
        0
    );

    slave_transfer_complete = false;

    /* Transfer all the data once */
    R_SPI_Transfer(
        MASTER_CHANNEL,
        PDL_NO_DATA,
        master_0_tx_data,
        master_0_rx_data,
        1,
        PDL_NO_FUNC,
        0,
        PDL_NO_FUNC,
        0
    );

    while (slave_transfer_complete == false);

    for (i = 0; i < 4; i++)
    {
        /* Did the Master output match the Slave input? */
        if (master_0_tx_data[i] != slave_0_rx_data[i])
        {
            /* Handle the error */
        }

        /* Did the Master input match the Slave output? */
        if (master_0_rx_data[i] != slave_0_tx_data[i])
        {
            /* Handle the error */
        }
    }
}

void spi_slave_callback(void)
{
    uint16_t StatusValue = 0;
    uint16_t Sequence_count;

    /* Read the slave channel status */
    R_SPI_GetStatus(
        SLAVE_CHANNEL,
        &StatusValue,
        &Sequence_count
    );

    /* No errors? */
    if ((StatusValue & 0x000Du) == 0x0u)
    {
        slave_transfer_complete = true;
    }
    else
    {
        /* Handle the error */
    }
}

```

Figure 5-53: Example of Serial Peripheral Interface use

5.19.2. Using one slave (2)

Figure 5-54 shows how strings of 8-bit data are copied into 32-bit buffers, then transmitted and received simultaneously by the master and slave.

The received data is then checked to confirm that the transfer was successful.

```

/* Peripheral driver function prototypes */
#include "r_pdl_cgc.h"
#include "r_pdl_spi.h"

/* PDL device-specific definitions */
#include "r_pdl_definitions.h"

/* Required for this example */
#include <string.h>

void spi_slave_callback(void);

volatile bool slave_transfer_complete;

#define SLAVE_CHANNEL 0
#define MASTER_CHANNEL 1

#define BUFFER_LENGTH 25

const char master_data_to_be_sent[] = "SPI data to slave";
const char slave_data_to_be_sent[] = "SPI slave output ";

void main(void)
{
    uint32_t master_tx_data[BUFFER_LENGTH];
    uint32_t master_rx_data[BUFFER_LENGTH];
    uint32_t slave_tx_data[BUFFER_LENGTH];
    uint32_t slave_rx_data[BUFFER_LENGTH];

    uint8_t i;

    /* Initialise the system clocks */
    NOTE: The code to initialise the system clock using R_CGC_Set is omitted here.
    Please refer to 5.1 Clock Generation Circuit.

    /* Configure SPI Pin */
    R_SPI_Set(
        SLAVE_CHANNEL,
        PDL_SPI_RSPCKA_PB0 | PDL_SPI_MOSIA_PA6 | PDL_SPI_MISOA_PA7 | \
        PDL_SPI_SSIA_PA4,
        PDL_NO_DATA
    );

    /* Configure SPI Pin */
    R_SPI_Set(
        MASTER_CHANNEL,
        PDL_NO_DATA,
        PDL_SPI_RSPCKB_PE5 | PDL_SPI_MOSIB_PE6 | PDL_SPI_MISOB_PE7 | \
        PDL_SPI_SSLB0_PE4
    );

    /* Configure the master SPI channel */
    R_SPI_Create(
        MASTER_CHANNEL,
        PDL_SPI_MODE_SPI_MASTER | PDL_SPI_PIN_SSL0_LOW,
        PDL_SPI_FRAME_1_1,
        PDL_NO_DATA,
        2E6
    );

    /* Configure the slave SPI channel */

```

```

R_SPI_Create(
    SLAVE_CHANNEL,
    PDL_SPI_MODE_SPI_SLAVE,
    PDL_SPI_FRAME_1_1,
    PDL_NO_DATA,
    PDL_NO_DATA
);

/* Configure the Master */
R_SPI_Command(
    MASTER_CHANNEL,
    0,
    PDL_SPI_CLOCK_MODE_0 | PDL_SPI_LENGTH_8 | \
    PDL_SPI_LSB_FIRST | PDL_SPI_ASSERT_SSL0,
    PDL_NO_DATA
);

/* Configure the slave */
R_SPI_Command(
    SLAVE_CHANNEL,
    0,
    PDL_SPI_CLOCK_MODE_0 | PDL_SPI_LENGTH_8 | PDL_SPI_LSB_FIRST,
    PDL_NO_DATA
);

/* Clear the receive buffers */
for (i = 0; i < BUFFER_LENGTH; i++)
{
    master_rx_data[i] = 0x00000000;
    slave_rx_data[i] = 0x00000000;
}

/* Copy the source data into the transmit buffers */
for (i = 0; i < strlen(master_data_to_be_sent); i++)
{
    master_tx_data[i] = (uint32_t)master_data_to_be_sent[i];
    slave_tx_data[i] = (uint32_t)slave_data_to_be_sent[i];
}

/* Prepare the Slave for data transfer */
R_SPI_Transfer(
    SLAVE_CHANNEL,
    PDL_NO_DATA,
    slave_tx_data,
    slave_rx_data,
    (uint16_t)strlen(slave_data_to_be_sent),
    spi_slave_callback,
    15,
    PDL_NO_FUNC,
    0
);

slave_transfer_complete = false;

/* Transfer all the data once */
R_SPI_Transfer(
    MASTER_CHANNEL,
    PDL_NO_DATA,
    master_tx_data,
    master_rx_data,
    (uint16_t)strlen(master_data_to_be_sent),
    PDL_NO_FUNC,
    0,
    PDL_NO_FUNC,
    0
);

while (slave_transfer_complete == false);

```

```
for (i = 0; i < strlen(master_data_to_be_sent); i++)
{
    /* Did the Master output match the Slave input? */
    if (master_data_to_be_sent[i] != (uint8_t)slave_rx_data[i])
    {
        while(1);
    }
    /* Did the Master input match the Slave output? */
    if ( (uint8_t)master_rx_data[i] != slave_data_to_be_sent[i])
    {
        while(1);
    }
}

void spi_slave_callback(void)
{
    uint16_t StatusValue = 0;
    uint16_t Sequence_count;

    /* Read the slave channel status */
    R_SPI_GetStatus(
        SLAVE_CHANNEL,
        &StatusValue,
        &Sequence_count
    );

    /* No errors? */
    if ((StatusValue & 0x000Du) == 0x00u)
    {
        slave_transfer_complete = true;
    }
    else
    {
        while(1);
    }
}
```

Figure 5-54: Example of Serial Peripheral Interface use

5.19.3. Master operation with multiple slaves

This is an example of Serial Peripheral Interface usage where one SPI master communicates with four SPI slaves. Each slave requires different data bit lengths.

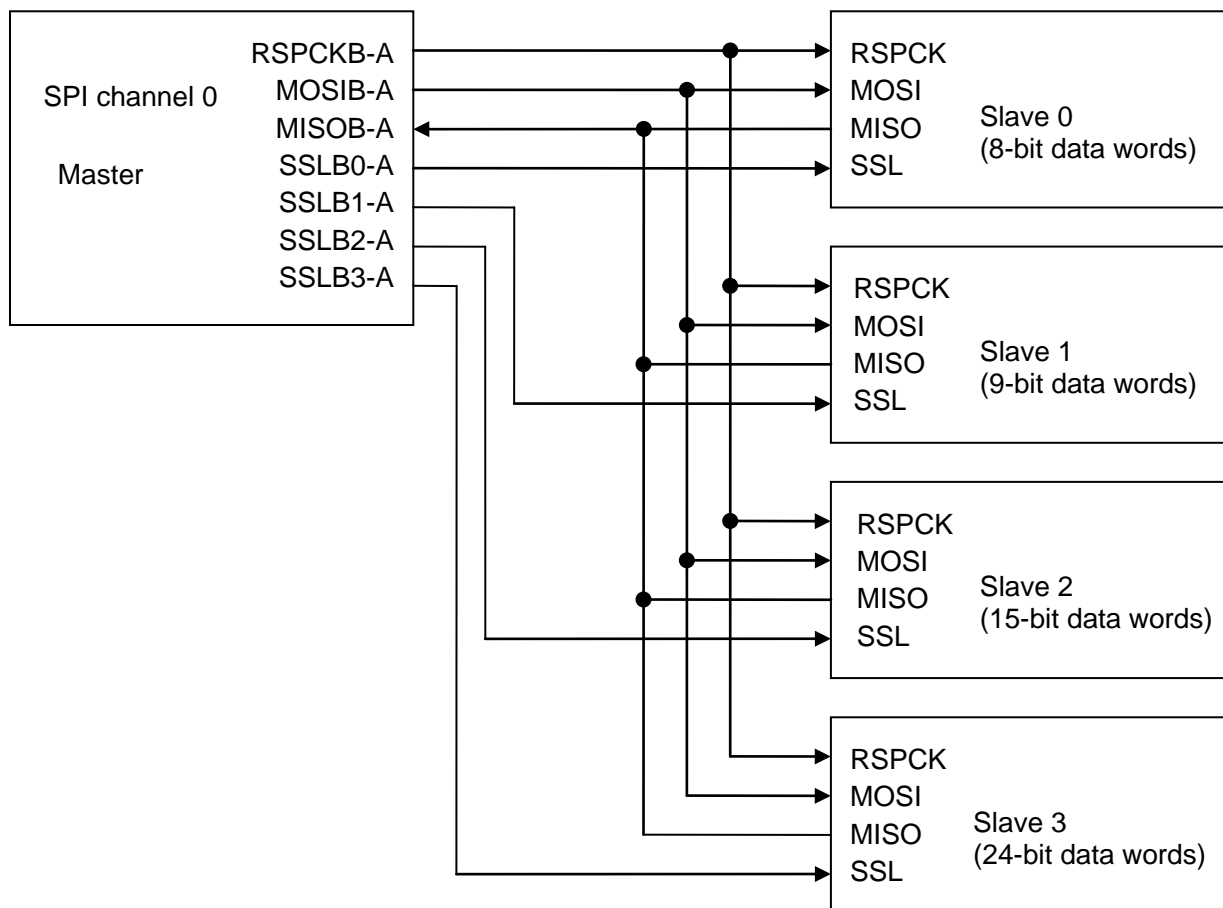

Figure 5-55 shows how data of appropriate bit lengths is transferred to each SPI slave. Commands 0 to 3 are executed in sequence, with each command asserting the appropriate SSL pin.

```

/* Peripheral driver function prototypes */
#include "r_pdl_spi.h"
#include "r_pdl_cgc.h"
#include "r_pdl_cmt.h"

/* PDL device-specific definitions */
#include "r_pdl_definitions.h"

#define MASTER_CHANNEL 0

void main(void)
{
    const uint32_t master_tx_data[4] = \
    {
        0x000000A4, /* 8-bit data */
        0x00000132, /* 9-bit data */
        0x00007F34, /* 15-bit data */
        0x00345678 /* 24-bit data */
    };

    uint32_t master_rx_data[4] = \
    {
        0x00000000,
    }

```



```

    0x00000000,
    0x00000000,
    0x00000000
};

/* Initialise the system clocks */
NOTE: The code to initialise the system clock using R_CGC_Set is omitted here.
Please refer to 5.1 Clock Generation Circuit.

/* Configure SPI Pin */
R_SPI_Set(
    MASTER_CHANNEL,
    PDL_SPI_RSPCKA_PB0 | PDL_SPI_MOSIA_PA6 | PDL_SPI_MISOA_PA7 | \
    PDL_SPI_SSIA0_PA4 | PDL_SPI_SSIA1_PA0 | \
    PDL_SPI_SSIA2_PA1 | PDL_SPI_SSIA3_PA2,
    PDL_NO_DATA
);

/* Configure the master SPI channel */
R_SPI_Create(
    MASTER_CHANNEL,
    PDL_SPI_MODE_SPI_MASTER | \
    PDL_SPI_PIN_SSIA0_LOW | PDL_SPI_PIN_SSIA1_LOW | \
    PDL_SPI_PIN_SSIA2_LOW | PDL_SPI_PIN_SSIA3_LOW,
    PDL_SPI_FRAME_4,
    PDL_NO_DATA,
    2E6
);

/* Prepare the transfer with slave 0 */
R_SPI_Command(
    MASTER_CHANNEL,
    0,
    PDL_SPI_CLOCK_MODE_0 | PDL_SPI_LSB_FIRST | \
    PDL_SPI_ASSERT_SSIA0 | PDL_SPI_LENGTH_8,
    PDL_NO_DATA
);

/* Prepare the transfer with slave 1 */
R_SPI_Command(
    MASTER_CHANNEL,
    1,
    PDL_SPI_CLOCK_MODE_0 | PDL_SPI_LSB_FIRST | \
    PDL_SPI_ASSERT_SSIA1 | PDL_SPI_LENGTH_9,
    PDL_NO_DATA
);

/* Prepare the transfer with slave 2 */
R_SPI_Command(
    MASTER_CHANNEL,
    2,
    PDL_SPI_CLOCK_MODE_0 | PDL_SPI_LSB_FIRST | \
    PDL_SPI_ASSERT_SSIA2 | PDL_SPI_LENGTH_15,
    PDL_NO_DATA
);

/* Prepare the transfer with slave 3 */
R_SPI_Command(
    MASTER_CHANNEL,
    3,
    PDL_SPI_CLOCK_MODE_0 | PDL_SPI_LSB_FIRST | \
    PDL_SPI_ASSERT_SSIA3 | PDL_SPI_LENGTH_24,
    PDL_NO_DATA
);

/* Transfer all the data once */
R_SPI_Transfer(
    MASTER_CHANNEL,

```

```
        PDL_NO_DATA,  
        master_tx_data,  
        master_rx_data,  
        1,  
        PDL_NO_FUNC,  
        0,  
        PDL_NO_FUNC,  
        0  
    );  
}
```

Figure 5-55: Example of multiple slave Serial Peripheral Interface use

5.20. IEBus Interface

5.20.1. Master operation

Figure 5-56 shows how the status of a slave unit is checked and data is sent to or transferred from it.

The slave status is read as one byte, with the contents in the format:

b7 – b6		b5	b4	b3	b2	b1	b0
Highest mode supported		0	Transmission status	0	Lock status	Buffer status	
0, 1, 2 or 3			0: Halted 1: Enabled		0: Unlocked 1: Locked	Receive	Transmit
					0: Empty 1: Contains data	0: Empty 1: Data available	

```

/* Peripheral driver function prototypes */
#include "r_pdl_ieb.h"
#include "r_pdl_cgc.h"
#include "r_pdl_io_port.h"

/* PDL device-specific definitions */
#include "r_pdl_definitions.h"

#include <string.h>

#define LED0    PDL_IO_PORT_0_3
#define LED1    PDL_IO_PORT_0_5

void main(void)
{
    const uint8_t
iebus_tx_data_a[32]={1,2,3,4,5,6,7,8,9,10,11,12,13,14,15,16,17,18,19,20,21,22,23,24,2
5,26,27,28,29,30,31,32};
    uint8_t iebus_rx_data[32];
    uint8_t iebus_rx_data_length=0;
    uint8_t iebus_slave_status=0;
    uint8_t counter;

    uint16_t General_flags;
    uint8_t Tx_status;
    uint32_t Rx_status;

    /* Configure the clocks */

    /* Initialise the system clocks */
    /* Prepare the main/pll clock settings */
    NOTE: The code to initialise the system clock using R_CGC_Set and R_CGC_Control are
omitted here. Please refer to 5.1 Clock Generation Circuit.

    /* Set the LED0 pin low */
    R_IO_PORT_Write(
        LED0,
        0
    );
    /* Set the LED1 pin low */
    R_IO_PORT_Write(
        LED1,
        0
    );
    /* Set the LED0 pin to output */
    R_IO_PORT_Set(
        LED0,
        PDL_IO_PORT_OUTPUT | PDL_IO_PORT_TYPE_CMOS | PDL_IO_PORT_DRIVE_HIGH
    );

```

```

/* Set the LED1 pin to output */
R_IO_PORT_Set(
    LED1,
    PDL_IO_PORT_OUTPUT | PDL_IO_PORT_TYPE_CMOS | PDL_IO_PORT_DRIVE_HIGH
);

/* Use port C for the IEBus pins */
R_IEB_Set(
    PDL_IEB_PIN_IERXD_PC2 | PDL_IEB_PIN_IETXD_PC3
);

/* Configure IEBus channel 0 */
R_IEB_Create(
    0,
    PDL_IEB_MODE_1 | PDL_IEB_POLARITY_HIGH,
    0x0001,
    0
);

while(1)
{
    /* Read the status from slave 345h, using polling */
    if(R_IEB_MasterReceive(
        0,
        PDL_IEB_STATUS,
        0x0345,
        &iebus_slave_status,
        &iebus_rx_data_length,
        PDL_NO_FUNC
    ) == true)
    {
        /* Was the slave status received? */
        if(iebus_rx_data_length == 1)
        {
            /* Is the slave able to accept data? */
            if((iebus_slave_status & BIT_1) == 0x0u)
            {
                /* Send data to the slave */
                if(R_IEB_MasterSend(
                    0,
                    PDL_IEB_DATA,
                    0x0345,
                    iebus_tx_data_a,
                    5,
                    PDL_NO_FUNC
                ) != true)
                {
                    /* Read the status of channel 0 */
                    R_IEB_GetStatus(
                        0,
                        &General_flags,
                        &Tx_status,
                        PDL_NO_PTR,
                        PDL_NO_PTR,
                        PDL_NO_PTR
                    );

                    /* Handle the error here */
                }
            }

            /* Is the slave ready to send data? */
            if((iebus_slave_status & BIT_0) != 0x0u)
            {
                /* Clear the data storage area */
                for(counter = 0; counter < 32; counter++)
                {
                    iebus_rx_data[counter] = 0x00;
                }
            }
        }
    }
}

```

5.20.2. Slave operation using polling

Figure 5-57 shows how a slave unit checks for data to be received from or sent to a master unit.

```

/* Peripheral driver function prototypes */
#include "r_pdl_ieb.h"
#include "r_pdl_cgc.h"
#include "r_pdl_cmt.h"

/* PDL device-specific definitions */
#include "r_pdl_definitions.h"

#include <string.h>

void main(void)
{
    uint8_t iebus_rx_data[32];
    uint8_t iebus_rx_data_length;
    uint16_t General_status;
    uint8_t Tx_status;
    uint32_t Rx_status;
    uint16_t received_sum;
    uint16_t checksum;
    uint8_t counter;
    const char iebus_tx_data_a[]="First slave message";
    const char iebus_tx_data_b[]="Second slave message";

    /* Initialise the system clocks */
    /* Prepare the main/pll clock settings */
    NOTE: The code to initialise the system clock using R_CGC_Set and R_CGC_Control are
    omitted here. Please refer to 5.1 Clock Generation Circuit.

    /* Use port C for the IEBus pins */
    R_IEB_Set(
        PDL_IEB_PIN_IERXD_PC2 | PDL_IEB_PIN_IETXD_PC3
    );

    /* Configure IEBus channel 0 */
    R_IEB_Create(
        0,
        PDL_IEB_MODE_1 | PDL_IEB_POLARITY_HIGH,
        0x0345,
        15
    );

    /* Prepare data for transmission when requested */
    R_IEB_SlaveWrite(
        0,
        (uint8_t *)iebus_tx_data_a,
        (uint8_t)strlen(iebus_tx_data_a)
    );

    iebus_rx_data_length = 0;
    General_status = 0;
    Tx_status = 0;
    Rx_status = 0;

    while(1)
    {
        /* Monitor channel 0 */
        R_IEB_SlaveMonitor(
            0,
            iebus_rx_data,
            &iebus_rx_data_length,
            PDL_NO_FUNC
        );
    }
}

```

```

/* Has data been received ? */
if (iebus_rx_data_length != 0)
{
    received_sum = 0;
    checksum = 0;
    /* Analyse the received data */
    for (counter = 0; counter < iebus_rx_data_length; counter++)
    {
        received_sum += iebus_rx_data[counter];
        checksum += (counter + 1);
    }
    /* Bad data ? */
    if (received_sum != checksum)
    {
        while(1);
    }

    /* Reset the receive buffer and counter */
    for (counter = 0; counter < 32; counter++)
    {
        iebus_rx_data[counter] = 0xFF;
    }
}
else
{
    /* Read the Receive status of channel 0 */
    R_IEB_GetStatus(
        0,
        PDL_NO_PTR,
        PDL_NO_PTR,
        &Rx_status,
        PDL_NO_PTR,
        PDL_NO_PTR
    );
}

/* Read the Transmit status of channel 0 */
R_IEB_GetStatus(
    0,
    PDL_NO_PTR,
    &Tx_status,
    PDL_NO_PTR,
    PDL_NO_PTR,
    PDL_NO_PTR
);

/* Slave transmission complete? */
if ((Tx_status & BIT_5) != 0)
{
    /* Prepare new data to be sent */
    R_IEB_SlaveWrite(
        0,
        (const uint8_t *)iebus_tx_data_b,
        (uint8_t)strlen(iebus_tx_data_b)
    );
}

/* Are any error flags set? */
if ( ((Tx_status & 0x0F) != 0) || ((Rx_status & 0x1F) != 0) )
{
    /* Read the General status of channel 0 */
    R_IEB_GetStatus(
        0,
        &General_status,
        PDL_NO_PTR,
        PDL_NO_PTR,
        PDL_NO_PTR,
        PDL_NO_PTR
    );
}

```

```
        );  
        /* Use General_status, Tx_status and Rx_status to handle the error */  
        while(1);  
    }  
}
```

Figure 5-57: Example of IEBus Slave use (using polling)

5.20.3. Slave operation using interrupts

Figure 5-58 shows how a slave unit checks for data to be received from or sent to a master unit.

```

/* Peripheral driver function prototypes */
#include "r_pdl_ieb.h"
#include "r_pdl_cgc.h"
#include "r_pdl_cmt.h"

/* PDL device-specific definitions */
#include "r_pdl_definitions.h"

#include <string.h>

volatile bool ieb_error;
volatile uint8_t iebus_rx_data[32];
volatile uint8_t iebus_rx_data_length;
volatile uint8_t Tx_status;
volatile uint32_t Rx_status;

void IEBus_callback(void);

const char iebus_tx_data_a[]="First slave message";
const char iebus_tx_data_b[]="Second slave message";

void main(void)
{
    uint16_t General_status;

    /* Initialise the system clocks */
    /* Prepare the main/pll clock settings */
    NOTE: The code to initialise the system clock using R_CGC_Set and R_CGC_Control are
    omitted here. Please refer to 5.1 Clock Generation Circuit.

    /* Use port C for the IEBus pins */
    R_IEB_Set(
        PDL_IEB_PIN_IERXD_PC2 | PDL_IEB_PIN_IETXD_PC3
    );

    /* Configure IEBus channel 0 */
    R_IEB_Create(
        0,
        PDL_IEB_MODE_1 | PDL_IEB_POLARITY_HIGH,
        0x0345,
        15
    );

    ieb_error = false;
    iebus_rx_data_length = 0;

    /* Prepare data for transmission when requested */
    R_IEB_SlaveWrite(
        0,
        (uint8_t *)iebus_tx_data_a,
        (uint8_t)strlen(iebus_tx_data_a)
    );

    /* Monitor channel 0 */
    R_IEB_SlaveMonitor(
        0,
        iebus_rx_data,
        &iebus_rx_data_length,
        IEBus_callback
    );

    while(1)
    {
        /* Has an error occurred ? */

```

```

        if (iebus_error == true)
        {
            /* Handle the error */

            General_status = 0;
            /* Read the General status of channel 0 */
            R_IEB_GetStatus(
                0,
                &General_status,
                PDL_NO_PTR,
                PDL_NO_PTR,
                PDL_NO_PTR,
                PDL_NO_PTR
            );

            while(1);
        }
    }
}

void IEBus_callback(void)
{
    uint8_t counter;
    uint16_t received_sum;
    uint16_t checksum;

    /* Has data been received ? */
    if (iebus_rx_data_length != 0)
    {
        received_sum = 0;
        checksum = 0;
        /* Analyse the received data */
        for (counter = 0; counter < iebus_rx_data_length; counter++)
        {
            received_sum += iebus_rx_data[counter];
            checksum += (counter + 1);
        }
        /* Bad data ? */
        if (received_sum != checksum)
        {
            while(1);
        }

        /* Reset the receive buffer and counter */
        for (counter = 0; counter < 32; counter++)
        {
            iebus_rx_data[counter] = 0xFF;
        }
        iebus_rx_data_length = 0;
    }

    Tx_status = 0;
    Rx_status = 0;
    /* Read the status of channel 0 */
    /* This clears the Tx and Rx status flags */
    /* Reception is unblocked */
    R_IEB_GetStatus(
        0,
        PDL_NO_PTR,
        &Tx_status,
        &Rx_status,
        PDL_NO_PTR,
        PDL_NO_PTR
    );

    /* Slave transmission complete? */
    if ((Tx_status & BIT_5) != 0)
    {

```

```
    /* Prepare new data to be sent */
    R_IEB_SlaveWrite(
        0,
        (uint8_t *)iebus_tx_data_b,
        (uint8_t)strlen(iebus_tx_data_b)
    );
}

/* Are any error flags set? */
if ( ((Tx_status & 0x0F) != 0) || ((Rx_status & 0x1F) != 0) )
{
    ieb_error = true;
}
}
```

Figure 5-58: Example of IEBus Slave use (with interrupts)

5.21. CRC calculator

Figure 5-59 shows an example of CRC usage. The payload and CRC checksum have been received from a remote unit. The CRC calculator is used to check that the payload is correct.

```
/* Peripheral driver function prototypes */
#include "r_pdl_crc.h"

/* RPDL device-specific definitions */
#include "r_pdl_definitions.h"

void main(void)
{
    uint16_t crc_result;

    /* Configure the CRC to use the CCITT polynomial; */
    R_CRC_Create(
        PDL_CRC_POLY_CRC_CCITT | PDL_CRC_LSB_FIRST
    );

    /* Write the payload data */
    R_CRC_Write(
        0xF0
    );

    /* Write the first half of the CRC checksum */
    R_CRC_Write(
        0x8F
    );

    /* Write the second half of the CRC checksum */
    R_CRC_Write(
        0xF7
    );

    /* Read the CRC calculation result; Expected result is 0 */
    R_CRC_Read(
        PDL_NO_DATA,
        &crc_result
    );

    /* Shutdown the CRC unit */
    R_CRC_Destroy(
    );
}
```

Figure 5-59: Example of CRC calculation

5.22. 10-bit Analog to Digital Converter

Figure 5-60 shows an example of ADC_10 usage.

```

/* Peripheral driver function prototypes */
#include "r_pdl_adc_10.h"
#include "r_pdl_cgc.h"

/* RPDL device-specific definitions */
#include "r_pdl_definitions.h"

uint16_t result_adc0[8];

void ADC0_callback(void);

void main(void)
{
    /* Initialise the system clocks */
    NOTE: The code to initialise the system clock using R_CGC_Set is omitted here.
    Please refer to 5.1 Clock Generation Circuit.

    /* Configure analog input */
    R_ADC_10_Set(
        PDL_ADC_10_PIN_AN0_PE2 | PDL_ADC_10_PIN_AN1_PE3 | \
        PDL_ADC_10_PIN_AN2_PE4 | PDL_ADC_10_PIN_AN3_PE5 | \
        PDL_ADC_10_PIN_AN4_PE6 | PDL_ADC_10_PIN_AN5_PE7 | \
        PDL_ADC_10_PIN_AN6_PD6 | PDL_ADC_10_PIN_AN7_PD7
    );

    /* Configure ADC unit 0 */
    R_ADC_10_Create(
        0,
        PDL_ADC_10_MODE_ONE_CYCLE_SCAN | PDL_ADC_10_CHANNELS_OPTION_8,
        12E6,
        20E-6,
        ADC0_callback,
        7
    );

    /* Start ADC0 */
    R_ADC_10_Control(
        PDL_ADC_10_0_ON | PDL_ADC_10_CPU_OFF
    );

    /* Shutdown ADC unit 0 */
    R_ADC_10_Destroy(0);

    while(1);
}

void ADC0_callback(void)
{
    /* Fetch the result */
    R_ADC_10_Read(
        0,
        result_adc0
    );
}

```

Figure 5-60: Example of ADC_10

5.23. 12-bit Analog to Digital Converter

Figure 5-61 shows ADC_12 used in single scan mode, with a software trigger and a specified sampling time.

```

/* Peripheral driver function prototypes */
#include "r_pdl_adc_12.h"
#include "r_pdl_cmt.h"
#include "r_pdl_cgc.h"

/* RPDL device-specific definitions */
#include "r_pdl_definitions.h"

/* Array used to read the ADC results */
uint16_t adc_results[21];

void main(void)
{
    /* Initialise the system clocks */
    NOTE: The code to initialise the system clock using R_CGC_Set is omitted here.
    Please refer to 5.1 Clock Generation Circuit.

    /* Configure ADC channels 0,2 and 4 in single scan mode. */
    /* Specify a sampling time */
    /* Use value addition mode on channel 4 */
    R_ADC_12_Create(
        0,
        PDL_ADC_12_CHANNEL_0 | PDL_ADC_12_CHANNEL_2 | PDL_ADC_12_CHANNEL_4,
        PDL_ADC_12_SCAN_SINGLE | PDL_ADC_12_DIV_2 |
        PDL_ADC_12_SAMPLING_TIME_CALCULATE,
        PDL_ADC_12_TRIGGER_SOFTWARE,
        PDL_ADC_12_VALUE_ADD_CHANNEL_4 | PDL_ADC_12_VALUE_ADD_TIME_4,
        3e-6, /* Sampling time 3uS */
        PDL_NO_DATA, /* Sampling time for temperature */
        PDL_NO_FUNC,
        PDL_NO_DATA
    );

    /* Wait 10 ms for the ADC to stabilise */
    R_CMT_CreateOneShot(0, 0, 10E-3, PDL_NO_FUNC, 0);

    /* Start / Trigger the ADC */
    R_ADC_12_Control(PDL_ADC_12_0_ON);

    /* Fetch the results */
    R_ADC_12_Read(0, adc_results);

    while(1);
}

```

Figure 5-61: Example of ADC_12

5.24. 10-bit Digital to Analog Converter

Figure 5-62 shows an example of DAC_10 usage.

```

/* Peripheral driver function prototypes */
#include "r_pdl_dac_10.h"

/* RPD_L device-specific definitions */
#include "r_pdl_definitions.h"

void main(void)
{
    /*-----*/
    /* VREFH = 3.3V                                     */
    /* Expected output voltages are shown in comments */
    /*-----*/

    /* Test align right (default) */
    R_DAC_10_Create(
        PDL_DAC_10_CHANNEL_1,
        0x0,
        0x0          /* 0.0V */
    );

    /* Write new data to both DAC channels */
    R_DAC_10_Write(
        PDL_DAC_10_CHANNEL_1,
        0x0,
        0x200      /* 1.7V */
    );

    /* Shut down both DAC channels */
    R_DAC_10_Destroy(
        PDL_DAC_10_CHANNEL_1
    );

    /* Test align left */
    R_DAC_10_Create(
        PDL_DAC_10_CHANNEL_1 | PDL_DAC_10_ALIGN_LEFT,
        0x0,
        0xffc0 /* 3.3V */
    );

    /* Write new data to both DAC channels */
    R_DAC_10_Write(
        PDL_DAC_10_CHANNEL_1,
        0x0,
        0x8000 /* 1.7V */
    );

    /* Shut down both DAC channels */
    R_DAC_10_Destroy(
        PDL_DAC_10_CHANNEL_1
    );

    while(1);
}

```

Figure 5-62: Example of DAC_10

5.25. Programmable Pulse Generator

Figure 5-63 shows an example Programmable Pulse Generator usage.

```
/* Peripheral driver function prototypes */
#include "r_pdl_ppg.h"

/* RPD_L device-specific definitions */
#include "r_pdl_definitions.h"

void main(void)
{
    /* Configure PPG output PO12, PO13, PO14 & PO15 (group 3) */
    R_PPG_Create(
        PDL_PPG_PO12_PIN_P34 | \
        PDL_PPG_PO13_PIN_P13 | \
        PDL_PPG_PO14_PIN_P16 | \
        PDL_PPG_PO15_PIN_P14,
        PDL_PPG_TRIGGER_MTU0,
        0x15);

    /* Configure PPG outputs PO20 and PO21 (group 5) */
    R_PPG_Create(
        PDL_PPG_PO20_PIN_PA4 | PDL_PPG_PO21_PIN_PA5,
        PDL_PPG_TRIGGER_MTU1 | PDL_PPG_NON_OVERLAP,
        0xA5);

    /* Load the next output values on group 6 */
    R_PPG_Control(
        PDL_PPG_GROUP_6,
        0xA7);

    /* Disable outputs PO20 and PO21 */
    R_PPG_Destroy(PDL_PPG_PO20_PIN_PA4 | PDL_PPG_PO21_PIN_PA5);

    while(1);
}
```

Figure 5-63: Example of PPG

5.26. Temperature Sensor

Figure 5-64: shows an example Temperature Sensor usage.

```

/* Peripheral driver function prototypes */
#include "r_pdl_adc_12.h"
#include "r_pdl_cgc.h"
#include "r_pdl_cmt.h"
#include "r_pdl_ts.h"

/* RPDL device-specific definitions */
#include "r_pdl_definitions.h"

void ADC_callback(void);
unsigned short ts_result;
bool ADC_end;

void main(void)
{
    /* Initialise the system clocks */
    NOTE: The code to initialise the system clock using R_CGC_Set is omitted here.
    Please refer to 5.1 Clock Generation Circuit.

    /* Setup 12 bits ADC for temperature sensor */
    R_ADC_12_Create(
        0,
        0,
        PDL_ADC_12_INPUT_TS | PDL_ADC_12_SAMPLING_TIME_TEMP_CALCULATE | \
        PDL_ADC_12_SCAN_SINGLE | PDL_ADC_12_DATA_ALIGNMENT_RIGHT | \
        PDL_ADC_12_RETAIN_RESULT | PDL_ADC_12_DIV_1,
        PDL_ADC_12_TRIGGER_SOFTWARE,
        PDL_ADC_12_VALUE_ADD_TIME_1,
        PDL_NO_DATA,
        7E-6, /* Temperature sensor sampling time (Seconds)*/
        ADC_callback,
        6
    );

    /*Start up temperature sensor operation*/
    R_TS_Create();

    /* Wait for 30us for stabilization of the reference
    voltage for the temperature sensor. (tTSTBL = 30 us) */
    R_CMT_CreateOneShot(
        0,
        PDL_NO_DATA,
        30E-6,
        PDL_NO_FUNC,
        0
    );

    /* Enable the Temperature Sensor output */
    R_TS_Control(
        PDL_TS_OUTPUT_ENABLE
    );

    /* Start A/D conversion */
    R_ADC_12_ControlAll(
        PDL_ADC_12_0_ON
    );

    /* Reset the variables to value 0 */
    ts_result = 0;
    ADC_end = false;

    /* Waiting for conversion trigger signal */
    while (ADC_end == false);
}

```

```
    /* Put the temperature sensor into power down state */
    R_TS_Destroy();

    /* Shut down ADC channel 0 */
    R_ADC_12_Destroy(0);

    while (1);
}

void ADC_callback(void)
{
    ADC_end = true;

    R_ADC_12_Read(
        0,
        &ts_result
    );
}
```

Figure 5-64: Example of Temperature sensor

5.27. Multi-Function Timer Pulse Unit

Figure 5-65: Show an example of Multi-Function Timer Pulse Unit.

```

/* Peripheral driver function prototypes */
#include "r_pdl_mtu2.h"
#include "r_pdl_cgc.h"

/* RPDFL device-specific definitions */
#include "r_pdl_definitions.h"

R_MTU2_Create_structure create_parameters;
R_MTU2_ControlChannel_structure control_parameter;
R_MTU2_ControlUnit_structure control_unit_para;;

void main(void)
{
    /* Initialise the system clocks */
    NOTE: The code to initialise the system clock using R_CGC_Set is omitted here.
    Please refer to 5.1 Clock Generation Circuit.

    R_MTU2_Set(
        3,
        PDL_MTU2_PIN_3B_PB7 | PDL_MTU2_PIN_3D_PB6,
        PDL_NO_DATA
    );

    R_MTU2_Set(
        4,
        PDL_MTU2_PIN_4A_PA0 | PDL_MTU2_PIN_4C_PB1 | \
        PDL_MTU2_PIN_4B_PD1 | PDL_MTU2_PIN_4D_PD2,
        PDL_NO_DATA
    );

    /* Load the defaults */
    R_MTU2_Create_load_defaults(&create_parameters);

    /* Set the non-default options */
    create_parameters.channel_mode = PDL_MTU2_MODE_NORMAL;
    create_parameters.TGRA_TCNTV_value = 30000;
    create_parameters.TGRB_TCNTW_value = 20000;

    R_MTU2_Create(
        4,
        &create_parameters
    );

    /* Load the defaults */
    R_MTU2_Create_load_defaults(&create_parameters);

    /* Set the non-default options */
    create_parameters.channel_mode = PDL_MTU2_MODE_PWM_RS;
    create_parameters.counter_operation = PDL_MTU2_CLK_PCLK_DIV_64
PDL_MTU2_CLEAR_TGRA;
    create_parameters.TGRA_TCNTV_value = 48000; /* TGRA */
    create_parameters.TGRB_TCNTW_value = 35000; /* TGRB */

    R_MTU2_Create(
        3,
        &create_parameters
    );

    control_unit_para.simultaneous_control = 0;
    control_unit_para.buffer_control = 0;
    control_unit_para.brushless_DC_motor_control = 0;
    control_unit_para.general_control = PDL_MTU2_PWM_RS_COMP_ENABLE;
    control_unit_para.register_selection = 0;
    control_unit_para.output_control = \

```

```
PDL_MTU2_OUT_P_PHASE_3_ENABLE | PDL_MTU2_OUT_N_PHASE_3_ENABLE | \  
PDL_MTU2_OUT_P_PHASE_1_ENABLE | PDL_MTU2_OUT_N_PHASE_1_ENABLE | \  
PDL_MTU2_OUT_P_PHASE_2_ENABLE | PDL_MTU2_OUT_N_PHASE_2_ENABLE | \  
PDL_MTU2_OUT_P_PHASE_ALL_LOW_HIGH;  
  
R_MTU2_ControlUnit(  
    0,  
    &control_unit_para  
);  
  
control_parameter.control_setting = PDL_MTU2_START;  
control_parameter.register_selection = PDL_NO_DATA;  
  
R_MTU2_ControlChannel(  
    3,  
    &control_parameter  
);  
  
while (1);  
}
```

Figure 5-65: Example of Multi-function Timer Pulse Unit

6. RX-specific notes

6.1. Interrupts and processor mode

The RX CPU has two processor modes; supervisor and user.

The API driver functions may be executed by the CPU in either mode.

However, any callback functions which are called by the API interrupt handlers will always be executed by the CPU in supervisor mode.

This means that the privileged CPU instructions (RTFI, RTE and WAIT) can be executed by the callback function and any function that is called by the callback function.

The user must:

1. Avoid using the RTFI and RTE instructions.

These instructions are issued by the API interrupt handlers, so there should be no need for the user's code to use these instructions.

2. Use the wait() intrinsic function with caution.

This instruction is used by some API functions as part of power management, so there should be no need for the user's code to use this instruction.

More information on the processor modes can be found in §1.4 of the RX Family software manual.

6.2. Interrupts and DSP instructions

The accumulator (ACC) register is modified by the following instructions:

- i. DSP (MACHI, MACLO, MULHI, MULLO, MVTACHI, MVTACLO and RACW).
- ii. Multiply and multiply-and-accumulate (EMUL, EMULU, FMUL, MUL, and RMPA)

The accumulator (ACC) register is not pushed onto the stack by the API interrupt handlers.

If DSP instructions are being utilised in the users' code, callback functions which are called by the API interrupt handlers should either

- a) Avoid using instructions which modify the ACC register.
- b) Take a copy of the ACC register and restore it before exiting the callback function.

Revision History	RX63N Group User's Manual
-------------------------	----------------------------------

Rev.	Date	Description	
		Page	Summary
1.00	Jul. 19, 2012	—	First issue.
1.10	May 07, 2013	56 - 62	Rev 1.10 issued. Developed using MCU hardware manual Rev.1.60. CGC: Add RTC initialization options and sub-clock oscillator drive control
		59	R_CGC_Set: Added remark for UCLK, ICLK and pin package support
		59	CGC: Added remark for restriction in PE mode or operating mode transition.
		94	IO_PORT_Set: remove option PDL_IO_PORT_TYPE_HI_Z
		94	IO_PORT: Add remarks: Refer to the hardware manual Table 21.1 for the available pins open drain control setting/ reading/ modification.
		105	R_IO_PORT_Switch: new API added
		125	LPC: Added a remark for operating power control mode and remark for restriction in Program Erase mode or operating mode transition.
		126	R_LPC_Control: No default value for RSTCKCR
		133	R_RWP_GetStatus: Change PDL_NO_DATA to PDL_NO_PTR.
		137 - 139	BSC: Add remark for package restriction
		142	R_BSC_Control: add remark Added remark for restriction in Program Erase mode or operating mode transition.
		159 - 166	EXDMAC: Add remark for package restriction.
		184	R_MTU2_Create: Add description for ADC trigger TRGnBN option.
		190	R_MTU2_Create: Added a remark for setting a value to MTU5.TCNT and MTU5.TGR registers
		227	R_PPG_Create: remark for the alternative modes on each PO pin
		262	R_RTC_Create: remove count source selection option
		271	R_RTC_Control: add PDL_RTC_PERIODIC_8_HZ into data11
		265 – 274	RTC: Add remark for package restriction
		291	R_SCI_Create: Modified the description of data3.
		297	R_SCI_Receive: Added continuous receive mode in data2
287 – 311	SCI: Revise remark for package restriction.		
320	R_IIC_MasterReceive: Add PDL_IIC_10_BIT_SLAVE_ADDRESS for channel configuration parameter [data2]		
337	R_SPI_Transfer: update description for data5		
363	ADC_12: Added remark for package restriction.		
368 – 375	ADC_10: Added remark for package restriction.		
376 – 379	DAC10: Added remark for package restriction.		
384	Updated the CGC usage example.		
413	Updated the POE usage example		
422 - 430	Updated the RTC usage example		
1.11	Sept 18, 2013	2	Add the "1.2. Compiler options when you use this product"
		3	Change 1.3.2 content into "Using RPD_L stand-alone"
		4 - 5	Revise picture: "litle" to "little"
		7	Add content "To use library with debug information, enter "RPDL\RX630_library_debug" as the File path."

Rev.	Date	Description	
		Page	Summary
		11	Add content "In this section, only options which you must change from the default settings are described. If you add RPD_L in existing project, see also "1.2 Compiler options when you use this product"
		14	Add the "11) Using library with debug information"
		18 - 19	Add modules to Control functions summary
1.20	Apr 01, 2014	2	Tool chain requirements: Change "RX Family V.1.02 Release 00" to "RX Family V.1.02 Release 01"
		16	Change description for initialisation of the sub-clock oscillator if not used: " Please refer the program in section 5.15.2 Initialization in case of RTC is not used"
		18	Revise name of module "Port Function" to "Multifunction pin controller".
		25	MCU: Remove RAM support, the description changes to "Controlling the MCU features and on-chip ROM"
		40	RTC: Add "Reconfigure callback function and priority setting of alarm and periodic interrupts at warm start up.
		54	Rename R_TPU_Control and add new R_TPU_ControlUnit into the API List by Peripheral Function
		55	Add new R_RTC_CreateWarm into the API List by Peripheral Function
		58	R_CGC_Set: Revise description of RTC Count source selection and Sub-clock oscillator drive ability
		59	R_CGC_Set: Revise description of the sub-clock oscillator stabilization times.
		61	R_CGC_Set: Revise remarks. <ul style="list-style-type: none"> • Delete remark: If the sub-clock is selected, the Start type status flag will be set to warm (see R_MCU_GetStatus). • Change description: <p>Old : "Call this function once for each clock source that will be used"</p> <p>New: "Call this function once to set the clock frequency for each clock source whether it is used as system clock or RTC count source."</p>
		64	R_CGC_Control: Revise description of RTC initialization control. <ul style="list-style-type: none"> • Add remarks <ol style="list-style-type: none"> a) Make sure PCLKB clock frequency \geq RTC count source clock frequency. b) If main clock oscillator is used as RTC count source, main clock and sub-clock cannot be used as system clock c) When RTC is not to be used, call R_CGC_Control with option PDL_CGC_RTC_NOT_USE after calling this function to configure the RTC count source. R_CGC_Control: Revise remarks: <ul style="list-style-type: none"> • Delete remarks: <ol style="list-style-type: none"> a) If the sub-clock is selected, the Start type status flag will be set to warm (see R_MCU_GetStatus). b) If PDL_CGC_NOT_MAIN_SUB (see R_CGC_Set) is selected, neither main clock nor sub-clock can be chosen as system clock. • Add remarks. <ol style="list-style-type: none"> a) The forced oscillation of the main clock oscillator will be automatically enabled when main clock as RTC count source and

Rev.	Date	Description	
		Page	Summary
			PDL_CGC_RTC_TO_BE_USED is selected in parameter data3.
			b) Do not use option PDL_CGC_MAIN_FORCED_DISABLE or PDL_CGC_MAIN_DISABLE when main clock as RTC count source and PDL_CGC_RTC_TO_BE_USED is selected in parameter data3.
			c) Calling R_RTC_Create after using option PDL_CGC_RTC_TO_BE_USED.
		76	R_INTC_CreateExceptionHandlers: revise example.
		103	R_IO_PORT_Compare: revise example.
		112	R_MCU_Control: a) Remove On-chip RAM control b) Replace remark by "The PDL_MCU_WARM_START is used after the initialization of cold start (caused by a power-on reset) has completed. This is to indicate the next reset processing is warm start (Caused by a reset signal during operation)."
		119	R_LVD_Create: revise example.
		129	R_LPC_Control: Add remark "Before entering software standby or deep software standby mode, do not use option PDL_CGC_MAIN_FORCED_DISABLE in R_CGC_Control if main clock as RTC count source."
		201	R_MTU2_ControlUnit: Add remark for complementary PWM mode. R_MTU2_ControlUnit: Revise program example.
		216	R_TPU_Create: Add PDL_TPU_START/PDL_TPU_STOP.
		221	R_TPU_Create: Add remark for auto start counter.
		223	R_TPU_ControlChannel: Rename function; add description for TRGC, TRGD.
		224	R_TPU_ControlChannel: Rename function in example.
		225	R_TPU_ControlUnit: New added.
		268	R_RTC_Create : • Add remarks: a) This function is called to use RTC after setting option PDL_CGC_RTC_TO_BE_USED in R_CGC_Control at cold start. b) This function is not required when using 48-pin package • Delete remark: Oscillate the clock provided to the RTC before initializing RTC.
		273	R_RTC_Control: • Add remarks: a) This function is called after R_RTC_Create or R_RTC_CreateWarm. b) This function is not required when using 48-pin package c) The RTCIC2 pin is not required when using 64-pin package, specify PDL_NO_DATA for data10
		277	R_RTC_CreateWarm: Add new API
		282	R_IWDT_Set: Add remark: "Call R_CGC_Set to set PCLKB clock frequency >= 4 times IWDTCLK clock frequency after division."
		305	R_SCI_SPI_Transfer: Revise program example.
		369	R_ADC_12_Control: Add remark "Do not select CPU Off unless there is any interrupt to wake up the CPU."
		377	R_ADC_10_Control: Add remark "Do not select CPU Off unless there is any interrupt to wake up the CPU."

Rev.	Date	Description	
		Page	Summary
		387-388	Revise CGC usage example
		425-449	Revise RTC usage example.
		450	Revise IWDT usage example.
		488-496	Revise SPI usage example.
		513-514	Add MTU2 usage example.
1.21	Aug 01, 2014	200	R_MTU2_ControlUnit: Revised from "Compare match clearing control (applies only to complementary PWM modes)." to "Compare match clearing control (applies only to complementary PWM mode 1)."

Renesas Peripheral Driver Library
User's Manual
RX63N Group

Publication Date: Rev.1.21 Aug 01, 2014

Published by: Renesas Electronics Corporation

**SALES OFFICES****Renesas Electronics Corporation**<http://www.renesas.com>Refer to "<http://www.renesas.com/>" for the latest and detailed information.**Renesas Electronics America Inc.**2801 Scott Boulevard Santa Clara, CA 95050-2549, U.S.A.
Tel: +1-408-588-6000, Fax: +1-408-588-6130**Renesas Electronics Canada Limited**1101 Nicholson Road, Newmarket, Ontario L3Y 9C3, Canada
Tel: +1-905-898-5441, Fax: +1-905-898-3220**Renesas Electronics Europe Limited**Dukes Meadow, Millboard Road, Bourne End, Buckinghamshire, SL8 5FH, U.K
Tel: +44-1628-585-100, Fax: +44-1628-585-900**Renesas Electronics Europe GmbH**Arcadiastrasse 10, 40472 Düsseldorf, Germany
Tel: +49-211-6503-0, Fax: +49-211-6503-1327**Renesas Electronics (China) Co., Ltd.**Room 1709, Quantum Plaza, No.27 ZhiChunLu Haidian District, Beijing 100191, P.R.China
Tel: +86-10-8235-1155, Fax: +86-10-8235-7679**Renesas Electronics (Shanghai) Co., Ltd.**Unit 301, Tower A, Central Towers, 555 Langao Road, Putuo District, Shanghai, P. R. China 200333
Tel: +86-21-2226-0888, Fax: +86-21-2226-0999**Renesas Electronics Hong Kong Limited**Unit 1601-1613, 16/F., Tower 2, Grand Century Place, 193 Prince Edward Road West, Mongkok, Kowloon, Hong Kong
Tel: +852-2265-6688, Fax: +852 2886-9022/9044**Renesas Electronics Taiwan Co., Ltd.**13F, No. 363, Fu Shing North Road, Taipei 10543, Taiwan
Tel: +886-2-8175-9600, Fax: +886 2-8175-9670**Renesas Electronics Singapore Pte. Ltd.**80 Bendemeer Road, Unit #06-02 Hyflux Innovation Centre, Singapore 339949
Tel: +65-6213-0200, Fax: +65-6213-0300**Renesas Electronics Malaysia Sdn.Bhd.**Unit 906, Block B, Menara Amcorp, Amcorp Trade Centre, No. 18, Jln Persiaran Barat, 46050 Petaling Jaya, Selangor Darul Ehsan, Malaysia
Tel: +60-3-7955-9390, Fax: +60-3-7955-9510**Renesas Electronics Korea Co., Ltd.**12F., 234 Teheran-ro, Gangnam-Ku, Seoul, 135-920, Korea
Tel: +82-2-558-3737, Fax: +82-2-558-5141

RX63N Group

