

To our customers,

---

## Old Company Name in Catalogs and Other Documents

---

On April 1<sup>st</sup>, 2010, NEC Electronics Corporation merged with Renesas Technology Corporation, and Renesas Electronics Corporation took over all the business of both companies. Therefore, although the old company name remains in this document, it is a valid Renesas Electronics document. We appreciate your understanding.

Renesas Electronics website: <http://www.renesas.com>

April 1<sup>st</sup>, 2010  
Renesas Electronics Corporation

Issued by: Renesas Electronics Corporation (<http://www.renesas.com>)

Send any inquiries to <http://www.renesas.com/inquiry>.

## Notice

1. All information included in this document is current as of the date this document is issued. Such information, however, is subject to change without any prior notice. Before purchasing or using any Renesas Electronics products listed herein, please confirm the latest product information with a Renesas Electronics sales office. Also, please pay regular and careful attention to additional and different information to be disclosed by Renesas Electronics such as that disclosed through our website.
2. Renesas Electronics does not assume any liability for infringement of patents, copyrights, or other intellectual property rights of third parties by or arising from the use of Renesas Electronics products or technical information described in this document. No license, express, implied or otherwise, is granted hereby under any patents, copyrights or other intellectual property rights of Renesas Electronics or others.
3. You should not alter, modify, copy, or otherwise misappropriate any Renesas Electronics product, whether in whole or in part.
4. Descriptions of circuits, software and other related information in this document are provided only to illustrate the operation of semiconductor products and application examples. You are fully responsible for the incorporation of these circuits, software, and information in the design of your equipment. Renesas Electronics assumes no responsibility for any losses incurred by you or third parties arising from the use of these circuits, software, or information.
5. When exporting the products or technology described in this document, you should comply with the applicable export control laws and regulations and follow the procedures required by such laws and regulations. You should not use Renesas Electronics products or the technology described in this document for any purpose relating to military applications or use by the military, including but not limited to the development of weapons of mass destruction. Renesas Electronics products and technology may not be used for or incorporated into any products or systems whose manufacture, use, or sale is prohibited under any applicable domestic or foreign laws or regulations.
6. Renesas Electronics has used reasonable care in preparing the information included in this document, but Renesas Electronics does not warrant that such information is error free. Renesas Electronics assumes no liability whatsoever for any damages incurred by you resulting from errors in or omissions from the information included herein.
7. Renesas Electronics products are classified according to the following three quality grades: “Standard”, “High Quality”, and “Specific”. The recommended applications for each Renesas Electronics product depends on the product’s quality grade, as indicated below. You must check the quality grade of each Renesas Electronics product before using it in a particular application. You may not use any Renesas Electronics product for any application categorized as “Specific” without the prior written consent of Renesas Electronics. Further, you may not use any Renesas Electronics product for any application for which it is not intended without the prior written consent of Renesas Electronics. Renesas Electronics shall not be in any way liable for any damages or losses incurred by you or third parties arising from the use of any Renesas Electronics product for an application categorized as “Specific” or for which the product is not intended where you have failed to obtain the prior written consent of Renesas Electronics. The quality grade of each Renesas Electronics product is “Standard” unless otherwise expressly specified in a Renesas Electronics data sheets or data books, etc.
  - “Standard”: Computers; office equipment; communications equipment; test and measurement equipment; audio and visual equipment; home electronic appliances; machine tools; personal electronic equipment; and industrial robots.
  - “High Quality”: Transportation equipment (automobiles, trains, ships, etc.); traffic control systems; anti-disaster systems; anti-crime systems; safety equipment; and medical equipment not specifically designed for life support.
  - “Specific”: Aircraft; aerospace equipment; submersible repeaters; nuclear reactor control systems; medical equipment or systems for life support (e.g. artificial life support devices or systems), surgical implantations, or healthcare intervention (e.g. excision, etc.), and any other applications or purposes that pose a direct threat to human life.
8. You should use the Renesas Electronics products described in this document within the range specified by Renesas Electronics, especially with respect to the maximum rating, operating supply voltage range, movement power voltage range, heat radiation characteristics, installation and other product characteristics. Renesas Electronics shall have no liability for malfunctions or damages arising out of the use of Renesas Electronics products beyond such specified ranges.
9. Although Renesas Electronics endeavors to improve the quality and reliability of its products, semiconductor products have specific characteristics such as the occurrence of failure at a certain rate and malfunctions under certain use conditions. Further, Renesas Electronics products are not subject to radiation resistance design. Please be sure to implement safety measures to guard them against the possibility of physical injury, and injury or damage caused by fire in the event of the failure of a Renesas Electronics product, such as safety design for hardware and software including but not limited to redundancy, fire control and malfunction prevention, appropriate treatment for aging degradation or any other appropriate measures. Because the evaluation of microcomputer software alone is very difficult, please evaluate the safety of the final products or system manufactured by you.
10. Please contact a Renesas Electronics sales office for details as to environmental matters such as the environmental compatibility of each Renesas Electronics product. Please use Renesas Electronics products in compliance with all applicable laws and regulations that regulate the inclusion or use of controlled substances, including without limitation, the EU RoHS Directive. Renesas Electronics assumes no liability for damages or losses occurring as a result of your noncompliance with applicable laws and regulations.
11. This document may not be reproduced or duplicated, in any form, in whole or in part, without prior written consent of Renesas Electronics.
12. Please contact a Renesas Electronics sales office if you have any questions regarding the information contained in this document or Renesas Electronics products, or if you have any other inquiries.

(Note 1) “Renesas Electronics” as used in this document means Renesas Electronics Corporation and also includes its majority-owned subsidiaries.

(Note 2) “Renesas Electronics product(s)” means any product developed or manufactured by or for Renesas Electronics.

# M16C R8C FoUSB/UART Debugger

User's Manual

RENESAS MICROCOMPUTER Development  
Environment System

M16C Family R8C/Tiny Series

Precautions on Connecting R8C/10, R8C/11,  
R8C/12, R8C/13

Active X, Microsoft, MS-DOS, Visual Basic, Visual C++, Windows and Windows NT are either registered trademarks or trademarks of Microsoft Corporation in the United States and other countries.

IBM and AT are registered trademarks of International Business Machines Corporation.

Intel and Pentium are registered trademarks of Intel Corporation.

Adobe and Acrobat are registered trademarks of Adobe Systems Incorporated.

All other brand and product names are trademarks, registered trademarks or service marks of their respective holders.

#### **Keep safety first in your circuit designs!**

- Renesas Technology Corporation and Renesas Solutions Corporation put the maximum effort into making semiconductor products better and more reliable, but there is always the possibility that trouble may occur with them. Trouble with semiconductors may lead to personal injury, fire or property damage. Remember to give due consideration to safety when making your circuit designs, with appropriate measures such as (i) placement of substitutive, auxiliary circuits, (ii) use of nonflammable material or (iii) prevention against any malfunction or mishap.

#### **Notes regarding these materials**

- These materials are intended as a reference to assist our customers in the selection of the Renesas Technology product best suited to the customer's application; they do not convey any license under any intellectual property rights, or any other rights, belonging to Renesas Technology Corporation, Renesas Solutions Corporation or a third party.
- Renesas Technology Corporation and Renesas Solutions Corporation assume no responsibility for any damage, or infringement of any third-party's rights, originating in the use of any product data, diagrams, charts, programs, algorithms, or circuit application examples contained in these materials.
- All information contained in these materials, including product data, diagrams, charts, programs and algorithms represents information on products at the time of publication of these materials, and are subject to change by Renesas Technology Corporation and Renesas Solutions Corporation without notice due to product improvements or other reasons. It is therefore recommended that customers contact Renesas Technology Corporation, Renesas Solutions Corporation or an authorized Renesas Technology product distributor for the latest product information before purchasing a product listed herein. The information described here may contain technical inaccuracies or typographical errors. Renesas Technology Corporation and Renesas Solutions Corporation assume no responsibility for any damage, liability, or other loss rising from these inaccuracies or errors. Please also pay attention to information published by Renesas Technology Corporation and Renesas Solutions Corporation by various means, including the Renesas home page (<http://www.renesas.com>).
- When using any or all of the information contained in these materials, including product data, diagrams, charts, programs, and algorithms, please be sure to evaluate all information as a total system before making a final decision on the applicability of the information and products. Renesas Technology Corporation and Renesas Solutions Corporation assume no responsibility for any damage, liability or other loss resulting from the information contained herein.
- Renesas Technology semiconductors are not designed or manufactured for use in a device or system that is used under circumstances in which human life is potentially at stake. Please contact Renesas Technology Corporation, Renesas Solutions Corporation or an authorized Renesas Technology product distributor when considering the use of a product contained herein for any specific purposes, such as apparatus or systems for transportation, vehicular, medical, aerospace, nuclear, or undersea repeater use.
- The prior written approval of Renesas Technology Corporation and Renesas Solutions Corporation is necessary to reprint or reproduce in whole or in part these materials.
- If these products or technologies are subject to the Japanese export control restrictions, they must be exported under a license from the Japanese government and cannot be imported into a country other than the approved destination. Any diversion or reexport contrary to the export control laws and regulations of Japan and/or the country of destination is prohibited.
- Please contact Renesas Technology Corporation or Renesas Solutions Corporation for further details on these materials or the products contained therein.

# Table of Contents

1.	Connection with User System.....	4
2.	Prepare M16C R8C FoUSB/UART emulator debugger .....	5
3.	Memory Map When Using R8C UART Debugger .....	17
4.	Occupied Area for Monitor Program .....	18
5.	Precautions on Using R8C UART Debugger.....	18
5.1.	When changing the communication speed and restarting the R8C UART debugger after the R8C UART debugger ends.....	18
5.2.	ID code of user program .....	18
5.3.	Area in which user program can be downloaded.....	18
5.4.	Frequency characteristics .....	19
5.5.	Limitations on SFR operation.....	20
5.6.	Limitations on stop mode or wait mode .....	20
5.7.	Watchdog timer .....	20
5.8.	Real-time operation of user program .....	21
5.9.	Exceptional step execution .....	22
5.10.	Limitations on peripheral functions.....	23
5.11.	Limitations on flag register .....	23
5.12.	Operation on peripheral I/O during break.....	23

# 1. Connection with User System

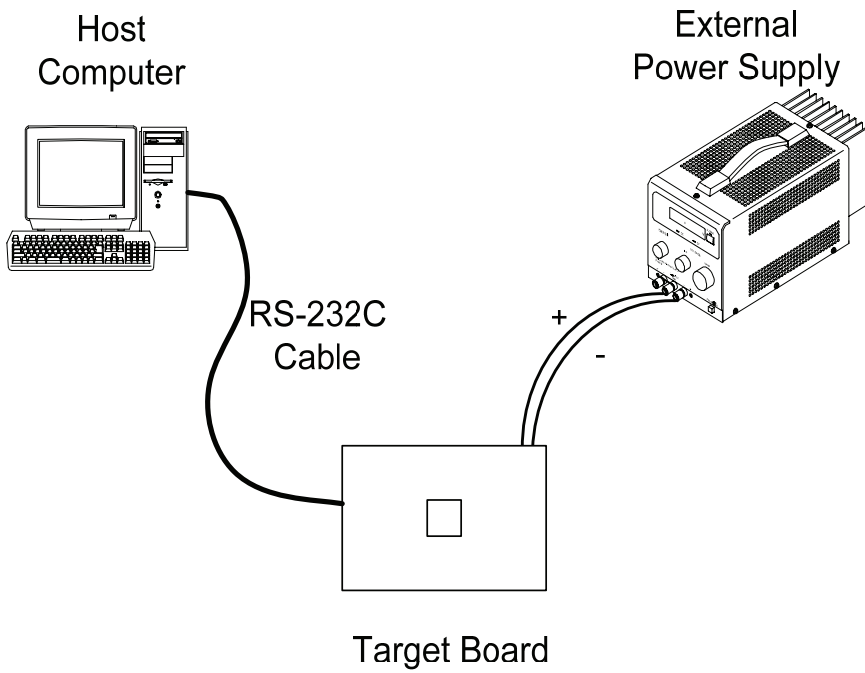

Figure 1 Connection Example with User System

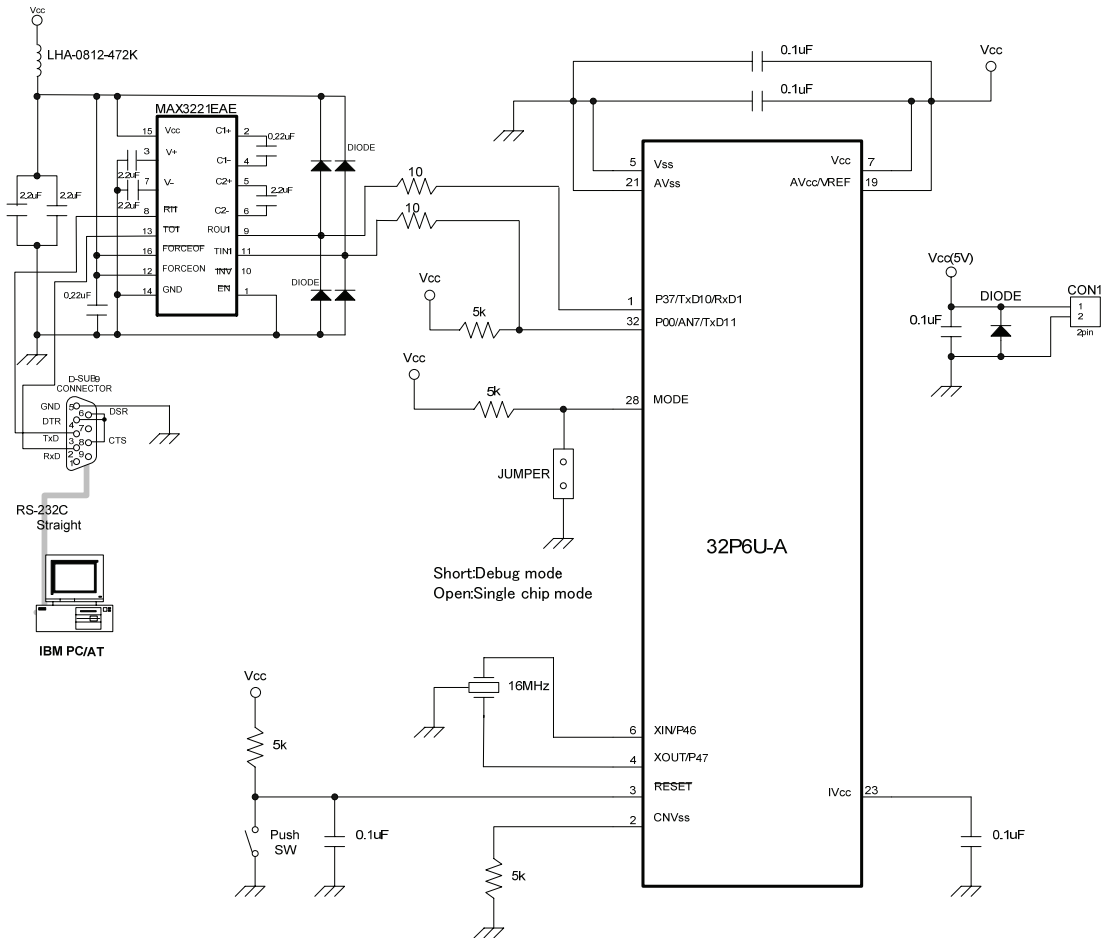

Figure 2 Circuit Example with RS-232C Cable

## 2. Prepare M16C R8C FoUSB/UART debugger

In the M16C R8C FoUSB/UART debugger (R8C UART debugger), connecting a PC and the target with the RS-232C can perform debugging.

It is not necessary to prepare a monitor program for a user since it is bundled when installing the “M16C R8C FoUSB/UART debugger”

As for the R8C/Tiny, the monitor program is automatically programmed when starting the R8C UART debugger. It is not necessary to program the monitor program with the M16C FlashStarter, etc. in advance.

- a) Start the High-performance Embedded Workshop. When clicking “Start”, “Program”, “Renesas”, “High-performance Embedded Workshop” and “High-performance Embedded Workshop”, “Welcome!” dialog is displayed.

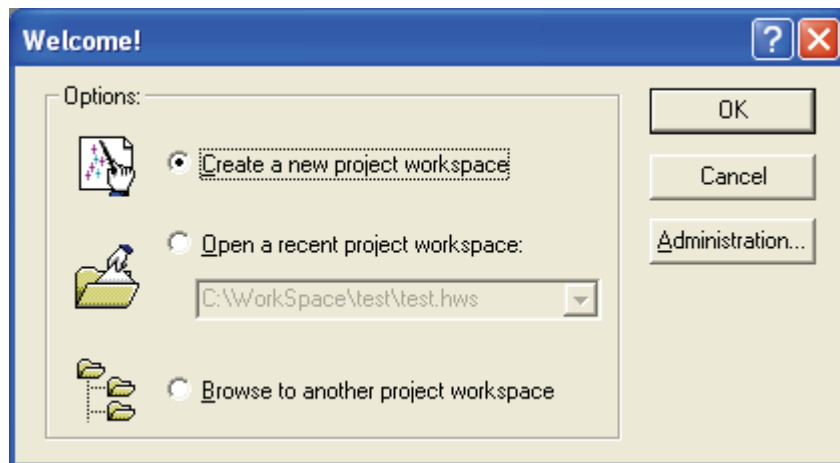

- [Create a new project work space]  
Select when creating a new workspace.
- [Open a recent project workspace]  
Select when using the existing workspace.  
Display a history in an open workspace.
- [Browse to another project workspace]  
Select when using the existing workspace  
This button is used when the open history does not remain.

When selecting the existing workspace and pushing the [OK] button, the screen of s) is displayed.

b) Select [Create a new project workspace] radio button. Push the [OK] button.

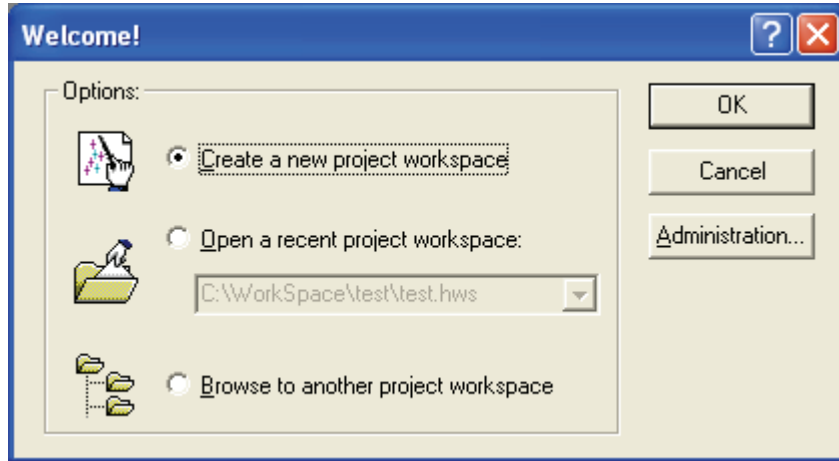

c) The Project Generator starts. When a tool chain is installed, the following screen is open.

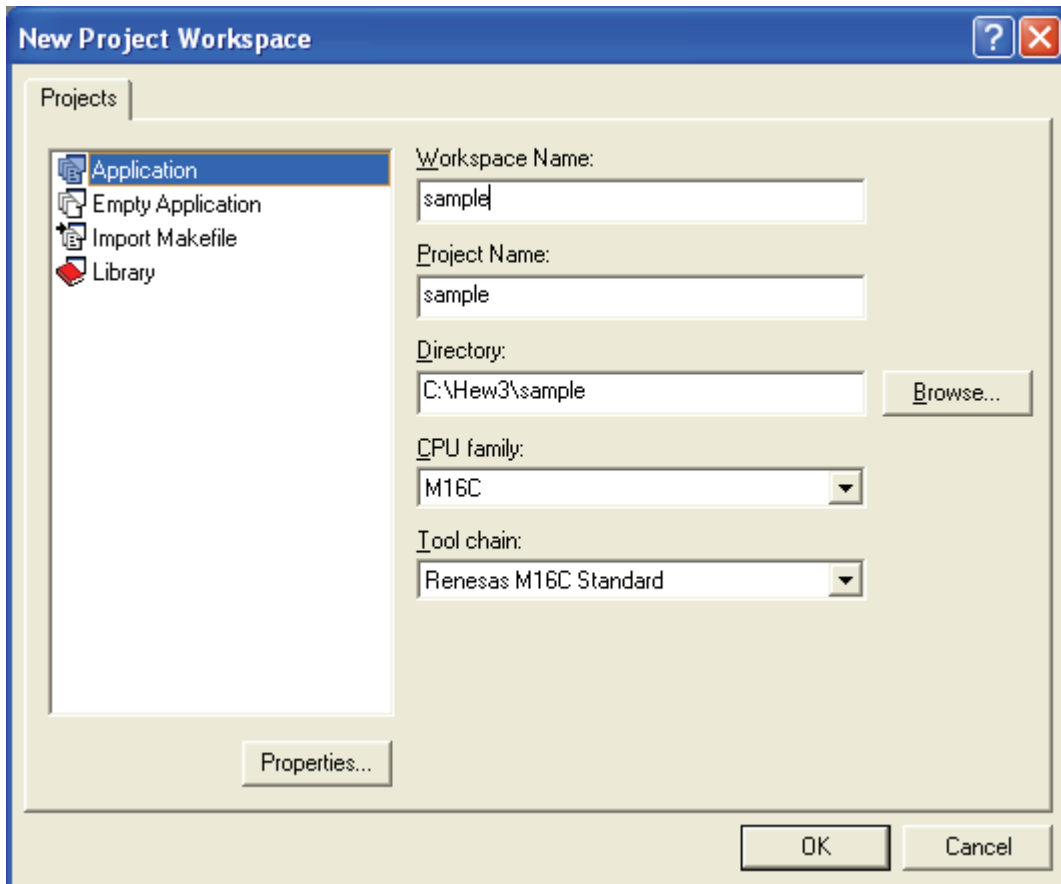

- [Workspace name]  
Apply the workspace name newly made. "Sample" is applied as an example
- [Project name]  
If the user wants to change the project name, apply the project name.
- [CPU type]  
Select the applicable CPU type.



- [Tool chain]  
When using the tool chain, select the applicable tool chain name. When the tool chain is not used, select [None].
- [Project type]  
Select a project type that wants to be used.

d) Next, set the tool chain.

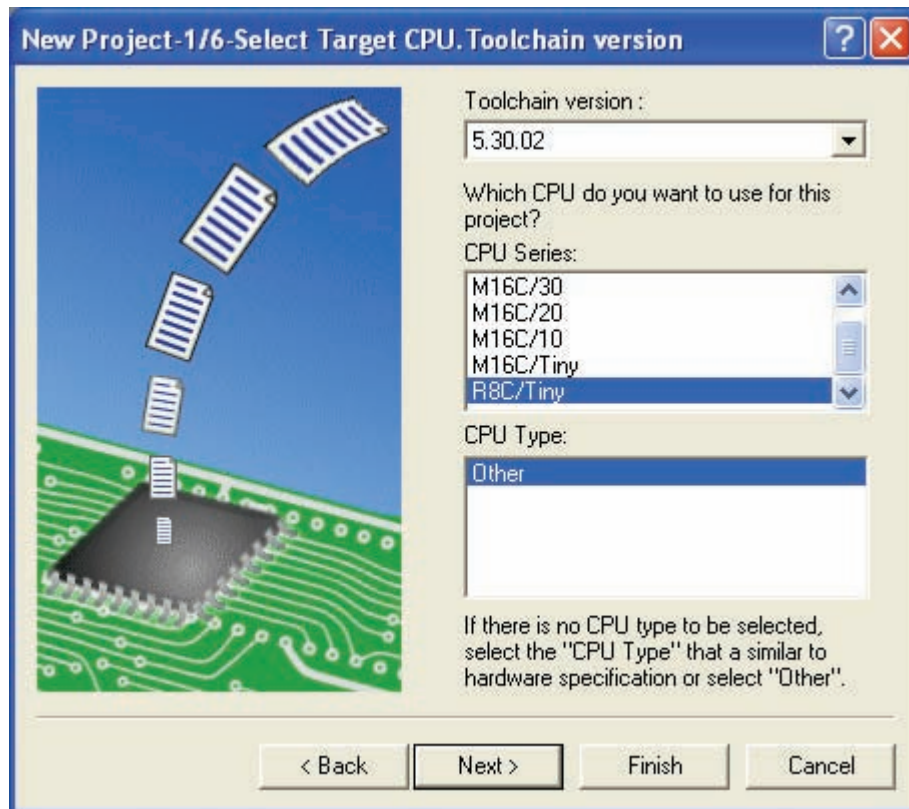

Select the tool chain version and CPU series to be used, and push the [Next] button.

e) Next, set the RTOS.

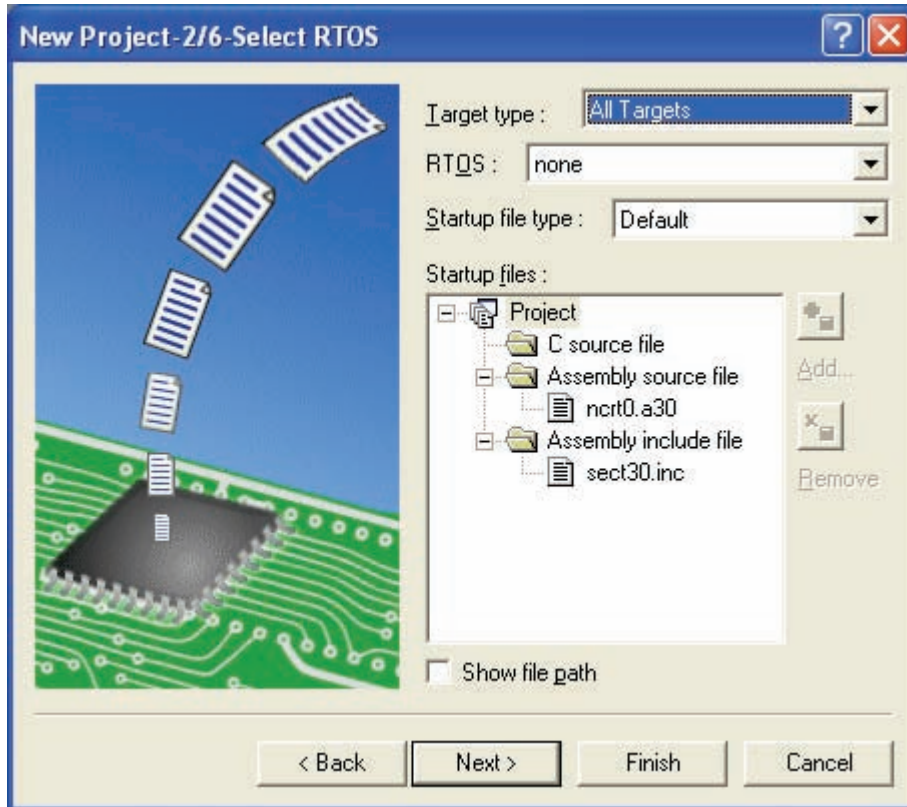

Select the RTOS and startup file type to be used, and push the "Next" button.

f) Next, set the heap area, etc.

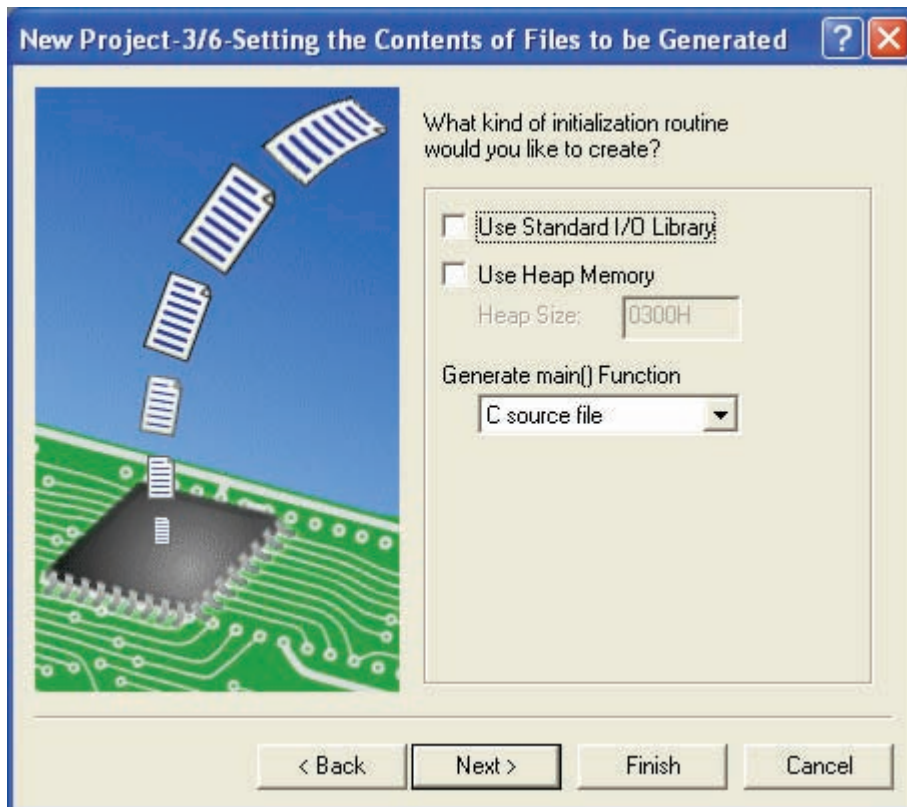

Set the heap size, etc. to be used and push the [Next] button.

g) Next, set the stack area.

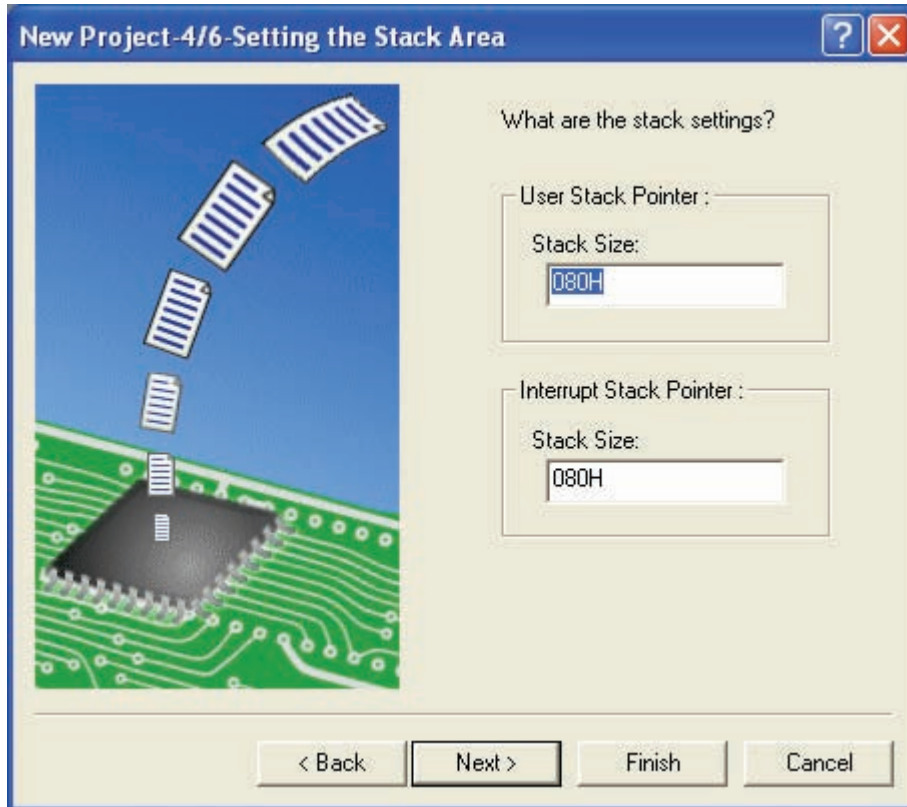

Set the stack size and push the [Next] button.

h) When the setting of the tool chain ends, the following screen is displayed.

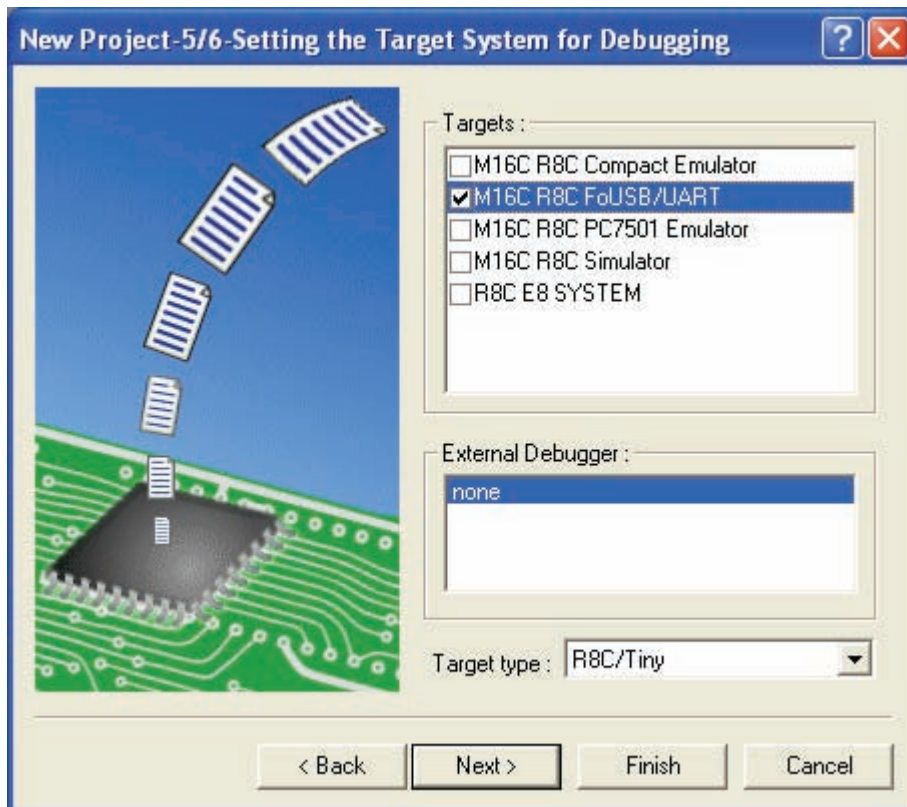

Check the M16C R8C FoUSB/UART here and push the [Next] button.  
If necessary, check other products.

- i) Next, set the configuration file name.

Configurations are the build option settings (e.g., output of debug information or optimization) having their own names. The term "configuration" can also be referred to as "build configuration".

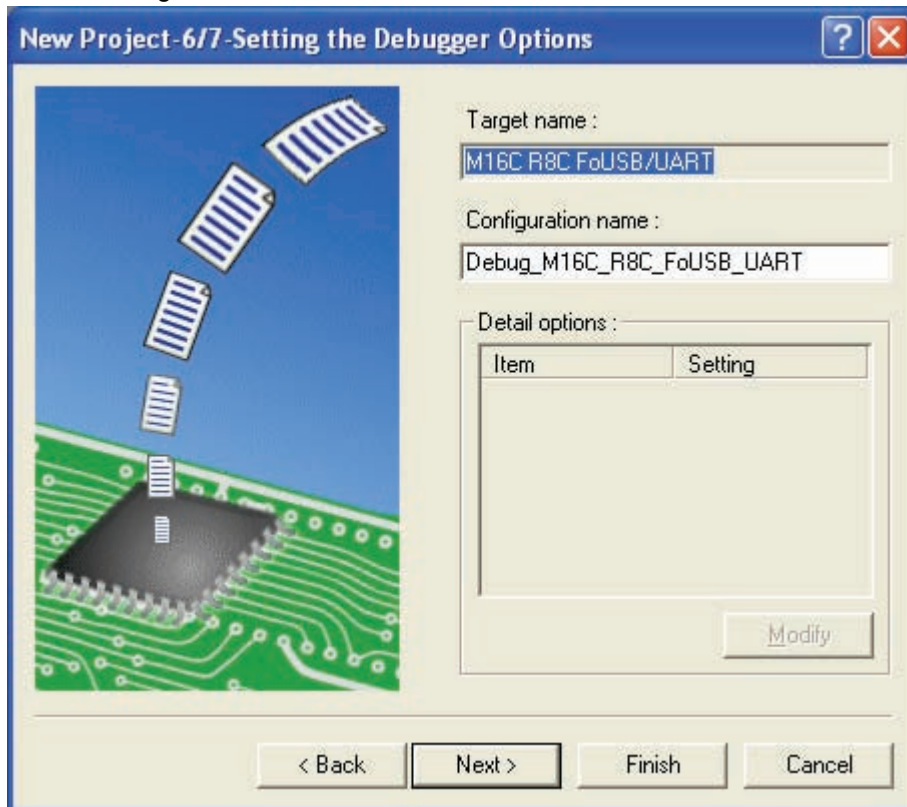

- j) Finally, check the file name to be generated.

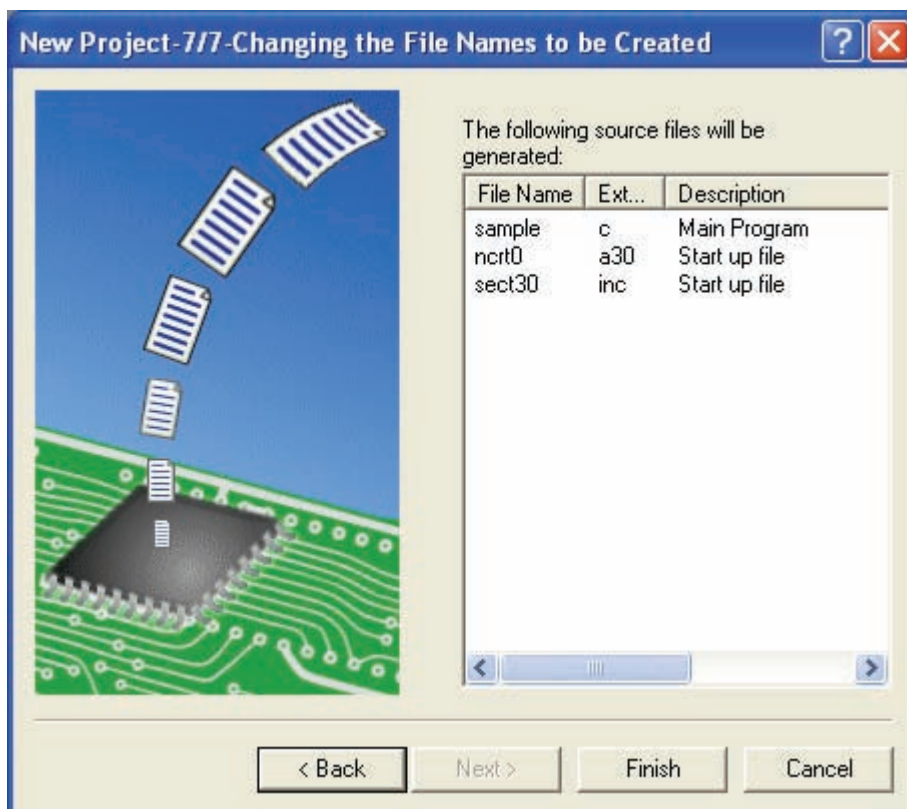

- k) The above settings display the file which the High-performance Embedded Workshop generates. When pushing the [OK] button, High-performance Embedded Workshop starts.

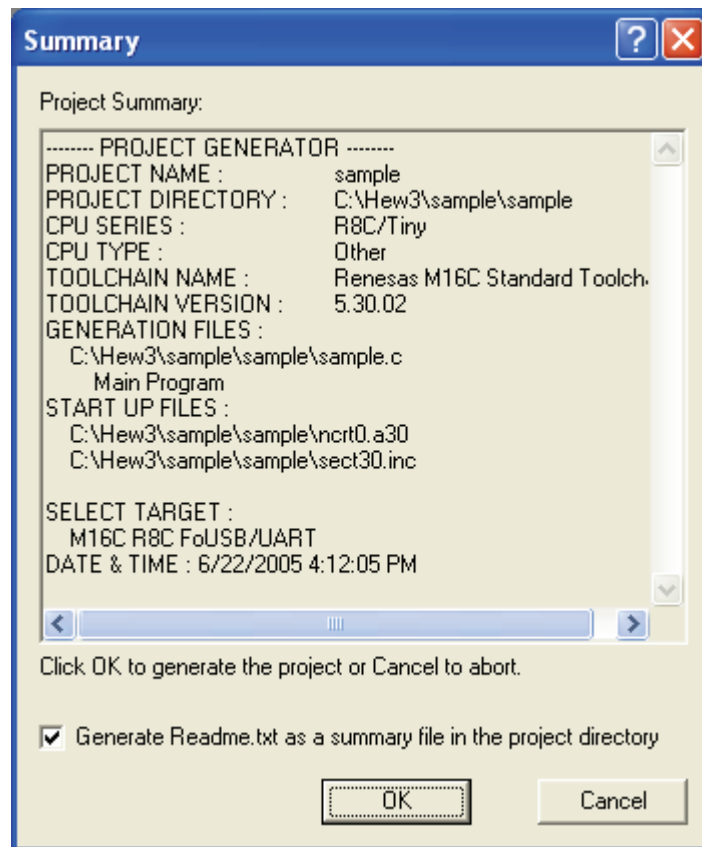

l) When double-clicking the source program, an editor starts and can be edited.

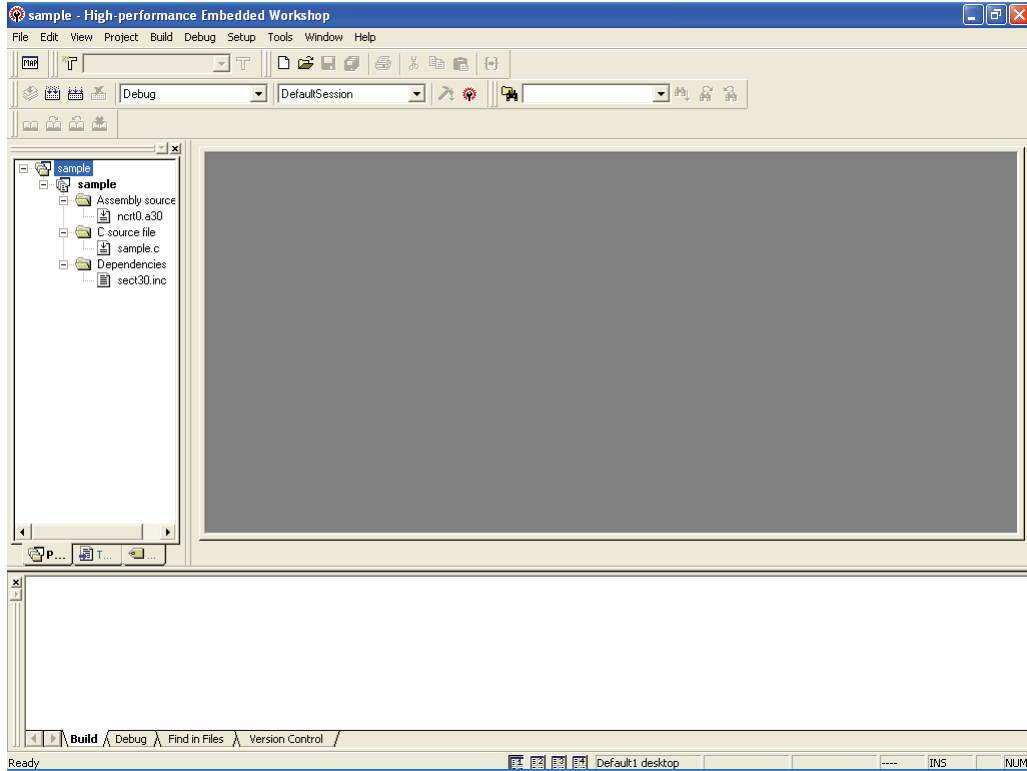

m) Clicking “Build”, and “Build” or “Build All” can build after creating a program.

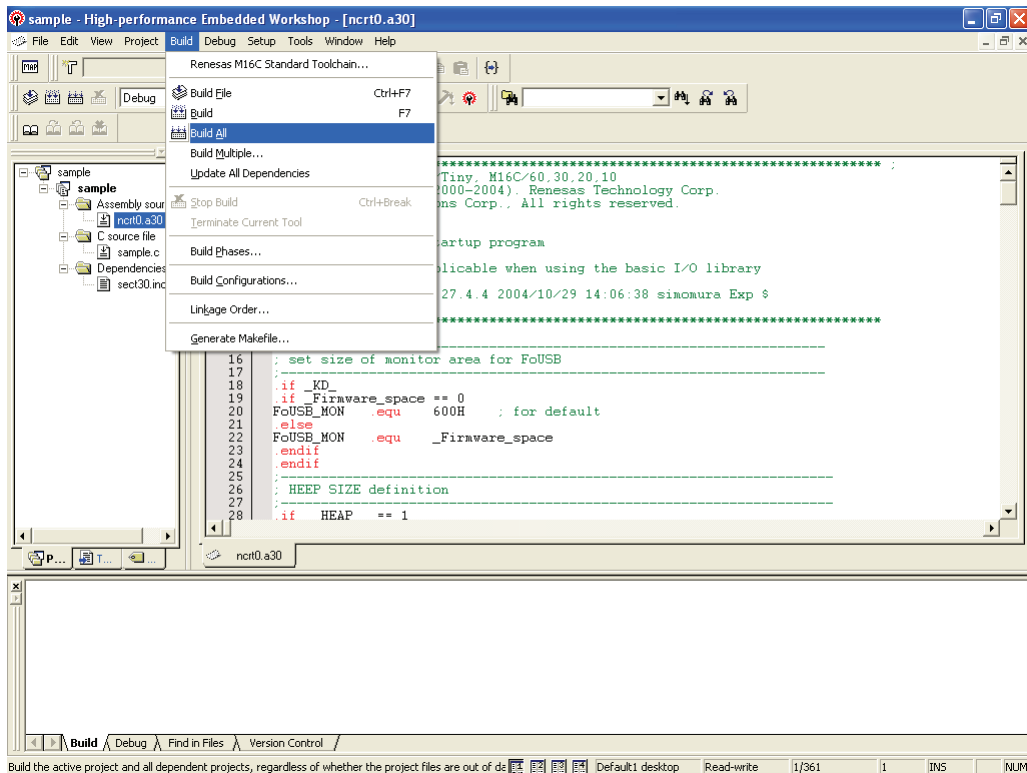

n) The result of a build is displayed.

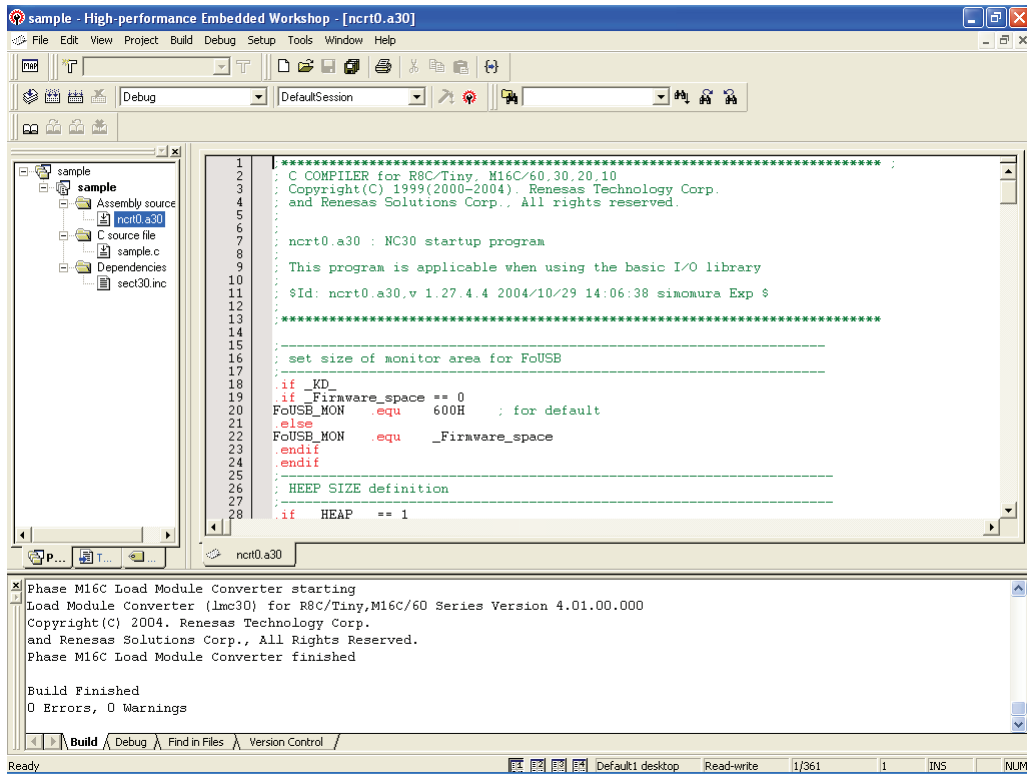

o) Next, connect with the target. Switching to the registered session file in which the setting uses the R8C UART debugger in advance can connect simply.

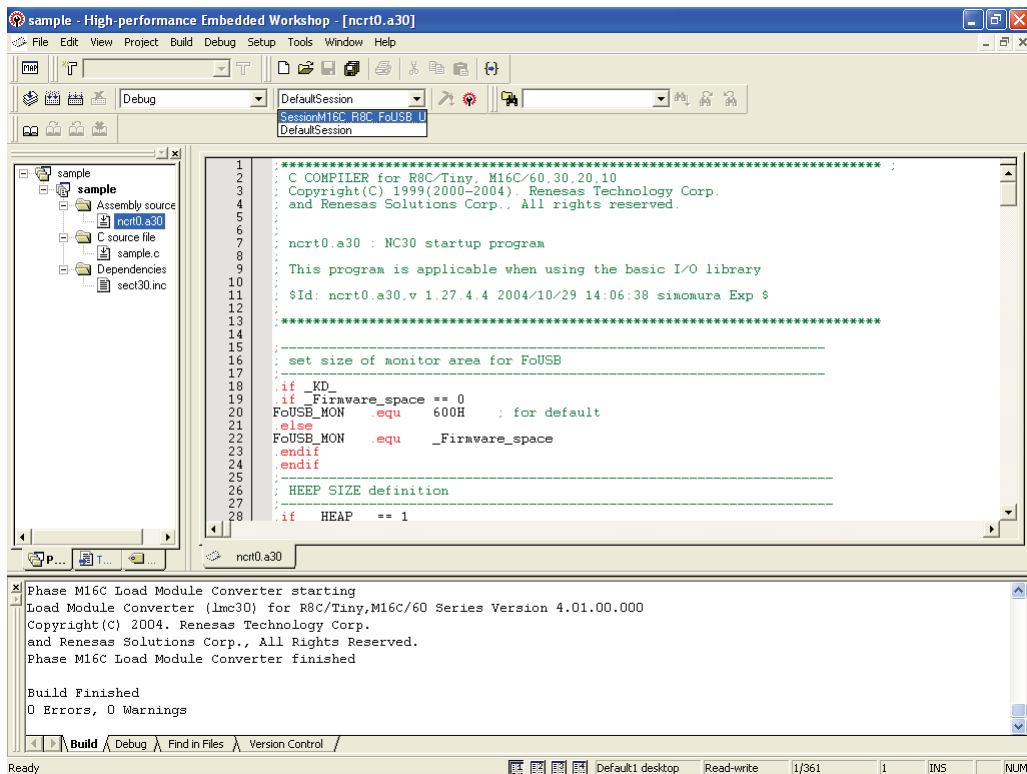

p) The Init screen is displayed. Select [Serial] radio button and push [Reference] button.

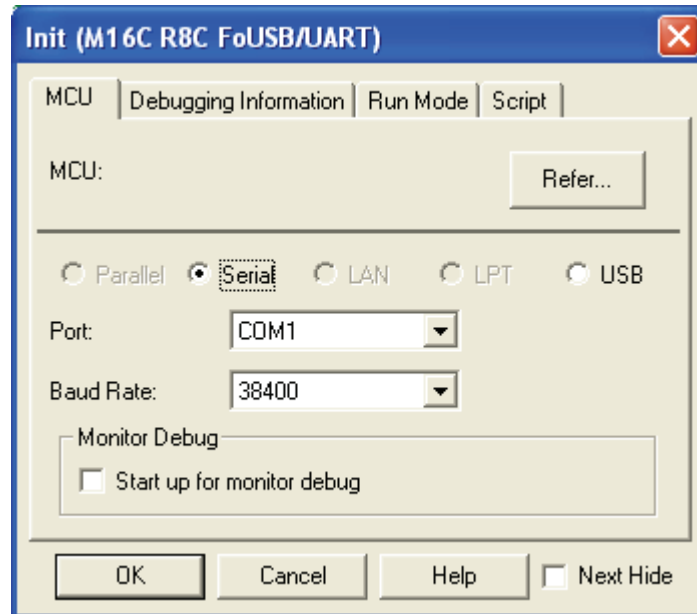

q) Select the "R8C-Tiny Series".

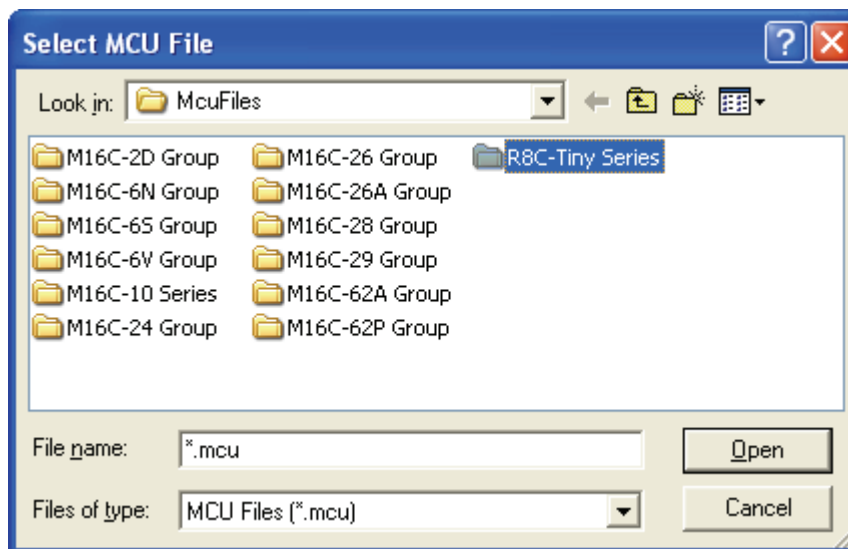

r) Select an MCU file.

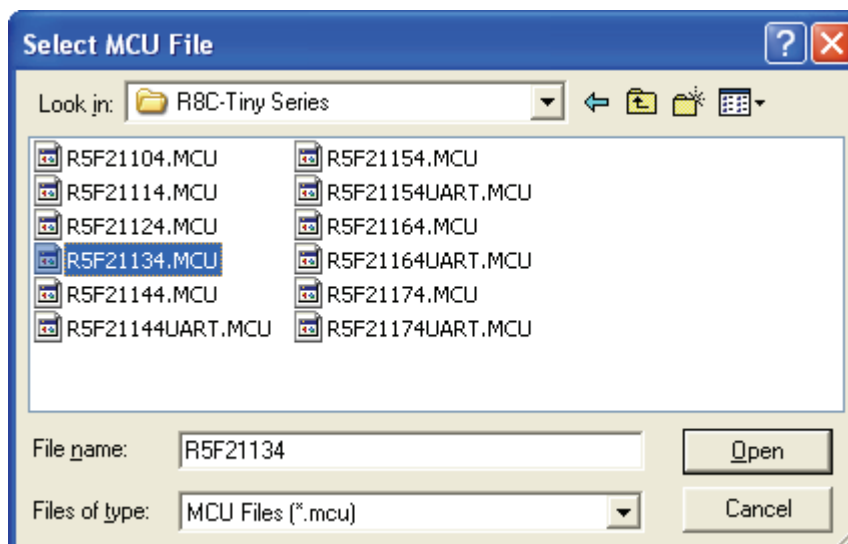



s) When pushing “OK”, a monitor program is downloaded.

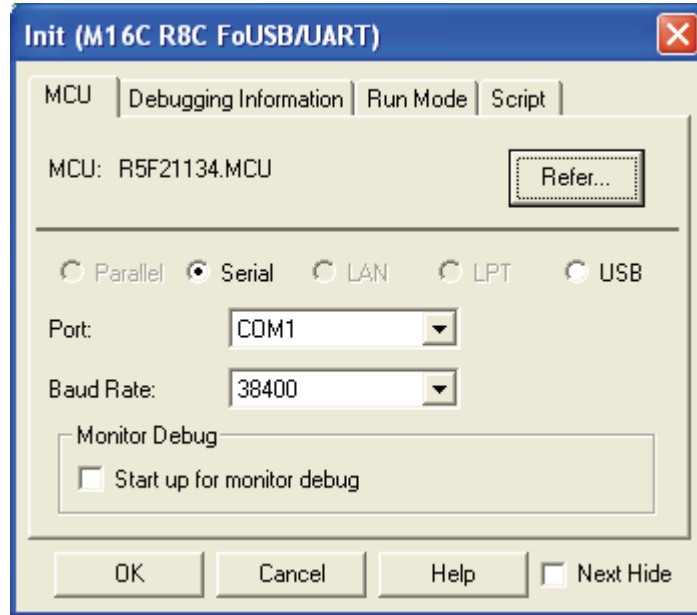

t) Download a user program with “Debug”, “Download” and “Download File (X30 file)”.

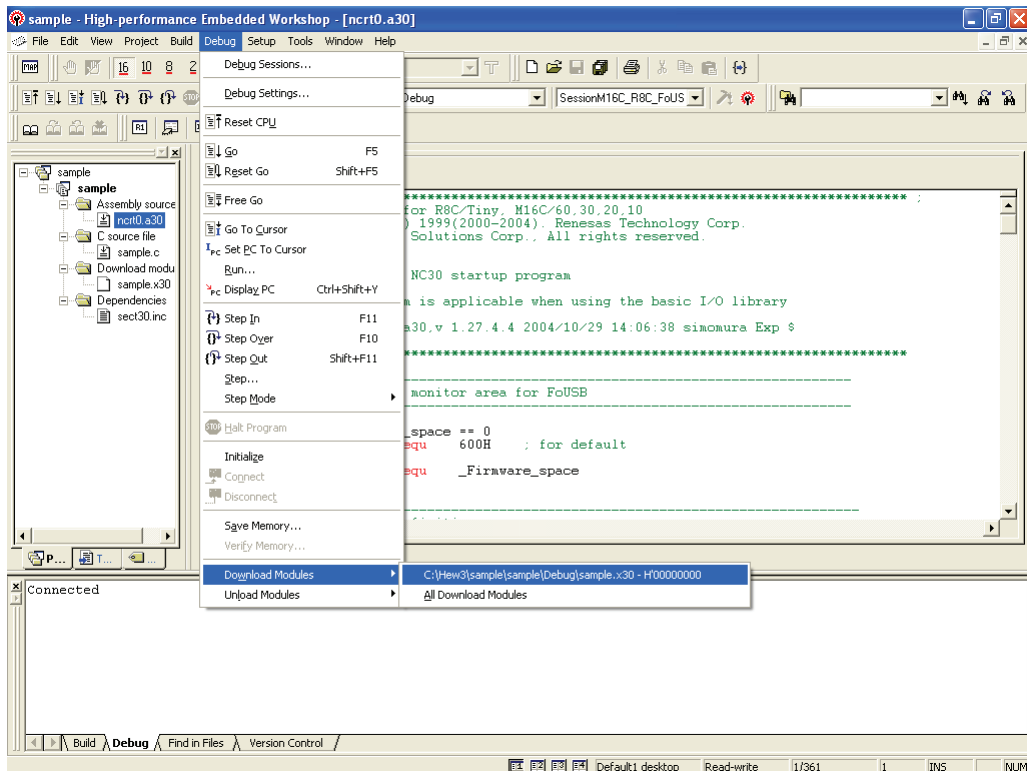

u) Clicking “Debug” and “Reset CPU” resets the user program.

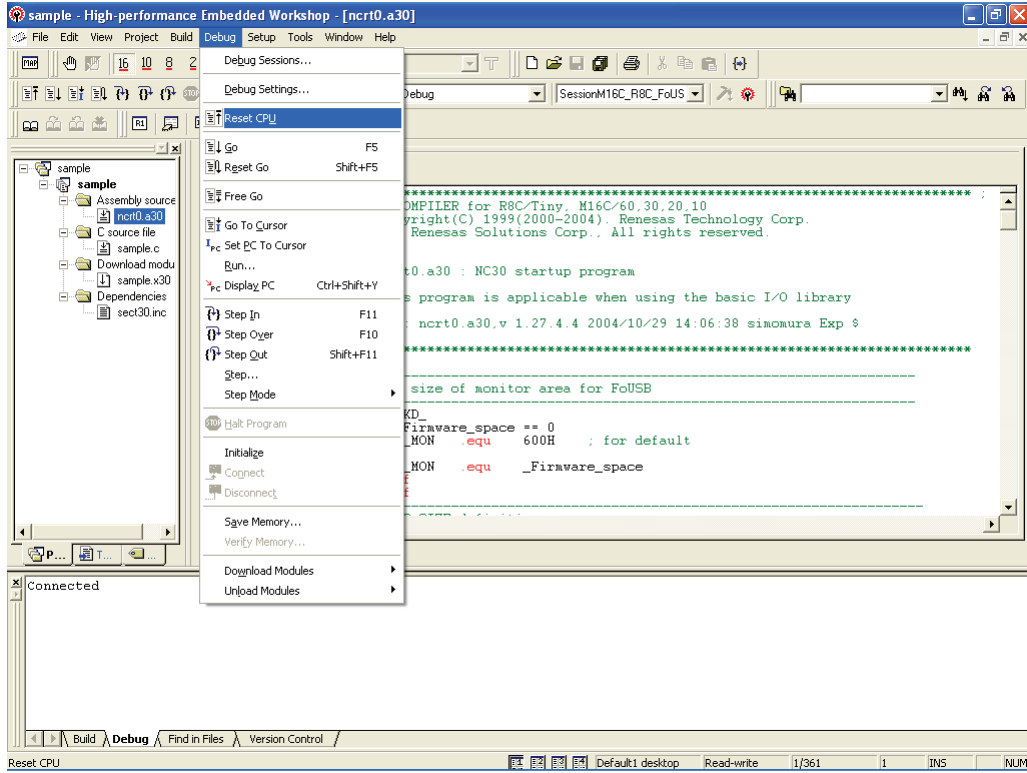

v) A cursor moves to the top of the user program and a debug can start.

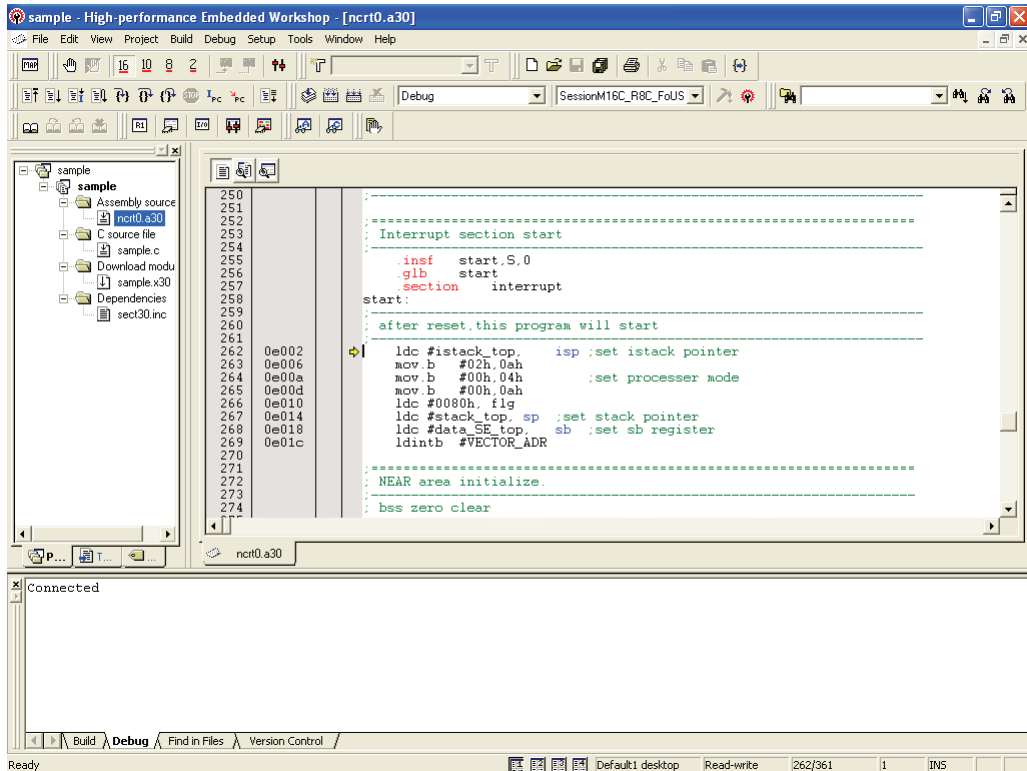

### 3. Memory Map When Using R8C UART Debugger

Figure 3 shows the Memory Map of R8C/Tiny On-chip Flash Memory

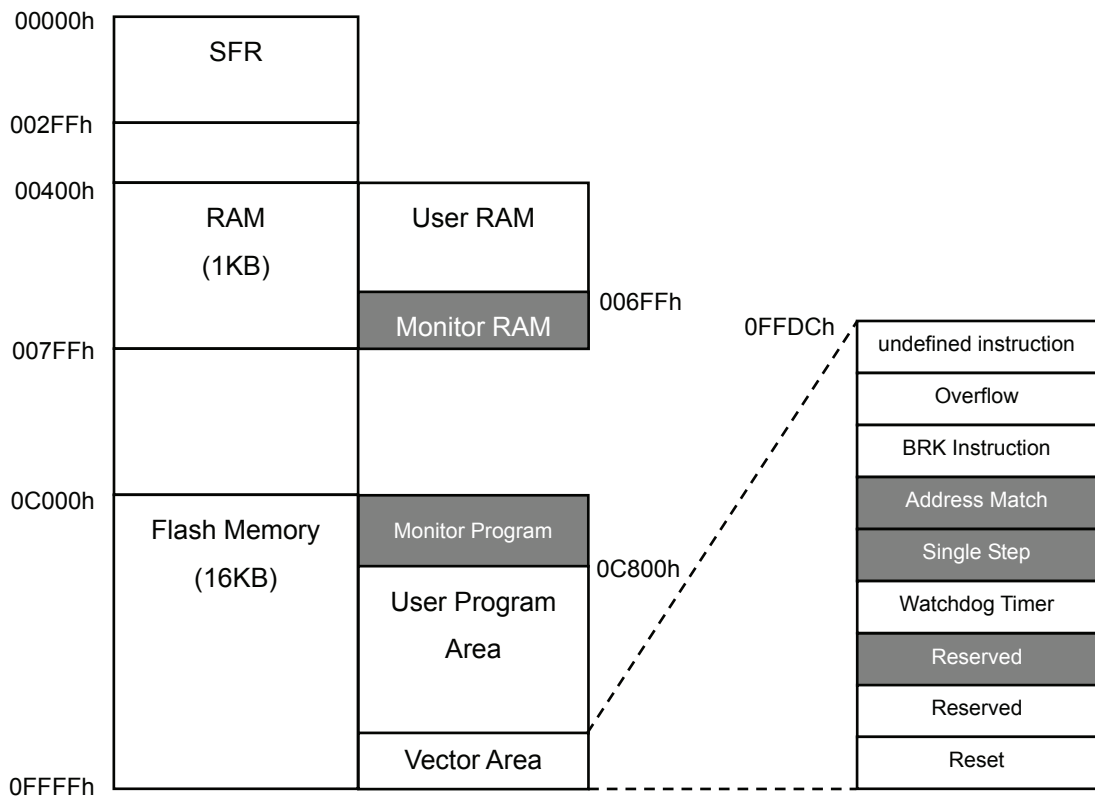

NOTES :  are occupied areas for the monitor program

**Figure 3 Memory Map of R8C/Tiny**

## 4. Occupied Area for Monitor Program

**Table 1 Occupied Area for Monitor Program**

ROM / RAM	Occupied Area for Monitor Program	
8KB / 512B	Vector	FFE8h to FFEbH, FFECh to FFEFh, FFF4h to FFF7h
12KB / 768B	RAM Vector	6FFh FFE8h to FFEbH, FFECh to FFEFh, FFF4h to FFF7h
16KB / 1KB	RAM Flash memory Vector	6FFh to 7FFh C000h to C7FFh FFE8h to FFEbH, FFECh to FFEFh, FFF4h to FFF7h

## 5. Precautions on Using R8C UART Debugger

### 5.1. When changing the communication speed and restarting the R8C UART debugger after the R8C UART debugger ends.

The target MCU holds the baud rate value after the R8C UART debugger ends. Therefore, when changing the communication speed and restarting the R8C UART debugger, a communication error occurs. (The R8C UART debugger can be started when using the previous communication speed). When changing the communication speed, turn off the target power and turn on the power again.

### 5.2. ID code of user program

Set the ID code of the user program to **all FFh** when using the R8C UART debugger.

**Table 2 Storing Address of ID Code (R8C/10 Group)**

Address	ID No.	Vector Table
0FFDFh – 0FFDCh	ID1	Undefined Instruction
0FFE3h – 0FFE0h	ID2	Overflow
0FFE7h – 0FFE4h		BRK Instruction
0FFEBh – 0FFE8h	ID3	Address Match
0FFEfH – 0FFECh	ID4	Single Step
0FFF3h – 0FFF0h	ID5	Watchdog Timer, Oscillation Stop Detection
0FFF7h – 0FFF4h	ID6	Reserved
0FFFBh – 0FFF8h	ID7	Reserved
0FFFFh – 0FFFCh	(NOTES 1)	Reset

#### NOTES

1. Refer to the hardware manual for the value set in 0FFFFh.

### 5.3. Area in which user program can be downloaded

As shown in Figure 3, a part of RAM or Flash Memory is used for the monitor program when using the R8C UART debugger. The R8C UART debugger does not download the user program in the area which overlaps with a monitor program when a user program overlaps with a monitor program. Note that the R8C UART debugger does not perform an error output at this time.

## 5.4. Frequency characteristics

The monitor program operates in the range of the main clock (Xin) frequency which is shown below. Use an oscillator which has this range of the frequency since the monitor program may not operate with the frequency other than the following.

1MHz (Min.) to 20MHz (Max.)

Table 3 lists each frequency and communication available speed. However, note that operation may not be performed when dividing the main clock and using it with 1MHz or below even in the range of frequency shown above.

**Table 3 Communication Available Speed of Each Frequency**

Frequency	Communication Speed (bps)					
	1200	2400	4800	9600	19200	38400
20MHz	N/A	N/A	√	√	√	√
16MHz	N/A	N/A	√	√	√	√
14MHz	N/A	N/A	√	√	√	√
12MHz	N/A	N/A	√	√	√	√
10MHz	N/A	√	√	√	√	√
8MHz	N/A	√	√	√	√	√
6MHz	N/A	√	√	√	√	√
4MHz	√	√	√	√	√	N/A
2MHz	√	√	√	√	N/A	N/A
1MHz	√	√	√	N/A	N/A	N/A

√ : Communication available

N/A : Communication not available

### NOTES:

A communication may not be performed depending on the conditions of temperature or voltage. In this case, use the R8C UART debugger with the lowered communication speed.

## 5.5. Limitations on SFR operation

Table 4 lists the limitations on a register operation. Also, the monitor program does not operate properly when the register to which the change is disabled is changed.

**Table 4 Limitations on SFR Operation**

Register	Default Value	Limitation	Change
Processor Mode Register 0	Reset to 00h	Single-chip mode only	*
Processor Mode Register 1	Reset to 01h	—————	√
System Clock Control Register 0	Reset to 08h	Set the CM05 bit to "0".	*
System Clock Control Register 1	Reset to 28h	Set the CM13, CM15 bit to "1".	*
High-Speed On-Chip Oscillator Control Register 0	Reset to 03h	—————	√
High-Speed On-Chip Oscillator Control Register 1	Reset to 7Fh	—————	√
Oscillation Stop Detection Register	Reset to 00h	—————	N/A
Protect Register	—————	—————	√
Flag Register	—————	Writing to the D flag is ignored Do not set to "1".	*
ISP (Interrupt Stack Pointer)	Reset to 05FFh	Set the value of 06FFh or below. 06FFh to 07FFh are used for the monitor program..	*
UART1 Transmit/Receive Mode Register	15h	Do not change.	N/A
UART1 Bit Rate Register	—————		
UART1 Transmit/Receive Control Register 0	00h		
UART1 Transmit/Receive Control Register 1	07h		
UART1 Transmit/Receive Control Register 2	22h		
UART1 Transmit Buffer Register	—————	Do not write data to this register	N/A
UART1 Receive Buffer Register	—————	Do not read this register.	N/A

√: Possible to change N/A: Disable to change \*: Possible to change (Limitations in part)

## 5.6. Limitations on stop mode or wait mode

When using stop mode or wait mode on a user program, start the R8C UART debugger in free-run mode, and close a RAM window, C watch window and an ASM window in advance. Also, do not operate the R8C UART debugger until the program stops at the break point by setting the break point after exiting stop mode or wait mode.

## 5.7. Watchdog timer

The R8C UART debugger does not support a watchdog timer. When debugging it with the R8C UART debugger, do not use a watchdog timer.

## 5.8. Real-time operation of user program

- Sampling Run (Sampling) Mode

In sampling mode, the execution status of the user program will be monitored regularly when executing Go and Come. Therefore, the stop of the user program by a break can be detected. Select this mode when performing normal debug.

- Free Run (free run) mode

In free fun mode, the execution status of the user program will not be monitored when executing Go and Come. The stop of the user program by a break cannot be detected although real-time operation of the user program can be kept. Therefore, even the user program stops, the R8C UART debugger does not stop executing Go and Come. Push the STOP button to stop the R8C UART debugger.

### NOTES:

In free run mode, use the R8C UART debugger while the RAM window, C watch window and ASM window are closed.

## 5.9. Exceptional step execution

- Software interrupt instruction

The step execution cannot be performed continuously for the instruction internal process of the instructions (undefined instruction, overflow, BRK instruction and INT instruction) which generate the software interrupts.

Example) INT instruction

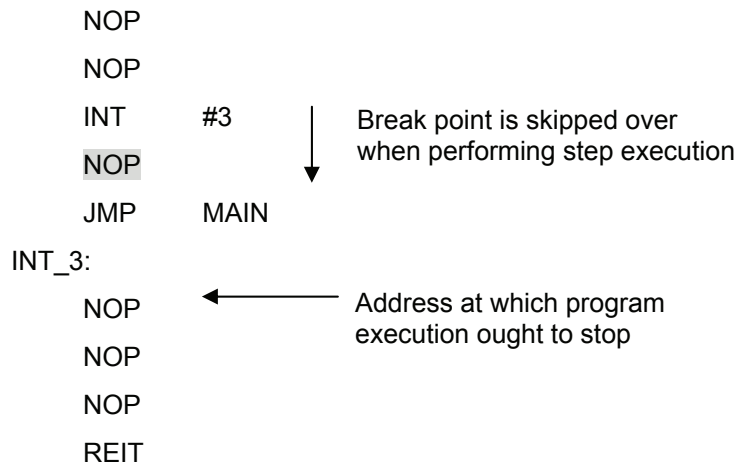

- INT instruction

Set the software break for the INT instruction internal process and use the Go command to debug the program using the INT instruction.

Example)

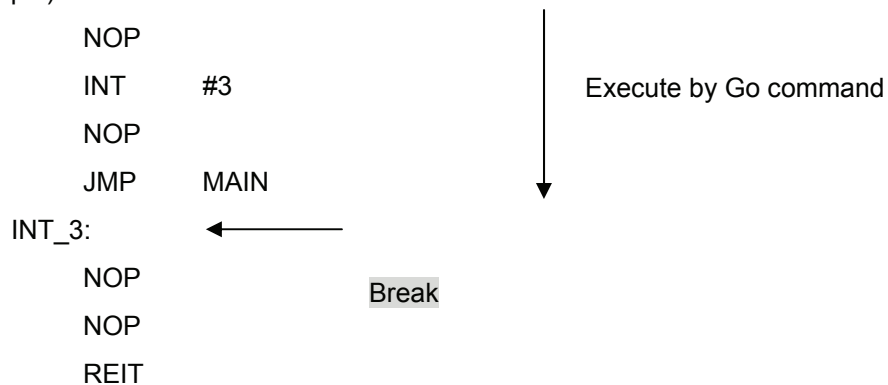



## 5.10. Limitations on peripheral functions

The UART1 is used for a communication with the monitor program and a host computer. Do not use the UART1 in the user program.

Also, the following pins are used for a communication with the host computer. Do not connect with other pins.

- R8C/10-13 Groups

TxD11 (32pin), RxD1 (1pin)

## 5.11. Limitations on flag register

When operating the flag register on the user program, execute the FSET instruction and FCLR instruction not to change the debug flag (D flag).

## 5.12. Operation on peripheral I/O during break

Although an interrupt cannot be acknowledged during a break, the peripheral I/O continues operating. For example, when stopping the user program by a break after operating a timer, the timer continues counting, but the timer interrupt cannot be acknowledge.

[Memo]

---

M16C R8C FoUSB/ART Debugger User's Manual  
Precautions on Connecting R8C/10, R8C/11, R8C/12, R8C/13

Publication Date      Rev.2.00 Jan. 16, 2006

Published by:        Sales Strategic Planning Div.  
                          Renesas Technology Corp.

Edited by:            Renesas Solutions Corp.

# M16C R8C FoUSB/UART Debugger User's Manual



Renesas Electronics Corporation

1753, Shimonumabe, Nakahara-ku, Kawasaki-shi, Kanagawa 211-8668 Japan

REJ10J1018-0200