

To our customers,

---

## Old Company Name in Catalogs and Other Documents

---

On April 1<sup>st</sup>, 2010, NEC Electronics Corporation merged with Renesas Technology Corporation, and Renesas Electronics Corporation took over all the business of both companies. Therefore, although the old company name remains in this document, it is a valid Renesas Electronics document. We appreciate your understanding.

Renesas Electronics website: <http://www.renesas.com>

April 1<sup>st</sup>, 2010  
Renesas Electronics Corporation

Issued by: Renesas Electronics Corporation (<http://www.renesas.com>)

Send any inquiries to <http://www.renesas.com/inquiry>.

## Notice

1. All information included in this document is current as of the date this document is issued. Such information, however, is subject to change without any prior notice. Before purchasing or using any Renesas Electronics products listed herein, please confirm the latest product information with a Renesas Electronics sales office. Also, please pay regular and careful attention to additional and different information to be disclosed by Renesas Electronics such as that disclosed through our website.
2. Renesas Electronics does not assume any liability for infringement of patents, copyrights, or other intellectual property rights of third parties by or arising from the use of Renesas Electronics products or technical information described in this document. No license, express, implied or otherwise, is granted hereby under any patents, copyrights or other intellectual property rights of Renesas Electronics or others.
3. You should not alter, modify, copy, or otherwise misappropriate any Renesas Electronics product, whether in whole or in part.
4. Descriptions of circuits, software and other related information in this document are provided only to illustrate the operation of semiconductor products and application examples. You are fully responsible for the incorporation of these circuits, software, and information in the design of your equipment. Renesas Electronics assumes no responsibility for any losses incurred by you or third parties arising from the use of these circuits, software, or information.
5. When exporting the products or technology described in this document, you should comply with the applicable export control laws and regulations and follow the procedures required by such laws and regulations. You should not use Renesas Electronics products or the technology described in this document for any purpose relating to military applications or use by the military, including but not limited to the development of weapons of mass destruction. Renesas Electronics products and technology may not be used for or incorporated into any products or systems whose manufacture, use, or sale is prohibited under any applicable domestic or foreign laws or regulations.
6. Renesas Electronics has used reasonable care in preparing the information included in this document, but Renesas Electronics does not warrant that such information is error free. Renesas Electronics assumes no liability whatsoever for any damages incurred by you resulting from errors in or omissions from the information included herein.
7. Renesas Electronics products are classified according to the following three quality grades: “Standard”, “High Quality”, and “Specific”. The recommended applications for each Renesas Electronics product depends on the product’s quality grade, as indicated below. You must check the quality grade of each Renesas Electronics product before using it in a particular application. You may not use any Renesas Electronics product for any application categorized as “Specific” without the prior written consent of Renesas Electronics. Further, you may not use any Renesas Electronics product for any application for which it is not intended without the prior written consent of Renesas Electronics. Renesas Electronics shall not be in any way liable for any damages or losses incurred by you or third parties arising from the use of any Renesas Electronics product for an application categorized as “Specific” or for which the product is not intended where you have failed to obtain the prior written consent of Renesas Electronics. The quality grade of each Renesas Electronics product is “Standard” unless otherwise expressly specified in a Renesas Electronics data sheets or data books, etc.
  - “Standard”: Computers; office equipment; communications equipment; test and measurement equipment; audio and visual equipment; home electronic appliances; machine tools; personal electronic equipment; and industrial robots.
  - “High Quality”: Transportation equipment (automobiles, trains, ships, etc.); traffic control systems; anti-disaster systems; anti-crime systems; safety equipment; and medical equipment not specifically designed for life support.
  - “Specific”: Aircraft; aerospace equipment; submersible repeaters; nuclear reactor control systems; medical equipment or systems for life support (e.g. artificial life support devices or systems), surgical implantations, or healthcare intervention (e.g. excision, etc.), and any other applications or purposes that pose a direct threat to human life.
8. You should use the Renesas Electronics products described in this document within the range specified by Renesas Electronics, especially with respect to the maximum rating, operating supply voltage range, movement power voltage range, heat radiation characteristics, installation and other product characteristics. Renesas Electronics shall have no liability for malfunctions or damages arising out of the use of Renesas Electronics products beyond such specified ranges.
9. Although Renesas Electronics endeavors to improve the quality and reliability of its products, semiconductor products have specific characteristics such as the occurrence of failure at a certain rate and malfunctions under certain use conditions. Further, Renesas Electronics products are not subject to radiation resistance design. Please be sure to implement safety measures to guard them against the possibility of physical injury, and injury or damage caused by fire in the event of the failure of a Renesas Electronics product, such as safety design for hardware and software including but not limited to redundancy, fire control and malfunction prevention, appropriate treatment for aging degradation or any other appropriate measures. Because the evaluation of microcomputer software alone is very difficult, please evaluate the safety of the final products or system manufactured by you.
10. Please contact a Renesas Electronics sales office for details as to environmental matters such as the environmental compatibility of each Renesas Electronics product. Please use Renesas Electronics products in compliance with all applicable laws and regulations that regulate the inclusion or use of controlled substances, including without limitation, the EU RoHS Directive. Renesas Electronics assumes no liability for damages or losses occurring as a result of your noncompliance with applicable laws and regulations.
11. This document may not be reproduced or duplicated, in any form, in whole or in part, without prior written consent of Renesas Electronics.
12. Please contact a Renesas Electronics sales office if you have any questions regarding the information contained in this document or Renesas Electronics products, or if you have any other inquiries.

(Note 1) “Renesas Electronics” as used in this document means Renesas Electronics Corporation and also includes its majority-owned subsidiaries.

(Note 2) “Renesas Electronics product(s)” means any product developed or manufactured by or for Renesas Electronics.

**User's Manual**



# **LCE-K0S Low-Cost Emulator**

**Getting Started**

---

No part of this document may be copied or reproduced in any form or by any means without the prior written consent of NEC Electronics Inc. (NECEL). The information in this document is subject to change without notice. All devices sold by NECEL are covered by the provisions appearing in NECEL's Terms and Conditions of Sales only, including the limitation of liability, warranty, and patent provisions. NECEL makes no warranty, express, statutory, implied or by description, regarding information set forth herein or regarding the freedom of the described devices from patent infringement. NECEL assumes no responsibility for any errors that may appear in this document. NECEL makes no commitments to update or to keep current information contained in this document. The devices listed in this document are not suitable for use in applications such as, but not limited to, aircraft control systems, aerospace equipment, submarine cables, nuclear reactor control systems and life support systems. "Standard" quality grade devices are recommended for computers, office equipment, communication equipment, test and measurement equipment, machine tools, industrial robots, audio and visual equipment, and other consumer products. For automotive and transportation equipment, traffic control systems, anti-disaster and anti-crime systems, it is recommended that the customer contact the responsible NECEL salesperson to determine the reliability requirements for any such application and any cost added. NECEL does not recommend or approve use of any of its products in life support devices or systems or in any application where failure could result in injury or death. If customers wish to use NECEL devices in applications not intended by NECEL, customers must contact the responsible NECEL salespeople to determine NECEL's willingness to support a given application.

# **LCE-K0S Low-Cost Emulator**

**Getting Started User's Manual**



## Contents

---

<b>Introduction</b> .....	<b>1-1</b>
Shipping Contents .....	1-2
Motherboard .....	1-2
Power Adapter .....	1-4
Parallel Cable .....	1-4
Daughterboard .....	1-5
Ribbon Cable .....	1-5
Optional Accessories .....	1-6
Emulation Probe .....	1-6
Flash Adapter .....	1-6
<b>Hardware Assembly</b> .....	<b>2-1</b>
Changing the Jumper Settings .....	2-1
Default Settings .....	2-1
Other Settings .....	2-1
Connecting the Boards .....	2-2
Establishing Communication .....	2-4
<b>Software Installation</b> .....	<b>3-1</b>
Obtaining a Password .....	3-1
Installing the Software .....	3-1
Removing Software .....	3-7
<b>Operation</b> .....	<b>4-1</b>
Downloading a Load Module File .....	4-2
Setting a Breakpoint .....	4-4
Viewing the Trace Window .....	4-5
Saving a Project .....	4-6
Opening a Project .....	4-7
<b>Flash Programming</b> .....	<b>5-1</b>
<b>Troubleshooting</b> .....	<b>6-1</b>
<b>Functional Description</b> .....	<b>7-1</b>





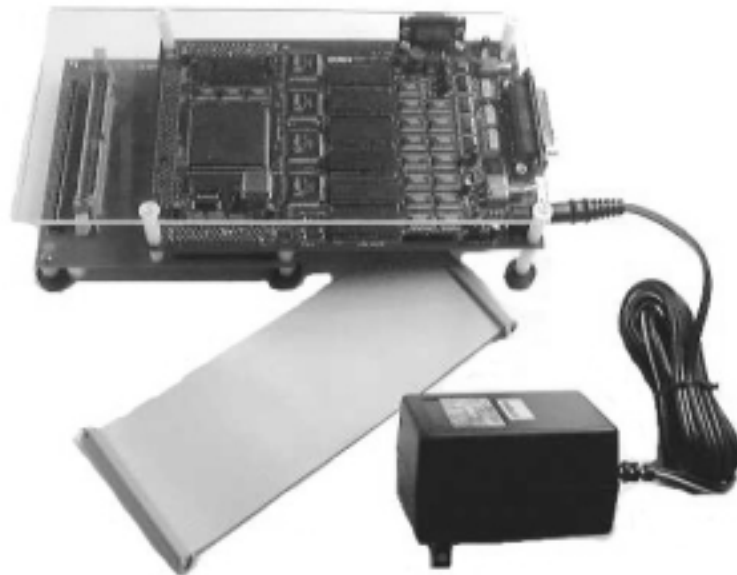
# Introduction 1

---

NEC's K0S Low-Cost Emulator (LCE-K0S) is an economical and comprehensive emulation system for developing embedded systems based on NEC's K0S microcontrollers. The LCE-K0S supports most conventional in-circuit emulation functions and is also a flash programmer for K0S microcontrollers with flash memory (Figure1-1).

The LCE-K0S consists of a motherboard (LCE-78K0S) that provides base functions for emulation and a daughterboard (LCE-789xxx-EM) that provides family-specific emulation functions. The LCE-K0S uses a Microsoft® Windows®-based integrated debugger and interfaces to a personal computer via a printer or parallel port.

**Figure 1-1. LCE-K0S**



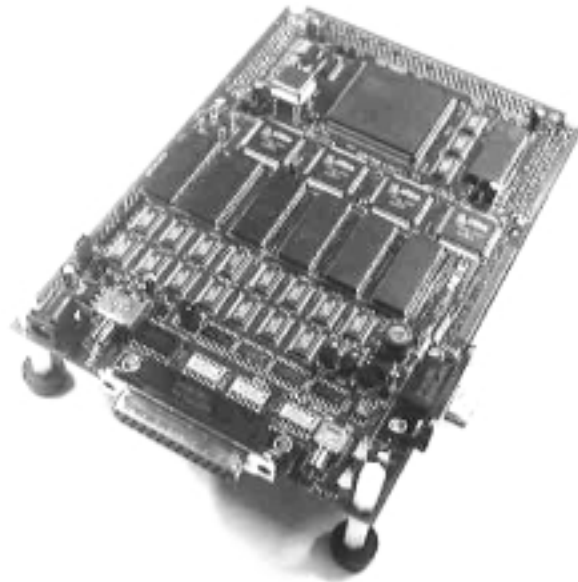
### Shipping Contents

- ❑ **Motherboard Package**
  - Motherboard
  - 110V AC power adapter
  - *Getting Started* Manual (document no. 50889)
  - DB25 straight-through cable
  - ID78K0S-LCE User's Manual (document no. 50888-1)
- ❑ **Daughterboard Package**
  - Daughterboard
  - One or two ribbon cables
  - CD-ROM containing software and documentation
  - Daughterboard user's manual
- ❑ **Optional Accessories**
  - Emulation probe
  - Flash adapter

### Motherboard

The main platform board, the *motherboard*, provides functions common to all K0S microcontrollers, as well as flash programming circuitry and tracing capability (Figure1-2). A clear plastic cover on top of the system protects it from fluid spills.

**Figure 1-2. Motherboard**

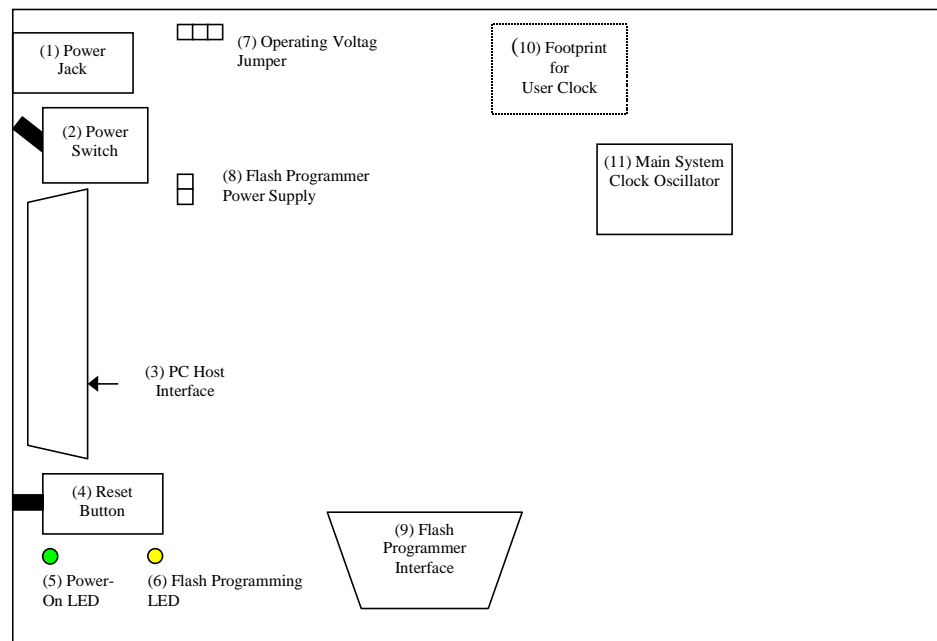


The motherboard is designed with the components described in Table 1-1. Each component is numbered to correspond with its location in Figure 1-3.

**Table 1-1. Motherboard Components**

Location	Item	Description
1	Power jack	Connects the power adapter
2	Power switch	Turns on/off power to the LCE
3	25-pin connector	Connects a straight-through cable from the LCE to host PC
4	Reset button	Hardware resets the LCE
5	Green power LED	Indicates that power is being supplied to the LCE
6	Yellow LED	Indicates the presence of the VPP signal during flash programming
7	3-pin male header, JP1	Sets the operating voltage for the LCE
8	2-pin male header, JP2	Enables or disables power (VPP) for flash programming
9	DB9 connecto	Connects a flash adapter (sold separately) or a cable to perform on-board flash programming (cable included with flash adapter)
10	U35 footprint	Reserved for user-installed crystal oscillator
11	40 MHz clock oscillato	Main system clock

**Figure 1-3. Top View of the Motherboard (Component Side)**



## Power Adapter

The main power supply for the LCE-K0S is a 110V AC power adapter that generates +5 volts (Figure 1-4). It does not provide power to the user target.

**Figure 1-4. Power Adapter**



## Parallel Cable

The parallel cable is a 25-pin straight-through cable that connects the LCE-K0S to the host computer via a parallel port (Figure 1-5).

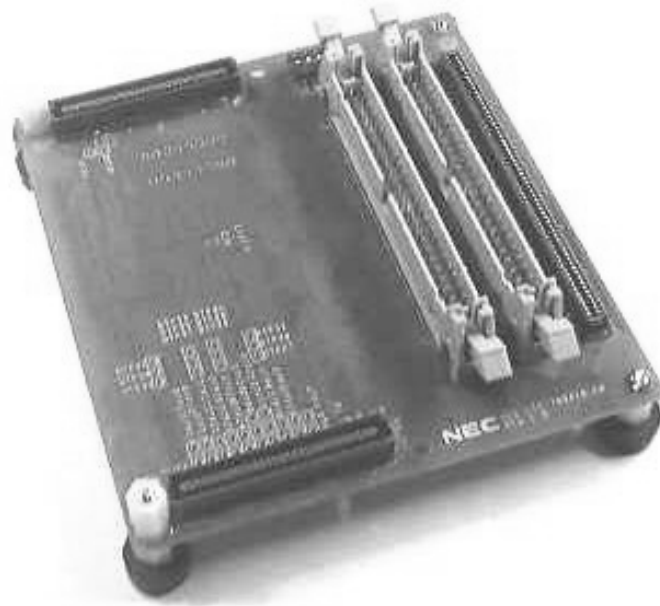
**Figure 1-5. Parallel Cable**



### Daughterboard

The daughterboard connects to the bottom of the motherboard and provides peripheral functionality for a specific subseries of K0S microcontrollers (Figure 1-6).

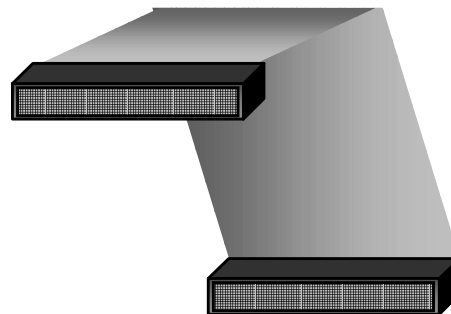
**Figure 1-6. Daughterboard**



### Ribbon Cable

The ribbon cable is a 50-pin female-to-female cable that connects the LCE-K0S to the user target (Figure 1-7). The emulation probe can be used alternatively.

**Figure 1-7. Ribbon Cable**



**Optional Accessories**      **Emulation Probe**

The emulation probe, sold separately, is an alternative way to connect the daughterboard to a user target (Figure 1-8). One end of the probe connects to the 120-pin KEL connector on the daughterboard; the other end connects to a special socket on the user target.

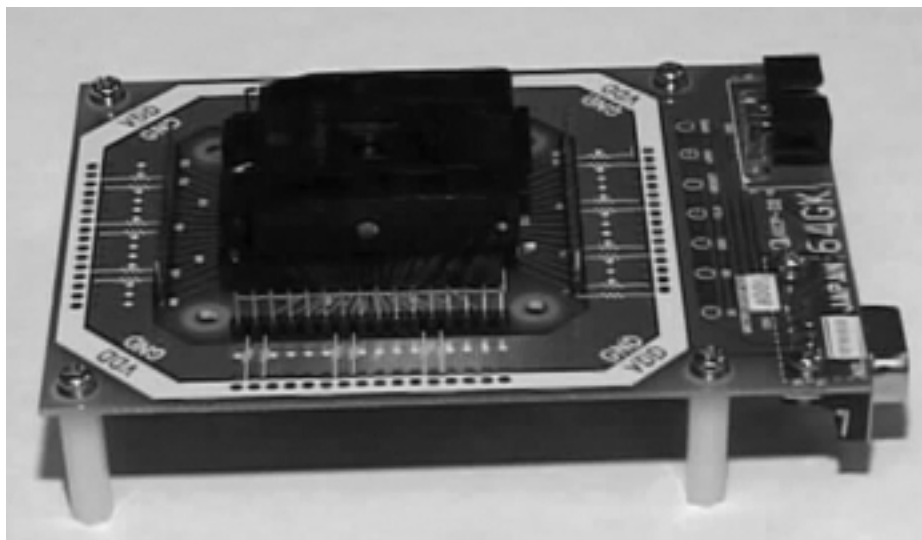
**Figure 1-8. Emulation Probe**



**Flash Adapter**

A flash adapter is used to program a flash microcontroller (Figure1-9). The adapter, a printed circuit board with a clam-shell socket and DB9 connector, must be wired so that the programming signals are transmitted to the connector. The DB9 connector may be used to connect the flash adapter to the LCE-K0S directly or through the flash programming cable included with the flash adapter.

**Figure 1-9. Flash Adapter**



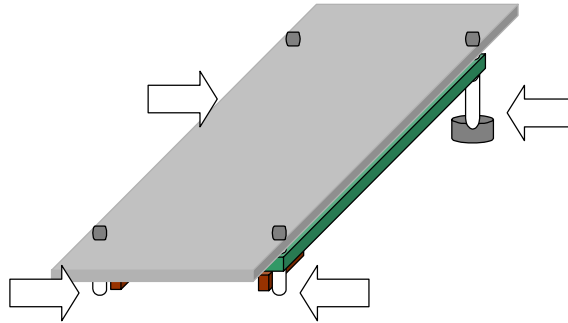
# Hardware Assembly 2

This section explains how to change the jumper settings, assemble the hardware components of the LCE-K0S, and establish connection to the host PC.

## Changing the Jumper Settings

1. Unscrew the four plastic spacers underneath the motherboard (Figure 2-1). **Take special care when handling the small washers.**

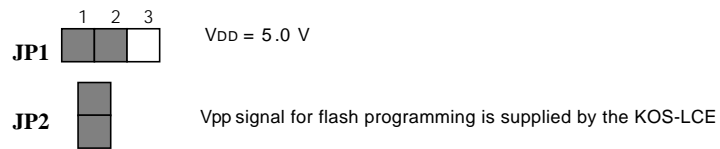
**Figure 2-1. Motherboard Cover and Screws**



2. Remove the plastic cover on top of the motherboard.
3. Figure 2-2 shows the default jumper settings.

## Default Settings

**Figure 2-2. Default Jumper Settings**



## Other Settings

4. To change the setting for JP1, refer to Figure 2-3.

**Figure 2-3. JP1 Setting for  $V_{DD} = 3.3 V$**



5. To change the setting for JP2, refer to Figure 2-4.

**Figure 2-4. JP2 Setting for VPP Supplied by User Target**

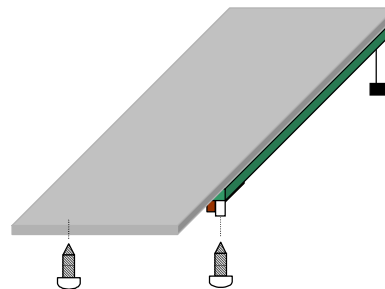


6. Replace the plastic cover on top of the motherboard.
7. Replace the washers and screws.

**Connecting the Boards**

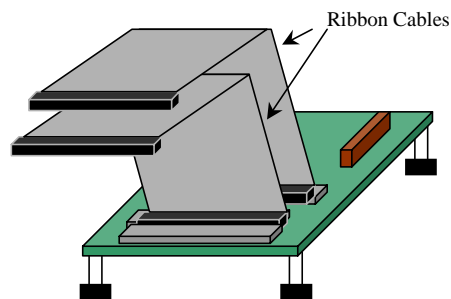
1. Make sure power is off.
2. Remove the two front screws at the bottom of the standoffs of the motherboard (Figure 2-5)

**Figure 2-5. Motherboard Screws**



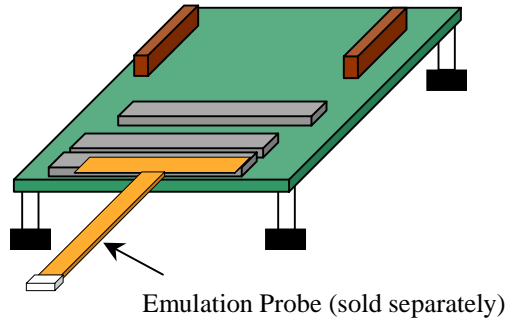
3. Connect the ribbon cables (Figure 2-6) or the probe (Figure 2-7) to the respective connectors on the daughterboard. Note that some daughterboards may come with only one ribbon cable.

**Figure 2-6. Ribbon Cables**



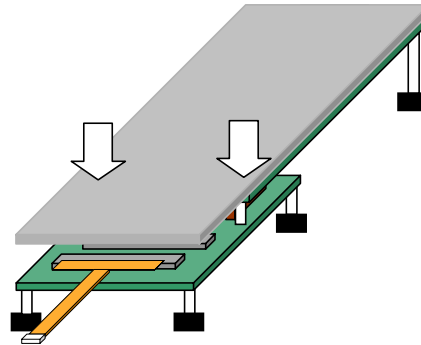


**Figure 2-7. Emulation Probe (Optional)**



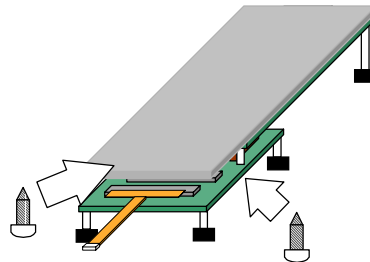
4. With the daughterboard on a stable surface, connect the motherboard to the top of the daughterboard by gently applying pressure on the mating connectors. Avoid applying too much pressure directly onto the plastic cover (Figure 2-8).

**Figure 2-8. Motherboard/Daughterboard Connections**

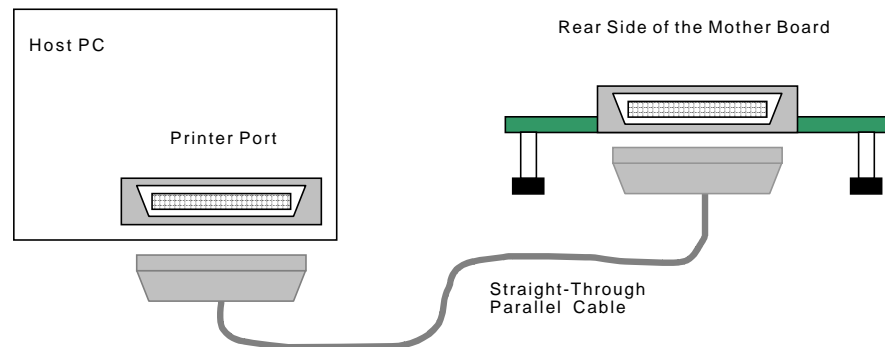


5. Replace the screws on the bottom of the daughterboard to secure the connections with the motherboard (Figure 2-9).

**Figure 2-9. Securing the Connections**



6. Connect the loose end of the ribbon cable or the probe to the user target. Refer to the daughterboard manual for pin assignments.
7. Use the 25-pin, male-to-male, straight-through cable included with the motherboard to connect to the printer or parallel port of the host (Figure 2-10).

**Figure 2-10. Host PC Connections**

### Establishing Communication

With the LCE-K0S power adapter connected, turn the switch to the ON position. The green LED on the motherboard will light when power is supplied to the system. The LCE-K0S is now ready to communicate with the software debugger.

For proper communication, the parallel port of the PC must be configured as a BIDIRECTIONAL port. In most cases, the port will be configured correctly. If not, enter into the BIOS of the PC and make the modifications. Refer to the user's manual for your PC for details.

## Software Installation **3**

---

### **Obtaining a Password**

Before installing the software, obtain a password from NEC Electronics Inc.

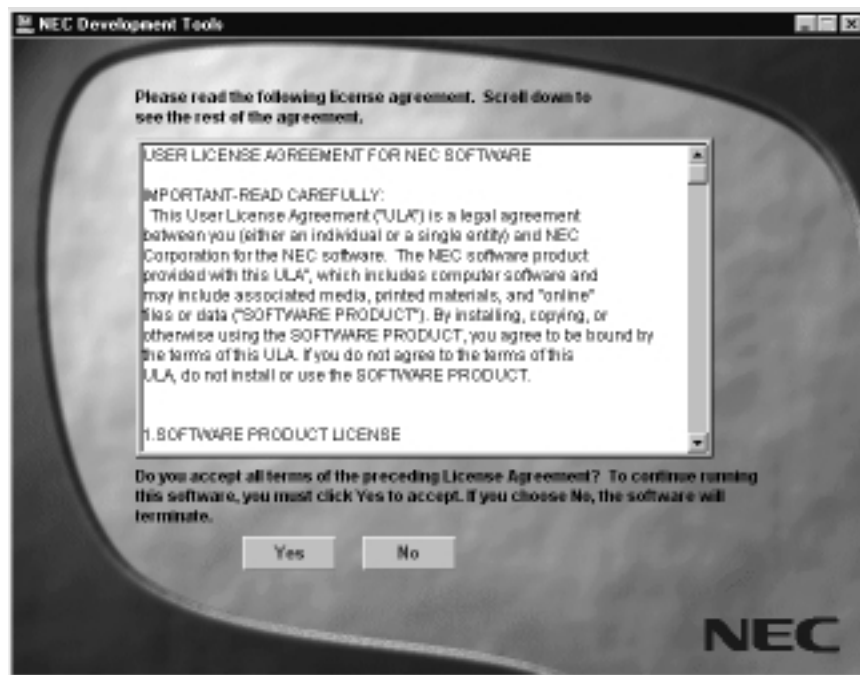
1. Call 1-800-366-9782. Press 1 for Literature and then press 1 again to speak to a representative who will assist you with LCE registration.
2. Provide your company information and the exact serial number printed on the motherboard.

### **Installing the Software**

The following procedure explains how to install the software for the LCE-K0S. At any time during the procedure, click **Back** to return to the previous screen or **Cancel** to cancel the installation.

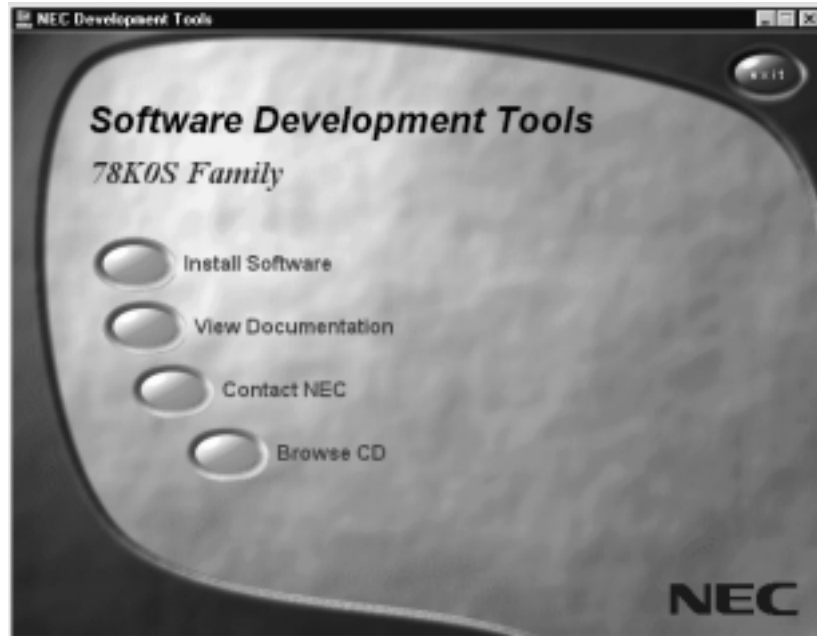
1. Load the CD-ROM into the drive. If the autorun feature is enabled in your CD-ROM drive, the **License Agreement** dialog box appears automatically after a few seconds (Figure 3-1). Alternatively, you may run the executable from the **Star** menu. Click **Run** → **Browse** and select the CD-ROM drive letter to view the contents of the CD-ROM. Select **NEC.EXE** and then click **Open** → **OK**.

**Figure 3-1. License Agreement**



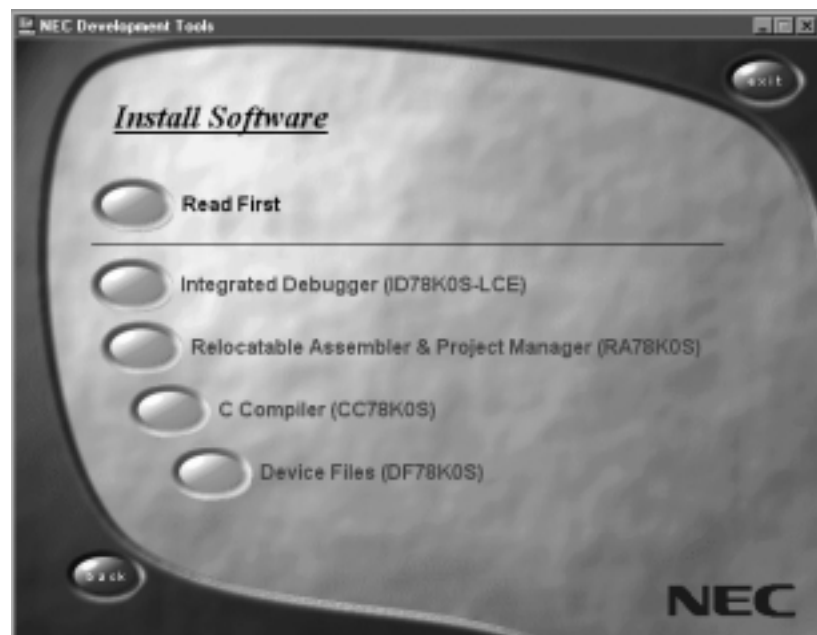
2. Click **Yes** to accept the agreement and proceed to the **Software Development Tools** menu (Figure 3-2) or click **No** to exit the program.

**Figure 3-2. Software Development Tools Menu**



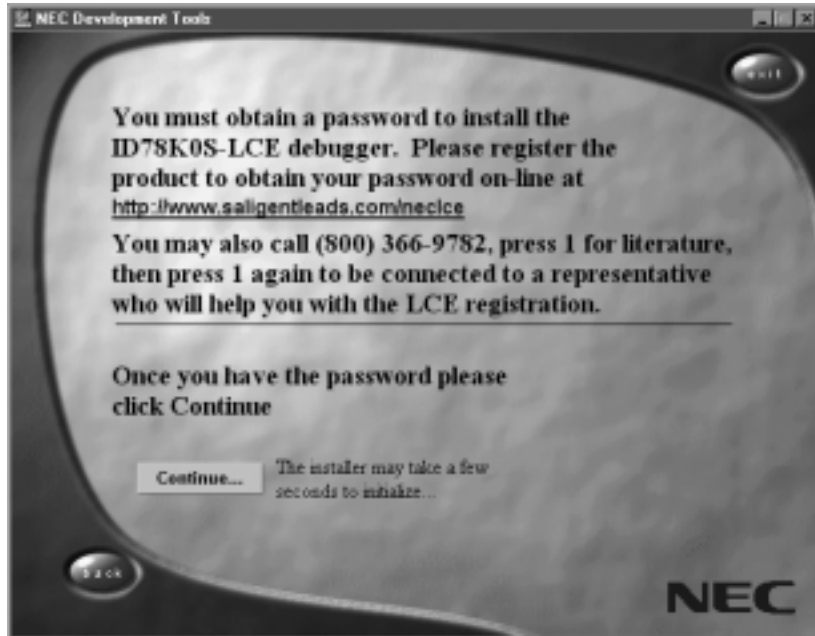
3. From the **Software Development Tools** menu, click **Install Software** to display the **Install Software** menu (Figure 3-3).

**Figure 3-3. Install Software Menu**



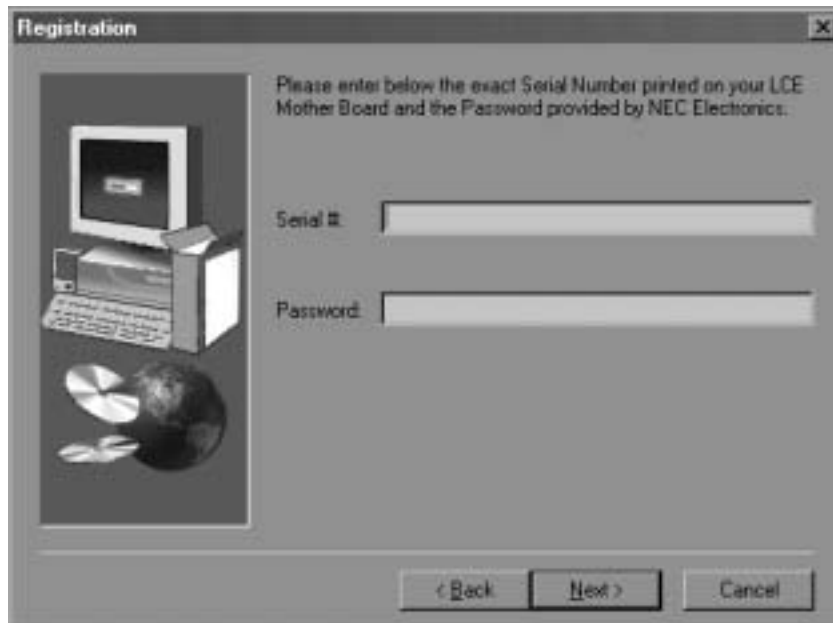
4. From the **Install Software** menu, click **Integrated Debugger** to learn how to register the ID78K0S-LCE and obtain a password from NEC Electronics Inc. (Figure 3-4). Once you obtain a password, click **Continue...** to install the software.

**Figure 3-4. Password Information**



5. The first screen in the ID78K0S-CCE install program is the **Registration** dialog box. Here enter the motherboard serial number and password assigned by NEC Electronics Inc. and then click **Next** to continue (Figure 3-5).

**Figure 3-5. Registration Dialog Box**



6. Read the **Welcome** dialog box and click **Next** to continue (Figure 3-6).

**Figure 3-6. Welcome Dialog Box**



7. In the **Select Components** dialog box, review the list of components (Figure 3-7). Clear those you do not wish to install and click **Next** to continue. To change the destination folder for installation, click **Browse**.

**Figure 3-7. Select Components Dialog Bo**



8. In the **Select Program Folder** dialog box, click **Next** to accept the default program folder (Figure 3-8). Otherwise, select another folder name and click **Next** to continue.

**Figure 3-8. Select Program Folder Dialog Box**



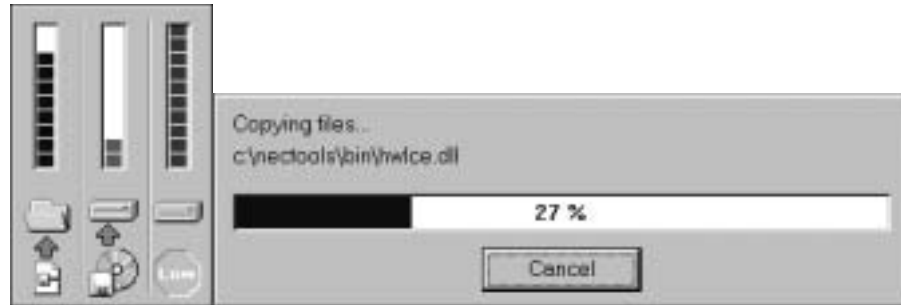
9. In the **Start Copying Files** dialog box, review your settings. If correct, click **Next** to install the program files (Figure 3-9). To change your settings, click **Back** to return to previous screens and repeat any steps necessary.

**Figure 3-9. Start Copying Files Dialog Box**



10. Wait for the installation to complete or click **Cancel** to cancel it (Figure 3-10).

**Figure 3-10. Copying Files Message**



11. Once the files are transferred to the host PC, you may choose to install the device files by checking the box in the **Setup Complete** dialog box. Click **Finish** to exit the program (Figure 3-11).

**Figure 3-11. Setup Complete Dialog Box**

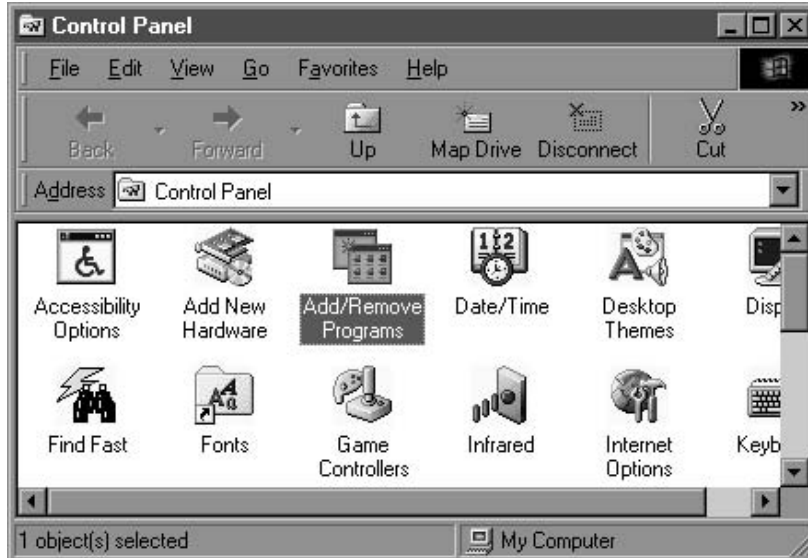




### Removing Software

1. To remove the software, open the **Start** menu from your desktop. Click **Settings** → **Control Panel** → **Add/Remove Programs** (Figure 3-12).

**Figure 3-12. Control Panel Window**



2. In the **Add/Remove Programs Properties** dialog box, select **NEC ID78K0S-LC** and then click **Add/Remove**. Click **OK** to exit the dialog box (Figure 3-13).

**Figure 3-13. Add/Remove Programs Properties**



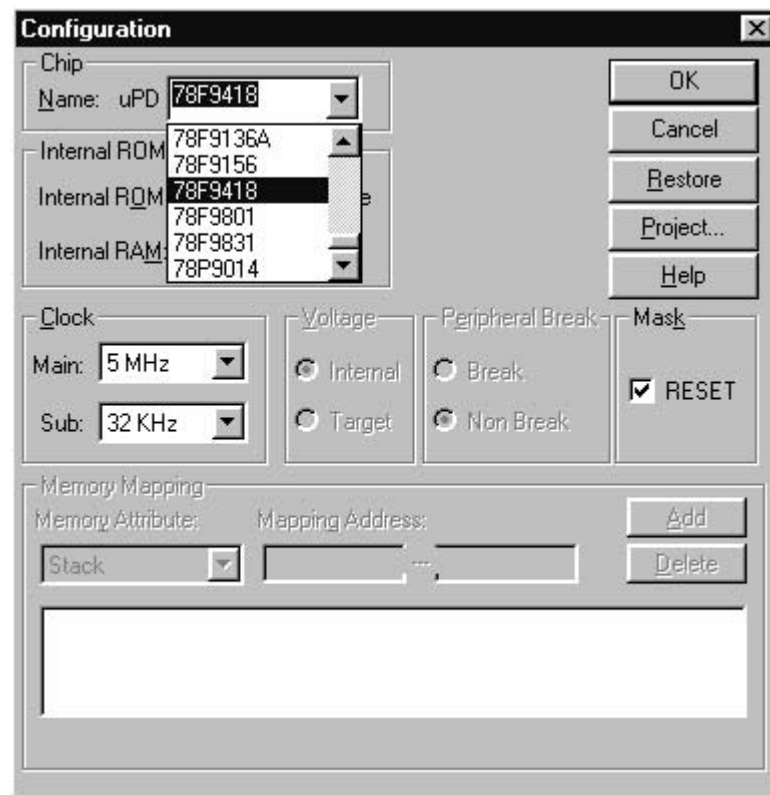


# Operation 4

With power applied to the LCE-K0S, follow this procedure to launch the ID78K0S-LCE integrated debugger.

1. From the **Star** menu, click **Programs** → **NEC Tools** → **ID78K0S-LCE** to open the **Configuration** dialog box (Figure 4-1).

**Figure 4-1. Configuration Menu**



2. In the **Configuration** dialog box, select the device to emulate and then click **OK** to open the **Main** window (Figure 4-2). The selected device must be supported by the daughterboard. Refer to the daughterboard user's manual for a list of devices supported.

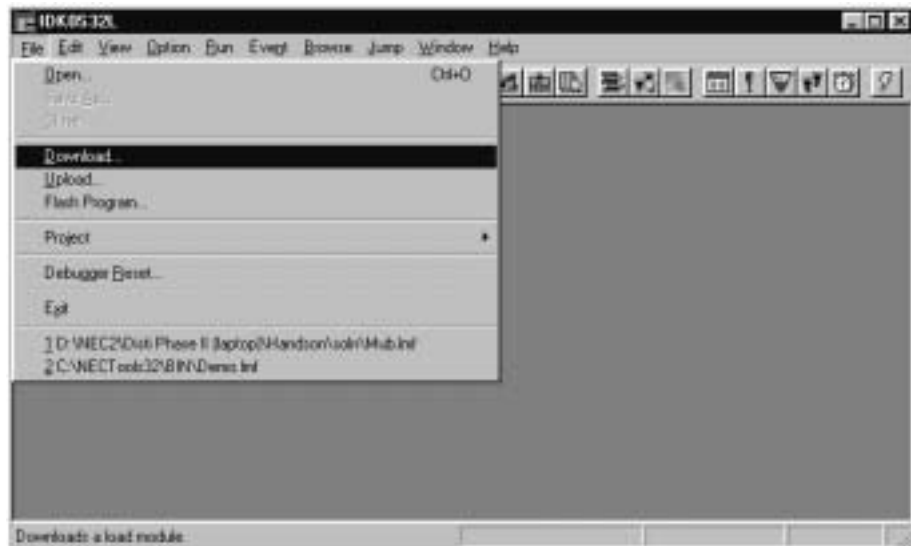
**Figure 4-2. Main Window**



**Downloading a Load Module File**

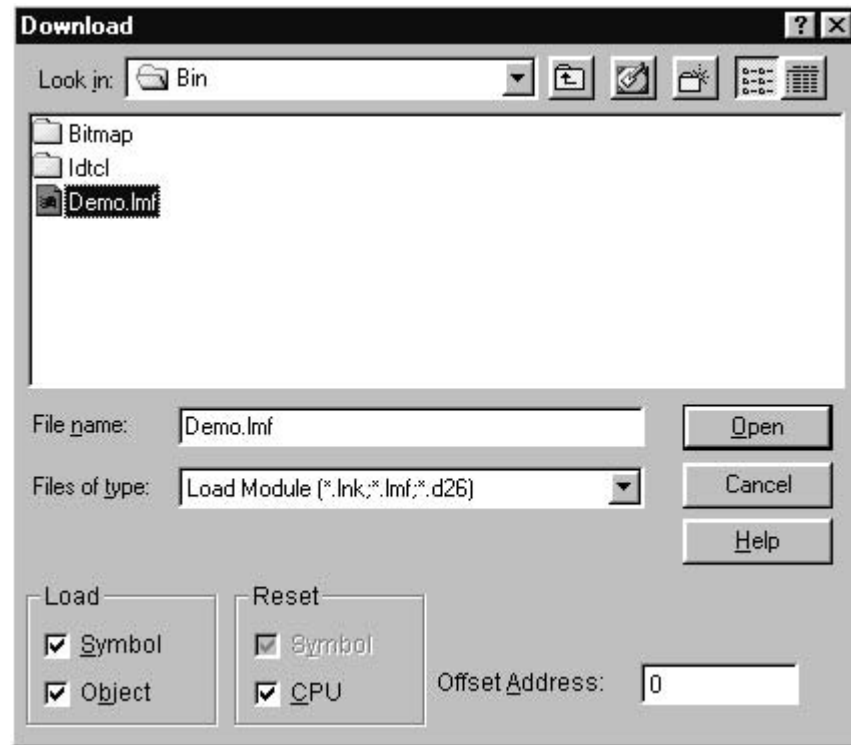
1. To download a load module file (the file containing source debugging information that is generated by the linker after it has compiled and assembled the source code) or a hex file to the emulator, click **File** to open the File menu (Figure 4-3). Example code is included during installation for demonstration.

**Figure 4-3. File Menu**



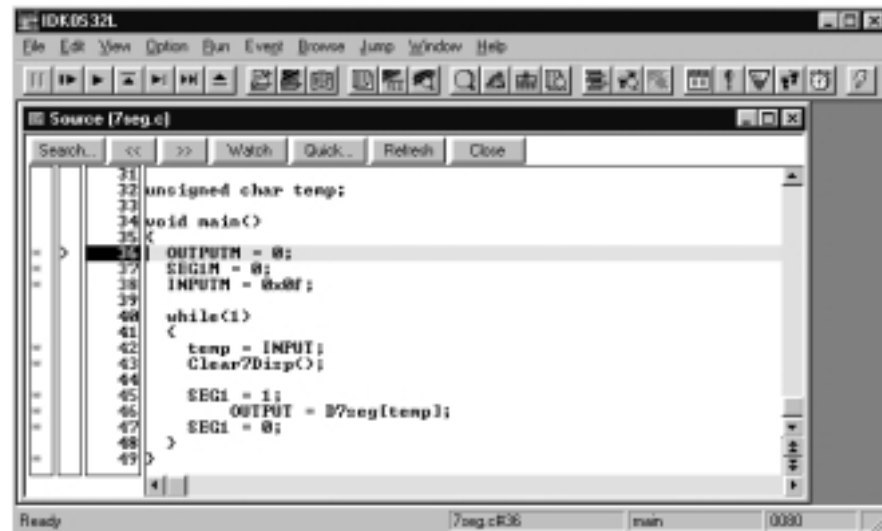
- Click **Download . . .** to open the **Download** dialog box (Figure 4-4).

**Figure 4-4. Download Dialog Box**



- Select a load module or hex file and click **Open** to load the file into the Source window (Figure 4-5).

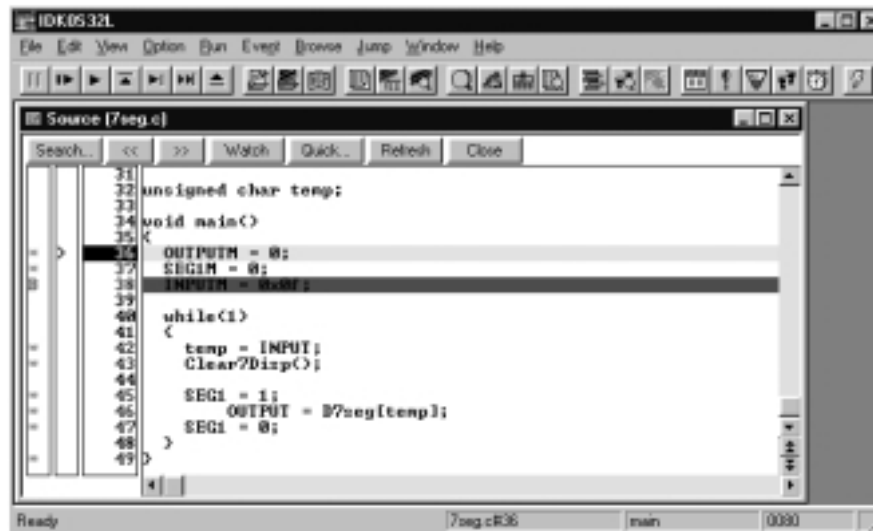
**Figure 4-5. Source Window**



### Setting a Breakpoint

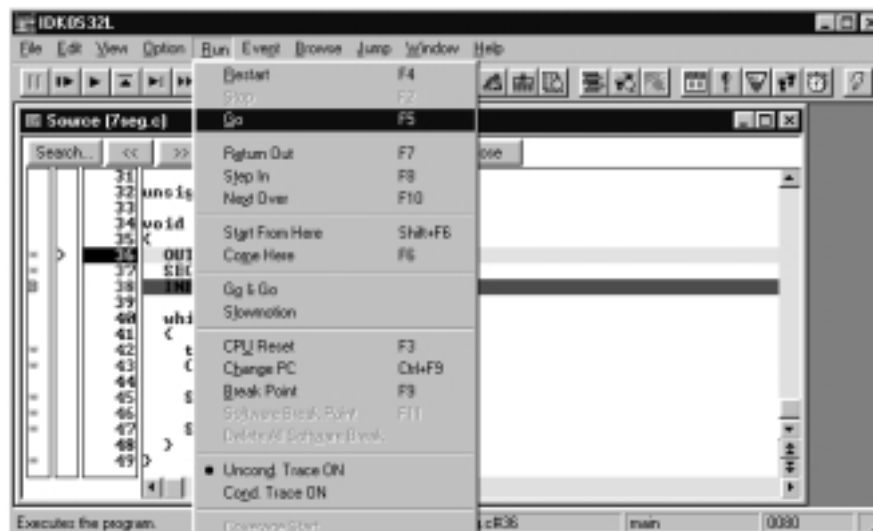
1. From the Source window, you can set a breakpoint by moving your cursor to a line in the source and then clicking the asterisk to the far left (Figure 4-6). This step causes a red B to appear at the breakpoint location; the source line is also highlighted in red. To delete the breakpoint, click the red B. The asterisk indicates a valid location for a breakpoint.

**Figure 4-6. Breakpoint Selection**



2. To execute the code at full speed in real time, select the **Run** menu and then click **Go** (Figure 4-7). When the program counter (PC) reaches the breakpoint, program execution terminates and the Source window shows the current PC value, shown as ">" in the second column. The source line is also highlighted in yellow.

**Figure 4-7. Run Menu**



- To view other debugging windows, open the **Browse** menu and click your selection (Figure 4-8).

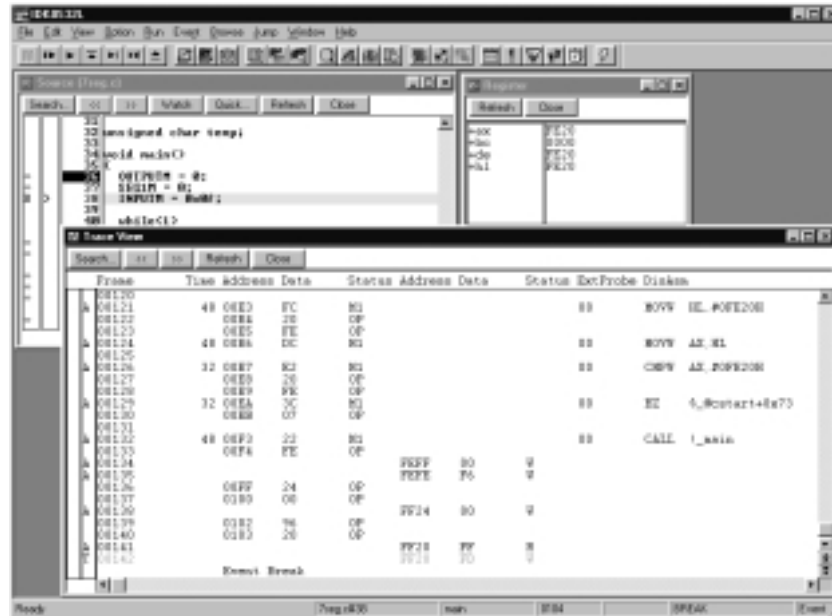
**Figure 4-8. Browse Menu**



## Viewing the Trace Window

To view tracing information in the Trace window, select **Browse** and then click **Trace** (Figure 4-9).

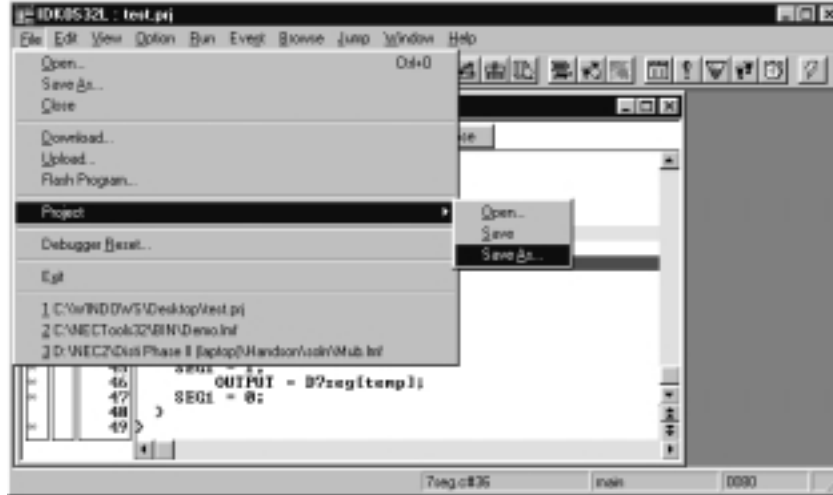
**Figure 4-9. Trace Window**



### Saving a Project

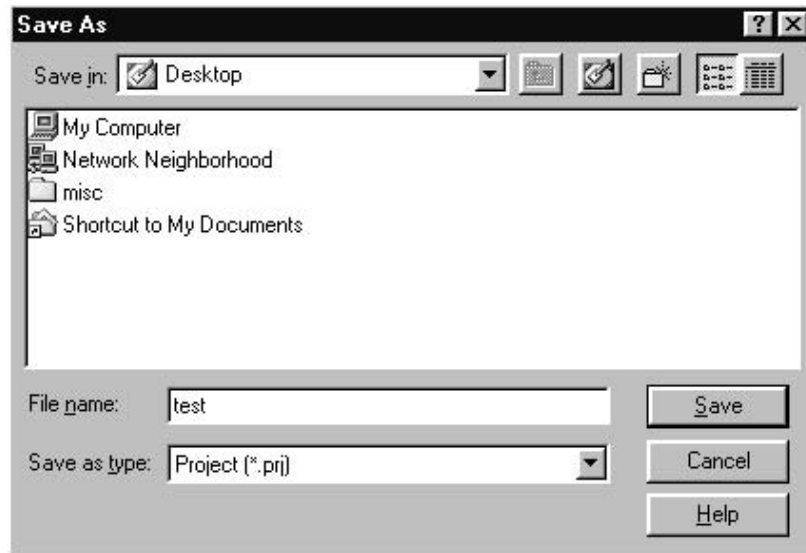
1. To save the debugging windows and breakpoints in a project file, click **File** → **Project** → **Save As...** (Figure 4-10).

**Figure 4-10. Project Submenu**



2. Select a directory, enter a project file name, and then click **Save** to save the file (Figure 4-11).

**Figure 4-11. Save As Dialog Box**

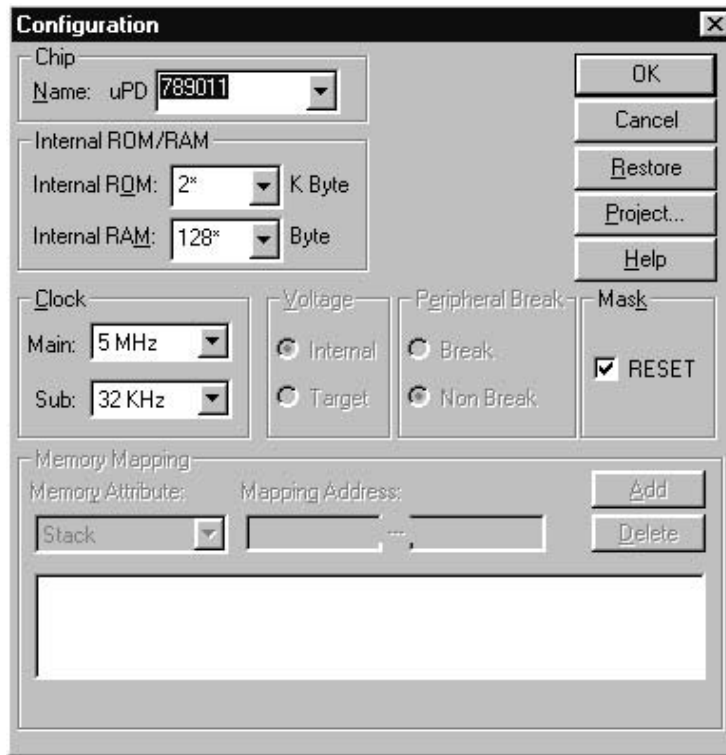




### Opening a Project

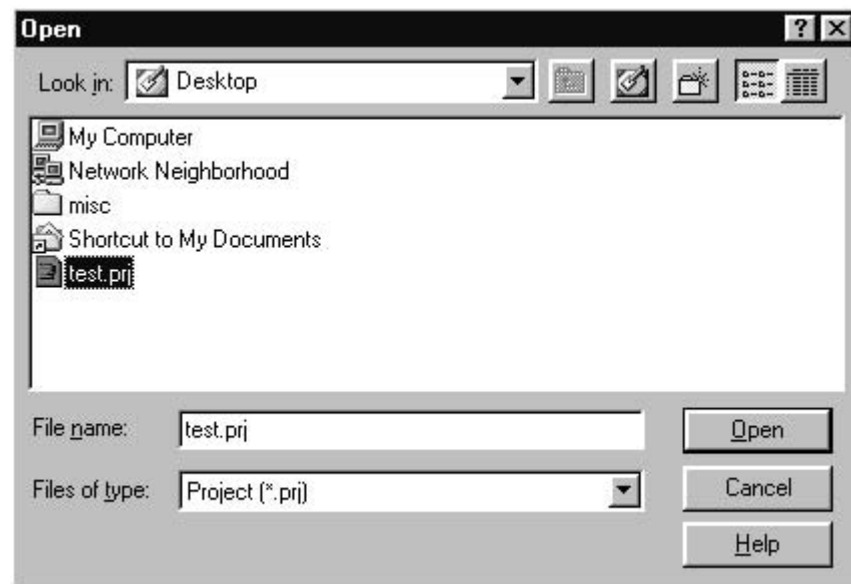
1. To open a previously saved project file, click **Star** → **Programs** → **NEC Tools** → **ID78K0S-LCE**. From the **Configuration** dialog box, click **Project...** (Figure 4-12).

**Figure 4-12. Configuration Dialog Box**



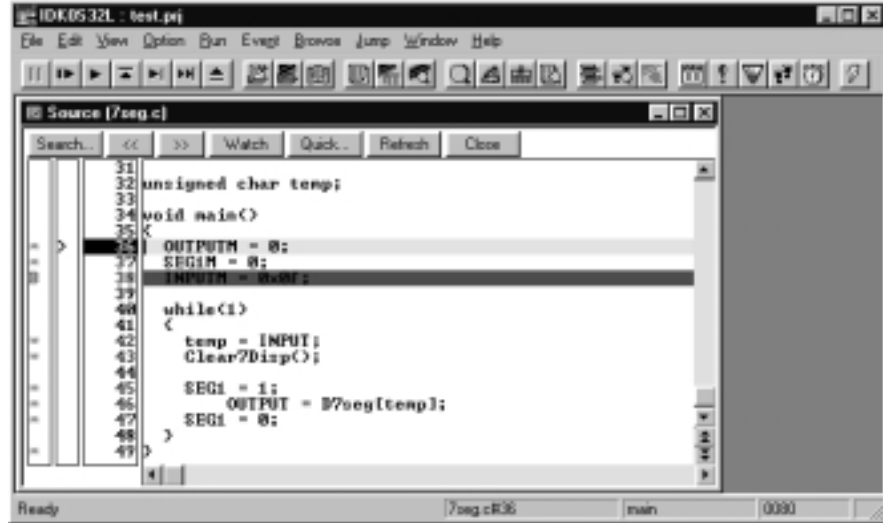
2. From the **Open** dialog box, select the project file name and click **Open** (Figure 4-13).

**Figure 4-13. Open Dialog Box**



3. The debugger loads the project and sets up all the windows and breakpoints exactly as they were last saved (Figure 4-14).

**Figure 4-14. .PRJ File Displayed in Source Window**



# Flash Programming 5

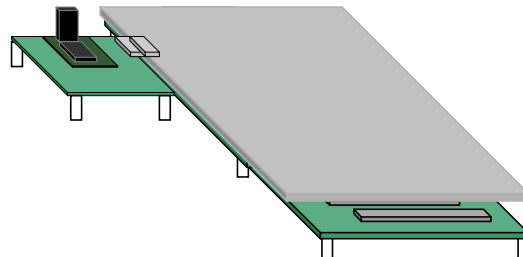
The LCE-K0S is equipped with a flash programmer for K0S microcontrollers with flash memory. The LCE-K0S supports only 3-wire serial I/O for flash programming. Table 5-1 shows the pin configuration of the LCE-K0S DB9 connector.

**Table 5-1. Pin Configuration of the LCE-K0S DB9 Connector**

Pin	Signal Name	Specification
1	GND	Ground
2	SI	Serial data input
3	SO	Serial data output
4	SCK	Serial clock output
5	CLK	Clock output to target
6	RESET	RESET signal output to target (active low)
7	VDD	VDD input/output to target
8	VPP	VPP output to target
9	–	

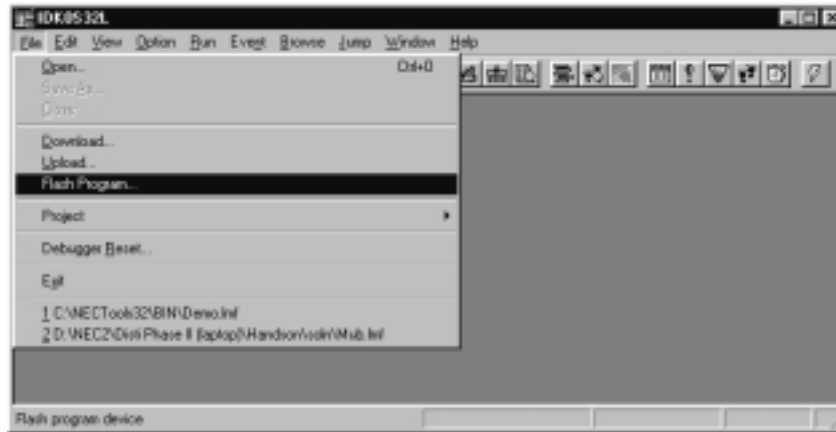
1. With power off to the LCE-K0S, connect a flash programming adapter with a flash device to the DB9 connector of the LCE-K0S (Figure 5-1).

**Figure 5-1. Clamshell Socket and DB9 Connector**



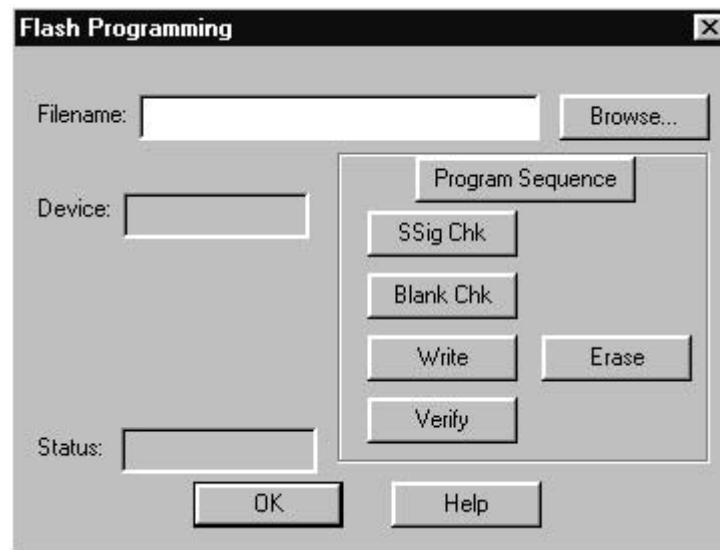
2. Turn on power to the LCE-K0S.
3. Click **Start** → **Programs** → **NEC Tools** → **ID78K0S-LCE**.
4. From the **Configuration** dialog box, select the proper device and click **OK**.
5. From the Main window, open the **File** menu and click **Flash Program...** (Figure 5-2).

Figure 5-2. Flash Program... Command



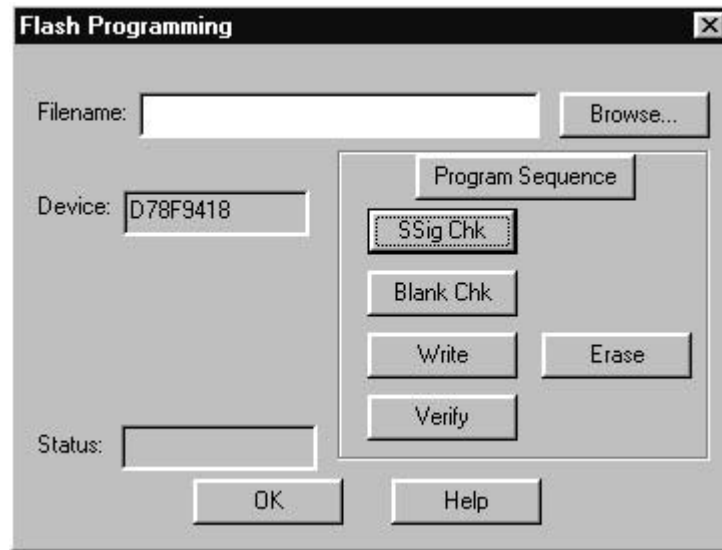
6. From the **Flash Programming** dialog box, click **SSig Chk** to check the silicon signature of the device (Figure 5-3).

Figure 5-3. Flash Programming Dialog Box



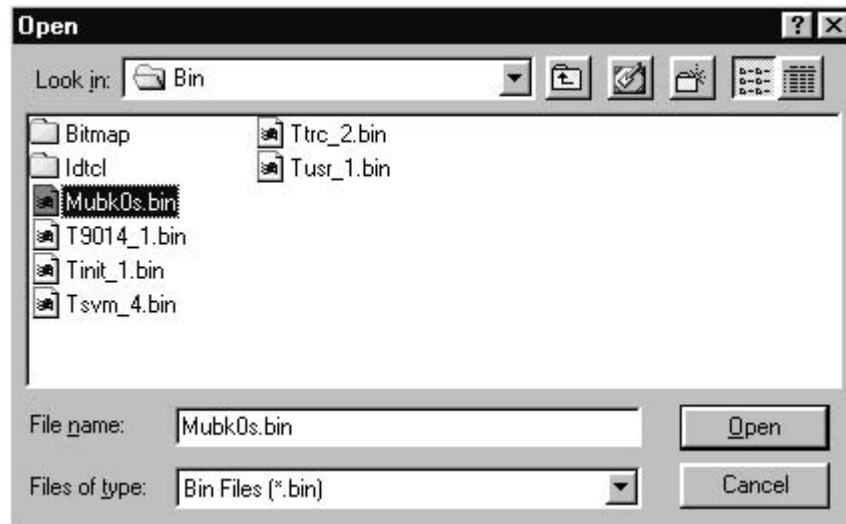
7. The flash programmer checks for the device and displays the part number in the **Device:** box (Figure 5-4).

**Figure 5-4. Successful Silicon Signature Check**



8. To perform a blank check on the device, click the **Blank Chk** button. To completely erase the entire device, click **Erase**.
9. To program the device, click **Browse...**, select a .HEX file and then click **Open** to download the file (Figure 5-5).

**Figure 5-5. Open Dialog Bo**



10. Click **Write** to program the device. Keep in mind that programming time will vary depending on the size of the file. **Verify** compares the contents of the flash device with the file. Note that this function may take a few minutes because it verifies the contents of the entire device.

11. To automate the programming sequence described above, click **Program Sequence** to execute the silicon signature check, blank check, erase (if necessary), and write operations in sequential order.
  
12. To exit the programmer, click **OK**.

# Troubleshooting 6

This section provides some helpful information for troubleshooting error messages from the LCE-K0S. Table 6-1 explains how to correct the **error** message shown in Figure 6-1.

## Communication Error

**Figure 6-1. Communication Error**



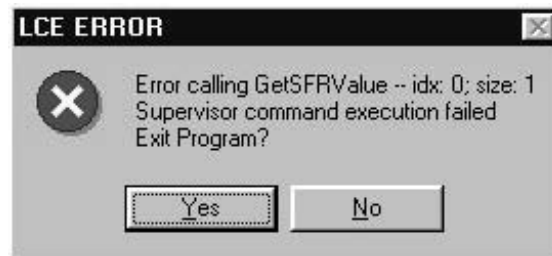
**Table 6-1. Troubleshooting a Communication Error**

Possible Cause	Solution
No power to the LCE	Check that the LCE-K0S has power (green LED should be on).
Parallel cable not connected	Connect a 25-pin straight-through cable.
Parallel port on the host PC not configured as bidirectional	Enter the host PC's BIOS configuration and modify its parallel port as bidirectional. Refer to the PC user's manual for procedures about modifying the BIOS.
No daughterboard connected to the motherboard	Connect a daughterboard and select the appropriate device in the Configuration window.

## Error When Opening a Project

If you load a previously save project to the LCE-K0S and receive the error message shown in Figure 6-2, then the clock source saved in the project file does not match the clock source of the LCE-K0S

**Figure 6-2. Failed Supervisor Command**



Open the .PRI file, an example of which is shown in Figure 6-3. Change “Clock=User” to “Clock=5 MHz” and “SubClock=User” to “SubClock=32 kHz.” Save the file and load it into the LCE-K0S. To change the clock settings, open the **Options** menu and click **Configuration....**

**Figure 6-3. Example .PRI File Flash Programming Error**

```
[Project.ID]
Ver=200
Target=IDK0S32L

[Configuration]
Chip=μPD78F9418
Internal Rom=32KB
Internal Ram=512B
Clock=User   <<<
SubClock=User <<<
Voltage=Internal
.
.
```

If you invoke the flash programming interface and receive the error message shown in Figure 6-4, refer to Table 6-2 to determine the possible cause of the problem.

**Figure 6-4. Flash Programming Error**



**Table 6-2. Troubleshooting a Flash Programming Error**

Possible Cause	Solution
No flash device connections	Connect a K0S flash micrcontroller.
Incorrect signal connections	Make sure all LCE-K0S connector pins are connected to the proper pins of the flash micrcontroller. On some devices, connect V <sub>SS0</sub> with V <sub>SS1</sub> and V <sub>DD0</sub> with V <sub>DD1</sub> .
No V <sub>PP</sub> signal	Connect the jumper on the JP2 header of the LCE-K0S.
Flash device not supporte	Connect only a K0S flash device.

**Write or Verify Errors**

If you receive the message “Couldn’t allocate 312016898 bytes of memory for buffer,” when you perform a Write or Verify operation, perform a Silicon Signature check before performing the Write or Verify operation.



# Functional Description **7**

---

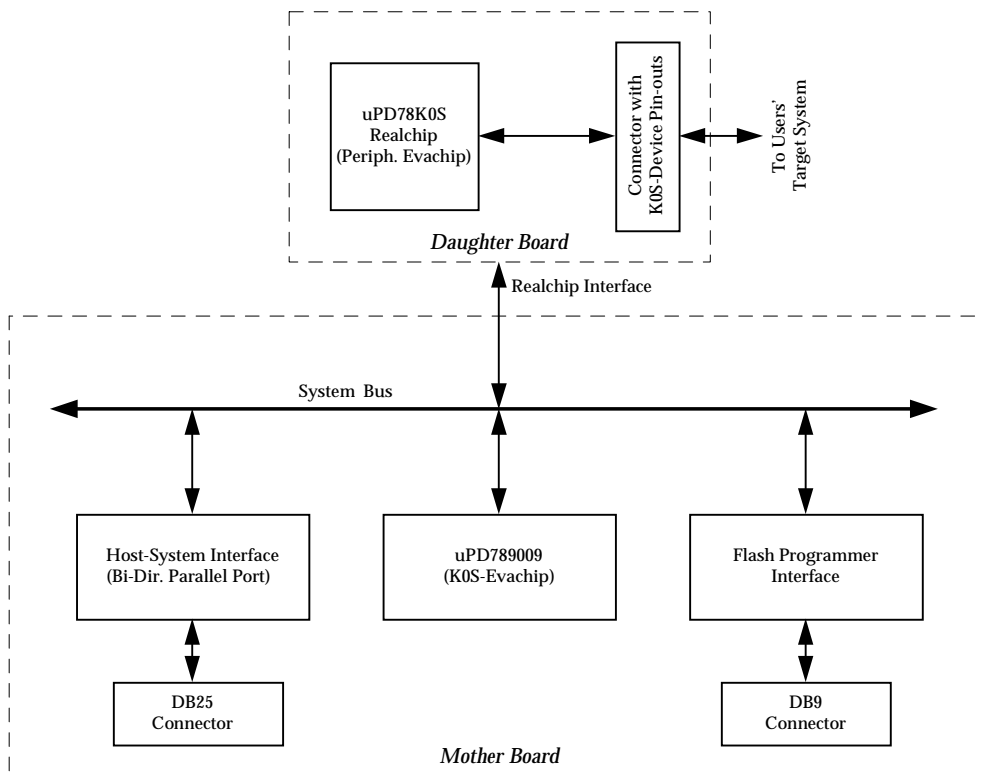
The LCE-K0S implements a motherboard/daughterboard design (Figure 7-1). Because of the standard peripheral bus in the K0S microcontroller's CPU, one motherboard is used for all LCE-K0S systems. The motherboard contains the K0S CPU Evachip, the flash programmer, and the parallel interface to the PC. The daughterboard is unique for each K0S subseries and contains a K0S real-chip with all the peripherals found in the K0S device being emulated. The motherboard and daughterboard interface using NEC's real-chip peripheral bus.

## Features

- ❑ Real-time in-circuit emulation
- ❑ Fully equipped flash programmer
- ❑ RAM-based control software for easy upgrade of control software versions
- ❑ 5- or 3-volt signal emulation
- ❑ Breakpoint settings
  - Up to 16 program (ROM) fetch breakpoints
  - Up to 2 data (RAM) breakpoints: break on read, write, and read/write
- ❑ Trace capabilities
  - 64 bits per frame by 64K frames
  - Trace window that displays assembly code or mixed C and assembly code
  - Three tracing modes
    - Unconditional
    - Qualified (if an event condition is satisfied)
    - Sectional (starts and ends by event triggering)
- ❑ Window synchronizing: frames displayed in the Trace View window are highlighted in the Source Code window
- ❑ Time stamping
  - Max. time: 7.15 min.–14.32 min.
  - Resolution: 100 ns or 200 ns
- ❑ Parallel interface to PC via DB25 connector
- ❑ Windows-based integrated debugger
- ❑ Source-level debugging in C language or Assembly language
- ❑ Emulation memory
  - Up to 48 KB internal ROM
  - Up to 1 KB internal RAM

The control software for the LCE-K0S is RAM-based to allow the controlling program to be down-line loaded each time the system is started. This feature allows for easy upgrading of new control software versions.

**Figure 7-1. LCE-K0S Block Diagram**



**Table 7-1. Specifications**

Parameter	Specifications		
System operating voltage	Main power supply	VCC = 5 V plus/minus 5%, wall-mounted power supply	
	Real chip	VDD = 3.3 V, 5% (LCE-K0S internally generated)	
	Flash program	VPP = 10 V, 5% (LCE-K0S internally generated)	
System operating frequencies	Main clock	10 MHz; system installed	
	Subclock	32.768 kHz; system Installed	
		CMOS logic needed to buffer the user-supplied clock from target	
		Footprint for user-installed crystal oscillator provided	
Host interface	Bidirectional parallel port		
	Connect LCE-K0S to host PC using 25-pin straight-through DB25 cable		
Flash programming interface	Connect program adapter to DB-9 connector on the motherboard		
	Connect target system for on-board programming through DB-9 connector on the motherboard		
Program memory and data memory	Program memory up to 48 KB; provided by K0S Evachip		
	Data memory up to 1 KB; provided by K0S Evachip		
Probe connection to user system	Cable probe	Socket connector to socket connector; 6-inch cable	
	Special probe	Socket connector to device socket (available as option)	
Break event detection	Program execution status detection		
	Bus event detection		
Trace memory	64 bits per frame by 64K frames		
	Trace address, data, and execution status		
	Time stamp for measuring execution time:	7.15 min. @ 100 ns count rate or,	
		14.32 min. @ 200 ns count rate	
Event integration	Linking events		
Platform board dimensions	Motherboard	Approximately 6.5" x 4.5" (16.5 cm x 11.5 cm)	
	Daughterboard	Approximately 4.0" x 4.5" (10.4 cm x 11.5 cm)	
	Combined	8.5" (L) x 4.5" (W) x 2.0" (H) (21.6 cm x 11.5 cm x 5.1 cm)	

