

# ISL73100SEHEV1Z

## User's Manual: Evaluation Board

High Reliability

All information contained in these materials, including products and product specifications, represents information on the product at the time of publication and is subject to change by Renesas Electronics Corp. without notice. Please review the latest information published by Renesas Electronics Corp. through various means, including the Renesas Electronics Corp. website (<http://www.renesas.com>).

## ISL73100SEHEV1Z

### Evaluation Board

The ISL73100SEHEV1Z evaluation board is designed to evaluate the performance of the ISL70100SEH and ISL73100SEH. The ISL70100SEH and ISL73100SEH are radiation hardened 40V current-sense amplifiers built using the Renesas proprietary PR40 SOI process.

### Key Features

- Large current-sense resistor footprint (2512)
- Easy gain configuration using a single resistor
- Kelvin sensing for improved measurement accuracy

### Specifications

- Power supply voltage range: 2.7V to 40V
- Current-sense input common-mode range: -0.3V to 40V (regardless of power supply voltage)
- Board dimension: 4.25cmx5.25cm
- Board layers: Two
- Board revision: A

### Ordering Information

Part Number	Description
ISL73100SEHEV1Z	ISL73100SEHEV1Z evaluation board

### Related Literature

For a full list of related documents, visit our website:

- [ISL73100SEH](#), [ISL70100SEH](#) device pages

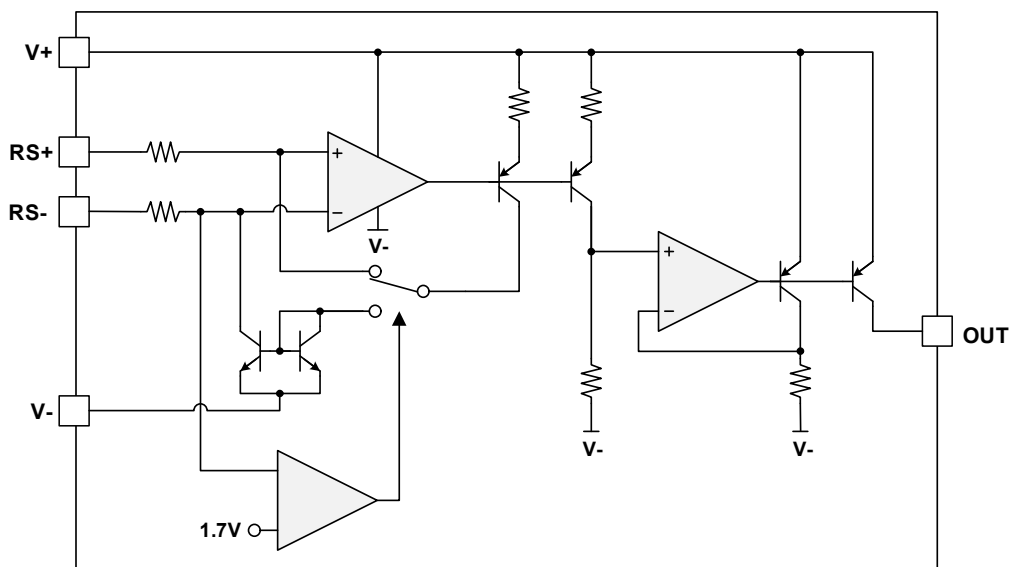

Figure 1. ISL73100SEHEV1Z Block Diagram

## 1. Functional Description

The evaluation board includes a 2512 sized SMD pad for populating a current-sense resistor and an output termination resistor to set the current-sense to output voltage scaling.

### 1.1 Operating Range

The ISL70100SEH and ISL73100SEH have a wide power supply range from 2.7V up to 40V. The input common-mode range extends from -0.3V to 40V, making them ideal to use in both high-side and low-side current-sense applications. The current-sense amplifiers are voltage-to-current converters that monitor current using an external sense resistor and output a scaled current of the sensed input voltage.

### 1.2 Quick Start Guide

1. R2 is a 15mΩ 2512 sized to provide 150mV for 10A. The analog differential input voltage for RS+ to RS- is 0V to 150mV. If R2 needs to be changed, the product of the current-sense resistance and maximum load current must fall within 150mV.
2. With the load unbiased: Connect the current-sense terminals to the circuit load either in a high-side sense (RS+ goes to load positive supply rail, RS- goes to load positive terminal) or low-side sense (RS+ goes to load negative terminal, RS- goes to load negative supply rail) configuration.
3. Provide a power supply voltage to V+ (BA1) and GND (BA2) terminals of the ISL73100SEHEV1Z board. The power supply voltage range is 2.7V to 40V.
4. Power-up load.
5. The voltage on OUT (BNC1) with the 25kΩ output resistor is 50mV for every 1mV input sense voltage. The full-scale 150mV input produces 7.5V output.

**Note:** To use the full-scale output voltage at 150mV full-scale input sense voltage with the 25kΩ output resistor, the minimum supply range must be increased to 9.5V to account for the 2.0V output head-room to the V+ supply voltage.

### 1.3 Current-Sense Resistor

To pick the current-sense resistor value, a decision has to be made between power dissipation and measurement accuracy. As a general rule for all applications, the sense resistor should be as small as possible while still providing adequate input dynamic range across the operating range. The minimum accurately sensed input voltage is primarily limited by the offset voltage of the ISL70100SEH and ISL73100SEH.

The sense resistor value can be calculated when the maximum load current is determined. The maximum recommended sense voltage for the amplifier is 150mV, so dividing that by the maximum load current provides the sense resistor value.

The current-sense error is the amplifier offset voltage divided by the current-sense resistor.

On the ISL73100SEHEV1Z, the current-sense signal is connected to the R2 current-sense resistor in a Kelvin configuration for sense accuracy.

### 1.4 Current-Sense Amplifier Output Voltage (Gain Setting)

The ISL73100SEHEV1Z is populated with a 25kΩ resistor at the current-sense amplifier output to GND (BNC terminal OUT).

The overall gain ( $A_{CSA}$ ) on the ISL70100SEH can be adjusted using a single resistor on the output. The ISL70100SEH outputs 2μA for every 1mV of differential across the inputs. [Equation 1](#) can be used to calculate the output load resistance to get a specific gain:

$$(EQ. 1) \quad R_{OUT} = \frac{A_{CSA}}{gm}$$

For the 25k $\Omega$  resistor, the current-sense amplifier gain ACSA is  $(25\text{mV}/\mu\text{A}) * (2\mu\text{A}/\text{mV}) = 50\text{V}/\text{V}$ . Therefore, at full-scale of the 150mV input, 300 $\mu\text{A}$  output current, the 25k $\Omega$  output resistor produces a full-scale output voltage of 7.5V. Therefore, the output produces 50mV for every 1mV input sense voltage.

### 1.5 Power Supply Bias Range

The ISL73100SEHEV1Z can be biased anywhere from 2.7V to 40V. The current-sense input common-mode voltage range is from -0.3V to 40V, regardless of the V+ to V- power supply bias. The current-sense amplifier output voltage range is V- to 2.0V below V+.

The ISL73100SEHEV1Z is populated with a 25k $\Omega$  output resistor that produces 7.5V output voltage at 150mV full-scale input voltage. To achieve full-scale output voltage, the minimum power supply bias voltage is 9.5V.

If the minimum power supply of 2.7V is used with the 25k $\Omega$  output resistor, the maximum accurately sensed current would be 0.93A.

## 2. Layout Recommendations

To ensure the best accuracy, Renesas recommends connecting the sense inputs to the sense resistor using a Kelvin connection. This 4-terminal approach to measurements helps eliminate the losses due to parasitic resistances in the high current path. To ensure that the bandwidth of the amplifier is not inadvertently compromised, care must be taken to minimize stray capacitance on the output.

### 2.1 ISL73100SEHEV1Z Evaluation Board

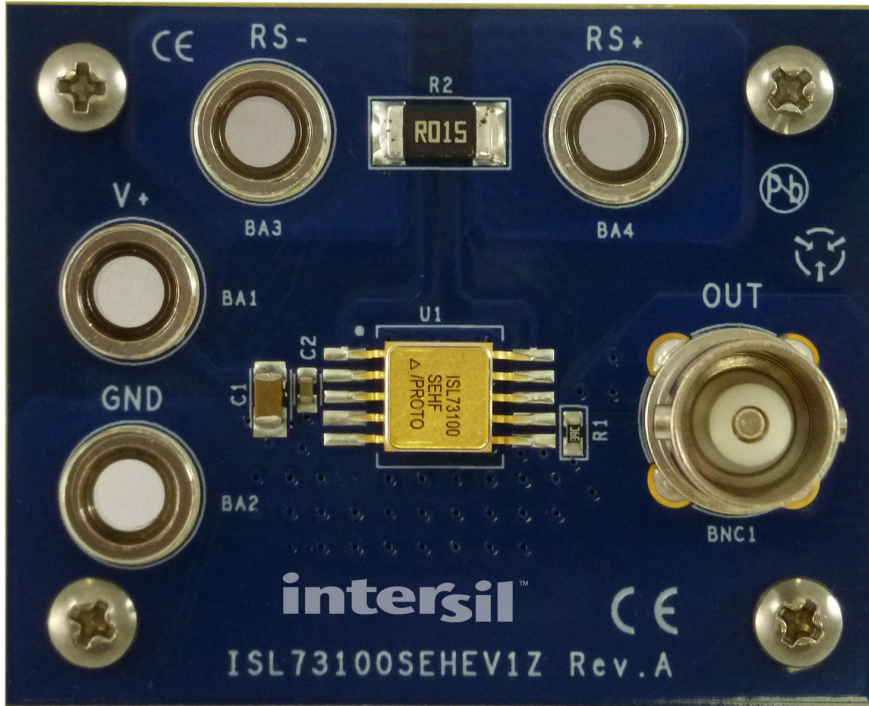

Figure 2. ISL73100SEHEV1Z (Top)

### 2.2 ISL73100SEHEV1Z Circuit Schematic

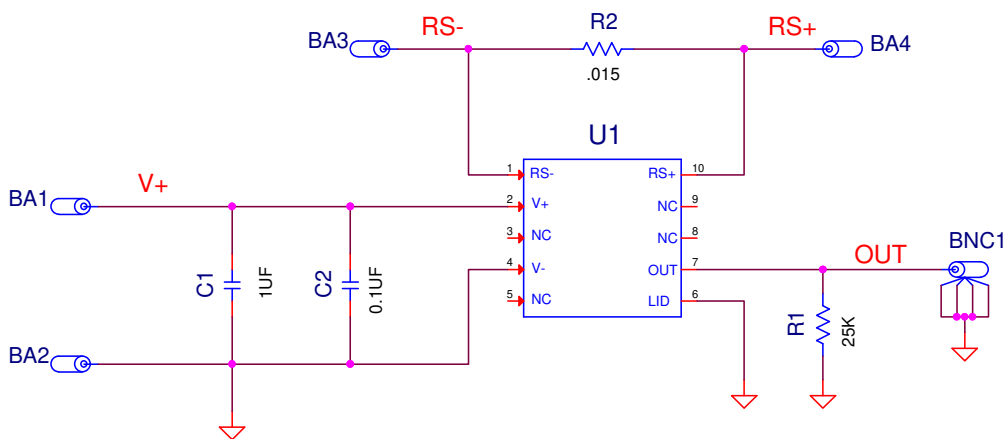

Figure 3. Schematic

### 3. Bill of Materials

Qty	Reference Designator	Description	Manufacturer	Manufacturer Part Number
1		PWB-PCB, ISL73100SEHEV1Z, REVA, ROHS	Imagineering Inc	ISL73100SEHEV1ZREVAPCB
1	C2	CAP, SMD, 0603, 0.1 $\mu$ F, 100V, 10%, X7R, ROHS	Murata	GRM188R72A104KA35J
1	C1	CAP, SMD, 1206, 1 $\mu$ F, 100V, 10%, X7R, ROHS	Venkel	C1206X7R101-105KNE
1	BNC1	CONN-BNC, RECEPTACLE, TH, 4 POST, 50 $\Omega$ , SILVERCONTACT, ROHS	Amphenol	31-5329-51RFX
4	BA1-BA4	CONN-JACK, MINI BANANA, 0.175 PLUG, NICKEL/BRASS, ROHS	Keystone	575-4
1	U1	IC-PROTO, RAD HARD, CURRENT SENSE AMP, SMD, 10P, CDFP	Renesas	ISL73100SEHF/PROTO
1	R2	RES-AEC-Q200, SMD, 2512, 0.015 $\Omega$ , 3W, 1%, MF, ROHS	Bourns	CRA2512-FZ-R015ELF
1	R1	RES, SMD, 0603, 24.9k, 1/10W, 1%, TF, ROHS	Panasonic	ERJ-3EKF2492V
4	Four corners	SCREW, 4-40x1/4in, PHILLIPS, PANHEAD, STAINLESS, ROHS	Building Fasteners	PMSSS 440 0025 PH
4	Four corners	STANDOFF, 4-40x3/4in, F/F, HEX, ALUMINUM, 0.25 OD, ROHS	Keystone	2204

## 4. Board Layout

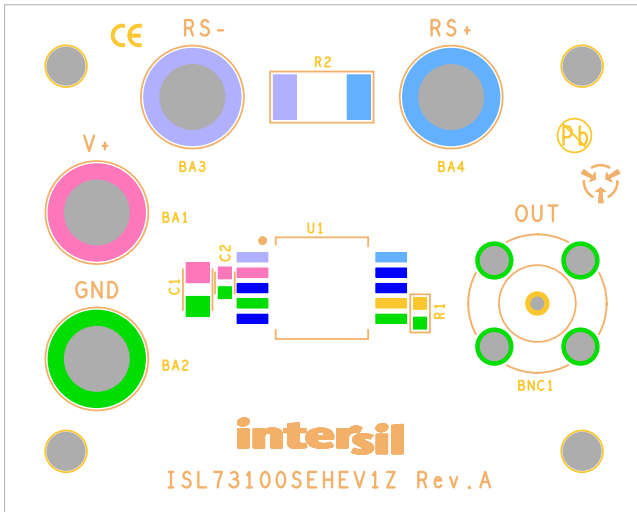

Figure 4. Silk Screen Top

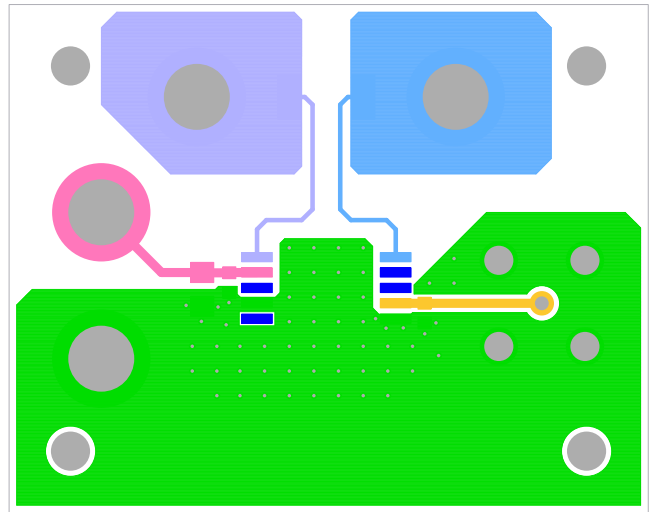

Figure 5. Top Layer Component Side

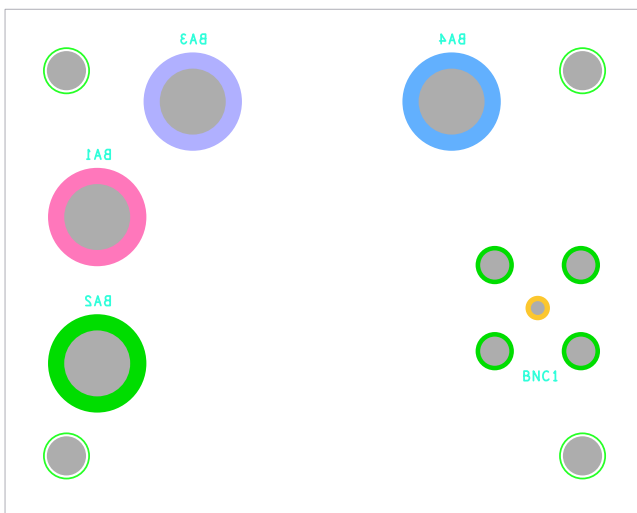

Figure 6. Silk Screen Bottom

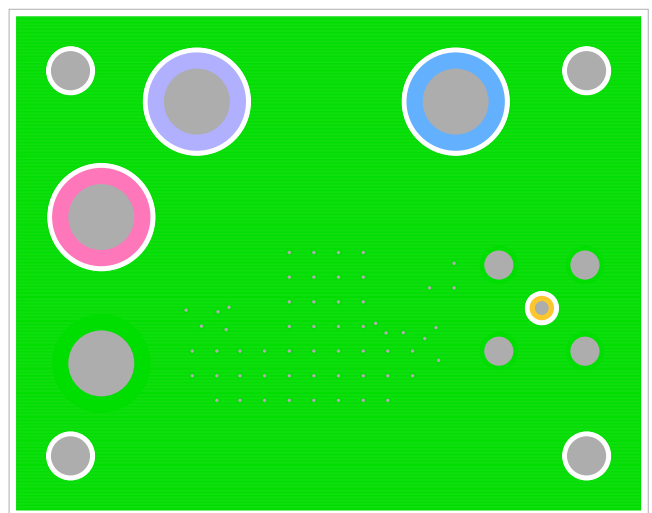

Figure 7. Bottom Layer Solder Side

### 5. Typical Performance Curves

Recommended operating conditions,  $V_+ = V_{RS+} = 12V$ ,  $V_- = 0V$ ,  $V_{SEN} = (V_{RS+} - V_{RS-})$ ,  $R_{OUT} = 5k\Omega$  and  $T_A = +25^\circ C$  unless otherwise specified.

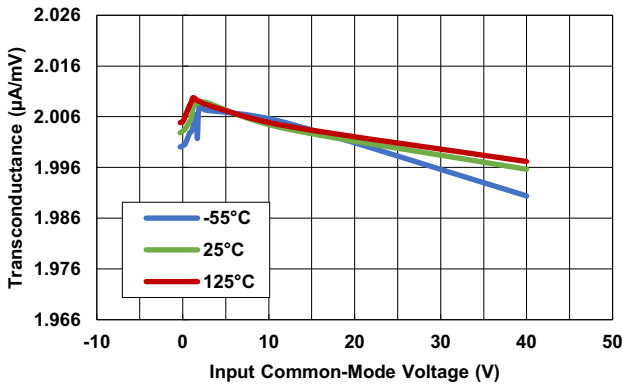

Figure 8. Transconductance,  $V_+ = 12V$

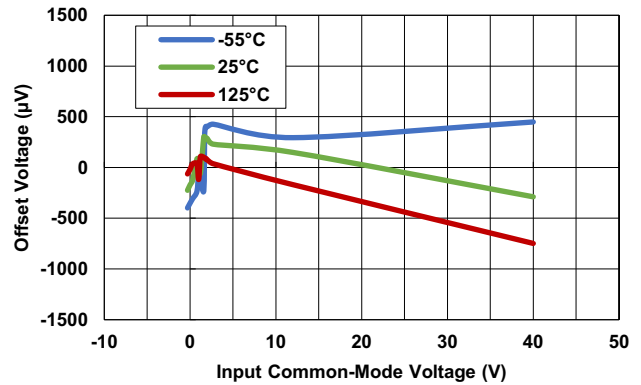

Figure 9. Common-Mode Voltage vs  $V_{OS}$ ,  $V_+ = 12V$

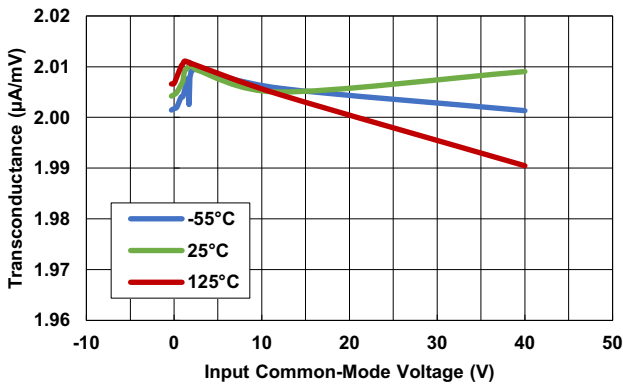

Figure 10. Transconductance,  $V_+ = 40V$

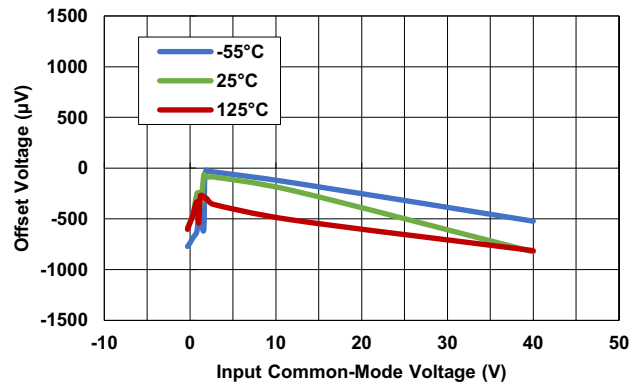

Figure 11. Common-Mode Voltage vs  $V_{OS}$ ,  $V_+ = 40V$

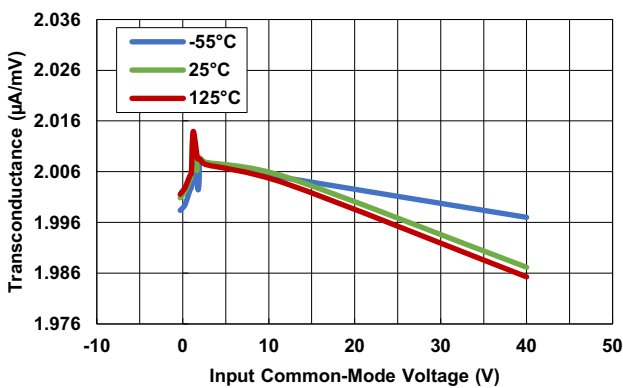

Figure 12. Transconductance,  $V_+ = 2.7V$

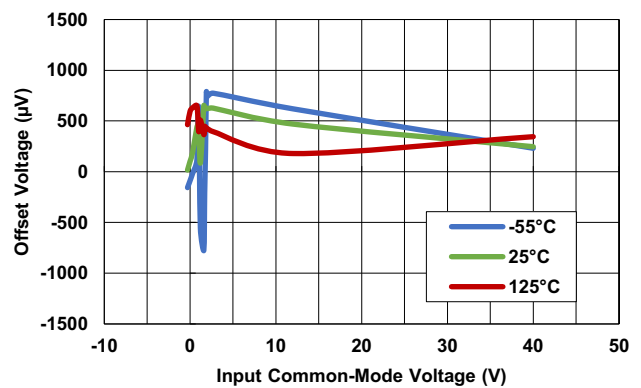

Figure 13. Common-Mode Voltage vs  $V_{OS}$ ,  $V_+ = 2.7V$



Recommended operating conditions,  $V_+ = V_{RS+} = 12V$ ,  $V_- = 0V$ ,  $V_{SEN} = (V_{RS+} - V_{RS-})$ ,  $R_{OUT} = 5k\Omega$  and  $T_A = +25^\circ C$  unless otherwise specified.

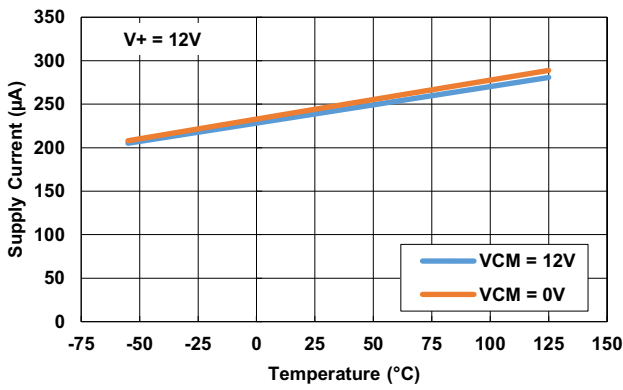

Figure 14. Supply Current,  $V_+ = 12V$

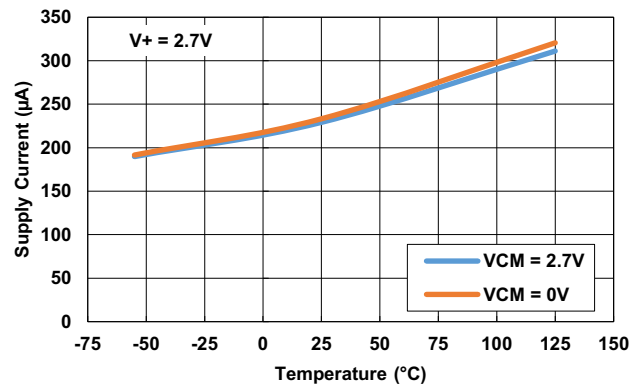

Figure 15. Supply Current,  $V_+ = 2.7V$

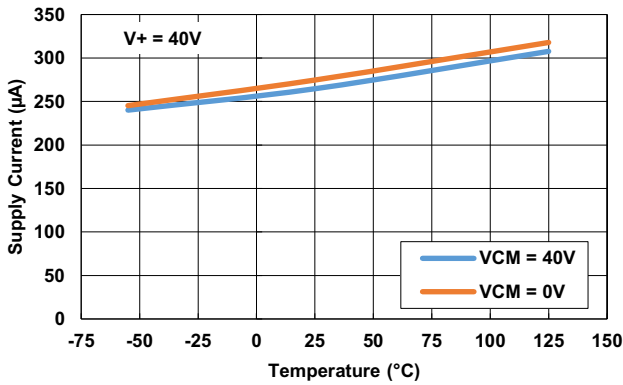

Figure 16. Supply Current,  $V_+ = 40V$

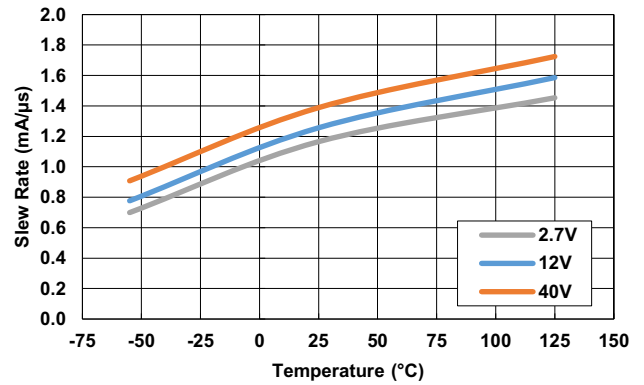

Figure 17. Slew Rate

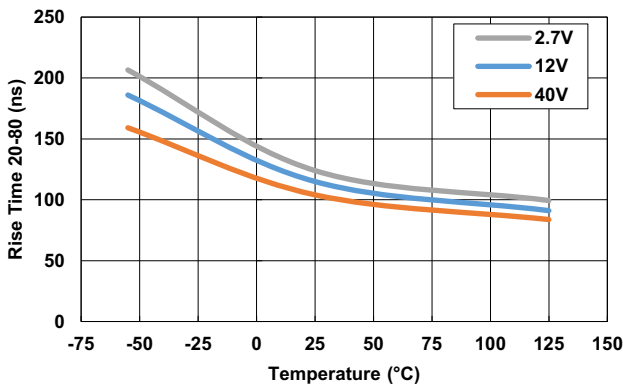

Figure 18. Rise Time

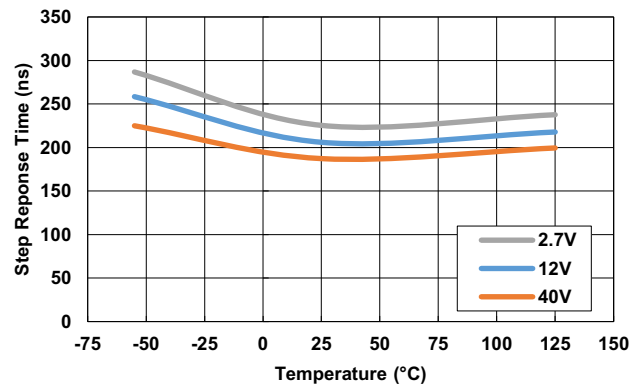

Figure 19. Step Response Time

Recommended operating conditions,  $V_+ = V_{RS+} = 12V$ ,  $V_- = 0V$ ,  $V_{SEN} = (V_{RS+} - V_{RS-})$ ,  $R_{OUT} = 5k\Omega$  and  $T_A = +25^\circ C$  unless otherwise specified.

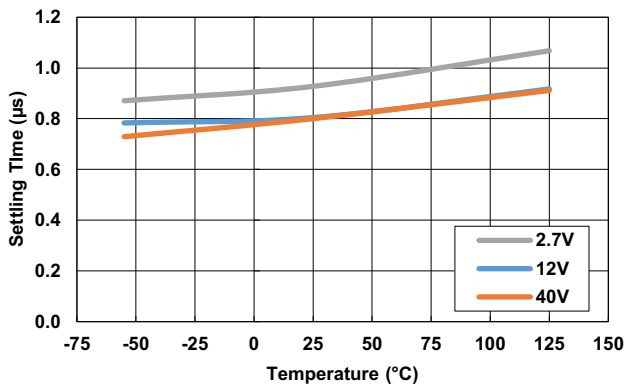

Figure 20. Settling Time

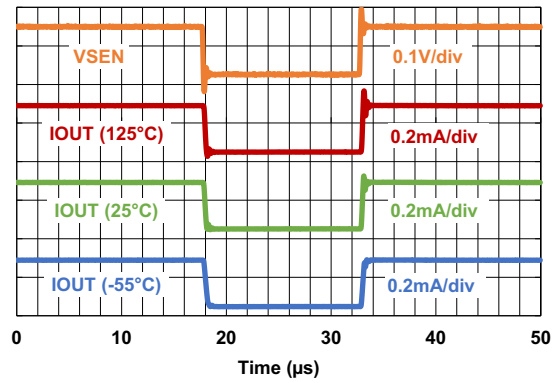

Figure 21. Input Step Response

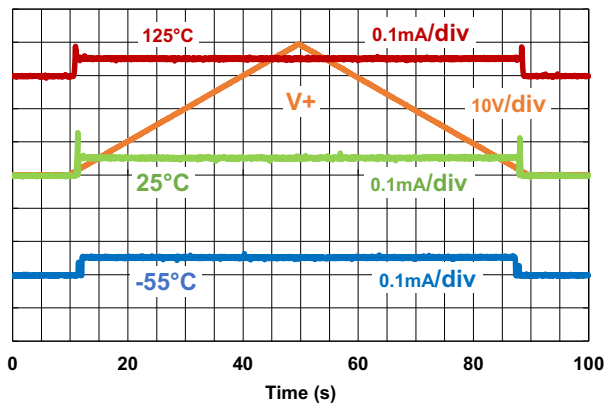

Figure 22. Power Supply Ramp at 1V/s

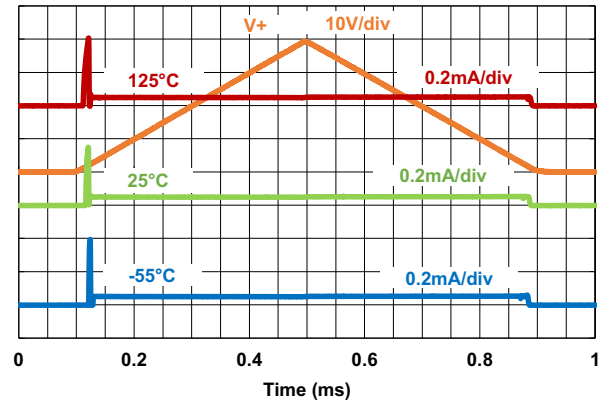

Figure 23. Power Supply Ramp at 1V/10µs

---

## 6. Revision History

Rev.	Date	Description
1.00	May.28.20	Initial release

## IMPORTANT NOTICE AND DISCLAIMER

RENESAS ELECTRONICS CORPORATION AND ITS SUBSIDIARIES (“RENESAS”) PROVIDES TECHNICAL SPECIFICATIONS AND RELIABILITY DATA (INCLUDING DATASHEETS), DESIGN RESOURCES (INCLUDING REFERENCE DESIGNS), APPLICATION OR OTHER DESIGN ADVICE, WEB TOOLS, SAFETY INFORMATION, AND OTHER RESOURCES “AS IS” AND WITH ALL FAULTS, AND DISCLAIMS ALL WARRANTIES, EXPRESS OR IMPLIED, INCLUDING, WITHOUT LIMITATION, ANY IMPLIED WARRANTIES OF MERCHANTABILITY, FITNESS FOR A PARTICULAR PURPOSE, OR NON-INFRINGEMENT OF THIRD PARTY INTELLECTUAL PROPERTY RIGHTS.

These resources are intended for developers skilled in the art designing with Renesas products. You are solely responsible for (1) selecting the appropriate products for your application, (2) designing, validating, and testing your application, and (3) ensuring your application meets applicable standards, and any other safety, security, or other requirements. These resources are subject to change without notice. Renesas grants you permission to use these resources only for development of an application that uses Renesas products. Other reproduction or use of these resources is strictly prohibited. No license is granted to any other Renesas intellectual property or to any third party intellectual property. Renesas disclaims responsibility for, and you will fully indemnify Renesas and its representatives against, any claims, damages, costs, losses, or liabilities arising out of your use of these resources. Renesas' products are provided only subject to Renesas' Terms and Conditions of Sale or other applicable terms agreed to in writing. No use of any Renesas resources expands or otherwise alters any applicable warranties or warranty disclaimers for these products.

(Rev.1.0 Mar 2020)

### Corporate Headquarters

TOYOSU FORESIA, 3-2-24 Toyosu,  
Koto-ku, Tokyo 135-0061, Japan  
[www.renesas.com](http://www.renesas.com)

### Contact Information

For further information on a product, technology, the most up-to-date version of a document, or your nearest sales office, please visit:  
[www.renesas.com/contact/](http://www.renesas.com/contact/)

### Trademarks

Renesas and the Renesas logo are trademarks of Renesas Electronics Corporation. All trademarks and registered trademarks are the property of their respective owners.

ISL73100SEHEV1Z