

## ISL6523EVAL1, ISL6524EVAL1

VRM8.5 Multiple-Output Motherboard Power Controllers

AN9925  
Rev 0.00  
May 2001

### Introduction

Today's high-performance desktop PC architectures demand power solutions featuring increased integration and reduced system-level costs. The Intersil ISL6523 and ISL6524 are complex controllers that integrate two and one, respectively, switching regulators, as well as two and three, respectively, linear controllers in a single package. The switching converters employ voltage-mode control architecture and high circuit performance is insured by the use of high gain-bandwidth product error amplifiers, high-accuracy references, and continuously adaptive shoot-through protection. The ICs offer a full range of protection features including overcurrent, overvoltage, as well as fault condition signaling and/or shutdown. All these combined features makes them ideal for microprocessor point-of-use power supply solutions. The ISL6523 and ISL6524 were designed to provide most of the active-state power needs of a typical Tualatin-based system. Some Coppermine-T and Celeron-based systems may also benefit from the ISL6523 or ISL6524. [1,2]

The ISL6523EVAL1 and ISL6524EVAL1 evaluation boards embody 4-output regulator solutions targeted at supplying power to the microprocessor core (1.05V - 1.825V), AGTL+ communication bus (1.2V), 4X AGP video (1.5V), and the ICH/MCH chip set core (1.8V).

### Evaluation Board Setup

#### Important!

The evaluation boards were not designed to support a continuous  $V_{CORE}$  output current in excess of 15A for extended periods of time. When testing either board to VOUT1 output currents in excess of 15A, restrict the ON time to less than 2 minutes, followed by at least 4 minutes OFF.

To facilitate the evaluation of the ISL6523 or ISL6524 in a typical setting, both evaluation boards were designed to be powered primarily from an ATX power supply [3]. However, the boards have hook-up turret terminals that allow them to be powered from standard laboratory power supplies.

#### Circuit Setup

Before connecting an input supply to the board, consult the circuit schematics and familiarize yourself with the various connection options offered by either evaluation board.

- **Set the Power-On Switch**

Ensure the 'ATX ON' (SW2) switch is in the off position (lever pointing away from 'ATX ON' marking).

- **Set Core Voltage SW1**

SW1, by means of the on-chip D/A converter, sets the output voltage for the  $V_{CORE}$  (VOUT1) output according to the

corresponding table detailed in the IC's data sheet. Consult the data sheet and set the status of the VID pins according to the core output voltage level you wish to regulate to.

- **Hookup Guide Using Standard Bench Supplies**

Connect a 5V, 16A supply to the +5VIN input, a 3.3V, 6A, supply to the +3.3VIN input, and a +12V, 100mA to the +12VIN input. Using a small jumper wire, connect the +5VIN and +5VSB inputs. Connect typical loads to all the evaluation board's outputs. Consult Table 1 for maximum loads supported by the design of the board in the configuration received; read the 'Modifications' section for information on modifying either evaluation board to meet your special needs.

- **Hookup Guide Using a Standard ATX Supply**

Connect the 20-pin ATX connector to the on-board J1 mating connector. Connect typical loads to all the evaluation board's outputs. Consult Table 1 for maximum loads supported by the design of the board in the configuration received; read the 'Modifications' section for information on modifying either evaluation board to meet your special needs.

### Operation

- **Provide Power to the Board**

Turn on the bench supplies. If using an ATX supply, plug it into the mains, and if it has an AC switch, turn it on. The 'ATX OFF' LED should light up, indicating the presence of 5V standby on board. Flip on the 'ATX ON' switch and the 'ATX OFF' LED should turn off. Shortly thereafter 'VTT PGOOD', 'POWER GOOD' and 'ATX PGOOD' LEDs should light up indicating power good status on all the outputs, as well as the input voltages provided by the ATX supply. If bench supplies are used, the 'ATX OFF' LED will only report the status of the SW2 switch, and the 'ATX PGOOD' LED will not light up under any circumstance; the other indicators will preserve their functionality.

- **Examine Start-Up Waveforms / Output Quality Under Varying Loads**

Start-up is immediate following application of bias voltage. Using an oscilloscope or other laboratory equipment, you may study the ramp-up and/or regulation of the controlled voltages under various loading conditions. For maximum versatility, we recommend the use of a programmable electronic load.

#### Fault Handling

In case of a fault condition (output undervoltage on the linear outputs, or overcurrent on the switching output), the entire IC shuts down and undergoes a re-start attempt. Three consecutive fault situations on any of the outputs (single fault on VOUT4, 1.8V output) latch the chip off. Review the appropriate data sheet section for more detail.

## Reference Design

### General

The evaluation board is built on 2-ounce, 4-layer, printed circuit board (contact Intersil for layout plots). Most of the components specific to the evaluation board alone, which are not needed in a real computer application, are placed on the bottom side of the board. Left on top of the evaluation board are the components necessary to exemplify a typical application, as well as the user interface (input/output terminals, test points, switches, etc.).

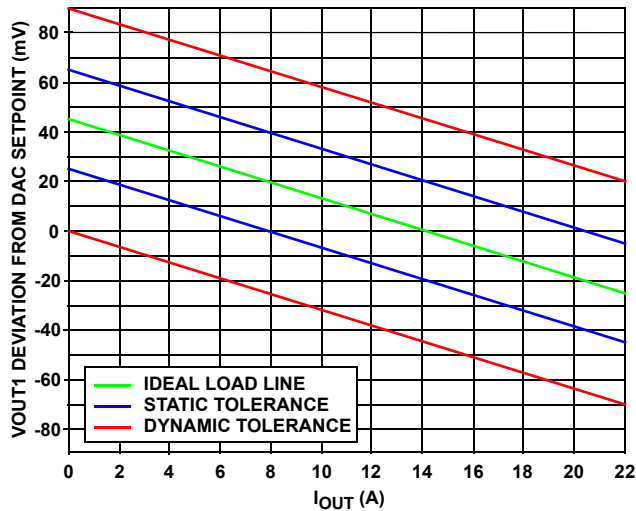

FIGURE 1. VOUT1 REGULATION ENVELOPE

### VOUT1 Regulation

The core regulator (VOUT1) was designed to meet the regulation envelope detailed in Figure 1. With a DAC-set regulation point of 1.750V, the output voltage conforms to the regulation limits shown. Although the droop pictured (difference between voltage at a lesser load and voltage at a higher load) will be the same regardless of the DAC setting, the offset shown will exhibit a proportional dependence. The resistive divider sets this offset at 2.57%. For example, the ideal load line at no load and 1.600V DAC setting will actually originate at 41mV positive offset.

### Design Envelope

Although an actual computer system application may have somewhat different requirements, the ISL6523EVAL1 and ISL6524EVAL1 boards were designed to meet the maximum output loading described in Table 1. Dynamic output tolerances and current ratings can be adjusted by properly selecting the components external to the ISL6523 or ISL6524.

TABLE 1. ISL6523EVAL1 MAXIMUM OUTPUT LOADING

OUTPUT VOLTAGE	I <sub>OUT</sub>	dI <sub>OUT</sub> /dt	TOLERANCE (STATIC/DYNAMIC)
<b>ISL6523EVAL1</b>			

TABLE 1. ISL6523EVAL1 MAXIMUM OUTPUT LOADING

OUTPUT VOLTAGE	I <sub>OUT</sub>	dI <sub>OUT</sub> /dt	TOLERANCE (STATIC/DYNAMIC)
V <sub>CORE</sub> (VOUT1)	22.0A(pk) 14.0A(avg)	20A/μs	Note 1
1.2VTT (VOUT2)	10.0A(pk) 4.0A(avg)	1A/μs	5%/9%
1.5VAGP (VOUT3)	3.0A(pk) 1.0A(avg)	1A/μs	3%/5%
1.8VMCH (VOUT4)	3.0A(pk) 1.0A(avg)	1A/μs	3%/5%
<b>ISL6524EVAL1</b>			
V <sub>CORE</sub> (VOUT1)	22.0A(pk) 14.0A(avg)	20A/μs	Note 1
1.2VTT (VOUT2)	6.0A(pk) 1.0A(avg)	1A/μs	5%/9%
1.5VAGP (VOUT3)	3.0A(pk) 1.0A(avg)	1A/μs	3%/5%
1.8VMCH (VOUT4)	3.0A(pk) 1.0A(avg)	1A/μs	3%/5%

NOTE:

- See Figure 1 for regulation tolerance details.

From a thermal performance perspective, do not operate the evaluation board for extended periods of time at output current levels exceeding the design envelope, as detailed in Table 1.

## Performance

Figures 2 through 8 depict the evaluation boards' performance during typical operational situations. To simulate minimum loading conditions, unless otherwise specified, the outputs were loaded with 65Ω resistive loads. As performance is very similar amongst the two evaluation boards, some characteristics were shown for only one of them, with the implicit understanding of similarity (as appropriate).

### Soft-Start Start-Up

Figure 2 shows a typical ISL6524EVAL1 start-up. For this capture, the ATX supply powering the board is turned on, at time T0. At time T1, the 1.8VMCH output starts ramping up, maintaining less than a 2V difference to the ATX3.3V output (sensed at the VAUX pin). At time T2, all input voltages reach regulation, and the 1.2VTT output starts its ramp-up. At time T3, the 1.2VTT output reaches VTT\_PGGOOD threshold and SS13 is released. Shortly after T3, the still rising SS24 brings the 1.8VMCH output in regulation. At T4, the SS13 clamp starts releasing outputs 1 and 3 (V<sub>CORE</sub> and 1.5VAGP), allowing them to ramp up to their regulation levels. At time T5, all outputs controlled by the ISL6524 are within regulation limits.

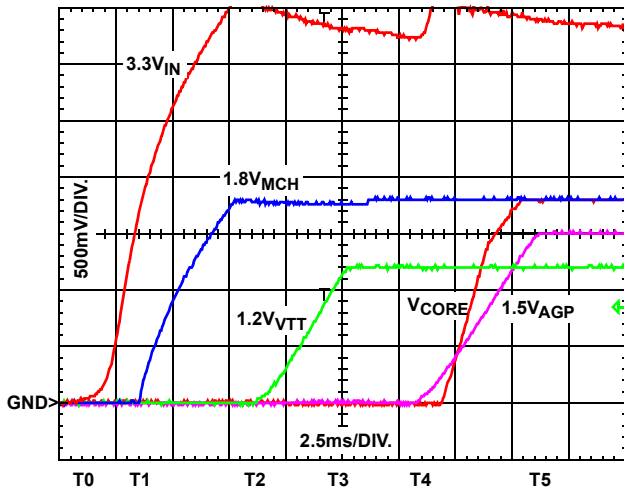

FIGURE 2. ISL6524EVAL1 START-UP

**Power Good Operation**

The ISL6523 and ISL6524 output two PGOOD indicators (both open-collector outputs). VTTPG is maintained high (pulled high by external pull-up resistor) as long as the 1.2VVTT output exceeds 1.08V (90%; as sensed at the VSEN pin). PGOOD is high for as long as V<sub>CORE</sub> is within power good limits (+/- 10%), all linears are above their undervoltage (UV) thresholds, and VTTPG is also high.

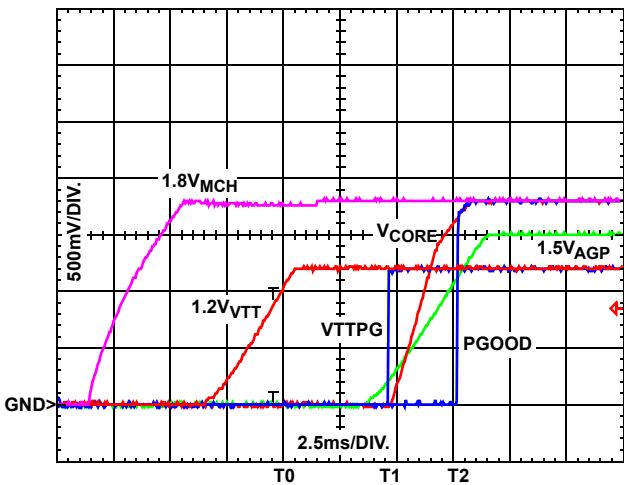

FIGURE 3. ISL6524EVAL1 POWER GOOD INDICATORS

Figure 3 details the operation of the power good functions. Following the 1.2VVTT output rising above 1.08V at time T0, VTTPG goes high simultaneously with enabling of the V<sub>CORE</sub> regulator, approximately 4.5ms later. This timing delay is given by the SS13 capacitor charging under a 28μA constant current, to about 1.25V (bottom of internal oscillator ramp). To reduce the delay, while preserving the same ramping rate for the V<sub>CORE</sub> output, insert a resistor (footprint provided; R18 and R22, respectively) of up to 100kΩ in series with the SS13 soft-

start capacitor (100kΩ resistor should yield a 1ms delay). At time T2, all conditions met, PGOOD goes high.

Note that the two power good pins are pulled high to VTT and V<sub>CORE</sub>, respectively. If TTL compatibility is desired, feel free to populate the provided spare footprints to ATX3.3V level (while de-populating the default pull-up resistors).

**Transient Response**

For transient response testing, the evaluation boards were subjected to the loading presented in Table 2. Each output response was recorded while the corresponding transient load was applied. The results are presented in Figures 4 and 5.

TABLE 2. TRANSIENT OUTPUT LOADING DESCRIPTION

OUTPUT	I <sub>OUT(MIN)</sub> (A)	I <sub>OUT(MAX)</sub> (A)	dI <sub>OUT/dt</sub> (A/μs)	FREQUENCY (Hz)
<b>ISL6523EVAL1</b>				
V <sub>CORE</sub> (VOUT1)	2.0	22.0	1.0	2500
1.2VVTT (VOUT2)	1.0	10.0	1.0	2000
1.5VAGP (VOUT3)	0.3	3.0	1.0	1500
1.8VMCH (VOUT4)	0.3	3.0	1.0	3000
<b>ISL6524EVAL1</b>				
V <sub>CORE</sub> (VOUT1)	2.0	22.0	1.0	2500
1.2VVTT (VOUT2)	0.5	6.0	1.0	2000
1.5VAGP (VOUT3)	0.3	3.0	1.0	1500
1.8VMCH (VOUT4)	0.3	3.0	1.0	3000

NOTE: All transients 30% duty cycle.

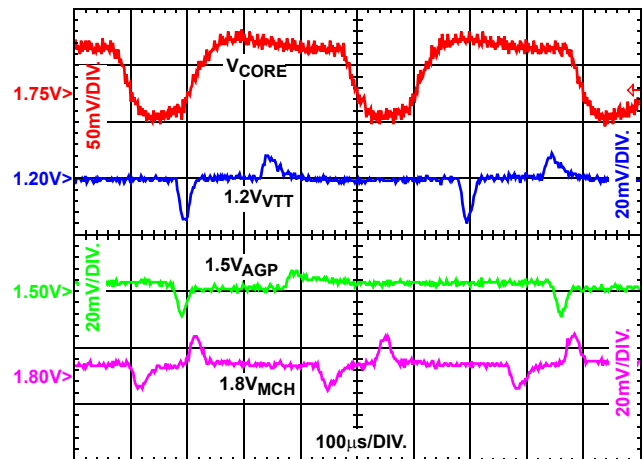

FIGURE 4. ISL6524EVAL1 OUTPUT TRANSIENT RESPONSE

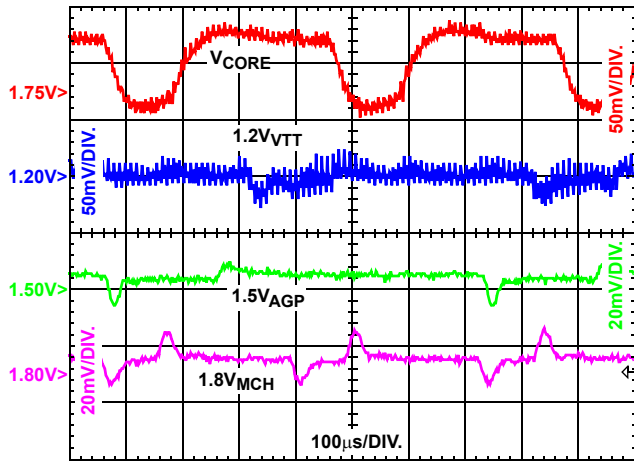

FIGURE 5. ISL6523EVAL1 OUTPUT TRANSIENT RESPONSE

### Output Short-Circuit Protection

In response to an overcurrent event on the switcher’s output, or an undervoltage event on any of the linear outputs, the entire chip is shut down. Figure 6 exemplifies such a scenario on VOUT1 of the ISL6524EVAL1. At time T0, an overload is applied to the core regulator output. Output current on this output increases, ultimately tripping the overcurrent (OC) protection. The fault counter is incremented and SS24 capacitor is discharged, timing a restart attempt. The restart takes place as the SS24 ramps up, and as the output voltage builds up, a second OC event is triggered at T1. The fault counter is incremented and the process repeats at time T2. At time T3 the fault counter reaches a count of three and the chip latches off. SS24 discharges down to about 1V, remaining at this level until bias voltage is removed.

consecutive fault events on output 2 will set the latch. Figure 7 details an example of such a situation where the overload is removed before the counter increments to three and latches the chip off. Time T0 marks the application of the current overload. At time T1 a second fault is recorded, but the overload is removed at time T2. Second restart attempt at time T3 is successful, bringing the output in regulation and resetting the fault counter.

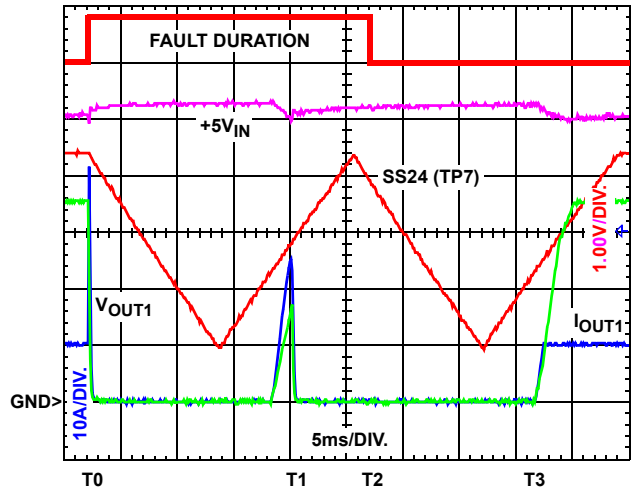

FIGURE 6B. ISL6524EVAL1 VOUT1 OVERCURRENT PROTECTION RESPONSE

### ISL6524EVAL1 Switching Regulator Efficiency

Figure 7 highlights the evaluation board’s conversion efficiency with only the switching section loaded ( $V_{CORE}$ ). The measurement was performed at room temperature with the linear outputs open and 100 LFM of air flow.

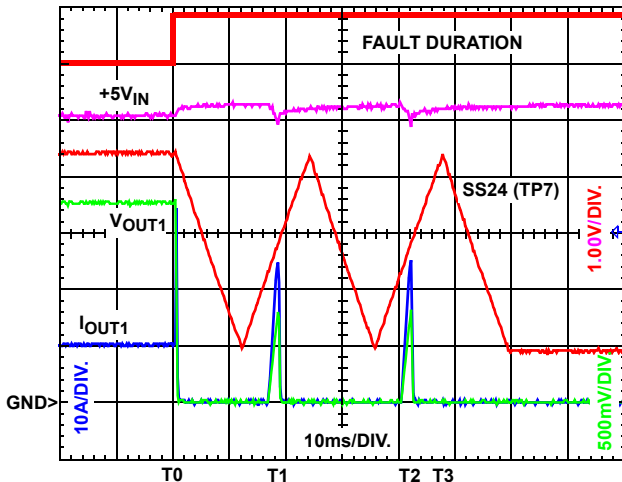

FIGURE 6A. ISL6524EVAL1 VOUT1 OVERCURRENT PROTECTION RESPONSE

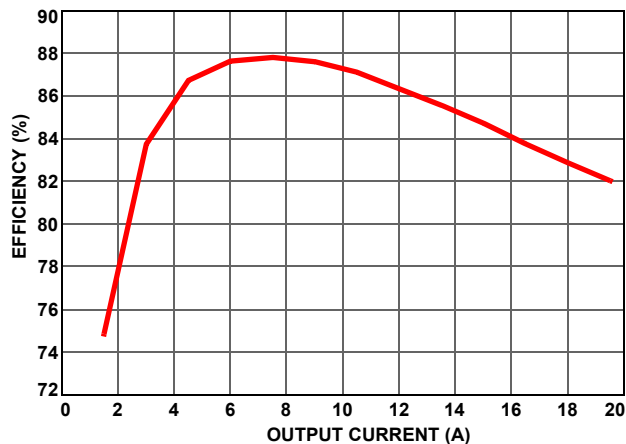

FIGURE 7. ISL6524EVAL1 SWITCHING REGULATOR MEASURED EFFICIENCY (ALL LINEAR OUTPUTS UNLOADED)

The chip has two independent fault counters. Three consecutive fault events on either outputs 1 or 3, or three

### Modifications

### Adjusting the Output Voltage

All linear outputs controlled by the ISL6523 and ISL6524 are adjustable by means of the resistive divider connecting the VSEN pins to their respective outputs. If adjusting the output voltage of the linear regulators, please pay attention to the recommended resistor value selection guidelines described in the data sheet. As the chips feature internal resistive dividers that set the output voltages, in order to minimize DC set-point interference with these resistors, it is recommended the parallel combination of the external resistive divider components be kept below 2kΩ to 5kΩ. Furthermore, the ISL6524 has provisions (by grounding the FIX pin) for bypassing the internal resistive dividers.

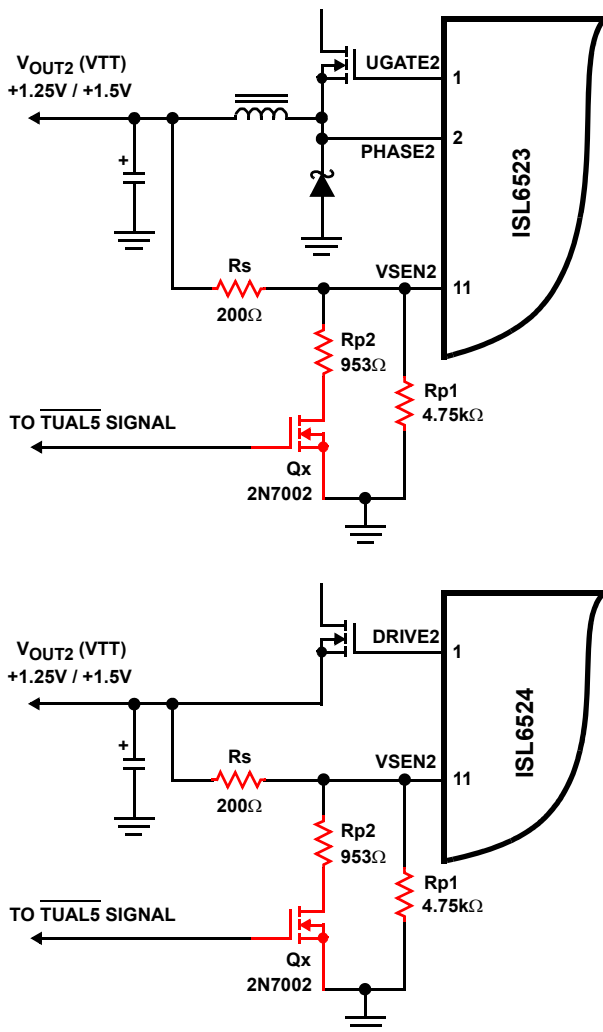

FIGURE 8. ISL6523, ISL6524 DUAL PROCESSOR GTL IMPLEMENTATION

### Recommended Implementation for Dual Processor GTL VTT and Universal AGP Support

As both ICs have fixed output voltages, it is necessary to implement an external circuit that helps switch a given output between two output voltage settings. The recommended circuits for the dual processor GTL VTT and universal AGP

support implementation are shown in Figures 8 and 9. As both the ISL6523 and ISL6524 were designed to regulate the voltage present at the VSEN2 pin to 1.2V, the resistive divider made out of Rs and Rp1 raise the DC regulation setting of this output to 1.25V, while Qx is off. When Qx is turned on (by means of a high TUAL5 signal), Rp2 is connected in parallel to Rp1, raising the DC regulation setting of this output to 1.5V.

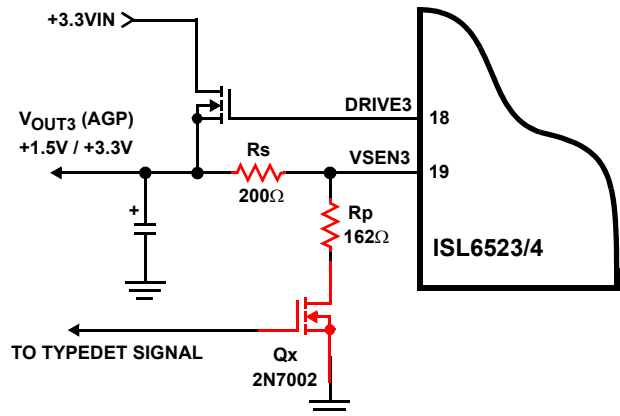

FIGURE 9. ISL6523, ISL6524 UNIVERSAL AGP SUPPORT IMPLEMENTATION

Same theory of operation applies to the circuit in Figure 9, with the exception that while Qx is off (low TYPEDET signal) the output is regulated to the internally-set 1.5V. A TYPEDET high signal turns on Qx and raises the output voltage to 3.3V. If AGP2X support is provided (3.3V output), remember that for a low voltage drop across the pass element, a low rDS(ON) MOSFET needs to be selected (Q4 in circuit schematics).

Important to mention is the fact that for either regulator on either IC, a sudden turn-on of Qx while the corresponding output is within regulation may trigger an undervoltage and/or overcurrent event, resulting in a chip shutdown and consequent re-start. If Qx is to be turned on while the outputs are regulating, an RC low-pass network needs be placed in series with its gate, in order to slow down its turn-on (if a pull-up is used to generate the logic high signal, then only the capacitor needs to be added). For this low-pass RC network, a time constant of about 200-300μs is recommended.

### Improving Output Voltage Tolerance

The key to improving the output voltage tolerance is identifying the parameters which affect it, and then taking steps toward improving them.

### AC Tolerance

High dV/dt spikes present in the output voltage waveform under highly dynamic load application (high dI/dt) are due to the ESR and the ESL of the output capacitance. These spikes coincide with the transient load's rising and falling edges, and decreasing their amplitude can be achieved by using lower

ESR/ESL output capacitors (such as surface-mount tantalum capacitors), and/or the addition of more ceramic capacitors, which have inherently low ESR/ESL.

### **DC Tolerance**

The no-load DC output voltage tolerance reduces virtually to the tolerance of the controller and that of the resistors in the DC feedback path. As the regulation tolerance of the controller is a design constraint, the only way to improve the DC regulation reduces to using precision resistors in the DC feedback path.

If output inductor based droop is employed (as shown in the default shipping configuration), the output voltage droop will also exhibit a temperature variation. As temperature will affect the DC resistance of the output inductor, the slope of the output droop will increase slightly with temperature.

### **VRM8.5 (Rev. 1.0) Compliance**

Although the transient response of the ISL6523EVAL1 and ISL6524EVAL1 evaluation boards may prove satisfactory, to build a well designed application around any of these two controllers requires careful consideration of all the parameters involved in the output regulation. Such careful analysis of these two designs suggests that to yield a 22A VRM8.5 compliant regulator, one more capacitor is needed in parallel with the VOUT1 output (same type as already populated). Additionally, to support the increased input RMS current of a

continuous 22A load, another input capacitor is also required in parallel with C1 (same type as C1).

However, compliance with this set of standards is not directly related to the use of a certain capacitor technology. Several solutions to meeting the output regulation requirements can be derived, using capacitors from various vendors, with distinctly different characteristics.

### **Conclusion**

The ISL6523EVAL1 and ISL6524EVAL1 evaluation boards showcase highly integrated approaches to providing system power control in late Pentium 3 computer systems. Typical implementation requires minimum effort and a reduced number of external components, yet provides a full array of standard features.

### **References**

For Intersil documents available on the internet, see web site [www.intersil.com/](http://www.intersil.com/)

- [1] *ISL6523 Data Sheet*, Intersil Corporation, Power Management Products Division, Document No. FN9024, 2001.
- [2] *ISL6524 Data Sheet*, Intersil Corporation, Power Management Products Division, Document No. FN9015, 2001.
- [3] ATX Specification, Version 2.02, October 1998, Intel Corporation (<http://www.teleport.com/~atx/>).

**ISL6523EVAL1 Schematic**

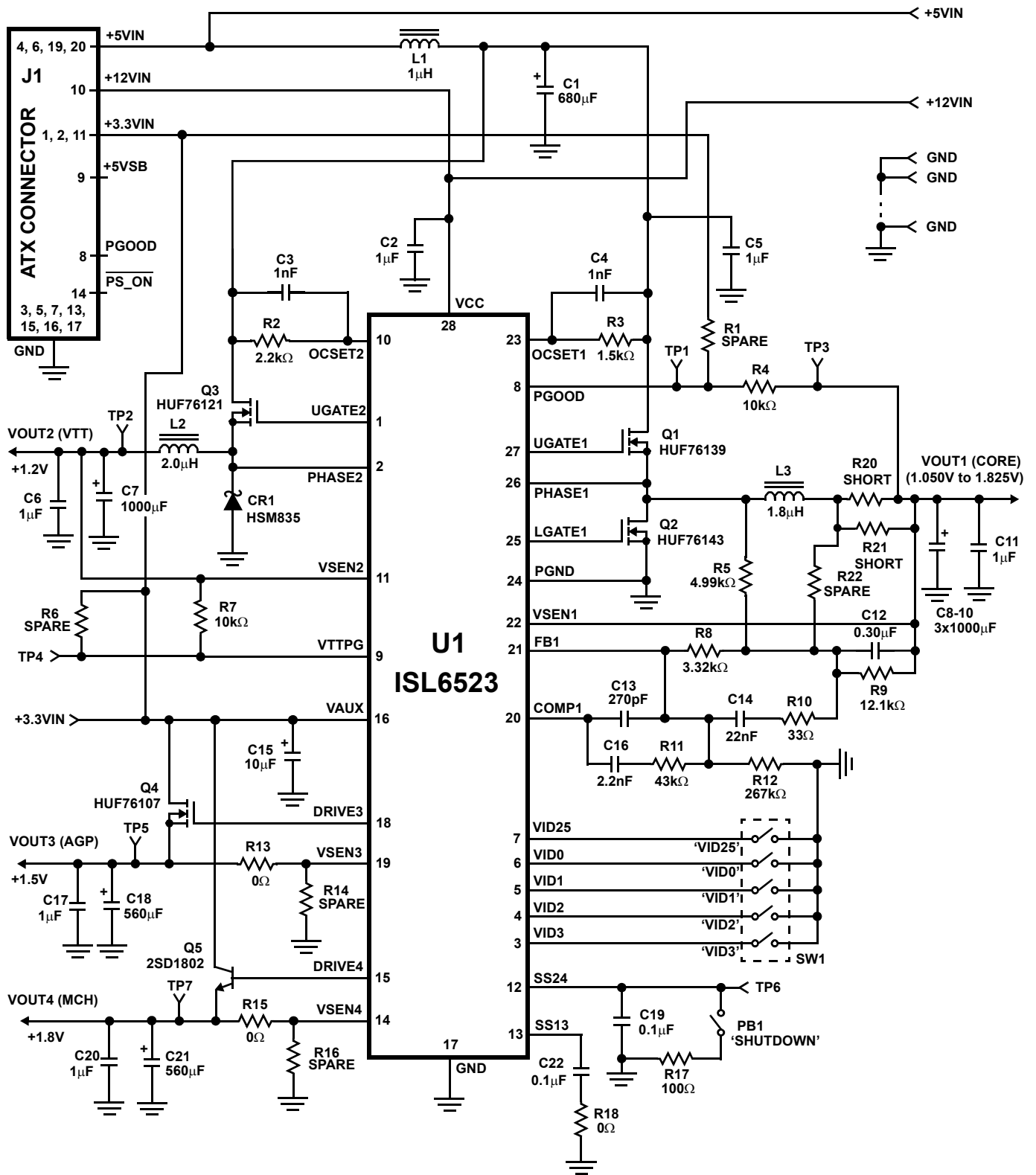

**ISL6523EVAL1 Schematic** (Continued)

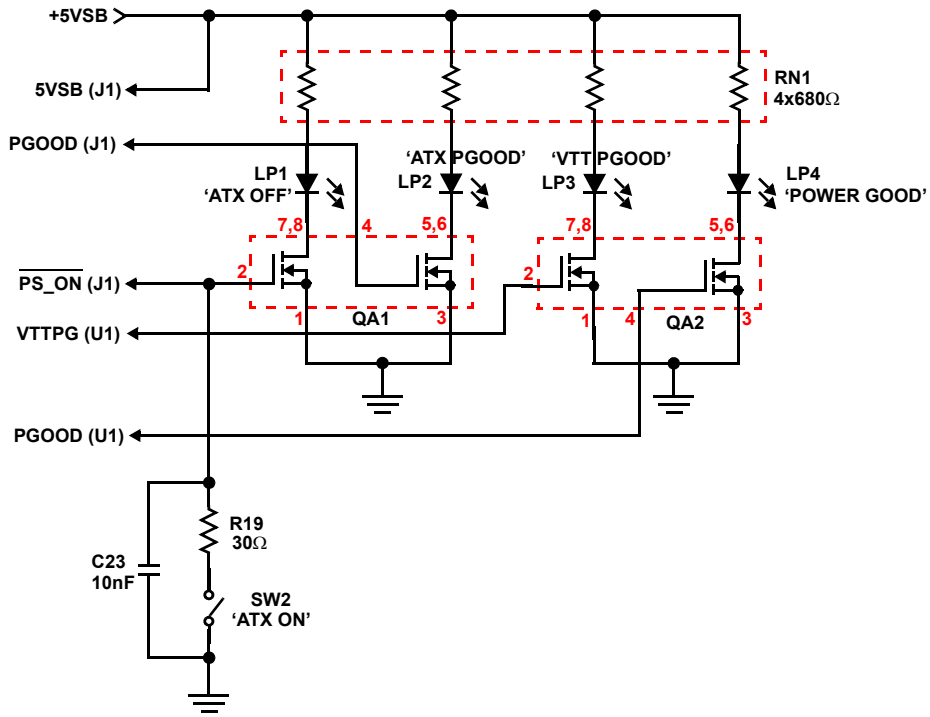

**ISL6524EVAL1 Schematic**

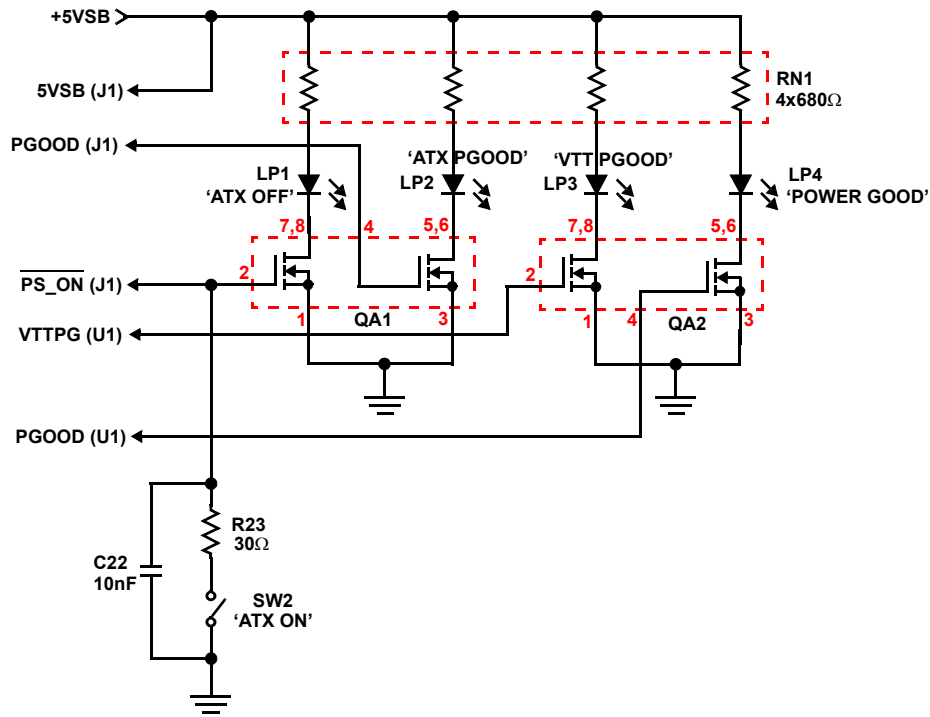



**ISL6524EVAL1 Schematic (Continued)**

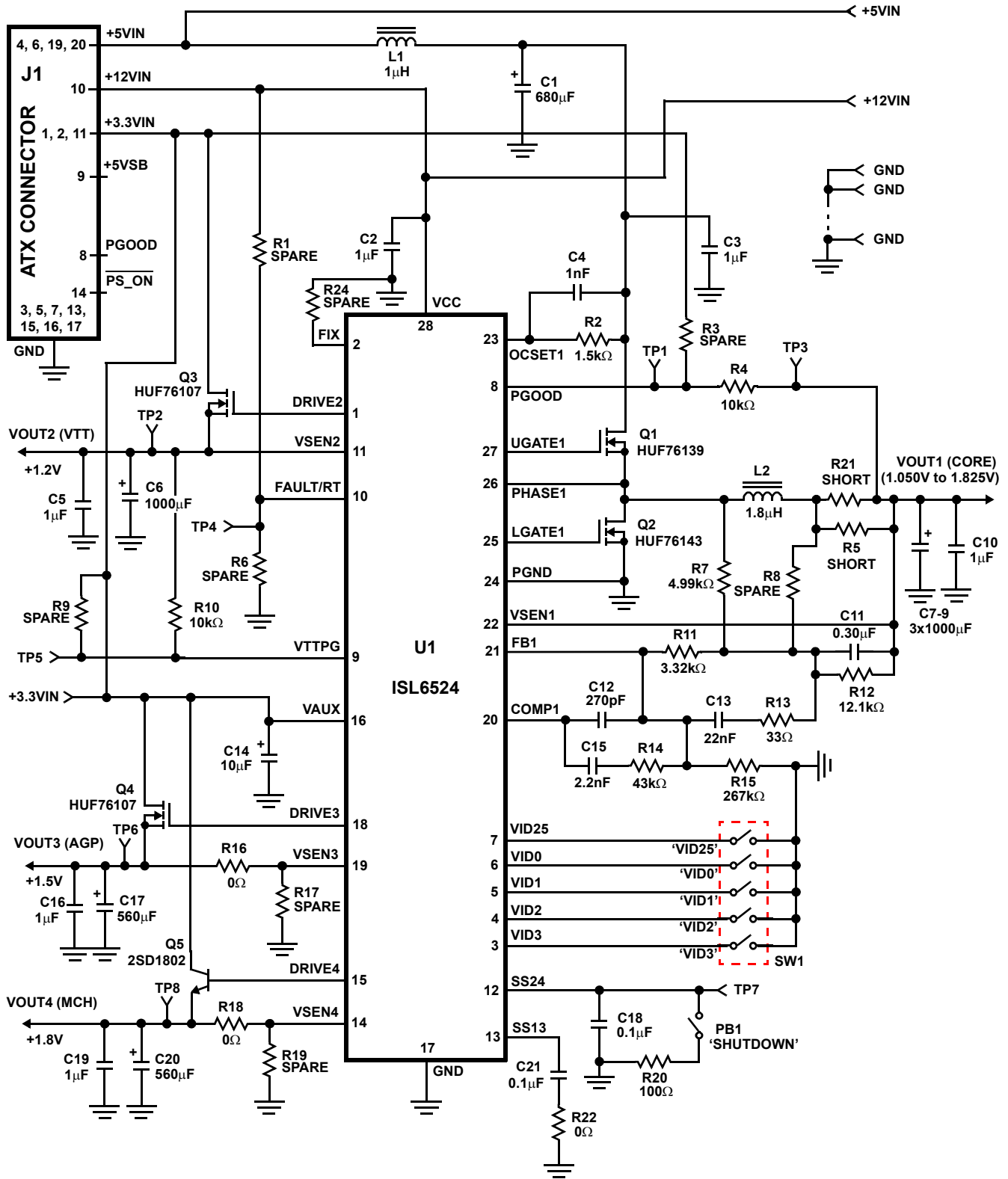

**ISL6523EVAL1 Bill of Materials**

REFERENCE DESIGNATOR	PART NUMBER	DESCRIPTION	CASE / FOOTPRINT	MANUF. OR VENDOR	QTY
C1	6SP680M	Oscon Capacitor, 6.3V, 680 $\mu$ F	10 x 10.5	Sanyo	1
C2	1206YC105KAT2A	Ceramic Capacitor, X7R, 16V, 1.0 $\mu$ F	1206	AVX	1
C3, 4	0603YC102KAT2A	Ceramic Capacitor, X7R, 16V, 1.0nF	0603	AVX	2
C5, 6, 11, 17, 20	1206YC105KAT2A	Ceramic Capacitor, X7R, 10V, 1.0 $\mu$ F	0805	AVX	5
C7-10	2SP1000M	Oscon Capacitor, 2V, 1000 $\mu$ F	10 x 10.5	Sanyo	4
C12	0805ZC304KAT2A	Ceramic Capacitor, X7R, 10V, 0.30 $\mu$ F	0805	AVX	1
C13	06033C271KAT2A	Ceramic Capacitor, X7R, 25V, 270pF	0603	AVX	1
C14	06033C223KAT2A	Ceramic Capacitor, X7R, 25V, 22nF	0603	AVX	1
C15	TAJB106M006R	Tantalum Capacitor, 6.3V, 10 $\mu$ F	3.0 x 4.0	AVX	1
C16	06033C222KAT2A	Ceramic Capacitor, X7R, 25V, 2.2nF	0603	Any	1
C18, C21	4SP560M	Oscon Capacitor, 4V, 560 $\mu$ F	8 x 10.5	Sanyo	2
C19, C22	0603ZC104KAT2A	Ceramic Capacitor, X7R, 10V, 0.1 $\mu$ F	0603	AVX	2
C23	0603YC103KAT2A	Ceramic Capacitor, X7R, 16V, 10nF	0603	AVX	1
CR1	HSM835J	Schottky Diode, 35V, 8A	DO-214AB	Microsemi	1
J1	39-29-9203	20-pin Mini-Fit, Jr.™ Header Connector		Molex	1
L1	1.0 $\mu$ H Inductor	6 Turns of 16AWG on T44-52 Core	8 x 15	Any	1
L2	2.0 $\mu$ H Inductor	8 Turns of 16AWG on T50-52 Core	8 x 17	Any	1
L3	1.8 $\mu$ H Inductor	6 Turns of 16-18AWG on T68-52 Core	10 x 21	Any	1
LP1-4	L63111CT-ND	Miniature LED, Through-Board Indicator		Digikey	4
Q1	HUF76139S3S	UltraFET™ MOSFET, 30V, 7.5m $\Omega$	TO-263AB	Intersil	1
Q2	HUF76143S3S	UltraFET™ MOSFET, 30V, 5.5m $\Omega$	TO-263AB	Intersil	1
Q3	HUF76121D3S	UltraFET™ MOSFET, 30V, 23m $\Omega$	TO-252AA	Intersil	1
Q4	HUF76107D3S	UltraFET™ MOSFET, 30V, 52m $\Omega$	TO-252AA	Intersil	1
Q5	2SD1802	NPN Bipolar, 50V, 3A	TO-252AA	Sanyo	1
QA1, 2	ZXMD63N02X	Small-Signal Dual MOSFET, 20V, 0.2 $\Omega$	MSOP-8	Zetex	2
PB1	P8007S-ND	Push-Button, Miniature		Digikey	1
R2	2.2k $\Omega$	Resistor, 5%, 0.1W	0603	Any	1
R3	1.5k $\Omega$	Resistor, 5%, 0.1W	0603	Any	1
R4, 7	10k $\Omega$	Resistor, 5%, 0.1W	0603	Any	2
R5	4.99k $\Omega$	Resistor, 1%, 0.1W	0603	Any	1
R8	3.32k $\Omega$	Resistor, 1%, 0.1W	0603	Any	1
R9	12.1k $\Omega$	Resistor, 1%, 0.1W	0603	Any	1
R10	33 $\Omega$	Resistor, 5%, 0.1W	0603	Any	1
R11	43k $\Omega$	Resistor, 5%, 0.1W	0603	Any	1
R12	267k $\Omega$	Resistor, 1%, 0.1W	0603	Any	1
R13, 15, 18	0 $\Omega$	Shorting Resistor	0603	Any	3
R17	100 $\Omega$	Resistor, 5%, 0.1W	0603	Any	1
R19	30 $\Omega$	Resistor, 5%, 0.1W	0603	Any	1
R1, 6, 14, 16	Spare		0603		
R20, 21	Spare		2512		
R22	Spare		0603		
RN1	Y9681CT-ND	4-Resistor Network, 680 $\Omega$ , 5%, 0.1W	3.2 x 1.6	Digikey	1
SW1	CKN3057-ND	Miniature Dip Slide Switch, 5-Pole		Digikey	1
SW2	GT12MSCKE	Miniature Switch, Single Pole, Single Throw		C&K	1
TP2, 3, 5, 7	1314353-00	Test Point, Scope Probe		Tektronics	4
TP1, 4, 6	SPCJ-123-01	Test Point		Jolo	3
U1	ISL6523CB	Dual Switcher and Dual Linear Controller	SOIC-28	Intersil	1
+5VSB, +5VIN, +3.3VIN, +12VIN, +V <sub>OUT1</sub> , +V <sub>OUT2</sub> , +V <sub>OUT3</sub> , +V <sub>OUT4</sub> , GND	1514-2	Terminal Post		Keystone	16

**ISL6524EVAL1 Bill of Materials**

REFERENCE DESIGNATOR	PART NUMBER	DESCRIPTION	CASE / FOOTPRINT	MANUF. OR VENDOR	QTY
C1	6SP680M	Oscon Capacitor, 6.3V, 680 $\mu$ F	10 x 10.5	Sanyo	1
C2	1206YC105KAT2A	Ceramic Capacitor, X7R, 16V, 1.0 $\mu$ F	1206	AVX	1
C4	0603YC102KAT2A	Ceramic Capacitor, X7R, 16V, 1.0nF	0603	AVX	2
C3, 5, 10, 16, 19	1206YC105KAT2A	Ceramic Capacitor, X7R, 10V, 1.0 $\mu$ F	0805	AVX	5
C6-9	2SP1000M	Oscon Capacitor, 2V, 1000 $\mu$ F	10 x 10.5	Sanyo	4
C11	0805ZC304KAT2A	Ceramic Capacitor, X7R, 10V, 0.30 $\mu$ F	0805	AVX	1
C12	06033C271KAT2A	Ceramic Capacitor, X7R, 25V, 270pF	0603	AVX	1
C13	06033C223KAT2A	Ceramic Capacitor, X7R, 25V, 22nF	0603	AVX	1
C14	TAJB106M006R	Tantalum Capacitor, 6.3V, 10 $\mu$ F	3.0 x 4.0	AVX	1
C15	06033C222KAT2A	Ceramic Capacitor, X7R, 25V, 2.2nF	0603	Any	1
C17, C20	4SP560M	Oscon Capacitor, 4V, 560 $\mu$ F	8 x 10.5	Sanyo	2
C18, C21	0603ZC104KAT2A	Ceramic Capacitor, X7R, 10V, 0.1 $\mu$ F	0603	AVX	2
C22	0603YC103KAT2A	Ceramic Capacitor, X7R, 16V, 10nF	0603	AVX	1
J1	39-29-9203	20-pin Mini-Fit, Jr. <sup>TM</sup> Header Connector		Molex	1
L1	1.0 $\mu$ H Inductor	6 Turns of 16AWG on T44-52 Core	8 x 15	Any	1
L2	1.8 $\mu$ H Inductor	6 Turns of 16-18AWG on T68-52 Core	10 x 21	Any	1
LP1-4	L63111CT-ND	Miniature LED, Through-Board Indicator		Digikey	4
Q1	HUF76139S3S	UltraFET <sup>TM</sup> MOSFET, 30V, 7.5m $\Omega$	TO-263AB	Intersil	1
Q2	HUF76143S3S	UltraFET <sup>TM</sup> MOSFET, 30V, 5.5m $\Omega$	TO-263AB	Intersil	1
Q3, Q4	HUF76107D3S	UltraFET <sup>TM</sup> MOSFET, 30V, 52m $\Omega$	TO-252AA	Intersil	2
Q5	2SD1802	NPN Bipolar, 50V, 3A	TO-252AA	Sanyo	1
QA1, QA2	ZXMD63N02X	Small-Signal Dual MOSFET, 20V, 0.2 $\Omega$	MSOP-8	Zetex	2
PB1	P8007S-ND	Push-Button, Miniature		Digikey	1
R2	1.5k $\Omega$	Resistor, 5%, 0.1W	0603	Any	1
R7	4.99k $\Omega$	Resistor, 1%, 0.1W	0603	Any	1
R4, R10	10k $\Omega$	Resistor, 5%, 0.1W	0603	Any	2
R11	3.32k $\Omega$	Resistor, 1%, 0.1W	0603	Any	1
R12	12.1k $\Omega$	Resistor, 1%, 0.1W	0603	Any	1
R13	33 $\Omega$	Resistor, 5%, 0.1W	0603	Any	1
R14	43k $\Omega$	Resistor, 5%, 0.1W	0603	Any	1
R15	267k $\Omega$	Resistor, 1%, 0.1W	0603	Any	1
R16, R18, R22	0 $\Omega$	Shorting Resistor	0603	Any	3
R20	100 $\Omega$	Resistor, 5%, 0.1W	0603	Any	1
R23	30 $\Omega$	Resistor, 5%, 0.1W	0603	Any	1
R1, R3, R6, R8, R9, R17, R19, R24	Spare		0603		
R5, R21	Spare		2512		
RN1	Y9681CT-ND	4-Resistor Network, 680 $\Omega$ , 5%, 0.1W	3.2 x 1.6	Digikey	1
SW1	CKN3057-ND	Miniature Dip Slide Switch, 5-Pole		Digikey	1
SW2	GT12MSCKE	Miniature Switch, Single Pole, Single Throw		C&K	1
TP2, 3, 6, 8	1314353-00	Test Point, Scope Probe		Tektronics	4
TP1, 4, 5, 7	SPCJ-123-01	Test Point		Jolo	4
U1	ISL6524CB	Dual Switcher and Dual Linear Controller	SOIC-28	Intersil	1
+5VSB, +5VIN, +3.3VIN, +12VIN, +V <sub>OUT1</sub> , +V <sub>OUT2</sub> , +V <sub>OUT3</sub> , +V <sub>OUT4</sub> , GND	1514-2	Terminal Post		Keystone	16

## Notice

1. Descriptions of circuits, software and other related information in this document are provided only to illustrate the operation of semiconductor products and application examples. You are fully responsible for the incorporation or any other use of the circuits, software, and information in the design of your product or system. Renesas Electronics disclaims any and all liability for any losses and damages incurred by you or third parties arising from the use of these circuits, software, or information.
2. Renesas Electronics hereby expressly disclaims any warranties against and liability for infringement or any other claims involving patents, copyrights, or other intellectual property rights of third parties, by or arising from the use of Renesas Electronics products or technical information described in this document, including but not limited to, the product data, drawings, charts, programs, algorithms, and application examples.
3. No license, express, implied or otherwise, is granted hereby under any patents, copyrights or other intellectual property rights of Renesas Electronics or others.
4. You shall not alter, modify, copy, or reverse engineer any Renesas Electronics product, whether in whole or in part. Renesas Electronics disclaims any and all liability for any losses or damages incurred by you or third parties arising from such alteration, modification, copying or reverse engineering.
5. Renesas Electronics products are classified according to the following two quality grades: "Standard" and "High Quality". The intended applications for each Renesas Electronics product depends on the product's quality grade, as indicated below.  
"Standard": Computers; office equipment; communications equipment; test and measurement equipment; audio and visual equipment; home electronic appliances; machine tools; personal electronic equipment; industrial robots; etc.  
"High Quality": Transportation equipment (automobiles, trains, ships, etc.); traffic control (traffic lights); large-scale communication equipment; key financial terminal systems; safety control equipment; etc.  
Unless expressly designated as a high reliability product or a product for harsh environments in a Renesas Electronics data sheet or other Renesas Electronics document, Renesas Electronics products are not intended or authorized for use in products or systems that may pose a direct threat to human life or bodily injury (artificial life support devices or systems; surgical implantations; etc.), or may cause serious property damage (space system; undersea repeaters; nuclear power control systems; aircraft control systems; key plant systems; military equipment; etc.). Renesas Electronics disclaims any and all liability for any damages or losses incurred by you or any third parties arising from the use of any Renesas Electronics product that is inconsistent with any Renesas Electronics data sheet, user's manual or other Renesas Electronics document.
6. When using Renesas Electronics products, refer to the latest product information (data sheets, user's manuals, application notes, "General Notes for Handling and Using Semiconductor Devices" in the reliability handbook, etc.), and ensure that usage conditions are within the ranges specified by Renesas Electronics with respect to maximum ratings, operating power supply voltage range, heat dissipation characteristics, installation, etc. Renesas Electronics disclaims any and all liability for any malfunctions, failure or accident arising out of the use of Renesas Electronics products outside of such specified ranges.
7. Although Renesas Electronics endeavors to improve the quality and reliability of Renesas Electronics products, semiconductor products have specific characteristics, such as the occurrence of failure at a certain rate and malfunctions under certain use conditions. Unless designated as a high reliability product or a product for harsh environments in a Renesas Electronics data sheet or other Renesas Electronics document, Renesas Electronics products are not subject to radiation resistance design. You are responsible for implementing safety measures to guard against the possibility of bodily injury, injury or damage caused by fire, and/or danger to the public in the event of a failure or malfunction of Renesas Electronics products, such as safety design for hardware and software, including but not limited to redundancy, fire control and malfunction prevention, appropriate treatment for aging degradation or any other appropriate measures. Because the evaluation of microcomputer software alone is very difficult and impractical, you are responsible for evaluating the safety of the final products or systems manufactured by you.
8. Please contact a Renesas Electronics sales office for details as to environmental matters such as the environmental compatibility of each Renesas Electronics product. You are responsible for carefully and sufficiently investigating applicable laws and regulations that regulate the inclusion or use of controlled substances, including without limitation, the EU RoHS Directive, and using Renesas Electronics products in compliance with all these applicable laws and regulations. Renesas Electronics disclaims any and all liability for damages or losses occurring as a result of your noncompliance with applicable laws and regulations.
9. Renesas Electronics products and technologies shall not be used for or incorporated into any products or systems whose manufacture, use, or sale is prohibited under any applicable domestic or foreign laws or regulations. You shall comply with any applicable export control laws and regulations promulgated and administered by the governments of any countries asserting jurisdiction over the parties or transactions.
10. It is the responsibility of the buyer or distributor of Renesas Electronics products, or any other party who distributes, disposes of, or otherwise sells or transfers the product to a third party, to notify such third party in advance of the contents and conditions set forth in this document.
11. This document shall not be reprinted, reproduced or duplicated in any form, in whole or in part, without prior written consent of Renesas Electronics.
12. Please contact a Renesas Electronics sales office if you have any questions regarding the information contained in this document or Renesas Electronics products.  
(Note 1) "Renesas Electronics" as used in this document means Renesas Electronics Corporation and also includes its directly or indirectly controlled subsidiaries.  
(Note 2) "Renesas Electronics product(s)" means any product developed or manufactured by or for Renesas Electronics.

(Rev.4.0-1 November 2017)



### SALES OFFICES

Renesas Electronics Corporation

<http://www.renesas.com>

Refer to "<http://www.renesas.com/>" for the latest and detailed information.

**Renesas Electronics America Inc.**  
1001 Murphy Ranch Road, Milpitas, CA 95035, U.S.A.  
Tel: +1-408-432-8888, Fax: +1-408-434-5351

**Renesas Electronics Canada Limited**  
9251 Yonge Street, Suite 8309 Richmond Hill, Ontario Canada L4C 9T3  
Tel: +1-905-237-2004

**Renesas Electronics Europe Limited**  
Dukes Meadow, Millboard Road, Bourne End, Buckinghamshire, SL8 5FH, U.K  
Tel: +44-1628-651-700, Fax: +44-1628-651-804

**Renesas Electronics Europe GmbH**  
Arcadiastrasse 10, 40472 Düsseldorf, Germany  
Tel: +49-211-6503-0, Fax: +49-211-6503-1327

**Renesas Electronics (China) Co., Ltd.**  
Room 1709 Quantum Plaza, No.27 ZhichunLu, Haidian District, Beijing, 100191 P. R. China  
Tel: +86-10-8235-1155, Fax: +86-10-8235-7679

**Renesas Electronics (Shanghai) Co., Ltd.**  
Unit 301, Tower A, Central Towers, 555 Langao Road, Putuo District, Shanghai, 200333 P. R. China  
Tel: +86-21-2226-0888, Fax: +86-21-2226-0999

**Renesas Electronics Hong Kong Limited**  
Unit 1601-1611, 16/F., Tower 2, Grand Century Place, 193 Prince Edward Road West, Mongkok, Kowloon, Hong Kong  
Tel: +852-2265-6688, Fax: +852-2886-9022

**Renesas Electronics Taiwan Co., Ltd.**  
13F, No. 363, Fu Shing North Road, Taipei 10543, Taiwan  
Tel: +886-2-8175-9600, Fax: +886-2-8175-9670

**Renesas Electronics Singapore Pte. Ltd.**  
80 Bendemeer Road, Unit #06-02 Hyflux Innovation Centre, Singapore 339949  
Tel: +65-6213-0200, Fax: +65-6213-0300

**Renesas Electronics Malaysia Sdn.Bhd.**  
Unit 1207, Block B, Menara Amcorp, Amcorp Trade Centre, No. 18, Jln Persiaran Barat, 46050 Petaling Jaya, Selangor Darul Ehsan, Malaysia  
Tel: +60-3-7955-9390, Fax: +60-3-7955-9510

**Renesas Electronics India Pvt. Ltd.**  
No.777C, 100 Feet Road, HAL 2nd Stage, Indiranagar, Bangalore 560 038, India  
Tel: +91-80-67208700, Fax: +91-80-67208777

**Renesas Electronics Korea Co., Ltd.**  
17F, KAMCO Yangjae Tower, 262, Gangnam-daero, Gangnam-gu, Seoul, 06265 Korea  
Tel: +82-2-558-3737, Fax: +82-2-558-5338