

To our customers,

---

## Old Company Name in Catalogs and Other Documents

---

On April 1<sup>st</sup>, 2010, NEC Electronics Corporation merged with Renesas Technology Corporation, and Renesas Electronics Corporation took over all the business of both companies. Therefore, although the old company name remains in this document, it is a valid Renesas Electronics document. We appreciate your understanding.

Renesas Electronics website: <http://www.renesas.com>

April 1<sup>st</sup>, 2010  
Renesas Electronics Corporation

Issued by: Renesas Electronics Corporation (<http://www.renesas.com>)

Send any inquiries to <http://www.renesas.com/inquiry>.

## Notice

1. All information included in this document is current as of the date this document is issued. Such information, however, is subject to change without any prior notice. Before purchasing or using any Renesas Electronics products listed herein, please confirm the latest product information with a Renesas Electronics sales office. Also, please pay regular and careful attention to additional and different information to be disclosed by Renesas Electronics such as that disclosed through our website.
2. Renesas Electronics does not assume any liability for infringement of patents, copyrights, or other intellectual property rights of third parties by or arising from the use of Renesas Electronics products or technical information described in this document. No license, express, implied or otherwise, is granted hereby under any patents, copyrights or other intellectual property rights of Renesas Electronics or others.
3. You should not alter, modify, copy, or otherwise misappropriate any Renesas Electronics product, whether in whole or in part.
4. Descriptions of circuits, software and other related information in this document are provided only to illustrate the operation of semiconductor products and application examples. You are fully responsible for the incorporation of these circuits, software, and information in the design of your equipment. Renesas Electronics assumes no responsibility for any losses incurred by you or third parties arising from the use of these circuits, software, or information.
5. When exporting the products or technology described in this document, you should comply with the applicable export control laws and regulations and follow the procedures required by such laws and regulations. You should not use Renesas Electronics products or the technology described in this document for any purpose relating to military applications or use by the military, including but not limited to the development of weapons of mass destruction. Renesas Electronics products and technology may not be used for or incorporated into any products or systems whose manufacture, use, or sale is prohibited under any applicable domestic or foreign laws or regulations.
6. Renesas Electronics has used reasonable care in preparing the information included in this document, but Renesas Electronics does not warrant that such information is error free. Renesas Electronics assumes no liability whatsoever for any damages incurred by you resulting from errors in or omissions from the information included herein.
7. Renesas Electronics products are classified according to the following three quality grades: “Standard”, “High Quality”, and “Specific”. The recommended applications for each Renesas Electronics product depends on the product’s quality grade, as indicated below. You must check the quality grade of each Renesas Electronics product before using it in a particular application. You may not use any Renesas Electronics product for any application categorized as “Specific” without the prior written consent of Renesas Electronics. Further, you may not use any Renesas Electronics product for any application for which it is not intended without the prior written consent of Renesas Electronics. Renesas Electronics shall not be in any way liable for any damages or losses incurred by you or third parties arising from the use of any Renesas Electronics product for an application categorized as “Specific” or for which the product is not intended where you have failed to obtain the prior written consent of Renesas Electronics. The quality grade of each Renesas Electronics product is “Standard” unless otherwise expressly specified in a Renesas Electronics data sheets or data books, etc.
  - “Standard”: Computers; office equipment; communications equipment; test and measurement equipment; audio and visual equipment; home electronic appliances; machine tools; personal electronic equipment; and industrial robots.
  - “High Quality”: Transportation equipment (automobiles, trains, ships, etc.); traffic control systems; anti-disaster systems; anti-crime systems; safety equipment; and medical equipment not specifically designed for life support.
  - “Specific”: Aircraft; aerospace equipment; submersible repeaters; nuclear reactor control systems; medical equipment or systems for life support (e.g. artificial life support devices or systems), surgical implantations, or healthcare intervention (e.g. excision, etc.), and any other applications or purposes that pose a direct threat to human life.
8. You should use the Renesas Electronics products described in this document within the range specified by Renesas Electronics, especially with respect to the maximum rating, operating supply voltage range, movement power voltage range, heat radiation characteristics, installation and other product characteristics. Renesas Electronics shall have no liability for malfunctions or damages arising out of the use of Renesas Electronics products beyond such specified ranges.
9. Although Renesas Electronics endeavors to improve the quality and reliability of its products, semiconductor products have specific characteristics such as the occurrence of failure at a certain rate and malfunctions under certain use conditions. Further, Renesas Electronics products are not subject to radiation resistance design. Please be sure to implement safety measures to guard them against the possibility of physical injury, and injury or damage caused by fire in the event of the failure of a Renesas Electronics product, such as safety design for hardware and software including but not limited to redundancy, fire control and malfunction prevention, appropriate treatment for aging degradation or any other appropriate measures. Because the evaluation of microcomputer software alone is very difficult, please evaluate the safety of the final products or system manufactured by you.
10. Please contact a Renesas Electronics sales office for details as to environmental matters such as the environmental compatibility of each Renesas Electronics product. Please use Renesas Electronics products in compliance with all applicable laws and regulations that regulate the inclusion or use of controlled substances, including without limitation, the EU RoHS Directive. Renesas Electronics assumes no liability for damages or losses occurring as a result of your noncompliance with applicable laws and regulations.
11. This document may not be reproduced or duplicated, in any form, in whole or in part, without prior written consent of Renesas Electronics.
12. Please contact a Renesas Electronics sales office if you have any questions regarding the information contained in this document or Renesas Electronics products, or if you have any other inquiries.

(Note 1) “Renesas Electronics” as used in this document means Renesas Electronics Corporation and also includes its majority-owned subsidiaries.

(Note 2) “Renesas Electronics product(s)” means any product developed or manufactured by or for Renesas Electronics.

16

H8S Series User System Interface Cable  
For H8S Series Compact Emulator

Microcomputer Development Environment System

User's Manual



**Microcomputer  
Development Environment System**

**CE2000**

**H8S Series User System Interface Cable  
For H8S/2215 TFP-120  
User's Manual**

**H8S Series User System Interface Cable for Compact Emulator  
User's Manual**

Published by : Renesas System Solutions Asia Pte. Ltd.

Date : April 1<sup>st</sup>, 2003, Version 1.0

Copyright(C) Renesas System Solutions Asia Pte. Ltd. All rights reserved.

**Trademarks**

**(a) General**

All brand or product names used in this manual are trademarks or registered trademarks of their respective companies or organizations.

## IMPORTANT INFORMATION

- **READ this user's manual before using this emulator product.**
- **KEEP the user's manual handy for future reference.**

**Do not attempt to use the emulator product until you fully understand its mechanism.**

### **Emulator Product:**

Throughout this document, the term 'emulator product' shall be defined as the following products produced only by Renesas System Solutions Asia Pte. Ltd.:

- Emulation system (SD01CE2238)
- User system interface cable (SD01UC2214TB2)
- User system interface cable (SD01UC2238FA0B)
- User system interface cable (SD01UC2215TC0)

The user system or a host computer is not included in this definition.

### **Purpose of the Emulator Product:**

This emulator product is a software and hardware development tool for systems employing the H8S series microcomputer. This emulator product must only be used for the above purpose.

### **Improvement Policy:**

Renesas System Solutions Asia Pte. Ltd. (hereafter collectively referred to as Renesas) pursues a policy of continuing improvement in design, performance, and safety of the emulator product. Renesas reserves the right to change, wholly or partially, the specifications, design, user's manual, and other documentation at any time without notice.

### **Target User of the Emulator Product:**

This emulator product should only be used by those who have carefully read and thoroughly understood the information and restrictions contained in the user's manual. Do not attempt to use the emulator product until you fully understand its mechanism.

It is highly recommended that first-time users be instructed by those who are well versed in the operation of emulator product.

## **LIMITED WARRANTY**

Renesas warrants its emulator products to be manufactured in accordance with published specifications and free from defects in material and/or workmanship. Renesas, at its option, will repair or replace any emulator products returned intact to the factory, transportation charges prepaid, which Renesas, upon inspection, shall determine to be defective in material and/or workmanship. The foregoing shall constitute the sole remedy for any breach of Renesas warranty. See the Renesas warranty booklet for details on the warranty period. This warranty extends only to you, the original Purchaser. It is not transferable to anyone who subsequently purchases the emulator product from you. Renesas is not liable for any claim made by a third party or made by you for a third party.

## **DISCLAIMER**

RENESAS MAKES NO WARRANTIES, EITHER EXPRESSED OR IMPLIED, ORAL OR WRITTEN, EXCEPT AS PROVIDED HEREIN, INCLUDING WITHOUT LIMITATION THEREOF, WARRANTIES AS TO MARKETABILITY, MECRCHANTABILITY, FITNESS FOR ANY PARTICULAR PURPOSE OR USE, OR AGAINST INFRINGEMENT OF ANY PATENT. IN NO EVENT SHALL RENESAS BE LIABLE FOR ANY DIRECT, INCIDENTAL OR CONSEQUENTIAL DAMAGES OF ANY NATURE, OR LOSSES OR EXPENSES RESULTING FROM ANY DEFECTIVE EMULATOR PRODUCT, THE USE OF ANY EMULATOR PRODUCT OR ITS DOCUMENTATION, EVEN IF ADVISED OF THE POSSIBILITY OF SUCH DAMAGES. EXCEPT AS EXPRESSLY STATED OTHERWISE IN THIS WARRANTY, THIS EMULATOR PRODUCT IS SOLD "AS IS". AND YOU MUST ASSUME ALL RISK FOR THE USE AND RESULTS OBTAINED FROM THE EMULATOR PRODUCT.



**State Law:**

Some states do not allow the exclusion or limitation of implied warranty or liability for incidental or consequential damages, so the above limitation or exclusion may not apply to you. This warranty gives you specific legal rights, and you may have other rights which may vary from state to state.

**The Warranty is Void in the Following Cases:**

Renesas shall have no liability or legal responsibility for any problems caused by misuse, abuse, misapplication, neglect, improper handling, installation, repair or modifications of the emulator product without Renesas's prior written consent or any problems caused by the user system.

**All Right Reserved:**

This user's manual and emulator product are copyrighted and Renesas reserves all rights. No part of this user's manual, all or part, may be reproduced or duplicated in any form, in hardcopy or machine-readable form, by any means available without Renesas's prior written consent.

**Other Important Things to Keep in Mind:**

1. Circuitry and other examples described herein are meant merely to indicate the characteristics and performance of Renesas Technology's semiconductor products. Renesas assumes no responsibility for any intellectual property claims or other problems that may result from applications based on the examples described herein.
2. No license is granted by implication or otherwise under any patents or other rights of any third party or Renesas.
3. **MEDICAL APPLICATIONS:** Renesas Technology's products are not authorized for use in **MEDICAL APPLICATIONS** without the written consent of the appropriate officer of Renesas Technology (Asia Sales company). Such use includes, but is not limited to, use in life support systems. Buyers of Renesas Technology's products are requested to notify the relevant Renesas Technology (Asia Sales offices) when planning to use the products in **MEDICAL APPLICATIONS**.

**Figures:**

Some figures in this user's manual may show items different from your actual system.

**Limited Anticipation of Danger:**

Renesas cannot anticipate every possible circumstance that might involve a potential hazard. The warnings in this user's manual and on the emulator product are therefore not all inclusive. Therefore, you must use the emulator product safely at your own risk.

# PREFACE

## **About this manual**

This manual explains how to link the user cable to the Compact Emulator.

- Section 1** Introduction  
Highlights the system package and specification.
- Section 2** Connection Procedures  
Explains how to link the user system to the emulator via the user cable.
- Section 3** Dimensions of the User System Cable Head  
Details the dimensions of the user system cable head needed.
- Section 4** Installing MCU to the user system  
Describes the steps involved to place the MCU into the socket.
- Section 5** Warning  
Emphasizes the precautionary measures when handling the user cable.

**Assumptions**

This manual assumes that the user has a working knowledge of

- Renesas Compact Emulator
- General Hardware Interface Circuitry

**Related Manuals:**

- Compact Emulator User's Manual
- H8S/2215 Series Hardware Manual

# Table of Contents

|   |          |
|---|----------|
| <b>SECTION 1. INTRODUCTION.....</b>                             | <b>1</b> |
| 1.1 GENERAL DESCRIPTION .....                                   | 1        |
| 1.2 IC SOCKET TYPE.....   | 1        |
| 1.3 CONFIGURATION .....   | 2        |
| 1.4 COMPONENTS.....   | 2        |
| <b>SECTION 2. CONNECTION PROCEDURES.....</b>                    | <b>3</b> |
| 2.1 CONNECTING USER SYSTEM INTERFACE CABLE TO THE EMULATOR..... | 3        |
| 2.2 CONNECTING USER SYSTEM INTERFACE CABLE TO USER SYSTEM.....  | 4        |
| 2.2.1 <i>Soldering IC Socket</i> .....                          | 4        |
| 2.2.2 <i>Jumpers Setting of the User Cable</i> .....            | 5        |
| <b>SECTION 3. DIMENSIONS OF USER CABLE SYSTEM .....</b>         | <b>6</b> |
| <b>SECTION 4. INSTALLING MCU TO THE USER SYSTEM.....</b>        | <b>8</b> |
| <b>SECTION 5. WARNINGS .....</b>                                | <b>9</b> |
| <b>RENESAS TECHNOLOGY (ASIA SALES OFFICES)</b>                  |          |

## List of Figures

|            |  |   |
|------------|--|---|
| Figure 1.1 | SD01UC2215TC0 User System Interface Cable .....            | 2 |
| Figure 2.1 | Connect User System Interface Cable to the Emulator.....   | 3 |
| Figure 2.2 | Connecting User System Interface Cable to User System..... | 4 |
| Figure 2.3 | Jumper Setting.....  | 5 |
| Figure 3.1 | PCB Footprint of User System Interface Cable Head.....     | 6 |
| Figure 3.2 | User System Interface Cable (TOP View).....                | 7 |
| Figure 3.3 | User System Interface Cable (Side View) .....              | 7 |
| Figure 4.1 | Installing MCU to User System.....                         | 8 |

## Section 1. Introduction

### 1.1 General Description

The user system interface cable (SD01UC2215TC0) connects the Compact Emulator (CE2000-H8S/2238) to the IC socket for a TFP 120-pin package. This user cable is able to support the H8S/2215 microcomputer.

This cable is required for the correct emulation of the H8S/2215 MCU. Unlike other user cables, it can work with or without the user target system.

### 1.2 IC Socket Type

The recommended IC socket used on the user system is from Yamaichi Electronics Co., Ltd. The part number for the TFP 120-pin package IC socket is given below:

- **IC149-120-043-B5**

### 1.3 Configuration

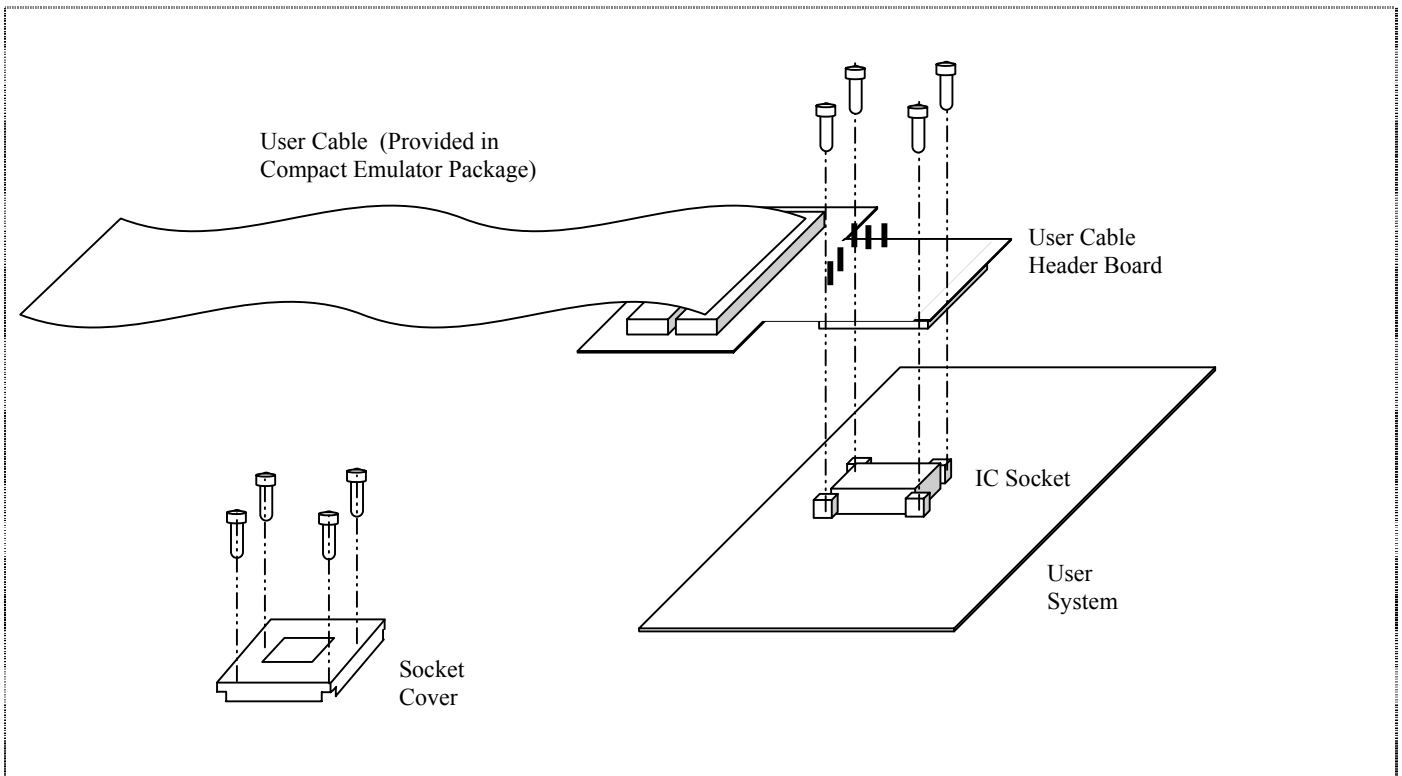

**Figure 1.1 SD01UC2215TC0 User System Interface Cable**

- Align pin 1 of the Adapter of user cable header to IC socket on the user system.
- Install Adapter to the socket with tightened screws.
- Connect the other ends of the 2 × 80-way connectors from the Compact Emulator to the User Cable header board.

### 1.4 Components

| No. | Component               | Quantity | Remarks   |
|-----|-------------------------|----------|---|
| 1   | User Cable Header Board | 1        |   |
| 2   | IC Socket               | 1        | For TFP 120-pin package                           |
| 3   | Socket Cover            | 1        | For installing the MCU                            |
| 4   | Screws (M2×12)          | 4        | For fastening cable head (with four flat washers) |
| 5   | Screws (M2×8)           | 4        | For installing MCU (with four flat washers)       |
| 6   | User's Manual           | 1        |   |

Note: The 2 × 80-way user cable assemblies are already provided in the Compact Emulator package.

## Section 2. Connection Procedures

**WARNING:** Always switch OFF the user system and the emulator product before the USER SYSTEM INTERFACE CABLE is connected to or removed from either of the boards. Before connecting, make sure that pin 1 is correctly aligned. Failure to do so may result in a FIRE HAZARD, which may damage the user system and the emulator product. PERSONAL INJURY may also be resulted.

### 2.1 Connecting User System Interface Cable to The Emulator

To connect the cable body to the emulator, follow the instructions below:

- Make sure the user system and emulator are powered off.
- Open the cover at the bottom of the emulator.
- Align the connectors on the cable body with those on the emulator according to the specified number, insert the cable body connectors to those on the emulator until they are locked. Refer to figure 2.1.

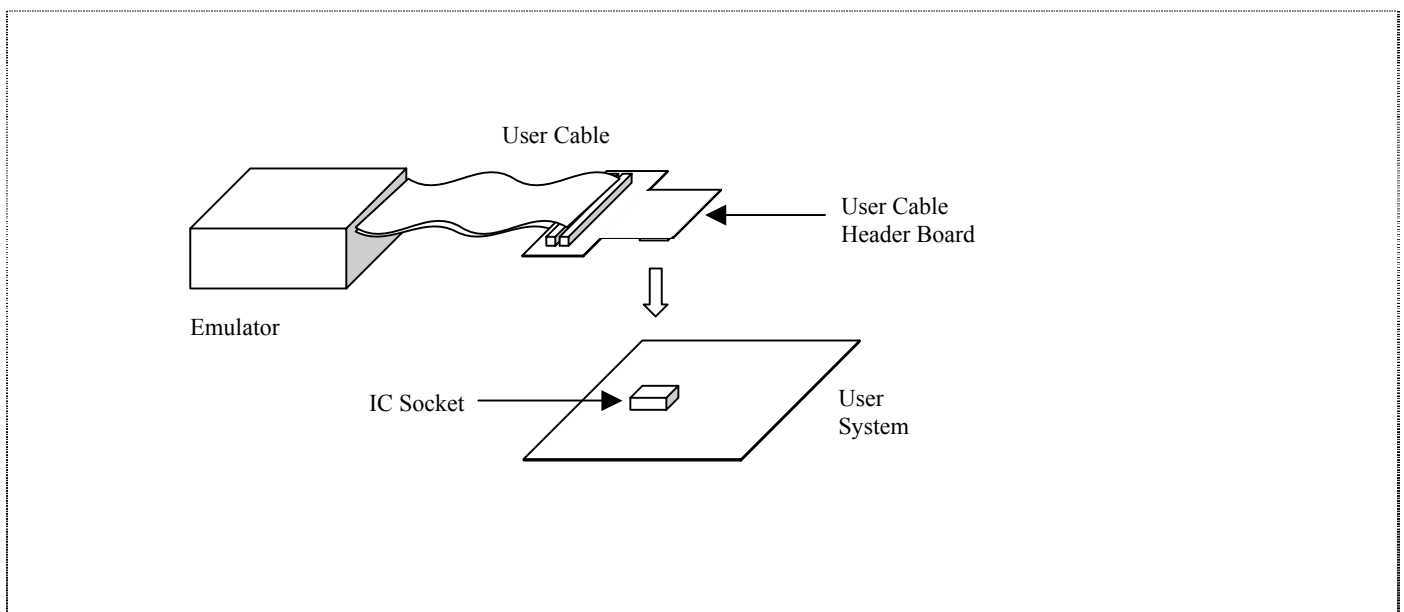

**Figure 2.1** Connect User System Interface Cable to the Emulator



## 2.2 Connecting User System Interface Cable to User System

### 2.2.1 Soldering IC Socket

- Apply epoxy resin adhesive to the corner guides and bottom face of an IC socket for the TFP 120-pin package and fasten it to the user system.
- Align pin 1 on the IC socket with pin 1 on the user system interface cable head, and insert the user system interface cable head into the IC socket on the user system as shown in figure 2.2.
- Fasten the user system interface cable to the IC socket on the user system with the four screws provided. Each screw should be tightened a little at a time, alternating between screws on opposite corners. Use special care to prevent the soldered IC socket from being damaged by over-tightening the screws or twisting the components.

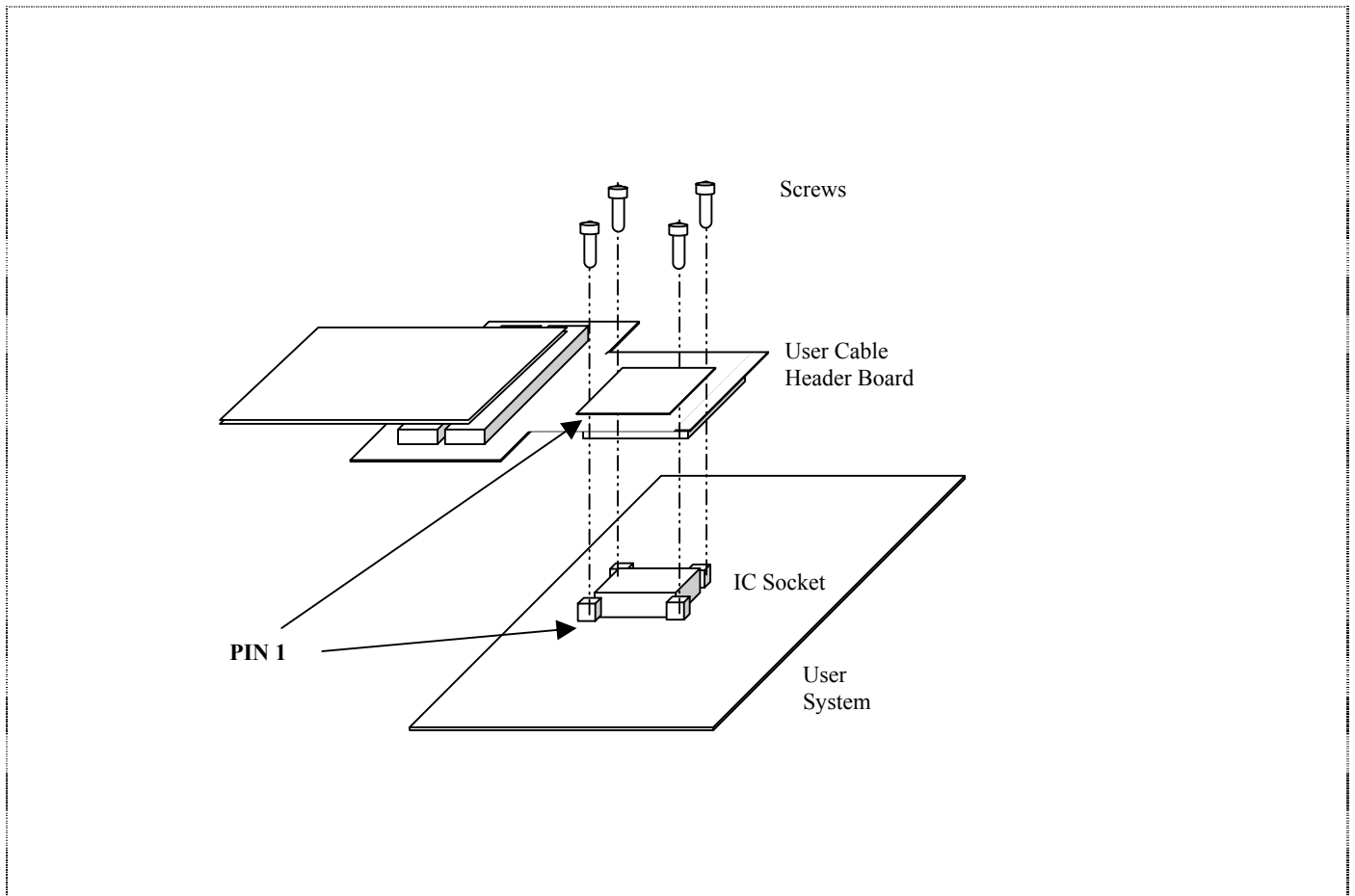
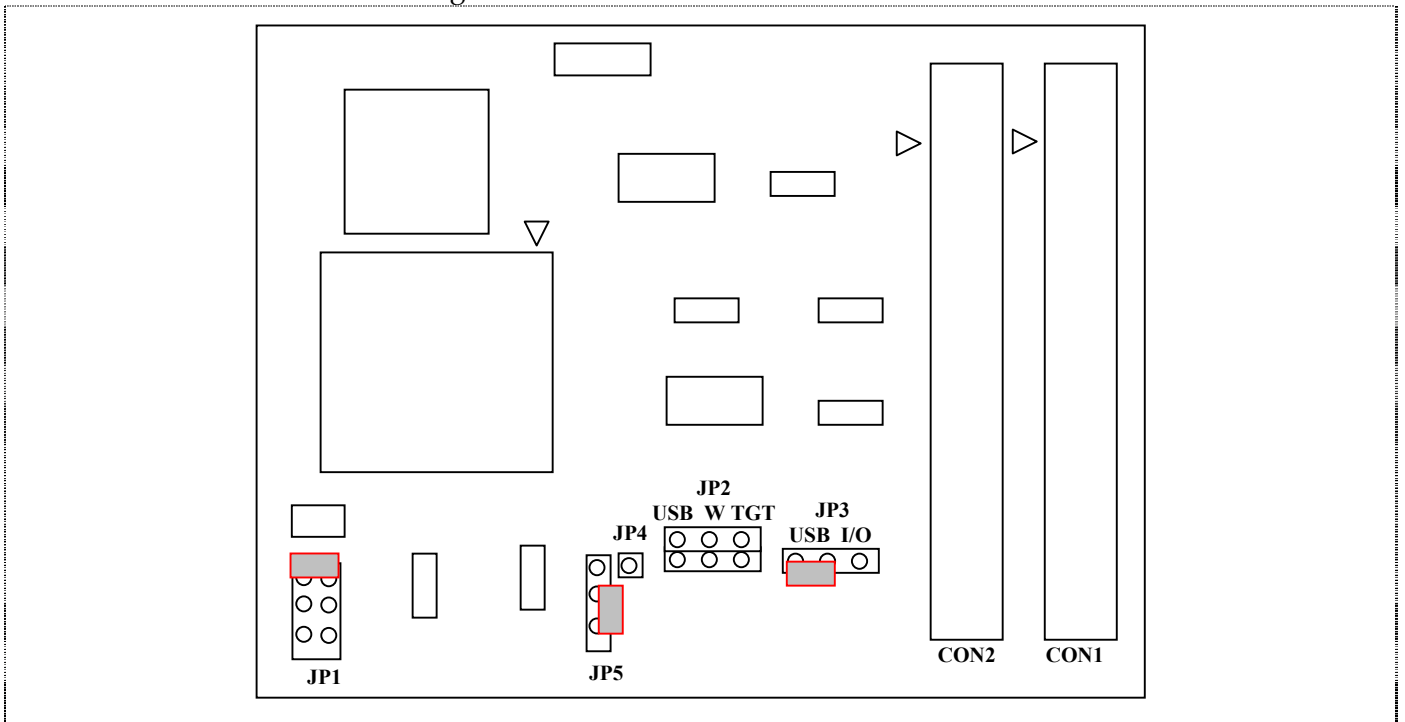

**Figure 2.2 Connecting User System Interface Cable to User System**

## 2.2.2 Jumpers Setting of the User Cable

The jumpers provide selection of:

1. main clock input
2. USB port
3. 48MHz clock input
4. emulation without target



**Figure 2.3 Jumper Setting**

| Jumper | Description           | Selection      | Remark   |
|--------|-----------------------|----------------|--|
| JP1    | 48MHz selection       | * Internal     | On-board 48MHz clock for USB emulation               |
|        |                       | Target         | 48MHz Clock input via target board                   |
|        |                       | Target Crystal | 48MHz Clock input via target board crystal           |
| JP2    | Emulation with target | *USB W TGT     | Emulation of H8S/2215 with target board connected    |
|        |                       | Without target | Emulation of H8S/2215 without target board connected |
| JP3    | PORT Select           | *USB           |  |
|        |                       | I/O (Port 1)   |  |
| JP4    | Clock Input (Probe)   |                | Main Clock Input based on JP5 selection              |
| JP5    | Main clock selection  | Probe          | Main Clock input at JP4                              |
|        |                       | *Target        | Main Clock input via target board crystal            |

\* Default Setting

**WARNING:** Users are reminded to remove all the 3 jumpers for JP2 when the user cable is connected to the target system.

### Section 3. Dimensions of User Cable System

The dimensions for the recommended mount pad (footprint) for the user system shown in figure 3.1 for the IC socket used on a TFP-120-pin package manufactured by Yamaichi Electronics Co., Ltd. Note that the dimensions in figure 3.1 are slightly different from the dimensions of the actual chip mounting pad.

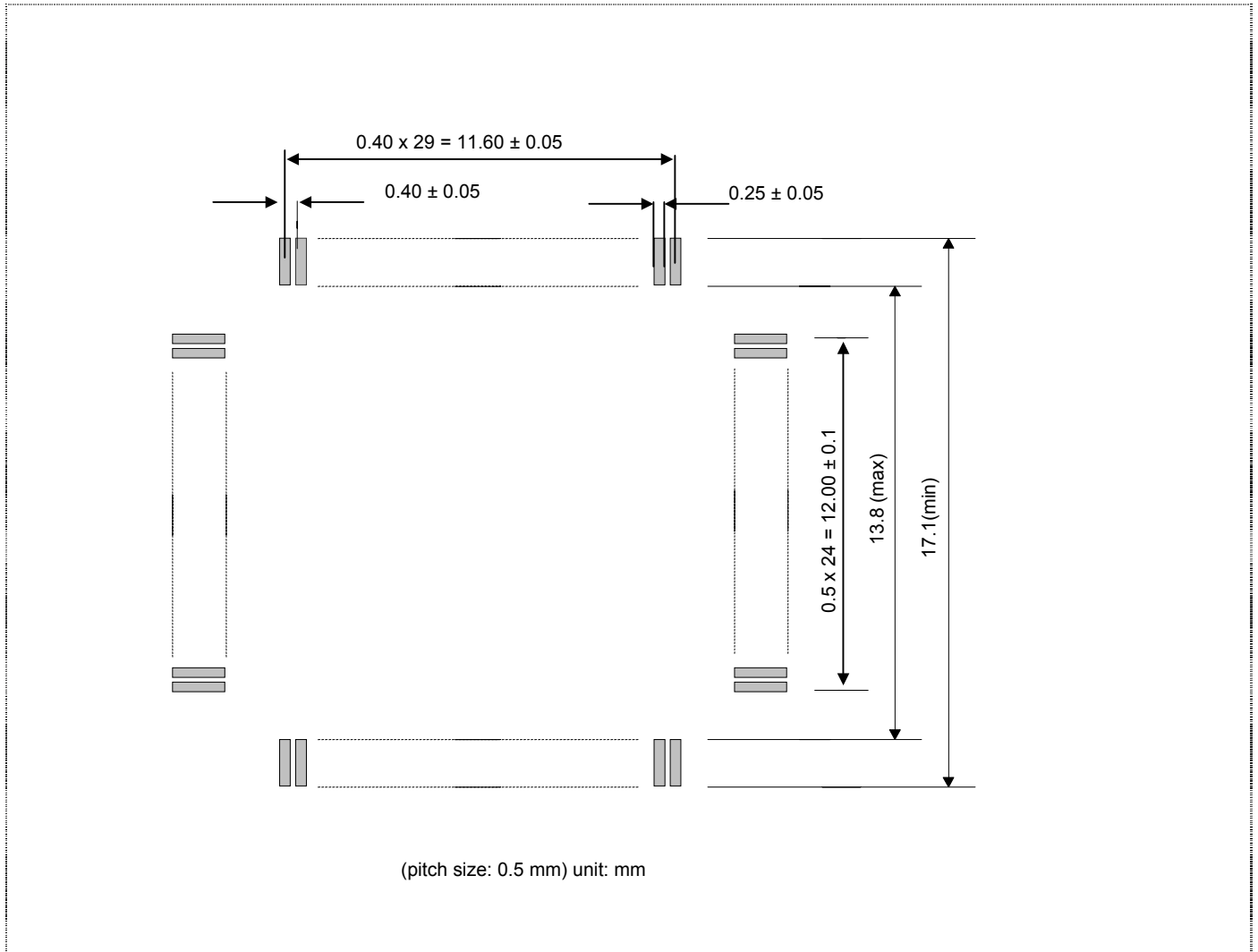

**Figure 3.1 PCB Footprint of User System Interface Cable Head**

The dimensions for the user system interface cable head is shown in figure 3.2.

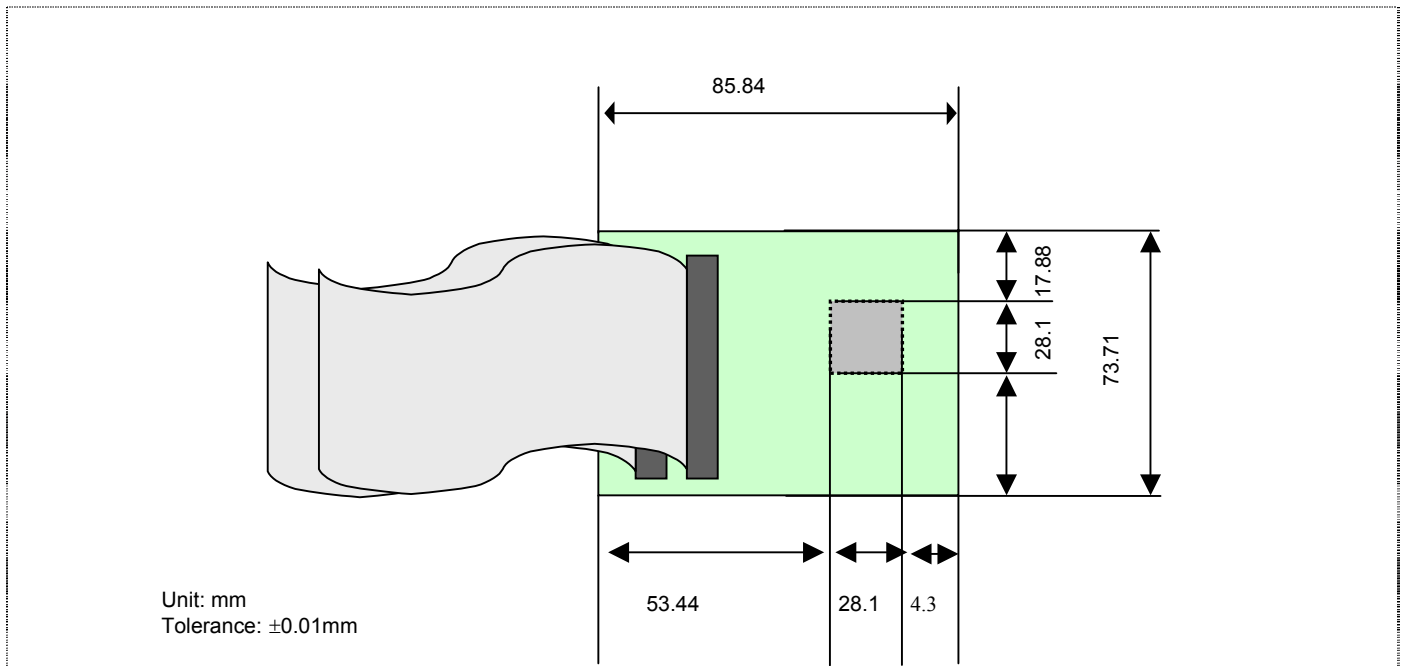

**Figure 3.2** User System Interface Cable (TOP View)

The dimensions after connecting to User System Interface Cable to the user system.

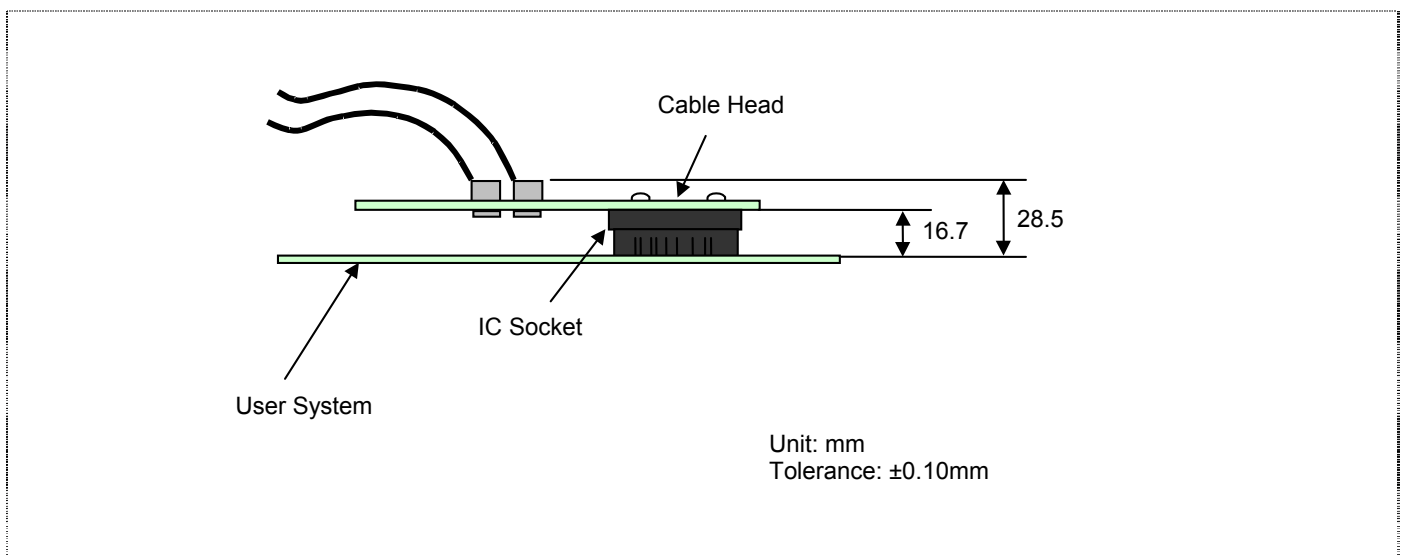

**Figure 3.3** User System Interface Cable (Side View)

## Section 4. Installing MCU to the User System

- Check the location of pin 1 before inserting the MCU into the IC socket on the user system as shown in figure 4.1.
- After inserting the MCU, fasten the socket cover with the four screws provided.
- Take special care, such as manually securing the IC socket soldered area, to prevent the soldered IC socket from being damaged by over-tightening the screws or twisting the component.

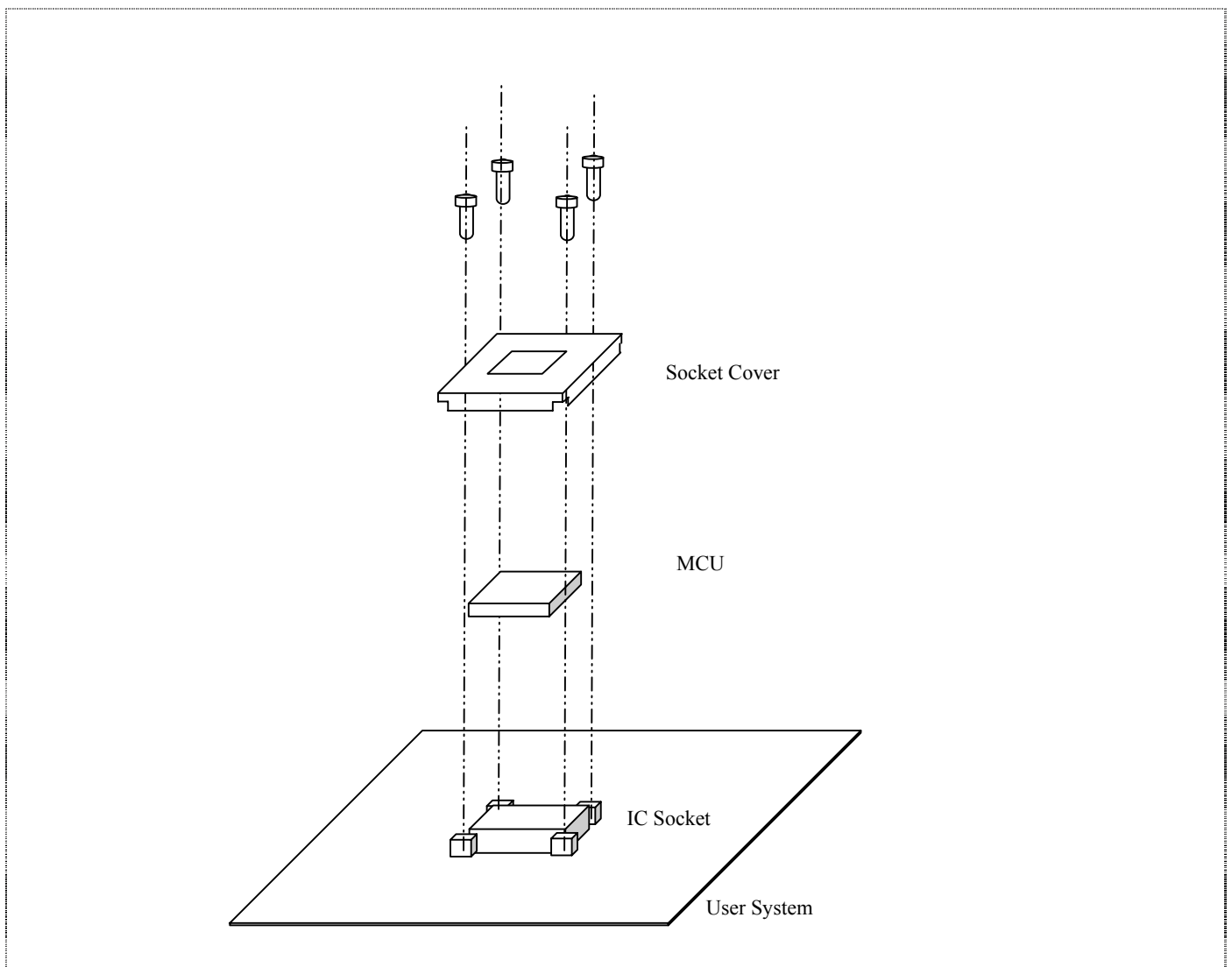

**Figure 4.1** Installing MCU to User System

## Section 5. Warnings

- Make sure that pin 1 on the IC socket is correctly aligned with pin 1 on the cable head before inserting the cable head into the IC socket on the user system.
- Do not apply excessive force to the user system interface cable while it is connected to the user system.
- The dimensions of the recommended footprint for the IC socket are different from those of the actual chip.
- This user system interface cable is specifically designed for the Compact Emulator. Do not use this cable with any other emulator.

While the emulator is connected to the user system with the user system interface cable, force must not be applied to the cable head

## **Renesas Technology (Asia Sales Offices)**

URL: <http://www.renesas.com>

## H8S Series User System Interface Cable

