

User's Manual

EEPROM Emulation Library

EEL - T05

**V850 Single Voltage Flash devices with Data Flash
and based on UX6LF Flash technology**

All information contained in these materials, including products and product specifications, represents information on the product at the time of publication and is subject to change by Renesas Electronics Corp. without notice. Please review the latest information published by Renesas Electronics Corp. through various means, including the Renesas Technology Corp. website (<http://www.renesas.com>).

Document No. U20280EE1V2UM00

Date Published: 05.02.2014

© Renesas Electronics Europe GmbH

Notice

1. All information included in this document is current as of the date this document is issued. Such information, however, is subject to change without any prior notice. Before purchasing or using any Renesas Electronics products listed herein, please confirm the latest product information with a Renesas Electronics sales office. Also, please pay regular and careful attention to additional and different information to be disclosed by Renesas Electronics such as that disclosed through our website.
2. Renesas Electronics does not assume any liability for infringement of patents, copyrights, or other intellectual property rights of third parties by or arising from the use of Renesas Electronics products or technical information described in this document. No license, express, implied or otherwise, is granted hereby under any patents, copyrights or other intellectual property rights of Renesas Electronics or others.
3. You should not alter, modify, copy, or otherwise misappropriate any Renesas Electronics product, whether in whole or in part.
4. Descriptions of circuits, software and other related information in this document are provided only to illustrate the operation of semiconductor products and application examples. You are fully responsible for the incorporation of these circuits, software, and information in the design of your equipment. Renesas Electronics assumes no responsibility for any losses incurred by you or third parties arising from the use of these circuits, software, or information.
5. When exporting the products or technology described in this document, you should comply with the applicable export control laws and regulations and follow the procedures required by such laws and regulations. You should not use Renesas Electronics products or the technology described in this document for any purpose relating to military applications or use by the military, including but not limited to the development of weapons of mass destruction. Renesas Electronics products and technology may not be used for or incorporated into any products or systems whose manufacture, use, or sale is prohibited under any applicable domestic or foreign laws or regulations.
6. Renesas Electronics has used reasonable care in preparing the information included in this document, but Renesas Electronics does not warrant that such information is error free. Renesas Electronics assumes no liability whatsoever for any damages incurred by you resulting from errors in or omissions from the information included herein.
7. Renesas Electronics products are classified according to the following three quality grades: "Standard", "High Quality", and "Specific". The recommended applications for each Renesas Electronics product depends on the product's quality grade, as indicated below. You must check the quality grade of each Renesas Electronics product before using it in a particular application. You may not use any Renesas Electronics product for any application categorized as "Specific" without the prior written consent of Renesas Electronics. Further, you may not use any Renesas Electronics product for any application for which it is not intended without the prior written consent of Renesas Electronics. Renesas Electronics shall not be in any way liable for any damages or losses incurred by you or third parties arising from the use of any Renesas Electronics product for an application categorized as "Specific" or for which the product is not intended where you have failed to obtain the prior written consent of Renesas Electronics.

8. The quality grade of each Renesas Electronics product is “Standard” unless otherwise expressly specified in a Renesas Electronics data sheets or data books, etc.

“Standard”: Computers; office equipment; communications equipment; test and measurement equipment; audio and visual equipment; home electronic appliances; machine tools; personal electronic equipment; and industrial robots.

“High Quality”: Transportation equipment (automobiles, trains, ships, etc.); traffic control systems; anti-disaster systems; anti- crime systems; safety equipment; and medical equipment not specifically designed for life support.

“Specific”:
support to Aircraft; aerospace equipment; submersible repeaters; nuclear reactor control systems; medical equipment or systems for life support (e.g. artificial life devices or systems), surgical implantations, or healthcare intervention (e.g. excision, etc.), and any other applications or purposes that pose a direct threat to human life.

9. You should use the Renesas Electronics products described in this document within the range specified by Renesas Electronics, especially with respect to the maximum rating, operating supply voltage range, movement power voltage range, heat radiation characteristics, installation and other product characteristics. Renesas Electronics shall have no liability for malfunctions or damages arising out of the use of Renesas Electronics products beyond such specified ranges.
10. Although Renesas Electronics endeavors to improve the quality and reliability of its products, semiconductor products have specific characteristics such as the occurrence of failure at a certain rate and malfunctions under certain use conditions. Further, Renesas Electronics products are not subject to radiation resistance design. Please be sure to implement safety measures to guard them against the possibility of physical injury, and injury or damage caused by fire in the event of the failure of a Renesas Electronics product, such as safety design for hardware and software including but not limited to redundancy, fire control and malfunction prevention, appropriate treatment for aging degradation or any other appropriate measures. Because the evaluation of microcomputer software alone is very difficult, please evaluate the safety of the final products or system manufactured by you.
11. Please contact a Renesas Electronics sales office for details as to environmental matters such as the environmental compatibility of each Renesas Electronics product. Please use Renesas Electronics products in compliance with all applicable laws and regulations that regulate the inclusion or use of controlled substances, including without limitation, the EU RoHS Directive. Renesas Electronics assumes no liability for damages or losses occurring as a result of your noncompliance with applicable laws and regulations.
12. This document may not be reproduced or duplicated, in any form, in whole or in part, without prior written consent of Renesas Electronics.
13. Please contact a Renesas Electronics sales office if you have any questions regarding the information contained in this document or Renesas Electronics products, or if you have any other inquiries.
 - (Note 1) “Renesas Electronics” as used in this document means Renesas Electronics Corporation and also includes its majority- owned subsidiaries.
 - (Note 2) “Renesas Electronics product(s)” means any product developed or manufactured by or for Renesas Electronics.

Regional Information

Some information contained in this document may vary from country to country. Before using any Renesas Electronics product in your application, please contact the Renesas Electronics office in your country to obtain a list of authorized representatives and distributors. They will verify:

- • Device availability
- • Ordering information
- • Product release schedule
- • Availability of related technical literature
- • Development environment specifications (for example, specifications for third-party tools and components, host computers, power plugs, AC supply voltages, and so forth)
- • Network requirements

In addition, trademarks, registered trademarks, export restrictions, and other legal issues may also vary from country to country.

Visit

<http://www.renesas.com>

to get in contact with your regional representatives and distributors.

Table of Contents

Chapter 1	Introduction	7
1.1	Naming Conventions.....	8
Chapter 2	EEL Architecture	9
2.1	UX6LF Data Flash.....	9
2.1.1	33-bit Implementation	9
2.1.2	Dual operation.....	9
2.2	Layered Architecture	10
2.3	Data Flash Pools.....	11
2.4	Safety Considerations	12
2.5	Feature Overview.....	12
2.6	EEL Flash block management y	13
2.6.1	Logical block structure	13
2.6.2	Block lifecycle	14
2.6.3	Internal block structure	15
2.7	EEL Data Sets Management	20
2.7.1	Basic Concept.....	20
2.7.2	DP and RP	20
2.7.3	Storage structure details.....	22
Chapter 3	EEL Design	25
3.1	Process management	25
3.1.1	EEL operations priority	25
3.1.2	Process hierarchy	26
3.1.3	State machine	28
3.1.4	Asynchronous architecture	29
3.1.5	Process errors and warnings	30
3.2	Data Set search and read	32
3.2.1	ID-L and IDX tables	32
3.3	Start-up processing	34
3.4	Function & command execution times & latencies	36
3.4.1	Library startup phase	36
3.4.2	Normal operation phase	38
Chapter 4	Implementation	40
4.1	File structure	40
4.1.1	Overview	40
4.1.2	Delivery package directory structure and files.....	41
4.2	EEL Linker sections	43
4.3	MISRA Compliance.....	43
Chapter 5	User Interface (API)	44
5.1	Pre-compile configuration	44

5.2	Run-time configuration	45
5.2.1	FDL run-time configuration elements	45
5.2.2	EEL run time configuration elements.....	47
5.3	Data Types	50
5.3.1	Error Codes.....	50
5.3.2	User operation request structure	51
5.3.3	Driver status.....	53
5.4	EEL Functions.....	56
5.4.1	Initialization / Shut down	56
5.4.2	Suspend / Resume	62
5.4.3	Operational functions.....	65
5.4.4	Administrative functions	72
Chapter 6	EEL Implementation into the user application	77
6.1	First steps.....	77
6.1.1	Application sample.....	77
6.2	Standard EEL life cycle	78
6.2.1	Device start-up.....	79
6.2.2	Device normal operation.....	81
6.2.3	Device power down	82
6.3	Special considerations	83
6.3.1	Endurance calculations.....	83
6.3.2	Data Flash initialization	83
6.3.3	Library handling by the user application	85
6.3.4	Concurrent Data Flash accesses.....	86
6.3.5	Entering power safe mode.....	87
6.3.6	Library behaviour after operation interruption.....	88
6.3.7	Application update issues	88
Chapter 7	Revision History	92

Chapter 1 Introduction

This user's manual describes the internal structure, the functionality and software interfaces (API) of the Renesas V850 EEPROM Emulation Library (EEL) type T05, designed for V850 based Flash devices with Data Flash based on the UX6LF Flash technology

The device features differ depending on the used Flash implementation and basic technology node. Therefore, pre-compile and run-time configuration options allow adaptation of the library to the device features and to the application needs.

The libraries are delivered in source code. However it has to be considered carefully to do any changes, as not intended behavior and programming faults might be the result.

The development environments of the companies Green Hills (GHS), IAR and Renesas are supported. Due to the different compiler and assembler features, especially the assembler files differ between the environments. So, the library and application programs are distributed using an installer tool that allows selecting the appropriate environment.

For support of other development environments, additional development effort may be necessary. Especially, but maybe not only, the calling conventions to the assembler code and compiler dependent section defines differ significantly.

The libraries are delivered together with device dependent application programs, showing the implementation of the libraries and the usage of the library functions.

The different options of setup and usage of the libraries are explained in detail in this document.

Caution:

Please read all chapters of the application note carefully.

Much attention has been put to proper conditions and limitations description. Anyhow, it can never be ensured completely that all not allowed concepts of library implementation into the user application are explicitly forbidden. So, please follow exactly the given sequences and recommendations in this document in order to make full use of the libraries functionality and features and in order to avoid any possible problems caused by libraries misuse.

The EEPROM emulation libraries together with the application samples, this application note and other device dependent information can be downloaded from the following URL:

<http://www.eu.renesas.com/update>

1.1 Naming Conventions

Certain terms, required for the description of the Flash and EEPROM emulation are long and too complicated for good readability of the document. Therefore, special names and abbreviations will be used in the course of this document to improve the readability.

These abbreviations shall be explained here:

Abbreviations / Acronyms	Description
Block	Smallest erasable unit of a flash macro
Code Flash	Embedded Flash where the application code is stored. For devices without Data Flash EEPROM emulation might be implemented on that flash in the so called data area.
Data Flash	Embedded Flash where mainly the data of the EEPROM emulation are stored. Beside that also code operation might be possible.
Dual Operation	Dual operation is the capability to fetch code during reprogramming of the flash memory. Current limitation is that dual operation is only available between different flash macros. Within the same flash macro it is not possible!
EEL	EEPROM Emulation Library
EEPROM emulation	In distinction to a real EEPROM the EEPROM emulation uses some portion of the flash memory to emulate the EEPROM behavior. To gain a similar behavior some side parameters have to be taken in account.
FAL	Flash Access Library (Flash access layer)
FCL	Code Flash Library (Code Flash access layer)
FDL	Data Flash Library (Data Flash access layer)
Flash	“Flash EPROM” - Electrically erasable and programmable nonvolatile memory. The difference to ROM is, that this type of memory can be re-programmed several times.
Flash Block	A flash block is the smallest erasable unit of the flash memory.
Flash Macro	A flash comprises of the cell array, the sense amplifier and the charge pump (CP). For address decoding and access some additional logic is needed.
NVM	Non volatile memory. All memories that hold the value, even when the power is cut off. E.g. Flash memory, EEPROM, MRAM...
RAM	“Random access memory” - volatile memory with random access
ROM	“Read only memory” - nonvolatile memory. The content of that memory can not be changed.
Serial programming	The onboard programming mode is used to program the device with an external programmer tool.
Single Voltage	For the reprogramming of single voltage flashes the voltage needed for erasing and programming are generated onboard of the microcontroller. No external voltage needed like for dual- voltage flash types.

Chapter 2 EEL Architecture

2.1 UX6LF Data Flash

2.1.1 33-bit Implementation

The Data Flash of devices in UX6LF Flash technology is based on a standard 32-bit architecture. This means, that the data can be written and read in 32-bit units (read or write in 8-bit or 16-bit units is not possible!).

Additionally to every 32-bit data word a 33rd bit (Tag) is available for free usage.

While the 32 data bits can be read in a linear address room, the Tag can be read in another linear address room on a different address (every 32-bit address one tag can be read). The data address room starts from 0x02000000 while the Tag address room starts from 0x02100000

Furthermore, the Tag can be written independently from the other data and it is protected against bit failures separately. The FDL provides separate functions to write the data and the tags.

The Tags are completely in the hand of the user application. In the EEL concept, the Tag is used to write additional management data in order to ensure data consistency in case of write interruptions.

2.1.2 Dual operation

Common for all Flash implementations is, that during Flash modification operations (Erase/Write) a certain amount of Flash memory is not accessible for any read operation (e.g. program execution or data read).

This does not only concern the modified Flash range, but a certain part of the complete Flash system. The amount of not accessible Flash depends on the device architecture.

A standard architectural approach is the separation of the Flash into Code Flash and Data Flash. By that, it is possible to read from the Code Flash (to execute program code or read data) while Data Flash is modified, and vice versa. This allows implementation of EEPROM emulation concepts with Data storage on Data Flash while all program code is executed from Code Flash.

If not mentioned otherwise in the device users manuals, UX6LF devices with Data Flash are designed according to this standard approach.

Note:

It is not possible to modify Code Flash and Data Flash in parallel!

2.2 Layered Architecture

This chapter describes the function of all blocks belonging to the EEPROM Emulation System.

Even though this specification describes the functional block EEL, a short description of all concerned functional blocks and their relationship can be beneficial for the general understanding.

Figure 1 Rough symbolic relationship between the functional blocks

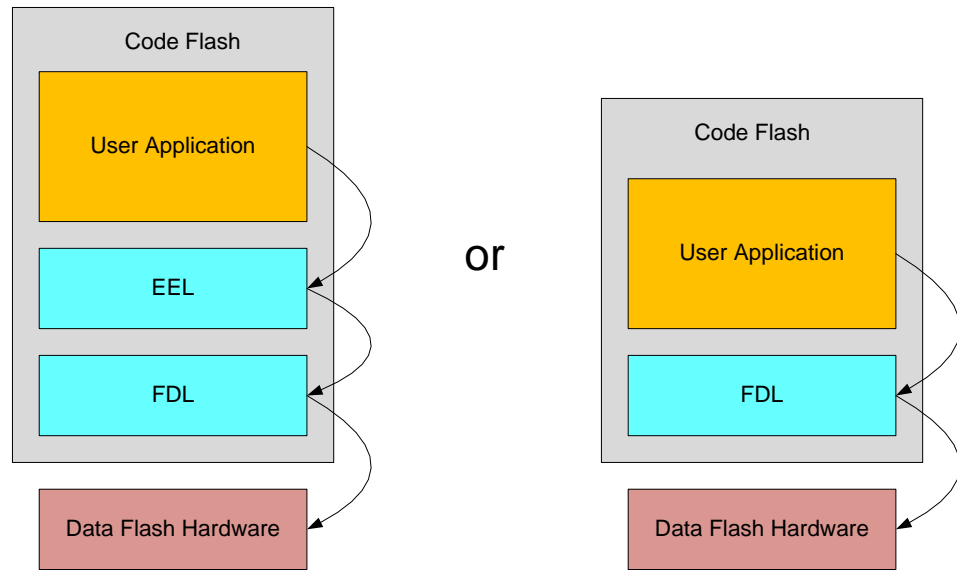

Application

The functional block “Application” should not use the functions offered by the FDL directly. FDL functions are reserved for EEL only. Exception is when the user implements a proprietary EEPROM emulation, it has to use functions provided by the FDL only.

EEPROM Emulation Library (EEL)

The functional block “EEPROM Emulation library” is the subject of this specification. It offers all functions and commands the “Application” can use in order to handle its EEPROM data.

Data Flash Access Library (FDL)

The “Data Flash Access Library” offers an interface to access any user-defined flash area, so called “FDL-pool” (described in next chapter). Beside the initialization function the FDL allows the execution of access-commands like write as well as a suspendable erase command.

Note:

General requirement is to be able to deliver pre-compiled EEL libraries, which can be linked to either Data Flash Access Libraries (FDL) or Code Flash Access Libraries (FCL). To support this, a unique API towards the EEL must be provided by these libraries. Following that, the standard API prefix FDL_... which would usually be provided by the FDL library, will be replaced by a standard Flash Access Layer prefix FAL_...

All functions, type definitions, enumerations etc. will be prefixed by FAL_ or fal_.

Independent from the API, the module names will be prefixed with FLD_ in order to distinguish the source/object modules for Code and Data Flash.

2.3 Data Flash Pools

The FDL pool defines the Flash blocks, which may be accessed by any FDL operation (e.g. write, erase). The limits of the FDL pool are taken into consideration by any of the FDL flash access commands. The user can define the size of the FDL-pool freely at project compilation time, while usually the complete Data Flash is selected.

The FDL pool provides the space for the EEL pool which is allocated by the EEL inside the FDL-pool. The EEL pool provides the Flash space for the EEL to store the emulation data and management information.

All FDL pool space not allocated by the EEL pool is freely usable by the user application, so is called the "User pool".

Pools details:

- **FDL-pool** is just a place holder for the EEL-pool. It does not allocate any flash memory. The FDL-pool descriptor defines the valid address space for FDL access to protect all flash outside the FDL-pool against destructive access (write/erase) by a simple address check in the library.

To simplify function parameter passing between FDL and the higher layer the physical Flash addresses (e.g. 0x02000000....0x0200FFFF) are transformed into a linear address room 0x0000....0xFFFF used by the FDL.

- **EEL-pool** allocates and formats (virgin initialization) all flash blocks belonging to the EEL-pool. The header data are generated in proper way to be directly usable by the application.
- **User Pool** is completely in the hands of the user application. It can be used to build up an own user EEPROM emulation or to simply store constants.

Figure 2 Data Flash / FDL Pool

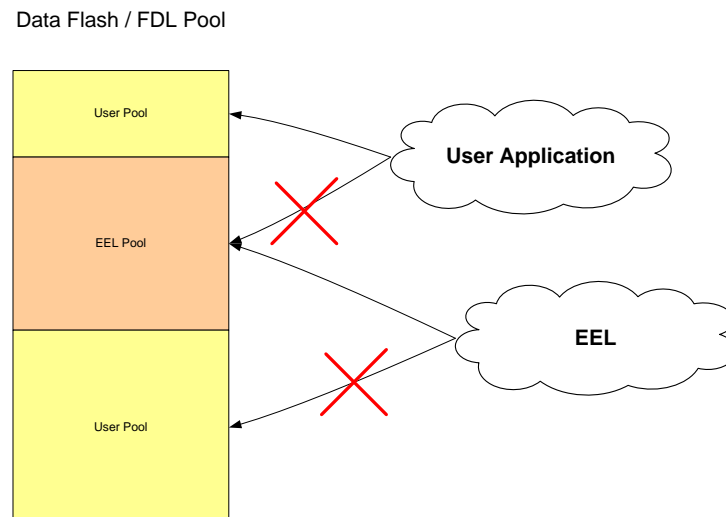

2.4 Safety Considerations

EEPROM emulation in the automotive market is not only operated under normal conditions, where stable function execution can be guaranteed. In fact, several failure scenarios should be considered.

Most important issue to be considered is the interruption of a function e.g. by power fail or Reset.

Differing from a normal digital system, where the operation is re-started from a defined entry point (e.g. Reset vector), the EEPROM emulation modifies Flash cells, which is an analogue process with permanent impact on the cells. Such an interruption may lead to instable electrical cell conditions of affected cells. This might be visible by undefined read values (read value \neq write value), but also to defined read values (blank or read value = write value). In each case the read margin of these cells is not given. The value may change by time into any direction.

This is considered in the emulation design. Safety relevant considerations and concepts are mentioned in dedicated sub-chapters in this document.

2.5 Feature Overview

The new EEL concept improves quite some features known from today's V850 MF2/UX4 EEELib. Beside the same kind of user data management, based on data sets (DS) identified with certain IDs, many new or extended features are implemented:

The old V850 MF2/UX4 EEELib searches DS's in the Flash memory on every Read access as well as during the Refresh process. Even though being executed in background, the read latency is very big.

In order to overcome this situation, the new EEL concept uses a RAM table to store the latest DS instance. So, the read access performance will be significantly increased.

Read and Write will be the only user visible EEL operations. All other operations are executed invisible in background and don't cause a significant latency to the Read and Write operations. Therefore:

- An Erase can be suspended and resumed
- A Refresh can be interrupted after each word write for data Read
- A Refresh can be interrupted after each DS copy for data Write

DS write abort is handled very simple by stopping the write process. Writing closing management data as for the V850 MF2 EEELib is no longer required due to the new data management method.

The startup performance is significantly improved regarding the V850 MF2/UX4 implementation as the DS management does no longer need to overwrite data in order to ensure the data consistency.

Ring buffer style Flash block management reaches better Flash endurance usage. While the old concept required a constant "copy zone" in order to execute Refresh section operations, the new concept requires copy space only if the data at the ring buffer tail (eldest part of the ring buffer) is not already written new in the ring buffer.

2.6 EEL Flash block management y

To simplify function parameter passing between the FAL and the EEL the physical space used by the FCB is transformed into a linear address room starting from 0x00000000 (FDL address range). This should save space in the reference-area of the EEPROM driver when writing new instance references. Also the protection mechanisms can be implemented in a more effective way. For block addressing the original physical block numbers are used in the same way starting from 0.

2.6.1 Logical block structure

The Flash blocks are used as a kind of ring buffer. The below picture considers a write pointer staying fix, while the ring buffer rotates clockwise. Every Flash block reaching the write pointer gets activated. This block is called the active zone head.

Every block reaching the end of the active zone is getting consumed. The end of the active zone is called later on the active zone tail.

Before getting activated again the block is prepared.

Each block will pass a complete life cycle on every ring buffer loop.

Figure 3 Basic ring buffer structure

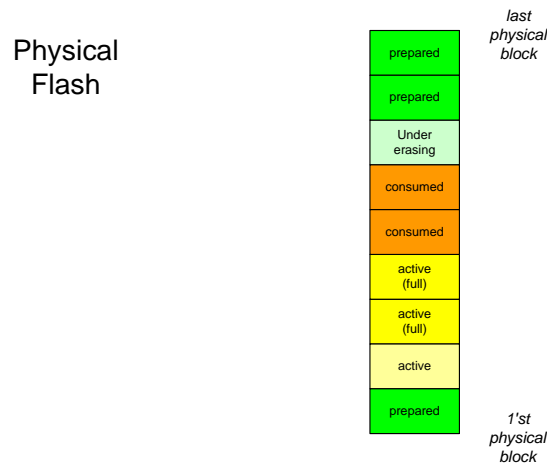
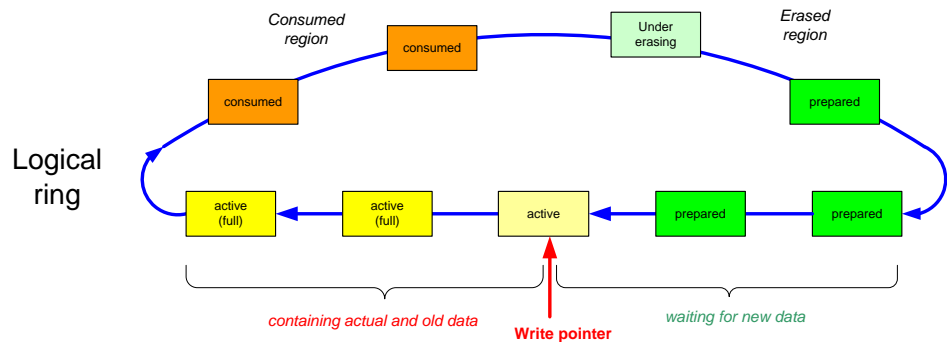

2.6.2 Block lifecycle

The life cycle of a block passes different steps which are largely marked inside the block header in specific words.

The active state and the occupied state are not explicitly distinguished by block header information. They all have the active marker set. Anyhow, inside the library only the latest block containing required data (not full, the write pointer points into this block) contains the active status. All other blocks containing required data are full and so, are treated internally occupied.

The consumed blocks, blocks under erasing or other blocks with undefined state due to power fail are considered as invalid and are all treated in the same way by the library. They enter the preparation phase in the next life cycle and are then prepared.

In case of an erase fail the affected Flash block is considered to be defect and is so marked excluded. This block will not enter the lifecycle again.

Figure 4 Block Lifecycle

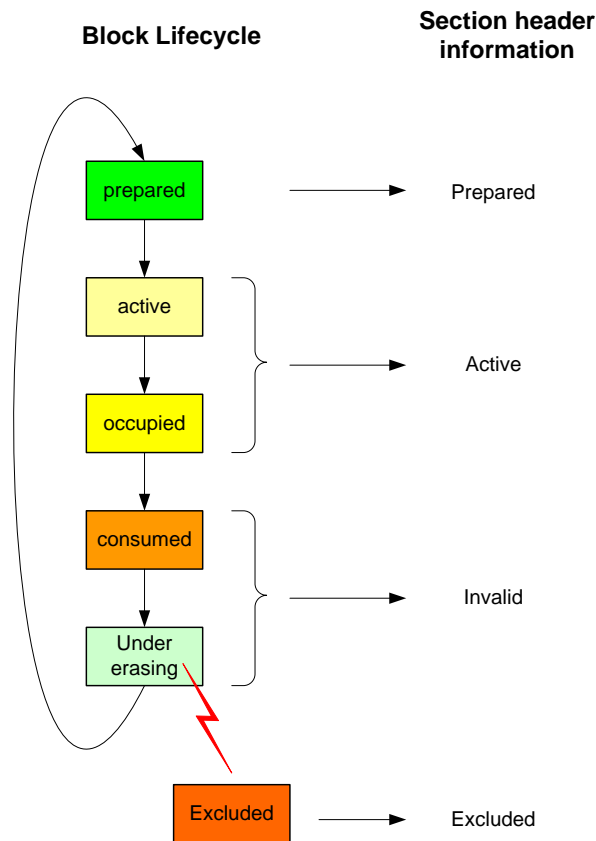

2.6.3 Internal block structure

Every Flash block of the logical ring buffer contains 3 areas. While the block header size is fix, the data zone and the Reference (REF) zone grow towards each other. A block is full and the next block must be activated, when only 1~3 blank words (depending on different conditions) as delimiter remain between the two zones.

Block header:
The header contains the block status information.

Data Zone:
Contains the pure user data to be stored without any management information.

Reference (REF) zone:
This is a table with entries containing the references (pointers) to the data.

Figure 5 Basic Block structure

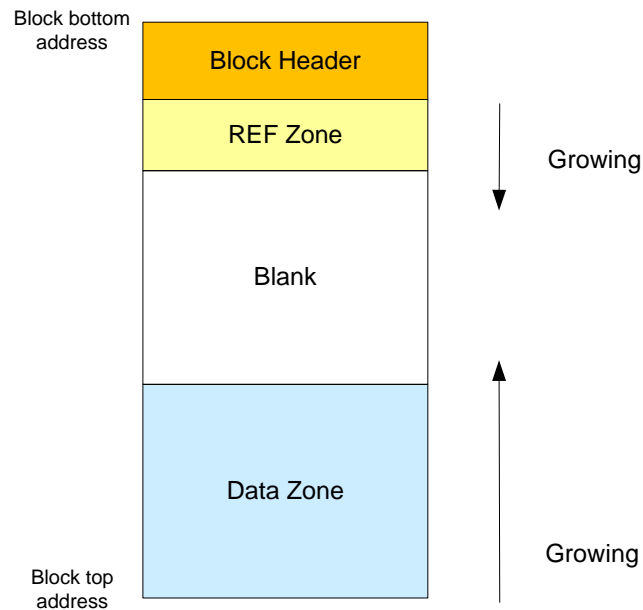

While the block management (including the block header) is described in the next sub-chapters, the data management within the blocks (including REF Zone and Data Zone) is described in the main chapter EEL Data Sets Management.

2.6.3.1 Block Header

The block header contains the block status words.

Figure 6 Block header words

widx	byte 3	byte 2	byte 1	byte 0	
0	I - 0				invalid/exclude flag 0
1	I - 1				invalid/exclude flag 1
2	P				prepare flag
3	A -0				active flag 0
4	A -1				active flag 1
5	CS	EC			erase counter (8bit CS protected)
6	CS	RWP			reference write pointer (8 bit CS protected)
7	CS	RDP			read data pointer (8 bit CS protected)

I – 0, I – 1:

These words together build a 64bit word containing the information, if a block is invalid or excluded.

By writing 0x5555555555555555, the block is marked excluded.

By writing 0x0000000000000000, the block is marked invalid.

If on startup the words are not blank and not matching one of the above patterns, the block is judged invalid. This is the block default state which may result from a power fail during block status change operations.

If on startup the words are blank, the other header words determine the block status.

P:

The prepare marker is set by the preparation process. With the pattern 0x55555555, the block is marked prepared.

A – 0:

The activation flag 0 is written 1st in the block activation process with the pattern 0x55555555.

It locks the block for the activation, so that in case of a power fail in this process, a later activation after restart will not lock this block again, but will use the next one.

A – 1:

The activation flag 1 is written last in the activation process with the pattern 0x55555555.

EC:

The erase counter is written as the 1st word in the preparation process.

Rule for counter calculation is:

if the block is the 1st physical block

$$EC = (\text{previous block EC}) + 1$$

otherwise

$$EC = (\text{previous block EC})$$

By that rule, on each ring buffer turn around the erase counter in each block is increased by 1.

The erase counter stability is ensured by the P word, written afterwards in the preparation process. If the P word is valid, the EC is electrically stable.

Additionally, the EC is checksum protected in order to be robust against accidental overwriting due to application failures.

Figure 7 Erase Counter example

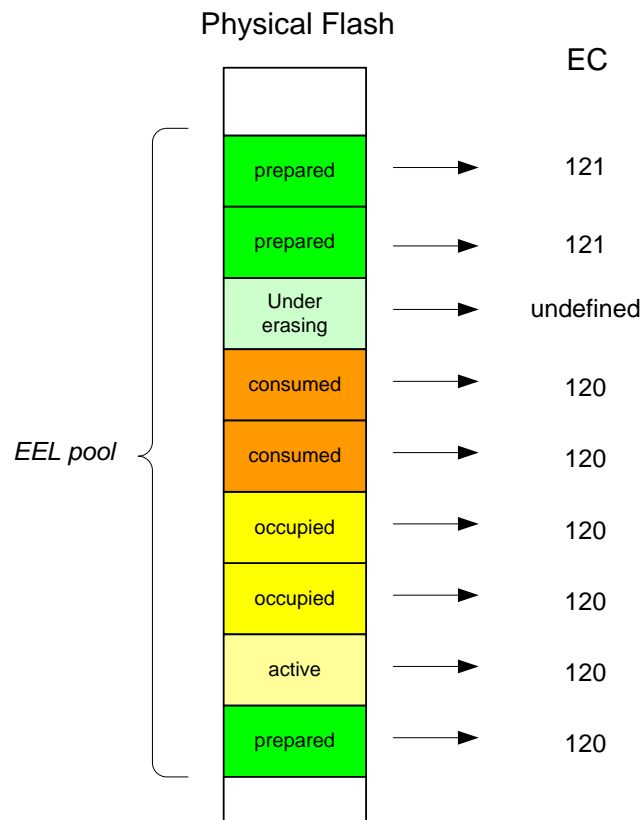

Note:

The erase counter does not necessarily match the real Flash block erase cycles, but only the erase cycles since the EEPROM emulation has been set up last time. The erase counter is affected by Data Flash complete erase or manual Flash modification (programmer or debugger).

RWP:

The reference write pointer is written in the activation process after A – 0 and before A – 1.

It points to the previous block separator between REF zone and Data zone. By that, the EEL knows for each occupied block the last REF zone entry.

The RWP stability is ensured by the A - 1 word, written afterwards in the activation process. If the A - 1 word is valid, the RWP is electrically stable.

Additionally, the RWP is checksum protected in order to be robust against accidental overwriting due to application failures.

Figure 8 Reference Write Pointer

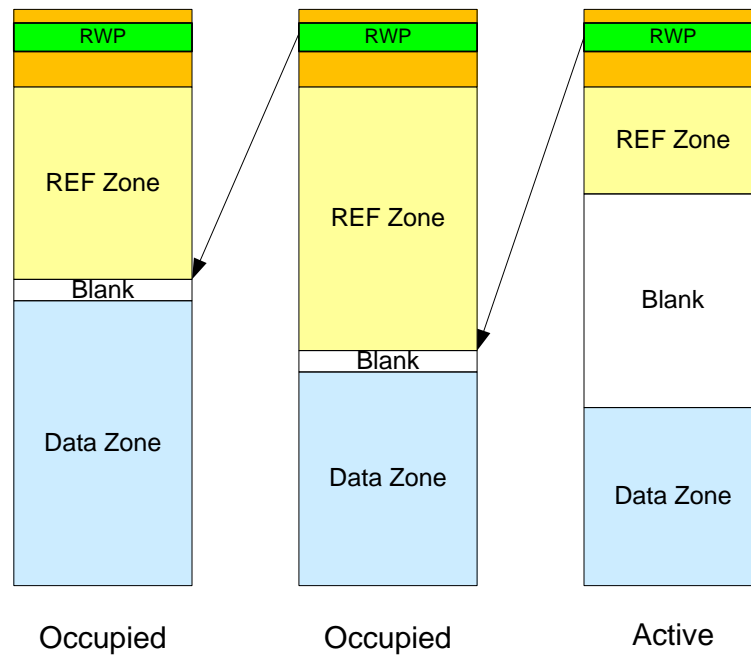
**RDP:**

The Read Data Pointer is used for treatment of the special situation that only one passive block is left ("Pool full situation").

2.6.3.2 Block header data transitions

During EEPROM emulation block header information changes according to the block status. The following table shows the data change process and the resulting block header data.

As the RDP word (see last sub-chapter) is not block status related, it is not mentioned here.

Figure 9 Block header data transitions

Block Operation	Status	Block Header words						
		I-0	I-1	P	A-0	A-1	EC	RWP
-	erased	FFFFFFFF	FFFFFFFF	FFFFFFFF	FFFFFFFF	FFFFFFFF	FFFFFFFF	FFFFFFFF
"Set Prepared"	ongoing	FFFFFFFF	FFFFFFFF	FFFFFFFF	FFFFFFFF	FFFFFFFF	????????	FFFFFFFF
	ongoing	FFFFFFFF	FFFFFFFF	FFFFFFFF	FFFFFFFF	FFFFFFFF	XXXXXXXX	FFFFFFFF
	ongoing	FFFFFFFF	FFFFFFFF	????????	FFFFFFFF	FFFFFFFF	XXXXXXXX	FFFFFFFF
	finished	FFFFFFFF	FFFFFFFF	55555555	FFFFFFFF	FFFFFFFF	XXXXXXXX	FFFFFFFF
"Set Active"	ongoing	FFFFFFFF	FFFFFFFF	55555555	????????	FFFFFFFF	XXXXXXXX	FFFFFFFF
	ongoing	FFFFFFFF	FFFFFFFF	55555555	55555555	FFFFFFFF	XXXXXXXX	FFFFFFFF
	ongoing	FFFFFFFF	FFFFFFFF	55555555	55555555	FFFFFFFF	XXXXXXXX	XXXXXXXX
	ongoing	FFFFFFFF	FFFFFFFF	55555555	55555555	????????	XXXXXXXX	XXXXXXXX
	finished	FFFFFFFF	FFFFFFFF	55555555	55555555	55555555	XXXXXXXX	XXXXXXXX
"Set Excluded"	ongoing	????????	FFFFFFFF	-----	-----	-----	-----	-----
	ongoing	55555555	FFFFFFFF	-----	-----	-----	-----	-----
	ongoing	55555555	????????	-----	-----	-----	-----	-----
	finished	55555555	55555555	-----	-----	-----	-----	-----
"Set Invalid"	ongoing	????????	-----	-----	-----	-----	-----	-----
	ongoing	0	-----	-----	-----	-----	-----	-----
	finished	0	0	-----	-----	-----	-----	-----

FFFFFFFF	Blank Flash word
55555555	Pattern 0x55555555
0	Pattern 0x00000000
XXXXXXXX	Erase counter / reference write pointer data
????????	Data write in progress --> Data is undefined
-----	Data is irrelevant and/or undefined

The block header information is read on library startup and maintained library internal during run-time.

The block header data is modified during run-time by the block management processes (see next chapter) and during startup in case of detected inconsistencies.

2.7 EEL Data Sets Management

2.7.1 Basic Concept

Differing from real EEPROM, where user data is referenced by the address information, the user data in the Renesas EEPROM emulation is referenced by an identifier (ID). An ID is unique for a certain set of data with a dedicated length. Differing from EEPROM, the data is stored “somewhere” in the Flash memory but not on a fix address.

Figure 10 Overview - Entry in the REF zone pointing to the user data in the Data zone

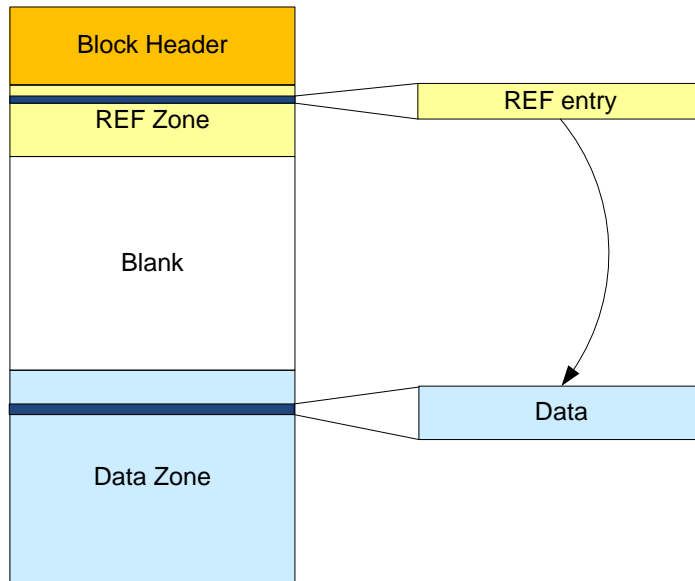

The user data is stored in the Data Zone sequentially according to the write sequence. Based on the Flash write size of 1 word, the data is stored word aligned.

In order to find the data later on in the Flash, the REF zone contains the DS management information, which is basically the ID and the pointer to the data. Further information is required in the REF-zone to ensure data consistency in case of write interruption and in order to improve the robustness against user application fails resulting in Flash words overwrite.

2.7.2 DP and RP

The emulation library requires two pointers in the active section in order to write new DS instances to the Flash

- Data Pointer (DP)
The DP is the pointer to the next write location for the user data.
- Reference Pointer (RP)
The RP is the pointer to the next location for a REF zone entry.

Figure 11 DP and RP

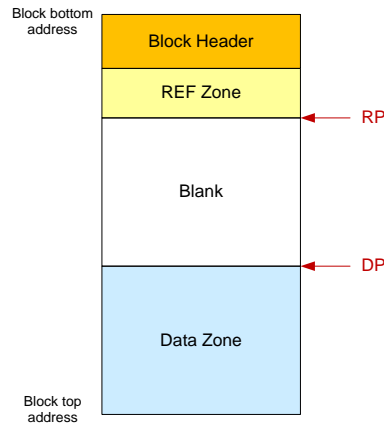

RP and DP grow together. When the pointers match, only one blank word is between the zones. The Flash block is considered as full and the next block must be activated.

2.7.2.1 Block overlapping DS's

In order not to waste Flash space when a DS does not completely fit into a Flash block, the DS is partly written into the block and finished in the next block (or blocks in case of DS bigger than one block).

Figure 12 Block Overlapping DS (normal size DS)

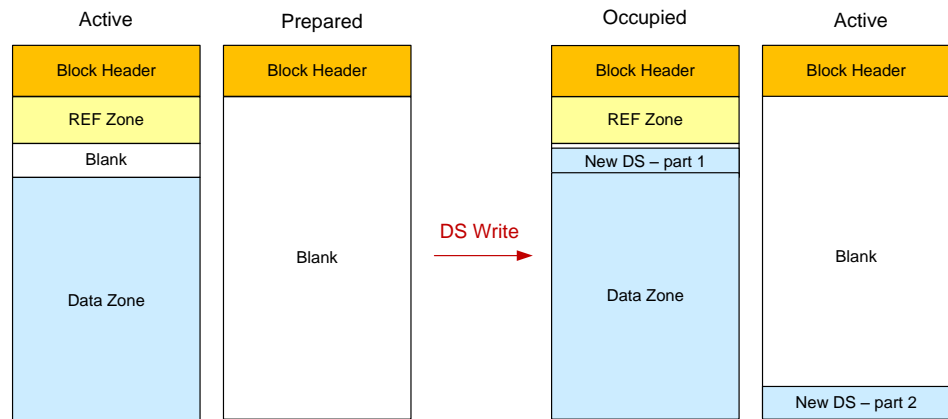

Note:

Based on the EEL implementation it is not allowed that the DS size exceeds more than one Data Flash block. So, overlapping multiple blocks is not possible.

2.7.3 Storage structure details

The following 2 sub-chapters describe the Data Sets (DS) storage structure details. The structures differ depending on:

- The DS contains valid user data
- The DS contains the information that the user data of a certain ID is invalid and so, may not be read until valid data is written again.
A Read command on a ID which last DS instance is invalidated will return the error “invalidated” instead of returning data.

2.7.3.1 DS containing normal data

The DS's are stored according to the following picture:

Figure 13 DS Data and management information in Flash

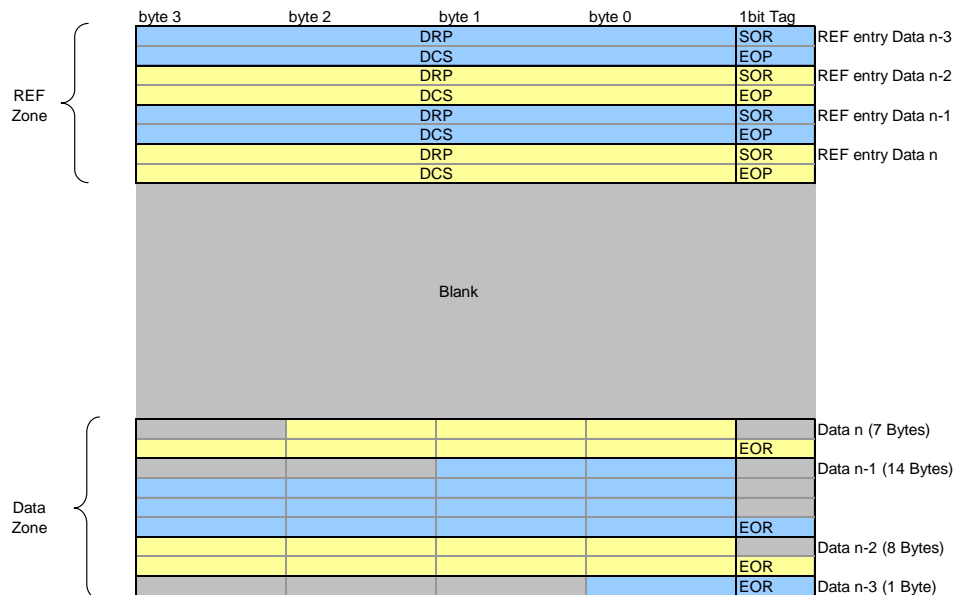

- **SOR** Start of reference entry (1-bit Tag)
It is written 1st in order to block one REF zone list entry.
- **DRP** Data Reference Pointer
Is written after SOR and contains:
 - 16-bit lower half word: ID
 - 16-bit upper half word: widx, a pointer to the data

Note:

DRP can address 64k addresses. This is sufficient to cover 256kB Flash with word addressing. If bigger Flash than 256kB is implemented, the address granularity must be increased to: 2 word for 512kB and 4words for 1MB Flash. This will be a configuration parameter for the library.

- **EOP** End of DRP (1-bit Tag)
Is written immediately after the DRP. When written, the read margin of the DRP word is ensured by the write sequence.
- **DCS** Data Check Sum
This is a simple 32bit checksum, calculated over the user data and DRP. It ensures higher robustness (detection) on accidental overwriting of data or DRP.
Additionally, by the write sequence it is ensured, that the read margin of the data is given, when the DCS is available.

NOTE:

The DRP widx is excluded from the checksum as it is updated in case of a Refresh, where the DCS is not recalculated (may not be recalculated as in case of an application update combined with IDL table update, the DCS indicates a possible DS length change to the user application).

- **EOR** End of Reference (1-bit Tag)
Additional safety for the case of data set write interruptions. In order not to waste an additional Flash word for this, the last data words Tag is used for EOR.

2.7.3.2 Invalidated DS

The Invalidated DS's are stored according to the following picture (data n-1 and data n-2):

Figure 14 DS Data and management information in Flash (invalidated DS)

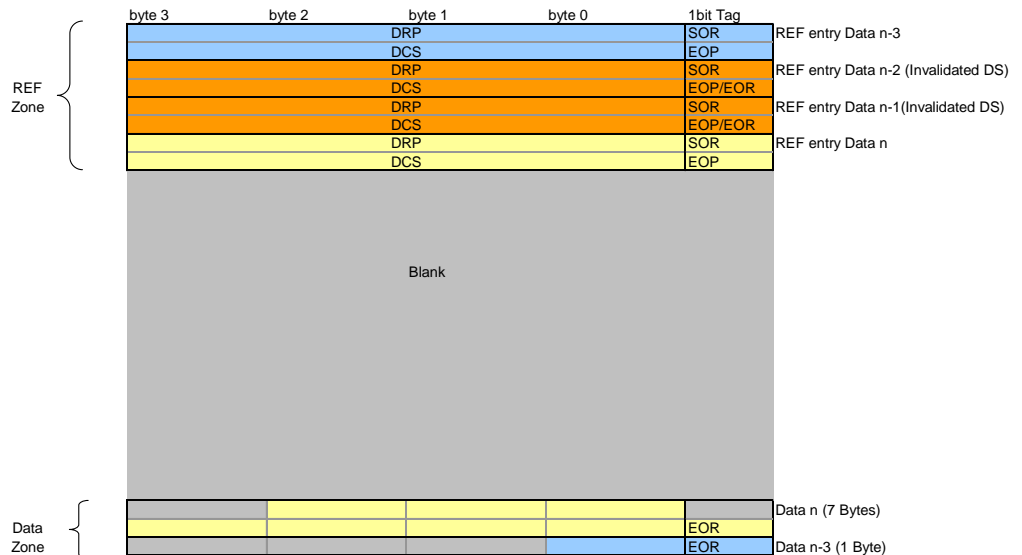

- **SOR** Start of reference entry (1-bit Tag)
It is written 1st in order to block one REF zone list entry.
 - **DRP** Data Reference Pointer (invalidated DS)
It is written after SOR and contains:
 - 16-bit lower half word: ID
 - 16-bit upper half word: widx = 0x0000
- Note:**
Widx = 0 identifies that the DS is invalidated and no data zone contents is addressed by this REF entry
- **EOP/EOR** End of Reference (1-bit Tag)
Is written immediately after the DCS. When written, the read margin of the DRP word is ensured by the write sequence.

- DCS Data Check Sum
This is a simple 32bit checksum, calculated just over the
DRP. It ensures higher robustness (detection) on accidental
overwriting of the DRP.
Additionally, by the write sequence it is ensured, that the read
margin of the EOR is given, when the DCS is available.

NOTE:

The DRP widx is excluded from the checksum as it is
updated in case of a Refresh, where the DCS is not re-
calculated (may not be recalculated as in case of an
application update combined with IDL table update, the DCS
indicates a possible DS length change to the user application.

Chapter 3 EEL Design

3.1 Process management

3.1.1 EEL operations priority

The EEL provides the following user operations which are invoked by appropriate commands: Immediate DS Write, Immediate DS Invalidate, DS Write, DS Invalidate, DS Read, Format, Cleanup. These commands have partially been mentioned before and are described in the API description.

The Read and Write operations are considered to be prioritized according to the following scheme:

- Priority 1) Read, can interrupt Write, Invalidation, Immediate Write and Immediate Invalidation
- Priority 2) Immediate Write and Immediate Invalidation can interrupt Write and Invalidation
- Priority 3) Write and Invalidation

The following rules apply to these operations:

All of the above operations can interrupt ongoing background operations.

A command invoking an operation when an operation of the same priority is ongoing will be rejected.

When an operation of a higher priority is invoked, a possibly ongoing operation of a lower priority will be suspended.

When invoking an operation of a lower priority, a possibly ongoing operation of a higher priority is will be finished first then the lower priority operation is executed.

Furthermore, special conditions apply for the other operations:

Format operation requires that the system executes no user or background operations. If this is not the case, the command will be rejected.

When started, all other operations are blocked.

Cleanup operation requires that the system executes no user or background operations. If this is not the case, the command will be rejected.

After being started other operations can be executed, the cleanup operation will be suspended and later on resumed automatically.

3.1.2 Process hierarchy

All user and background operations are served by a state machine, executing dedicated processes. Resulting from the operations hierarchy, the basic process hierarchy is defined as follows:

- **Read process**
Has the highest priority in order to have the lowest execution latency of the Read operation.
- **Immediate Write process**
This process serves the Immediate Write operation and Immediate Invalidation operation which have a high priority.
- **Write process**
This process serves the Write operation and Invalidation operation which have a lower priority than the immediate ones.
- **Write (Refresh) process**
This process serves the Write operations invoked by the Refresh process which have the lowest write priority.
- **Prepare process**
Is invoked by the Supervision process and so, needs a higher priority than the supervision process but a lower than the user Read/Write processes.
- **Refresh process**
Is invoked by the Supervision process and so, needs a higher priority than the supervision process but a lower than the user Read/Write processes and the Refresh Write process.
- **Format process**
Has a lower priority but anyhow is started only when no other process is active.
- **Supervision process**
This controls the startup processing, when no other process may be active. As soon as other processes are activated, this one is pushed to the background in order to be transparent for the user application.

The process scheduler judges the priority of the main processes and suspends/resumes the processes accordingly.

The following rules are considered:

- The startup process prohibits Read operations until DP and RP are calculated.
- The startup process prohibits Write operations until all DS margins are ensured.
- Process states need to be finished before a process can be suspended. This includes all Flash operations except Erase.
- If a process state containing a Flash erase is active:
 - The Flash erase is suspended.
 - The process step is finished.
 - A Flash erase resume process step is set as next step.

The basic suspend / resume mechanism is overruled by the startup procedure, where all other processes are locked from the beginning and are released step by step according to the Startup status.

Furthermore, the Format process immediately locks all other processes except Preparation, which is required for the Format.

Note:

All Write/Invalidation processes are based on one source code. The differentiation in the processes is done by the process local variables.

Figure 15 Process priority scheme

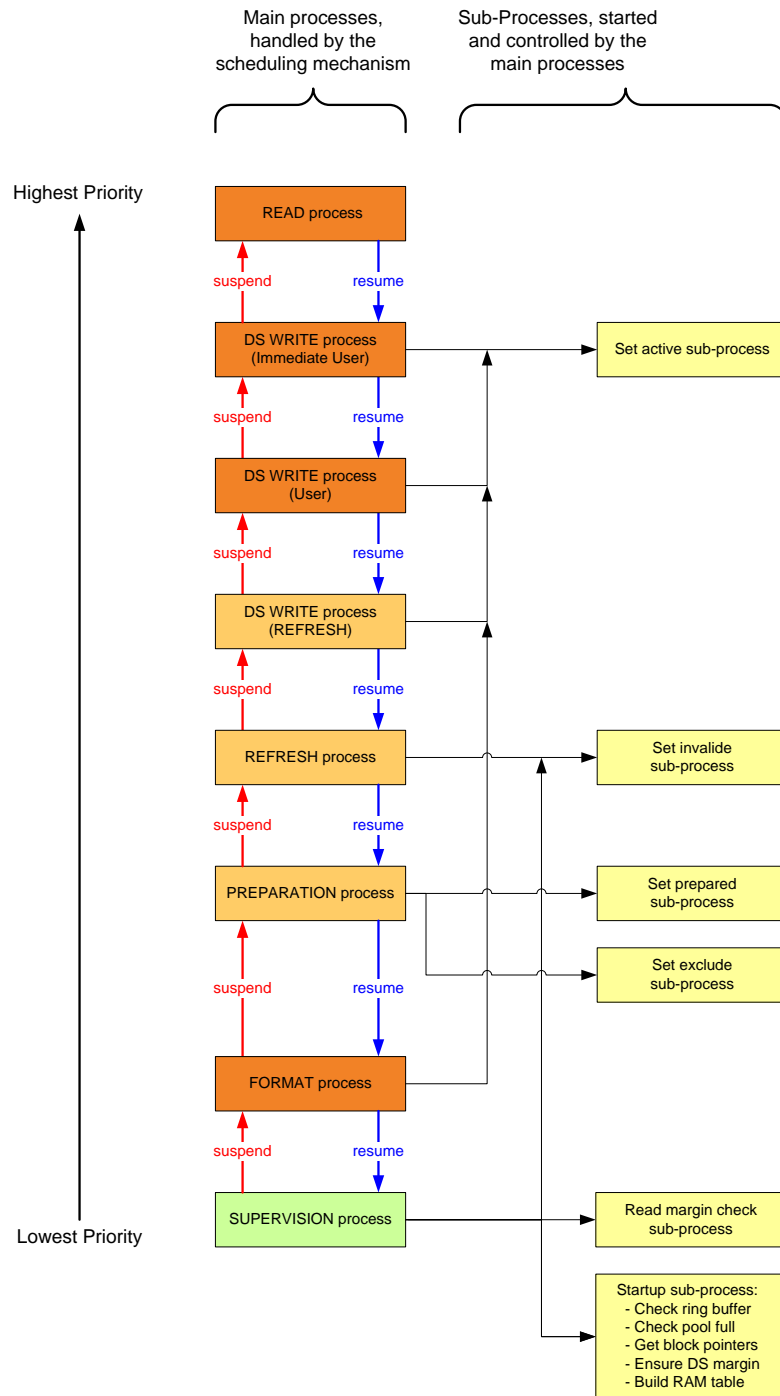

3.1.3 State machine

The state machine checks the activity of the main processes (Read, Write ...) and executes the active process with the highest priority.

Figure 16 State machine - process selection

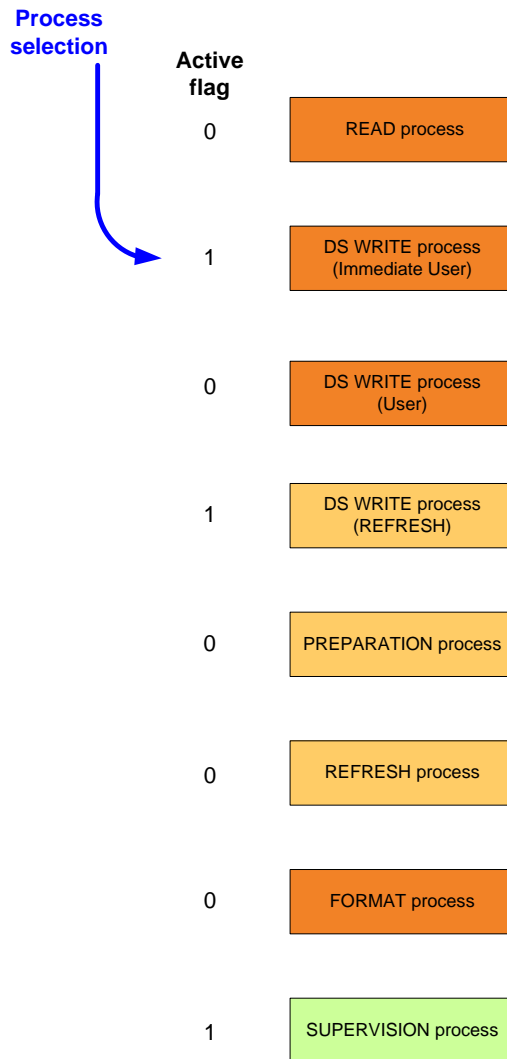

Each process / sub-process may contain different states with a limited execution time.

Figure 17 Process states execution

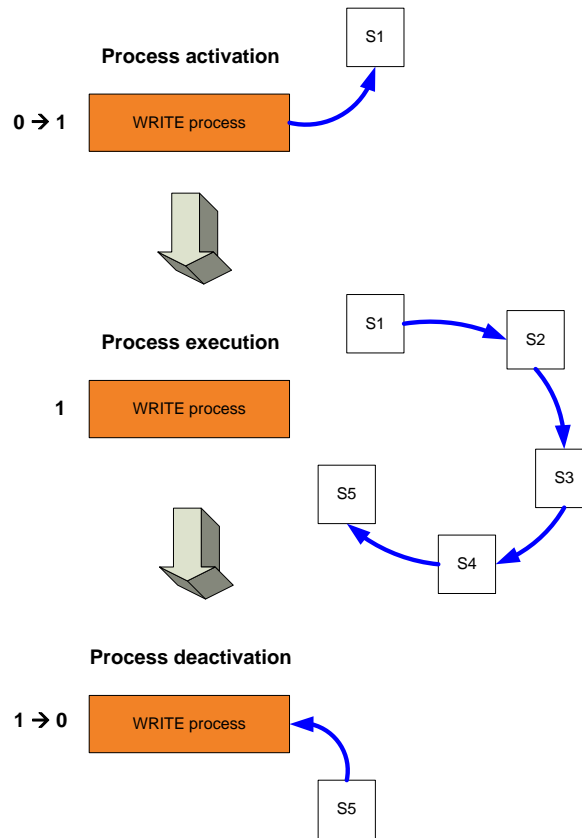

After finishing one state, the next state within this (sub) process is stored and the control is given back to the state machine, which then again selects the highest priority active process to execute.

All processes except the lowest priority supervision process have an exit or exception state, which result in deactivation of the process, so that other lower priority processes can be executed.

3.1.4 Asynchronous architecture

Each state has a strictly limited execution time. Based on that, the library function controlling the state machine (EEL_Handler, see API description) will immediately return to the user application. Due to dual operation between Code Flash and Data Flash the upper application can continue operation while frequently invoking the state machine handler function.

3.1.5 Process errors and warnings

3.1.5.1 Error reaction and return

Due to the case, that errors may happen in cause of user activated processes (e.g. write, read, format) or background processes (prepare, refresh, supervision), the error return to the user and the complete system reaction on the errors must be clearly defined.

The error reaction is classified in the chapter 5.3.1, "Error Codes":

- Warnings, e.g. EEL_ERR_BLOCK_EXCLUDED
These warnings are signalled to the user application but don't result in a emulation system reaction.
- Errors resulting in complete system lock, e.g. EEL_ERR_POOL_INCONSISTENT
The error is signalled to the user application and the complete system is locked:
 - No user commands accepted.
 - All ongoing user operations are stopped and return with error EEL_ERR_ACCESS_LOCKED.
 - All background processes are stopped.
- Errors resulting in read only mode, e.g. EEL_ERR_FLASH_ERROR during data set write:
The error is signalled to the user application and the complete system is in read only mode:
 - Only further user read command accepted, write and format are locked.
 - All ongoing user operations are stopped and return with error EEL_ERR_ACCESS_LOCKED (a read operation cannot be ongoing as this has the highest priority).
 - All background processes are stopped.

The errors/warnings are returned to the user application on two different ways:

- Errors on background operations are returned by a special function returning the driver status. Independently, in case of errors, ongoing and future user commands will be answered with EEL_ERR_ACCESS_LOCKED.
- Errors on user commands (Write, Read, Format) will be returned as command answer.

3.1.5.2 Internal process error handling

Every process has an own error status. The reaction on errors is different from the type of process:

- Sub-processes (e.g. set-invalid, set active)
These are not treated as individual processes but as states of their "master" processes.

On errors in the sub-processes just the master processes error status is set and a defined state (run state of the supervision process or finish state of other processes) of the master process is entered.

- Background processes (DS Write (Refresh), Refresh, Prepare)
All these processes are activated by another user or background process. Typically Supervision as top level background process activates other background processes (e.g. Supervision activates Refresh --> Refresh activates DS Write Refresh).
As special case also the Format user operation activates Prepare.

On errors the process error status is set and the affected process is finished. The error reaction is taken over by the higher level process when execution is continued there.

- **Background process Supervision**
This top level background process activates the background processes. After finish of these processes, the supervision checks the error status of these processes and depending on the result, the system reaction is handled (see 3.1.5.1, "Error reaction and return"). This also includes the startup sub-process functions which are also handled by the supervision.
- **User command processes (Read, Write, Format)**
These processes may activate other processes (e.g. Format activates prepare). After finish of these processes, the user command processes check the error status of the activated processes and depending on the result, the system reaction is handled (see 3.1.5.1, "Error reaction and return").

3.2 Data Set search and read

3.2.1 ID-L and IDX tables

The library uses internal tables to store the DS size information and latest DS location.

While the DS size is stored together with the ID statically in ROM, the pointers to the latest DS instances are evaluated on library startup and stored in RAM.

Figure 18 Library ID Tables

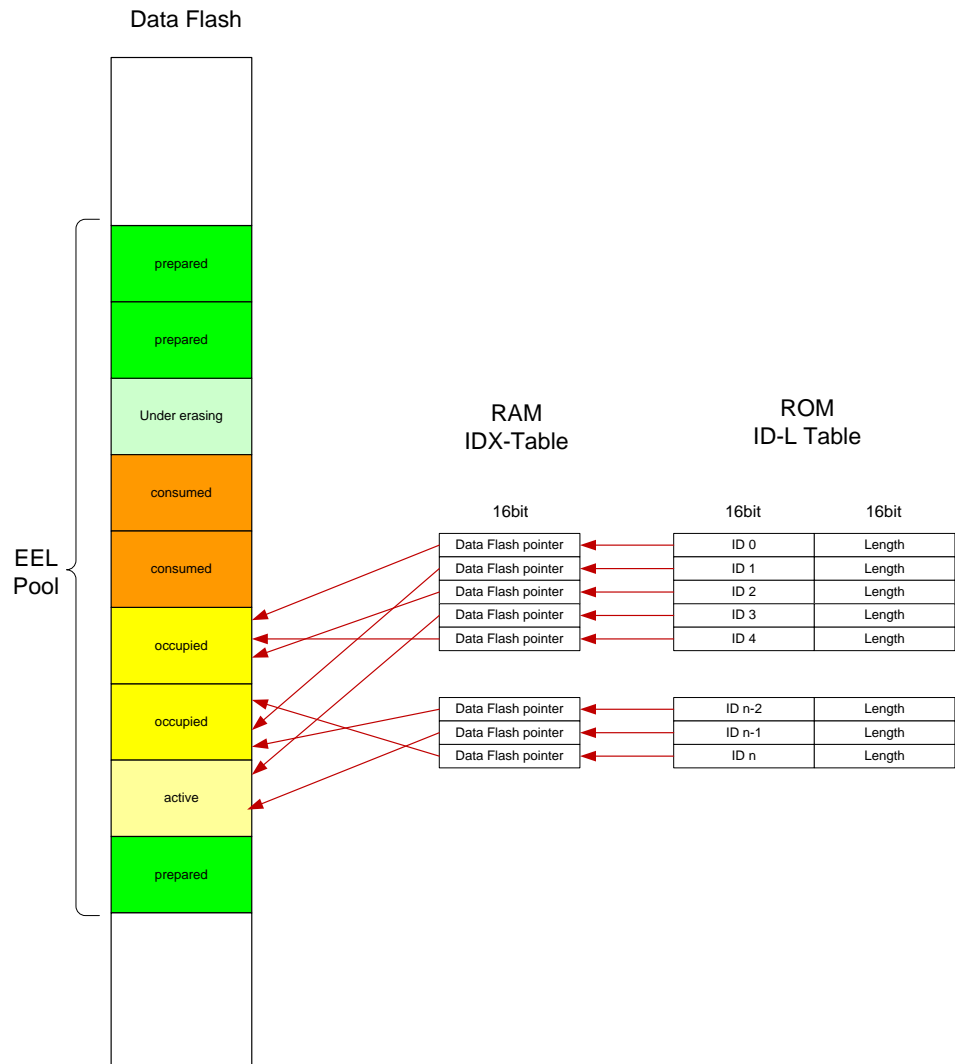

The ID-L table (ROM table) contains one entry for each ID available in the system, together with its DS length information. This table is configured at compile time.

IDX table (RAM table) contains for each ID available in the system the pointer to the latest data instance. On EEL startup the IDX table is filled and continuously updated on each DS Write access.

3.2.1.1 Data Read Mechanisms

ROM table search

Whenever a DS with a dedicated ID shall be read, the requested ID is searched in the ROM table. The index of the ROM table entry with the fitting ID is then used to get the data pointer (to the Data Flash) from the RAM table.

This ROM table search is fast, but the RAM table must be initialized on startup which requires some time.

The Rom table is used for Read as well as for the Refresh process.

REF zone search

In order to be able to read data without initialized RAM table, the library provides another read (data search) mechanism. The library can parse the REF zone of the blocks and read the entries sequentially until an entry with the requested ID is found. It needs to be considered, that the REF zone parsing requires some time and 100% CPU load.

This search mechanism is called REF-zone search.

The REF zone search is used in the library startup phase, when the ID-L table is not yet initializes and also in special library operation modes (see next sub-chapter).

3.3 Start-up processing

The start-up processing is controlled by the EEL state machine. After library initialization and start-up invocation (see EEL_Startup function API), several start-up process steps are executed until the system is in normal operation. Along with the start-up progress the access rights to the data and the library features are unlocked and the full performance of the EEL is reached.

The start-up progress can be checked by the user application with the function EEL_GetDriverStatus which returns the access status and the operational status. Please check the next figure for the status values depending on the progress:

Table 1 Start-up process progress steps

Start-up progress	access status	operational status	comment
EEL Initialized	EEL_ACCESS_LOCKED	EEL_OPERATION_PASSIVE	All library operations are prevented.
EEL startup started	EEL_ACCESS_LOCKED	EEL_OPERATION_STARTUP	All library operations are prevented.
EEL startup ongoing - basic startup finished	EEL_ACCESS_READ_WRITE	EEL_OPERATION_STARTUP	DS Read is possible with limited performance (REF zone search). DS Write is possible until the prepared blocks are full.
EEL startup ongoing - RAM table filled	EEL_ACCESS_UNLOCKED	EEL_OPERATION_STARTUP	DS Read is possible with full performance (ROM table search). DS Write is possible and supervision processing is active to manage the ring buffer.
EEL startup end	EEL_ACCESS_UNLOCKED	EEL_OPERATION_BUSY or _IDLE (depending if Refresh/Prepare operations are to be done)	- DS Read and DS Write as before - Electrical margin of the latest DS instances is ensured.

In case of a fatal error during any start-up step, the library switches to EEL_ACCESS_LOCKED and EEL_OPERATION_PASSIVE and the function EEL_GetDriverStatus will additionally return an appropriate error.

Note:

The last step (Ensure the electrical margin of the latest DS instances) checks if the last DS instances have been completely written. Therefore it checks if the last step of a DS write was executed (EOR is written). If not, redundant information (valid DCS) ensures that the DS data is valid. On detection of such cases, the DS is refreshed (copied to active zone head).

Figure 19 Start-up processing steps

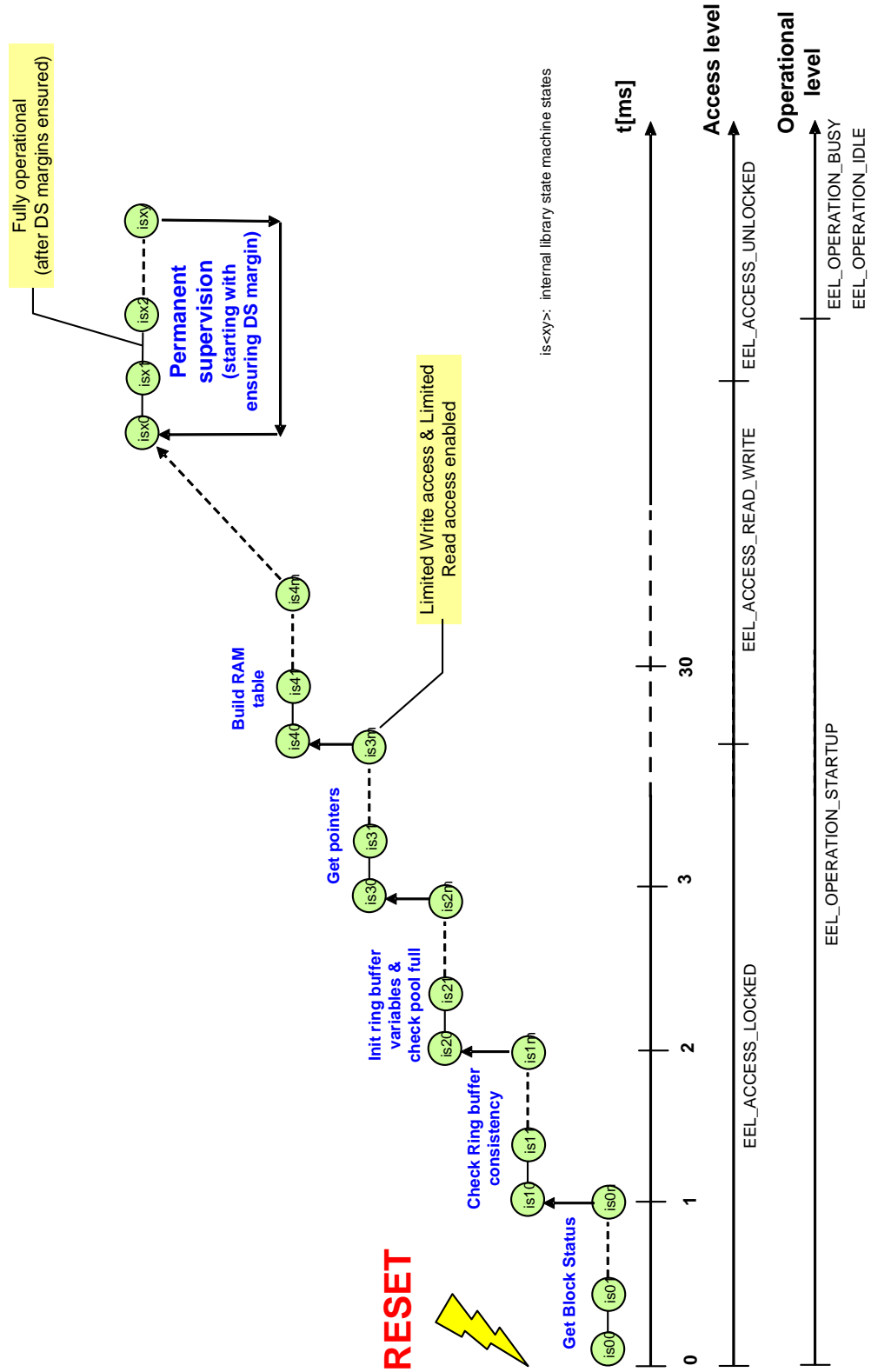

3.4 Function & command execution times & latencies

Basically three important times need to be considered when implementing the EEL into a user application:

- **Operation invocation latency**
 This is the time from calling EEL_Execute to issue the command and start an operation (e.g. Read, Write, ...) up to the point where the process of the operation is really started.
 This latency is determined by execution of higher priority operations but also by the delay to suspend a lower priority operation.
 Some process steps of lower priority operations cannot be suspended because they started Flash Write operations (erase can immediately be suspended).
 The 1st steps of the DS Write process until the user data is written cannot be suspended for higher priority Flash write operations because then the data consistency would be endangered.
 So, these process steps must be finished and by this determine the invocation latency of a higher priority operation.
- **EEL_Handler execution time**
 The handler execution time should be typically below 100us on a 100MHz device in order to realize a system with reliable timing. During normal operation this can be reached, but in the startup phase the execution times will be longer as complex calculations and searches are executed. In the startup phase this time is affected by many conditions and so can only be measured for a reference system, whereas the real timing needs to be evaluated by the customer in the user application.
 Issues affecting this time are e.g. DS Size, higher priority operations ongoing, pool size,...
- **Overall operation execution time**
 This is the time to execute a complete operation, like user DS write, user DS Read from operation invocation to operation finish.
 This time is affected by many conditions and so can only be measured for a reference system, whereas the real timing needs to be evaluated by the customer in the user application.
 Issues affecting this time are e.g. Flash Write time (in the evaluations also the worst case time need to be considered), DS Size, operation invocation latency, higher priority operations ongoing, ...
 So, in the next sub-chapters this time is not mentioned again.

3.4.1 Library startup phase

The library needs to execute various process steps according to the implementation concept (see startup phase description). The EEL_Handler execution time during steps will be partially >>100us, which need to be considered in the library implementation concept.

Note:

From implementation point of view the startup phase will end when the operational status changes from EEL_OPERATION_STARTUP to EEL_OPERATION_BUSY/IDLE. Then all startup operations are finished.
 From timing point of view, the startup phase will end when the access status changes from EEL_ACCESS_READ_WRITE to EEL_ACCESS_UNLOCKED.
 The remaining startup operations are executed in background and transparent for the user. Also the early Read (see below) ends on EEL_ACCESS_UNLOCKED.
 Please refer to chapter 5.3.3, "Driver status" for the defines.

3.4.1.1 Early Read command

Operation invocation latency

The maximum latency of the Read operation invocation by the EEL_Execute function is defined by the EEL_Handler execution time (see comments above). Furthermore, after invocation of the read, start of the Read process need to wait for the end of a possibly started 4-word Data Flash write (up to 4 words can be written by the Flash hardware in sequence without software interaction) caused by a Write command or by the startup process.

EEL_Handler execution time

A Read command executed in the library startup phase while the RAM table is not (completely) filled is called early read. The data of a DS with a certain ID to be read is found as follows:

- If the ID-X RAM table entry belonging to the ID is already filled, the entry addresses the data and the data can be read quickly.
- If the ID-X RAM table entry belonging to the ID is not yet filled, the DS is searched by parsing the REF entries from the youngest one backwards until a valid DS with the ID is found.

According to the possibly necessary REF entry parsing, the early Read may last longer time (>>100us) and requires 100% CPU load.

3.4.1.2 Early Immediate Write / Immediate Invalidation command

The early Immediate Write sequence does not differ to the normal Immediate Write.

Generally, a Write operation needs to wait for the end of a preceding Write or Invalidation operation. Trying to invoke a Write before will be rejected.

Operation invocation latency

The maximum latency of the Write operation invocation by the EEL_Execute function is defined by the EEL_Handler execution time (see comments above). Furthermore, after invocation of the write, starting of the Write/Invalidation process need to wait for:

- The end of a higher priority Read command.
- The end of blocking by a lower priority DS Write process invoked by user DS Write/Invalidation command or background Refresh process. In order to ensure data and ring buffer consistency, any DS Write process need to block higher priority Write commands until the process step to write the user data is reached. Blocking time is defined by 6 times a 1-word Data Flash Write (3-times to write SOR, RWP, EOP & 3 times to possibly activate a new block).

EEL_Handler execution time

The execution time should be <100us on a 100MHz device.

3.4.1.3 Early Write / Invalidation command

The early Write sequence does not differ to the normal Write.

Generally, a Write operation needs to wait for the end of a preceding Write or Invalidation operation. Trying to invoke a Write before will be rejected.

Operation invocation latency

The maximum latency of the Write operation invocation by the EEL_Execute function is defined by the EEL_Handler execution time (see comments above). Furthermore, after invocation of the write, starting of the Write process need to wait for:

- The end of a higher priority Read, Immediate Write or Immediate Invalidation command.
- The end of blocking by a lower priority DS Write process invoked by user DS Write/Invalidation command or background Refresh process. In order to ensure data and ring buffer consistency, any DS Write process need to block higher priority Write commands until the process step to write the user data is reached. Blocking time is defined by 6 times a 1-word Data Flash Write (3-times to write SOR, RWP, EOP & 3 times to possibly activate a new block).

EEL_Handler execution time

The execution time should be <100us on a 100MHz device.

3.4.2 Normal operation phase

If not mentioned otherwise, in the normal operation phase the EEL_Handler function execution time should always below 100us on a 100MHz device.

An ongoing Flash erase will not block any user command. The erase will be suspended and later on resumed. Anyhow, after a configurable number of times suspending, the warning EEL_ERR_ERASESUSPEND_OVERFLOW is returned in order to inform the user to give sufficient time to complete the erase operation rather than extremely frequently invoking Read/Write/Invalidation operations.

3.4.2.1 Read command

Operation invocation latency

The maximum latency of the Read operation invocation by the EEL_Execute function is defined by the EEL_Handler execution time (see comments above).

Furthermore, after invocation of the read, start of the Read process need to wait for the end of a possibly started 4-word Data Flash write (up to 4 words can be written by the Flash hardware in sequence without software interaction) caused by a Write command or by the background process.

EEL_Handler execution time

Typically the handler execution time will be below 100us, but might be increased above, if the DS to be read is big.

3.4.2.2 Immediate Write / Immediate Invalidation command

The normal operation Immediate Write and Immediate Invalidation sequence does not differ to the early Immediate Write/Invalidation. So please refer to this description.

3.4.2.3 Write / Invalidation command

The normal operation Write/Invalidation sequence does not differ to the early Write/Invalidation. So please refer to this description.

3.4.2.4 Format command

The Format command is considered as an exclusive command and can only be executed if the background state machine is EEL_OPERATION_IDLE or EEL_OPERATION_PASSIVE. So, invocation by EEL_Execute is rejected until this state is reached.

Operation invocation latency

The operation is invoked without latency as no other operations are ongoing.

EEL_Handler execution time

The handler execution time will be below 100us.

3.4.2.5 Cleanup command

The Cleanup command is considered as an exclusive command and can only be executed if the background state machine is EEL_OPERATION_IDLE. So, invocation by EEL_Execute is rejected until this state is reached.

Operation invocation latency

The operation is invoked without latency as no other operations are ongoing.

EEL_Handler execution time

The Cleanup command only sets a variable to more often call the Refresh process and Prepare process in background. The handler execution time will be below 100us.

Chapter 4 Implementation

4.1 File structure

The library is delivered as a complete compilable sample project which contains the EEL and FDL libraries and in addition to an application sample to show the library implementation and usage in the target application.

The application sample initializes the *EEL* and does some dummy data set *Write* and *Read* operations.

Differing from former EEPROM emulation libraries, this one is realized not as a graphical IDE related specific sample project, but as a standard sample project which is controlled by makefiles.

Following that, the sample project can be built in a command line interface and the resulting elf-file can be run in the debugger.

The FDL and EEL files are strictly separated, so that the FDL can be used without the EEL. However, using EEL without FDL is not possible.

The delivery package contains dedicated directories for both libraries containing the source and the header files.

Note:

The application sample does not contain sample code for the FDL interface usage, but only for the EEL interface. Anyhow, as the EEL contains FDL functions calls, the usage of the FDL functions can be derived from that.

4.1.1 Overview

The following picture contains the library and application related files.

Figure 20 Library and application file structure

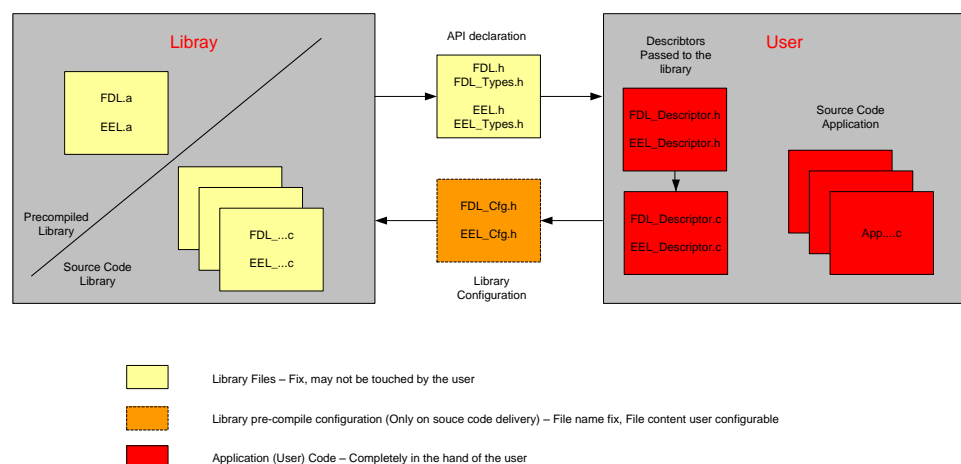

The library code consists of different source files, starting with FDL/EEL_*. The files may not be touched by the user, independently, if the library is distributed as source code or pre-compiled.

The file FDL/EEL.h is the library interface functions header file.

The file FDL/EEL_Types.h is the library interface parameters and types header file.

In case of source code delivery, the library must be configured for compilation. The file FDL/EEL_Cfg.h contains defines for that. As it is included by the library source files, the file contents may be modified by the user, but the file name may not.

FDL/EEL_Descriptor.c and FDL/EEL_Descriptor.h do not belong to the libraries themselves, but to the user application. These files reflect an example, how the library descriptor ROM variables can be built up which need to be passed with the functions FDL/EEL_Init to the FDL/EEL for run-time configuration (see FDL user manual and 5.4.1.1, "EEL_Init").

- The structure of the descriptor is passed to the user application by FDL/EEL_Types.h.
- The value definition should be done in the file FDL/EEL_Descriptor.h.
- The constant variable definition and value assignment should be done in the file FDL/EEL_Descriptor.c.

If overtaking the files FDL/EEL_Descriptor.c/h into the user application, only the file FDL/EEL_Descriptor.h need to be adapted by the user, while FDL/EEL_Descriptor.c may remain unchanged.

4.1.2 Delivery package directory structure and files

[root]	
Release.txt	Installer package release notes
[root]\[make]	
GNUPublicLicense.txt	Make utility license file
libconv2.dll	DLL-File required by make.exe
libintl3.dll	DLL-File required by make.exe
make.exe	Make utility
[root]\[<device name>]\[compiler]	
Build.bat	Batch file to build the application sample
Clean.bat	Batch file to clean the application sample
Makefile	Makefile that controls the build and clean process
[root]\[<device name>]\[<compiler>]\[sample]	
EELApp.h	Application sample header with function prototypes and collecting all includes
EELApp_Main.c	Main source code
EELApp_Control.c	Source code of the control program for EEPROM emulation
target.h	Target device and application related definitions.
... device header files ...	(GHS: df<device number>.h, io_macros.h, ... IAR: io_70f3xxx.h REC: -)
... startup file ...	(GHS: Startup_df<dev. num.>.850 IAR: DF3xxx_HWInit.s85

```

REC: cstart.asm)
... linker directive file ... ( GHS: Df<device number>.ld
IAR: Ink70f3xxx.xcl
REC: df3xxx.dir )

[root]\<device name>\<compiler>\[sample]\[EEL]
EEL_Cfg.h          Header file with definitions for library setup at
                   compile time
EEL.h             Header file containing function prototypes
EEL_Types.h       Header file containing calling structures and error
                   definitions
EEL_Descriptor.h  Descriptor file header with the run-time EEL
                   configuration. To be edited by the user.
EEL_Descriptor.c  Descriptor file with the run-time EEL configuration.
                   Should not be edited by the user.

[root]\<device name>\<compiler>\[sample]\[EEL]\[lib]
EEL_Global.h      Library internal defines, function prototypes and
                   variables
EEL_UserIF.c      Source code for the EEL internal state machine,
                   service routines and initialization
EEL_BasicFct.c    Source code of functions called by the state machine

[root]\<device name>\<compiler>\[sample]\[FDL]
FDL_Cfg.h         Header file with definitions for library setup at
                   compile time
FDL.h            Header file containing function prototypes
FDL_Types.h       Header file containing calling structures and error
                   definitions
FDL_Descriptor.h  Descriptor file header with the run-time FDL
                   configuration. To be edited by the user.
FDL_Descriptor.c  Descriptorfile with the run-time EEL configuration.
                   Should not be edited by the user.

[root]\<device name>\<compiler>\[sample]\[FDL]\[lib]
FDL_Env.h         Library internal defines for the Flash programming
                   hardware
FDL_Global.h      Library internal defines, function prototypes and
                   variables
FDL_UserIF.c      Source code for the library user interface and service
                   functions
FDL_HWAccess.c    Source code for the libraries HW interface

```

4.2 EEL Linker sections

The following sections are EEPROM emulation library related:

- FAL_Text
FDL code section, containing the hardware interface and user interface.
- FAL_Const
FDL data section, containing library internal constant data
- FAL_Data
FDL Data section containing all FDL internal variables
- EEL_Text
EEL code section containing the state machine, user interface and FAL interface
- EEL_Const
EEL data section, containing library internal constant data
- EEL_Data
EEL Data section containing all EEL internal variables

4.3 MISRA Compliance

The EEL and FDL have been tested regarding MISRA compliance.

The used tool is the QAC Source Code Analyzer which tests against the MISRA 2004 standard rules.

All MISRA related rules have been enabled. Findings are commented in the code while the QAC checker machine is set to silent mode in the concerning code lines.

Chapter 5 User Interface (API)

5.1 Pre-compile configuration

The pre-compile configuration of the EEL may be located in the `EEL_cfg.h`. The user has to configure all parameters and attributes by adapting the related constant definition in that header-file.

The configuration contains the following elements:

EEL_CFG_MAX_DATA_FLASH_SIZE:

Defines the maximum supported Data Flash size.

Currently Data Flash up to 256kB is supported. This define is reserved for future use and must be set to `EEL_CFG_MAX_DATA_FLASH_SIZE_256K`.

EEL_CFG_TAG_READ_OFFSET:

Defines the read address offset of the Data Flash Tags regarding the Data Flash base address.

This define is reserved for future use and must be set to `0x100000` for the current devices.

Implementation in `EEL_Cfg.h`:

```
#define EEL_CFG_MAX_DATA_FLASH_SIZE EEL_CFG_MAX_DATA_FLASH_SIZE_256K  
  
#define EEL_CFG_TAG_READ_OFFSET 0x100000
```

5.2 Run-time configuration

The overall EEL run-time configuration is defined by an EEL specific part (EEL run-time configuration) and by the FDL run-time configuration. Background of the splitting is that the FDL requires either common, by EEL and FDL used information (e.g. block size) or EEL related information (e.g. about the EEL pool size). So, this information is part of the FDL run-time configuration.

Both configurations of FDL and EEL are stored in descriptor structures which are declared in `FDL_Types.h` / `EEL_Types.h` and defined in `FDL_Descriptor.c` / `EEL_Descriptor.c` with header files `FDL_Descriptor.h` / `EEL_Descriptor.h`. The descriptor files (.c and .h) are considered as part of the user application.

The defined descriptor structures are passed to the libraries as reference by the functions `FDL_Init` and `EEL_Init`.

5.2.1 FDL run-time configuration elements

The descriptor contains the following elements; please also refer to chapter 2.3 "Data Flash Pools":

blkSize:

Defines the Data Flash block size in Bytes. This is just a configuration option reserved for future use. In all current Devices the Data Flash size is fixed to 2kB=0x800Bytes.

Value range: Currently fixed to 0x800

falPoolSize:

Defines the number of blocks used for the FAL pool, which means the User Pool + EEL Pool. Usually, the FAL pool size equals the total number of Flash blocks.

Value range: Min: EEL pool size
Max: Physical number of Data Flash blocks

eelPoolStart:

Defines the first Data Flash block number used as EEL pool.

Value range: Min: FAL Pool start block
Max: $eelPoolStart + eelPoolSize \leq falPoolSize$

eelPoolSize:

Defines the number of blocks used for the EEL pool.

Value range: Min: 4 Blocks (required for proper EEL operation)
Max: FAL pool size, condition:
 $eelPoolStart + eelPoolSize \leq falPoolSize$

Implementation:

The descriptor structure is defined in the module `FDL_Types.h`

```
typedef struct {
    fal_u16 blkSize_u16;
    fal_u16 falPoolSize_u16;
    fal_u16 eelPoolStart_u16;
    fal_u16 eelPoolSize_u16;
} fal_descriptor_t;
```

The descriptor variable definition and filling is part of the user application. The files FDL_Descriptor.h/c give an example which shall be used by the user application. Only FDL_Descriptor.h need to be modified for proper configuration while FDL_Descriptor.c can be kept unchanged.

Example variable definition and filling in FDL_Descriptor.c:

```
const fal_descriptor_t eelApp_fdlConfig =
{
    FAL_CONFIG_BLOCK_SIZE,
    FAL_CONFIG_DATAFLASH_SIZE,
    EEL_CONFIG_BLOCK_START,
    EEL_CONFIG_BLOCK_CNT
};
```

Example configuration in FDL_Descriptor.h:

Example 1)

Data Flash size is 32kB, separated into blocks of 2kB.

The EEL shall use the complete Data Flash for the EEL pool:

```
#define FAL_CONFIG_DATAFLASH_SIZE    16
#define FAL_CONFIG_BLOCK_SIZE        0x800
#define EEL_CONFIG_BLOCK_START        0
#define EEL_CONFIG_BLOCK_CNT         16
```

Example 2)

Data Flash size is 32kB, separated into blocks of 2kB.

The EEL shall use blocks 2 to 11 for the EEL pool, while blocks 0 to 1 and 12 to 15 can be used as user pool:

```
#define FAL_CONFIG_DATAFLASH_SIZE    16
#define FAL_CONFIG_BLOCK_SIZE        0x800
#define EEL_CONFIG_BLOCK_START        2
#define EEL_CONFIG_BLOCK_CNT         10
```

Example 3)

Data Flash size is 32kB, separated into blocks of 2kB; the EEL shall not be used at all. The complete Data Flash shall be used as user pool:

```
#define FAL_CONFIG_DATAFLASH_SIZE    16
#define FAL_CONFIG_BLOCK_SIZE        0x800
#define EEL_CONFIG_BLOCK_START        0
#define EEL_CONFIG_BLOCK_CNT         0
```

5.2.2 EEL run time configuration elements

The descriptor contains the following elements:

addDF

Defines the Data Flash start address in the physical address room. The definition is required for EEL internal calculations.

This is just a configuration option reserved for future use. In all current Devices the Data Flash address is fixed.

Value range: Fixed to 0x2000000

blkRefreshThreshold

Defines the number of blocks that shall be prepared in the ring buffer by default. In case of threshold underflow, the EEL supervision will initiate Refresh / Prepare operations by time until the threshold is exceeded again. Increasing the threshold allows fast sequences of data write without having to give the EEL time to do the Refresh/Prepare operations. Reducing the threshold improves the Flash usage as written data sets stay longer in the ring buffer and need less Refresh copy operations. When the threshold is set too low and the ring buffer gets full due to continuous data set write, the library will return error Pool Full and block further write operations until the supervision had enough time to prepare at least one additional Flash block.

Value range: Min: 2 Blocks (required for proper EEL operation)
Max: EEL pool size – 2

Example:

On a threshold of 6 the EEL will always try to have 6 prepared blocks as passive pool in the ring buffer. This means that the user application could write 10kB data in sequence without giving the EEL time to do background operations to prepare new space again (one block must remain prepared for pool full situation handling).

~1/3 of the total available Flash blocks might be a reasonable starting point to evaluate the balance between the possibility to write fast data sequences (big threshold) and reducing the data copy effort on refresh (low threshold). The service function `EEL_GetSpace` provides a tool to trace the available free space in the ring buffer during run-time which allows threshold optimization during run-time.

**IDLTab*

Pointer to ROM ID-L table, see chapter 3.2.1, "ID-L and IDX tables".

The ID-L table need to be defined as a 2-dimensional array of 16bit values as follows:

```
{ { ID1, size 1 }, { ID2, size 2 }, { ID3, size 3 }, ..... }
```

Value range: ID Min: 1
ID Max: 0xFFFFE
Size min: 1Byte (is adjusted library internal to word boundary)
Size max: Block size – Block header size - 12Bytes
= 2048 – 32 - 12
= 2004Bytes
(this is caused by the EEL implementation. Bigger data size would require significant overhead in the power fail and supervision concepts).

****IDXTab***

Pointer to ROM ID-X table, see chapter 3.2.1, “ID-L and IDX tables”.

The ID-X table is a 1-dimensional array of 16bit values. The ID-X table RAM is provided by the user application and filled and handled by the EEL.

IDLTabIdxCnt

Defines the size of the ID-L/X table in “number of entries”.

eraseSuspendThreshold_u16

When the EEL background operation executes the Prepare process, the Data Flash block is erased. Any user Read or Write operation will suspend the Flash Erase and after the operation resume the Erase again. Based on the UX6LF Flash implementation, this Erase Suspend/Resume flow is restricted. The Erase operation might not finish, if it is interrupted continuously. The user application must be realized in a way that the erase operation once gets the time to complete, which means that the user application must provide a time frame as long as the worst case Flash block erase time in which the erase operation is not suspended. As long as the erase is not finished, the EEL cannot continue to provide new free passive pool space for further write operations. In order to signal too often Erase suspends to the user application, the *eraseSuspendThreshold_u16* can be configured. A user operation resulting in exceeding the threshold will return a warning “erase suspend overflow”. This is no hard error resulting in EEL reaction but just a signal to the user application to provide enough time to the EEL to finish the background operation.

Value range: Min: 0 (On every erase suspend the warning is returned)
Max: 0xFFFF

Implementation:

The descriptor structure is defined in the module EEL_Types.h

```
typedef struct {
    eel_u32      addDF_u32;
    eel_u16      blkRefreshThreshold_u16;
    const eel_u16 (*idlTab_pau16)[2];
    eel_u16      *idxTab_pau16;
    eel_u32      idlTabIdxCnt_u32;
    eel_u16      eraseSuspendThreshold_u16;
} eel_descriptor_t;
```

The descriptor variable definition and filling is part of the user application. The files EEL_Descriptor.h/c give an example which shall be used by the user application. Only EEL_Descriptor.h need to be modified for proper configuration while EEL_Descriptor.c can be kept unchanged.

Example variable definition and filling in EEL_Descriptor.c:

```
const eel_u16          idlTab_aul6[][2] = EEL_CONFIG_IDL_TABLE;
eel_u16               idxTab_aul6[sizeof( idlTab_aul6 )>>1];

const eel_descriptor_t eelApp_eelConfig =
    {
        EEL_CONFIG_DF_BASE_ADDRESS,
        EEL_CONFIG_BLOCK_CNT_REFRESH_THRESHOLD,
        idlTab_aul6,
        &(idxTab_aul6[0]),
        ( sizeof( idlTab_aul6 ) >> 2 ),
        EEL_CONFIG_ERASE_SUSPEND_THRESHOLD
    };
```

Example configuration in EEL_Descriptor.h:

Data Flash size is 32kB, separated into blocks of 2kB.

The EEL shall use the complete Data Flash for the EEL pool,

blkRefreshThreshold is set to ~1/3 of 16 Flash blocks = 5, the erase shall be suspend able up to 10 times until the erase suspend warning is issued:

```
#define EEL_CONFIG_DF_BASE_ADDRESS          0x2000000
#define EEL_CONFIG_BLOCK_CNT_REFRESH_THRESHOLD  0x05
#define EEL_CONFIG_ERASE_SUSPEND_THRESHOLD    10

/*-----*\
EEL_CONFIG_IDL_TABLE
Descriptor table containing data set identifier and data set
length as:
{ { <16-bit ID>, <16-bit length in bytes> }, {...},
  {...}, .... }
/*-----*\
#define EEL_CONFIG_IDL_TABLE {
    { 0x1111, 0x0005 }, \
    { 0x2222, 0x0006 }, \
    { 0x3333, 0x0007 }, \
    { 0x4444, 0x0008 }, \
    { 0x5555, 0x0009 }, \
    { 0x6666, 0x000a }, \
    { 0x7777, 0x000b }, \
    { 0x8888, 0x000c }, \
    { 0x9999, 0x000d }, \
    { 0xaaaa, 0x0015 }, \
    { 0xbbbb, 0x0018 }, \
    { 0xcccc, 0x0033 } \
}
```

5.3 Data Types

5.3.1 Error Codes

Figure 21 EEL status & error codes

Error	Explanation	Root cause judgement	EEL Operation Impact	Recommended application reaction
EEL_OK	The operation finished successfully		None	Continue operation
EEL_BUSY	The operation has been started successfully		None	Continue operation
EEL_ERR_CONFIGURATION	The EEL_init function was called with wrong configuration data	Application bug	The library is not initialized	Stop EEPROM emulation and investigate in the root cause
EEL_ERR_PARAMETER	Wrong parameters have been passed to the EEL, e.g.: Wrong parameter in the request structure	Application bug	Current command rejected	Stop EEPROM emulation and investigate in the root cause
EEL_ERR_REJECTED	A new operation should be initiated although the state machine is still busy with a concurrent operation (e.g. EEL_CMD_READ --> EEL_CMD_READ, but not EEL_CMD_WRITE --> EEL_CMD_READ)	Application bug or intended behaviour	Current command rejected	Repeat the command when concurrent operation has finished
EEL_ERR_ERASESUSPEND_OVERFLOW	Read/Write operations are executed and lead to a background erase operation suspend. The Erase suspend took place so often, that the erase could not be completed for a long time. This error return shall be treated as warning. The counter until the warning is configurable by the user.	EEL System overload	None / Warning only	Reduce EEL load with Read/Write operations, so that the Flash erase has time to finish
EEL_ERR_ACCESS_LOCKED	A function or command which is locked was called. Reason for locking may be: 1) The library is not in the correct status for an operation 2) Due to an error the library switched to passiv and locks all new operations and ongoing lower-priority operations	1) Application bug 2) Application bug or Hardware problem	Current command / function execution rejected	Stop EEPROM emulation and investigate in the root cause
EEL_ERR_NO_INSTANCE	Either no DS corresponding to the ID could be found or the data has been invalidated explicitly (See Invalidation API)	Application bug or intended behaviour	None / Warning only	Continue operation - or - if the result is not expected, stop EEPROM emulation and investigate in the root cause
EEL_ERR_WRONG_CHECKSUM	The checksum of the Data Set does not match. Beside accidental data overwrite, also a change of the IDL ROM table (data length information) during application update by a boot loader might be the root cause	Application bug, hardware problem or intended behaviour	Read returns data, but it might be wrong	Continue operation - or - if the result is not expected, stop EEPROM emulation and investigate in the root cause
EEL_ERR_POOL_FULL	Due to high DS Write load, no more blocks could be prepared to gain space for new data	EEL System overload	Current command rejected	Stop further Write operations but call EEL_Handler frequently, until the EEL had time to prepare enough passive pool space
EEL_ERR_FLASH_ERROR	A Flash operation of the FDL (called by EEL) failed due to a Flash problem.	Hardware problem or Application bug	The Flash should be considered as defect, the library accesses are locked: - Write locked (Error occurred during normal operation) - Read & Write locked (Error occurred during startup)	Stop EEPROM emulation and investigate in the root cause
EEL_ERR_INTERNAL	A library internal error occurred, which could not happen in case of normal program execution (E.g., Program run-away, bug, ...)	Application Bug	The further library reaction is undefined: - All access is locked	Stop EEPROM emulation and investigate in the root cause
EEL_ERR_POOL_EXHAUSTED	Due to multiple Flash block exclusion no more blocks are available for Prepare operations. The error is very unlikely due to the Flash failure rate!	Hardware problem or Application bug	The Flash should be considered as defect: - Write locked	Stop EEPROM emulation and investigate in the root cause
EEL_ERR_BLOCK_EXCLUDED	A Prepare operation excluded a block as this could not be erased	Hardware Problem	None / Warning only	Continue operation
EEL_ERR_FIX_DONE	Startup has done a consistency fix-operation. This is a normal return value on Startup after power fail. The sections are assumed to be consistent and emulation can normally continue		None / Warning only	Continue operation
EEL_ERR_POOL_INCONSISTENT	The block consistency check of the startup routine found an inconsistency in the startup routine	Application bug, hardware problem or intended behaviour	The Flash must be formatted: - Read & Write locked	Continue operation with EEL_CMD_FORMAT or if the result is not expected, stop EEPROM emulation and investigate in the root cause
EEL_ERR_COMMAND	This error is also returned in case of block unformatted Flash The command to be executed is unknown	Application Bug	Current command rejected	Stop EEPROM emulation and investigate in the root cause

5.3.2 User operation request structure

All different user operations are initiated by a central initiation function (EEL_Execute). All information required for the execution is passed to the EEL by a central request structure. Also the error is returned by the same structure:

Figure 22 Request structure handling

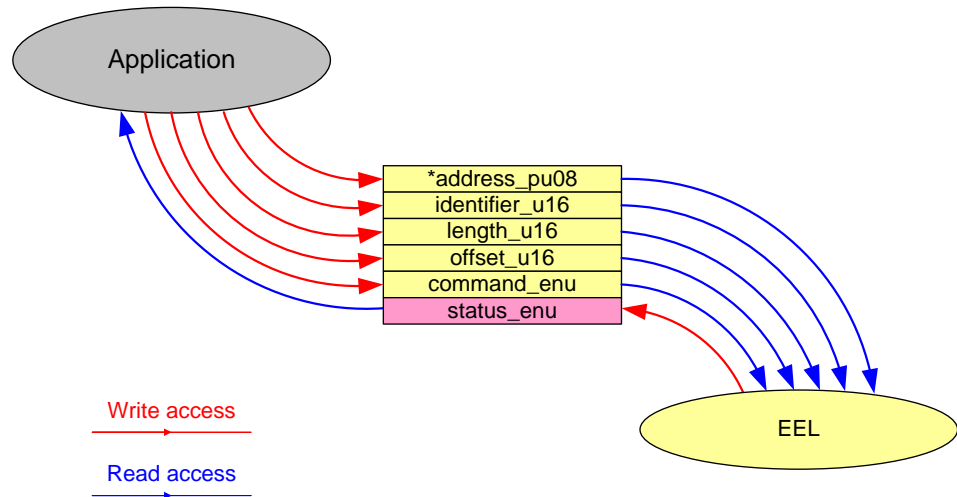

The following request elements are defined:

- **command_enu:** User operation to execute:

EEL_CMD_READ	Read a DS
EEL_CMD_WRITE	Write a DS
EEL_CMD_INVALIDATE	Write a DS data invalid
EEL_CMD_WRITE_IMM	Write a DS with high priority
EEL_CMD_INVALIDATE_IMM	Write a DS data invalid with high priority
EEL_CMD_FORMAT	Format the Data Flash for EEPROM
EEL_CMD_CLEANUP	Clean up ring buffer to provide as much as possible prepared ring buffer space
- ***address_pu08** Buffer pointer for the Read and Write operation.
- **identifier_u16:** 16bit ID, identifying the DS to read or write.
- **length_u16:** Only required for Read operation: Number of bytes to read from the DS.
- **offset_u16:** Only required for Read operation: Read offset from the DS bottom. Together with length the parameter is used to read only a fraction of the DS.
- **status_enu:** Status/Error codes returned by the library (see next page).

Type definition in EEL_Types.h

```
typedef enum {
    EEL_CMD_READ,
    EEL_CMD_WRITE,
    EEL_CMD_INVALIDATE,
    EEL_CMD_WRITE_IMM,
    EEL_CMD_INVALIDATE_IMM,
    EEL_CMD_CLEANUP,
    EEL_CMD_FORMAT
} eel_command_t;
```

```
typedef enum {
    /* Normal operation */
    EEL_OK,
    EEL_BUSY,

    /* Warnings */
    EEL_ERR_BLOCK_EXCLUDED,
    EEL_ERR_FIX_DONE,
    EEL_ERR_WRONG_CHECKSUM,

    /* Errors */
    EEL_ERR_CONFIGURATION
    EEL_ERR_PARAMETER,
    EEL_ERR_ACCESS_LOCKED
    EEL_ERR_FLASH_ERROR,
    EEL_ERR_POOL_EXHAUSTED,
    EEL_ERR_POOL_FULL,
    EEL_ERR_POOL_INCONSISTENT,
    EEL_ERR_REJECTED,
    EEL_ERR_NO_INSTANCE,
    EEL_ERR_COMMAND,
    EEL_ERR_ERASESUSPEND_OVERFLOW,
    EEL_ERR_INTERNAL
} eel_request_status_t;
```

```
typedef struct {
    eel_u32                *address_pu08;
    eel_u16                identifier_u16;
    eel_u16                length_u16;
    eel_u16                offset_u16;
    eel_command_t         command_enu;
    eel_request_status_t  status_enu;
} eel_request_t;
```

5.3.3 Driver status

Important driver status elements are stored in a state machine structure. The following status information is relevant for the user:

- Operational status

Defining the status of the state machine according to the following:

- EEL_OPERATION_PASSIVE
The state machine can handle neither internal nor user initiated processes.

This state is set:
 - before EEL startup
 - after EEL shutdown is finished
 - after fatal EEL operations errors
- EEL_OPERATION_IDLE
No process active except supervision doing margin checks. No Refresh or Prepare necessary and no user process Read, Write, Format active.
- EEL_OPERATION_BUSY
This status is set, if either a background process, e.g. Refresh or Prepare is active or a user process Read or Write is being processed. As Flash operations may be processed, the device should not be switched off in this status in order to avoid repair operations to be executed on EEL startup.
- EEL_OPERATION_STARTUP
This status is set as long as the startup background process is executed. This indicates that the EEL is not completely up and running. As long as this operational status is returned, EEL functionality is possibly limited. Please see emulation access status below and chapter 6.2.1, "Device start-up".
- EEL_OPERATION_SUSPENDED
When the suspend request is issued to the EEL by the EEL_Suspend function, the state machine enters the suspend mode. As this cannot be done immediately, the application need to wait until the suspend status is set.

- Emulation access status

During Startup the full functionality of the EEPROM emulation is not given. It is increased step by step depending on the proceeding of the Startup flow.

It is important, that not only Startup affects the access level, but also EEL failures resulting in loss of functionality. Depending on the failure, either Write is prohibited or no access is possible. See also error codes of the request structure in chapter 5.3.1, "Error Codes".

- EEL_ACCESS_LOCKED
During Startup:
The state machine is in an early startup phase and so, does not accept any user operation.
During normal operation:

Due to a failure no more data access is possible.

- EEL_ACCESS_READ_WRITE
During Startup only:
The state machine proceeded further in the startup phase and so, accepts DS read and write operations.
 - The read operations require REF table search as the RAM table is not yet available. So, the Read requires longer execution time at 100% CPU load.
 - The DS write capability is limited to the available passive blocks (prepared and invalid) as due to the missing RAM table no Refresh operation is possible.
- EEL_ACCESS_READ_ONLY
During normal operation only:
A user DS Write operation resulted in a Flash Write error, either caused by a hardware or a software problem. In order to preserve the remaining Flash contents the library forbids any further Flash modification operations. Read operations are still possible, however a certain risk is given, that the read data may be wrong if the write operation caused damage to the read data. This should be detected by the DCS check.
- EEL_ACCESS_UNLOCK
The state machine is up and running. All user and background operations should be possible, if no error occurred. The RAM table is built up, so Read operations are executed fast from now on.

- State machine errors

Error values of the state machine are returned. As only process errors are considered (no errors on EEL_Execute resulting in not starting a process), the error range is limited to:

- EEL_ERR_FIX_DONE
- EEL_ERR_FLASH_ERROR
- EEL_ERR_POOL_INCONSISTENT
- EEL_ERR_POOL_EXHAUSTED
- EEL_ERR_BLOCK_EXCLUDED
- EEL_ERR_INTERNAL
- EEL_ERR_ACCESS_LOCKED

Please refer to the error description for details

Type definition:

```
typedef enum {
    /* read- & write access disabled*/
    EEL_ACCESS_LOCKED,

    /* read only access, set in case of write
    error */
    EEL_ACCESS_READ_ONLY,

    /* read- & write-access enabled limited
    performance */
    EEL_ACCESS_READ_WRITE,

    /* full read- and write-access enabled */
    EEL_ACCESS_UNLOCKED
} eel_access_status_t;
```

```
typedef enum {
    /* all operations locked */
    EEL_OPERATION_PASSIVE,

    /* after Startup, maintenance passive,
    full operation possible */
    EEL_OPERATION_IDLE,

    /* any user request under processing */
    EEL_OPERATION_BUSY,

    /* While startup processes are running */
    EEL_OPERATION_STARTUP,

    /* User suspend */
    EEL_OPERATION_SUSPENDED
} eel_operation_status_t;
```

```
typedef struct {
    eel_operation_status_t    operationStatus_enu;
    eel_access_status_t      accessStatus_enu;
    eel_request_status_t     error_enu;
} eel_driver_status_t;
```

5.4 EEL Functions

Functions represent the functional interface to the EEL which other SW can use.

5.4.1 Initialization / Shut down

5.4.1.1 EEL_Init

Description

The EEL_Init() function is executed before any execution of other EEL functions. It initializes the basic EEL variables, but the state machine is not started.

This function also defines the operation mode of the library. While in the normal application the full operation must be enabled, in case of a boot loader not all information required for full operation might be available. Especially the ROM ID-table might be not present or not completely present if the application is being updated.

Interface

```
eel_status_t EEL_Init( const eel_descriptor_t* descriptor_pstr,
                      eel_operation_mode_t   opMode_enu );
```

Arguments

Type	Argument	Description
eel_opMode	opMode_enu	<ul style="list-style-type: none"> EEL_OPERATION_MODE_NORMAL Full operation of the library EEL_OPERATION_MODE_LIMITED Operation with limited ID-L-table in ROM (containing not all IDs → no Refresh possible)
eel_descriptor_t	descriptor_pstr	Pointer to the EEL run-time configuration descriptor structure in ROM

Return types/values

Type	Argument	Description
eel_status_t	-	Result of the function. Possible values are: EEL_OK EEL_ERR_ACCESS_LOCKED EEL_ERR_CONFIGURATION

The function checks the configuration in the descriptor variable for consistency. If a problem is found in the configuration, the error EEL_ERR_CONFIGURATION is returned:

- Threshold must be ≥ 2 blocks and at least 2 blocks must remain between threshold and EEL pool size.
- Max DS size must be $< \text{EEL_PFct_Calc_BlkSpace} - \text{REF entry size}$.

On check fail, the startup processing is locked and user operations will never be unlocked.

Pre-conditions

The library may not already be active (function EEL_Startup already called). In case of re-initialization, the function EEL_ShutDown must be called before EEL_Init. On violation the function ends with EEL_ERR_ACCESS_LOCKED.

Post-conditions

None

Example

eel_rtConfiguration is configured globally in EEL_Descriptor.c

```
ret = EEL_Init( eel_rtConfiguration, EEL_OPMODE_FULL );

if( EEL_OK != ret )
{
  /* Error treatment */
}
```

5.4.1.2 EEL_Startup

Description

This function starts the EEL state machine and initiates execution of the startup process.

By this function and continuous EEL_Handler calls, the library passes the startup status and enters the operational status.

Interface

```
eel_status_t EEL_Startup( void );
```

Arguments

-

Return types/values

Type	Argument	Description
eel_status_t	-	Result of the function. Possible values are: EEL_OK EEL_ERR_ACCESS_LOCKED

Pre-conditions

- The library must be initialized. Call EEL_Init before.
- The library may not already be active (function EEL_Startup already called). On violation the function ends with EEL_ERR_ACCESS_LOCKED.

In case of re-initialization, the function EEL_ShutDown must be called before EEL_Init and EEL_Startup.

Post-conditions

- Continuously call the EEL_Handler() function to forward the state machine to come to normal operation.

Example

Option: Wait after EEL_Startup until the library is completely up and running

```
eel_driver_status_t dStat;

ret = EEL_Init();

if( EEL_OK == ret )
{
    EEL_Startup();
}
else
{
    /*error treatment */
}

do
{
    EEL_Handler();
    EEL_GetDriverStatus( &dStat );
}
/* Wait until the system is up and running (or error) */
while(EEL_OPERATION_STARTUP ==
    dStat.operationStatus_enu );

/* Error check */
if( EEL_OK != dStat.errorStatus_enu )
{
    /* Error handler */
    . . .
}
}
```

Option: Wait after EEL_Startup until the library at least partially unlocked

```
eel_driver_status_t dStat;

ret = EEL_Init();

if( EEL_OK == ret )
{
    EEL_Startup();
}
else
{
    /*error treatment */
}

do
{
    EEL_Handler();
    EEL_GetDriverStatus( &dStat );
}
/* Wait until early read/write is possible (or error) */
while( ( EEL_OPERATION_STARTUP == dStat.operationStatus_enu )
    &&( EEL_ACCESS_LOCKED == dStat.accessStatus_enu ) );

/* Error check */
if( EEL_OK != dStat.errorStatus_enu )
{
    /* Error handler */
    . . .
}
}
```

5.4.1.3 EEL_ShutDown

Description

This function initiates deactivation of the EEL state machine.

After this function the EEL_Handler need to be continuously executed in order to finish eventually executed processes and to set the state machine status passive.

Effect on the processes:

- Startup
The process is stopped after a sub-process execution.
- Refresh
A ongoing DS Write is finished, then the Refresh is stopped.
- Prepare
The Prepare is finished in order not to waste a Flash erase cycle.
- User DS Write
A ongoing DS Write is finished.
- User DS Read
A ongoing DS Read is finished.

Interface

```
eel_status_t EEL_ShutDown( void );
```

Arguments

-

Return types/values

Type	Argument	Description
eel_status_t	-	Result of the function. Possible values are: EEL_OK EEL_ERR_ACCESS_LOCKED

Pre-conditions

- The library must be active. Call EEL_Startup before.

On violation the function ends with EEL_ERR_ACCESS_LOCKED.

Post-conditions

- Continuously call the EEL_Handler() function to forward the state machine to the shut-down status.
- Continuously call EEL_GetDriverStatus to detect when the state machine is shut-down

Example

```
eel_driver_status_t dStat;

/* ... */

Ret = EEL_ShutDown();
if( EEL_OK != ret )
{
    /* Error treatment */
}

/* Wait until operation end */
do
{
    EEL_Handler();
    EEL_GetDriverStatus( &dStat );
}
while(EEL_OPERATION_PASSIVE != dStat.operationStatus_enu );

/* Error check */
if( EEL_OK != dStat.errorStatus_enu )
{
    /* Error handler */
    . . .
}
```

5.4.2 Suspend / Resume

The library provides the functionality to suspend and resume the library operation in order to provide the possibility to synchronize the EEL Flash operations with possible user application Flash operations, e.g. write/erase by using the FDL library directly or read by direct Data Flash read access.

5.4.2.1 EEL_Suspend

Description

This function suspends the EEL operations and puts the EEL in a passive state.

Interface

```
eel_status_t EEL_Suspend( void );
```

Arguments

None

Return types/values

Type	Argument	Description
eel_status_t	-	Result of the function. Possible values are: EEL_OK EEL_ERR_ACCESS_LOCKED

Pre-conditions

- The library must be initialized. Call EEL_Init before.
- On violation the function ends with EEL_ERR_ACCESS_LOCKED.

Post-conditions

- Call EEL_Handler until the library is suspended (status EEL_OPERATION_SUSPENDED).

If the function returned successfully, no further error check of the suspend procedure is necessary, as a potential error is saved. This is restored on EEL_Resume.

Example

```
eel_driver_status_t dStat;

/* ... */

ret = EEL_Suspend();
if( EEL_OK != ret )
{
    /* Error treatment */
}

/* Wait until operation end */
do
{
    EEL_Handler();
    EEL_GetDriverStatus( &dStat );
}
while(EEL_OPERATION_SUSPENDED != dStat.operationStatus_enu );

/* Do other Flash operations or bring the device in power safe
mode */
...

ret = EEL_Resume();
if( EEL_OK != ret )
{
    /* Error treatment */
}

/ Continue with EEL operations */
```

5.4.2.2 EEL_Resume

Description

This function resumes the EEL operations after suspend.

Interface

```
ret = EEL_Resume( void );
```

Arguments

None

Return types/values

Type	Argument	Description
eel_status_t	-	Result of the function. Possible values are: EEL_OK EEL_ERR_ACCESS_LOCKED

Pre-conditions

- The library must be suspended. Call EEL_Suspend before and wait until the suspend process finished.

On violation the function ends with EEL_ERR_ACCESS_LOCKED.

Post-conditions

None

Example

See EEL_Suspend

5.4.3 Operational functions

5.4.3.1 EEL_Execute

Description

This function initiates an EEL user operation. The operation type and operation parameters are passed to the EEL by a request structure, the status and the result of the operation are returned to the user application also by the same structure. The required parameters as well as the possible return values depend on the operation to be started.

This function only starts a process according to the operation to be executed. The processes must be controlled and stepped forward by the state machine handler function `EEL_Handler` (explained later on).

Possible user operations are:

- Read

Read a DS or a fraction of the DS from the Data Flash to a user defined buffer address. The DS is identified by the ID, the offset from the DS start and the number of bytes to read can be specified.

Required parameters from the request structure:

- `identifier_u16` → ID to read
- `*address_pu08` → Destination buffer pointer
- `length_u16` → Number of bytes to read
- `offset_u16` → Offset from DS begin to start reading
- `command_enu` → `EEL_CMD_READ` for the Read operation

Parameter checks, resulting in return value `EEL_ERR_PARAMETER`:

- `Offset + length > DS size`
- Unknown ID

- Write

Writing data from a user defined address into a new DS instance identified by an ID. This is done with normal priority.

Required parameters from the request structure:

- identifier_u16 → ID to write
- *address_pu08 → source buffer pointer
- command_enu → EEL_CMD_WRITE for the Write operation

Parameter checks, resulting in return value EEL_ERR_PARAMETER:

- Unknown ID

- Invalidate

Writing a DS instance, identified by an ID invalid. This is done with normal priority.

Required parameters from the request structure:

- identifier_u16 → ID to invalidate
- command_enu → EEL_CMD_INVALIDATE for the Invalidation operation

Parameter checks, resulting in return value EEL_ERR_PARAMETER:

- Unknown ID

- Write Immediate

Writing data from a user defined address into a new DS instance identified by an ID. This is done with high priority, resulting in suspending an eventually ongoing DS write/invalidate with normal priority. Later on the normal priority operation is resumed.

Required parameters from the request structure:

- identifier_u16 → ID to write
- *address_pu08 → source buffer pointer
- command_enu → EEL_CMD_WRITE_IMM for the Write operation

Parameter checks, resulting in return value EEL_ERR_PARAMETER:

- Unknown ID

- Invalidate Immediate

Writing a DS instance invalid, identified by an ID. This is done with high priority, resulting in suspending an eventually ongoing DS write/invalidate with normal priority. Later on the normal priority operation is resumed.

Required parameters from the request structure:

- identifier_u16 → ID to invalidate

- `command_enu` → `EEL_CMD_INVALIDATE_IMM` for the Invalidation operation

Parameter checks, resulting in return value `EEL_ERR_PARAMETER`:

- Unknown ID

- **Format**

Format the Data Flash block structure, so that DS can be written. Format erases all Flash blocks and so deletes all eventually existing DS instances:

Required parameters from the request structure:

- `command_enu` → Set to `EEL_CMD_FORMAT` for the Format operation

Note:

After successful Format, the EEL must be restarted with `EEL_Init` --> `EEL_Startup` --> ...

- **Clean-up**

This operation initiates, that the active blocks are defragmented/cleaned-up in order to achieve as much as possible prepared blocks for new data. This command is recommended, before the EEL is started without a complete reference list (ID-L table). As in this case the Refresh cannot be executed, as much free space as possible for DS Write should be available. Please refer to chapter 6.3.7.2, "ID-L ROM table temporarily not available"

Cleanup concept:

This command sets an indication flag for cleaning to the supervision. The cleaning itself is handled by the supervision process by executing Refresh & Prepare operations over all active/occupied blocks. Cleaning is finished when the driver status changes from busy to idle again. The cleanup request structure immediately returns with `EEL_OK`.

Required parameters from the request structure:

- `command_enu` → Set to `EEL_CMD_CLEANUP` for the Clean-up operation

Note:

Format is executed as exclusive operation, Cleanup is started as exclusive operation (finished in background). Exclusive operations require that no other operation (except supervision) is ongoing. All other functions can be prioritized.

This prioritization allows executing up to three operations in parallel:

- Read
- Normal priority write/invalidate
- High priority write/invalidate

In order to do so, the application needs to provide separate request structures for these operations.

Interface

```
void EEL_Execute( eel_request_t request_str );
```

Arguments

Type	Argument	Description
eel_request_t	request_str	See chapter 5.3.1, "Error Codes"

Return types/values

Type	Argument	Description
eel_request_t	request_str. status_enu	The value is returned in the request structure error variable. EEL_BUSY EEL_ERR_REJECTED EEL_ERR_ACCESS_LOCKED EEL_ERR_PARAMETER EEL_ERR_COMMAND EEL_ERR_POOL_FULL

Note:

The user application can either react directly on the errors returned by the EEL_Execute function or call the handler function EEL_Handler and react on errors then. The errors set on EEL_Execute are not reset and the handler execution does not do additional operations in case of an error already set.

Pre-conditions

- Call EEL_Init to initialize the library
- Call EEL_Startup and call EEL_Handler cyclically to bring the library into operational status

Post-conditions

Call EEL_Handler to complete the initiated operation

Example

See EEL_Handler function

5.4.3.2 EEL_Handler

Description

This function handles the complete state machine. It shall be called frequently, but the calling style depends on the user application. Possible solutions are:

- **Asynchronous to EEL operation invocation by EEL_Execute in an operating system idle task**

In a normal system the CPU load is balanced in a way, that a sufficient idle time is available.

By calling from the idle task loop, the handler can be called frequently and the EEPROM Emulation performance is quite high. However, as the idle time is not always deterministic, also the emulation performance might not be deterministic enough.

Advantages:

- + Usually high emulation performance
- + No blocking of other user application operations

Disadvantages:

- Not always deterministic

- **Asynchronous to EEL operation invocation by EEL_Execute in a timed task**

By calling in a timed task a deterministic performance can be reached. However, as the Flash operations execution (Flash Write) usually require less than 200us, for best possible performance the handler should be called in very short time slices. As these are usually not available, the performance of the emulation decreases.

Advantages:

- + Deterministic

Disadvantages:

- Lower emulation performance

- **Synchronous with EEL operation invocation by EEL_Execute**

The handler is called in the same function context as EEL_Execute. The handler call is repeated in this function in a loop until the EEL operation has finished.

Advantages:

- + Highest performance

Disadvantages:

- function execution time is high and not deterministic

Interface

```
void EEL_Handler( void );
```

Arguments

-

Return types/values

Type	Argument	Description
eel_request_t	request_str. status_enu	<p>The value is returned in the request structure error variable, passed to the EEL_Execute function. The possible return values depend on the operation that was started as well as on the errors of background operations.</p> <p>This table describes not the errors set by operation invocation with the EEL_Execute function, but the errors, additionally set during operation execution.</p>
		<p>All operations</p> <ul style="list-style-type: none"> • EEL_OK • EEL_BUSY • EEL_ERR_REJECTED • EEL_ERR_COMMAND • EEL_ERR_ERASESUSPEND_OVERFLOW • EEL_ERR_INTERNAL
		<p>Additionally on Write and Invalidate:</p> <ul style="list-style-type: none"> • EEL_ERR_FLASH_ERROR • EEL_ERR_POOL_FULL • EEL_ERR_ACCESS_LOCKED
		<p>Additionally on immediate Write and immediate Invalidate:</p> <ul style="list-style-type: none"> • EEL_ERR_FLASH_ERROR • EEL_ERR_POOL_FULL • EEL_ERR_ACCESS_LOCKED
		<p>Additionally on Read:</p> <ul style="list-style-type: none"> • EEL_ERR_WRONG_CHECKSUM • EEL_ERR_NO_INSTANCE <p>Note: Even when the error EEL_ERR_WRONG_CHECKSUM is returned, the data is copied to the destination buffer in order to have the possibility to check the content.</p>
		<p>Additionally on Format:</p> <ul style="list-style-type: none"> • EEL_ERR_BLOCK_EXCLUDED • EEL_ERR_FLASH_ERROR • EEL_ERR_POOL_EXHAUSTED

Pre-conditions

- Call EEL_Init to initialize the library
- Call EEL_Startup and call EEL_Handler cyclically to bring the library into operational status
- Call EEL_Execute to initiate an EEL operation

Post-conditions

None

Example

```
eel_request_t req_str;
eel_u08      buffer[0x100];

/* Start the read operation */
req_str.address_pu08 = (&buffer[0]); /* Set receive buffer */
req_str.identifier_ul6 = 10u;
req_str.length_ul6 = 0x10u;
req_str.offset_ul6 = 0x13u;
req_str.command_enu = EEL_CMD_READ;

EEL_Execute( &req_str );

/* Wait until operation end */
while( EEL_BUSY == req_str.status_enu )
{
    EEL_Handler();
}

/* Error check */
If( EEL_OK != req_str.status )
{
    /* Error handler */
    . . .
}
```

5.4.4 Administrative functions

5.4.4.1 EEL_GetEraseCounter

Description

This function reads the current erase counter at the active Flash block of the ring buffer. Except potentially excluded blocks, the erase counter of all other blocks only differs from the active block in the range of +-1.

Note:

The erase counter is counting the ring buffer loops. As long as the ring buffer is normally handled by the library, the erase counter is counted up. Of course, the erase counter is as reliable as all EEPROM emulation data. It is handled by the library and any mistreatment outside the library (e.g. manual erase of the Flash) will destroy the erase counter.

Interface

```
eel_status_t EEL_GetEraseCounter( eel_u32 *counter_pu32 );
```

Arguments

-

Return types/values

Type	Argument	Description
eel_status_t		Result of the function. Possible values are: EEL_OK EEL_ERR_ACCESS_LOCKED
u32	counter_pu32	Pointer to the erase counter storage location

Pre-conditions

- The library must be unlocked:
 - Call EEL_Init to initialize the library
 - Call EEL_Startup and call EEL_Handler cyclically to unlock the access status (access status != EEL_ACCESS_LOCKED)
 - Do not call EEL_ShutDown or EEL_Suspend before

Post-conditions

None

Example

```
eel_u32      eraseCounter;
eel_status_t ret;

ret = EEL_GetEraseCounter( &EraseCounter );

if( EEL_OK != ret )
{
    /* Error treatment */
}
```

5.4.4.2 EEL_GetDriverStatus

Description

This function returns the state machine status into the driver status structure.

Interface

```
eel_status_t EEL_GetDriverStatus( eel_driver_status_t
                                  *driverStatus_str );
```

Arguments

Type	Argument	Description
eel_status_t		Result of the function. Possible values are: EEL_OK EEL_ERR_ACCESS_LOCKED
eel_driver_status_t	driverStatus_str	Pointer to the driver status structure to update. See chapter 5.3.3, "Driver status"

Return types/values

-

Pre-conditions

Call EEL_Init to initialize the library

Post-conditions

None

Example

```
eel_driver_status_t dStat;
eel_status_t        ret;

ret = EEL_GetDriverStatus( &dStat );

if( EEL_OK != ret )
{
  /* Error treatment */
}
```

5.4.4.3 EEL_GetSpace

Description

This function returns the current free space in the EEL ring buffer (prepared space for new data).

As the library always need to reserve one block for refreshing data sets (copy from the ring buffer tail to the front), the function reduces the prepared space by one block.

Calculation base:

$$\text{Free space} = (\text{no. of prepared blocks} - 1) * (\text{block size} - \text{block header} - 1 \text{ word}) + \text{remaining space in the active block}$$
Interface

```
eel_status_t EEL_GetSpace( eel_u32 *space_pu32 );
```

Arguments

-

Return types/values

Type	Argument	Description
eel_status_t		Result of the function. Possible values are: EEL_OK EEL_ERR_ACCESS_LOCKED
u32	space_pu32	Pointer to the space calculation result storage location

Pre-conditions

- The library must be unlocked:
 - Call EEL_Init to initialize the library
 - Call EEL_Startup and call EEL_Handler cyclically to unlock the access status (access status != EEL_ACCESS_LOCKED)
 - Do not call EEL_ShutDown or EEL_Suspend before

Post-conditions

None

Example

```

eel_u32      space;
eel_status_t ret;

ret = EEL_GetSpace( &space );

if( EEL_OK != ret )
{
/* Error treatment */
}

```

5.4.4.4 EEL_GetVersionString

Description

This function returns the pointer to the library version string. The version string is the zero terminated string identifying the library.

Interface

```
(const eel_u08*) EEL_GetVersionString( void );
```

Arguments

-

Return types/values

The library version is returned as string value in the following style:

“EV850T05xxxxyZabc”

with

x = supported compiler

y = compiler option

Z = “E” for engineering versions,

“V” for final versions

abc = Library version numbers according to version Va.b.c

Pre-conditions

None

Post-conditions

None

Example

```

eel_u08 *vstr_pu08;

vstr_pu08 = EEL_GetVersionString();

```

Chapter 6 EEL Implementation into the user application

6.1 First steps

There are several ways to approach the EEPROM emulation concept and the implementation into the user application.

It is for sure worth knowing the basics of the Renesas EEPROM emulation concept and the library architecture, design and implementation. By that, you most probably get a feeling of the EEPROM emulation complexity at all and might consider that the implementation into the user's application is not done in a few days but requires careful consideration of the libraries features and requirements and the users application requirements.

A few things worth mentioning here are:

- Start-up time until 1st data read and write
- CPU load by the EEL, during library start-up and during normal operation
- Where to call the EEL_Handler function
- Where to call the EEL_Execute function
- How to map application variables to the EEL IDs
- ...

All these questions require some hands on experience with the EEL.

The best way after initial reading the user manual will be testing the EEL application sample.

6.1.1 Application sample

After a first compile run, it will be worth playing around with the library in the debugger. By that you will get a feeling for the source code files, the request structure mechanism and the library startup behavior.

Note:

Before the first compile run, the compiler path must be configured in the application sample file "makefile":

Set the variable COMPILER_INSTALL_DIR to the correct compiler directory

Later on the sample might be extended by further IDs and different data read and write sequences in order to come nearer to the later application requirements (data set amount and size) and to get a feeling of the CPU load and execution time during start-up and normal operation.

After this exercise, it might be easier to understand and follow the recommendations and considerations of this document.

6.2 Standard EEL life cycle

The following flow chart represents the recommended EEL life cycle during device operation including the API functions to be used.

Figure 23 EEL life cycle

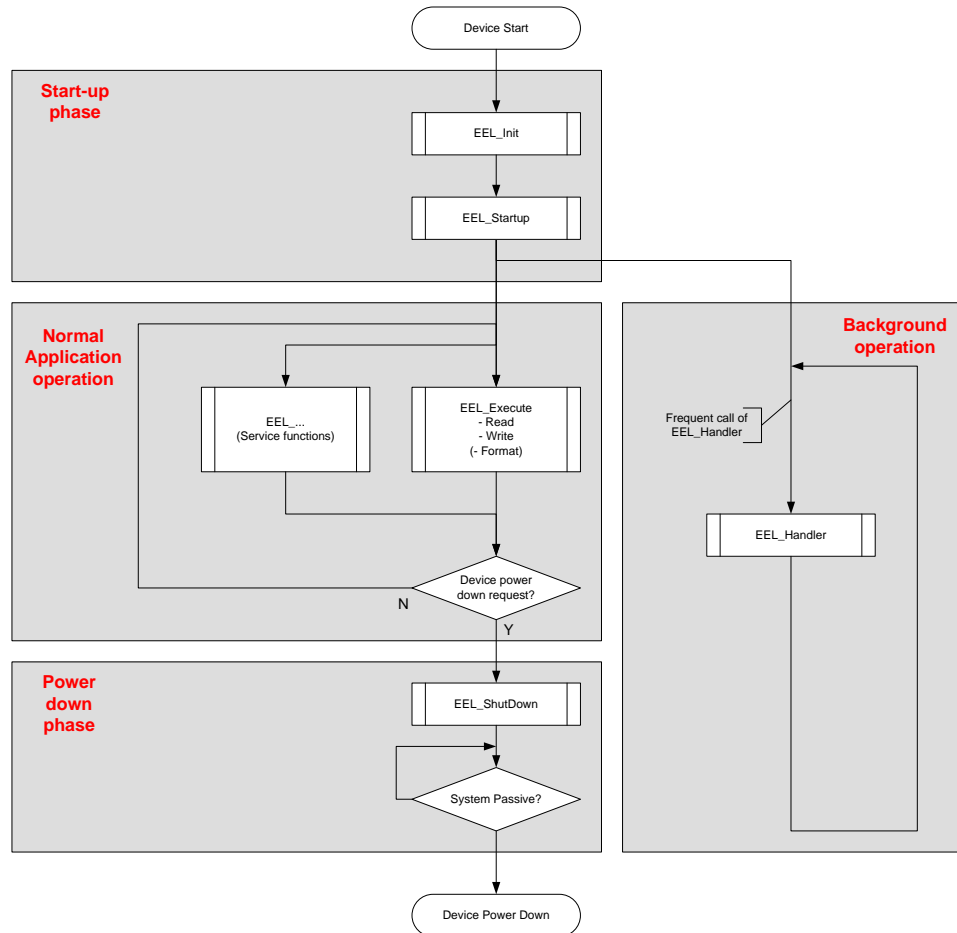

In the startup phase, the EEL is initialized by EEL_Init and the background operation is started by EEL_StartUp

During normal operation, the foreground operations (user operations) are initiated synchronous to the application, while the background handler task ought to be executed in a task, asynchronous to the application (idle task, interrupt task, timed task)

In the power down phase the EEL is shut down. EEL_Handler need to be executed until the library status is passive. This is required in order to finalize ongoing EEL processes.

6.2.1 Device start-up

The device boots and the application start up. Usually very soon some data sets need to be read. Then the EEPROM emulation has some time to come up completely before the rest of the data need to be read (e.g. build up a RAM mirror) and written.

The example code below reads and writes data as soon as possible and then waits until the EEL is fully operational and unlocked

```

u08          buffer_au08[0x100];
eel_request_t req_str;
eel_driver_status_t dStat;
eel_status_t res;

/* -----
   Initialize the EEL
   - eel_RTConfiguration_str should have been set in
     EEL_Descriptor.c
   ----- */
res = EEL_Init( eel_RTConfiguration_str,
               EEL_OPERATION_MODE_NORMAL );
if( EEL_OK != res )
{
  /* Error handler */
  . . .
}

res = EEL_Startup();
if( EEL_OK != res )
{
  /* Error handler */
  . . .
}

/* -----
   Wait until we can read/write 1st data sets
   ----- */
do
{
  EEL_Handler();
  EEL_GetDriverStatus( &dStat );
}
/* Wait until early read/write is possible (or error) */
while( ( EEL_OPERATION_STARTUP == dStat.operationStatus_enu )
      &&( EEL_ACCESS_LOCKED == dStat.accessStatus_enu ) );

/* Error check */
if( EEL_OK != dStat.errorStatus_enu )
{
  /* Error handler */
  . . .
}

```

```

/* -----
   Early read/write operation
   ----- */
req_str.address_pu08  = (&buffer[0]);
req_str.identifier_ul6 = 10u;
req_str.length_ul6   = 0x10u;
req_str.offset_ul6   = 0x13u;
req_str.command_enu   = EEL_CMD_READ;

EEL_Execute( &req_str );

/* Wait until operation end */
while( EEL_BUSY == req_str.status_enu )
{
    EEL_Handler();
}

/* Error check */
if( EEL_OK != req_str.status_enu )
{
    /* Error handler */
    . . .
}

req_str.address_pu08  = (&buffer[0]);
req_str.identifier_ul6 = 10u;
req_str.command_enu   = EEL_CMD_WRITE;

EEL_Execute( &req_str );

/* Wait until operation end */
while( EEL_BUSY == req_str.status_enu )
{
    EEL_Handler();
}

/* Error check */
if( EEL_OK != req_str.status_enu )
{
    /* Error handler */
    . . .
}

```

```

/* -----
   Wait for fully operational and access unlock
   ----- */
do
{
    EEL_Handler();
    EEL_GetDriverStatus( &dStat );
}
/* Wait until the system is completely up and running
   (or error) */
while(EEL_OPERATION_STARTUP == dStat.operationStatus_enu );

/* Error check */
if( EEL_OK != dStat.errorStatus_enu)
{
    /* Error handler */
    . . .
}

/* -----
   Now the EEL is fully operational
   ----- */

```

6.2.2 Device normal operation

When the device has passed the startup phase and is in normal operation, the complete functionality is available.

The example code below reads and writes data sets.

```

/* -----
   Normal operations
   ----- */
req_str.address_pu08 = (&buffer[0]);
req_str.identifier_ul6 = 10u;
req_str.length_ul6 = 0x10u;
req_str.offset_ul6 = 0x13u;
req_str.command_enu = EEL_CMD_READ;

EEL_Execute( &req_str );

/* Wait until operation end */
while( EEL_BUSY == req_str.status_enu )
{
    EEL_Handler();
}

/* Error check */
if( EEL_OK != req_str.status_enu )
{
    /* Error handler */
    . . .
}

req_str.address_pu08 = (&buffer[0]);
req_str.identifier_ul6 = 10u;
req_str.command_enu = EEL_CMD_WRITE;

EEL_Execute( &req_str );

/* Wait until operation end */
while( EEL_BUSY == req_str.status_enu )
{
    EEL_Handler();
}

/* Error check */
if( EEL_OK != req_str.status_enu )
{
    /* Error handler */
    . . .
}

```

Most important operation control signals are the status of a requested user operation and the driver status. The following diagram shows the relationship between a request and execution of background operations.

Figure 24 Operations state diagram

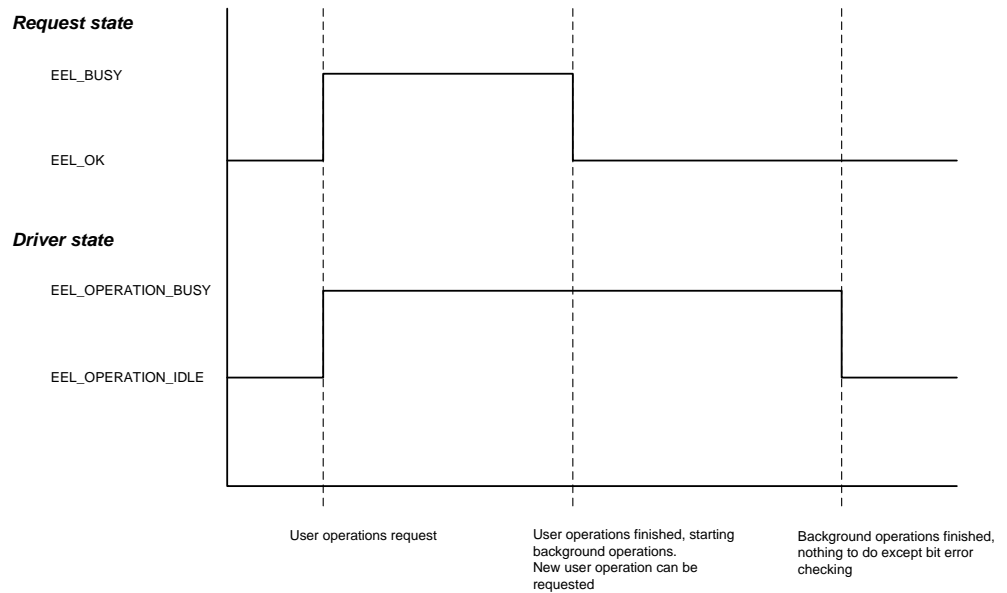

The handler call frequency significantly determines the EEL performance. As long as the driver or request state is busy, the handler should be called with higher frequency. When the driver state is idle, the call frequency can be reduced as then only cyclical bit error checks are done by the EEL. Then, on each handler call one Flash word (incl. tag) is checked.

6.2.3 Device power down

On power down, the user application should give the library time to finish background operations which are under progress. This can be reached by using the service functions in the following way:

```

/* -----
   Request Library shutdown
   ----- */
EEL_Shutdown();

/* -----
   Wait until all background processes are finished and the
   supervision gets passive
   ----- */
do
{
    EEL_Handler();
    EEL_GetDriverStatus( &dStat );
}
while(EEL_OPERATION_PASSIVE != dStat.operationStatus_enu );

/* Error check */
if( EEL_OK != dStat.errorStatus_enu)
{
    /* Error handler */
    . . .
}

```

6.3 Special considerations

6.3.1 Endurance calculations

Every write operation of a new data set instance occupies space in the Data Flash. When a certain amount of Data Flash is filled, new space is created by Refresh and Prepare processes where the Refresh process copies data which is still valid from the ring buffers active zone tail block to the active zone head block. When finished the Prepare operation can erase the tail block.

This is repeated many times over device lifetime. However, the endurance of the Data Flash blocks regarding number of erase cycles is limited. So, it is necessary to calculate the number of erase cycles required over device life time and to judge if this does not exceed the specified Data Flash endurance.

Renesas provides an endurance calculation sheet which can be filled with the different data sets sizes and the required write cycles. That sheet can estimate the expected number of Flash erase cycles and judge if this exceeds the specification.

Note:

The endurance calculation sheet is a very helpful tool, but still the result is just an estimation and cannot be absolute accurate because the result depends on different conditions like e.g. the sequence of the written Data sets. So, the result must be confirmed in the real user application.

The calculation sheet can either be loaded from the Renesas download page mentioned in the "Introduction" chapter or be requested at the Renesas Flash support under:

application_support.flash-eu@lm.renesas.com

6.3.2 Data Flash initialization

Before being able to normally use the Data Flash for EEPROM emulation, the Flash must be formatted and (depending on the application) be filled with initial data set instances.

This can be done using different approaches. Often used ones are:

- The application itself executes the Format operation and then writes initial instances of the data sets.
As the format operation deletes all data, it shall be carefully considered how to prevent accidental formatting by the application!
- A serial programming tool (e.g. PG-FP5) or debugger is used to program the Data Flash in the same flow, that also programmes the Code Flash.
- In a self-programming flow a boot loader normally updates the application code in the Code Flash. During this flow, also the Data Flash can be filled using the FDL directly.

For the later solution with the programming tool or debugger a hex file is required which contains the Data Flash contents (complete EEL pool content).

This content can be gained by:

- Dumping the Flash content of an already formatted Data Flash to a hex file using a serial programming tool or the debugger.
- Using a tool chain called Data Flash Converter and Data Flash Editor to convert a raw data description in an xml file into a hex file. This tool chain will be provided by Renesas on request when available.

Figure 25 Data Flash initialization tool chain

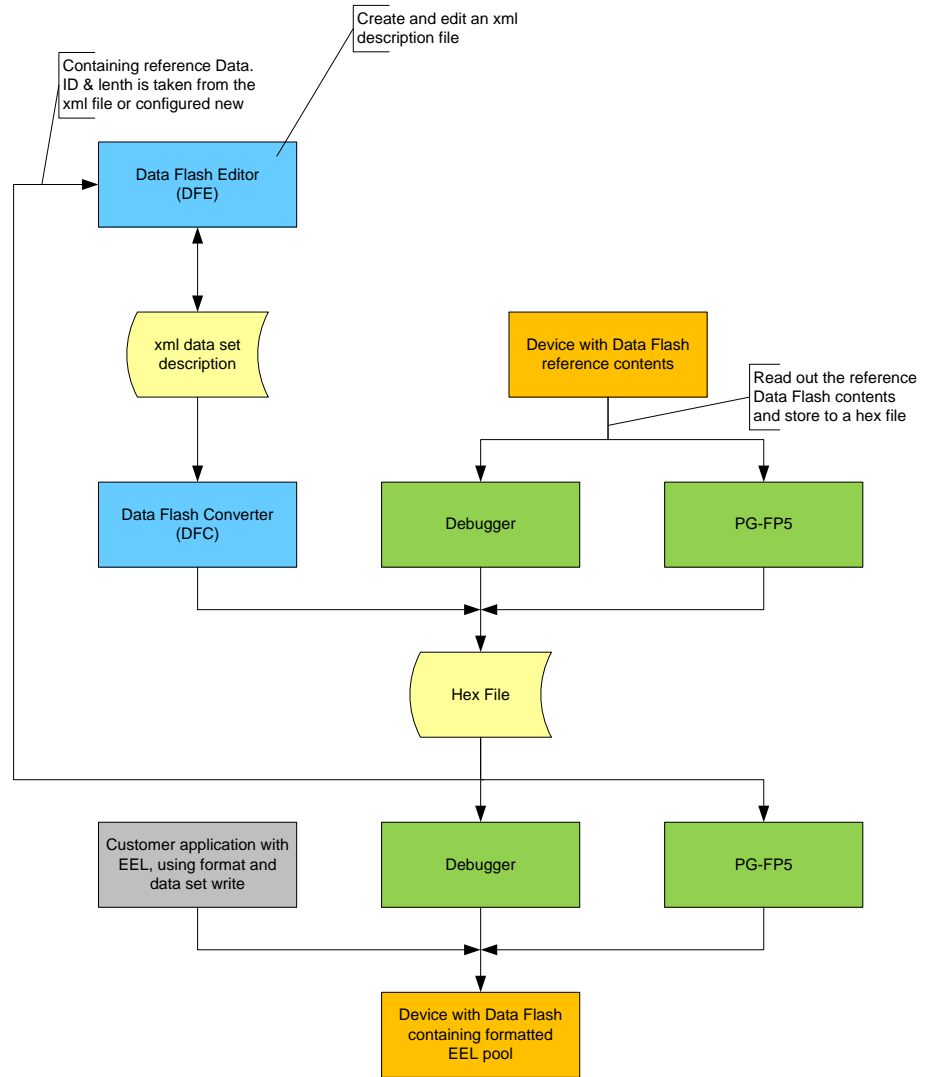

6.3.3 Library handling by the user application

6.3.3.1 Function re-entrancy

All functions are not reentrant. So, reentrant calls of any EEL or FDL functions must be avoided.

6.3.3.2 Task switches, context changes and synchronization between EEL functions

All EEL functions depend on EEL global available information and are able to modify this. In order to avoid synchronization problems, it is necessary that at any time only one EEL function is executed. So, it is not allowed to start an EEL function, then switch to another task context and execute another EEL function while the last one has not finished.

Example of not allowed sequence:

- Task1: Start an EEL operation with EEL_Execute
- Interrupt the function execution and switch to task 2, executing EEL_Handler function
- Return to task 1 and finish EEL_Execute function

As the EEL may not define critical sections which disable interrupts in order to avoid context changes and task switches, this synchronization need to be done by the user application.

6.3.3.3 EEL operation performance

The performance of the EEL operations strongly depends on the frequency of the handler calls. This especially affects operations which require many Flash write operations until the operation is finished, such as DS Write and background operations such as Startup processing or Refresh.

As the typically Flash write operation needs between 200 and 500us, a slower handler call frequency significantly reduces the operation performance.

The following user application implementations are judged regarding advantages and disadvantages (also mixtures are possible if the synchronization of the function calls is ensured):

- Call in a timed task
In order to archive a reasonable emulation operation performance, the time slice should not be selected too big. A 500us interval would not significantly reduce the EEL performance and so seems to be a reasonable compromise between library performance and CPU load.
- Call in the idle task
If it is ensured that the idle task is called often enough, that method might result in the good performance as the handler can be called continuously. However, as this method is not deterministic in case of higher CPU load by the application, it might be combined with calls in a timed task.

6.3.3.4 EEL Start-up time optimization

The duration from EEL initialization up to EEL full operation is usually a critical value for the application.

This time is largely defined by the process step to fill the RAM ID-L table for fast DS search and read (See also chapter 3.2.13.2.1, "ID-L and IDX tables"). Here the complete Data Flash is parsed DS to DS and on each found DS, the library checks if the appropriate RAM table entry is already filled. Therefore, the ROM table is searched for the correct ID from the last entry (table end) to the first entry.

If all IDs of often written Data Sets are placed to the ID-L table end and all rarely written DS IDs are placed to the ID-L Table begin, the EEL Start-up performance is significantly increased.

6.3.4 Concurrent Data Flash accesses

Depending on the user application scenario, the Data Flash might be used for different purposes, e.g. one part is reserved for direct access by the user application and one part is reserved for EEPROM emulation by the Renesas EEL. The FDL is prepared to split the Data Flash into an EEL Pool and a User Pool.

On splitted Data Flash, the EEL is the only master on the EEL pool, accesses to this pool shall be done via the EEL API only.

Access to the user pool is done by using the FDL API functions for all accesses except read (e.g. FDL_Erase, FDL_Write, ...), while Data Flash read is directly done by the CPU.

The configuration of FDL pool and EEL pool (and resulting user pool) is done in the FDL descriptor.

6.3.4.1 User Data Flash access during active EEPROM emulation

While the EEL is active, any direct Data Flash access like Data Flash Read by the CPU or execution of FLD functions are not allowed at all!

The EEL can at each time erase or write Data Flash. During these operations Data Flash is not accessible for Read operations, even not on other address ranges. Furthermore, execution of FDL operations like Flash Erase or Write would be blocked.

Following that, EEL operations and user accesses to Data Flash must be synchronized. This has to be done by the application, considering the EEL as the default master. If the user application wants to get access rights, the EEL need to be suspended beforehand. The API contains the functions EEL_Suspend and EEL_Resume for this. The following flow chart shows the correct handling.

Figure 26 EEL Suspend / Resume

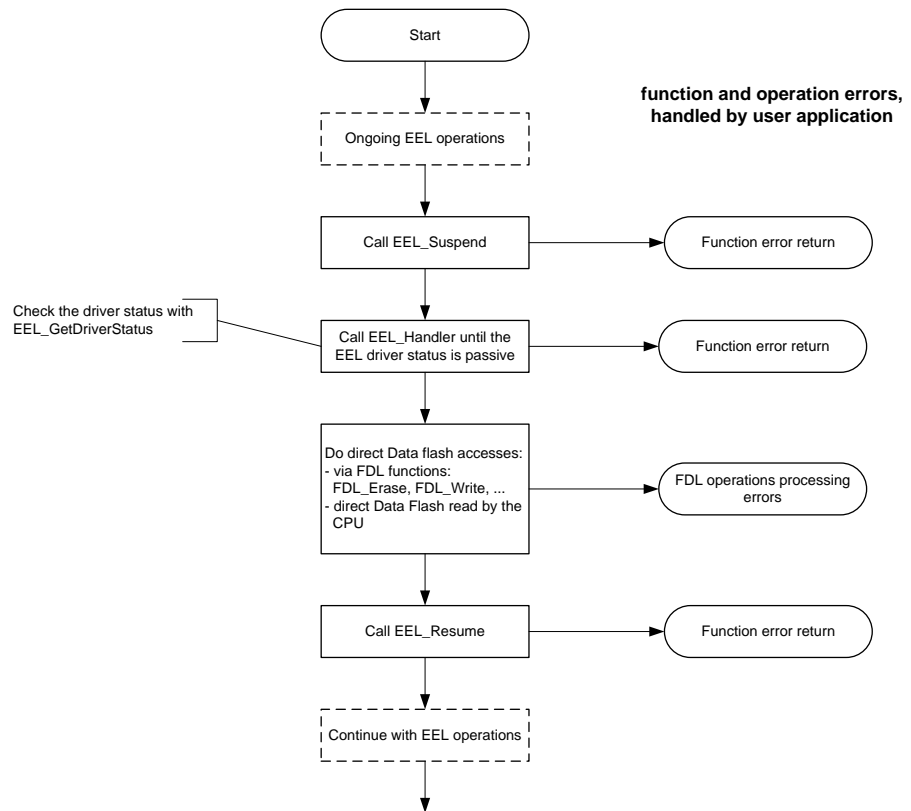

6.3.4.2 Direct access to the Data Flash by the user application by DMA

Basically, DMA transfers from Data Flash are permitted, but need to be synchronized with the EEL. Same considerations apply as mentioned in the last sub-chapter for accesses by the user application.

6.3.5 Entering power safe mode

Entering power safe modes is delayed by the device hardware until eventually ongoing Data Flash operations are finished.

In order to gain a proper synchronisation between EEL and Power safe mode entering, the library operations must be suspended before entering the mode (Please check EEL_Suspend API description).

6.3.6 Library behaviour after operation interruption

Library operation might be suddenly interrupted e.g. by a power fail. Depending on the interrupted operation (E.g. Flash erase, write) the behaviour of the library on the next start-up might differ:

- Library was idle or at the end of a operation:
Normal library start-up
- Flash block erase or Flash block header operation was interrupted:
Eventually it is necessary to fix a block status (e.g. block activation or block erase was interrupted). In this case additionally Flash write operations might take some more time and so, slightly enlarge the time until the driver leaves the state `EEL_OPERATION_STARTUP`. Furthermore, the driver will return the warning `EEL_ERR_FIX_DONE` as an indication that a fix was done. The library operation continues normally, the application does not need to react on the warning.
- DS Write was interrupted
If the DS write proceeded up to writing the DCS, the DS is valid. If the EOR has not been written, the DS will automatically be refreshed. In this case additionally Flash write operations might take some more time and so, enlarge the time until the driver leaves the state `EEL_OPERATION_STARTUP`.
- DS Write was interrupted
If the DS write did not proceed up to writing the DCS, the DS is invalid. The start-up process does no special action, but this DS instance is not considered on DS read.

6.3.7 Application update issues

6.3.7.1 Change DS length

When a user application shall be updated but the EEPROM emulation data shall be used also further on, different constraints need to be considered with respect to the ROM ID-L table.

On application update it might be required to change the DS length of some IDs. Differing from the MF2/UX4 EEELib, this is automatically done, when the ID-L table in ROM is updated. After that update all DS's are read/written with the new length and also the Refresh process copies the data with the new length:

- Old length < new length
Data is extended by any data stored after the DS (data words of the next DS → undefined)
- Old length > new length
Data is cut to new length

Note:

After DS length change, a Read operation will always return a checksum error (`EEL_ERR_WRONG_CHECKSUM`) as the checksum does not match to the DS data (see above) anymore. To fix this, the DS must be written once more by the application.

Anyhow, differing from the EEELib, the DS length is no longer stored within the DS, but in the ID-L table. When the table is updated, the information of the former DS size get lost. So, the library provides no measure to get the length of the last stored DS instance. This information must be provided otherwise.

Possible options to store the DS lengths are:

- Store the length of the DS in the DS itself
If the length is stored in the 1st Bytes, a read operation on the 1st Bytes only can be done.
- Reserve a special DS only containing all available DS IDs and the length information
A comparison with the ROM ID-L table will identify the IDs with changed length.
- Protect the DSs with a checksum
Calculating the checksum from data with a different length result in a checksum differing from the stored one (not 100% safe!).

6.3.7.2 ID-L ROM table temporarily not available

The boot loader as well as the application needs to access EEPROM emulation data with Read as well as Write. While the application requires frequent data write, the boot loader will only store a very limited amount of data, e.g. to store the application update process state.

The ROM ID-L table containing all IDs available in the emulation belongs to the application. On application update it needs to be removed together with the application. After removal of the ID-L table, normal operation of the EEPROM emulation cannot continue. In order to continue at least with limited functionality, the library provides operation modes to survive at least with limited functionality.

The mode configuration is done by the initialization function `EEL_Init`. In order to change the mode, `EEL_Init` need to be called again.

- `EEL_OPERATION_MODE_NORMAL`
Full (normal) operation of the library, requires the complete ID-L table in ROM
- `EEL_OPERATION_MODE_LIMITED`
Operation with limited ID-L-table in ROM, containing only the IDs, required by the boot loader. The DS Read and Write work on the ID-L table. The Refresh process is not possible as this would require a list of all available IDs. Following this, Data Sets can only be written until the passive Flash space of the Data Flash (prepared and invalid blocks) is consumed. Then the library must switch to read only.

As the size of data to be written by the boot loader is very limited, it is considered, that the passive space should be sufficient, even in case of frequent interruptions of the application update process.

Additionally the library provides a function to defragment the active space (activated blocks) in the Flash by Refreshing all activated blocks. By that all DS instances which are not the latest ones are removed and as much as possible passive space is provided.

The limited mode is realized by simply stopping the EEL start-up process before it could complete. The resulting access state is `EEL_ACCESS_READ_WRITE` (see chapter 5.3.3, "Driver status")

The following sub-chapters describe the different application update strategies which we consider to be reasonable. The different strategies use the different operation modes.

**Application update flow proposal -
Stop EEPROM emulation until ROM ID-L table is available**

The following flow chart explains the application update idea. Timely no EEPROM emulation is possible.

EEL_OPERATION_MODE_NORMAL is set by the EEL initialization function EEL_Init (see chapter 6.2.1, "Device start-up").

Figure 27 Application update concept with timely stopping EEPROM emulation

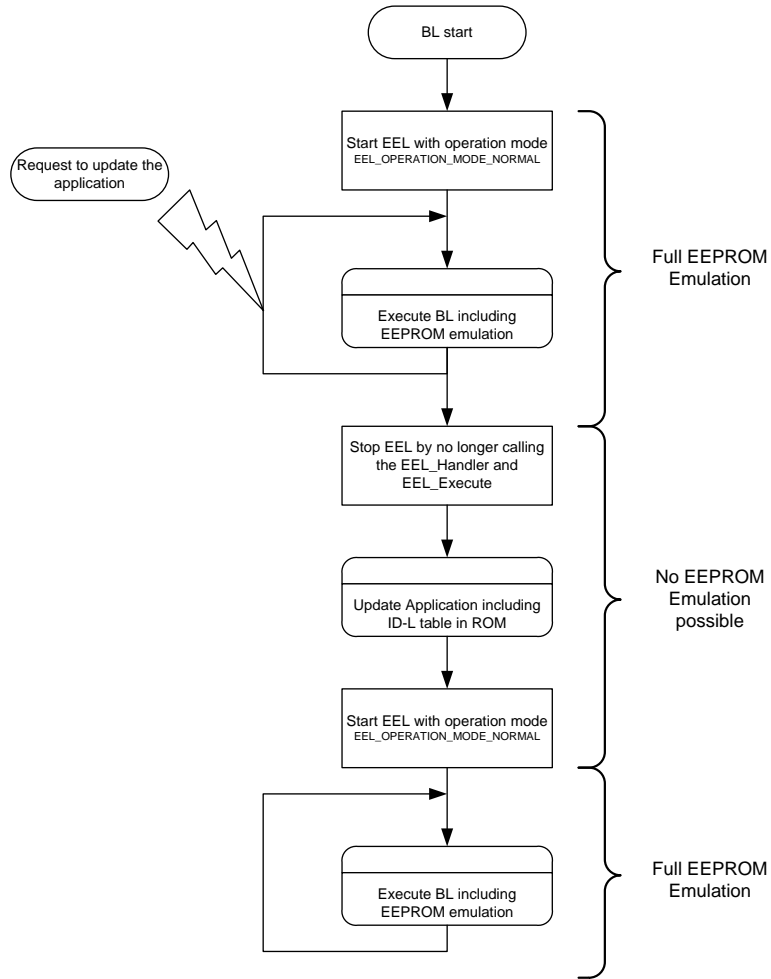

**Application update flow proposal -
Boot loader with independent ID-L table and limited Write**

The following flow chart explains the application update idea. Timely only limited EEPROM emulation is possible.

In order to overcome the situation of no Refresh during the limited emulation period, the active blocks may be defragmented/cleaned (see chapter 5.4.3.1, "EEL_Execute").

EEL_OPERATION_MODE_LIMITED is set by the EEL initialization function EEL_Init (see chapter 6.2.1, "Device start-up").

Figure 28 Application update concept with timely limited EEPROM emulation

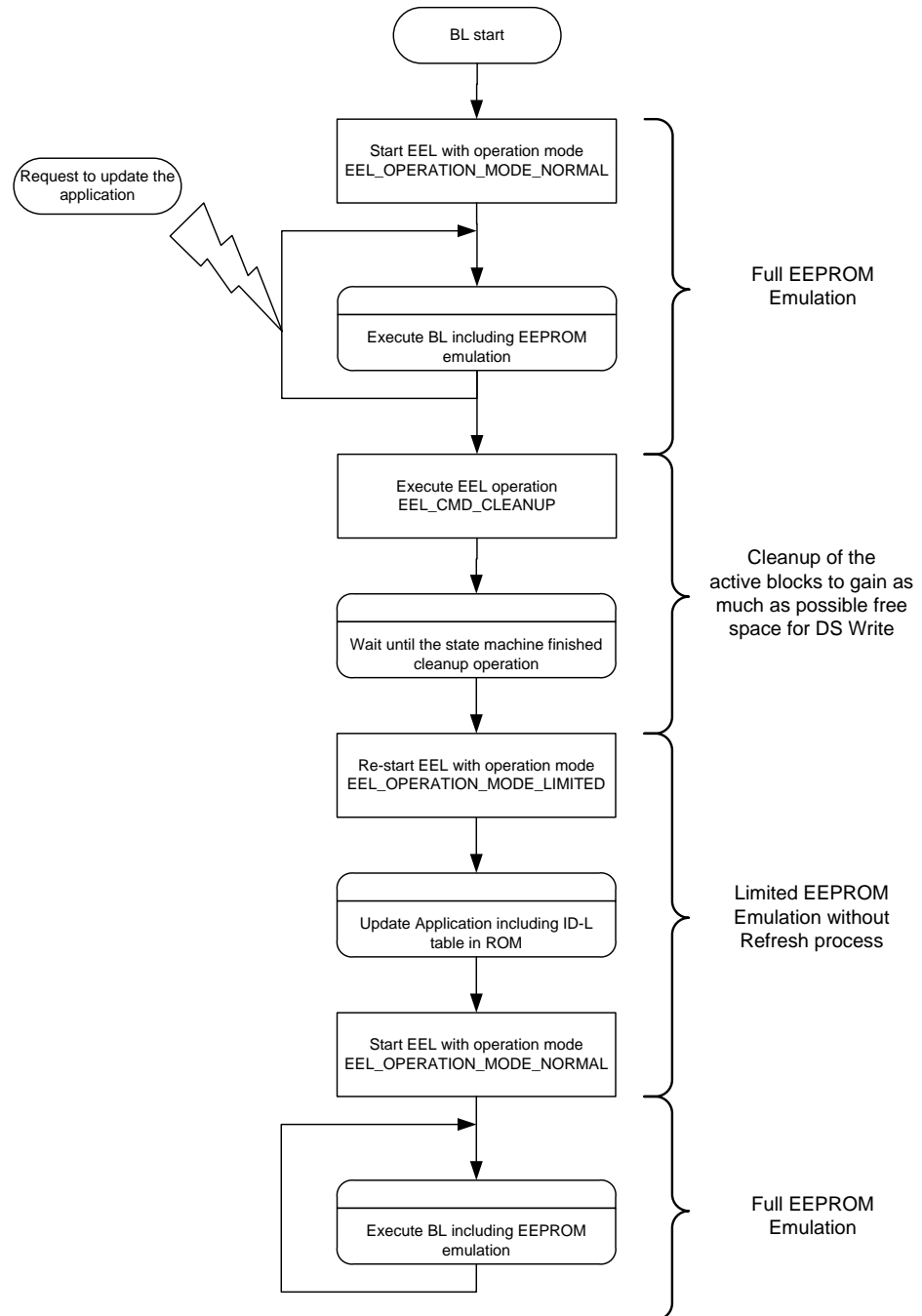

Chapter 7 Revision History

Rev.	Date	Description	
		Page	Summary
1.0	Mar 16, 2010	—	First Edition issued
1.1	May 27, 2010	41	Added new EEL and FDL sections (EEL_Const, FDL_Const)
	July 02, 2010	84	Modified and renamed chapter 6.3.4
		85	Moved chapter 6.3.3.5 to 6.3.5
		86	Added chapter 6.3.6
		86	Added description of Checksum error to chapter 6.3.7.1
		68	Added error EEL_ERR_ACCESS_LOCKED to immediate write/invalidate operation
1.2	Feb. 5, 2014	all	Minor re-formatting
			rename address_u32 -> address_pu08
			Update due to company renaming NEC -> Renesas