

CubeSuite Ver.1.40

Integrated Development Environment

User's Manual: 78K0 Debug

Target Device

78K0 Microcontroller

All information contained in these materials, including products and product specifications, represents information on the product at the time of publication and is subject to change by Renesas Electronics Corp. without notice. Please review the latest information published by Renesas Electronics Corp. through various means, including the Renesas Electronics Corp. website (<http://www.renesas.com>).

Notice

1. All information included in this document is current as of the date this document is issued. Such information, however, is subject to change without any prior notice. Before purchasing or using any Renesas Electronics products listed herein, please confirm the latest product information with a Renesas Electronics sales office. Also, please pay regular and careful attention to additional and different information to be disclosed by Renesas Electronics such as that disclosed through our website.
2. Renesas Electronics does not assume any liability for infringement of patents, copyrights, or other intellectual property rights of third parties by or arising from the use of Renesas Electronics products or technical information described in this document. No license, express, implied or otherwise, is granted hereby under any patents, copyrights or other intellectual property rights of Renesas Electronics or others.
3. You should not alter, modify, copy, or otherwise misappropriate any Renesas Electronics product, whether in whole or in part.
4. Descriptions of circuits, software and other related information in this document are provided only to illustrate the operation of semiconductor products and application examples. You are fully responsible for the incorporation of these circuits, software, and information in the design of your equipment. Renesas Electronics assumes no responsibility for any losses incurred by you or third parties arising from the use of these circuits, software, or information.
5. When exporting the products or technology described in this document, you should comply with the applicable export control laws and regulations and follow the procedures required by such laws and regulations. You should not use Renesas Electronics products or the technology described in this document for any purpose relating to military applications or use by the military, including but not limited to the development of weapons of mass destruction. Renesas Electronics products and technology may not be used for or incorporated into any products or systems whose manufacture, use, or sale is prohibited under any applicable domestic or foreign laws or regulations.
6. Renesas Electronics has used reasonable care in preparing the information included in this document, but Renesas Electronics does not warrant that such information is error free. Renesas Electronics assumes no liability whatsoever for any damages incurred by you resulting from errors in or omissions from the information included herein.
7. Renesas Electronics products are classified according to the following three quality grades: “Standard”, “High Quality”, and “Specific”. The recommended applications for each Renesas Electronics product depends on the product’s quality grade, as indicated below. You must check the quality grade of each Renesas Electronics product before using it in a particular application. You may not use any Renesas Electronics product for any application categorized as “Specific” without the prior written consent of Renesas Electronics. Further, you may not use any Renesas Electronics product for any application for which it is not intended without the prior written consent of Renesas Electronics. Renesas Electronics shall not be in any way liable for any damages or losses incurred by you or third parties arising from the use of any Renesas Electronics product for an application categorized as “Specific” or for which the product is not intended where you have failed to obtain the prior written consent of Renesas Electronics. The quality grade of each Renesas Electronics product is “Standard” unless otherwise expressly specified in a Renesas Electronics data sheets or data books, etc.
 - “Standard”: Computers; office equipment; communications equipment; test and measurement equipment; audio and visual equipment; home electronic appliances; machine tools; personal electronic equipment; and industrial robots.
 - “High Quality”: Transportation equipment (automobiles, trains, ships, etc.); traffic control systems; anti-disaster systems; anti-crime systems; safety equipment; and medical equipment not specifically designed for life support.
 - “Specific”: Aircraft; aerospace equipment; submersible repeaters; nuclear reactor control systems; medical equipment or systems for life support (e.g. artificial life support devices or systems), surgical implantations, or healthcare intervention (e.g. excision, etc.), and any other applications or purposes that pose a direct threat to human life.
8. You should use the Renesas Electronics products described in this document within the range specified by Renesas Electronics, especially with respect to the maximum rating, operating supply voltage range, movement power voltage range, heat radiation characteristics, installation and other product characteristics. Renesas Electronics shall have no liability for malfunctions or damages arising out of the use of Renesas Electronics products beyond such specified ranges.
9. Although Renesas Electronics endeavors to improve the quality and reliability of its products, semiconductor products have specific characteristics such as the occurrence of failure at a certain rate and malfunctions under certain use conditions. Further, Renesas Electronics products are not subject to radiation resistance design. Please be sure to implement safety measures to guard them against the possibility of physical injury, and injury or damage caused by fire in the event of the failure of a Renesas Electronics product, such as safety design for hardware and software including but not limited to redundancy, fire control and malfunction prevention, appropriate treatment for aging degradation or any other appropriate measures. Because the evaluation of microcomputer software alone is very difficult, please evaluate the safety of the final products or system manufactured by you.
10. Please contact a Renesas Electronics sales office for details as to environmental matters such as the environmental compatibility of each Renesas Electronics product. Please use Renesas Electronics products in compliance with all applicable laws and regulations that regulate the inclusion or use of controlled substances, including without limitation, the EU RoHS Directive. Renesas Electronics assumes no liability for damages or losses occurring as a result of your noncompliance with applicable laws and regulations.
11. This document may not be reproduced or duplicated, in any form, in whole or in part, without prior written consent of Renesas Electronics.
12. Please contact a Renesas Electronics sales office if you have any questions regarding the information contained in this document or Renesas Electronics products, or if you have any other inquiries.

(Note 1) “Renesas Electronics” as used in this document means Renesas Electronics Corporation and also includes its majority-owned subsidiaries.

(Note 2) “Renesas Electronics product(s)” means any product developed or manufactured by or for Renesas Electronics.

How to Use This Manual

This manual describes the role of the CubeSuite integrated development environment for developing applications and systems for 78K0 microcontrollers, and provides an outline of its features.

CubeSuite is an integrated development environment (IDE) for 78K0 microcontrollers, integrating the necessary tools for the development phase of software (e.g. design, implementation, and debugging) into a single platform.

By providing an integrated environment, it is possible to perform all development using just this product, without the need to use many different tools separately.

Readers This manual is intended for users who wish to understand the functions of the CubeSuite and design software and hardware application systems.

Purpose This manual is intended to give users an understanding of the functions of the Cubesuite to use for reference in developing the hardware or software of systems using these devices.

Organization This manual can be broadly divided into the following units.

CHAPTER 1 GENERAL

CHAPTER 2 FUNCTIONS

APPENDIX A WINDOW REFERENCE

APPENDIX B USER OPEN INTERFACE

APPENDIX C INDEX

How to Read This Manual It is assumed that the readers of this manual have general knowledge of electricity, logic circuits, and microcontrollers.

Conventions

Data significance:	Higher digits on the left and lower digits on the right
Active low representation:	\overline{XXX} (overscore over pin or signal name)
Note:	Footnote for item marked with Note in the text
Caution:	Information requiring particular attention
Remark:	Supplementary information
Numeric representation:	Decimal ... XXXX Hexadecimal ... 0xXXXX

Related Documents

The related documents indicated in this publication may include preliminary versions. However, preliminary versions are not marked as such.

Document Name		Document No.
CubeSuite	Start	R20UT0256E
Integrated Development Environment	Analysis	R20UT0265E
User's Manual	Programming	R20UT0266E
	Message	R20UT0267E
	Coding for CX compiler	R20UT0259E
	Build for CX compiler	R20UT0261E
	78K0 Coding	R20UT0004E
	78K0 Build	R20UT0005E
	78K0 Debug	This manual
	78K0 Design	R20UT0006E
	78K0R Coding	U19382E
	78K0R Build	U19385E
	78K0R Debug	R20UT0263E
	78K0R Design	R20UT0007E
	V850 Coding	U19383E
	V850 Build	U19386E
	V850 Debug	R20UT0264E
	V850 Design	R20UT0257E

Caution The related documents listed above are subject to change without notice. Be sure to use the latest edition of each document when designing.

All trademarks or registered trademarks in this document are the property of their respective owners.

[MEMO]

[MEMO]

[MEMO]

TABLE OF CONTENTS

CHAPTER 1 GENERAL ... 11

- 1.1 Summary ... 11
- 1.2 Features ... 11

CHAPTER 2 FUNCTIONS ... 12

- 2.1 Overview ... 12
- 2.2 Preparation before Debugging ... 15
 - 2.2.1 Confirm the connection to a host machine ... 15
- 2.3 Configuration of Operating Environment of the Debug Tool ... 17
 - 2.3.1 Select the debug tool to use ... 17
 - 2.3.2 [IECUBE] ... 18
 - 2.3.3 [MINICUBE2] ... 27
 - 2.3.4 [Simulator] ... 34
- 2.4 Connect to/Disconnect from the Debug Tool ... 40
 - 2.4.1 Connect the debug tool to CubeSuite ... 40
 - 2.4.2 Disconnect the debug tool from CubeSuite ... 40
- 2.5 Download/Upload Programs ... 41
 - 2.5.1 Execute downloading ... 41
 - 2.5.2 Advanced downloading ... 43
 - 2.5.3 Execute uploading ... 47
- 2.6 Display/Change Programs ... 49
 - 2.6.1 Display source files ... 49
 - 2.6.2 Display the result of disassembling ... 53
 - 2.6.3 Run a build in parallel with other operations ... 57
 - 2.6.4 Perform line assembly ... 57
- 2.7 Execute Programs ... 59
 - 2.7.1 Reset microcontroller (CPU) ... 59
 - 2.7.2 Execute programs ... 59
 - 2.7.3 Execute programs in steps ... 61
- 2.8 Stop Programs (Break) ... 63
 - 2.8.1 Stop the program manually ... 63
 - 2.8.2 Stop the program at the arbitrary position (breakpoint) ... 63
 - 2.8.3 Stop the program with the access to variables/SFRs ... 65
 - 2.8.4 Stop the program when an invalid execution is detected [IECUBE] ... 68
 - 2.8.5 Other break causes ... 70
- 2.9 Display/Change the Memory, Register and Variable ... 71
 - 2.9.1 Display/change the memory ... 71
 - 2.9.2 Display/change the CPU register ... 79
 - 2.9.3 Display/change the SFR ... 81
 - 2.9.4 Display/change global variables/static variables ... 83
 - 2.9.5 Display/change local variables ... 83

2.9.6	Display/change watch-expressions ...	85
2.10	Display Information on Function Call from Stack ...	91
2.10.1	Display call stack information ...	91
2.11	Collect Execution History of Programs [IECUBE][Simulator] ...	93
2.11.1	Configure the trace operation ...	93
2.11.2	Collect execution history until stop of the execution ...	95
2.11.3	Collect execution history in the arbitrary section ...	95
2.11.4	Collect execution history when the condition is met ...	97
2.11.5	Display the collected execution history ...	98
2.11.6	Clear the trace memory ...	100
2.11.7	Search the trace data ...	100
2.11.8	Save the contents of execution history ...	105
2.12	Measure Execution Time of Programs ...	107
2.12.1	Measure execution time until stop of the execution ...	107
2.12.2	Measure execution time in the arbitrary section [IECUBE][Simulator] ...	108
2.12.3	Measurable time ranges ...	110
2.13	Measure Coverage [IECUBE][Simulator] ...	111
2.13.1	Configure the coverage measurement ...	111
2.13.2	Display the coverage measurement result ...	112
2.14	Set an Action into Programs ...	114
2.14.1	Inset printf ...	114
2.15	Manage Events ...	116
2.15.1	Change the state of set events (valid/invalid) ...	116
2.15.2	Display only particular event types ...	117
2.15.3	Jump to the event address ...	117
2.15.4	Delete events ...	117
2.15.5	Write comment to events ...	118
2.15.6	Notes for setting events ...	118
2.16	Use Hook Function ...	120
2.17	Use the Simulator GUI [Simulator] ...	122
2.17.1	Check the I/O waveform of the microcontroller ...	123
2.17.2	Input signals to the pins ...	123
2.17.3	Perform serial communication ...	124
2.17.4	Use buttons, LEDs, level gauges, and other components ...	124
2.18	About Input Value ...	125
2.18.1	Input rule ...	125
2.18.2	Icons for invalid input ...	127

APPENDIX A WINDOW REFERENCE ... 128

A.1	Description ...	128
-----	-----------------	-----

APPENDIX B USER OPEN INTERFACE ... 375

B.1	Overview ...	375
B.1.1	Types of interface functions ...	376
B.1.2	Interface methods ...	376
B.1.3	Development environment ...	377

B.2	Creating User Model ...	378
B.2.1	Program configuration ...	378
B.2.2	Outline of programming ...	379
B.2.3	Example of program file (UserModel.c) ...	381
B.2.4	Compilation and linking ...	382
B.3	Embedding User Model ...	383
B.3.1	Description in simulator configuration file ...	383
B.3.2	Example of simulator configuration file ...	385
B.4	Supplied Interface Functions ...	387
B.4.1	Overview ...	387
B.4.2	Basic interface functions ...	389
B.4.3	Time interface functions ...	393
B.4.4	Pin interface functions ...	400
B.4.5	External bus interface functions ...	409
B.4.6	Serial interface functions ...	416
B.4.7	Signal output unit interface functions ...	435
B.4.8	Error numbers ...	441
B.5	User-Defined Functions ...	442
B.6	Sample Program (Timer Model) ...	456
B.6.1	Overview ...	456
B.6.2	Configuration ...	456
B.6.3	Operation ...	456
B.6.4	Project file ...	456
B.6.5	Details of program ...	457

APPENDIX C	INDEX ...	461
-------------------	------------------	------------

CHAPTER 1 GENERAL

CubeSuite is a platform of an integrated developing environment for the 78K0 microcontroller, 78K0R microcontroller and V850 microcontroller.

CubeSuite can run all the operations needed for developing the programs such as designing, coding, building, debugging, and flash programming.

In this manual, the debugging is explained out of those operations needed for the program development.

In this chapter, an overview of debugging products that CubeSuite provides is explained.

1.1 Summary

You can effectively debug/simulate the program developed for the 78K0 microcontroller, using the debugger which Cube Suite provides.

1.2 Features

The following are the features of the debugger provided by CubeSuite.

- Connecting to the various debug tools

A pleasant debugging environment for target systems is provided by connecting to the debug tool (IECUBE, MINICUBE2, and Simulator).

- C source text and disassembled text are shown mixed

The C source text and the disassembled text are shown mixed on the same panel.

- Source level debugging and instruction level debugging

The source level debugging and the instruction level debugging for a C source program can be done.

- Real-time display update function

Display information is automatically updated not only when the program execution is stopped, but also in execution.

- Save/restore the debugging environment

The debugging environment such as breakpoints, event configuration information, file download information, display condition/position of the panel, etc. can be saved.

CHAPTER 2 FUNCTIONS

This chapter describes a debugging process of CubeSuite and main functions for debugging.

2.1 Overview

The basic debugging sequence for programs using CubeSuite is as follows:

(1) Start CubeSuite

Launch CubeSuite from the [Start] menu of Windows®.

Remark For details on "Start CubeSuite", see "CubeSuite Start".

(2) Set a project

Create a new project, or load an existing one.

Remark For details on "Set a project", see "CubeSuite Start".

(3) Create a load module

Create a load module by running a build after setting of the active project and the build tool to be used.

Remark For details on "Create a load module" with CA78K0, see "CubeSuite Build".

(4) Confirm the connection to a host machine

Connect the debug tool (IECUBE, MINICUBE2, or Simulator) to be used to a host machine.

(5) Select the debug tool to use

Select the debug tool to use in a project.

(6) Configure operating environment of the debug tool

Configure the operating environment of the debug tool selected in steps (5).

- [IECUBE]
- [MINICUBE2]
- [Simulator]

(7) Connect the debug tool to CubeSuite

Connect the debug tool to CubeSuite to start communication.

(8) Execute downloading

Download the load module created in steps (3) to the debug tool.

(9) Display source files

Display the contents of the downloaded load module (source files) on the [Editor panel](#) or [Disassemble panel](#).

(10) Execute programs

Execute the program by using the operation method corresponding to a purpose.

If you wish to stop the program at the arbitrary position, set a breakpoint/break event^{Note} before executing the program (see "2.8.2 Stop the program at the arbitrary position (breakpoint)"/"2.8.3 Stop the program with the access to variables/SFRs").

Note These functions are implemented by setting events to the debug tool used.
See "2.15.6 Notes for setting events", when you use events.

(11) Stop the program manually

Stop the program currently being executed.

Note that if a breakpoint/break event has been set in steps (10), the program execution will be stopped automatically when the condition of the breakpoint/break event is met.

(12) Check the result of the program execution

Check the following information that the debug tool acquired by the program execution.

- Display/Change the Memory, Register and Variable
- Display Information on Function Call from Stack
- Collect Execution History of Programs [IECUBE][Simulator]^{Note}
- Measure Execution Time of Programs^{Note}
- Measure Coverage [IECUBE][Simulator]

Note These functions are implemented by setting events to the debug tool used.
See "2.15.6 Notes for setting events", when you use events.

Debug the program, repeating steps (9) to (12) as required.

Note that if the program is modified during debugging, steps (3) and (8) also should be repeated.

Remarks 1. Other than the above, you can also check the result of the program execution by using the following functions.

- Set an Action into Programs
 - Use Hook Function
 - Use the Simulator GUI [Simulator]
2. The acquired information can be saved to a file.
- Save the disassembled text contents
 - Save the memory contents
 - Save the CPU register contents
 - Save the SFR contents
 - Save the contents of local variables
 - Save the contents of watch-expressions
 - Save the contents of call stack information
 - Save the contents of execution history

(13) Execute uploading

Save the program (the memory contents) to a file in the arbitrary format (e.g. Intel hex format, binary data format, and etc.), as required.

(14) Disconnect the debug tool from CubeSuite

Disconnect the debug tool from CubeSuite to terminate communication.

(15) Save the project file

Save the setting information of the project to the project file.

Remark For details on "Save the project file", see "CubeSuite Start".

2.2 Preparation before Debugging

This section describes the preparation to start debugging the created program.

2.2.1 Confirm the connection to a host machine

Connection examples for each debug tool are shown.

- (1) [IECUBE]
- (2) [MINICUBE2]
- (3) [Simulator]

(1) [IECUBE]

Connect a host machine and IECUBE. If required, connect a target board, too. See IECUBE User's Manual for details on the connection method.

Figure 2-1. Connection Example [IECUBE]

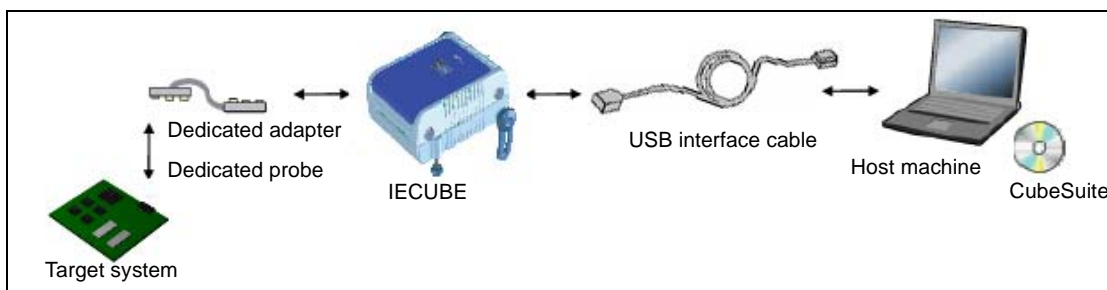

(2) [MINICUBE2]

Connect a host machine and MINICUBE2. If required, connect a target board, too. See MINICUBE2 User's Manual for details on the connection method.

Figure 2-2. Connection Example [MINICUBE2]

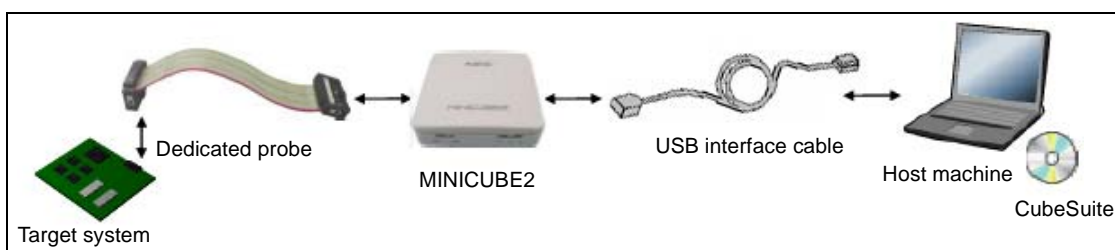

(3) [Simulator]

A host machine is only needed for debugging (emulators are not needed).

Figure 2-3. Connection Example [Simulator]

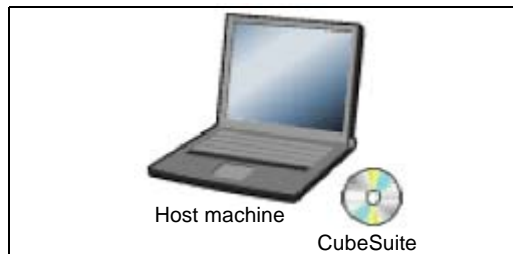

2.3 Configuration of Operating Environment of the Debug Tool

This section describes the configuration of the operating environment for each debug tool.

2.3.1 Select the debug tool to use

You can configure the operating environment in the [Property panel](#) corresponding to the debug tool to use.

Therefore, first, select the debug tool to be used in a project (the debug tool to be used can be specified in the individual projects).

To select or switch the debug tool, use the context menu shown by right clicking on the [78K0 *Debug tool name* (Debug Tool)] node on the [Project Tree panel](#).

Figure 2-4. Select/Switch Debug Tool to Use

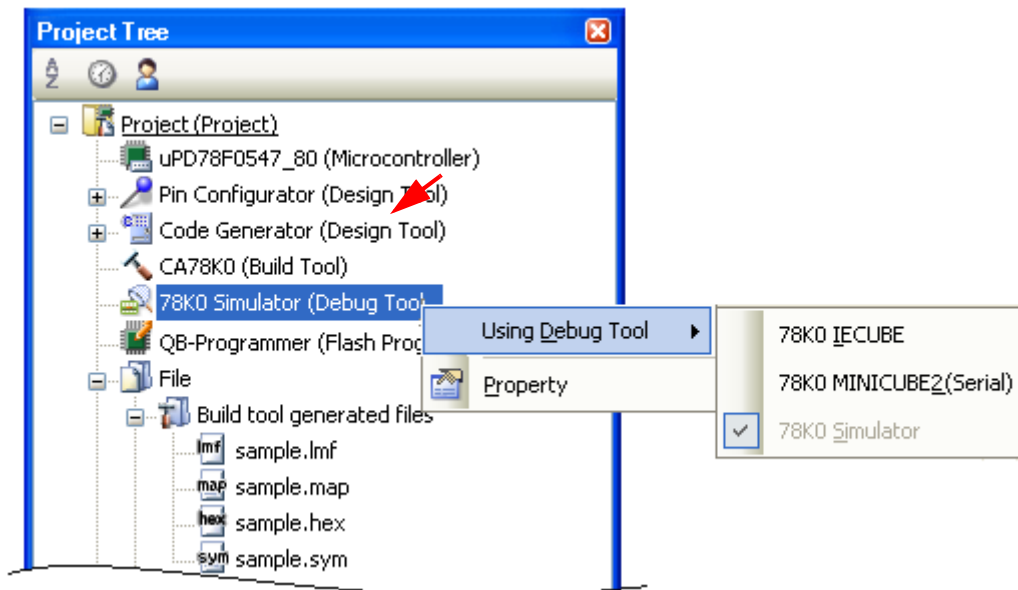

If the [Property panel](#) is already open, click the [78K0 *Debug tool name* (Debug Tool)] node again. The view switches to the Property panel of the selected debug tool.

If the Property panel is not open, double-click the above mentioned node to open the corresponding Property panel.

2.3.2 [IECUBE]

Configure the operating environment on the [Property panel](#) below when using IECUBE.

Figure 2-5. Property Panel [IECUBE]

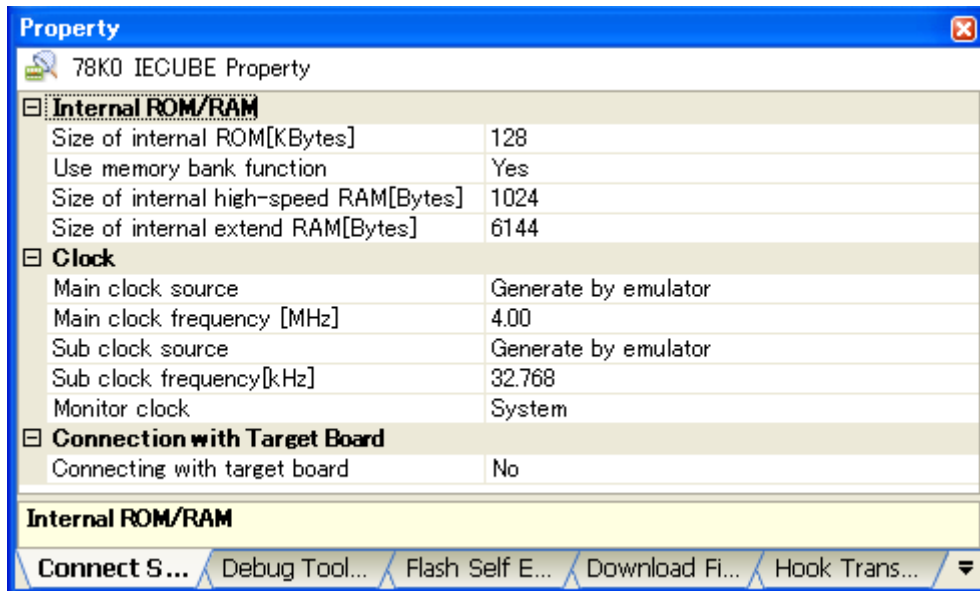

Follow the steps below by selecting the corresponding tab on the [Property panel](#).

- (1) [\[Connect Settings\] tab](#)
- (2) [\[Debug Tool Settings\] tab](#)
- (3) [\[Flash Self Emulation Settings\] tab](#)
- (4) [\[Download File Settings\] tab](#)
- (5) [\[Hook Transaction Settings\] tab](#)

(1) [Connect Settings] tab

In the [\[Connect Settings\] tab](#), configuration with regard to the connection to the debug tool can be done.

- (a) [\[Internal ROM/RAM\]](#)
- (b) [\[Clock\]](#)
- (c) [\[Connection with Target Board\]](#)

(a) [Internal ROM/RAM]

You can configure internal ROM/RAM in this category.

The size of internal ROM/internal high-speed RAM/internal extend RAM of the selected microcontroller is specified by default.

Remark There is no need to change the settings in this category if you wish to debug with the same memory mapping of the selected microcontroller.

Figure 2-6. [Internal ROM/RAM] Category [IECUBE]

Internal ROM/RAM	
Size of internal ROM[KBytes]	128
Use memory bank function	Yes
Size of internal high-speed RAM[Bytes]	1024
Size of internal extend RAM[Bytes]	6144

<1> [Size of internal ROM[KBytes]]

Specify the internal ROM size to emulate (unit: Kbytes).

To perform debugging using IECUBE memory resources after changing the memory mapping, make a selection from the drop-down list.

Note that specifying the [Use memory bank function] property at the bottom will change the numbers displayed in the drop-down list (if the memory bank function is used, it will display the values with the internal bank's ROM size added).

<2> [Use memory bank function]

This property appears only when the selected microcontroller provides the memory bank function.

Specify from the drop-down list whether to use the memory bank function.

Select [Yes] to the memory bank function (default).

Caution This property cannot be changed while connecting to IECUBE.

<3> [Size of internal high-speed RAM[Bytes]]

Specify the internal high-speed RAM size to emulate (unit: bytes).

To perform debugging using IECUBE memory resources after changing the memory mapping, make a selection from the drop-down list.

<4> [Size of internal extend RAM[Bytes]]

Specify the internal extend RAM size to emulate (unit: bytes).

To perform debugging using IECUBE memory resources after changing the memory mapping, make a selection from the drop-down list.

Caution You should be careful not to overlap the area with other memory mapping area.

(b) [Clock]

You can configure the clock in this category.

Figure 2-7. [Clock] Category [IECUBE]

Clock	
Main clock source	Generate by emulator
Main clock frequency [MHz]	4.00
Sub clock source	Generate by emulator
Sub clock frequency[kHz]	32.768
Monitor clock	System

<1> [Main clock source]

Specify the main clock source to input to the CPU from the following drop-down list.

Clock board	Uses a clock of the transmitter on the clock board. Note that if there is no transmitter on the clock board, this item is not appeared.
External	Uses a main clock (square wave) of the target system. Note that if the target power supply cannot be detected, this item does not appear.
Generate by emulator	Uses a clock generated inside IECUBE (default).

Caution This property cannot be changed while connecting to IECUBE.

<2> **[Main clock frequency[MHz]]**

This property appears only when the [Main clock source] property is set to [Generate by emulator].

Specify the main clock frequency from the drop-down list.

The drop-down list displays the following frequencies (unit: MHz).

1.00, 2.00, 3.00, 3.57, 4.00 (default), 4.19, 4.91, 5.00, 6.00, 8.00, 8.38, 10.00, 12.00, 16.00, 20.00

<3> **[Sub clock source]**

Specify the sub clock source to input to the CPU and peripheral devices from the following drop-down list.

Clock board	Uses a clock of the transmitter on the clock board.
External	Uses a main clock (square wave) of the target system.
Generate by emulator	Uses a clock generated inside IECUBE (default).

Caution This property cannot be changed while connecting to IECUBE.

<4> **[Sub clock frequency[kHz]]**

This property appears only when the [Sub clock source] property is set to [Generate by emulator].

Specify the sub clock frequency from the drop-down list.

The drop-down list displays the following frequencies (unit: kHz).

32.768 (default), 38.40

<5> **[Monitor clock]**

Specify from the following drop-down list a clock on which the monitor program operates while the program is stopped.

System	Operates with main clock (default).
User	Operates with the clock that the program specified.

(c) **[Connection with Target Board]**

You can configure the connection to the target board in this category.

Figure 2-8. [Connection with Target Board] Category

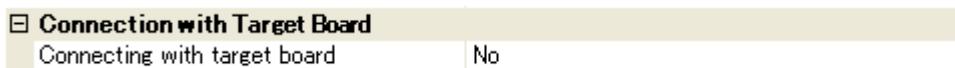

<1> [Connecting with target board]

Specify if the target board is connected to IECUBE or not from the drop-down list.
 Select [Yes] when the target board is connected to IECUBE ([No] is selected by default).

Caution This property cannot be changed while connecting to IECUBE.

(2) [Debug Tool Settings] tab

In the [Debug Tool Settings] tab, general configurations on the debug tool can be done.

- (a) [Memory]
- (b) [Access Memory While Running]
- (c) [Set Event While Running]
- (d) [Break]
- (e) [Fail-safe Break]
- (f) [Trace]
- (g) [Coverage]
- (h) [Mask for Input Signal]

(a) [Memory]

You can configure the memory in this category.

Figure 2-9. [Memory] Category [IECUBE]

[-] Memory	
[-] Memory mappings	[5]
[+] [0]	Internal ROM area
[+] [1]	Non-map area
[+] [2]	Internal high-speed RAM area
[+] [3]	Register area
[+] [4]	SFR area
Verify on writing to memory	Yes

<1> [Memory mappings]

Current memory mapping status is displayed for each type of memory area.

The memory mapping status cannot be changed on this panel. If it is necessary to add a memory mapping, click on the [Memory Mapping] property, and click on the [...] button that appears on the right end of the setting field. The Memory Mapping dialog box opens; perform the setting from there. See the section for the Memory Mapping dialog box for details on how to configure the parameters.

Figure 2-10. Opening the Memory Mapping Dialog Box

[-] Memory	
[-] Memory mappings	[5] ...
[+] [0]	Internal ROM area
[+] [1]	Non-map area

Caution If you are not connected to a debug tool, then only memory mapping areas added by user is displayed.

Connecting to a debug tool (see "2.4.1 Connect the debug tool to CubeSuite") will display details for each memory type.

<2> [Verify on writing to memory]

Specify whether to perform a verify check when data has been written to memory from the drop-down list.

Select [Yes] to perform verification (default).

Remark The verification is performed at when the download is performed, or when the values that have been modified on the [Watch panel/Memory panel](#) are written to the memory.

(b) [Access Memory While Running]

You can configure the memory access in this category.

The settings of this category are required when using the real-time display update function.

See "(4) [Display/modify the memory contents during program execution](#)" for details on the real-time display update function.

Figure 2-11. [Access Memory While Running] Category [IECUBE]

<input type="checkbox"/> Access Memory While Running	
Access by stopping execution	No
Update display during the execution	Yes
Display update interval[ms]	500

<1> [Access by stopping execution]

Specify whether to allow access to the memory area where cannot be accessed while executing a program (target memory area/SFR area) from the drop-down list.

Select [Yes] to allow access ([No] is selected by default).

<2> [Update display during the execution]

Specify whether to update the display in the [Watch panel/Memory panel](#) during a program execution (the real-time display update function).

Select [Yes] to update the display (default).

<3> [Display update interval[ms]]

This property appears only when the [\[Update display during the execution\]](#) property is set to [Yes].

Specify the interval in 100 ms unit to update the contents in the [Watch panel/Memory panel](#) display while executing a program.

Directly specify the Integer number between 100 and 65500 (rounding up the fractions less than 100ms) ([500] is selected by default).

(c) [Set Event While Running]

You can configure the setting of events during execution in this category.

Figure 2-12. [Set Event While Running] Category [IECUBE]

<input type="checkbox"/> Set Event While Running	
Set event by stopping execution momentarily	No

<1> [Set event by stopping execution momentarily]

Specify whether to forcibly pause the execution for events that cannot be set while executing the program.

For details on the event types that are affected by this property, see "Table 2-18. Event Types That Can be Set and Deleted during Execution".

Select [Yes] to set events above while execution ([No] is selected by default).

(d) [Break]

You can configure the break function in this category.

Figure 2-13. [Break] Category [IECUBE]

Break	
First using type of breakpoint	Software break
Stop emulation of peripherals when stopping	No

<1> [First using type of breakpoint]

Specify from the following drop-down list a breakpoint type to use with priority when setting it with a one click operation of the mouse in the [Editor panel/Disassemble panel](#).

See "2.8.2 Stop the program at the arbitrary position (breakpoint)" for details on breakpoints.

Software break	Sets software breakpoint with priority (default).
Hardware break	Sets hardware breakpoint with priority.

<2> [Stop emulation of peripherals when stopping]

Specify from the drop-down list whether the peripheral emulation function of emulator is stopped while stopping the program execution.

Setting	78K0/Fx2, 78K0/Lx2, 78K0/Lx, 78K0/3Kx2	78K0/Kx1+
[Yes]	While stopping the program execution, operations of the peripheral function are stopped except for the following. - TMH1 (however, only when f _{RL} source clock is selected as the count clock)	While stopping the program execution, all operations of the peripheral function are stopped.
[No] (default)	While stopping the program execution, operations of the peripheral function are maintained except for the following. - TMH1 (however, only when f _{RL} /2 ⁷ or f _{RL} /2 ⁹ is selected as the count clock) - Watchdog timer	While stopping the program execution, operations of the peripheral function are maintained except for the following. - TMH (however, only when Ring-OSC is selected) - Watchdog timer

(e) [Fail-safe Break]

You can configure the fail-safe break function in this category.

See "2.8.4 Stop the program when an invalid execution is detected [IECUBE]" for details on the fail-safe break function and this category configuration.

(f) [Trace]

You can configure the trace function in this category.

See "2.11 Collect Execution History of Programs [IECUBE][Simulator]" for details on the trace function and this category configuration.

(g) [Coverage]

You can configure the coverage function in this category.

See "[2.13 Measure Coverage \[IECUBE\]\[Simulator\]](#)" for details on the coverage function and this category configuration.

(h) [Mask for Input Signal]

You can configure the input signal masking in this category.

Figure 2-14. [Mask for Input Signal] Category [IECUBE]

Mask for Input Signal	
Mask WAIT signal	No
Mask TARGET RESET signal	No
Mask INTERNAL RESET signal	No
Mask NMI signal	No

With the properties shown below, select [Yes] to mask the signal from the drop-down list (all properties below are set to [No] by default).

- [Mask WAIT signal]^{Note}
- [Mask TARGET RESET signal]^{Note}
- [Mask INTERNAL RESET signal]
- [Mask NMI signal]

Note When [No] is specified with the [\[Connection with Target Board\]](#) property in the [Connect Setting] tab, these properties are fixed to [Yes] after connecting to the debug tool (changes not allowed).

(3) [Flash Self Emulation Settings] tab

In the [\[Flash Self Emulation Settings\] tab \[IECUBE\]](#) tab, general configurations on flash self programming emulation can be done.

- (a) [\[Flash Self Emulation\]](#)
- (b) [\[Macro Service Error\]](#)
- (c) [\[Security Flag Emulation\]](#)

(a) [Flash Self Emulation]

You can configure the flash self programming emulation function in this category.

Figure 2-15. [Flash Self Emulation] Category

Flash Self Emulation	
Flash self-programming	No

<1> [Flash self-programming]

Specify whether to use the flash self programming emulation function from the drop-down list.
Select [Yes] to use the flash self programming emulation function ([No] is selected by default).

(b) [Macro Service Error]

You can configure the operation of flash functions of the self programming library for the flash macro service in this category.

For details on the flash functions, see "78K0 Microcontrollers Self Programming Library Type0x".

Figure 2-16. [Macro Service Error] Category

Macro Service Error	
FlashBlockErase error	0x00 (None)
FlashBlockIVerify error	0x00 (None)
FlashWordWrite error	0x00 (None)
FlashBlockBlankCheck error	0x00 (None)
FlashSetInfo error	0x00 (None)
FlashEnv error	0x00 (None)
FlashGetInfo error	0x00 (None)
EEPROM Write error	0x00 (None)
EEPROM Erase error	0x00 (None)
FLMD0 error	High

The properties shown below specify the error value to return from the function in question.

By default, all are set to [0x00 (None)]. If a setting must be changed, select the number to display from the drop-down list, or enter a number between 0x00 and 0xFF directly using hexadecimal notation.

Note that the numbers in the drop-down list will differ depending on which microcontroller is selected.

- [FlashBlockErase error]
- [FlashBlockVerify error]
- [FlashWordWrite error]
- [FlashBlockBlankCheck error]
- [FlashSetInfo error]
- [FlashEnv error]^{Note 1}
- [FlashGetInfo error]
- [EEPROM Write error]
- [EEPROM Erase error]^{Note 1}
- [FLMD0 error]^{Note 2}

Notes 1. If the selected microcontroller is in the MF2 series (Kx2+), then it appears only while disconnecting from the debug tool.

2. If the selected microcontroller is in the CZ6 series (Kx1+) or MF2 series (Kx2+), then it is only displayed if the target board is not connected to IECUBE.

(c) [Security Flag Emulation]

You can configure the function on the security flag emulation in this category.

The initial value of the security flag is emulated when the security has been set to the flash memory.

Figure 2-17. [Security Flag Emulation] Category

Security Flag Emulation	
Disable chip erase	No
Disable block erase	No
Disable program	No
Disable boot block cluster reprogram	No

<1> [Disable chip erase]

Specify whether to emulate to disable chip erase from the drop-down list.

Select [Yes] to emulate to disable chip erase ([No] is selected by default).

<2> [Disable block erase]

Specify whether to emulate to disable block erase from the drop-down list.
Select [Yes] to emulate to disable block erase ([No] is selected by default).

<3> [Disable program]

Specify whether to emulate to disable writing from the drop-down list.
Select [Yes] to emulate to disable writing ([No] is selected by default).

<4> [Disable boot block cluster reprogram]

If the selected microcontroller is in the CZ6 series (Kx1+), then this property appears only while disconnecting from the debug tool.

Specify whether to emulate to disable rewrite boot area from the drop-down list.
Select [Yes] to emulate to disable rewrite boot area ([No] is selected by default).

(4) [Download File Settings] tab

In the [\[Download File Settings\] tab](#), configuration on downloading file to the debug tool can be done.
See "[2.5.1 Execute downloading](#)" for details on each category configuration.

(5) [Hook Transaction Settings] tab

In the [\[Hook Transaction Settings\] tab](#), configuration on the hook transaction can be done.
See "[2.16 Use Hook Function](#)" for details on each category configuration and the function of the hook transaction.

2.3.3 [MINICUBE2]

Configure the operating environment on the [Property panel](#) below when using MINICUBE2.

Figure 2-18. Property Panel [MINICUBE2]

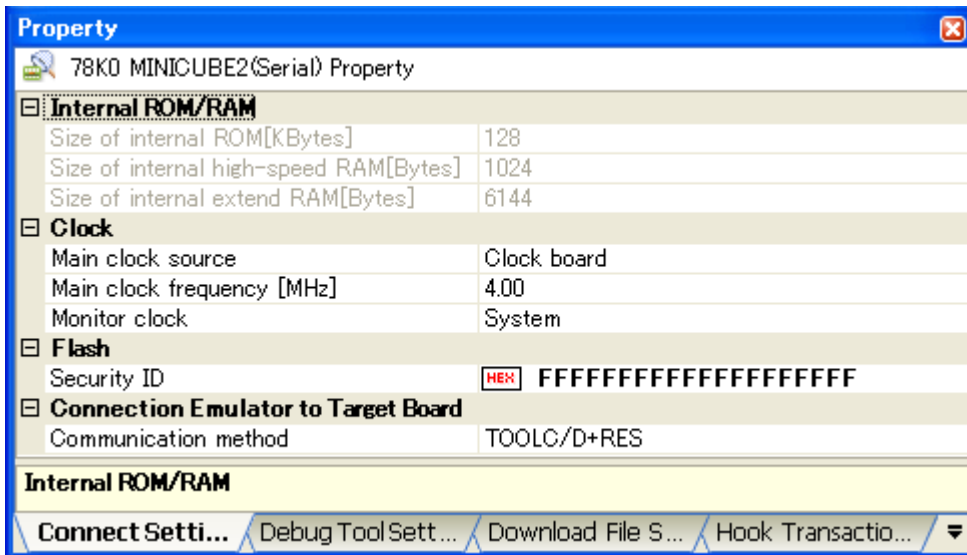

Follow the steps below by selecting the corresponding tab on the [Property panel](#).

- (1) [\[Connect Settings\] tab](#)
- (2) [\[Debug Tool Settings\] tab](#)
- (3) [\[Download File Settings\] tab](#)
- (4) [\[Hook Transaction Settings\] tab](#)

(1) **[Connect Settings] tab**

In the [\[Connect Settings\] tab](#), configuration with regard to the connection to the debug tool can be done.

- (a) [\[Internal ROM/RAM\]](#)
- (b) [\[Clock\]](#)
- (c) [\[Flash\]](#)
- (d) [\[Connection Emulator to Target Board\]](#)

(a) **[Internal ROM/RAM]**

The configuration of internal ROM/RAM is displayed in this category.

Figure 2-19. [Internal ROM/RAM] Category [MINICUBE2]

Internal ROM/RAM	
Size of internal ROM[KBytes]	128
Size of internal high-speed RAM[Bytes]	1024
Size of internal extend RAM[Bytes]	6144

<1> **[Size of internal ROM[KBytes]**

The internal ROM size to emulate is displayed (unit: Kbytes).

If the currently selected microcontroller provides the memory bank function, it displays the value including the ROM size of the internal bank.

You cannot change the value of this property.

<2> **[Size of internal high-speed RAM[Bytes]]**

The internal high-speed RAM size to emulate is displayed (unit: bytes).
You cannot change the value of this property.

<3> **[Size of internal extend RAM[Bytes]]**

The internal extend RAM size to emulate is displayed (unit: bytes).
You cannot change the value of this property.

(b) [Clock]

You can configure the clock in this category.

Figure 2-20. [Clock] Category [MINICUBE2]

☐ Clock	
Main clock source	Generate by emulator
Main clock frequency [MHz]	4.00
Monitor clock	System

<1> **[Main clock source]**

Specify the main clock source to input to the CPU from the following drop-down list.

Clock board	Uses a clock of the transmitter on the clock board (default). Note that if there is no transmitter on the clock board, this item is not appeared.
Generate by emulator	Uses a clock generated inside MINICUBE2.

Caution This property cannot be changed while connecting to MINICUBE2.

<2> **[Main clock frequency[MHz]]**

This property appears only when [Generate by emulator] is displayed in the [Main clock source] property.
Specify the main clock frequency from the drop-down list.

The drop-down list displays the following frequencies (unit: MHz).

4.00 (default), 8.00, 16.00

Caution This property cannot be changed while connecting to MINICUBE2.

Remark The main clock frequency is used to synchronize the communication between MINICUBE2 and the host machine. This specification is not for the frequency of the CPU operation.

<3> **[Monitor clock]**

Specify a clock for monitor programs to operate while the program is stopped.

Specify from the following drop-down list.

System	Operates with main clock (default).
User	Operates with the clock that the program specified.

(c) [Flash]

You can configure the flash memory rewriting in this category.

Figure 2-21. [Flash] Category [MINICUBE2]



<1> [Security ID]

This property appears only when the selected microcontroller supports the ROM security function (security ID) for flash memory.

Specify a security ID for reading codes in the internal ROM or internal flash memory.

Directly enter 20 digits hexadecimal number (10 bytes) ([FFFFFFFFFFFFFFFF] is specified by default).

For details on the security ID authentication, see MINICUBE2 User's Manual.

Caution This property cannot be changed while connecting to MINICUBE2.

(d) [Connection Emulator to Target Board]

You can configure the connection between MINICUBE2 and the target board in this category.

Note that this category appears only when a microcontroller in which the communication method between MINICUBE2 and the target board can be changed is selected.

Figure 2-22. [Connection Emulator to Target Board] Category



<1> [Communication method]

Specify the port to which to connect MINICUBE2 when performing serial communication between MINICUBE2 and the device in the target system.

1-wire, 2-wire, and 3-wire communication are supported as the communication format. Select a port from the following drop-down list according to the communication format and the ports used for communication (the ports that can be selected depend on the selected device.)

Setting	Communication Format	Port Name	Description
TOOLD ^{Note}	1-wire	TOOLD0	In this format, a clock is not supplied for communication between MINICUBE2 and the target microcontroller. Note that the [Main clock source] property in the [Clock] category disappears and the [Mask TARGET RESET signal] property in the [Mask for Input Signal] category is automatically fixed to [No].
TOOLC/D	2-wire	TOOLD0 TOOLC0	The setting specified in the [Main clock source] property is used.
TOOLD+RES ^{Note}	2-wire	TOOLD RESET	In this format, a clock is not supplied for communication between MINICUBE2 and the target microcontroller. Note that the [Main clock source] property in the [Clock] category disappears.

Setting	Communication Format	Port Name	Description
TOOLC/D+RES	3-wire	TOOLDx TOOLCx RESET	The setting specified in the [Main clock source] property is used (default).

Note This item can be selected only if no oscillator or oscillation circuit is mounted on the clock board.

Caution This property cannot be changed while connecting to MINICUBE2.

(2) [Debug Tool Settings] tab

In the [\[Debug Tool Settings\] tab](#), general configurations on the debug tool can be done.

- (a) [\[Memory\]](#)
- (b) [\[Access Memory While Running\]](#)
- (c) [\[Break\]](#)
- (d) [\[Power Off Emulation\]](#)
- (e) [\[Mask for Input Signal\]](#)

(a) [Memory]

You can configure the memory in this category.

Figure 2-23. [Memory] Category [MINICUBE2]

<input type="checkbox"/> Memory	
<input type="checkbox"/> Memory mappings	[5]
<input type="checkbox"/> [0]	Internal ROM area
<input type="checkbox"/> [1]	Non-map area
<input type="checkbox"/> [2]	Internal high-speed RAM area
<input type="checkbox"/> [3]	Register area
<input type="checkbox"/> [4]	SFR area
Verify on writing to memory	Yes

<1> [Memory mappings]

Current memory mapping status is displayed for each type of memory area.

The memory mapping status cannot be changed on this panel. If it is necessary to add a memory mapping, click on the [\[Memory Mapping\]](#) property, and click on the [\[...\]](#) button that appears on the right end of the setting field. The [Memory Mapping dialog box](#) opens; perform the setting from there. See the section for the [Memory Mapping dialog box](#) for details on how to configure the parameters.

Figure 2-24. Opening the Memory Mapping Dialog Box

<input type="checkbox"/> Memory	
<input type="checkbox"/> Memory mappings	[5] 
<input type="checkbox"/> [0]	Internal ROM area
<input type="checkbox"/> [1]	Non-map area

Caution If you are not connected to a debug tool, then only memory mapping areas added by user is displayed.

Connecting to a debug tool (see ["2.4.1 Connect the debug tool to CubeSuite"](#)) will display details for each memory type.

<2> [Verify on writing to memory]

Specify whether to perform a verify check when data has been written to memory from the drop-down list.

Select [Yes] to perform verification (default).

Remark The verification is performed at when the download is performed, or when the values that have been modified on the [Watch panel/Memory panel](#) are written to the memory. Note, however, that writing to built-in flash memory does not depend on this setting. Writing to flash self is always internally verified (excluding read verification).

(b) [Access Memory While Running]

You can configure the memory access in this category.

See "(4) [Display/modify the memory contents during program execution](#)" for details on the real-time display update function.

Figure 2-25. [Access Memory While Running] Category [MINICUBE2]

<input type="checkbox"/> Access Memory While Running	
Access by stopping execution	No
Update display during the execution	Yes
Display update interval[ms]	500
Set update display during the execution automatically	Yes

<1> [Access by stopping execution]

Specify whether to allow access to the memory area while executing a program.

Select [Yes] to allow access ([No] is selected by default).

<2> [Update display during the execution]

Specify whether to update the display in the [Watch panel/Memory panel](#) during a program execution (the real-time display update function).

Select [Yes] to update the display (default).

<3> [Display update interval[ms]]

This property is valid only when the [\[Update display during the execution\]](#) property is set to [Yes].

Specify the interval in 100ms unit to update the contents in the [Watch panel/Memory panel](#) display while executing a program.

Directly enter the Integer number between 100 and 65500 (rounding up the fractions less than 100ms) ([500] is specified by default).

<4> [Set update display during the execution automatically]

This property appears only when the [\[Update display during the execution\]](#) property is set to [Yes].

Select [Yes] when letting the MINICUBE2 set the area displayed in the [Watch panel/Memory panel](#) as automatically as possible as an area to be updated by the real-time display update function and updating the displayed content during execution of the program (default).

(c) [Break]

You can configure the break function in this category.

Figure 2-26. [Break] Category [MINICUBE2]

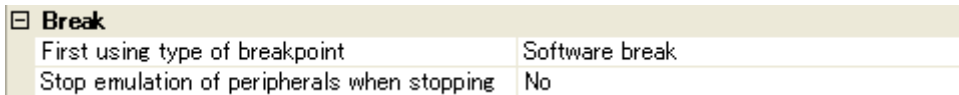

<1> [First using type of breakpoint]

Specify from the following drop-down list a breakpoint type to use with priority when setting it with a one click operation of the mouse in the [Editor panel/Disassemble panel](#).

See "2.8.2 Stop the program at the arbitrary position (breakpoint)" for details on breakpoints.

Software break	Sets software breakpoint with priority (default).
Hardware break	Sets hardware breakpoint with priority.

<2> [Stop emulation of peripherals when stopping]

Specify from the drop-down list whether to terminate the peripheral emulation while stopping the program execution.

Setting	78K0/Fx2, 78K0/Lx2, 78K0/Lx, 78K0/3Kx2	78K0/Kx1+
[Yes]	While stopping the program execution, operations of the peripheral function are stopped except for the following. - TMH1 (however, only when fRL is selected as the count clock)	While stopping the program execution, operations of the peripheral function are stopped except for the following. - TM50
[No] (default)	While stopping the program execution, operations of the peripheral function are maintained except for the following. - TMH1 (however, only when fRL/2 ⁷ or fRL/2 ⁹ is selected as the count clock) - Watchdog timer	While stopping the program execution, operations of the peripheral function are maintained except for the following. - TMH (however, only when fRL/2 ⁷ is selected as the count clock) - Watchdog timer

(d) [Power Off Emulation]

You can configure the Power off emulation function in this category.

Figure 2-27. [Power Off Emulation] Category [MINICUBE2]



<1> [Enable Power-off emulation]

Specify from the drop-down list whether to enable the Power off emulation function (this function executes the program after a CPU reset action).

Select [Yes] to enable (default).

(e) [Mask for Input Signal]

You can configure the input signal masking in this category.

Figure 2-28. [Mask for Input Signal] Category [MINICUBE2]

Mask for Input Signal	
Mask TARGET RESET signal	No
Mask INTERNAL RESET signal	No

With the properties shown below, select [Yes] to mask the signal from the drop-down list (all properties below are set to [No] by default).

- [Mask TARGET RESET signal]
- [Mask INTERNAL RESET signal]

(3) [Download File Settings] tab

In the [Download File Settings] tab, configuration on downloading file to the debug tool can be done. See "2.5.1 Execute downloading" for details on each category configuration.

(4) [Hook Transaction Settings] tab

In the [Hook Transaction Settings] tab, configuration on the hook transaction can be done. See "2.16 Use Hook Function" for details on each category configuration and the function of the hook transaction.

2.3.4 [Simulator]

Configure the operating environment on the [Property panel](#) below when using Simulator.

Figure 2-29. Property Panel [Simulator]

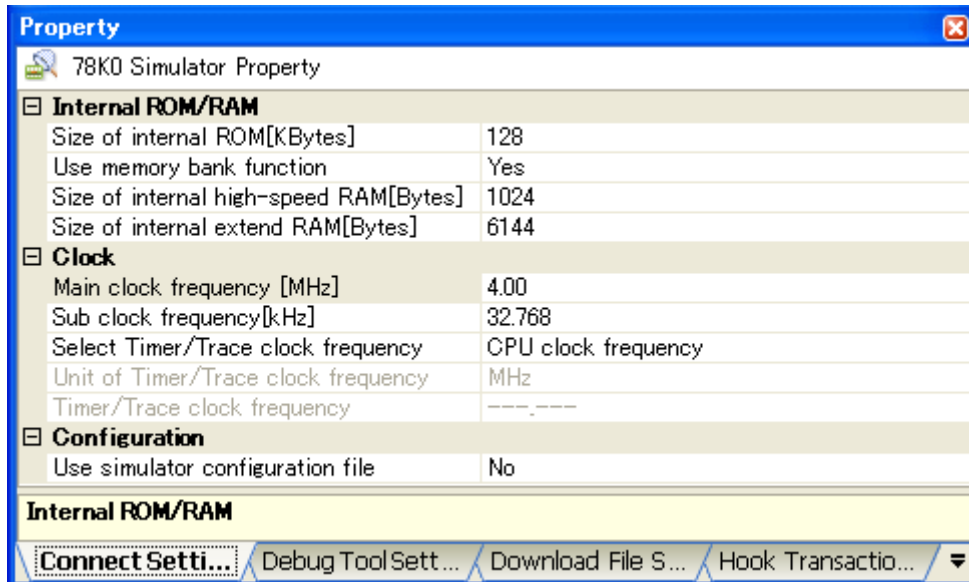

Follow the steps below by selecting the corresponding tab on the [Property panel](#).

- (1) [\[Connect Settings\] tab](#)
- (2) [\[Debug Tool Settings\] tab](#)
- (3) [\[Download File Settings\] tab](#)
- (4) [\[Hook Transaction Settings\] tab](#)

Remark When Simulator to be used corresponds to peripheral function simulations, you can use the Simulator GUI. See "2.17 [Use the Simulator GUI \[Simulator\]](#)" for details on the Simulator GUI.

(1) [Connect Settings] tab

In the [\[Connect Settings\] tab](#), configuration with regard to the connection to the debug tool can be done.

- (a) [\[Internal ROM/RAM\]](#)
- (b) [\[Clock\]](#)
- (c) [\[Configuration\]](#)

(a) [Internal ROM/RAM]

You can configure internal ROM/RAM in this category.

The size of internal ROM/internal high-speed RAM/internal extend RAM of the selected microcontroller is specified by default.

There is no need to change the settings in this category if you wish to debug with the same memory mapping of the selected microcontroller.

Figure 2-30. [Internal ROM/RAM] Category [Simulator]

Internal ROM/RAM	
Size of internal ROM[KBytes]	128
Use memory bank function	Yes
Size of internal high-speed RAM[Bytes]	1024
Size of internal extend RAM[Bytes]	6144

<1> [Size of internal ROM[KBytes]]

Specify the internal ROM size to simulate from the drop-down list (unit: bytes).

Note that specifying the [Use memory bank function] property at the bottom will change the numbers displayed in the drop-down list (if the memory bank function is used, it will display the values with the internal bank's ROM size added).

<2> [Use memory bank function]

This property appears only when the selected microcontroller provides the memory bank function.

Specify from the drop-down list whether to use the memory bank function.

Select [Yes] to the memory bank function (default).

<3> [Size of internal high-speed RAM[Bytes]]

Specify the internal high-speed RAM size to simulate (unit: bytes).

To perform debugging after changing the memory mapping, make a selection from the drop-down list.

<4> [Size of internal extend RAM[Bytes]]

Specify the internal extend RAM size to simulate (unit: bytes).

To perform debugging after changing the memory mapping, make a selection from the drop-down list.

(b) [Clock]

You can configure the clock in this category.

Figure 2-31. [Clock] Category [Simulator]

Clock	
Main clock frequency [MHz]	4.00
Sub clock frequency[kHz]	32.768
Select Timer/Trace clock frequency	CPU clock frequency
Unit of Timer/Trace clock frequency	MHz
Timer/Trace clock frequency	---.---

<1> [Main clock frequency[MHz]]

Specify the main clock frequency.

You can specify the frequency from the drop-down list or by directly entering a frequency value between 0.001 and 99.999 (unit: MHz).

The drop-down list displays the following frequencies (unit: MHz).

1.00, 2.00, 3.00, 3.57, 4.00 (default), 4.19, 4.91, 5.00, 6.00, 8.00, 8.38, 10.00, 12.00, 16.00, 20.00

<2> [Sub clock frequency[kHz]]

Specify the sub clock frequency.

You can specify the frequency from the drop-down list or by directly entering a frequency value between 0.001 and 99.999 (unit: kHz).

The drop-down list displays the following frequencies (unit: kHz).

32.768 (default), 38.40

<3> **[Select Timer/Trace clock frequency]**

Specify the clock frequency for using timer/trace function.
Specify from the following drop-down list.

CPU clock frequency	Uses the CPU clock frequency (default).
Specify clock frequency	Specifies an arbitrary frequency (property items to specify become valid in the lower area).

<4> **[Unit of Timer/Trace clock frequency]**

This property appears only when the [\[Select Timer/Trace clock frequency\]](#) property is set to [\[Specify clock frequency\]](#).
Specify from the following drop-down list the unit of the clock frequency for timer/trace.

MHz	The unit of the frequency is in MHz (default).
KHz	The unit of the frequency is in kHz.

<5> **[Timer/Trace clock frequency]**

The operation of this property differs depending on the specification with the [\[Select Timer/Trace clock frequency\]](#) property.

- When [\[Specify clock frequency\]](#) is specified
Specify the clock frequency for timer/trace.
Directly enter the value between 1 [kHz] and 99.999 [MHz] ([4.00] is specified by default).
Unit is depending on the specification with the [\[Unit of Timer/Trace clock frequency\]](#) property.
- When [\[CPU clock frequency\]](#) is specified
While disconnecting from the debug tool, [---_---] is displayed. While connecting to the debug tool, *[CPU clock frequency]* is displayed.

(c) **[Configuration]**

You can configure the customization of the simulator in this category.

Figure 2-32. **[Configuration] Category**

Configuration	
Use simulator configuration file	Yes
Simulator configuration file	

<1> **[Use simulator configuration file]**

Specify from the drop-down list whether to use the simulator configuration file to perform user customization (adding of user models) of the simulator.
Select [\[Yes\]](#) to use the simulator configuration file ([\[No\]](#) is selected by default).

<2> **[Simulator configuration file]**

Specify the simulator configuration file to use.
Directly enter the file name, or select the file with the [Select Simulator Configuration File dialog box](#) [\[Simulator\]](#) opened by clicking on the [...] button that appears on the right end of the setting field.

Caution This property cannot be changed while connecting to Simulator.

(2) [Debug Tool Settings] tab

In the [Debug Tool Settings] tab, general configurations on the debug tool can be done.

- (a) [Memory]
- (b) [Access Memory While Running]
- (c) [Break]
- (d) [Trace]
- (e) [Timer]
- (f) [Coverage]
- (g) [Simulator GUI]

(a) [Memory]

You can configure the memory in this category.

Figure 2-33. [Memory] Category [Simulator]

[-] Memory	
[-] Memory mappings	[5]
[+] [0]	Internal ROM area
[+] [1]	Non-map area
[+] [2]	Internal high-speed RAM area
[+] [3]	Register area
[+] [4]	SFR area

<1> [Memory mappings]

Current memory mapping status is displayed for each type of memory area.

The memory mapping status cannot be changed on this panel. If it is necessary to add a memory mapping, click on the [Memory Mapping] property, and click on the [...] button that appears on the right end of the setting field. The Memory Mapping dialog box opens; perform the setting from there. See the section for the Memory Mapping dialog box for details on how to configure the parameters.

Figure 2-34. Opening the Memory Mapping Dialog Box

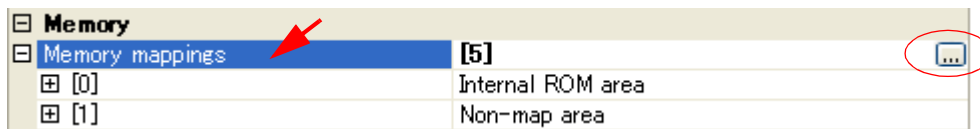

Caution If you are not connected to a debug tool, then only memory mapping areas added by user is displayed.

Connecting to a debug tool (see "2.4.1 Connect the debug tool to CubeSuite") will display details for each memory type.

(b) [Access Memory While Running]

You can configure the memory access in this category.

See "(4) [Display/modify the memory contents during program execution](#)" for details on the real-time display update function.

Figure 2-35. [Access Memory While Running] Category [Simulator]

Access Memory While Running	
Update display during the execution	Yes
Display update interval[ms]	500

<1> [Update display during the execution]

Specify whether to update the display in the [Watch panel/Memory panel](#) during a program execution (the real-time display update function).

Select [Yes] to update the display (default).

<2> [Display update interval[ms]]

This property is valid only when the [\[Update display during the execution\]](#) property is set to [Yes].

Specify the interval in 100ms unit to update the contents in the [Watch panel/Memory panel](#) display while executing a program.

Directly enter the Integer number between 100 and 65500 (rounding up the fractions less than 100ms) ([500] is selected by default).

(c) [Break]

You can configure the break function in this category.

Figure 2-36. [Break] Category [Simulator]

Break	
Execute instruction at breakpoint when break	No

<1> [Execute instruction at breakpoint when break]

Specify the timing to stop the program execution by breakpoints either after or before the execution of the instruction at the breakpoint.

Select [Yes] to stop after the execution of the instruction ([No] is selected by default).

See "[2.8.2 Stop the program at the arbitrary position \(breakpoint\)](#)" for details on breakpoints.

(d) [Trace]

You can configure the trace function in this category.

See "[2.11 Collect Execution History of Programs \[IECUBE\]\[Simulator\]](#)" for details on the trace function and this category configuration.

(e) [Timer]

You can configure the timer function in this category.

See "[2.12 Measure Execution Time of Programs](#)" for details on the timer function.

Figure 2-37. [Timer] Category [Simulator]

Timer	
Use timer function	No

<1> [Use timer function]

Specify whether to use the timer function from the drop-down list.
Select [Yes] to use the timer function ([No] is selected by default).

(f) [Coverage]

You can configure the coverage function in this category.

See "[2.13 Measure Coverage \[IECUBE\]\[Simulator\]](#)" for details on the coverage function and this category configuration.

(g) [Simulator GUI]

You can configure the Simulator GUI function in this category.

See "[2.17 Use the Simulator GUI \[Simulator\]](#)" for details on the Simulator GUI function and this category configuration.

(3) [Download File Settings] tab

In the [\[Download File Settings\] tab](#), configuration on downloading file to the debug tool can be done.

See "[2.5.1 Execute downloading](#)" for details on each category configuration.

(4) [Hook Transaction Settings] tab

In the [\[Hook Transaction Settings\] tab](#), configuration on the hook transaction can be done.

See "[2.16 Use Hook Function](#)" for details on each category configuration and the function of the hook transaction.

2.4 Connect to/Disconnect from the Debug Tool

This section describes how to connect to/disconnect from the debug tool.

2.4.1 Connect the debug tool to CubeSuite



Select the [Debug] menu >> [Connect to Debug Tool] to connect to the debug tool selected in the currently active project.

After succeeding in the connection to the debug tool, the **Statusbar** of the **Main window** changes as follows:

For details on each item displayed on the **Statusbar**, see the section of the "Main window".

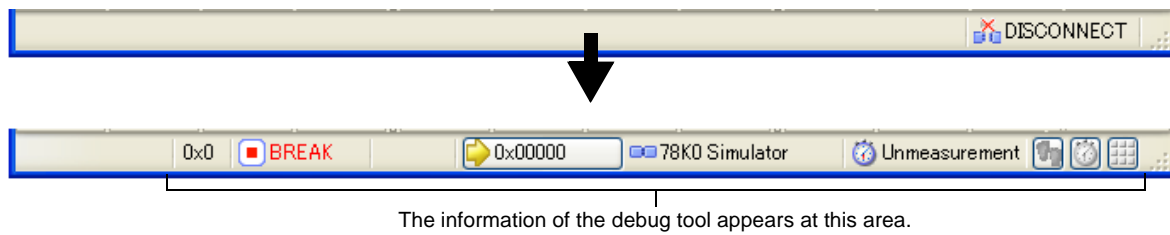
Figure 2-38. The Statusbar during Connecting to Debug Tool (Example for Using Simulator)



- Remarks 1.** When the  button on the **Debug toolbar** is clicked, the specified file is downloaded automatically after connecting to the debug tool (see "2.5.1 Execute downloading").
When the  button on this toolbar is clicked, the project is built automatically, and then the built file is downloaded after connecting to the debug tool.
- 2.** When a microcontroller whose Simulator supports peripheral function simulations is selected and [Simulator] is selected as the debug tool to use, the **Simulator GUI window** is automatically opened after connecting to the debug tool (default).

2.4.2 Disconnect the debug tool from CubeSuite

Click the  button on the **Debug toolbar** to disconnect from the currently connected debug tool.

After disconnecting from the debug tool, the **Statusbar** of the **Main window** changes as follows:

Figure 2-39. The Statusbar during Disconnecting From Debug Tool

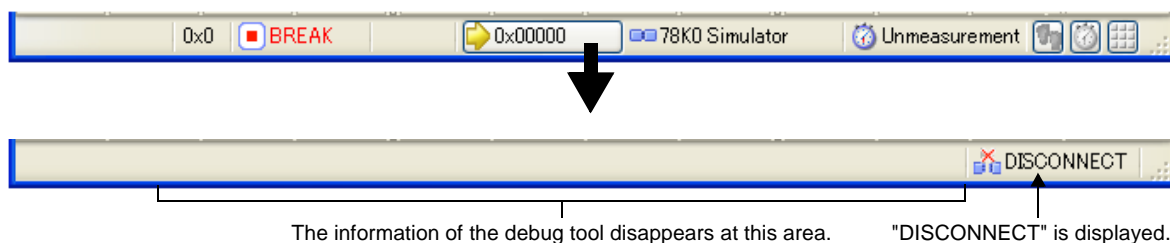

Remark When the debug tool is disconnected, all panels and dialog boxes that are displayed only when the debug tool is connected are closed.

2.5 Download/Upload Programs

This section describes how to download programs (such as load module files (*.Imf)) to debug to CubeSuite and how to upload the debugging memory contents from CubeSuite to files.

2.5.1 Execute downloading

Download the lode module file to debug to the debug tool that is currently connected.

Follow the steps below on the [\[Download File Settings\]](#) tab in the [Property panel](#) for the downloading, and then execute the downloading.

(1) [\[Download\]](#) category setting

Figure 2-40. [\[Download\]](#) Category

<input type="checkbox"/> Download	
<input type="checkbox"/> Download files	[1]
<input type="checkbox"/> [0]	Debug Build*.Imf
File	Debug Build*.Imf
File type	Load module file
Download object	Yes
Download symbol information	Yes
CPU Reset after download	Yes
Erase flash ROM before download	No
Automatic change method of event setting position	Suspend event

(a) [\[Download files\]](#)

The names of files to be downloaded and the download conditions are displayed (the number enclosed with "[]" indicates the number of files to be download).

A file to be downloaded is automatically decided to a file that have been specified as the build target file in main project or subproject^{Note}.

However, you can manually change the download files and the condition. In this case, see "[2.5.2 Advanced downloading](#)".

Note To download a load module file created by an external build tool (i.e. a compiler or assembler other than the build tool provided by CubeSuite), you must create a debug-dedicated project.

In the debug-dedicated project, a file to be downloaded is reflected to this property by your adding the file to the Download files node in the project tree.

See "CubeSuite Start" for details on the using an external build tool and a debug-dedicated project.

(b) [\[CPU Reset after download\]](#)

Specify whether to reset the CPU after downloading.

Select [Yes] to reset the CPU (default).

(c) [\[Erase flash ROM before download\]](#)

Specify whether to erase the flash ROM before downloading.

Select [Yes] to erase the flash ROM ([No] is selected by default).

(d) [\[Automatic change method of event setting position\]](#)

If the file is downloaded again during debugging then the location (address) set for the currently configured event may change to midway in the instruction.

Specify with this property how to handle the target event in this circumstance.

Select one of the options from the following drop-down list.

Move to the head of instruction	Sets the event to the top address of the instruction.
Suspend event	Disables the event (suspended state) (default).

Note, however, that this property setting only applies to the location setting of events without debugging information. The location setting of events with debug information is always moved to the beginning of the source text line.

(2) [Debug Information] category setting

Figure 2-41. [Debug information] Category

Debug Information	
Execute to the specified symbol after CPU Reset	Yes
Specified symbol	_main
Startup start symbol	@cstart
Startup end symbol	@cend

(a) [Execute to the specified symbol after CPU Reset]

Specify from the drop-down list whether to execute the program to the specified symbol position after CPU reset or downloading (for only when the [\[CPU Reset after download\]](#) property is set to [Yes]).

Select [Yes] to execute the program to the specified symbol position after CPU reset (default).

Remark When the [\[CPU Reset after download\]](#) property is set to [Yes], the operation after downloading is as follows:

If [Yes] is selected for this property, the [Editor panel](#) will open automatically with displaying source text of the position specified with the [\[Specified symbol\]](#) property after downloading.

If [No] is selected for this property, the Editor panel will open with displaying source text of the reset address (when if the source text has not been allocated to the reset address, the contents of the reset address is displayed in the [Disassemble panel](#)).

(b) [Specified symbol]

This property appears only when the [\[Execute to the specified symbol after CPU Reset\]](#) property is set to [Yes].

Specify the position at which the program is stop after CPU reset.

Directly enter an address expression between 0 and "*last address in address space*" (`[_main]` is specified by default).

Note, however, that the program will not be executed if the specified address expression cannot be converted into an address.

Remark Normally, specify the following.

For assembler source: Start label corresponding to main function

For C source: Symbol assigned to the start of the main function name

(c) [Startup start symbol]

Specify the start symbol of the text area (code area) of the startup routine.

Directly enter an address expression between 0 and "*last address in address space*" (`[_cstart]` is specified by default).

This setting is not needed if the source is assembly language.

(d) [Startup end symbol]

Specify the end symbol of the text area (code area) of the startup routine.

Directly enter an address expression between 0 and "last address in address space" ([_@cend] is specified by default).

This setting is not needed if the source is assembly language.

- Cautions 1.** To automatically display the source text right after downloading the file, the startup symbol must be correctly specified.
- 2.** By default, CPU reset automatically occurs after downloading the file, and then the program is executed to the specified symbol position. If this operation above is not needed, specify [No] with both of the [CPU Reset after download] and [Execute to the specified symbol after CPU Reset] property.

(3) Execute download

Click the  button on the [Debug toolbar](#).

If this operation is performed while disconnecting from the debug tool, the application automatically connects to the debug tool, and then performs the download.

Remark When a program that has been modified during debugging is re-downloaded, you can easily build and download it by selecting [Build & Download] from the [Debug] menu on the [Main window](#).

If the load module file is successfully downloaded, the [Editor panel](#) opens automatically, and the contents of the downloaded file's source text are displayed.

Remarks 1. [IECUBE][MINICUBE2]

You can specify whether to verify memory writing when downloading the file by configuring the [Verify on writing to memory] property in the [Memory] category in the [\[Debug Tool Settings\] tab](#) of the [Property panel](#).

- 2.** You can automatically overwrite the value of SFR/CPU register with the specified values before and after performing the download (see "2.16 [Use Hook Function](#)" for details).

2.5.2 Advanced downloading

You can change the download files and the condition to download.

With CubeSuite, the following file types can be downloaded.

Table 2-1. Type of Files That Can be Downloaded

File Format	Extension	Note
Load module format	lmf	
Intel Hex format (Standard)	hex, hxb, hxf	
Intel Hex format (Extension)	hex, hxb, hxf	Can be up to 1 Mbyte
Motorola S type Hex format (S0, S2, S8 - 24 bit-address)	hex, hxb, hxf	
Extended Tektronix Hex format	hex, hxb, hxf	
Binary data format	bin	

- The value of a watch-expression of variable may be displayed incorrectly, because debug information does not include valid period information of variables. This item applies to cases where a variable is optimized and deleted, or a value is temporarily assigned to a register.

- Floating point rounding accuracy differs between the compiler and debugger.
- Only a current function is displayed in the [Call Stack panel](#) because the call stack information cannot be acquired.
- Step execution in setjmp function is not possible.
- A return out execution from a variable-length argument function may fail.

Remark [IECUBE]

When the flash library is ROMized, the flash self programming emulation function cannot be used. If hex or binary-data format is specified when using a memory bank, you can select a memory bank file ([Hex file [Bank]] / [Binary data file [Bank]]) or a 64 Kbytes file ([Hex file [64KB]] / [Binary data file [64KB]]).

You can change the download files or the download condition in the following [Download Files dialog box](#).

The Download Files dialog box is opened when clicking the [...] button appears at right by selecting the [Download files] property in the [Download] category in the [\[Download File Settings\] tab](#) of the [Property panel](#).

Figure 2-42. Opening the Download Files Dialog Box

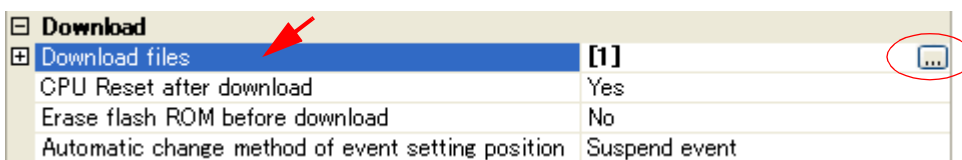
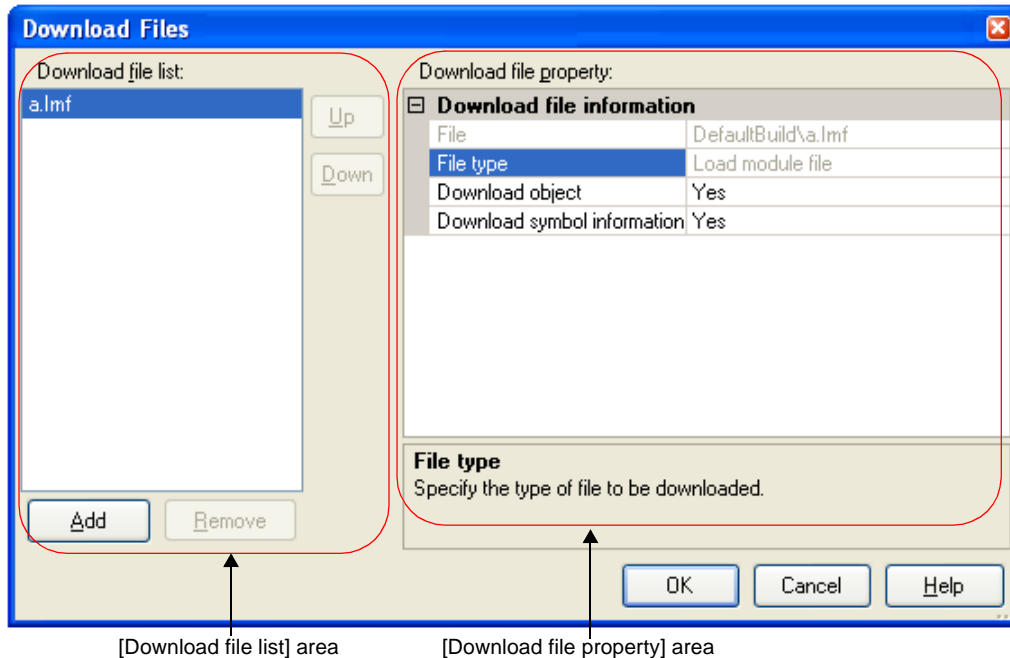

Figure 2-43. Advanced Downloading (Download Files Dialog Box)



This section describes how to configure on the [Download Files dialog box](#) above when the following cases.

- (1) [Change download condition of a load module file](#)
- (2) [Add download files \(*.hex, *.hxb, *.hxf/*.bin\)](#)
- (3) [Perform source level debugging with a hex or binary data format file](#)

Caution You cannot download more than one load module file (*.Imf).

(1) Change download condition of a load module file

Follow the steps below in the [Download Files dialog box](#) to change download condition (object information and symbol information) of load module files (*.Imf) to download.

(a) Select a load module file

Select a load module file to download in the [Download file list] area.

(b) Change download condition

Current download condition of the selected load module file is displayed in the [Download file property] area. Change each items displayed in the property.

Download object	Specify whether to download the object information from the specified file.	
	Default	Yes
	Modifying	Select from the drop-down list.
	Available values	Yes
No		Does not download object information.
Download symbol information	Specify whether to download the symbol information from the specified file ^{Note} .	
	Default	Yes
	Modifying	Select from the drop-down list.
	Available values	Yes
No		Does not download symbol information.

Note If the symbol information have not been downloaded, the source level debugging cannot be performed.

(c) Click the [OK] button

Enable all the configuration in this dialog box and change download condition.

(2) Add download files (*.hex, *.hxb, *.hxf/*.bin)

Follow the steps below to add download files (in hex format (*.hex, *.hxb, *.hxf)/in binary data format (*.bin)) in the [Download Files dialog box](#).

Caution You cannot download more than one load module file (*.Imf).

(a) Click the [Add] button

When the [Add] button is clicked, a blank list item "-" is displayed in the last line of the [Download file list] area.

(b) Property configuration of the download files to add

Configure the download condition of the download file to add in the [Download file property] area.

Configure each item displayed with the following condition.

When the configuration is completed, the file name specified in this property is displayed in the blank list of the [Download file list] area.

File	Specify the file (*.hex, *.hxb, *.hxf/*.bin) to download (up to 259 characters).	
	Default	Blank
	Modifying	Directly enter from the keyboard, or specify with the Select Download File dialog box opened by clicking the [...] button.
	Available values	See "Table 2-1. Type of Files That Can be Downloaded".
File type	Specify the type of the file to download. Select [Hex file] or [Binary data file].	
	Default	Load module file
	Modifying	Select from the drop-down list.
	Available values	Either one of the following [With memory banks] - Load module file - Hex file[Bank] (For memory banks) - Hex file[64KB] (For less than 64 Kbytes) - Binary data file[Bank] (For memory banks) - Binary data file[64KB] (For less than 64 Kbytes) [Without memory banks] - Load module file - Hex file - Binary data file
Offset	This item appears only when the file to download is in hex format (*.hex, *.hxb, *.hxf). Specify the offset from the address at which the file's download is to start.	
	Default	0x0
	Modifying	Directly enter from the keyboard.
	Available values	[With memory banks] 0x0 to 0xFFFF in hexadecimal number [Without memory banks] 0x0 to 0xFFFF in hexadecimal number
Start address	This item appears only when the file to download is in binary format (*.bin). Specify the address at which to start the file's download.	
	Default	0x0
	Modifying	Directly enter from the keyboard.
	Available values	[With memory banks] 0x0 to 0xFFFF in hexadecimal number [Without memory banks] 0x0 to 0xFFFF in hexadecimal number

Remark The settings of whether to download the object information or symbol information can be made only when the type of the file to download is load module files.

(c) Check the order of download

The order of the download is the display order of the files displayed in the [Download file list] area. If you want to change the order, use the [Up]/[Down] button.

(d) Click the [OK] button

Enable all the configuration in this dialog box and add a download file (the file name is displayed in the [Download] category in the [\[Download File Settings\] tab](#) of the [Property panel](#)).

(3) Perform source level debugging with a hex or binary data format file

You can also perform source level debugging when a hex format (*.hex, *.hxb, *.hxf) or a binary data format (*.bin) file is specified for download, by also downloading the symbol information for the load module file to be used for creation.

To do so, follow the steps below on the [Download Files dialog box](#).

(a) Click the [Add] button

When the [Add] button is clicked, a blank list item "-" is displayed in the last line of the [Download file list] area.

(b) Property configuration of the load module file to add

Configure each item displayed with the following condition in the [Download file property] area.

File	Specify the load module file that was the source for creating the hex format (*.hex, *.hxb, *.hxf) or binary data format (*.bin) file to be downloaded. Directly enter from the keyboard, or specify with the Select Download File dialog box opened by clicking the [...] button that appears at right by selecting this property.
File type	Select [Load module file] (default).
Download object	Specify [No].
Download symbol information	Select [Yes] (default).

(c) Click the [OK] button

Enable all the configuration in this dialog box and add the specified load module file (Only the symbol information included in the load module file will be downloaded).

2.5.3 Execute uploading

The contents of the memory of the debug tool currently connected can be saved (uploaded) in an arbitrary file. You can upload the data in the [Data Save dialog box](#) opened by selecting the [Debug] menu >> [Upload...]. In this dialog box, follow the steps below.

Figure 2-44. Execute Uploading (Data Save Dialog Box)

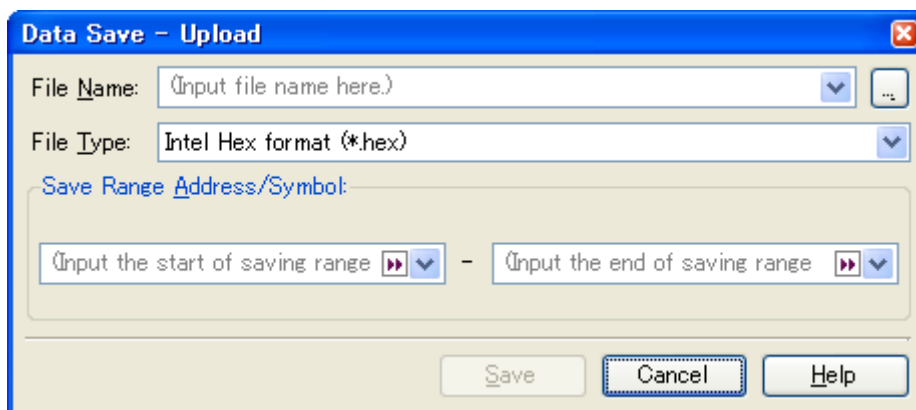

(1) Specify [File Name]

Specify the name of the file to save.

You can either type a filename directly into the text box (up to 259 characters), or select one from the input history via the drop-down list (up to 10 items). You can also specify the file by clicking the [...] button, and selecting a file via the [Select Data Save File dialog box](#).

(2) Specify [File Type]

Select the format in which to save the file from the following drop-down list.

The following file formats can be selected.

Table 2-2. Type of Files That Can be Uploaded

List Item	Format
Intel Hex format (Extension) (*.hex)	Hex format
Motorola Hex format (S0, S2, S8 - 24bit-address) (*.hex)	Hex format
Extended Tektronix Hex format (*.hex)	Hex format
Binary data (*.bin)	Binary data format

Remark When using a memory bank, if the end address specified in the [Specify \[Save Range Address/Symbol\]](#) is greater than 0x10000, then it will be uploaded as [Hex file[Bank]]/[Binary data file[Bank]].

(3) Specify [Save Range Address/Symbol]

Specify the range of addresses to save via "start address" and "end addresses".

Directly enter hexadecimal number/address expression in each text box or select from the input history displayed in the drop-down list (up to 10 items).

If you wish to download the file that have been saved with the end address that is greater than 0x10000, specify [Hex file[Bank]] or [Binary data file[Bank]] with the [File type] item in the [Download Files dialog box](#).

If you wish to download the file that have been saved with the end address that is less than 0x10000, specify [Hex file[64KB]] or [Binary data file[64KB]] with the [File type] item (see "[2.5.2 Advanced downloading](#)").

(4) Click the [Save] button

Save the contents of the memory in the specified file in specified format as upload data.

2.6 Display/Change Programs

This section describes how to display and change programs when a load module file with the debug information is downloaded to a debug tool.

Downloaded programs can be displayed in the following panels.

- Editor panel

The source file is displayed and can be edited.

Furthermore, the source level debugging (see "2.7.3 Execute programs in steps") and the display of the code coverage measurement result (see "2.13.2 Display the coverage measurement result") can be performed in this panel.

- Disassemble panel

The result of disassembling the downloaded program (the memory contents) is displayed and can be edited (line assemble).

Furthermore, the instruction level debugging (see "2.7.3 Execute programs in steps") and the display of the code coverage measurement result (see "2.13.2 Display the coverage measurement result") can be performed in this panel. In this panel, the disassemble results can be displayed with the corresponding source text (default).

Remark It is normally necessary to download a load module file (*.Imf) with debugging information in order to perform the source level debugging, but it is also possible to do so by downloading a hex format (*.hex, *.hxb, *.hxf) or binary data format (*.bin) file (see "(3) Perform source level debugging with a hex or binary data format file").

2.6.1 Display source files

The source file is displayed in the [Editor panel](#) below. The Editor panel automatically opens with displaying source text of the specified position (see "2.5.1 Execute downloading") when a load module file (*.Imf) is successfully downloaded.

If you want to open the Editor panel manually, double-click on the source file in the [Project Tree panel](#).

For details on the contents and function in each area, see the section for the [Editor panel](#).

Figure 2-45. Display Source File (Editor Panel)

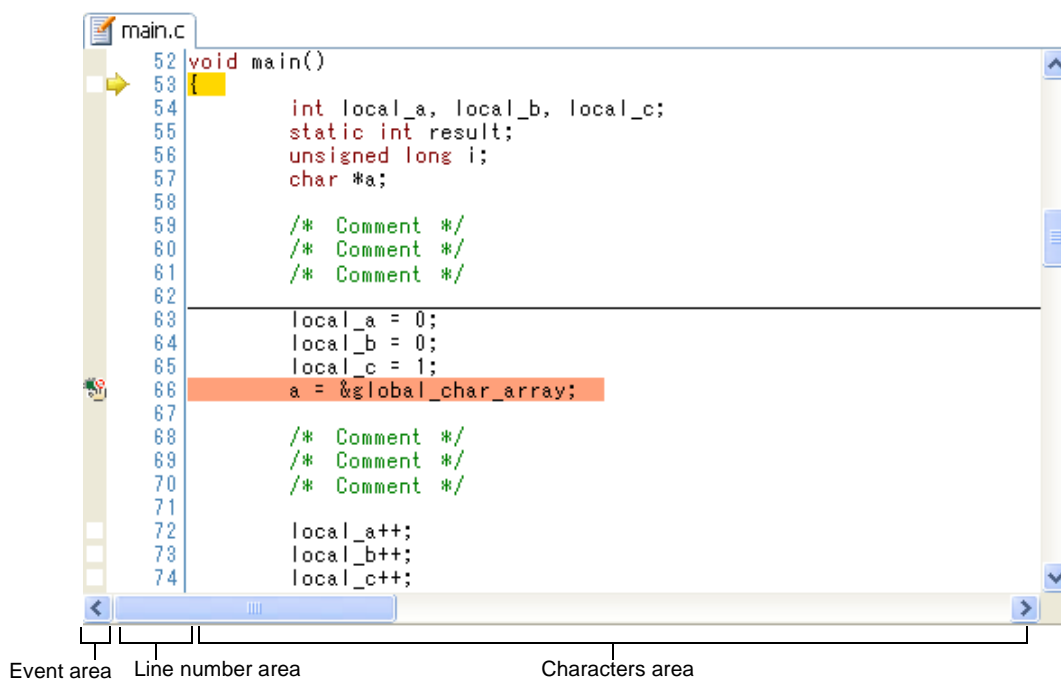

This section describes the following.

- (1) Display variables
- (2) Search characters
- (3) Move to the specified line
- (4) Jump to functions
- (5) Jump to a desired line (tag jump)

(1) Display variables

By superimposing the mouse cursor on variables on the source text, variable values are pop-up displayed.

The display format of the variable value is same as "Table A-9. Display Format of Watch-Expressions (Default)" depending on the type of the variable.

Figure 2-46. Pop-up Display of Variables (Editor Panel)

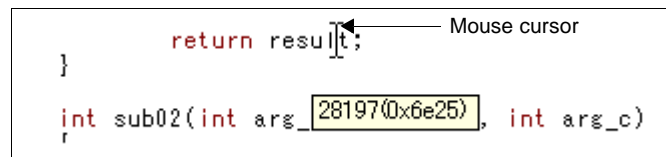

(2) Search characters

Character searching in the source text is taken place in the Search and Replace dialog box opens with selecting the  button on the toolbar. If the search is taken place with the range selection in the Editor panel, search is taken place in the selected range.

In this dialog box, follow the steps below.

Figure 2-47. Character Search in Source Text (Search and Replace Dialog Box)

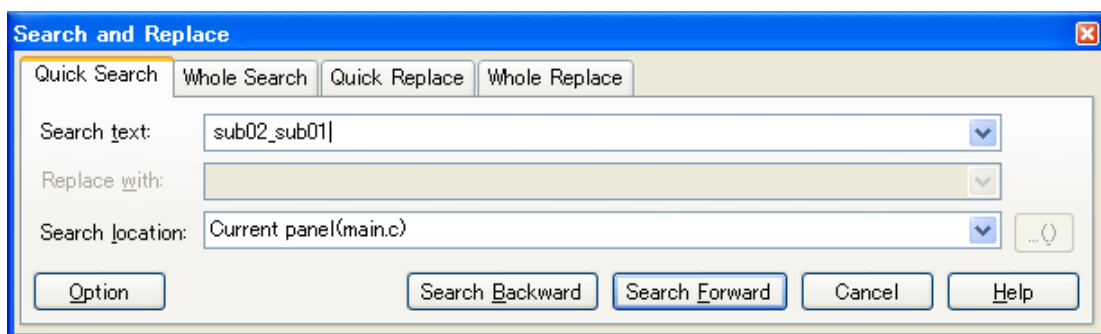

(a) Specify [Search text]

Enter characters to search.

A word (variable/function) at the caret position in the Editor panel is specified by default.

If you want to change it, directly enter the characters into the text box (up to 1024 characters) or select from the input history in the drop-down list (up to 10 items).

(b) Specify [Search location]

Select [Current panel (file name)] from the drop-down list.

If you want to search in the selected range in the Editor panel, select [Selection area].

(c) Click the [Search Backward]/[Search Forward] button

When the [Search Backward] button is clicked, search is taken place in the order from the large address number to small and the search results are displayed selected in the Editor panel.

When the [Search Forward] button is clicked, search is taken place in the order from the small address number to small and the search results are displayed selected in the Editor panel.

Remarks 1. Click the [Option] button to specify to use wild card, case sensitivity, word by word search, and so on.

2. In the Search and Replace dialog box, various search/replace operation can be done with selecting either [Whole Search]/[Quick Replace]/[Whole Replace] tab.

(3) Move to the specified line

You can move to the specified line in the source text in the Go to the Location dialog box opens when selecting [Move to...] from the context menu.

In this dialog box, follow the steps below.

Figure 2-48. Move to the Specified Line in Source Text (Go to the Location Dialog Box)

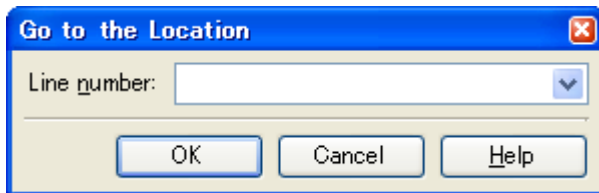

(a) Specify [Line number]

Specify the number of the line you want to move the caret to.

You can either type a location directly into the text box (only in decimal number), or select one from the input history via the drop-down list (up to 10 items).

(b) Click the [OK] button

Caret is moved to the specified line.

(4) Jump to functions

You can jump to the function determined from the selected characters or the word at the caret position (jumps to the first executable line in the target function).

Select [Jump to Function] from the context menu after moving the caret to the function on the source text.

Figure 2-49. Jump to Functions

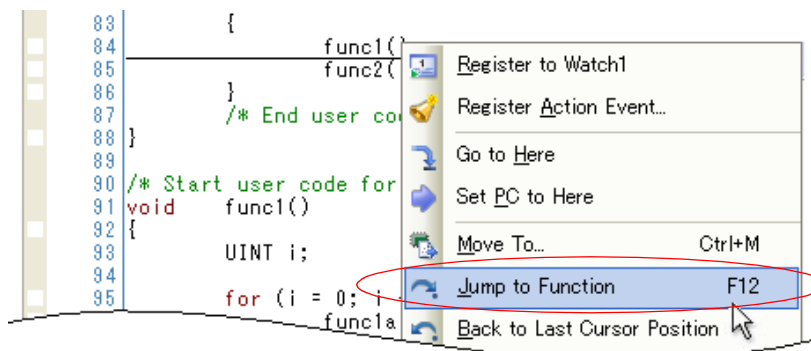

Note that this function is available only when the following conditions are satisfied depending on the build tool used:

(a) [CA78K0]

- The target function^{Note 1} has been defined in an active project.
- The type of the project specified as the active project is "Application".
- A file^{Note 2} with the symbol information has been specified with [\[Download files\]](#). For while disconnecting from the debug tool, the file has been specified at the top in [\[Download files\]](#).

(b) An External build tool

- The target function^{Note 1} has been defined in an active project.
- The focus is in the [Editor panel](#).
- A file^{Note 2} with the symbol information has been specified with [\[Download files\]](#). For while disconnecting from the debug tool, the file has been specified at the top in [\[Download files\]](#).

- Notes 1.** A Jump to a static function cannot be made while disconnecting from the debug tool.
- 2.** When the file is the hex format, the specification of downloading the symbol information is required (see "(3) [Perform source level debugging with a hex or binary data format file](#)").

Caution When multiple statements are described in a line, a jump to an illegal location may be made.

Remark The word determination depends on the current build tool.

(5) Jump to a desired line (tag jump)

If the information of a file name, a line number and a column number exists in the line at the caret position, you can open the file in the another [Editor panel](#) and jump to the corresponding line and the corresponding column (if the Editor panel is already opened, jump to the panel).

Select [Tag Jump] from the context menu after moving the caret to the line on the source text.

The tag jump is operated as follows:

Table 2-3. Operation of Tag Jump

Example of Character String	Operation
C:\work\src.c	Jumps to the top line of the file "C:\work\src.c".
Tmp\src.c	Jumps to the top line of the file ".Tmp\src.c". (The reference point of the path is the project folder.)
C:\work\src.c(10)	Jumps to the tenth line from the top of the file "C:\work\src.c".
C:\work sub\src.c"(10)	Jumps to the tenth line from the top of the file "C:\work sub\src.c". (Path specification (path/file name) including space characters must be enclosed in ".")
C:\work\src.c(10,5)	Jumps to the fifth column of the tenth line from the top of the file "C:\work\src.c".

Figure 2-50. Tag Jump

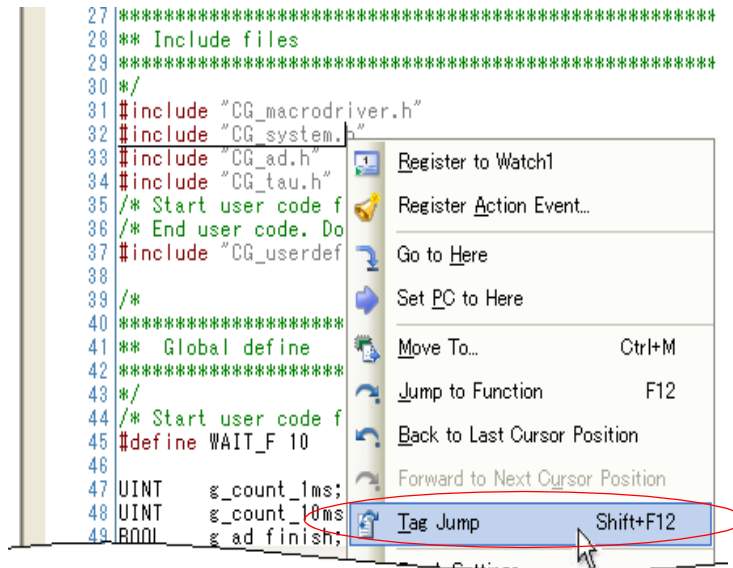

- Remarks 1.** Jumps are case-insensitive.
2. The reference point of the path is the project folder in which the file is registered. If the file is not registered in any project, the reference point of the path will be the active folder.
 3. Path specifications (path/file names) including space characters must be enclosed in "".

2.6.2 Display the result of disassembling

The result of disassembling the downloaded program (disassembled text) is displayed in the [Disassemble panel](#) below. Select [View] menu >> [Disassemble] >> [Disassemble 1 - 4].

The maximum of 4 Disassemble panels can be opened. Each panel is identified by the names "Disassemble1", "Disassemble2", "Disassemble3" and "Disassemble4" on the title bar.

For details on the contents and function in each area, see the section for the [Disassemble panel](#).

Figure 2-51. Display the Result of Disassembling (Disassemble Panel)

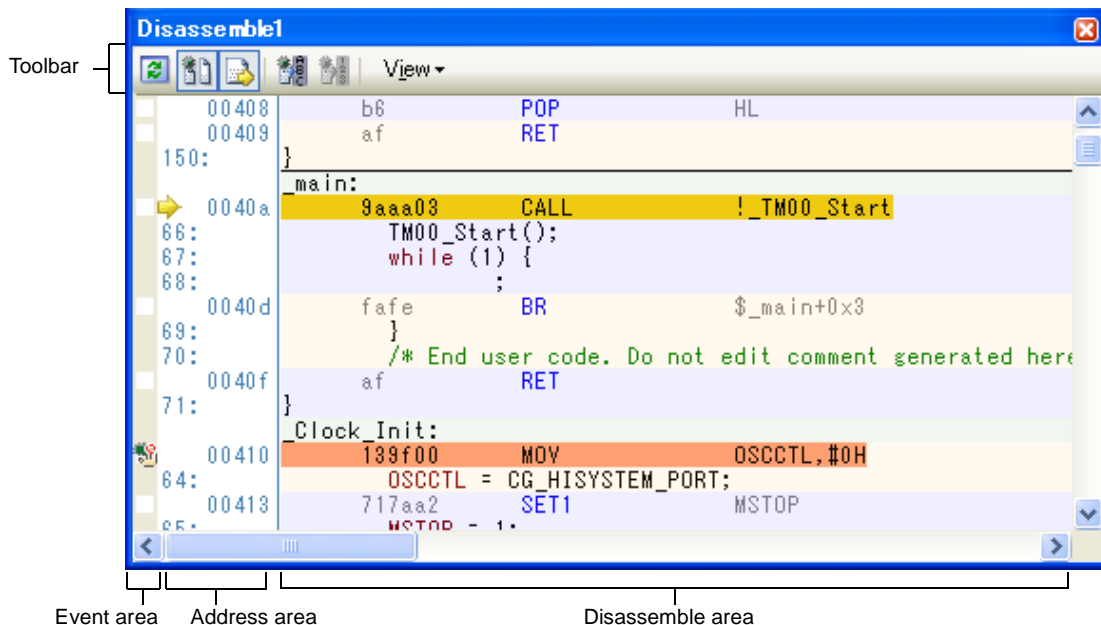

This section describes the following.

- (1) Change display mode
- (2) Change display format
- (3) Move to the specified address
- (4) Move to the symbol defined location
- (5) Save the disassembled text contents

(1) Change display mode

The result of disassembling is displayed in the mixed display mode (both the disassembled text and the source text) by default.





When you click the  button (toggle function) on the toolbar, the source text is displayed or hidden.

Figure 2-52. Display Example of Source Text Hidden

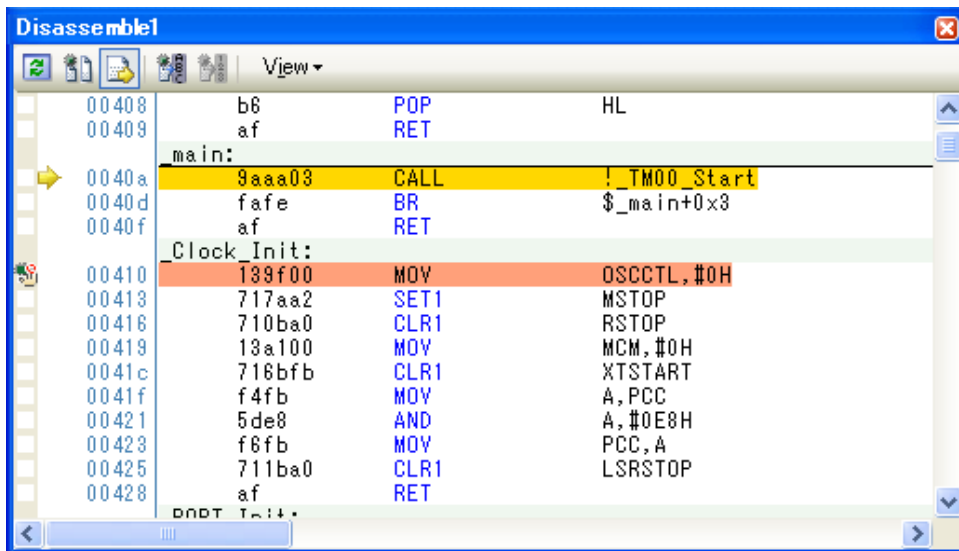

(2) Change display format

The display format of the disassemble area can be changed using buttons below on the toolbar.

View	The following buttons to change the display format are displayed.
	Displays the offset value of the label. The offset value from the nearest label is displayed when a label is defined for the address.
	Displays the address value as the result of disassembling in the format "symbol + offset value" (default). Note that when a symbol has been defined as the address value, only the symbol is displayed.
	Displays the name of the register by its function name (default).
	Displays the name of the register by its absolute name.

(3) Move to the specified address

You can move to the specified address in the disassembled text in the [Go to the Location dialog box](#) opens when selecting [Move to...] from the context menu.

In this dialog box, follow the steps below.

Figure 2-53. Move to the Specified Address in Disassembled Text (Go to the Location Dialog Box)

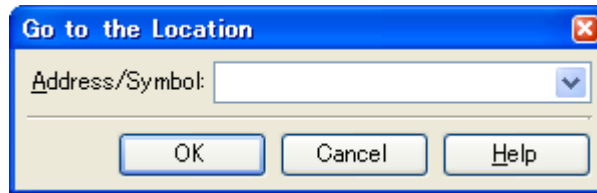
**(a) Specify [Address/Symbol]**

Specify the address you want to move the caret to.

You can either type address expressions directly into the text boxes, or select them from the input history via the drop-down list (up to 10 items).

(b) Click the [OK] button

Caret is moved to the specified address.

(4) Move to the symbol defined location

You can move the caret to the address where the symbol is defined.

Click the  button on the toolbar after moving the caret to the instruction which refers to the symbol.

Furthermore, click the  button on the toolbar following the previous operation returns the caret to the instruction which refers to the symbol at previous caret is defined.

(5) Save the disassembled text contents

Contents of the disassembled text can be saved in text files (*.txt)/CSV files (*.csv).

When saving to the file, the latest information is acquired from the debug tool, and it is saved according with the display format on this panel.

The [Data Save dialog box](#) can be opened by selecting the [File] menu >> [Save Disassemble Data As...] (when this operation is taken place with range selection on the panel, the disassemble data only in the selected range is saved).

In this dialog box, follow the steps below.

Figure 2-54. Save the Disassembled Text Contents (Data Save Dialog Box)

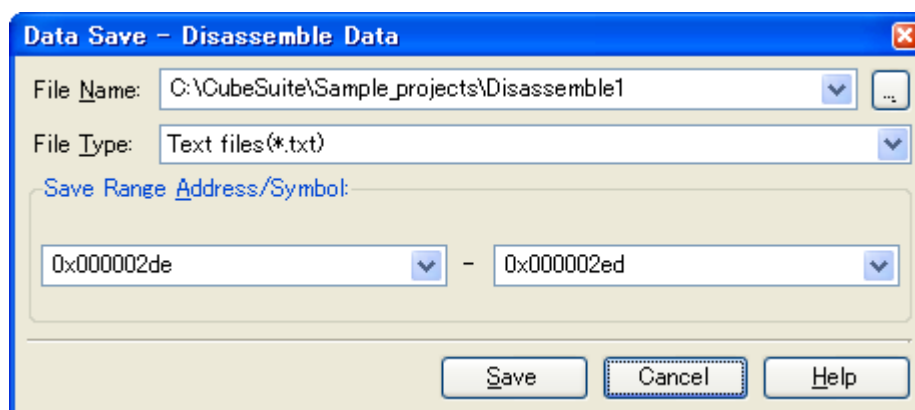
**(a) Specify [File Name]**

Specify the name of the file to save.

You can either type a filename directly into the text box (up to 259 characters), or select one from the input history via the drop-down list (up to 10 items).

You can also specify the file by clicking the [...] button, and selecting a file via the [Select Data Save File dialog box](#).

(b) Specify [File Type]

Select the format in which to save the file from the following drop-down list. The following file formats can be selected.

List Item	Format
Text files (*.txt)	Text format (default)
CSV (Comma-Separated Variables)(*.csv)	CSV format ^{Note}

Note The data is saved with entries separated by commas (,).
If the data contains commas, each entry is surrounded by double quotes "" in order to avoid illegal formatting.

(c) Specify [Save Range Address/Symbol]

Specify the range of addresses to save via "start address" and "end addresses". Directly enter hexadecimal number/address expression in each text box or select from the input history displayed in the drop-down list (up to 10 items).
If a range is selected in the panel, that range is specified as the default. If there is no selection, then the range currently visible in the panel is specified.

(d) Click the [Save] button

Disassembling data is saved in the specified file with the specified format.

Figure 2-55. Output Example of Disassembling Data

Address	Offset	Code	Result of disassembling
-----	-----	-----	-----
Address	Offset	Code	Result of disassembling
:	:	:	:

Remarks 1. The following items are output for data except for lines of the result of disassembling.

Line	Address	Offset	Code	Result of Disassembling
Label (symbol) line	Blank	Label (symbol)	Blank	Blank
Source text line	File name	Line number	Blank	C language source text

- When the contents of the panel are overwritten and saved by selecting [File] menu >> [Save Disassemble Data], the [Disassemble panels](#) (Disassemble1-4) are handled individually for these respectively.
In addition, saving range is same as the previously specified address range.

2.6.3 Run a build in parallel with other operations

CubeSuite has a function that a build is started automatically when one of the following events occurs (rapid build function).

(1) When the target project type is other than a debug-dedicated project

- When a C source file, assembler source file, header file, link directive file, symbol information file, object module file or library file that is being added to the project has been updated
- When a build target file has been added to or removed from the project
- When the link order of object module files and library files has changed
- When any one of properties in the Property panel of the build tool or build target files has been changed

(2) When the target project type is a debug-dedicated project

- When a C source file, assembler source file, or header file that is being added to the debug-dedicated project has been saved after editing
- When a C source file, assembler source file, or header file has been added to or removed from the debug-dedicated project
- When any one of properties in the Property panel of the debug-dedicated project has been changed

If a rapid build is enabled, it is possible to perform a build in parallel with the above operations.

To enable/disable a rapid build, select [Rapid Build] from the [Build] menu. A rapid build is enabled by default.

Caution When an external text editor is used, check the [Observe registered files changing] check box on the [General - Build/Debug] category in the [Option dialog box](#) to enable this function.

- Remarks 1.** After editing source files, it is recommend to save frequently by pressing the [Ctrl] + [S] key.
- 2.** Enabling/disabling a rapid build is set for the entire project (main project and subprojects).
- 3.** If you disable a rapid build while it is running, it will be stopped at that time.

2.6.4 Perform line assembly

Instructions and code displayed in the [Disassemble panel](#) can be edited (line assembly).

This section describes the following.

- (1) [Edit instructions](#)
- (2) [Edit code](#)

(1) Edit instructions

Follow the steps below to edit instructions.

(a) Switch to edit mode

Double-click the instruction to edit or select [Edit Disassemble] from the context menu after moving the caret to the instruction to edit.

(b) Edit instructions

Use keyboard to directly edit the instructions.

(c) Write to memory

Press the [Enter] key to line assemble the edited instructions after editing. The code is automatically written to the memory.

If the edited instruction is invalid, the instruction is shown in red and will not be written to the memory.

If there is a space because of overwriting the displayed result of disassembling by another instruction, its byte number is automatically compensated with NOP instruction as follows:

Examples 1. MOVW instruction (4-byte instruction) in the second line is overwritten by DEC instruction (1-byte instruction).

Before editing	0461CF	ADDW AX, #0CF61H
	CBF820FE	MOVW SP, #0FE20H
	FC8E1800	CALL !!_funcA
	53C0	MOV B, #0C0H
After editing	0461CF	ADDW AX, #0CF61H
	93	DEC B
	00	NOP
	00	NOP
	00	NOP
	FC8E1800	CALL !!_funcA
	53C0	MOV B, #0C0H

2. ADDW instruction (3-byte instruction) in the first line is overwritten by MOVW instruction (4-byte instruction).

Before editing	0461CF	ADDW AX, #0CF61H
	CBF820FE	MOVW SP, #0FE20H
	FC8E1800	CALL !!_funcA
	53C0	MOV B, #0C0H
After editing	CBF820FE	MOVW SP, #0FE20H
	00	NOP
	00	NOP
	00	NOP
	FC8E1800	CALL !!_funcA
	53C0	MOV B, #0C0H

(2) Edit code

Follow the steps below to edit code.

(a) Switch to edit mode

Double-click the code to edit or select [Edit Code] from the context menu after moving the caret to the code to edit.

(b) Edit code

Use keyboard to directly edit the code.

(c) Write to memory

Press the [Enter] key to write the code to the memory after editing.

If the edited instruction is invalid, the instruction is shown in red and will not be written to the memory.

When the code is written to the memory, the result of disassembling is also updated.

2.7 Execute Programs

This section describes how to execute programs.

Main operations in this section are taken place from the debug toolbar in the [Main window](#), where commands to control the execution of programs are included, or from the [Debug] menu.

Caution Items of the debug toolbar and the [Debug] menu are valid only while connecting to the debug tool.

Figure 2-56. Debug Toolbar



Figure 2-57. [Debug] Menu

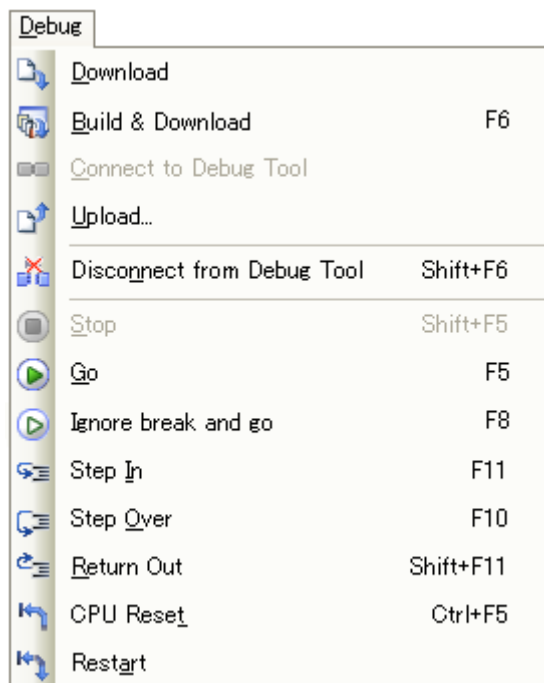

2.7.1 Reset microcontroller (CPU)

To reset CPU, click the  button on the debug toolbar.

When CPU is reset, the current PC value is set to the reset address.

Remark You can automatically overwrite the value of SFR/CPU register with the specified values after CPU reset (see "2.16 Use Hook Function" for details).

2.7.2 Execute programs

The following types of CubeSuite execution functions are provided.

Select any of the following operations according to the purpose of debugging.

See "2.8 Stop Programs (Break)" for details on how to stop the program in execution.

- (1) [Execute after resetting microcontroller \(CPU\)](#)
- (2) [Execute from the current address](#)
- (3) [Execute after changing PC value](#)

Remark You can automatically overwrite the value of SFR/CPU register with the specified values before executing the program (see "2.16 Use Hook Function" for details).

(1) Execute after resetting microcontroller (CPU)

Click the  button on the debug toolbar.

Reset CPU and start execution of the program from the reset address.

When this operation is performed, the program continues executing until either of the following occurs:

- The  button has been clicked (see "2.8.1 Stop the program manually").
- The PC has reached a breakpoint (see "2.8.2 Stop the program at the arbitrary position (breakpoint)").
- A break event condition has been met (see "2.8.3 Stop the program with the access to variables/SFRs").
- A fail-safe break has occurred (see "2.8.4 Stop the program when an invalid execution is detected [IECUBE]").
- The [Other break causes](#) have occurred.

Remark This operation is the same as when the  button is clicked after clicking the  button.

(2) Execute from the current address

Perform any of the following operations to start executing the program from the address at the current PC value.

(a) Normal execution

Click the  button on the debug toolbar.

When this operation is performed, the program continues executing until either of the following occurs:

- The  button has been clicked (see "2.8.1 Stop the program manually").
- The PC has reached a breakpoint (see "2.8.2 Stop the program at the arbitrary position (breakpoint)").
- A break event condition has been met (see "2.8.3 Stop the program with the access to variables/SFRs").
- A fail-safe break has occurred (see "2.8.4 Stop the program when an invalid execution is detected [IECUBE]").
- The [Other break causes](#) have occurred.

(b) Execution ignoring break-related events

Click the  button on the debug toolbar.

When this operation is performed, the program continues executing until either of the following occurs:

- The  button has been clicked (see "2.8.1 Stop the program manually").
- A fail-safe break has occurred (see "2.8.4 Stop the program when an invalid execution is detected [IECUBE]").
- The [Other break causes](#) have occurred.

Remark The action event that is currently set does not occur while the program with this operation is in execution.

(c) Execution to the caret position

To start this operation, move the caret to the line/instruction to stop the program in the [Editor panel/Disassemble panel](#), then select [Go to Here] from the context menu.

When this operation is performed, the program continues executing until either of the following occurs:

- The PC has reached the address of the caret position.
- The  button has been clicked (see "2.8.1 Stop the program manually").

- A fail-safe break has occurred (see "2.8.4 Stop the program when an invalid execution is detected [IECUBE]").
- The Other break causes have occurred.

Caution When the corresponding address of the line at the caret position does not exist, the program is executed to the corresponding address of the lower valid line (if the corresponding address does not exist, an error message will appear).

Remark The action event that is currently set does not occur while the program with this operation is in execution.

(3) Execute after changing PC value

The program is executed after forcibly changing the current PC value to an arbitrary position.

To start this operation, move the caret to the line/instruction to start the program in the Editor panel/Disassemble panel, then select [Set PC to Here] from the context menu (the current PC value is set to the address of the line/instruction where the caret currently exists).

Then execute either one of the execution method described in "(2) Execute from the current address" or "2.7.3 Execute programs in steps".

2.7.3 Execute programs in steps

When either of the following operation is taken place, the program is automatically stopped after step execution in source level units (for one line source text)/in instruction level units (for one instruction).

As contents in each panel are automatically updated by the minute after the program is stopped, the step debugging is effective to debug the transition execution in source level units/instruction units.

An execution unit for step execution is determined automatically by the panel in which the current focus is as follows:

- When the focus is not in the Disassemble panel: Step execution^{Note} in source level units
- When the focus is in the Disassemble panel: Step execution in instruction units

Note If the line information does not exist in the address at the current PC value, the step execution is taken place in instruction units.

The following are types of step execution.

- (1) Step in function (Step in execution)
- (2) Step over function (Step over execution)
- (3) Execute until return is completed (Return out execution)

Cautions 1. Breakpoints, break events, and action events that are being set do not occur during step execution.

2. [IECUBE][MINICUBE2]

Interrupts are not acknowledged and fail-safe breaks do not occur, during step execution. [Simulator]

You may jump to a interrupt handler during step execution.

3. An error message will appear while processing a function prologue or epilogue if the return address cannot be acquired.

(1) Step in function (Step in execution)

When the function is called, the program is stopped at the top of the called function.

Click the  button on the debug toolbar to perform Step in execution.

Caution If Step in execution is performed for the longjmp function, execution processing may not complete and may wait for a time-out.

(2) Step over function (Step over execution)

In the case of a function call by the CALL/CALLT/CALLF instruction, all the source lines/instructions in the function are treated as one step and executed until the position where execution returns from the function (step execution will continue until the same nest is formed as when the CALL /CALLT/CALLF instruction has been executed).

Click the  button on the debug toolbar to perform Step over execution.

In the case of an instruction other than CALL/CALLT/CALLF, operation is the same as when the  button is clicked.

Caution If Step over execution is performed for the longjmp function, execution processing may not complete and may wait for a time-out.

(3) Execute until return is completed (Return out execution)

Execute the current function until the program returns to the original function.

The program returns to the original function without executing the rest of the instructions in the current function when the step execution with this instruction is taken place at the termination of the source lines/instructions execution that need to check in a function.

Click the  button on the debug toolbar to perform Return out execution.

- Cautions**
1. Return out execution cannot be performed within main function (the state of the program becomes "RUN").
 2. Return out execution cannot be performed immediately after stepping in a function.
 3. Return out execution cannot be performed while processing a function prologue or epilogue.
 4. If Return out execution is performed in a function that called the longjmp function, breaks may not occur.
 5. Return out execution cannot be performed immediately after a function return.
 6. If Return out execution is performed in a recursive function, the program will be executed in free-run mode.
 7. If Return out execution is performed in a memory bank function, the program may be executed in free-run mode.

2.8 Stop Programs (Break)

This section describes how to stop the program in execution.

Remark When the program in execution is stopped, a statement of the cause of the break appears on the [Statusbar](#) in the [Main window](#).

2.8.1 Stop the program manually

The program in execution is forcibly stopped by clicking the  button on the debug toolbar.

2.8.2 Stop the program at the arbitrary position (breakpoint)

The program in execution can be stopped at the arbitrary position by setting a breakpoint. You need to configure the type of breakpoints to use before setting a breakpoint. This section describes the following.

- (1) [Configure types/movements of breakpoints to use](#)
- (2) [Set a breakpoint](#)
- (3) [Delete a breakpoint](#)

(1) Configure types/movements of breakpoints to use

Breakpoints to use are set in the [Break] category in the [\[Debug Tool Settings\] tab](#) of the [Property panel](#). The setting method differs depending on the debug tool used.

- (a) [\[IECUBE\]\[MINICUBE2\]\[MINICUBE2\]](#)
- (b) [\[Simulator\]](#)

(a) [\[IECUBE\]\[MINICUBE2\]\[MINICUBE2\]](#)

Figure 2-58. [Break] Category [\[IECUBE\]\[MINICUBE2\]\[MINICUBE2\]](#)



Specify the types of the breakpoint to use with priority (breakpoint that can be set with one-click operation of the mouse) in the [First using type of breakpoint] property.

Note, however, that if the number of the set breakpoints of the specified type exceeds the limit settable, a breakpoint of another type will be used (see "").

Select from the drop-down list below for each use of the breakpoint.

Software break	Temporary insert the instruction for the break right before/after the code at the specified address and stop the program (default). This breakpoint is handled as a Software Break event.
Hardware break	The debug tool checks the execution of the code at the address specified while the program in execution by the minute and stop the program when it is executed ^{Note} . This breakpoint is handled as a Hardware Break event (execution).

Note There are two types of Hardware Break event: "before execution break," which breaks before the instruction at the specified address is executed; and "after execution break," which breaks after the instruction at the specified address is executed. Both of these break types are implemented using the

debug tool's resources.

CubeSuite starts by using "before execution break" resource to set hardware breakpoints, and as soon as that resource becomes unavailable, uses "after execution break" resource (see "(1) [Maximum number of enabled events](#)"). For this reason, the user cannot select between "before" and "after" execution.

(b) [Simulator]

Figure 2-59. [Break] Category [Simulator]

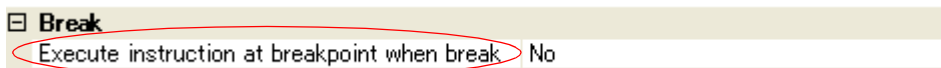

You can specify the timing to stop the program execution by breakpoints whether after or before the execution of the instruction at the breakpoint. Specify in the [Execution instruction at breakpoint when break] property whether to break after executing the instruction.

Select [Yes] to break after execution of the instruction ([No] is selected by default).

All set breakpoints are handled as Hardware Break events.

Caution When [Yes] is selected, all of action events currently being set are handled as Hardware Break events (see "2.14 [Set an Action into Programs](#)").

(2) Set a breakpoint

Perform this operation in the [Editor panel/Disassemble panel](#) in which the source text/disassembly text is displayed.

In the panel's event area, click on the location where you want to set a breakpoint.

A breakpoint is set to the instruction at the start address corresponding to the clicked line.

When a breakpoint is set, the following event mark appears at the breakpoint location, and the source text line/ disassembled text line is highlighted.

It is interpreted as if a break event (Software or Hardware Break event) has been set at the target address, and it is managed in the [Events panel](#) (see "2.15 [Manage Events](#)" for details).

Table 2-4. Event Marks of the Breakpoint

Event Type	Event Mark
Software Break [IECUBE][MINICUBE2]	
Hardware Break	

Figure 2-60. Breakpoint Setting Example

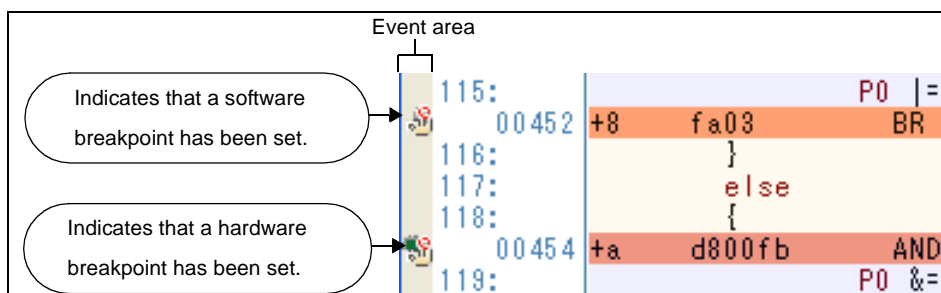

- Cautions 1.** Also see "2.15.6 Notes for setting events" for details on breakpoints (e.g. limits on the number of enabled events).
- 2.** Breakpoints cannot be set at lines in the event area with the background color in gray (showing to the corresponding address of the line that no change is allowed).

Settable line →	135 : 0042e	+67	f c8a0100	CALL	!!_SCK_STRT
No-settable line →	136 : 137 :			SCK_STRT();	

Remarks 1. Event marks differ depending on the event state (see "2.15.1 Change the state of set events (valid/invalid)").

When an event is set at the point which other event is already set, the event mark (🔒) is displayed meaning more than one event is set at the point.

- 2. [Simulator]**
The type of breakpoint that can be set is locked to hardware breakpoints.
- 3. [IECUBE][MINICUBE2]**
You can set hardware breakpoints/software breakpoints without depending on the specification of "(1) Configure types/movements of breakpoints to use" by following the step below.

Type	Operation1	Operation2
Hardware breakpoint	[Ctrl] + mouse click	Select [Break Settings] >> [Set Hardware Break] from the context menu.
Software breakpoint	[Shift] + mouse click	Select [Break Settings] >> [Set Software Break] from the context menu.

(3) Delete a breakpoint

Click event marks displayed in the Editor panel/Disassemble panel to delete set breakpoints.

2.8.3 Stop the program with the access to variables/SFRs

By setting a break event with the access, the program can be stopped when an arbitrary variable or SFR is accessed with the specified type.

You can also limit the accessed value.

The following types can be specified with the access.

Table 2-5. Types of Accesses to Variables

Access Type	Description
Read	The program is stopped with the read access to (after reading) the specified variable/SFR.
Write	The program is stopped with the write access to (after writing) the specified variable/SFR.
Read/Write	The program is stopped with the read access/write access to (after reading or writing) the specified variable/SFR.

This section describes the following.

- (1) Set a break event to a variable/SFR
- (2) Delete a break event

(1) Set a break event to a variable/SFR

Follow the steps below to set a break event to stop programs with the access to a variable/SFR.

- Cautions 1. Also see "2.15.6 Notes for setting events" for details on breakpoints (e.g. limits on the number of enabled events).
- 2. The access break events described here cannot be set for 32-bit (4-byte) variables. Additionally, accessing a single byte of a 16-bit (2-byte) variable will not be detected as an access.

(a) **Set a break event to a variable/SFR in the source text/disassembled text**

Perform this operation in the [Editor panel/Disassemble panel](#) in which the source text/disassembled text is displayed.

Follow the operation listed below from the context menu after selecting an arbitrary variable or SFR in the source text/disassembled text. Note, however, that only global variables, static variables inside functions, and file-internal static variables can be used.

By performing the following operation, it is interpreted as if a Hardware Break event (access) has been set at the target variable/SFR, and it is managed in the [Events panel](#) (see "2.15 Manage Events" for details).

Access Type	Operation
Read	Select [Break Settings] >> [Set Read Break to], and then press the [Enter] key. Break occurs when the variable/SFR is read with the specified value while a value is specified in the text box in the menu. If values are not specified, break occurs when the selected variable/SFR is read regardless of its value.
Write	Select [Break Settings] >> [Set Writ Break to], and then press the [Enter] key. Break occurs when the variable/SFR is written with the specified value while a value is specified in the text box in the menu. If values are not specified, break occurs when the selected variable/SFR is written regardless of its value.
Read/Write	Select [Break Settings] >> [Set R/W Break to], and then press the [Enter] key. Break occurs when the variable/SFR is read/written with the specified value while a value is specified in the text box in the menu. If values are not specified, break occurs when the selected variable/SFR is read/written regardless of its value.

- Cautions 1. Variables within the current scope can be specified.
- 2. Break events cannot be set to variables/SFR on lines in the event area with the background color in gray (showing to the corresponding address of the line that no change is allowed). Set the break event to a variable/SFR on the line in the event area with background color in white.

Figure 2-61. Example of Setting a Break Event on a Variable in the Source Text

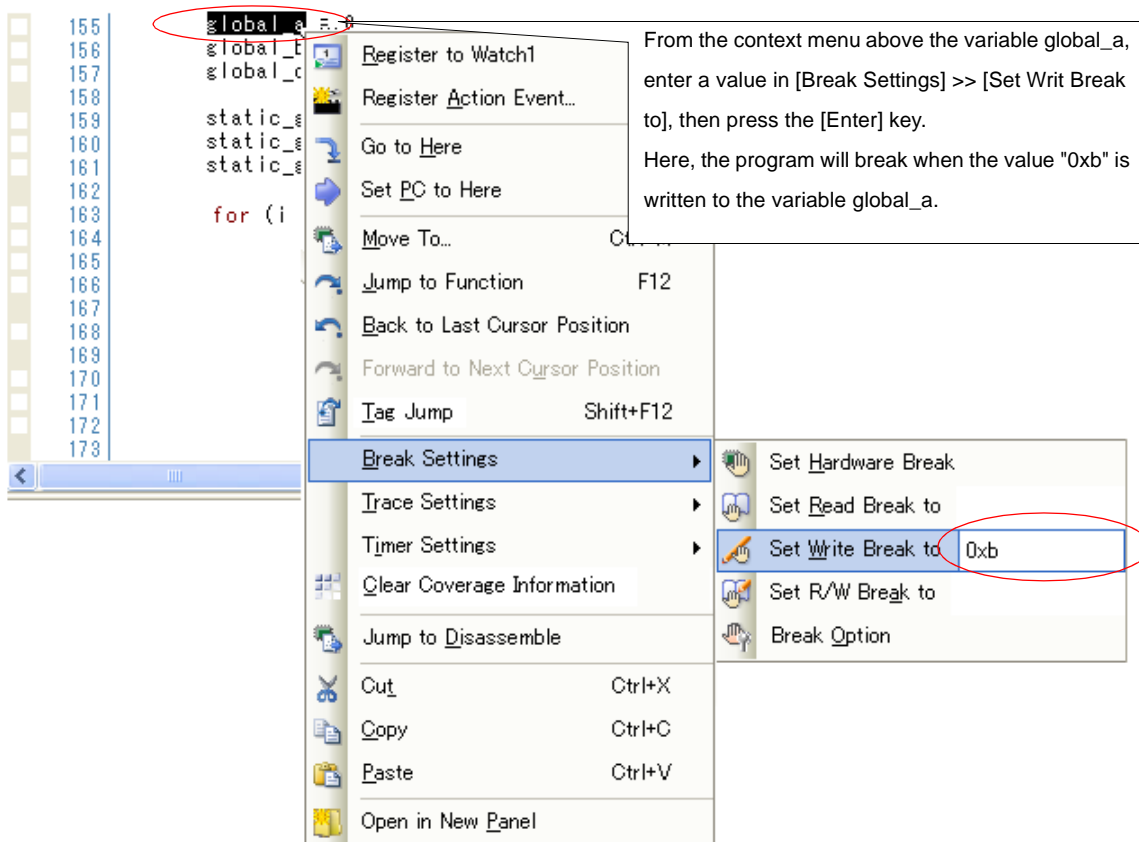

(b) Set a break event to a registered watch-expression

You can set break events in the [Watch panel](#).

Follow the operation listed below from the context menu after selecting the registered watch-expression.

Note, however, that only global variables, static variables inside functions, file-internal static variables, and SFR can be used.

By performing the following operation, it is interpreted as if a Hardware Break event (access) has been set at the target watch-expression, and it is managed in the [Events panel](#) (see "2.15 Manage Events" for details).

Access Type	Operation
Read	Select [Access Break] >> [Set Read Break to], and then press the [Enter] key. Break occurs when the watch-expression is read with the specified value while a value is specified in the text box in the menu. If values are not specified, break occurs when the selected watch-expression is read regardless of its value.
Write	Select [Access Break] >> [Set Writ Break to], and then press the [Enter] key. Break occurs when the watch-expression is written with the specified value while a value is specified in the text box in the menu. If values are not specified, break occurs when the selected watch-expression is written regardless of its value.
Read/Write	Select [Access Break] >> [Set R/W Break to], and then press the [Enter] key. Break occurs when the watch-expression is read/written with the specified value while a value is specified in the text box in the menu. If values are not specified, break occurs when the selected watch-expression is read/written regardless of its value.

Remark A watch-expression within the current scope can be specified.
To target a watch-expression outside the current scope, select a watch-expression with a specified scope.

Figure 2-62. Example of Setting a Break Event on a Watch-Expression

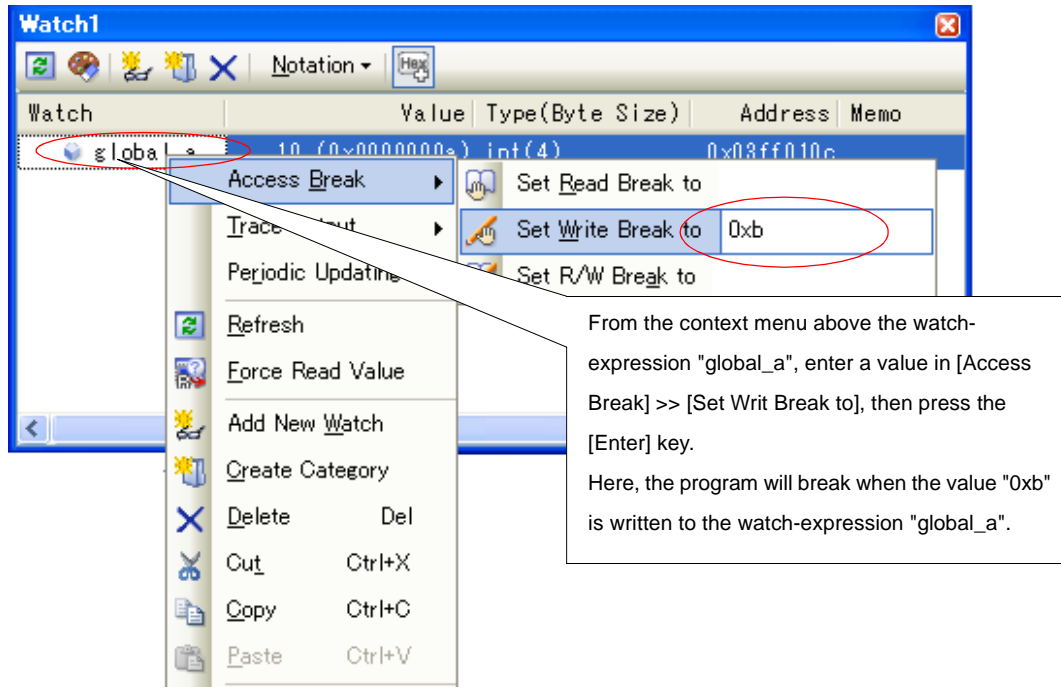

(2) Delete a break event

To delete break events, select the event name to delete in the [Events panel](#) opened when selecting the [View] menu >> [Event], then press the  button in the toolbar in the same panel (see "[2.15 Manage Events](#)").

2.8.4 Stop the program when an invalid execution is detected [IECUBE]

The system forcibly breaks the program execution when unexpected program behavior such as invalid access to internal ROM/internal RAM/SFR/external memory is detected (fail-safe break function).

This function has various break conditions. Enable/disable each break condition in the [Fail-safe Break] category in the [\[Debug Tool Settings\] tab](#) of the [Property panel](#).

Figure 2-63. [Fail-safe Break] Category

☐ Fail-safe Break	
Stop when retry over	Yes
Stop when fetched from fetch protected area	Yes
Stop when read from read protected area	Yes
Stop when wrote to write protected area	Yes
Stop when access to not-exist SFR	Yes
Stop when read from read protected SFR	Yes
Stop when wrote to write protected SFR	Yes
Stop when IMS / IXS / BANK register specification error occur	Yes
Stop when overflowed user stack	No
User stack top address	@STEND
Stop when underflowed user stack	No
User stack bottom address	@STBEG
Stop when read from uninitialized RAM	Yes
Stop when accessed to non-mapping area	Yes
Stop when operated uninitialized stack pointer	Yes
Stop when received fail safe from peripheral	Yes

In the following property setting, select [Yes] to enable and [No] to disable the function from the drop-down list. All the properties are set to [Yes] by default (with some exceptions).

- [Stop when retry over]
- [Stop when fetched from fetch protected area]
- [Stop when read from read protected area]
- [Stop when wrote to write protected area]
- [Stop when access to not-exist SFR]
- [Stop when read from read protected SFR]
- [Stop when wrote to write protected SFR]
- [Stop when IMS / IXS / BANK register specification error occur]
- [Stop when overflowed user stack]^{Note 1}
- [Stop when underflowed user stack]^{Note 2}
- [Stop when read from uninitialized RAM]
- [Stop when accessed to non-mapping area]
- [Stop when read from uninitialized RAM]
- [Stop when received fail safe from peripheral]

Notes 1. [No] is selected by default.

To set to [Yes], the [User stack top address] property on the bottom must be set to the top address of the user stack ([@STEND] is specified by default).

2. [No] is selected by default.

To set to [Yes], the [User stack bottom address] property on the bottom must be set to the end address of the user stack ([@STBEG] is specified by default).

2.8.5 Other break causes

The cause of the break other than the described above is as follows:

Moreover, you can confirm the break cause on the [Statusbar](#) in the [Main window](#).

Table 2-6. Break Cause (Other Than the Above)

Break Cause	Debug Tool to Use		
	IECUBE	MINICUBE2	Simulator
Full of the trace memory ^{Note 1}	✓	-	✓
An occurrence of Trace Delay Break	✓	-	-
An occurrence of Timer Over Break ^{Note 2}	✓	-	-
An access to non-mapped area	✓	-	✓
A writing to write protected area	✓	-	✓
An occurrence of Temporary Break	✓	✓	✓
An occurrence of Flash Illegal Break	✓	-	-
Illegal action of program related to the peripheral chip function ^{Note 3}	✓	-	-
Failure to execute/uncertain cause	✓	✓	-

Notes 1. The operation depends on the setting of the [Operation after trace memory is full] property in the [Trace] category on the [\[Debug Tool Settings\] tab](#) of the [Property panel](#).

2. See "[2.12.3 Measurable time ranges](#)".

3. See the documentation on peripheral emulation board to use.

2.9 Display/Change the Memory, Register and Variable

This section describes how to display/change the memory, register and variable.

2.9.1 Display/change the memory

The contents of the memory can be displayed and its values can be changed in the [Memory panel](#) below.

Select the [View] menu >> [Memory] >> [Memory 1 - 4].

The maximum of 4 Memory panels can be opened. Each panel is identified by the names "Memory1", "Memory2", "Memory3" and "Memory4" on the title bar.

For details on the contents and function in each area, see the section for the [Memory panel](#).

Figure 2-64. Display the Contents of the Memory (Memory Panel)

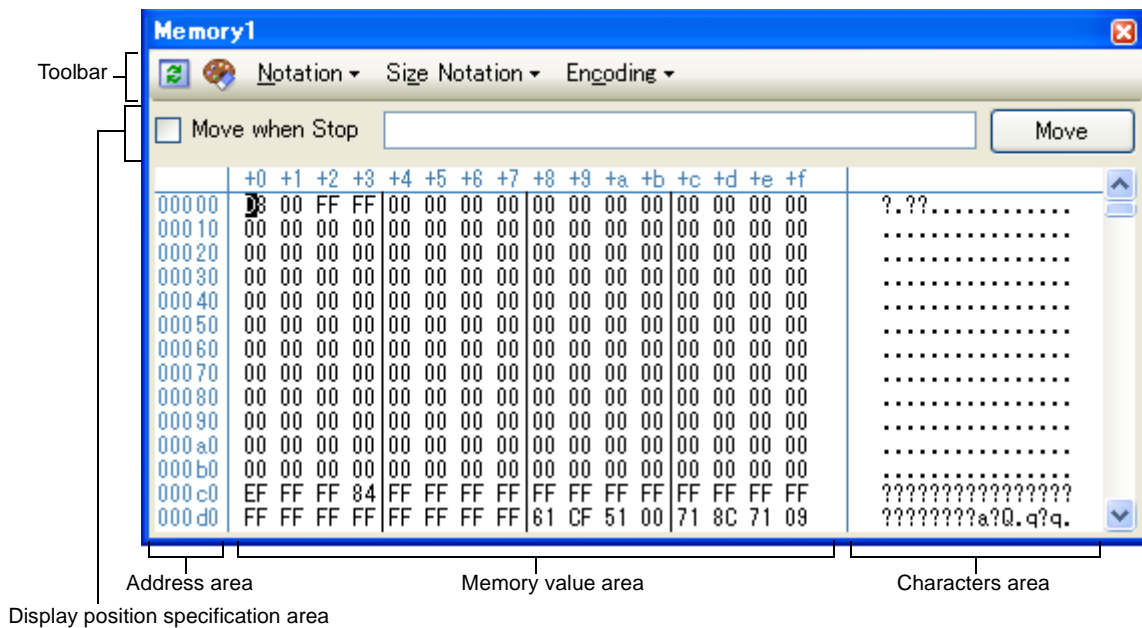

This section describes the following.

- (1) Specify the display position
- (2) Change display format of values
- (3) Modify the memory contents
- (4) Display/modify the memory contents during program execution
- (5) Search the memory contents
- (6) Modify the memory contents in batch (initialize)
- (7) Save the memory contents

(1) Specify the display position

It is possible to specify the display start position of the memory contents by specifying an address expression in the display position specification area (starting with address "0" by default).

Figure 2-65. Display Position Specification Area (Memory Panel)

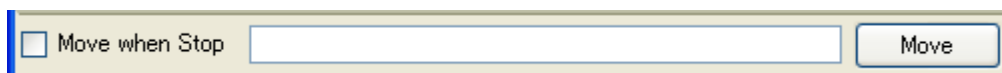

(a) Specify an address expression

Directly enter the address expression of the memory value address to display in the text box. You can specify an input expression with up to 1024 characters. The result of the expression is treated as the display start position address.

Note that if an address value greater than the microcontroller address space is specified, the upper address value is masked.

An address value greater than the value expressed within 32 bits cannot be specified.

(b) Specify automatic/manual evaluation of the address expression

The timing to change the display start position can be determined by specifying in the [Move when Stop] check box and the [Move] button.















[Move when Stop]	<input checked="" type="checkbox"/>	The caret is moved to the address which is automatically calculated from the address expression after the program is stopped.
	<input type="checkbox"/>	The address expression is not automatically evaluated after the program is stopped. Click the [Move] button to manually evaluate the address expression.
[Move]		When the [Move when Stop] check box is not checked, click this button to evaluate the address expression and move the caret to the result address of the evaluation.

Remark If the specified address expression is the symbol and its size can be recognized, everything from the start address to the end address of that symbol is displayed selected.

(2) Change display format of values

The display format of the memory value area/character string area can be changed using buttons below on the toolbar.

Note that the button is invalid while program is executed.

Notation	The following buttons to change the notation of memory values are displayed.	
	Displays memory values in hexadecimal number (default).	
	Displays memory values in signed decimal number.	
	Displays memory values in unsigned decimal number.	
	Displays memory values in octal number.	
	Displays memory values in binary number.	
Size Notation	The following buttons to change the notation of sizes of memory values are displayed.	
	Displays memory values in 4-bit width.	
	Displays memory values in 8-bit width (default).	
	Displays memory values in 16-bit width.	
	Displays memory values in 32-bit width.	
	Displays memory values in 64-bit width.	
Encoding	The following buttons to change the encoding of character strings are displayed.	
	Displays character strings in ASCII code (default).	
	Displays character strings in Shift_JIS code.	
	Displays character strings in EUC-JP code.	
	Displays character strings in UTF-8 code.	

(3) Modify the memory contents

The memory values can be edited.

Directly edit from the keyboard after moving the caret to the line to modify in memory value area/characters area.

The color of the memory value changes when it is in editing. Press the [Enter] key to write the edited value to the target memory (if the [Esc] key is pressed before the [Enter] key is pressed, the editing is cancelled).

However, the character string that can be inputted during the editing is limited to that character string that can be handled by the display notation that has been currently specified. In the characters string area, modification can only be made with "ASCII" character code.

Remark This operation can be taken place while the program is in execution. See "(4) Display/modify the memory contents during program execution" for details on how to operate it.

When you modify the values, be aware of the following examples.

Examples 1. The value exceeds the upper limit of the display bit wide

If you edit the display value "105" as "1" to "3" in the decimal 8-bit display, the value will be changed to the upper limit of "127".

2. The symbol, "-" is entered between numbers

If you edit the display value "32768" as "32-68" with signed decimal 16-bit display, "3" and "2" are changed to the blank and the value is changed to "-68".

3. The blank symbol (space) is entered between numbers

If you edit the display value "32767" as "32 67", "3" and "2" are changed to the blank and the value is changed to "67".

4. The same value is entered

Even if the same value as the current memory value is specified, the specified value is written to the memory.

(4) Display/modify the memory contents during program execution

The [Memory panel/Watch panel](#) has the real-time display update function that can update/modify the display contents of the memory/watch-expression in real-time while executing the program (this function is implemented using the debug tool's RRM (Real-time RAM Monitor) function and DMM (Dynamic Memory Modification) function). Using the real-time display update function enables to display/modify the value of memory/watch-expression not only while the program is stopped, but also in execution.

The target range where the values can be read/modified using the real-time display update function differs depending on the debug tool and the settings of the [Property panel](#).

Based on the following settings of properties in the [Access memory while running] category on the [\[Debug Tool Settings\] tab](#) of the [Property panel](#), configure "Table 2-7."/"Table 2-8." in accordance with the debugging purpose.

Mark	Properties in [Access memory while running] Category	Setting Value	Note
A	[Update display during the execution]	[Yes] (default)	
	[Display update interval[ms]]	[Integer number between 100 and 65500]	Rounding up the fractions less than 100 ms
B	[Access by stopping execution]	[Yes]	[IECUBE][MINICUBE2]
C	[Set update display during the execution automatically]	[Yes] (default)	[MINICUBE2]

Table 2-7. Target Range for Real-Time Display Update Function (Reading)

Area	IECUBE		MINICUBE2		Simulator	
	Setting	RRM Target Range	Setting	RRM Target Range	Setting	RRM Target Range
Internal ROM	A	Entire range	A+B+C	Automatically determined range ^{Note}	A	Entire range
Internal bank ROM	A	Entire range	Impossible		A	Entire range
Internal RAM	A	Entire range, except below - Internal buffer RAM - Register area	A+B+C	Automatically determined range ^{Note} (except register area)	A	Entire range, except below - Internal buffer RAM - Register area
Emulation memory	A	Emulation ROM	Impossible		A	Entire range
Target memory	A+B	Entire range			A	Entire range
CPU register	A	General-purpose registers			A	Entire range
	A+B	Entire range				
SFR	A+B	Entire range			A	Entire range
Data flash	Impossible		Impossible		Impossible	

Note [MINICUBE2]

The target range for the RRM function (the area where the values can be obtained using the real-time display update function in the [Memory panel/Watch panel](#)) are limited to up to 8 locations within 16 bytes. Therefore, in CubeSuite, it follows the determination rule (priority order) below and determines the target of the real-time display update within the above limitation (the panel displayed in front right before the program execution is the only target).

- (1) Ascending order of watch-expressions listed in the [Watch panel](#) (if more than one panel is opened, the smallest in number is configured first).
- (2) Ascending order of the addresses listed in the [Memory panel](#) (if more than one memory panel is opened, the smallest in number is configured first).

Note that when a read-protected area is included in this target range, the display contents of the area are not updated.

Table 2-8. Target Range for Real-Time Display Update Function (Modifying)

Area	IECUBE		MINICUBE2		Simulator	
	Setting	DMM Target Range	Setting	DMM Target Range	Setting	DMM Target Range
Internal ROM	A	Entire range	Impossible		A	Entire range
Internal bank ROM	A	Entire range	A+B	Entire range	A	Entire range
Internal RAM	A	Entire range, except below - Register area	A+B	Entire range, except below - Register area	A	Entire range, except below - Register area

Area	IECUBE		MINICUBE2		Simulator	
	Setting	DMM Target Range	Setting	DMM Target Range	Setting	DMM Target Range
Emulation memory	A	Entire range	Impossible		A	Entire range
Target memory	A+B	Entire range			A	Entire range
CPU register	A	Entire range			A	Entire range
SFR	A+B	Entire range			A	Entire range
Data flash	Impossible				Impossible	

- Cautions 1.** If CPU status shifts to the HALT/STOP/IDLE mode, a monitor time-out error will occur.
2. Local variables are not subject to the real-time display update function.

Remark See "(3) Modify the memory contents" or "(6) Modify the contents of watch-expressions" for details on how to modify values in the [Memory panel/Watch panel](#).

Values of memory/watch-expression for which the real-time display update function is being operated are highlighted as follows (character colors and background colors depend on the configuration in the [\[General - Font and Color\]](#) category of the [Option dialog box](#)):

Figure 2-66. Example of Memory Values where the Real-time Display Update Function Is Being Operated

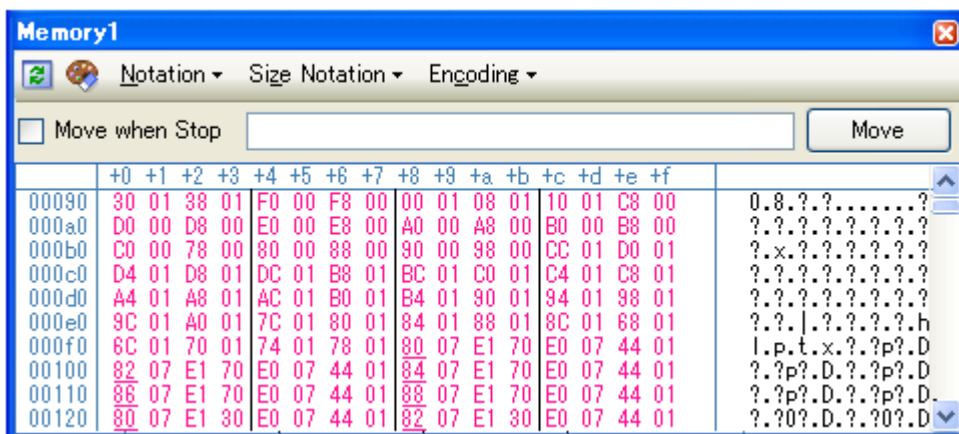

(5) Search the memory contents

Values of memory can be searched in the [Memory Search dialog box](#) opened by selecting [Find...] from the context menu. The search is operated either in the memory value area or characters string area, in which a caret is. In this dialog box, follow the steps below.

Figure 2-67. Search the Memory Contents (Memory Search Dialog Box)

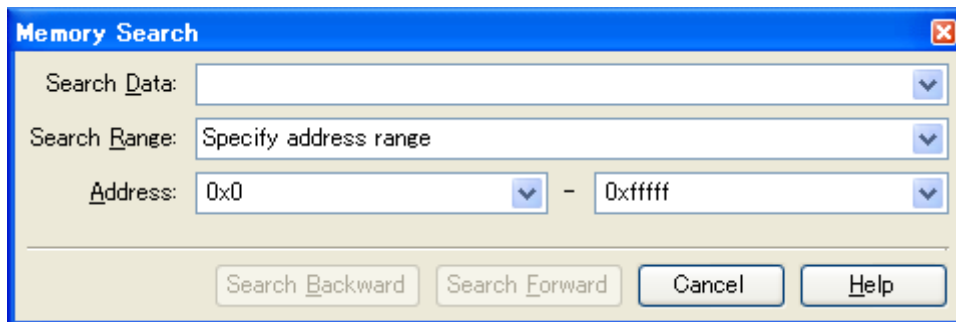

Caution Search for the contents of the memory cannot be performed while executing the program.

(a) Specify [Search Data]

Specify data to search.

You can either type a value directly into the text box (up to 256 bytes), or select one from the input history via the drop-down list (up to 10 items).

If the search is performed in the memory value area, the value must be entered in the same display format (notation and size) as that area.

If the search is performed in the character string area, then the target of the search must be a string. The specified string is converted into the encoding format displayed in that area, and searched for.

If a memory value was selected immediately prior to opening this dialog box, then that value will appear as default.

(b) Specify [Search Range]

Select the range to search from the following drop-down list.

Specify address range	Searches in the address range specified in the [Address] area.
<i>Memory mapping</i>	Searches within the selected memory mapping range. This list item displays individual memory mapping configured in the Memory Mapping dialog box (except the non-mapped area). Display format: <memory type> <address range> <size>

(c) Specify [Address]

This item is only enabled if [Specify address range] is selected in the **(b) Specify [Search Range]**.

Specify the range of memory address to search via the start and end addresses. You can either type address expressions directly into the text boxes (up to 1024 characters), or select them from the input history via the drop-down list (up to 10 items).

The results of calculating the address expressions you have entered are treated as start and end addresses, respectively.

Note that if an address value^{Note} greater than the microcontroller address space is specified, the upper address value is masked.

An address value greater than the value expressed within 32 bits cannot be specified.

Note When the selected microcontroller has a built-in memory bank, only the bank area (0xN8000 - 0xNBFFF) can be searched.,in the address range larger than 0x10000.

Remarks 1. If the start address field is left blank, it is treated as if "0x0" were specified.

2. If the end address field is left blank, then it is treated as if the maximum value in the microcontroller's address space were specified.

(d) Click the [Search Backward]/[Search Forward] button

When the [Search Backward] button is clicked, search is taken place in the order from the large address number to small and the search results are displayed selected in the [Memory panel](#).

When the [Search Forward] button is clicked, search is taken place in the order from the small address number to small and the search results are displayed selected in the Memory panel.

(6) Modify the memory contents in batch (initialize)

Contents of the memory can be modified in batch (initialize).

When [Fill...] from the context menu is selected, the [Memory Initialize dialog box](#) opens to modify the memory value of the specified address range in batch.

In this dialog box, follow the steps below.

Figure 2-68. Modify the Memory Contents in Batch (Memory Initialize Dialog Box)

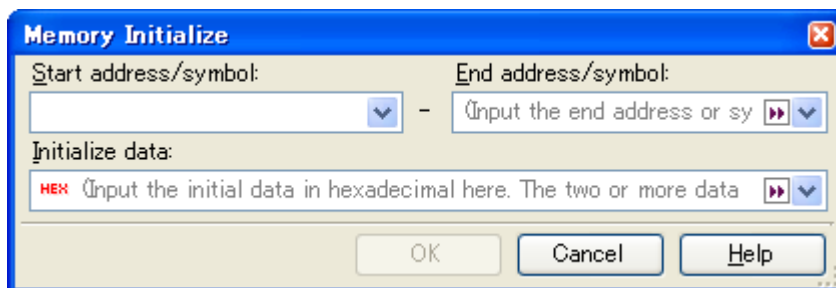

(a) Specify [Start address/symbol] and [End address/symbol]

Specify the range of memory address to initialize via the [Start address/symbol] and [End address/symbol]. You can either type address expressions directly into the text boxes (up to 1024 characters), or select them from the input history via the drop-down list (up to 10 items).

The results of calculating the address expressions you have entered are treated as start and end addresses, respectively.

Note that address values greater than the microcontroller address space cannot be specified.

(b) Specify [Initialize data]

Specify the initializing data to write to the memory.

You can either type the initial value into the text box directly in hexadecimal number (the value need not start with "0x"), or select one from the input history via the drop-down list (up to 10 items).

You can specify more than one initial value. Specify up to 16 values of up to 4 bytes (8 characters) each, separated by spaces.

Each initial data value is parsed from the end of the string, with each two characters interpreted as a byte. If the string has an odd number of characters, then the first character is interpreted as one byte.

Example Endianness specified by debug tool is little endian

Input Character String (Initialization Data)	How Data is Overwritten (in Bytes)
1	01
0 12	00 12
00 012 345	00 12 00 45 03

Input Character String (Initialization Data)	How Data is Overwritten (in Bytes)
000 12 000345	00 00 12 45 03 00

(c) Click the [OK] button

Click the [OK] button.

The memory area in the specified address range is repeatedly overwritten with the specified initial data pattern. If the end address is reached in the middle of the pattern, then writing ends at that point.

Note that if an illegal value is specified, a message will be appear, and the memory value will not be initialized.

(7) Save the memory contents

Contents of the memory can be saved with range selection in text files (*.txt)/CSV files (*.csv).

When saving to the file, the latest information is acquired from the debug tool, and it is saved according with the display format on this panel.

The [Data Save dialog box](#) can be opened by selecting the [File] menu >> [Save Memory Data As...] (when this operation is taken place with range selection on the panel, the memory data only in the selected range is saved).

In this dialog box, follow the steps below.

Figure 2-69. Save the Memory Data (Data Save Dialog Box)

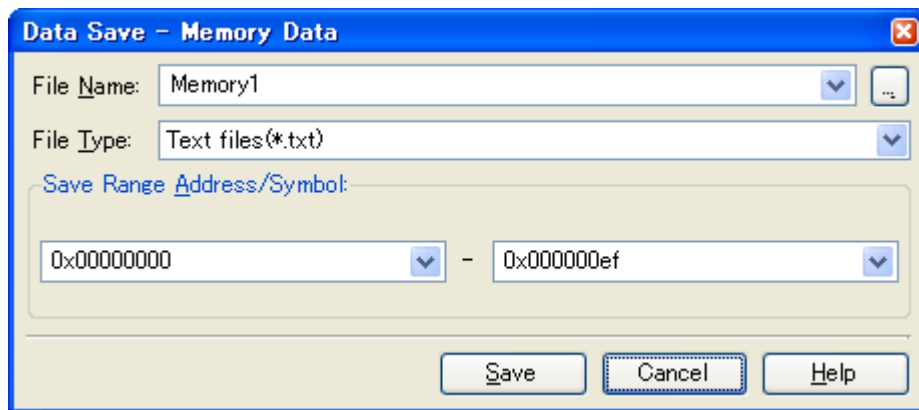

(a) Specify [File Name]

Specify the name of the file to save.

You can either type a filename directly into the text box (up to 259 characters), or select one from the input history via the drop-down list (up to 10 items).

You can also specify the file by clicking the [...] button, and selecting a file via the [Select Data Save File dialog box](#).

(b) Specify [File Type]

Select the format in which to save the file from the following drop-down list.

The following file formats can be selected.

List Item	Format
Text files (*.txt)	Text format (default)
CSV (Comma-Separated Variables)(*.csv)	CSV format ^{Note}

Note The data is saved with entries separated by commas (.).
 If the data contains commas, each entry is surrounded by double quotes "" in order to avoid illegal formatting.

(c) Specify [Save Range Address/Symbol]

Specify the range of addresses to save via "start address" and "end addresses".
 Directly enter hexadecimal number/address expression in each text box or select from the input history displayed in the drop-down list (up to 10 items).
 If a range is selected in the panel, that range is specified as the default. If there is no selection, then the range currently visible in the panel is specified.

(d) Click the [Save] button

Saves the memory data to a file with the specified filename, in the specified format.

Figure 2-70. Output Example of the Memory Data

[Text files (*.txt)]

(Hexadecimal notation/8-bit width/ASCII code)

	+0,	+1,	+2,	+3,	+4,	+5,	+6,	+7,	+8,	+9,	a,	b,	c,	d,	e,	f,	A,	B,	C,	D,	E,	F	
0000		00	00	00	00	00	00	00	00	00	00	00	00	00	00	00	00	00	00	00	00	00	00
0010		11	11	11	11	11	11	11	11	11	11	11	11	11	11	11	11	11	11	11	11	11	11

[CSV files (*.csv)]

(Hexadecimal notation/8-bit width/ASCII code)

0000,	00,	00,	00,	00,	00,	00,	00,	00,	00,	00,	00,	00,	00,	00,	00,	00,	00,	00,	00,	00,	00,	00,
0010,	11,	11,	11,	11,	11,	11,	11,	11,	11,	11,	11,	11,	11,	11,	11,	11,	11,	11,	11,	11,	11,	11,

Remark When the contents of the panel are overwritten with selecting the [File] menu>> [Save Memory Data], each Memory panel (Memory1-4) is treated as a different panel.
 In addition, saving range is same as the previously specified address range.

2.9.2 Display/change the CPU register

The contents of the CPU register (general-purpose register/control register) can be shown and the value can be changed in the [CPU Register panel](#) below.

Select the [View] menu >> [CPU Register].

For details on the contents and function in each area, see the section for the [CPU Register panel](#).

Figure 2-71. Display the Contents of the CPU Register (CPU Register Panel)

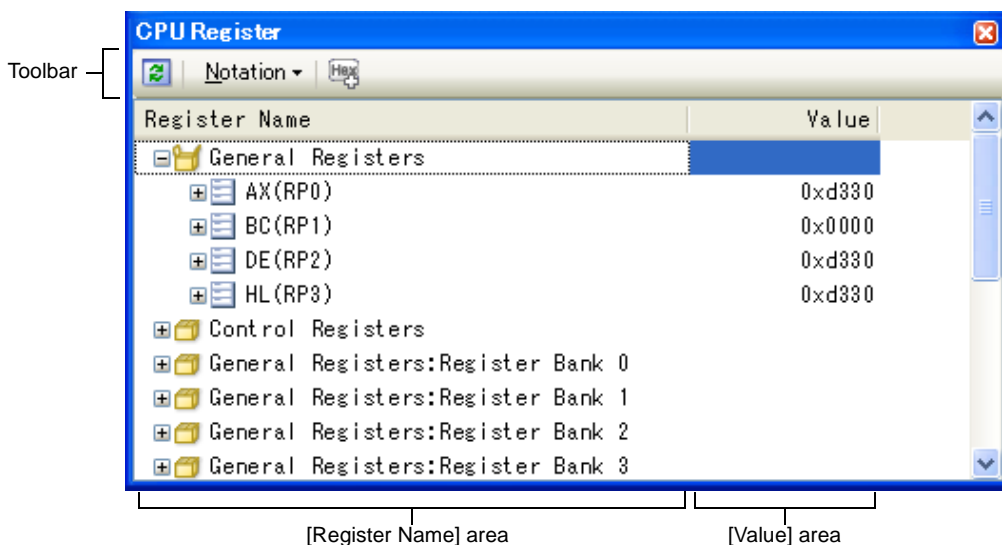

This section describes the following.

- (1) [Change display format of values](#)
- (2) [Modify the CPU register contents](#)
- (3) [Display/modify the CPU register contents during program execution](#)
- (4) [Save the CPU register contents](#)

(1) Change display format of values

The display format of the [value] area can be changed using buttons below on the toolbar.

Notation	The following buttons to change the notation of a data value are displayed.
	Displays the value of the selected item (including sub-items) in the default notation (default).
	Displays the value of the selected item (including sub-items) in hexadecimal number.
	Displays the value of the selected item (including sub-items) in signed decimal number.
	Displays the value of the selected item (including sub-items) in unsigned decimal number.
	Displays the value of the selected item (including sub-items) in octal number.
	Displays the value of the selected item (including sub-items) in binary number.
	Displays the character string of the selected item (including sub-items) in ASCII code. If the character size is 2 bytes and above, it is displayed with the characters for each 1 byte arranged side-by-side.
	Displays the value of the selected item in Float. Note that when the value is not 4-byte data, displays it in the default notation.
	Displays the value of the selected item in Double. Note that when the value is not 8-byte data, displays it in the default notation.
	Adds the value in hexadecimal number enclosing with "()" at the end of the value.

(2) Modify the CPU register contents

The CPU register values can be edited.

Double-click the value of the CPU register to edit in the [Value] area to switch the value to edit mode (press the [Esc] key to cancel the edit mode).

To write the edited value to the target memory, directly enter the value from the keyboard then press the [Enter] key.

Caution This operation cannot be performed during program execution.

(3) Display/modify the CPU register contents during program execution

By registering a CPU register to the [Watch panel](#) as a watch-expression, the value of the CPU register can be displayed/modified not only while the program is stopped, but in execution.

See "2.9.6 [Display/change watch-expressions](#)" for details on the watch-expression.

(4) Save the CPU register contents

The [Save As dialog box](#) can be opened by selecting the [File] menu >> [Save CPU Register Data As...], and all the contents in the CPU register can be saved to a text file (*.txt) or CSV file (*.csv).

When saving to files, retrieve the latest information from the debug tool.

Figure 2-72. Output Example of CPU Register Data

Register name	Value

Category name	
-Register name	Value
:	:

2.9.3 Display/change the SFR

Contents of the SFR can be displayed and its values can be changed in the [SFR panel](#) below.

Select the [View] menu >> [SFR]

For details on the contents and function in each area, see the section for the [SFR panel](#).

Figure 2-73. Display the Contents of the SFR (SFR Panel)

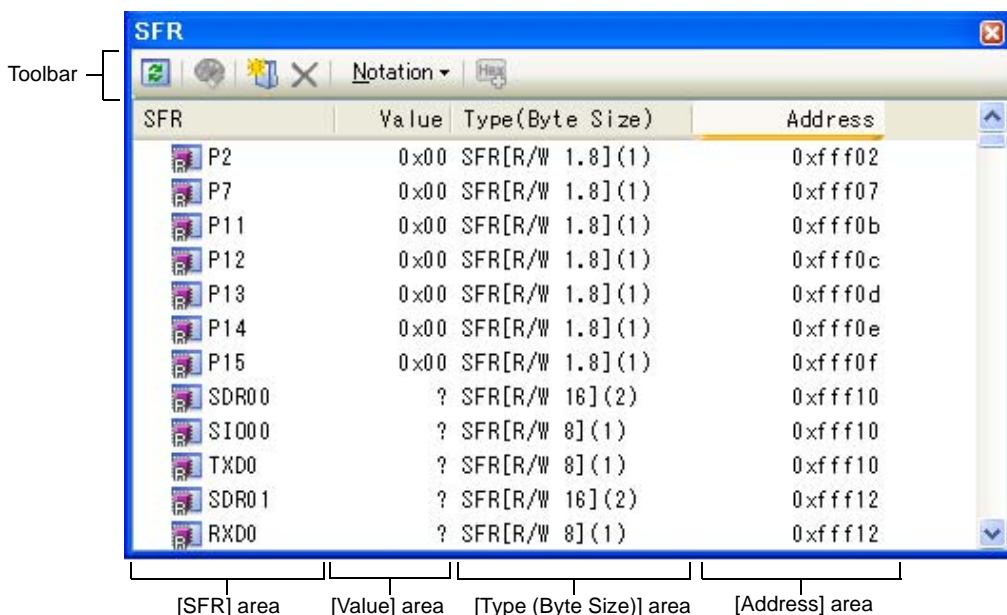

This section describes the following.

- (1) Organize SFRs
- (2) Change display format of values
- (3) Modify the SFR contents
- (4) Display/modify the SFR contents during program execution
- (5) Save the SFR contents

(1) Organize SFRs

The each SFR can be categorized (by folders) and displayed in the tree view.

- Cautions 1. Categories cannot be created within categories.**
- 2. SFRs cannot be added or deleted.**

(a) Create new category

Move the caret to the SFR name to create a new category then click the  button in the toolbar and directly enter the new category name.

(b) Edit category name

Click the category name to edit, and click it again, then directly modify the category name from the keyboard.

(c) Delete categories







Select categories to delete then click the  button in the toolbar. However, the categories that can be deleted are only the empty categories.

(d) Change the display order

SFR name is categorized when SFR is dragged and dropped in the category. Also, the display order of the categories and the SFR names (upper or lower position) can be changed easily by drag and drop operation.

(2) Change display format of values

The display format of the [value] area can be changed using buttons below on the toolbar.

Notation	The following buttons to change the notation of a data value are displayed.
	Displays the value of the selected item in hexadecimal number (default).
	Displays the value of the selected item in signed decimal number.
	Displays the value of the selected item in unsigned decimal number.
	Displays the value of the selected item in octal number.
	Displays the value of the selected item in binary number.
	Displays the value of the selected item in ASCII code.
	Adds the value in hexadecimal number enclosing with "()" at the end of the value of the selected item.

(3) Modify the SFR contents

The SFR values can be edited. Double-click the value of the SFR to edit in the [Value] area to switch the value to edit mode (press the [Esc] key to cancel the edit mode).

To write the edited value to the target memory, directly enter the value from the keyboard then press the [Enter] key.

- Cautions 1. This operation cannot be performed during program execution.**
- 2. The value of the read-only SFR cannot be edited.**

ASCII characters can be entered to the SFR value.

- Examples 1.** When the numeric "0x41" is written to the SFR "P0"
>> "0x41" is written in the port "P0".
- 2.** When the ASCII character "A" is written to the SFR "P0"
>> "0x41" is written in the port "P0".

(4) Display/modify the SFR contents during program execution

By registering a SFR to the [Watch panel](#) as a watch-expression, the value of the SFR can be displayed/modified not only while the program is stopped, but in execution.

See "[2.9.6 Display/change watch-expressions](#)" for details on the watch-expression.

(5) Save the SFR contents

The [Save As dialog box](#) can be opened by selecting the [File] menu >> [Save SFR Data As...], and all the contents of the SFR can be saved in a text file (*.txt) or CSV file (*.csv). At this time, the values of all SFRs become targets irrespective of the setting of display/non-display on this panel.

When saving the contents to the file, the values of the SFR are reacquired and save the latest values acquired. Note that the values of read-protected SFR are not re-read. If you want to save the latest values of those, select [Force Read Value] from the context menu then save the file.

Figure 2-74. Output Example of SFR

SFR name	Value	Type (Byte Size)	Address

<i>Category name</i>			
-SFR name	Value	Type (Byte Size)	Address
:	:	:	:

2.9.4 Display/change global variables/static variables

Global variables or static variables are displayed and its values can be changed in the [Watch panel](#).

Register the variables to display/modify their values to the Watch panel as the watch-expressions.

For details, see "[2.9.6 Display/change watch-expressions](#)".

2.9.5 Display/change local variables

Contents of local variables can be displayed and its values can be changed in the [Local Variables panel](#) below.

Select the [View] menu >> [Local Variable].

Specify the scope in the scope area to display the contents of the target local variable.

In the Local Variables panel, the name of local variables and functions are displayed. The argument of the function is also displayed as the local variable.

For details on the contents and function in each area, see the section for the [Local Variables panel](#).

**Caution Nothing is displayed on this panel during execution of a program.
When the program is stopped, items in each area are displayed.**

Figure 2-75. Display the Contents of Local Variables (Local Variables Panel)

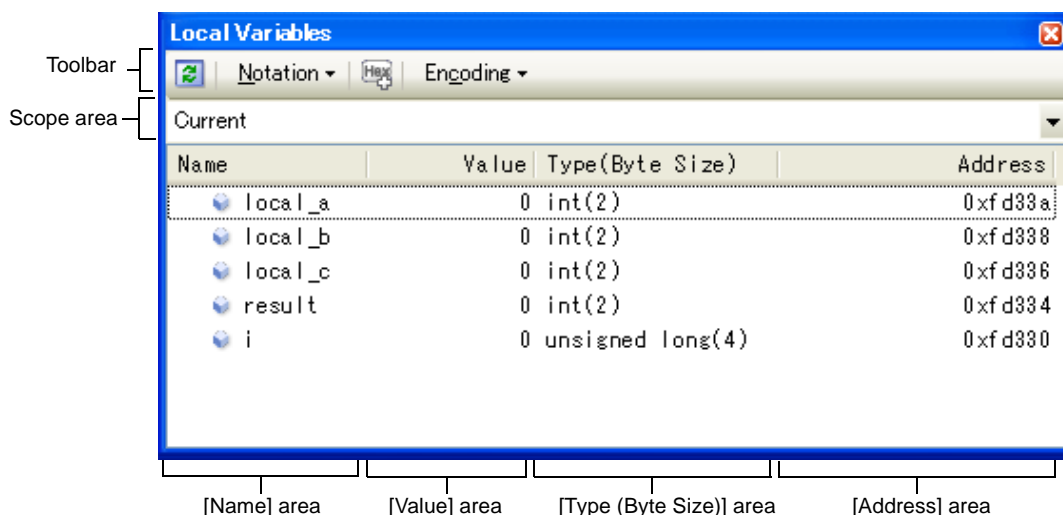

This section describes the following.

- (1) Change display format of values
- (2) Modify the contents of local variables
- (3) Save the contents of local variables

(1) Change display format of values

The display format of the [value] area can be changed using buttons below on the toolbar.

Notation	The following buttons to change the notation of a data value are displayed.
	Displays values on this panel in the default notation according to the type of variable (default).
	Displays values on this panel in hexadecimal number.
	Displays values on this panel in decimal number.
	Displays values on this panel in octal number.
	Displays values on this panel in binary number.
	Displays array indexes on this panel in decimal number (default).
	Displays array indexes on this panel in hexadecimal number.
	Displays values on this panel in Float. Note that when the value is not 4-byte data, or has the type information, displays it in the default notation.
	Displays values on this panel in Double. Note that when the value is not 4-byte data, or has the type information, displays it in the default notation.
	Adds the value in hexadecimal number enclosing with "()" at the end of the value.
Encoding	The following buttons to change the encoding of character variables are displayed.
	Displays character variables in ASCII code (default).
	Displays character variables in Shift_JIS code.
	Displays character variables in EUC-JP code.
	Displays character variables in UTF-8 code.

(2) Modify the contents of local variables

Values and arguments of local variables can be edited.

Select the value of the local variables/arguments to edit in the [Value] area, then click on it again to switch the value to edit mode (press the [Esc] key to cancel the edit mode).

To write the edited value to the target memory, directly enter the value from the keyboard then press the [Enter] key. At this time, the edited value is checked and if it is incompatible with the type, the editing is invalidated.

Caution This operation cannot be performed during program execution.

ASCII characters can be entered to values of local variables.

Examples 1. Entering via an ASCII character

In the [Value] area for the variable "ch", enter "A"
 >> "0x41" will be written to the memory area allocated to "ch"

2. Entering via a numeric value

In the [Value] area for the variable "ch", enter "0x41"
 >> "0x41" will be written to the memory area allocated to "ch"

3. Entering via an ASCII string

Set the display format of character array "str" to ASCII, and in the [Value] area, enter ""ABC"
 >> "0x41, 0x42, 0x43, 0x00" will be written to the memory area allocated to "str"

Remarks 1. If a number with fewer digits than the size of the variable is entered, the higher-order digits will be padded with zeroes.

2. If a number with more digits than the size of the variable is entered, the higher-order digits will be masked.

3. If the display format of a character array (type char or unsigned char) is set to ASCII, then the value can also be entered as a string (ASCII/Shift_JIS/EUC-JP/Unicode (UTF-8)).

(3) Save the contents of local variables

The [Save As dialog box](#) can be opened by selecting the [File] menu >> [Save Local Variables Data As...], and all the contents in the local variables can be saved in a text file (*.txt) or CSV file (*.csv).

When saving to files, retrieve the latest information from the debug tool. If arrays, pointer type variables, structures/unions, and CPU registers (only those with the part name) are displayed expanded, the value of each expanded element is also saved. When they are not expanded, "+" mark is added on the top of the item and the value becomes blank.

Figure 2-76. Output Example of Local Variables

Scope : <i>Current scope</i>				
[V] Variable Name	[P] Parameter Value	[F] Function Type	Address	
[V] Variable name[1]	Value	Type	Address	
- [V] Variable name[0]	Value	Type	Address	
:	:	:	:	:

2.9.6 Display/change watch-expressions

By registering C language variables, CPU register, SFR, and assembler symbols to the [Watch panel](#) as watch-expressions, you can always retrieve their values from debug tools and monitor the values in batch.

The values of the watch-expressions can be updated during the program is in execution (see "[\(7\) Display/modify the contents of watch-expressions during program execution](#)").

Select the [View] menu >> [Watch] >> [Watch 1 - 4] to open the Watch panel.

The Watch panel can be opened up to 4 panels. Each panel is identified by the names "Watch1", "Watch2", "Watch3" and "Watch4" on the title bar, and the watch-expressions can be registered/deleted/moved individually, and they are saved as the user information of the project.

For details on the contents and function in each area, see the section for the [Watch panel](#).

Figure 2-77. Display the Contents of Watch-Expression (Watch Panel)

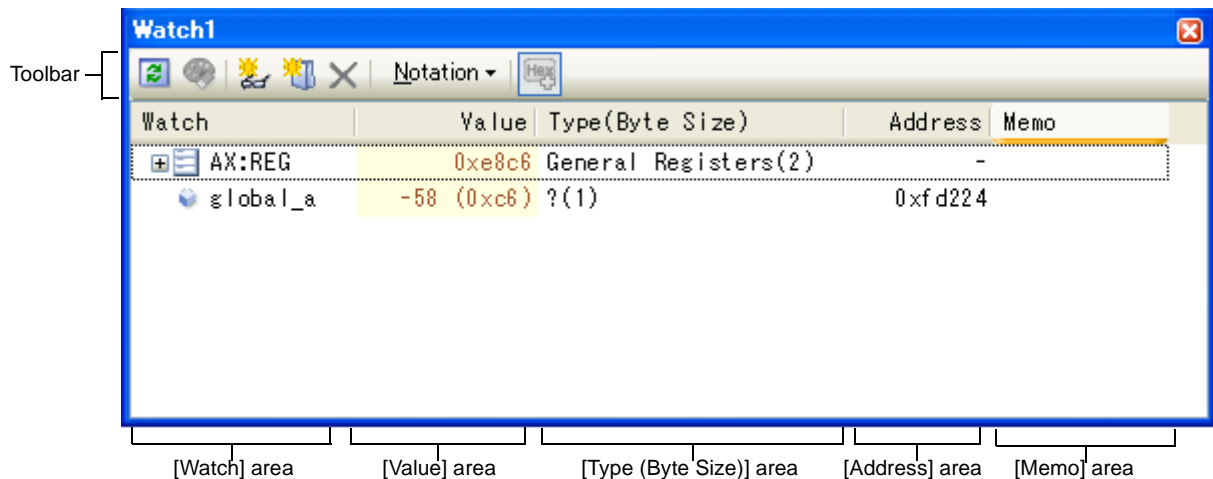

This section describes the following.

- (1) Register a watch-expression
- (2) Organize the registered watch-expressions
- (3) Edit the registered watch-expressions
- (4) Delete a watch-expression
- (5) Change display format of values
- (6) Modify the contents of watch-expressions
- (7) Display/modify the contents of watch-expressions during program execution
- (8) Save the contents of watch-expressions

(1) Register a watch-expression

There are three ways as follows to register watch-expressions (watch-expressions are not registered as default).

Caution Watch-expressions can be registered up to 128 in one watch panel (if this restriction is violated, a message appears).

- Remarks 1.** Each watch-expression registered in each watch panel (Watch1 to Watch4) is managed in each panel and saved as the user information of the project.
2. More than one watch-expression with the same name can be registered.

(a) Register from other panels

Watch-expressions can be registered from other panel in CubeSuite.

In other panel, drag and drop the watch-expression to register in any watch panel (Watch1 to Watch4).

For the relationship between panels that can use this operation and targets that can be registered as watch-expressions, see "Table A-4. Relationship between Panels and Targets That Can be Registered as Watch-Expressions".

Figure 2-78. Registering the Watch-Expression from Other Panels

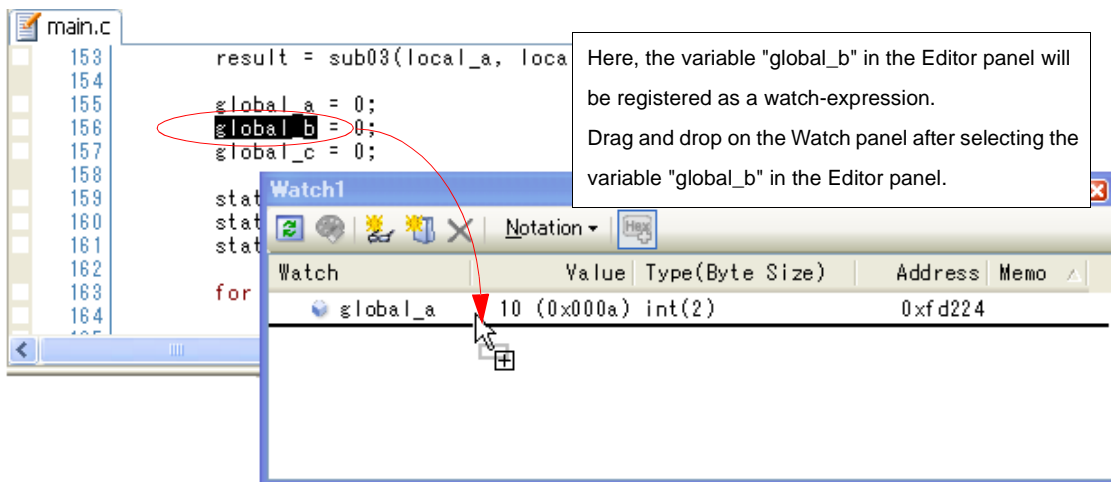

Remark You can also add a watch-expression by doing the following. First, select the target for which you wish to register a watch-expression, or move the caret to one of the target strings (the target is determined automatically). Next, from the context menu, select [Register Watch1] (but this is limited to the Watch panel (Watch 1)).

(b) Directly register in the Watch panel

Click the button in the toolbar in any the Watch panel (Watch1 to Watch4) to display the following entry box in the [Watch] area.

Figure 2-79. Entry Box of the Watch-Expression

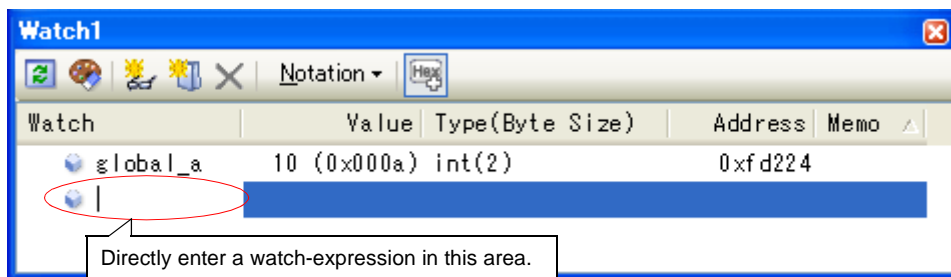

Directly input a watch-expression from the keyboard in the entry box then press the [Enter] key. The input format of the watch-expression is the following tables.

- "Table A-5. Input Format of Watch-Expression"
- "Table A-6. Scope Specification of C language Used with Watch-Expression Registration"
- "Table A-7. Scope Specification of CPU Register with Watch-Expression Registration"
- "Table A-8. Scope Specification of SFR with Watch-Expression Registration"

(c) Register from other application

Select the character strings of C language variables/CPU registers/SFR/assembly symbols from an external editor and drag and drop it in the Watch panel (Watch 1 to Watch 4). The dropped character strings are registered as a watch-expression.

(2) Organize the registered watch-expressions

Registered watch-expressions can be organized in categories (folders) and displayed in tree view (there is no category as default).

Cautions 1. Categories cannot be created within categories.

- 2. Up to 64 categories can be created in one watch panel (if this restriction is violated, a message appears).**

(a) Create new category

Move the caret to the position to create a new category then click the  button in the toolbar and directly enter the new category name.

(b) Edit category name

Click the category name to edit, and click it again, then directly modify the category name from the keyboard.

(c) Delete categories

Select categories to delete then click the  button in the toolbar.

(d) Change the display order

Registered watch-expressions are categorized when they are dragged and dropped in the category.

Also, the display order of the categories and the watch-expressions (upper or lower position) can be changed easily by drag and drop operation.

Remark Drag and drop the watch-expressions/categories in other watch panel (Watch1 to Watch4) to copy them.

(3) Edit the registered watch-expressions

Registered watch-expressions can be edited.

Double-click the watch-expression to edit to switch the watch-expression to edit mode (press the [Esc] key to cancel the edit mode).











Directly edit from the keyboard and then press the [Enter] key.

(4) Delete a watch-expression

To delete watch-expressions, select the one you want to delete in the [Watch panel](#) then click the  button in the toolbar.

(5) Change display format of values

The display format of the [value] area can be changed using buttons below on the toolbar.

Notation	The following buttons to change the notation of a data value are displayed.
	Displays the value of the selected watch-expression in the default notation (see "Table A-9. Display Format of Watch-Expressions (Default)") according to the type of variable (default).
	Displays the value of the selected item in hexadecimal number.
	Displays the value of the selected item in signed decimal number.
	Displays the value of the selected item in unsigned decimal number.
	Displays the value of the selected item in octal number.
	Displays the value of the selected item in binary number.
	Displays the value of the selected item in ASCII code.
	Displays the value of the selected item in Float. Note that this item becomes valid only when the selected watch-expression value is 4-byte data.
	Displays the value of the selected item in Double. Note that this item becomes valid only when the selected watch-expression value is 8-byte data.
	Adds the value in hexadecimal number enclosing with "("" at the end of the value of the selected item (except the item displayed in hexadecimal number).

(6) Modify the contents of watch-expressions

The watch-expressions values can be edited.

Double-click the value of the watch-expression to edit in the [Value] area to switch the value to edit mode (press the [Esc] key to cancel the edit mode).

To write the edited value to the target memory, directly enter the value from the keyboard then press the [Enter] key.

Note that only those values correspond one by one to variables of C language, CPU registers, SFR or assembler symbols can be edited. In addition, read-only SFR values cannot be edited.

Remark This operation can be taken place while the program is in execution. See "(4) Display/modify the memory contents during program execution" for details on how to operate it.

You can use ASCII characters also to the values of the watch-expression.

Examples 1. Entering via an ASCII character

In the [Value] area for the variable "ch", enter "A"
>> "0x41" will be written to the memory area allocated to "ch"

2. Entering via a numeric value

In the [Value] area for the variable "ch", enter "0x41"
>> "0x41" will be written to the memory area allocated to "ch"

3. Entering via an ASCII string

Set the display format of character array "str" to ASCII, and in the [Value] area, enter ""ABC"
>> "0x41, 0x42, 0x43, 0x00" will be written to the memory area allocated to "str"

Remarks 1. If a number with fewer digits than the size of the variable is entered, the higher-order digits will be padded with zeroes.

2. If a number with more digits than the size of the variable is entered, the higher-order digits will be masked.

3. If the display format of a character array (type char or unsigned char) is set to ASCII, then the value can also be entered as a string (ASCII/Shift_JIS/EUC-JP/Unicode (UTF-8)).

(7) Display/modify the contents of watch-expressions during program execution

The [Memory panel/Watch panel](#) has the real-time display update function that can update/modify the display contents of the memory/watch-expression in real-time while executing the program (this function is implemented using the debug tool's RRM (Real-time RAM Monitor) function and DDM (Dynamic Memory Modification) function). Using the real-time display update function enables to display/modify the value of memory/watch-expression not only while the program is stopped, but also in execution.

See "(4) [Display/modify the memory contents during program execution](#)" for details on how to operate it.

(8) Save the contents of watch-expressions

By selecting the [File] menu >> [Save Watch Data As...], the [Save As dialog box](#) can be opened, and all the contents of the watch-expression and its value can be saved in a text file (*.txt) or CSV file (*.csv).

When saving the contents to the file, all the values of the watch-expression are reacquired and save the latest values acquired.

If arrays, pointer type variables, structures/unions, and CPU registers (only those with the part name) are displayed expanded, the value of each expanded element is also saved. When they are not expanded, "+" mark is added on the top of the item and the value becomes blank.

Note that the values of read-protected SFR are not re-read. If you want to save the latest values of those, select [Force Read Value] from the context menu then save the file.

Figure 2-80. Output Example of Watch Data

Watch-expression	Value	Type (Byte Size)	Address	Memo

<i>Category name</i>				
<i>Watch-expression</i>	<i>Value</i>	<i>Type</i>	<i>Address</i>	<i>Memo</i>
:	:	:	:	:

Remark When the contents of the panel are overwritten with selecting the [File] menu >> [Save Watch Data], each watch panel (Watch1 to Watch4) is treated as a different panel.

2.10 Display Information on Function Call from Stack

This section describes how to show the information on function call from the stack.

The CubeSuite compiler (CA78K0) pushes function-call information onto the stack, in accordance with the ANSI standard.

It is thus possible to learn the function call depth, the location of the caller, parameters, and other information by analyzing the function-call information.

This "function-call information" is called the call stack information; this term will be used in the rest of this document.

2.10.1 Display call stack information

Call stack information is displayed in the [Call Stack panel](#) below.

Select the [View] menu >> [Call Stack].

For details on the contents and function in each area, see the section for the [Call Stack panel](#).

Caution Nothing is displayed on this panel during execution of a program.
When the program is stopped, items in each area are displayed.

Figure 2-81. Display Call Stack Information (Call Stack Panel)

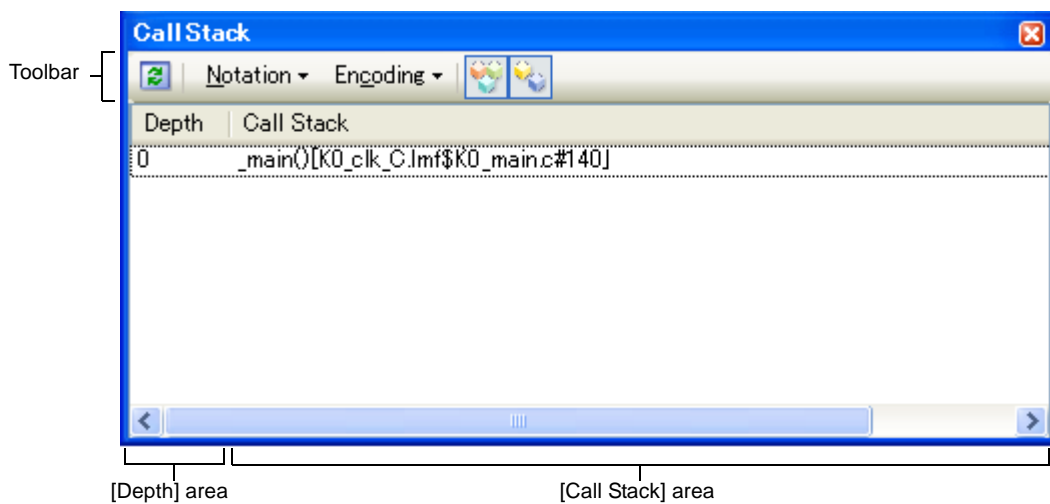









This section describes the following.

- (1) Change display format of values
- (2) Jump to the source line
- (3) Display local variables
- (4) Save the contents of call stack information

(1) Change display format of values

The display format of this panel can be changed using buttons below on the toolbar.

This item becomes invalid during execution of a program.

Notation	The following buttons to change the notation of a data value are displayed.
	Displays values on this panel in the default notation according to the type of variable (default).
	Displays values on this panel in hexadecimal number.
	Displays values on this panel in decimal number.
	Displays values on this panel in octal number.
	Displays values on this panel in binary number.
Encoding	The following buttons to change the encoding of character variables are displayed.
	Displays character variables in ASCII code (default).
	Displays character variables in Shift_JIS code.
	Displays character variables in EUC-JP code.
	Displays character variables in UTF-8 code.

(2) Jump to the source line

The [Editor panel](#) is opened with moving the caret to the function call source line which the selected line designates when the line is double-clicked (if the panel is already opened, jump to the Editor panel).

Remark The [Disassemble panel](#) (Disassemble1) is opened with moving the caret to the function call source address which the currently selected line designates when selecting [Jump to Disassemble] from the context menu (if the panel is already opened, jump to the Disassemble panel (Disassemble1)).

(3) Display local variables

The [Local Variables panel](#) that displays the local variables which the currently selected line designates is opened when selecting [Jump to Local Variable at This Time] from the context menu.

(4) Save the contents of call stack information

By selecting the [File] menu >> [Save Call Stack Data As...], the [Save As dialog box](#) can be opened, and all the contents in the call stack information can be saved in a text file (*.txt) or CSV file (*.csv).

When saving to files, retrieve the latest information from the debug tool.

Figure 2-82. Output Example of Call Stack Information

Depth	Call stack
0	----- <i>Call stack information</i>
1	<i>Call stack information</i>
:	:

2.11 Collect Execution History of Programs [IECUBE][Simulator]

This section describes how to collect the execution history of the program.

A history of program execution is generally called a trace; this term will be used in the remainder of this document.

It is nearly impossible to find the cause of runaway program execution from the memory contents, stack information, and the like after the runaway has occurred. The collected trace data, however, can be used to trace program execution up to the runaway directly, making this an effective tool for discovering hidden bugs.

Caution [MINICUBE2]

The trace function is not supported.

2.11.1 Configure the trace operation

When tracing starts, the trace data that the execution process of the program currently in execution is recorded is collected (when the program is stopped, tracing automatically stops).

You need to configure the trace operation before using the trace function.

The setting method differs depending on the debug tool used.

- (1) [IECUBE]
- (2) [Simulator]

(1) [IECUBE]

This trace operation can be configured in the [Trace] category in the [Debug Tool Settings] tab in the Property panel.

Figure 2-83. [Trace] Category [IECUBE]

Trace	
Clear trace memory before running	Yes
Operation after trace memory is full	Non stop and overwrite to trace memory

(a) [Clear trace memory before running]

Specify from the drop-down list whether to clear (initialize) the trace memory before tracing starts in this property. Select [Yes] to clear the memory (default).

Remark You can forcibly clear the trace memory when clicking the  button in the toolbar in the Trace panel [IECUBE][Simulator].

(b) [Operation after trace memory is full]

Specify the operation after the trace memory is full with the collected trace data from the following drop-down list.

Non stop and overwrite to trace memory	Continues overwriting the older trace data after the trace memory is full (default). When "(a) [Clear trace memory before running]" is set to [Yes], at the time of a resumption, the trace data is collected after clearing the trace memory.
Stop trace	When the trace memory is full, the trace data stops writing (the program does not stop execution). When "(a) [Clear trace memory before running]" is set to [No], the trace data is not collected even if the program is executed again.

Stop	When the trace memory is full, the trace data stops writing and the program stops execution. When "(a) [Clear trace memory before running]" is set to [No], the program cannot be executed again even if it is executed.
------	---

(2) [Simulator]

This trace operation can be configured in the [Trace] category in the [Debug Tool Settings] tab in the Property panel.

Figure 2-84. [Trace] Category [Simulator]

Trace	
Use trace function	No
Clear trace memory before running	Yes
Operation after trace memory is full	Non stop and overwrite to trace memory
Accumulate trace time	No
Trace memory size[frames]	4K

(a) [Use trace function]

Specify whether to use trace function from the drop-down list in this property. Select [Yes] to use the trace function ([No] is selected by default).

(b) [Clear trace memory before running]

Specify from the drop-down list whether to clear (initialize) the trace memory before tracing starts in this property. Select [Yes] to clear the memory (default).

Remark You can forcibly clear the trace memory when clicking the  button in the toolbar in the Trace panel [IECUBE][Simulator].

(c) [Operation after trace memory is full]

Specify the operation after the trace memory is full with the collected trace data from the following drop-down list.

Non stop and overwrite to trace memory	Continues overwriting the older trace data after the trace memory is full (default). When (b) [Clear trace memory before running] is set to [Yes], at the time of a resumption, the trace data is collected after clearing the trace memory.
Stop trace	When the trace memory is full, the trace data stops writing (the program does not stop execution). When (b) [Clear trace memory before running] is set to [No], the trace data is not collected even if the program is executed again.
Stop	When the trace memory is full, the trace data stops writing and the program stops execution. When (b) [Clear trace memory before running] is set to [No], the program cannot be executed again even if it is executed.

(d) [Accumulate trace time]

Specify from the drop-down list whether to display the trace time with accumulated time in this property. Specify [Yew] to display trace time with accumulated time. Specify [No] to display the trace time with differential time (default).

(e) [Trace memory size[frames]]

Specify from the drop-down list the trace memory size (trace frame number) in this property.

The trace frame is a unit of the trace data. One trace frame is used for each operation in fetch/write/read.

Drop down list includes the following trace frame numbers.

4K (default), 8K, 12K, 16K, 20K, 24K, 28K, 32K, 36K, 40K, 44K, 48K, 52K, 56K, 60K, 64K, 128K 192K, 256K, 320K, 384K, 448K, 512K, 576K, 640K, 704K, 768K, 832K, 896K, 960K, 1M, 2M, 3M

2.11.2 Collect execution history until stop of the execution

In the debug tool, there is a function to collect the execution history from the start of program execution to the stop.

Therefore, the trace data collection is automatically started when the program starts executing and stopped when the program stops.

See "2.11.5 Display the collected execution history" for how to check the collected trace data.

Remark This function is operated by the Unconditional Trace event, which is one of the built-in events set by default in the debug tool.

Consequently, if the Unconditional Trace event is set to **Invalid state** by clearing the check box in the **Events panel**, trace data linked to the start of program execution will not be collected (the Unconditional Trace event is set to **Valid state** by default).

Note that the Unconditional Trace event and the Trace event (see "2.11.3 Collect execution history in the arbitrary section" below) are events that are used on a mutually exclusive basis. Therefore, if the Trace event with **Valid state** is set, the Unconditional Trace event is automatically set to **Invalid state**.

2.11.3 Collect execution history in the arbitrary section

The execution history is collected as trace data only for the arbitrary section while the program is in execution by setting a Trace event (Start Tracing event/Stop Tracing event).

To use this function, follow the steps below.

Cautions 1. Also see "2.15.6 Notes for setting events" for details on Trace events (e.g. limits on the number of enabled events).

2. [Simulator]

Start Tracing events and Stop Tracing events cannot be set while a tracer is running.

(1) Set a Start Tracing event/Stop Tracing event

Set a Start Tracing event/Stop Tracing event that starts/stops collecting the trace data in the **Editor panel/Disassemble panel**.

(a) How to set a Start Tracing event

Move the caret to the line/address^{Note} to start collecting trace data then select [Trace Settings] >> [Start Tracing] from the context menu.

A Start Tracing event is set to the instruction at the start address of the line/address where the caret exists.

(b) How to set a Stop Tracing event

Move the caret to the line/address^{Note} to stop collecting trace data then select [Trace Settings] >> [Stop Tracing] from the context menu.

A Stop Tracing event is set to the instruction at the start address of the line/address where the caret exists.

Note Start Tracing events/Stop Tracing events cannot be set at lines in the event area with the background color in gray (showing to the corresponding address of the line that no change is allowed).

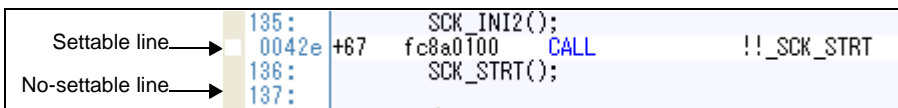

Once a Start Tracing event/Stop Tracing event is set, the following event mark is displayed in the event area of the line/address that an event is set. Start Tracing events/Stop Tracing events are managed as a single event (the Trace event) in the [Events panel](#) (details about set Start Tracing events/Stop Tracing events can be checked by clicking the plus mark "+" next to the Trace event item).

Table 2-9. Event Marks of the Start Tracing Event/Stop Tracing Event

Event Type	Event mark
Start Tracing	
Stop Tracing	

Figure 2-85. Start Tracing Event/Stop Tracing Event Setting Example

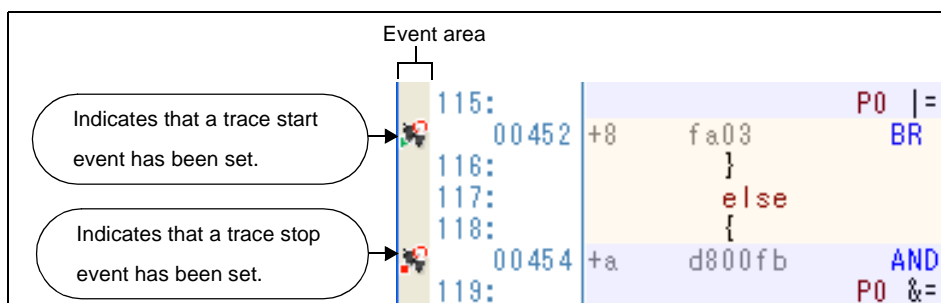

Remarks 1. When either of the Start Tracing event/Stop Tracing event is set as [Valid state](#), the check box of the Unconditional Trace event in the [Events panel](#) is automatically cleared, therefore, the trace data collection does not automatically start with the start of the program execution (the tracer will not move until the condition of the Start Tracing event that has been set is met).

- 2. A Stop Tracing event is not indispensable for A Trace event.
- 3. Event marks differ depending on the event state (see "[2.15.1 Change the state of set events \(valid/invalid\)](#)").

When an event is set at the point which other event is already set, the event mark () is displayed meaning more than one event is set at the point.

- 4. **[Simulator]**
When either of the Start Tracing event/Stop Tracing event is set to [Valid state](#), the [Use trace function] property in the [Trace] category on the [\[Debug Tool Settings\]](#) tab of the [Property panel](#) is automatically set to [Yes] and the trace function will be enabled.

(2) Execute the program

Execute the program (see "[2.7 Execute Programs](#)").

If the instruction with the Start Tracing event/Stop Tracing event executes, the trace data collection starts/stops.

See "[2.11.5 Display the collected execution history](#)" for how to check the collected trace data.

(3) Delete the Start Tracing event/Stop Tracing event

To delete the set Start Tracing event/Stop Tracing event, select [Delete Event] from the context menu that appears by right clicking on the event mark in the event area.

2.11.4 Collect execution history when the condition is met

The program execution history is collected when a condition is met.

(1) When an access to variables/SFRs occurs

Set the Point Trace event to collect information about accesses to specified variables or SFR as trace data. Set a Point Trace event by one of the following operation.

Cautions 1. Also see "2.15.6 Notes for setting events" for details on point trace events (e.g. limits on the number of enabled events).

2. [IECUBE]

The point trace events cannot be set for 32-bit (4-byte) variables.

Additionally, accessing a single byte of a 16-bit (2-byte) variable will not be detected as an access.

(a) When the access is to the variable/SFR on the source text/disassembled text

Perform this operation in the [Editor panel/Disassemble panel](#) in which the source text/disassembly text is displayed.

Follow the operation listed below from the context menu after selecting the variable/SFR.

Note, however, that only global variables, static variables inside functions, and file-internal static variables can be used.

By performing the following operation, it is interpreted as if a Point Trace event has been set at the target variable/SFR, and it is managed in the [Events panel](#) (see "2.15 Manage Events" for details).

Access Type	Operation
Read/Write	Select [Trace Settings] >> [Record R/W Value].

Remark Variables within the current scope can be specified.

(b) When the access is to the registered watch-expression

Follow the steps below in the [Watch panel](#).

Follow the operation listed below from the context menu after selecting the registered watch-expression (see "2.9.6 Display/change watch-expressions").

Note, however, that only global variables, static variables inside functions, file-internal static variables, and SFR can be used.

By performing the following operation, it is interpreted as if a Point Trace event has been set at the target watch-expression, and it is managed in the [Events panel](#) (see "2.15 Manage Events" for details).

Access Type	Operation
Read	Select [Trace Output] >> [Record Reading Value].
Write	Select [Trace Output] >> [Record Writing Value].
Read/Write	Select [Trace Output] >> [Record R/W Value].

Remark A watch-expression within the current scope can be specified.
 To target a watch-expression outside the current scope, select a watch-expression with a specified scope.

After the setting of the Point Trace event is complete, execute the program (see "2.7 Execute Programs").
 If the conditions for a Point Trace event that you have set are met while the program is executing, that information is collected as trace data.

See "2.11.5 Display the collected execution history" for details on checking trace data.

To delete a Point Trace event, select the event name to delete in the Events panel opened when selecting the [View] menu >> [Event], then press the  button in the toolbar in the same panel (see "2.15 Manage Events").

Figure 2-86. Example of Point Trace Event Results View (When Using Simulator)



2.11.5 Display the collected execution history

The collected trace data is displayed in the Trace panel [IECUBE][Simulator] below.

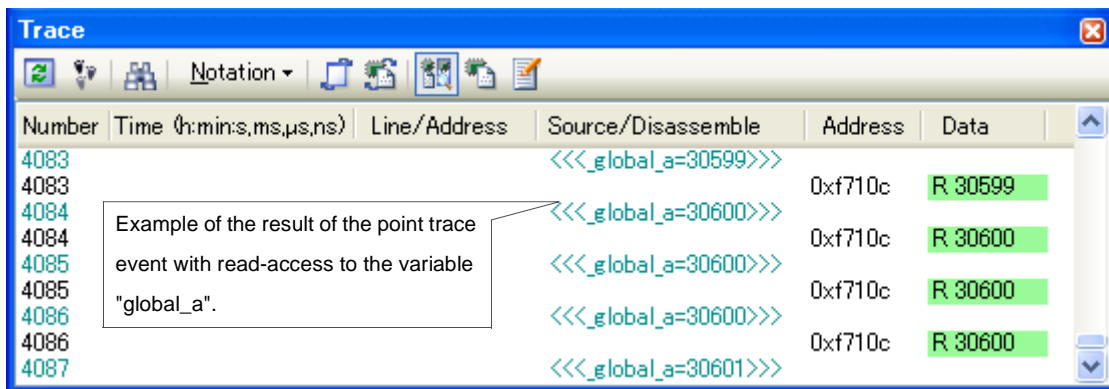
Select the [View] menu >> [Trace].

The trace data displays by mixing the disassembled text and source text by default, but it is also possible to display either one of these by selecting the Display mode.

For details on the contents and function in each area, see the section for the Trace panel [IECUBE][Simulator].

Figure 2-87. Display the Trace Data (Trace Panel)

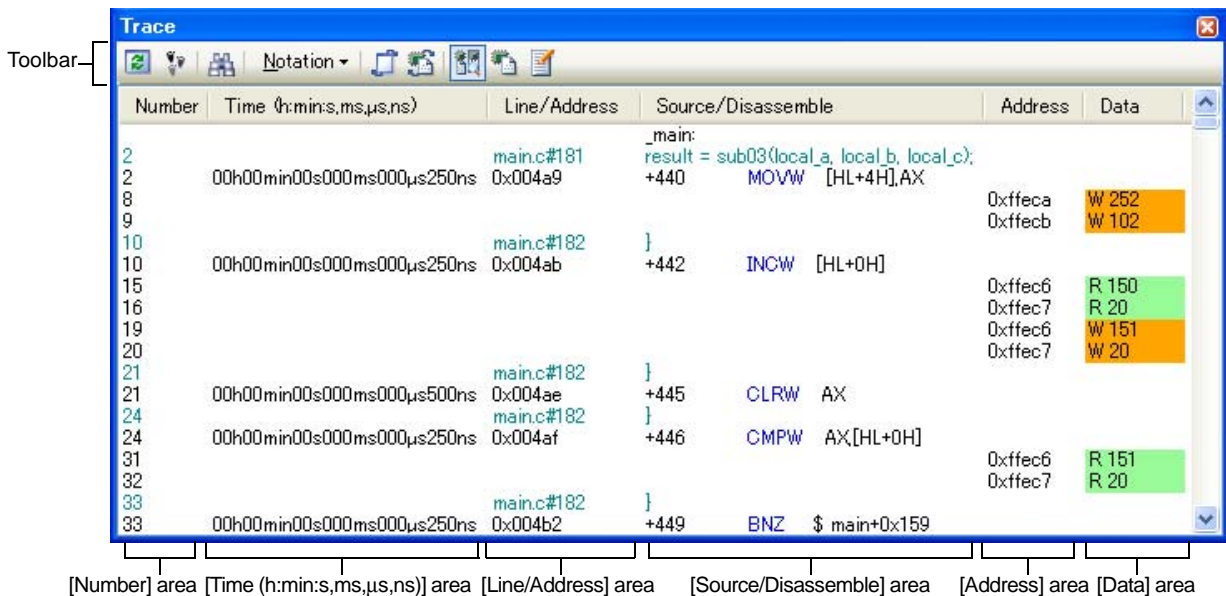

This section describes the following.

- (1) Change display mode
- (2) Change display format of values
- (3) Link with other panels

(1) Change display mode

Display mode can be changed to the purpose when clicking the buttons below in the toolbar. These buttons become invalid during trace operation.

Table 2-10. Display Modes of the Trace Panel



Button	Display Mode	Display Contents
	Mixed display mode	Displays the instruction (disassemble results), labels, source text (corresponding source line), point trace results, and break causes (default).
	Disassemble display mode	Displays the instruction (disassemble results), labels, point trace results, and break causes.
	Source display mode	Displays the source text (corresponding source line), and break causes. However, when a place where no debugging information is present is executed, "<No Debug Information>" is displayed.





Figure 2-88. Example of Source Display Mode View (Trace Panel)

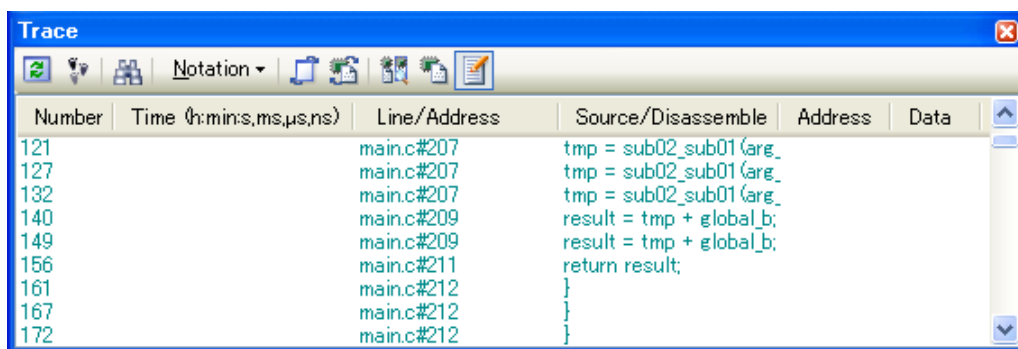

(2) Change display format of values

The display format of the [Line Number/Address]/[Address]/[Data] area can be changed using buttons below on the toolbar.

Note that the button is invalid while program is executed.

Notation	The following buttons to change the notation of a data value are displayed.
	Displays values on this panel in hexadecimal number (default).
	Displays values on this panel in decimal number.
	Displays values on this panel in octal number.
	Displays values on this panel in binary number.

(3) Link with other panels

Items in the trace panel can be linked to other panels using the currently selected line address as a pointer (window focus will not move).

Click the  button on the toolbar to start linking to the [Editor panel](#). Click the  button on the toolbar to start linking to the [Disassemble panel](#).

If the button is clicked again, the link is disconnected.

Remark The [Editor panel/Disassemble panel](#) opens when selecting the [Jump to Source]/[Jump to Disassemble] from the context menu with moving the caret to the source line/address corresponding to the address of the currently selected line (focus is moved).

2.11.6 Clear the trace memory

To clear the collected trace data contents, click the  button on the toolbar.

Note that this button becomes invalid during trace operation.

Remark When [Yes] is specified in the [Clear trace memory before running] property in the [Trace] category in the [\[Debug Tool Settings\] tab](#) of the [Property panel](#), the trace memory is cleared every time the program executes.

2.11.7 Search the trace data

To search the collected trace data, click the  button to open the [Trace Search dialog box \[IECUBE\]\[Simulator\]](#) (note that the search is disabled during the program is executing).

In this dialog box, follow the steps below.

When the tab on the tab selection area is selected, the trace data can be searched in instruction level/source level.

Note however, that if you search the trace data at the instruction level, the display mode must be set in the [Trace panel \[IECUBE\]\[Simulator\]](#) to the [Mixed display mode](#) or [Disassemble display mode](#).

When searching at the source level, the mode must be set to the [Mixed display mode](#) or [Source display mode](#).

Figure 2-89. Search the Trace Data (Trace Search Dialog Box)

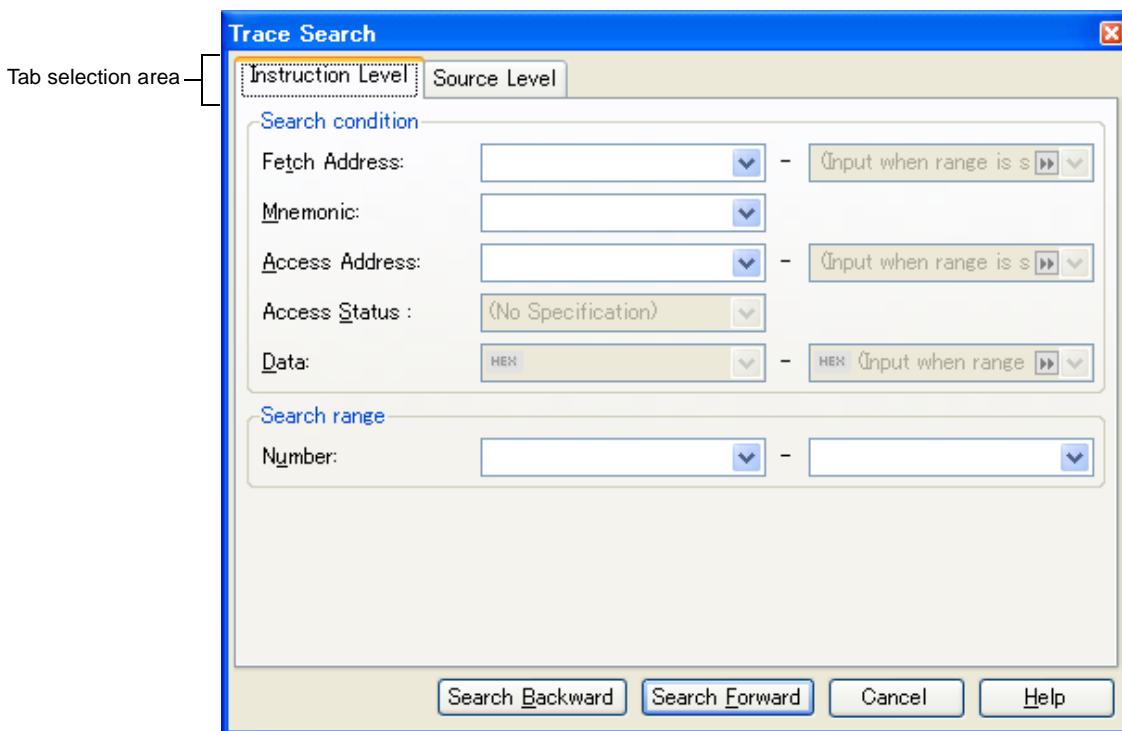

This section describes the following.

- (1) Search in the instruction level
- (2) Search in the source level

(1) Search in the instruction level

Search the trace data in the instruction level.

Select the [Instruction Level] tab and then follow the steps below.

Figure 2-90. Search the Trace Data in the Instruction Level

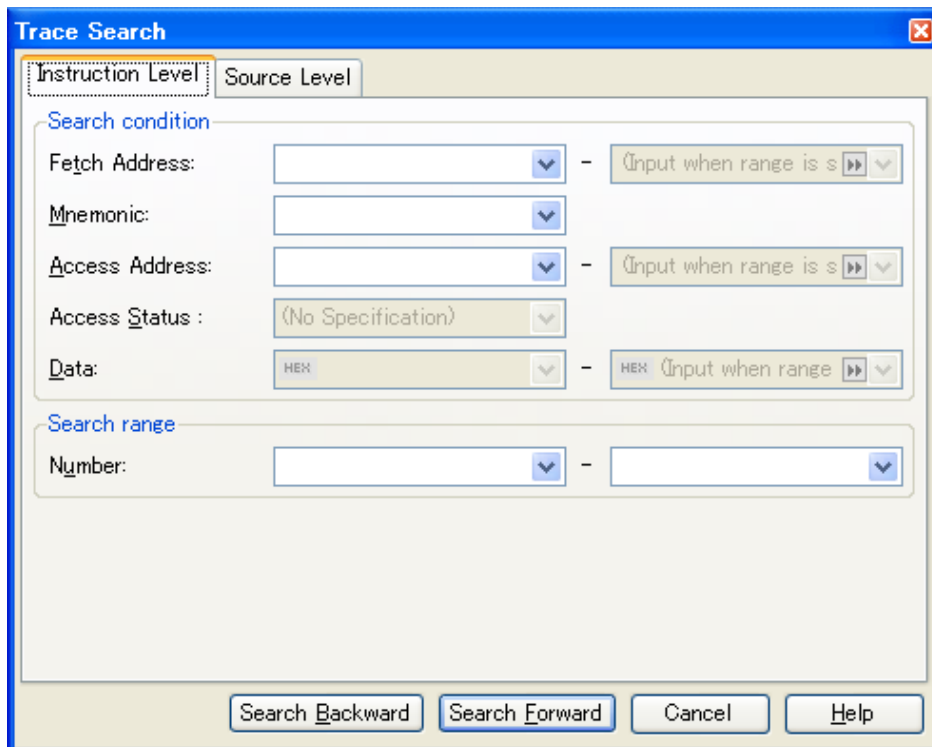

(a) Specify [Fetch Address]

Specify the fetch address if it is a required search parameter.

You can either type the address expression directly into the text boxes, or select it from the input history via the drop-down list (up to 10 items).

The fetch address can also be specified as a range. In this case, specify a range by specifying address expressions in both the left and right text boxes.

If the right-hand text box is blank or contains the text [(Input when range is specified)], then the fixed address specified in the left-hand text box will be searched.

Note that if an address value greater than the microcontroller address space is specified, the upper address value is masked.

An address value greater than the value expressed within 32 bits cannot be specified.

(b) Specify [Mnemonic]

Specify the mnemonic if it is a required search parameter.

The specified character strings in this area is searched within the [Source/Disassemble] area of the Trace panel [IECUBE][Simulator].

You can either type a mnemonic directly into the text boxes, or select one from the input history via the drop-down list (up to 10 items).

Searches are case-insensitive, and partial matches are also allowed.

(c) Specify [Access Address]

Specify the access address if it is a required search parameter.

You can either type the address value directly into the text boxes (in hexadecimal number), or select it from the input history via the drop-down list (up to 10 items).

The access address can also be specified as a range. In this case, specify a range by specifying address expressions in both the left and right text boxes.

If the right-hand text box is blank or contains the text [(Input when range is specified)], then the fixed address specified in the left-hand text box will be searched.

Note that if an address value greater than the microcontroller address space is specified, the upper address value is masked.

An address value greater than the value expressed within 32 bits cannot be specified.

(d) Specify [Access Status]

This item is only enable if a value for [Specify \[Access Address\]](#) is specified.

Select the access type (Read/Write, Read, Write, Vector Read and DMA) from drop-down list.

Select [(No Specification)] if you do not wish to limit access types.

(e) Specify [Data]

This item is only enable if a value for [Specify \[Access Address\]](#) is specified.

Specify the access data.

You can either type the data directly into the text boxes (in hexadecimal number), or select it from the input history via the drop-down list (up to 10 items).

The data can also be specified as a range. In this case, specify a range by specifying data in both the left and right text boxes.

If the right-hand text box is blank or contains the text [(Input when range is specified)], then the fixed data specified in the left-hand text box will be searched.

(f) Specify [Number]

Specify the range within the trace data to search via the number displayed in the [Number] area of the [Trace panel \[IECUBE\]\[Simulator\]](#).

Specify the starting number in the left text box, and the ending number in the right text box ("0" to "*last number*" are specified by default).

You can either type the numbers directly into the text boxes (in base-10 format), or select them from the input history via the drop-down list (up to 10 items).

If the left-hand text box is left blank, it is treated as if "0" were specified.

If the right-hand text box is left blank, it is treated as if the last number were specified.

(g) Click the [Search Backward]/[Search Forward] button

When the [Search Backward] button is clicked, search is taken place in the order from the large number to small and the search results are shown selected in the [Trace panel \[IECUBE\]\[Simulator\]](#).

When the [Search Forward] button is clicked, search is taken place in the order from the small number to large and the search results are shown selected in the [Trace panel \[IECUBE\]\[Simulator\]](#).

(2) Search in the source level

Search the trace data in the source level.

Select the [Source Level] tab.

Figure 2-91. Search the Trace Data in the Source Level

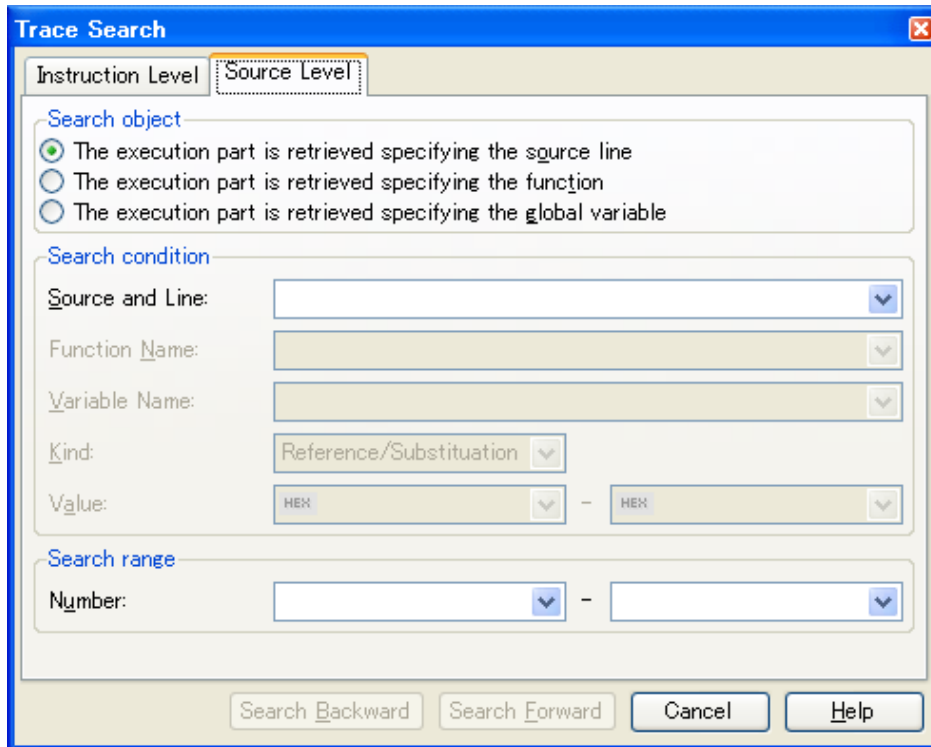
**(a) Search with specifying the source line (default)**

Select the [The execution part is retrieved specifying the source line] item in the [Search object] area and then follow the operation below.

<1> Specify [Source and Line]

The specified character strings in this area is searched within the [Line/Address] area of the Trace panel [IECUBE][Simulator].

You can either type the character strings of the source line to be find directly into the text box, or select them from the input history via the drop-down list (up to 10 items).

Searches are case-insensitive, and partial matches are also allowed.

Examples 1. main.c#40

2. main.c
3. main

<2> Specify [Number]

Specify the range within the trace data to search via the number displayed in the [Number] area of the Trace panel [IECUBE][Simulator].

Specify the starting number in the left text box, and the ending number in the right text box ("0" to "last number" are specified by default).

You can either type the numbers directly into the text boxes (in base-10 format), or select them from the input history via the drop-down list (up to 10 items).

If the left-hand text box is left blank, it is treated as if "0" were specified.

If the right-hand text box is left blank, it is treated as if the last number were specified.

<3> Click the [Search Backward]/[Search Forward] button

When the [Search Backward] button is clicked, search is taken place in the order from the large number to small and the search results are shown selected in the [Trace panel \[IECUBE\]\[Simulator\]](#).

When the [Search Forward] button is clicked, search is taken place in the order from the small number to large and the search results are shown selected in the [Trace panel \[IECUBE\]\[Simulator\]](#).

(b) Search with specifying the function name

Select the [The execution part is retrieved specifying the function] item in the [Search object] area and then follow the operation below.

<1> Specify [Function Name]

You can either type the function name to be find directly into the text box, or select it from the input history via the drop-down list (up to 10 items).

Searches are case-insensitive, and only complete matches are retrieved.

<2> Specify [Number]

Specify the range within the trace data to search via the number displayed in the [\[Number\] area](#) of the [Trace panel \[IECUBE\]\[Simulator\]](#).

Specify the starting number in the left text box, and the ending number in the right text box ("0" to "*last number*" are specified by default).

You can either type the numbers directly into the text boxes (in base-10 format), or select them from the input history via the drop-down list (up to 10 items).

If the left-hand text box is left blank, it is treated as if "0" were specified.

If the right-hand text box is left blank, it is treated as if the last number were specified.

<3> Click the [Search Backward]/[Search Forward] button

When the [Search Backward] button is clicked, search is taken place in the order from the large number to small and the search results are shown selected in the [Trace panel \[IECUBE\]\[Simulator\]](#).

When the [Search Forward] button is clicked, search is taken place in the order from the small number to large and the search results are shown selected in the [Trace panel \[IECUBE\]\[Simulator\]](#).

(c) Search with specifying the global variable

Select the [The execution part is retrieved specifying the global variable] item in the [Search object] area and then follow the operation below.

<1> Specify [Variable Name]

You can either type the variable name to be find directly into the text box, or select it from the input history via the drop-down list (up to 10 items).

Searches are case-insensitive, and only complete matches are retrieved.

<2> Specify [Kind]

Select the access type ([Reference/Substitution], [Reference], or [Substitution]) from the drop-down list.

<3> Specify [Value]

You can either type the accessed variable value directly into the text box, or select one from the input history via the drop-down list (up to 10 items).

The variable value can also be specified as a range. In this case, specify a range by specifying variable values in both the left and right text boxes.

If the right-hand text box is blank, then access locations with the fixed variable values specified in the left-hand text box will be searched for.

<4> Specify [Number]

Specify the range within the trace data to search via the number displayed in the [Number] area of the Trace panel [IECUBE][Simulator].

Specify the starting number in the left text box, and the ending number in the right text box ("0" to "last number" are specified by default).

You can either type the numbers directly into the text boxes (in base-10 format), or select them from the input history via the drop-down list (up to 10 items).

If the left-hand text box is left blank, it is treated as if "0" were specified.

If the right-hand text box is left blank, it is treated as if the last number were specified.

<5> Click the [Search Backward]/[Search Forward] button

When the [Search Backward] button is clicked, search is taken place in the order from the large number to small and the search results are shown selected in the Trace panel [IECUBE][Simulator].

When the [Search Forward] button is clicked, search is taken place in the order from the small number to large and the search results are shown selected in the Trace panel [IECUBE][Simulator].

2.11.8 Save the contents of execution history

Contents of the collected trace data can be saved with range selection in text files (*.txt)/CSV files (*.csv).

When saving to the file, the latest information is acquired from the debug tool, and it is saved according with the display format on this panel.

The following Data Save dialog box can be opened by selecting the [File] menu >> [Save Trace Data As...].

In this dialog box, follow the steps below.

Figure 2-92. Save Execution History (Data Save Dialog Box)

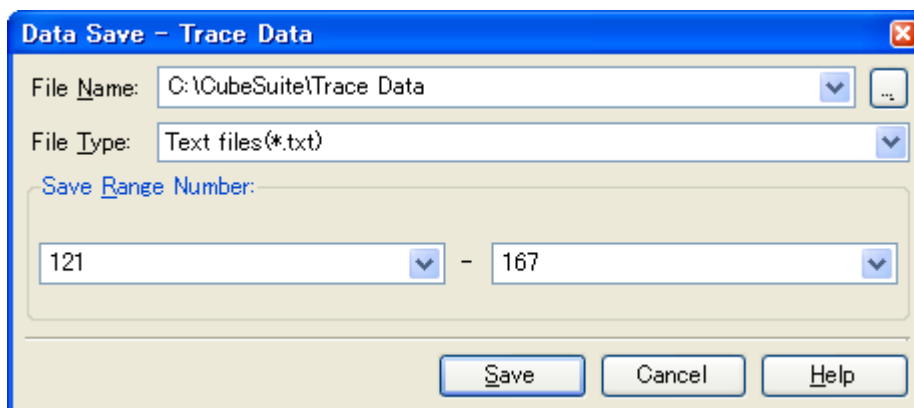

(1) Specify [File Name]

Specify the name of the file to save.

You can either type a filename directly into the text box (up to 259 characters), or select one from the input history via the drop-down list (up to 10 items).

You can also specify the file by clicking the [...] button, and selecting a file via the Select Data Save File dialog box.

(2) Specify [File Type]

Select the format in which to save the file from the following drop-down list.

The following file formats can be selected.

List Item	Format
Text files (*.txt)	Text format (default)
CSV (Comma-Separated Variables)(*.csv)	CSV format ^{Note}

Note The data is saved with entries separated by commas (,).
 If the data contains commas, each entry is surrounded by double quotes "" in order to avoid illegal formatting.

(3) Specify [Save Range Number]

Specify the range of the number to save via "start number" and "end number".

Directly enter decimal number in each text box or select from the input history displayed in the drop-down list (up to 10 items).

When saving all the trace data, select the [All Trace Data] item in the drop-down list at the left (the right text box becomes invalid).

If a range is selected in the panel, that range is specified as the default. If there is no selection, then the range currently visible in the panel is specified.

(4) Click the [Save] button

Trace data is saved in the specified file with the specified format.

Figure 2-93. Output Example of the Trace Data

Number	Time	Line Number/Address	Source/Disassemble	Address	Data
Number	Time	Line Number/Address	Source/Disassemble	Address	Data
:	:	:	:	:	:

2.12 Measure Execution Time of Programs

This section describes how to measure the execution time of the program.

2.12.1 Measure execution time until stop of the execution

In the debug tool, there is a function to measure the program execution time (Run-Break time) from the start to the stop. Therefore, when the program starts its execution, the execution time is automatically measured. You can check the result of the measurement by either one of the following.

Caution [Simulator]

To use this function, [Yes] must be specified with the [Use timer function] property in the [Timer] category in the [Debug Tool Settings] tab of the Property panel.

Remark

This function is operated by the Run-Break Timer event, which is one of the built-in events set by default in the debug tool. The Run-Break Timer event is always set to **Valid state** (changes not allowed).

(1) Check in the status bar

After the program is stopped, the result of the measurement is displayed in the status bar on the **Main window** (when measurements have not been performed yet, "Unmeasurement" is displayed).

Figure 2-94. Example of the Result of the Run-Break Timer Event (Status Bar)

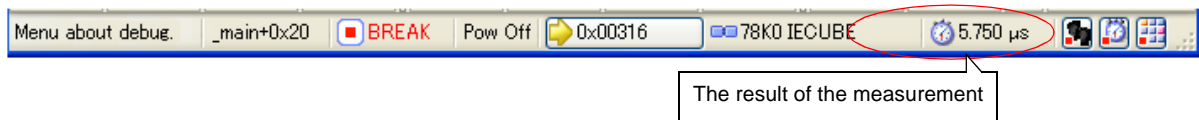

(2) Check on the Events panel

After the program is stopped, the result of the measurement is displayed in the **Events panel** opened by selecting the [View] menu >> [Event], in event type as "Run-Break Timer".

Figure 2-95. Example of the Result of the Run-Break Timer Event (Events Panel)

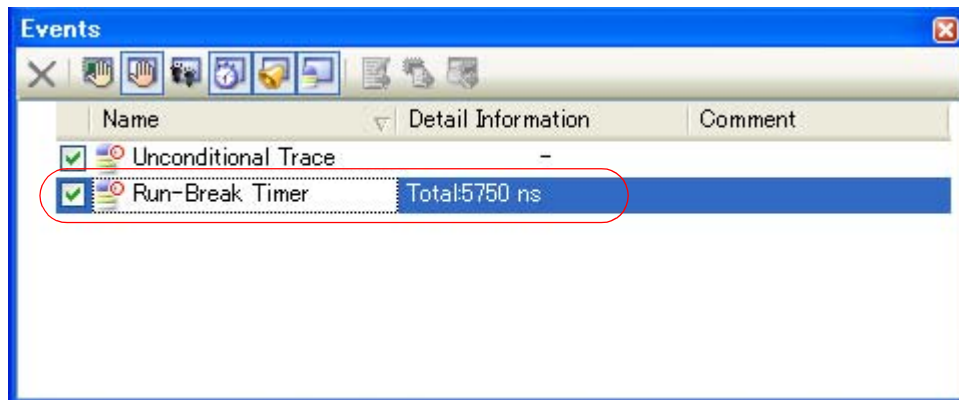

2.12.2 Measure execution time in the arbitrary section [IECUBE][Simulator]

In the program execution process, the execution time in the arbitrary section can be measured by setting the Timer result event (Start Timer event/Stop Timer event).

To use this function, follow the steps below.

- Cautions 1. Also see "2.15.6 Notes for setting events" for details on Timer Result events (e.g. limits on the number of enabled events).
- 2. [MINICUBE2]
The Timer result event is not supported.
- 3. [Simulator]
To use this function, [Yes] must be specified with the [Use timer function] property in the [Timer] category in the [Debug Tool Settings] tab of the Property panel.

(1) Set a Start Timer event/Stop Timer event

Set a Start Timer event/Stop Timer event in the Editor panel/Disassemble panel.

(a) How to set a Start Timer event

Move the caret to the line/address^{Note} to start the timer then select [Timer Settings] >> [Start Timer] from the context menu. A Start Timer event is set to the instruction at the start address of the line/address where the caret exists.

(b) How to set a Stop Timer event

Move the caret to the line/address^{Note} to stop the timer then select [Timer Settings] >> [Stop Timer] from the context menu. A Stop Timer event is set to the instruction at the start address of the line/address where the caret exists.

Note Start Timer events/Stop Timer events cannot be set at lines in the event area with the background color in gray (showing to the corresponding address of the line that no change is allowed).

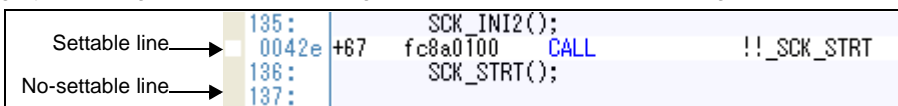

Once a Start Timer event/Stop Timer event is set, the following event marks are displayed in the event area of the line/address that an event is set. Start Timer events and Stop Timer events are managed as a single event (Timer Result event) in the Events panel (details about the set Start Timer event/Stop Timer event can be checked by clicking the plus mark "+" next to the Timer Result event item).

Table 2-11. Event Marks of the Start Timer Event/Stop Timer Event

Event Type	Event mark
Start Timer	
Stop Timer	

Figure 2-96. Start Timer Event/Stop Timer Event Setting Example

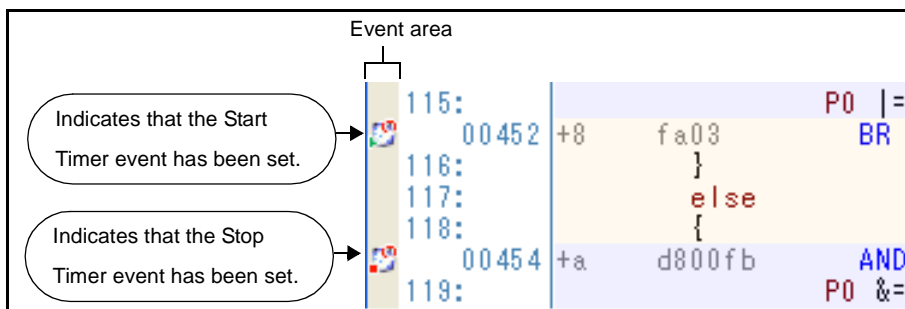

Remark Event marks differ depending on the event state (see "2.15.1 Change the state of set events (valid/invalid)").

When an event is set at the point which other event is already set, the event mark (🔒) is displayed meaning more than one event is set at the point.

(2) Execute the program

Execute the program (see "2.7 Execute Programs").

If the instruction with the Start Timer event/Stop Timer event executes, the timer starts/stops.

After the program is stopped, the result of the measurement is displayed in the Events panel opened by selecting the [View] menu >> [Event], in event type as "Timer Result".

This "Timer Result" is the even type that is registered in the Events panel bundled in one event when both the Start Timer event and the Stop Timer event setting is completed.

Figure 2-97. Timer Result Event (Start Timer Event/Stop Timer Event) Setting Example

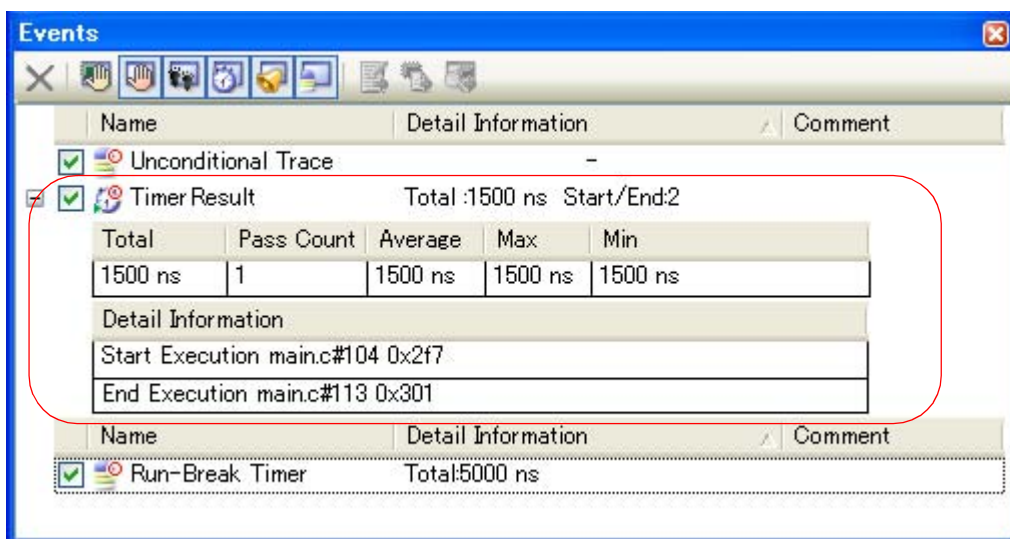

(3) Delete the Start Timer event/Stop Timer event

To delete the set Start Timer event/Stop Timer event, select [Delete Event] from the context menu that appears by right clicking on the event mark in the event area.

2.12.3 Measurable time ranges

The scope of time that can be measured via timers using Run-Break Timer events (see "2.12.1 Measure execution time until stop of the execution" for details) or Timer Result events (see "2.12.2 Measure execution time in the arbitrary section [IECUBE][Simulator]" for details) is shown below.

If the maximum measurable length of time is exceeded, a timer-over break is generated, and program execution stops.

Table 2-12. Measurable Time Ranges

Debug Tool	Run-Break Timer Event		Timer Result Event	
IECUBE	Min.	20 ns (time for 1 cycles)	Min.	20 ns (time for 1 cycles)
	Max.	Approx. 48 hours 50 min. (time for 2K cycles) Overflow detection included	Max.	Approx. 48 hours 50 min. (time for 2K cycles) Maximum elapsed cycles: 4294967295 times Overflow detection included
MINICUBE2	Min.	20 μs	-	
	Max.	Approx. 119 hours 18 min. Overflow detection included		
Simulator	Depends on the clock frequency for timer/trace		Depends on the clock frequency for timer/trace	

2.13 Measure Coverage [IECUBE][Simulator]

This section describes the coverage measurement using the coverage function.

Although there are several types of coverage measurement, CubeSuite measures code coverage (C0 coverage) based on fetch-size for a source line/function and data coverage based on access-size for a variable.

The coverage measurement area is as follows:

Table 2-13. Coverage Measurement Area

Debug Tool	Code Coverage Measurement Area
IECUBE	Internal ROM, Internal bank ROM, Internal RAM, Internal extend RAM, Buffer RAM, Emulation ROM, Target memory
Simulator	Internal ROM, Internal bank ROM, Internal RAM, Internal extend RAM, Buffer RAM, Emulation ROM/ RAM, Target memory

Caution [MINICUBE2]
The coverage function is not supported.

Remark C0 coverage: Instruction coverage (statement coverage)
 For example, when all statements in a code have been executed at least once, the C0 coverage is 100%.

2.13.1 Configure the coverage measurement

You need to configure the code coverage measurement before using the coverage function.
 The setting method differs depending on the debug tool used.

- (1) [IECUBE]
- (2) [Simulator]

(1) [IECUBE]
 You can configure the coverage measurement in the [Coverage] category in the [Debug Tool Settings] tab of the Property panel as follows:

Figure 2-98. [Coverage] Category [IECUBE]

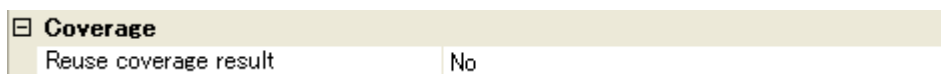

(a) [Reuse coverage result]
 Specify whether to restore the previous code coverage measurement result when connecting to the debug tool by automatically saving the acquired code coverage measurement result when disconnecting from the debug tool. Select [Yes] to restore the previous code coverage measurement result ([No] is selected by default).

(2) [Simulator]
 You can configure the coverage measurement function in the [Coverage] category in the [Debug Tool Settings] tab of the Property panel as follows:

Figure 2-99. [Coverage] Category [Simulator]

Coverage	
Use coverage function	Yes
Reuse coverage result	No

(a) [Use coverage function]

Specify whether to use the coverage function from the drop-down list.
 Select [Yes] to use the coverage function ([No] is selected by default).

(b) [Reuse coverage result]

This property appears only when the [Use coverage function] property is set to [Yes].
 Specify whether to restore the previous code coverage measurement result when connecting to the debug tool by automatically saving the acquired code coverage measurement result when disconnecting from the debug tool.
 Select [Yes] to restore the previous code coverage measurement result ([No] is selected by default).

2.13.2 Display the coverage measurement result

The code coverage measurement is automatically started when the program starts executing, and is stopped when the program stops.

(1) Code coverage



(a) Displaying the code coverage ratio for each source text line/disassembled text line

The code coverage ratio for each source text line/disassembled text line can be checked in the [Editor panel/Disassemble panel](#) that is displaying the target program.
 In each panel, background colors of the target source text lines/disassembled text lines are shown as "Table 2-15.", based on the coverage ratio obtained by using the expressions indicated in "Table 2-14."
 Note that the displaying of the code coverage ratio is not performed while executing a program or disconnecting from the debug tool.
 All the code coverage measurement result can be cleared by selecting [Clear Coverage Information] from the context menu in the [Editor panel/Disassemble panel](#) (the color distinctions on the panels are also reset).

Table 2-14. Expressions of Code Coverage Ratio

Panel	Expressions
Editor panel	"Number of bytes of code executed in the address range corresponding to the source text line" / "Total number of bytes of code in the address range corresponding to the source text line"
Disassemble panel	"Number of bytes of code executed in the address range corresponding to the disassembled text line" / "Total number of bytes of code in the address range corresponding to the disassembled text line"

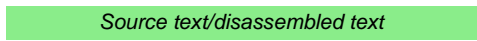
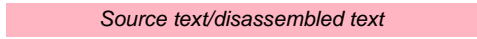
Table 2-15. View of Code Coverage Measurement Result (Default)

Code Coverage	Background Color
100 %	 Source text/disassembled text
1 to 99 %	 Source text/disassembled text
0 % (not yet executed)	 Source text/disassembled text

- Remarks 1. The code coverage measurement result is automatically updated at a break in each panel.
- 2. Background colors above depend on the configuration in the [General - Font and Color] category of the Option dialog box.
- 3. Background colors above are not shown outside the coverage measurement area (Table 2-13. Coverage Measurement Area).
- 4. When the downloaded lode module file is older than the source file currently being open, the displaying of the code coverage measurement result is not performed in the Editor panel.

Figure 2-100. View of the Code Coverage Measurement Result (Editor Panel)

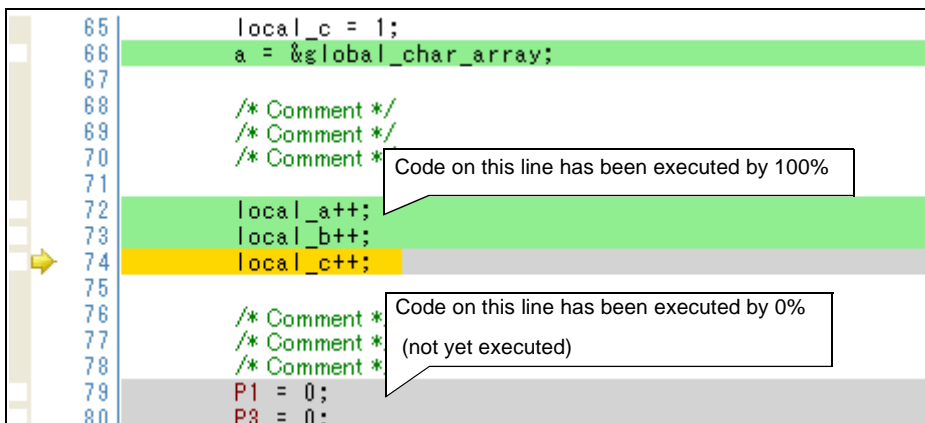
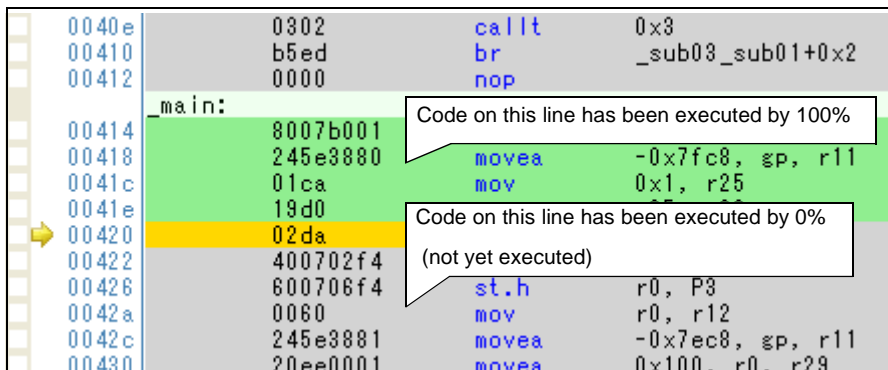

Figure 2-101. View of the Code Coverage Measurement Result (Disassemble Panel)



(b) Displaying the code coverage ratio for each function

The code coverage ratio for each function can be checked by the [Code Coverage[%]] item in the Function List panel of the analyze tool. For details on "the code coverage ratio of the function", see "CubeSuite Analysis".

(2) Data coverage

The data coverage ratio for each variable can be checked by the [Data Coverage[%]] item in the Variable List panel of the analyze tool. For details on "the data coverage ratio of the variable", see "CubeSuite Analysis".

2.14 Set an Action into Programs

This section describes how to set the specified action into the program.

2.14.1 Inset printf

By setting the Printf event that is one of "action events", the value of the specified variable expression can be output the [Output panel](#) by executing a printf command after temporary stopping the program in execution at an arbitrary position. To use this function, follow the steps below.

- Cautions 1.** Also see "[2.15.6 Notes for setting events](#)" for details on Printf events (e.g. limits on the number of enabled events).
- 2.** Once a Printf event has been set, its variable expressions cannot be edited. If you need to edit a variable expression, first delete the Printf event and then create a new one.
- 3.** When [Yes] is specified with the [Execute instruction at breakpoint when break] property in the [Break] category on the [\[Debug Tool Settings\] tab](#) in the [Property panel](#), all of Printf events currently being set are handled as Hardware Break events (printf commands will not be executed).

(1) Set a Printf event

Set a Printf event to the position where you want to execute the printf command in the [Editor panel/Disassemble panel](#).

Select [Register Action Event...] from the context menu after moving the caret to the line/address^{Note} to set a Printf event in the Editor panel/Disassemble panel to open the following the [Action Events dialog box](#).

In this dialog box, follow the steps below.

Note Printf events cannot be set at lines in the event area with the background color in gray (showing to the corresponding address of the line that no change is allowed).

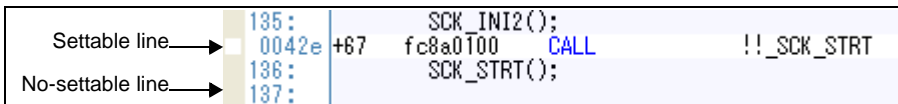
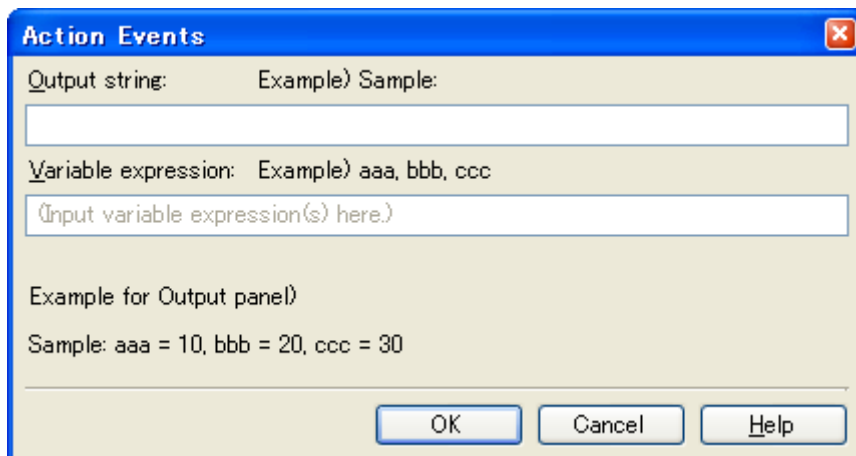

Figure 2-102. Set Printf Event (Action Events Dialog Box)



(a) Specify [Output string]

Directly enter from the keyboard the characters to add when output to the [Output panel](#). Characters must be in one line (spaces allowed).

(b) Specify [Variable expression]

Specify the variable expression for the Printf event to take place.

Type a variable expression directly into the text box (up to 1024 characters).

You can specify up to 10 variable expressions for a single Printf event by separating them with commas ",".

If this dialog box is opens with a variable expression selected in the [Editor panel/Disassemble panel](#), the selected variable expression appears as the default.

For the basic input format that can be specified as variable expressions and the values output by Printf event, see "[Table A-14. Relationship between Variable Expressions and Output Value \(Printf Event\)](#)".

(c) Click the [OK] button

Set the Printf event to the line/address at the caret position in the [Editor panel/Disassemble panel](#).

When the Printf event is set, the  mark is displayed in the event area on the Editor panel/Disassemble panel, and the set Printf event is managed in the [Events panel](#) (see "[2.15 Manage Events](#)").

(2) Execute the program

Execute the program (see "[2.7 Execute Programs](#)").

By executing the program, the program momentarily stops immediately before executing the instruction at the location where this event is set, and the value of the variable expression specified in this dialog box is output to the [Output panel](#).

(3) Check the output result

The output result format from the Printf event in the [Debug Tool] tab of the [Output panel](#) are as follows:

Figure 2-103. Example of Output Result of Printf Event

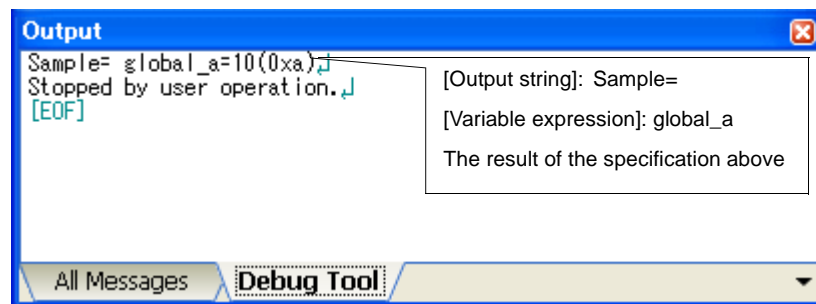

2.15 Manage Events

An event represents a certain status of the target system when debugging such as "Address 0x1000 is fetched" and "Data is written to address 0x2000".

In CubeSuite, these events are used as the action trigger of the debug function such as breakpoint, start/stop the tracing, and start/stop the timer.

This section describes how to manage those events.

Select the [View] menu >> [Event].

Events are all managed in the [Events panel](#). In the Events panel, you can confirm the details of the currently set events in a list, and they can be deleted and changed enable/disable status.

For details on the contents and function in each area, see the section for the [Events panel](#).

Figure 2-104. Manage Events (Events Panel)

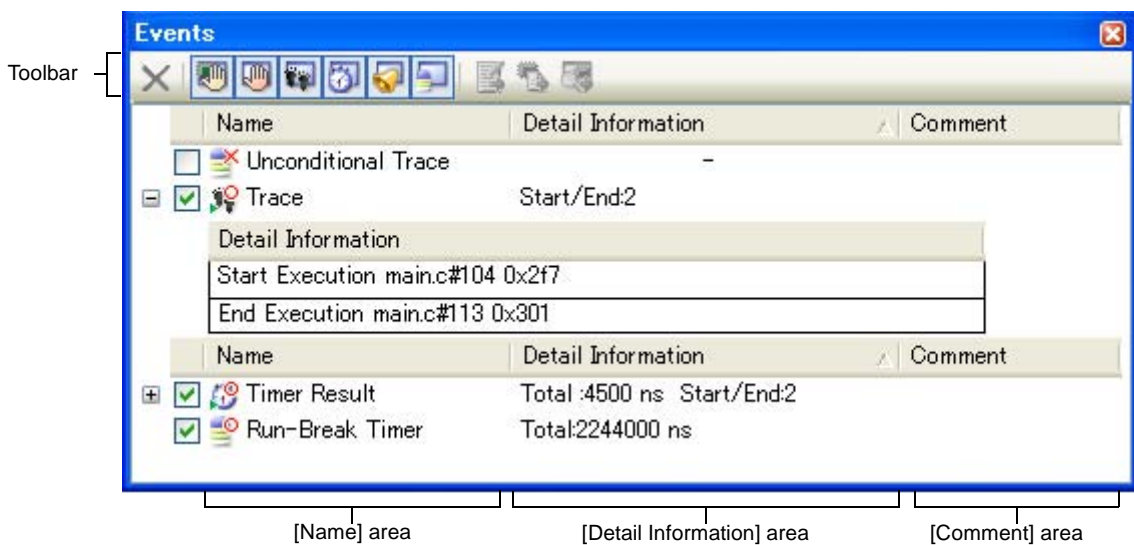

2.15.1 Change the state of set events (valid/invalid)

By changing the check on the check box of the event name, the setting state of the event can be changed (the [Event mark](#) is changed depending on the setting state of the event).

The following are types of the setting state of the event.

Figure 2-105. Check Box of the Event

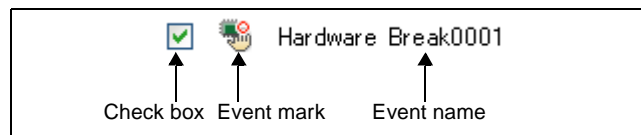







Table 2-16. Setting State of the Event

<input checked="" type="checkbox"/>	Valid state	Event occurs when the specified condition is met. It is possible to set the event to an invalid state by removing the check.
<input type="checkbox"/>	Invalid state	Event does not occur when the specified condition is met. It is possible to set the event to a valid state by removing the check.
<input type="checkbox"/>	Suspended State	The conditions that have been specified cannot be set with the program of the debugging target. It is not possible to operate the check box.

- Remarks 1.** Both of the Start Timer event and the Stop Timer event is must be set for the Timer Result event. Therefore, it is not possible to set a particular event to a valid state by only the setting of one of these (at the same time as both events are set, they are treated as grouped events as a Timer Result).
2. It is not possible to set the Run-Break Timer event to an invalid/suspended state.
 3. The setting state of the event can be changed from the menu displayed by right clicking on the [Event mark](#) in the [Editor panel/Disassemble panel](#).
 4. The setting of the Unconditional Trace event and the Trace event to valid or invalid state is exclusively controlled. Therefore, the Unconditional Trace event, which is a built-in event, is valid state by default, but if either a Start Tracing event/Stop Tracing event is set, it automatically becomes invalid state, and the Trace event, which is a event name that is collectively called with a Start Tracing event and a Stop Tracing event, becomes valid state. Conversely, if the set Trace event is invalid state, the Unconditional Trace event automatically becomes valid state.

2.15.2 Display only particular event types



Click on the toolbar button to display only the particular event type.

	Displays events related to the Hardware Break.
 [IECUBE][MINICUBE2]	Displays events related to the Software Break.
 [IECUBE][Simulator]	Displays events related to the trace.
 [IECUBE][Simulator]	Displays events related to the timer.
	Displays events related to the action event (Printf event).
	Displays the built-in events (Unconditional Trace event and Run-Break Timer event).

2.15.3 Jump to the event address

Clicking the following buttons jumps to each panel which selected events address exist.

Note however, that when a Trace event/Timer Result event/ Unconditional Trace event/ Run-Break Timer event is selected, these button becomes invalid.

	Opens the Editor panel and jumps to the source line corresponding to the address where the selected event is being set.
	Opens the Disassemble panel and jumps to the disassemble results corresponding to the address where the selected event is being set.
	Opens the Memory panel and jumps to the source line corresponding to the address where the selected event is being set.

2.15.4 Delete events

To delete the set event, select the event and click the  button in the toolbar.

Note that it is not possible to delete the built-in events (Unconditional Trace event and Run-Break Timer event).

- Remarks 1.** For the Break event of execution type, it is possible to delete the set event to click the event mark displayed in the [Editor panel/Disassemble panel](#).
2. To delete all of the set event, select [Select All from the context menu, then click the  button (note, however, that it is not possible to delete the built-in events).

2.15.5 Write comment to events

The user can write comments for each event that has been set.

To input comments, click the [Comment] area after selecting the event to input comments, then input directly the desired text from the keyboard (the edit mode is cancelled by pressing the [Esc] key).

After editing the comments, complete the editing by pressing the [Enter] key or moving the focus to outside the edit region.

Up to 256 characters can be inputted for the comments, and this is saved as the settings of the user during use.

2.15.6 Notes for setting events

This section describes notes for setting each type of event.

- (1) [Maximum number of enabled events](#)
- (2) [Event types that can be set and deleted during execution](#)
- (3) [Other notes](#)

(1) Maximum number of enabled events

The number of events that can be set to [Valid state](#) simultaneously is limited as follows:

Consequently, if enabling a new event would exceed the limit, you must first set some other event to [Invalid state](#).

Table 2-17. Maximum Number of Enabled Events

Event Type	Debug Tool to Use		
	IECUBE	MINICUBE2	Simulator
Hardware Break (before execution)	16	1 ^{Note 2}	64 ^{Note 3}
Hardware Break (after execution)	8	-	
Hardware Break (access)	10 ^{Note 1}	1	
Software Break	2000	2000 ^{Note 2}	-
Trace (Start Tracing/Stop Tracing)	4 + 5 ^{Note 4}	-	32 ^{Note 4}
Point Trace	8 + 10	-	64
Timer Result (Start Timer/ Stop Timer)	4 + 5 ^{Note 4}	-	1
Action (Printf)	100 ^{Note 5}		64 ^{Note 6}

- Notes**
1. 8 dedicated byte-access events and 2 dedicated word-access events
 2. Used exclusively for Hardware Break events (before execution) and Software Break events
 3. The before break/after break can be specified in the [Property panel](#).
 4. Only one group can be set (however, two or more Start/Stop events can be set)
 5. Combination with Software Break events
 6. Combination with Hardware Break events

(2) Event types that can be set and deleted during execution

The following types of events can be set or deleted during program execution, or during tracer/timer execution.

Table 2-18. Event Types That Can be Set and Deleted during Execution

Function	Debug Tool to Use		
	IECUBE	MINICUBE2	Simulator
Hardware Break (before execution)	○	▲	▲
Hardware Break (after execution)	○	▲	▲
Hardware Break (access)	○	▲	▲
Software Break	△	▲	—
Trace (Start Tracing/Stop Tracing)	○	—	▲
Point Trace	○	—	▲
Timer Result (Start Timer/Stop Timer)	○	—	▲
Action (Printf)	○	▲	▲

○ : Yes

△ : Yes, if the program execution is allowed to pause for events^{Note}

▲ : Not while tracer or timer is executing

— : Not supported

Note To enable this, specify [Yes] with the [Set event by stopping execution momentarily] property in the [Set Event While Running] category in the [\[Debug Tool Settings\] tab](#) of the [Property panel](#).

(3) Other notes

- Events do not occur during step execution (including return execution) and program execution by selecting [Go to Here] from the context menu.
- If the location set for an existing event changes to midway in an instruction because the program to debug has been downloaded again, re-set the event using the following method.
 - If debugging information is available:
 - The location setting of events is always moved to the beginning of the source text line.
 - If debugging information is not available:
 - Depends on the [Automatic change method of event setting position] property in the [Download] category in the [\[Download File Settings\] tab](#) of the [Property panel](#).
- If a change to internal ROM/RAM, or memory-bank size changes the location the event is set to a non-mapped area, then set events will not occur (they will also not change to [Invalid state](#) /[Suspended State](#) on the [Events panel](#)).
- **[IECUBE][MINICUBE2]**
 - Hardware Break events with access conditions and Point Trace events **[IECUBE]** cannot be set for 32-bit (4-byte) variables.
 - Additionally, Hardware Break events with access conditions and Point Trace events **[IECUBE]** cannot be detected if a single byte of a 16-bit (2-byte) variable is accessed.

2.16 Use Hook Function

This section describes how to set hooks in the debug tool using the hook function.

By setting a hook transaction, you can automatically change the values of the SFR/CPU register before and after downloading a load module or after resetting the CPU.

Configure the hook transaction in the [Hook Transaction Settings] category in the [Hook Transaction Settings] tab of the Property panel.

Remark By setting a SFR by using the [Before download] property, for example, downloading can be executed at high speeds.
 Downloading to the external RAM is also facilitated by using this function.

Figure 2-106. [Hook Transaction Settings] Category

[-] Hook Transaction Settings	
[+] Before download	Before download[0]
[+] After download	After download[0]
[+] After CPU reset under breaking	After CPU reset under breaking[0]
[+] Before running	Before running[0]
[+] After breaking	After breaking[0]

Table 2-19. Properties in the [Hook Transaction Settings] Category

Property	Description
Before download	Perform the specified process immediately before downloading the load module file.
After download	Perform the specified process immediately after downloading the load module file.
After CPU reset under breaking	Perform the specified process immediately after resetting the CPU.
Before running	Perform the specified process immediately before starting program execution.
After breaking	Perform the specified process immediately after breaking program execution.

The properties in the [Hook Transaction Settings] category indicate the timing with which the hook process will be performed. "[0]" indicates the current number of specified processes (no hook processes are configured by default).

Specify the target process in the property for which you want the hook process to be performed.

To specify a process, select the target property, then open the Text Edit dialog box by clicking the [...] button appears on the right edge of the field.

Figure 2-107. Opening the Text Edit Dialog Box

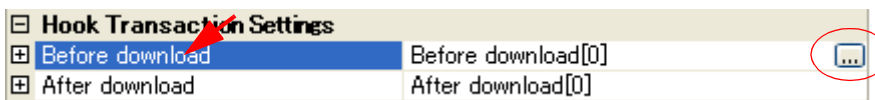
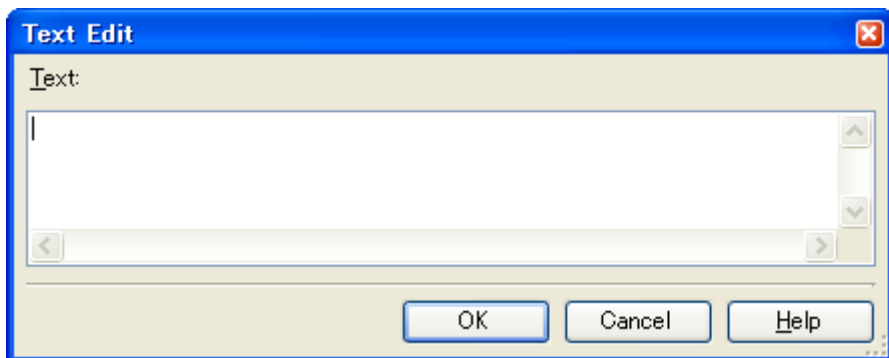

Figure 2-108. Use Hook Function (Text Edit Dialog Box)



In this dialog box, directly enter the desired process from the key board.

The format for specifying processes is as follows. The value of the specified *SFR/CPU* register will be overwritten with the specified value automatically at the corresponding time.

- *SFR name/CPU register name + space + specified value*

Up to 64 characters for one process, and up to 128 processes for each property can be set (one line in the [Text] area in the *Text Edit dialog box* is equivalent to one processing).

After the specification of the process is complete, click the [OK] button to set the process to the *Property panel*.

Figure 2-109. Example of Hook Transaction

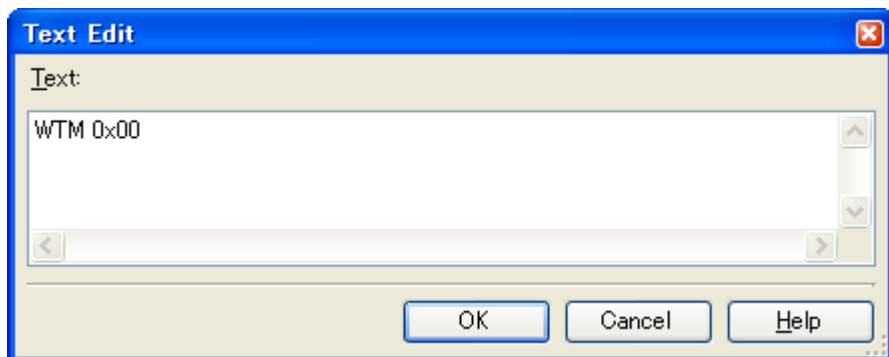

- Remarks 1. When specifying hook processes, lines starting with a hash mark "#" will be treated as comments.
- 2. A tab character can be used instead of the space character.

2.17 Use the Simulator GUI [Simulator]

This section describes how to use the Simulator GUI.

Note that the function of the Simulator GUI described in this section is only supported when a microcontroller whose Simulator supports peripheral function simulations is selected.

Control the Simulator GUI via the [Simulator GUI window](#) below.

This window appears automatically by default after connecting to the debug tool when a microcontroller whose Simulator supports peripheral function simulations is selected and [Simulator] is selected as the debug tool to use.

Remark The [Simulator GUI window](#) and windows opened from it cannot be docked to the CubeSuite [Main window](#).

Figure 2-110. Using the Simulator GUI (Simulator GUI Window)

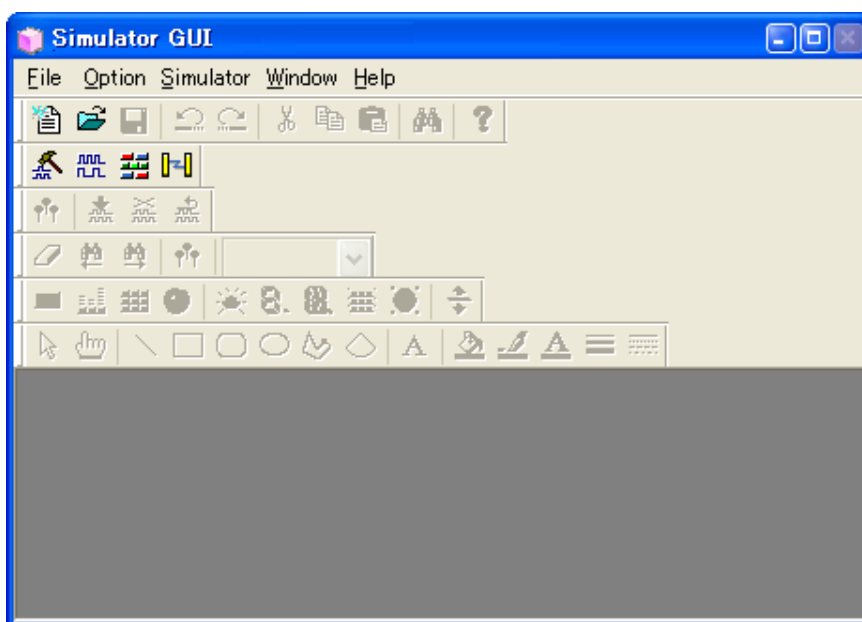

The setting of the display of the [Simulator GUI window](#) can be configured in the [Simulator GUI] category on the [\[Debug Tool Settings\] tab](#) of the [Property panel](#) as follows:

Configure the appropriate settings.

Caution After connecting to the debug tool, all the properties in this category will become invalid when a microcontroller whose Simulator does not support peripheral function simulations (instruction simulation version) is selected.

Figure 2-111. [Simulator GUI] Category

Simulator GUI	
Display Simulator GUI	Yes
Display Simulator GUI on top of other windows	Yes

(1) [Display Simulator GUI]

Specify whether to display the [Simulator GUI window](#) from the drop-down list.

Select [Yes] to use the function of the Simulator GUI (default).

When you do not need to use the Simulator GUI, select [No] to close the [Simulator GUI window](#).

(2) [Display Simulator GUI on top of other windows]

This property appears only when the [Display Simulator GUI] property is set to [Yes].

Specify whether to display the Simulator GUI window in the forefront when program execution starts. Select [Yes] to display it in the forefront (default).

2.17.1 Check the I/O waveform of the microcontroller

It is possible to check the I/O waveform of the microcontroller by clicking the  button on the Simulator GUI window's toolbar and opening the Timing Chart window (shown below).

This window displays a timing chart of the input and output signals of the microcontroller's pins.

See the section on the Timing Chart window for details about controlling the window.

Figure 2-112. Checking the I/O Waveform of the Microcontroller (Timing Chart Window)

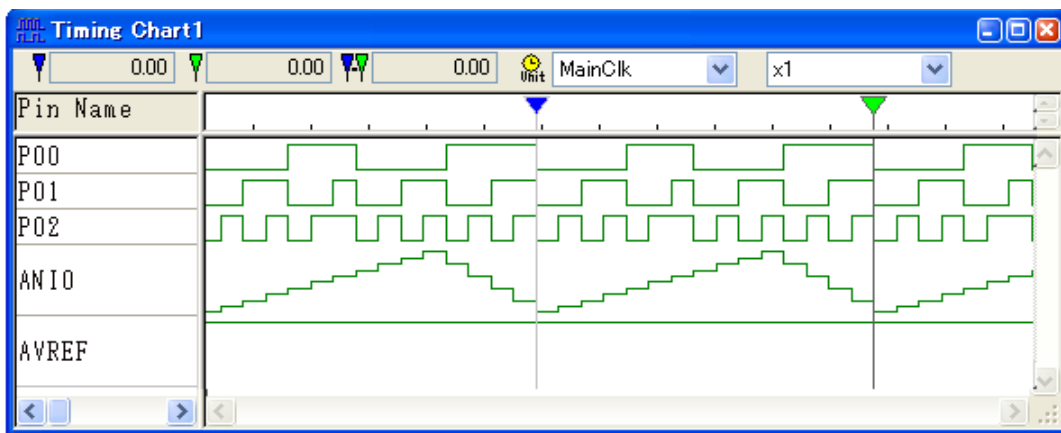

2.17.2 Input signals to the pins

To configure the input signal to a pin, click the  on the Simulator GUI window's toolbar. The following Signal Data Editor window opens.

You can use this window to set the input signal data for the input pin to a numerical value, to be input at an arbitrary time.

See the section on the Signal Data Editor window for details about controlling the window.

Figure 2-113. Configuring the Input Signal to a Pin (Signal Data Editor Window)

	Mark	Wait	P00	P01	P02	ANIO	AVREF
1		100	0	0	0	0	5000
2		100	0	0	1	500	5000
3		100	0	1	0	1000	5000
4		100	0	1	1	1500	5000
5		100	1	0	0	2000	5000
6		100	1	0	1	2500	5000
7		100	1	1	1	3000	5000
8		100	0	0	0	3500	5000
9		100	0	0	1	4000	5000
11		100	0	1	0	4500	5000
12		100	1	0	1	3000	5000

2.17.3 Perform serial communication

To configure serial communication, click the  on the Simulator GUI window's toolbar. The following Serial window opens.

This window provides serial I/O features for communicating with the CPU's built-in serial interface. This enables you to input data to the microcontroller's serial receiver pin, and acquire output data from its serial transmitter pin.

See the section on the Serial window for details about controlling the window.

Figure 2-114. Performing Serial Communication (Serial Window)

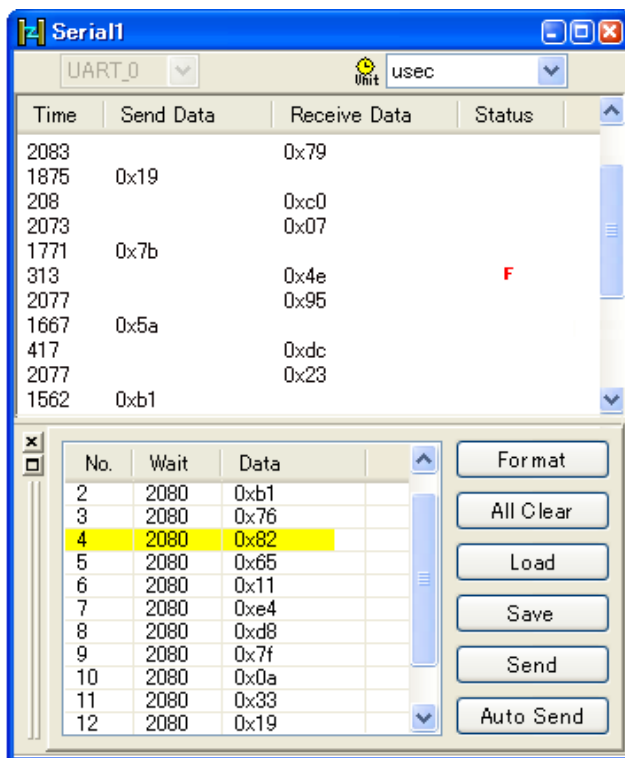

2.17.4 Use buttons, LEDs, level gauges, and other components

The Simulator GUI allows input manipulation and output display simulation by providing standard connected parts (buttons, LEDs, level gauges, etc.) in which the I/O block for peripheral I/O designed as a GUI interface.

To configure connected parts, click the  on the Simulator GUI window's toolbar. The following I/O Panel window opens.

This window enables you to configure the various connected parts, building a dummy target system.

See the section on the I/O Panel window for details about controlling the window.

Figure 2-115. Configuring Connected Parts (I/O Panel Window)

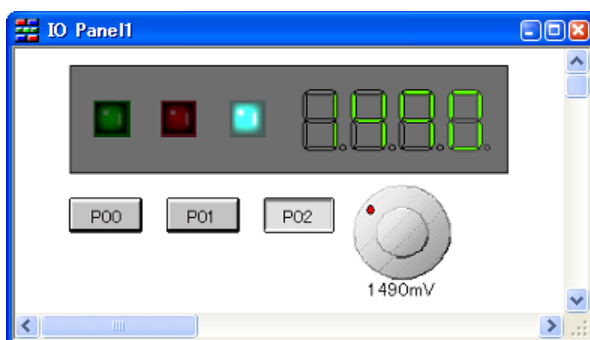

2.18 About Input Value

this section describes consideration to take when inputting values in each.

2.18.1 Input rule

Following is the rules for input to each panel/dialog box.

(1) Character set

Character sets that are allowed to input are as follows:

Table 2-20. List of Character Set

Character Set	Outline
ASCII	1- byte alphabets, numbers, symbols
Shift-JIS	2-byte alphabet, number, symbol, Hiragana, Katakana, Kanji and 1-byte Katakana.
EUC-JP	2-byte alphabet, number, symbol, Hiragana, Katakana, Kanji and 1-byte Katakana.
UTF-8	2-byte alphabet, number, symbol, Hiragana, Katakana, Kanji (include Chinese characters) and 1-byte Katakana.

(2) Number

Notations allowed when entering numbers are as follows:

Table 2-21. Notation List

Notation	Outline
Octal number	Start with 0 and continues with the numbers from 0 to 7.
Decimal	Start without 0 and continues with the numbers from 0 to 9.
Hexadecimal number	Start with 0x and continues with the numbers from 0 to 9 and alphabets a to f. (Case insensitive for alphabets) In the input area with the HEX mark, prefix 0x is not needed.

(3) Expression and operator

Expression represents constants, register name, SFR name and symbols and those connected with operators. When SFR name, label name, function name and variable name are described as symbols, the address is operated as a value of symbols.

The basic input formats are as follows:

Table 2-22. Basic Input Format of Expressions

Expression	Description
Variable name of C language	Value of C language variable
<i>Expression</i> [<i>Index</i>]	Element of array
<i>Expression</i> Member name	Member of structures/unions
<i>Expression</i> ->Member name	Member of structures/unions that pointer designates
* <i>Expression</i>	Value of pointer variable
& <i>Expression</i>	Location address
Name of CPU Register	Value of the CPU register

Expression	Description
SFR	SFR value
Label, EQU symbol and immediate address	Values of label, EQU symbol and immediate address
Register name.bit	Register name.bit value
Label name.bit, EQU symbol.bit, immediate address.bit	Label name.bit value, EQU symbol. bit value, immediate address.bit value
Bit symbol	Bit symbol value
Integer constant	Integer constant value
Floating constant	Floating point constant value
Character constant	Character constant value

From "Table 2-22. Basic Input Format of Expressions", the following expressions with operator can be constructed.

Table 2-23. Construction of Expressions with Operators

Expression	Description
<i>(Expression)</i>	Value of the parenthetical watch-expression
<i>! Expression</i>	Logical negation
<i>~ Expression</i>	Bit inversion
<i>Expression ++</i>	Backward increment
<i>Expression --</i>	Backward decrement
<i>++ Expression</i>	Forward increment
<i>-- Expression</i>	Forward decrement
<i>(Data type) Expression</i>	Type casting
<i>size of Expression</i>	Object size
<i>size of (type name)</i>	Type size
<i>Expression * Expression</i>	Product
<i>Expression / Expression</i>	Quotient
<i>Expression % Expression</i>	Residue
<i>Expression + Expression</i>	Sum
<i>Expression . Expression</i>	Difference
<i>Expression << Expression</i>	Left shift
<i>Expression >> Expression</i>	Right shift
<i>Expression < Expression</i>	When it is "smaller", 1 is set, others 0 is set.
<i>Expression <= Expression</i>	When it is "smaller, or equal", 1 is set, others 0 is set.
<i>Expression > Expression</i>	When it is "bigger", 1 is set, others 0 is set.
<i>Expression >= Expression</i>	When it is "bigger, or equal", 1 is set, others 0 is set.
<i>Expression == Expression</i>	When it is "equal", 1 is set, others 0 is set.

Expression	Description
<i>Expression != Expression</i>	When it is not "equal", 1, others 0.
<i>Expression & Expression</i>	Logical multiplication by bits
<i>Expression ^ Expression</i>	Exclusive disjunction by bits
<i>Expression Expression</i>	Logical sum by bits
<i>Expression && Expression</i>	Logical multiplication
<i>Expression Expression</i>	Logical sum

2.18.2 Icons for invalid input

In some of the dialogs in CubeSuite, the  icons that represent that the input value is invalid when some invalid characters are input are shown at the relevant location and warns by changing the character color to red.

Remark When the mouse cursor is hover over the  icon, information on the valid characters to input is pops up.

APPENDIX A WINDOW REFERENCE

Appendix A provides detailed explanations of windows/panels/dialog boxes used for debugging with CubeSuite.

A.1 Description

Windows/panels/dialog boxes for debugging are listed below.

Table A-1. Window/Panel/Dialog Box List

Window/Panel/Dialog Box Name	Description
Main window	Controls program execution. Various windows, panels and dialogs can be opened from this window.
Project Tree panel	Selects the debug tool to use.
Property panel	Displays detailed information on the debug tool currently selected in the Project Tree panel , and enables the settings of the tool to be changed.
Editor panel	Enables text files to be viewed and edited, and is used to execute source level debug.
Memory panel	Displays and modifies memory values.
Disassemble panel	Displays the results of memory value disassemble and is used to execute line assemble and instruction level debug.
CPU Register panel	Displays the contents of CPU registers, and modifies register values.
SFR panel	Displays and modifies SFR values.
Local Variables panel	Displays and modifies local variables.
Watch panel	Displays and modifies registered watch-expression values.
Call Stack panel	Displays call stack information on function calls.
Trace panel [IECUBE][Simulator]	Displays trace data acquired from the debug tool.
Events panel	Displays detailed information on set events, switches the events between enabled and disabled, or deletes them.
Output panel	Displays messages output from the build tool/debug tool/plugin-ins, or the results of batch searches carried out using the Search and Replace dialog box.
Memory Mapping dialog box	Sets the memory mapping.
Download Files dialog box	Selects files to be downloaded and sets the download conditions.
Text Edit dialog box	Inputs and modifies character strings.
Action Events dialog box	Sets action events.
Save Settings dialog box	Specifies the encoding and the new line code of the file being edited.
Memory Initialize dialog box	Initializes memory.
Memory Search dialog box	Searches memory.
Trace Search dialog box [IECUBE][Simulator]	Searches trace data.
Go to the Location dialog box	Moves the caret to the specified position.
Data Save dialog box	Saves the settings and other data displayed in the respective windows/panels/dialogs or saves upload data.

Window/Panel/Dialog Box Name	Description
Progress Status dialog box	Displays the progress of the processing being executed.
Option dialog box	Makes settings for various environments.
Select Download File dialog box	Selects files to be downloaded.
Save As dialog box	Saves files or the contents of various windows/panels/dialogs.
Select Data Save File dialog box	Selects the file to save data.
Select Simulator Configuration File dialog box [Simulator]	Selects simulator configuration file.

Table A-2. Simulator GUI Block-Dedicated Window/Dialog Box List

Window/Dialog Box Name	Description
Simulator GUI window	Opens and controls various simulator GUI's windows and dialog boxes.
Customize dialog box	Setting of window colors and fonts
Signal Data Editor window	Setting of input signal data
Loop dialog box	Setting of loop information for the Signal Data Editor window
Select Pin dialog box	Selection of display pins in the Signal Data Editor window and Timing Chart window
Timing Chart window	Timing chart display of input and output signals
Search Data dialog box	Detailed search of the Timing Chart window
I/O Panel window	Creation of dummy target system
Parts Button Properties dialog box	Setting of button pin connection information
Analog Button Properties dialog box	Setting of analog button pin connection information
Parts Key Properties dialog box	Setting of key matrix LED pin information
Parts Level Gauge Properties dialog box	Setting of level gauge pin connection information
Parts Led Properties dialog box	Setting of key matrix LED pin information
Parts Segment LED Properties dialog box	Setting of 7/14-segment LED pin connection information
Parts Matrix Led Properties dialog box	Setting of matrix LED pin connection information
Parts Buzzer Properties dialog box	Setting of buzzer pin connection information
Pull up/Pull down dialog box	Setting of pull-up/pull-down resistor pin connection information
Object Properties dialog box	Setting of connection information for figure, character, and bitmap pins
Parts List dialog box	List display of object pin connection status in the I/O Panel window
Serial window	Serial interface communication window
Format (UART) dialog box	Setting of serial format (UART)
Format (CSI) dialog box	Setting of serial format (CSI)

Main window

This window is automatically opened when CubeSuite is started up.
 In this window, you can control the program execution and open panels for the debugging process.

Figure A-1. Main Window

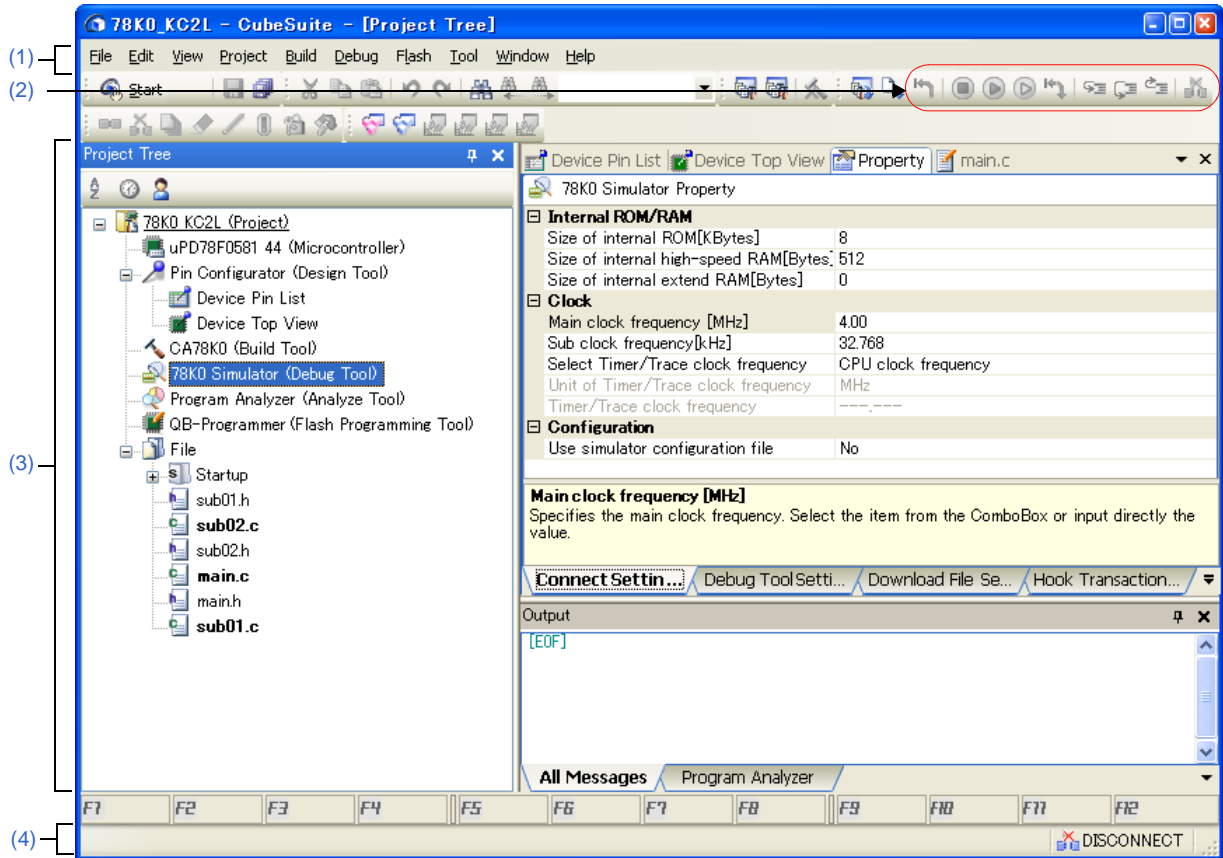

This section describes the following.

- [How to open]
- [Description of each area]

[How to open]

- From the Windows [Start] menu, select [All Programs] >> [NEC Electronics CubeSuite] >> [CubeSuite].

[Description of each area]

(1) Menubar

Menu items related to the debugging are as follows:

Remark The items that can be selected in each menu can be customized using the User Setting dialog box.

(a) [View]

The [View] menu provides the following items and functions (default).

Watch	The following cascade menus are displayed to open the Watch panel . These items are invalid while disconnecting from the debug tool.
Watch1	Opens the Watch panel (Watch1).
Watch2	Opens the Watch panel (Watch2).
Watch3	Opens the Watch panel (Watch3).
Watch4	Opens the Watch panel (Watch4).
Local Variable	Opens the Local Variables panel .
Call Stack	Opens the Call Stack panel .
Memory	The following cascade menus are displayed to open the Memory panel . These items are invalid while disconnecting from the debug tool.
Memory1	Opens the Memory panel (Memory1).
Memory2	Opens the Memory panel (Memory2).
Memory3	Opens the Memory panel (Memory3).
Memory4	Opens the Memory panel (Memory4).
SFR	Opens the SFR panel . This item is invalid while disconnecting from the debug tool.
CPU Register	Opens the CPU Register panel . This item is invalid while disconnecting from the debug tool.
Trace [IECUBE][Simulator]	Opens the Trace panel [IECUBE][Simulator] . This item is invalid while disconnecting from the debug tool.
Disassemble	The following cascade menus are displayed to open the Disassemble panel . These items are invalid while disconnecting from the debug tool.
Disassemble1	Opens the Disassemble panel (Disassemble1).
Disassemble2	Opens the Disassemble panel (Disassemble2).
Disassemble3	Opens the Disassemble panel (Disassemble3).
Disassemble4	Opens the Disassemble panel (Disassemble4).
Event	Opens the Events panel . This item is invalid while disconnecting from the debug tool.
Show Current PC Location	Displays the current PC position in the Editor panel . This item is invalid while disconnecting from the debug tool.
Back to Last Cursor Position	Goes back to the position before jumping (see "(4) Jump to functions " / "(4) Move to the symbol defined location ") to the defined location. This item is invalid while disconnecting from the debug tool.

Forward to Next Cursor Position	Forwards to the position before operating [Back to Last Cursor Position].
Tag Jump	Jumps to the corresponding line/column in the corresponding file if the information of a file name/line number/column number exists in the line at the caret position on the Editor panel/Output panel (see "(5) Jump to a desired line (tag jump) ").

(b) [Debug]

The [Debug] menu provides the following items and functions (default).

Download	Downloads the specified file(s) into the debug tool for an active project. While disconnecting from the debug tool, the download is executed after connecting to the debug tool. This item becomes invalid during execution of a program.
Build & Download	Executes the build of a project and downloads the file into the debug tool for an active project. While disconnecting from the debug tool, the download is executed after connecting to the debug tool. However, when the build has failed, download will not be executed.
Connect to Debug Tool	Connects to the debug tool for an active project.
Upload...	Opens the Data Save dialog box to save the memory contents. This item becomes invalid during execution of a program or while disconnecting from the debug tool.
Disconnect from Debug Tool	Disconnects from the currently connected debug tool.
Stop	Forcibly stops the program currently being executed. This item becomes invalid during non-execution of a program or while disconnecting from the debug tool.
Go	Executes the program from the current PC position. Execution of the program will be stopped when the condition of a set break event is met. This item becomes invalid during execution of a program or while disconnecting from the debug tool.
Ignore break and go	Executes the program from the current PC position. Execution of the program continues, ignoring set beak events and action events. This item becomes invalid during execution of a program or while disconnecting from the debug tool.
Step In	Executes the program step by step ^{Note} from the current PC position (Step in execution). However, in the case of a function call, the program is stopped at the beginning of the function having been called. This item becomes invalid during execution of a program or while disconnecting from the debug tool.
Step Over	Executes the program step by step ^{Note} from the current PC position (Step over execution). In the case of a function call by the CALL/CALLT/CALLF instruction, all the source lines/ instructions in the function are treated as one step and executed until the position where execution returns from the function (step-by-step execution will continue until the same nest is formed as when the CALL /CALLT/CALLF instruction has been executed). In the case of an instruction other than CALL/CALLT/CALLF, operation is the same as when [Step In] is selected. This item becomes invalid during execution of a program or while disconnecting from the debug tool.







Return Out	Executes the program until execution returns from the current function (or returns to the calling function) ^{Note} (Return out execution). This item becomes invalid during execution of a program or while disconnecting from the debug tool.
CPU Reset	Resets the CPU (does not execute a program) This item becomes invalid during execution of a program or while disconnecting from the debug tool.
Restart	Resets the CPU and then executes the program from the reset address. This item becomes invalid during execution of a program or while disconnecting from the debug tool.





Note Step execution can be carried out either in units of source lines or in units of instructions.
For details, see "2.7.3 Execute programs in steps".

(2) Debug toolbar

The debug toolbar provides the following buttons and functions (default).

- Remarks 1.** The buttons on the toolbar can be customized using the User Setting dialog box. Furthermore, a new toolbar can be created using the same dialog box.
- 2.** A Group of toolbar displayed can be selected with the context menu that is displayed by right-clicking on the toolbar.

	Executes the build of a project and downloads the file into the debug tool for an active project. While disconnecting from the debug tool, the download is executed after connecting to the debug tool. However, when the build has failed, download will not be executed. The function of this item is the same as that of [Build & Download] in the [Debug] menu.
	Downloads the specified file(s) into the debug tool for an active project. While disconnecting from the debug tool, the download is executed after connecting to the debug tool. The function of this item is the same as that of [Download] in the [Debug] menu.
	Resets the CPU (does not execute a program) This item becomes invalid during execution of a program or while disconnecting from the debug tool. The function of this item is the same as that of [CPU Reset] in the [Debug] menu.
	Forcibly stops the program currently being executed. This item becomes invalid during non-execution of a program or while disconnecting from the debug tool. The function of this item is the same as that of [Stop] in the [Debug] menu.
	Executes the program from the current PC position. Execution of the program will be stopped when the condition of a set break event is met. This item becomes invalid during execution of a program or while disconnecting from the debug tool. The function of this item is the same as that of [Go] in the [Debug] menu.
	Executes the program from the current PC position. Execution of the program continues, ignoring set break events and action events. This item becomes invalid during execution of a program or while disconnecting from the debug tool. The function of this item is the same as that of [Ignore break and go] in the [Debug] menu.
	Resets the CPU and then executes the program from the reset address. This item becomes invalid during execution of a program or while disconnecting from the debug tool. The function of this item is the same as that of [Restart] in the [Debug] menu.

	<p>Executes the program step by step^{Note} from the current PC position (Step in execution). However, in the case of a function call, the program is stopped at the beginning of the function having been called. This item becomes invalid during execution of a program or while disconnecting from the debug tool. The function of this item is the same as that of [Step In] in the [Debug] menu.</p>
	<p>Executes the program step by step^{Note} from the current PC position (Step over execution). In the case of a function call by the CALL/CALLT/CALLF instruction, all the source lines/instructions in the function are treated as one step and executed until the position where execution returns from the function (step-by-step execution will continue until the same nest is formed as when the CALL /CALLT/CALLF instruction has been executed). In the case of an instruction other than CALL/CALLT/CALLF, operation is the same as when the  button is clicked. This item becomes invalid during execution of a program or while disconnecting from the debug tool. The function of this item is the same as that of [Step Over] in the [Debug] menu.</p>
	<p>Executes the program until execution returns from the current function (or returns to the calling function)^{Note} (Return out execution). This item becomes invalid during execution of a program or while disconnecting from the debug tool. The function of this item is the same as that of [Return Out] in the [Debug] menu.</p>
	<p>Disconnects from the currently connected debug tool. The function of this item is the same as that of [Disconnect from Debug Tool] in the [Debug] menu.</p>

Note Step execution can be carried out either in units of source lines or in units of instructions.
 For details, see "2.7.3 Execute programs in steps".

(3) Panel display area

This area displays the various panels.

For details on the display content, see the sections describing the individual panels.

(4) Statusbar

Statusbar displays the following items of information.

Figure A-2. Statusbar

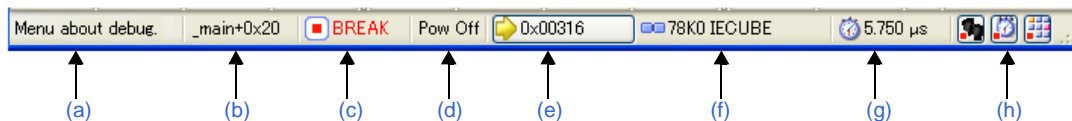

(a) Status message

This area displays the following messages and other information.

- A brief explanation of the selected menu item
- A message reporting that an invalid value has been input in the panel/dialog
- A message reporting that the specified character string has not been found as a result of a search using the Search and Replace dialog box
- A statement of the cause of the break when a break has occurred (see "2.8 Stop Programs (Break)")



(b) Focus panel status information

This area displays status information on the panel currently having the focus.

Note that nothing is displayed here for a panel that has no status information.

(c) Running state

This area displays the state of the program with the following icons and character strings.
 Note that nothing is displayed here when the debug tool is not connected.

State of Program	Display Contents
Running	 RUN
Stopped	 BREAK
In step execution	 STEP

(d) CPU status

This area displays CPU statuses of the debug tool. When there is the possibility that the CPU is in two or more statuses, the corresponding display contents are displayed separated by "&".
 Note that nothing is displayed here when the debug tool is not connected.

Debug Tool	Display Contents	CPU Status
IECUBE	Halt	In HALT mode
	Stop	In STOP mode
	Wait	In wait state
	Reset	In reset state
	Pow Off	Power not supplied to the target
MINICUBE2	Reset	In reset state
	Pow Off	Power not supplied to the target
Simulator	Halt	In HALT mode
	Stop	In STOP mode
	Reset	In reset state

(e) Current PC position

This area displays the current PC position with a hexadecimal value^{Note 1}. When this area is clicked, the caret moves to the current PC position on the [Editor panel](#).

In addition, when the mouse pointer is placed over this area, a pop-up window appears to display the following information.



- Current PC: 0x *current PC value* (*source name#line count*)^{Note 2}

Note that nothing is displayed here when the debug tool is not connected.

- Notes 1.** If the bank function is being used, then the current bank number will be assigned to the 4 higher-order bits.
- 2.** "*symbol name+offset value*" is displayed when acquisition of information is impossible.

(f) Connection state

This area displays the current state of connection with the debug tool using the following icons and character strings.

Connection State	Display Contents
Connected	 <i>Debug tool name</i>
Disconnected	 DISCONNECTED

(g) Run-Break Timer measurement result









This area displays the result of measurement by the Run-Break Timer event (the unit of value used differs depending on the measurement amount). See "2.12.1 Measure execution time until stop of the execution". Note that nothing is displayed here when the debug tool is not connected.

Condition	Display Contents
Un-measuring	Unmeasurement
Under measurement	Measuring
When a timer measurement overflow has occurred	OVERFLOW

(h) Debug tool state [IECUBE][Simulator]

This area displays the current state of debug tool's functions using the following icons and character strings. When a function is stopped, clicking the appropriate icon enables the state to be switched between "Use" and "Not use"^{Note}.

Note that nothing is displayed here when the debug tool is not connected.

Function	Being Executed	Stopped (Use)	Not Use
Trace			
Timer			
Coverage			

Note [IECUBE]

Switching is impossible because the trace function, the timer function and the coverage function are always used (the icon for "Not use" is not displayed).

[Simulator]

The result of switching will be reflected in the setting of [Yes]/[No] for the [Use trace function]/[Use timer function]/[Use coverage function] property of the [Trace]/[Timer]/[Coverage] category in the [\[Debug Tool Settings\] tab](#) of the [Property panel](#).

Project Tree panel

This panel is used to display the project components such as the build tool, source files, etc. in tree view. On this panel, You can select or change the debug tool to use.

Figure A-3. Project Tree Panel

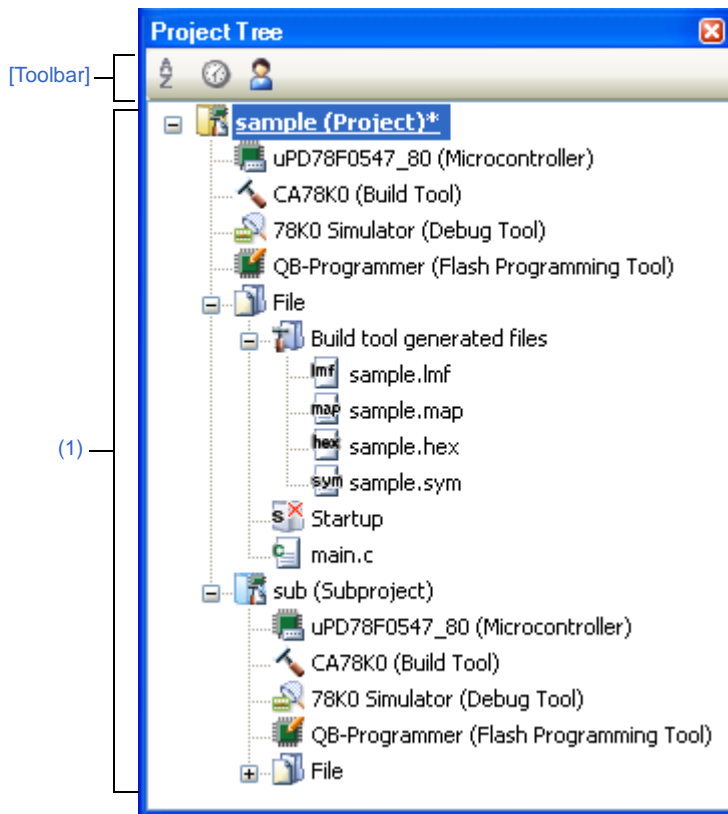

The following items are explained here.

- [How to open]
- [Description of each area]
- [Toolbar]
- [Context menu]

[How to open]

- From the [View] menu, select [Project Tree].

[Description of each area]











(1) Project tree area

Project components are displayed in tree view with the following given node.

Node	Description
78K0 <i>Debug tool name</i> (Debug tool)	<i>Debug tool name:</i> The debug tool (IECUBE, MINICUBE2(Serial), or Simulator) used in the project is displayed. Simulator is selected by default.

Select the debug tool node to configure with the [Property panel](#). If the Property panel is not being opened, double-click the node to open the corresponding Property panel.

[Toolbar]

	Sorts the category nodes and the file names into their name (character code) order. Clicking repeatedly toggles the sort order between ascending and descending.
	 Indicates that the items are not being sorted into their name order (default).
	 Indicates that the items are being sorted in descending order.
	 Indicates that the items are being sorted in ascending order.
	Sorts the category nodes and the file names into their time-stamp order. Clicking repeatedly toggles the sort order between ascending and descending.
	 Indicates that the items are not being sorted into their time-stamp order (default).
	 Indicates that the items are being sorted in descending order.
	 Indicates that the items are being sorted in ascending order.
	Sorts the category nodes and the file names into the order specified by user.
	 Indicates that the items are not being sorted by user.
	 Indicates that the items are being sorted by user (default). You can arbitrarily customize the order of the items by dragging and dropping them.

[Context menu]

Using Debug Tool	The following cascade menus are displayed to select the debug tool to use.
<i>Device name</i> IECUBE	Uses IECUBE as the debug tool.
<i>Device name</i> MINICUBE2(Serial)	Uses MINICUBE2 as the debug tool.
<i>Device name</i> Simulator	Uses Simulator as the debug tool.
Property	Displays the selected category node's property in the Property panel .

Property panel

This panel is used to display and set the debug tool operation environment that is selected in the [Project Tree panel](#).

Figure A-4. Property Panel (When IECUBE Is Selected)

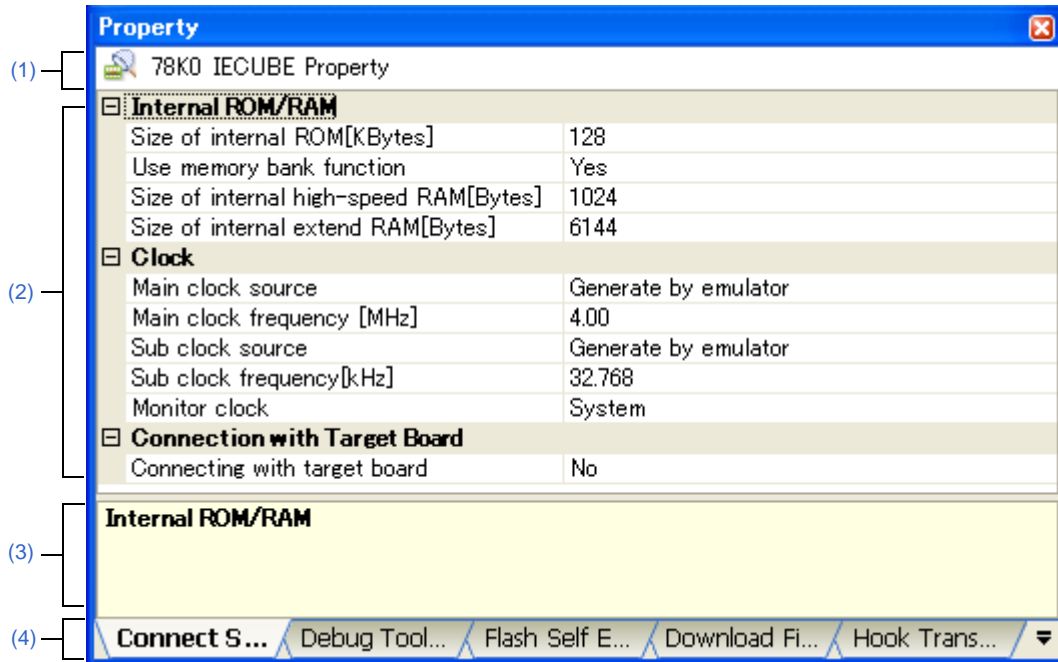

This section describes the following.

- [\[How to open\]](#)
- [\[Description of each area\]](#)
- [\[\[Edit\] menu \(Property panel-dedicated items\)\]](#)
- [\[Context menu\]](#)

[How to open]

- On the [Project Tree panel](#), select the [78K0 Debug tool name (Debug Tool)] node to use, and then select [Property] from the [View] menu or the context menu.
- On the [Project Tree panel](#), double-click the [78K0 Debug tool name (Debug Tool)] node to use.

Remark If this panel has been opened, the detailed information on the debug tool is displayed by selecting the [78K0 Debug tool name (Debug Tool)] node on the [Project Tree panel](#).



[Description of each area]

(1) Selected node area

In this area, the name of the selected debug tool on the [Project Tree panel](#) is displayed.

(2) Detailed information display/change area

In this area, the detailed information on the debug tool that is selected in [Project Tree panel](#) is displayed by category in the list. Also, you can directly change its settings.

The  mark indicates all the items in the category are expanded. The  mark indicates all the items are shrink. You can expand/shrink the items by clicking these marks or double-clicking the category name.

Note that only the hexadecimal number is allowed in the text box if the  mark is displayed in the property configuration area.

For details on the information/how to setup in the category and property items contained in it, see the section explaining the corresponding tab.

(3) Property description area

In this area, brief description of the categories and properties selected in the detailed information display/change area is displayed.

(4) Tab selection area

Categories for the display of the detailed information are changed when each tab is selected.

In this panel, following tabs are contained (see the section explaining each tab for details on the display/setting on the tab).

- [\[Connect Settings\] tab](#)
- [\[Debug Tool Settings\] tab](#)
- [\[Flash Self Emulation Settings\] tab \[IECUBE\]](#)
- [\[Download File Settings\] tab](#)
- [\[Hook Transaction Settings\] tab](#)

[[Edit] menu (Property panel-dedicated items)]

Undo	Undoes the latest property value editing being done.
Cut	Deletes the selected character string(s) and copies them to the clipboard while editing the property value.
Copy	Copies the contents of the selected range to the clipboard as character string(s).
Paste	Pastes the contents of the clipboard to the property value while editing the property value.
Delete	Deletes the selected character string(s) while editing the property value.
Select All	Selects all the character strings in the selected property while editing the property value.

[Context menu]

[While not editing the property value]

Reset to Default	Restores the selected setting of the property item to default value.
Reset All to Default	Restores all the selected settings of the property items on the tab to default value.

[While editing the property value]

Undo	Undoes the latest property value editing being done.
Cut	Deletes the selected character string(s) and copies them to the clipboard while editing the property value.
Copy	Copies the contents of the selected range to the clipboard as character string(s).
Paste	Pastes the contents of the clipboard to the property value while editing the property value.
Delete	Deletes the selected character string(s) while editing the property value.
Select All	Selects all the character strings in the selected property while editing the property value.

[Connect Settings] tab

This tab is used to display the detailed information categorized by the following and the configuration can be changed.

- (1) [Internal ROM/RAM]
- (2) [Clock]
- (3) [Connection with Target Board] [IECUBE]
- (4) [Flash] [MINICUBE2]
- (5) [Connection Emulator to Target Board] [MINICUBE2]
- (6) [Configuration] [Simulator]

Figure A-5. Property Panel: [Connect Settings] Tab [IECUBE]

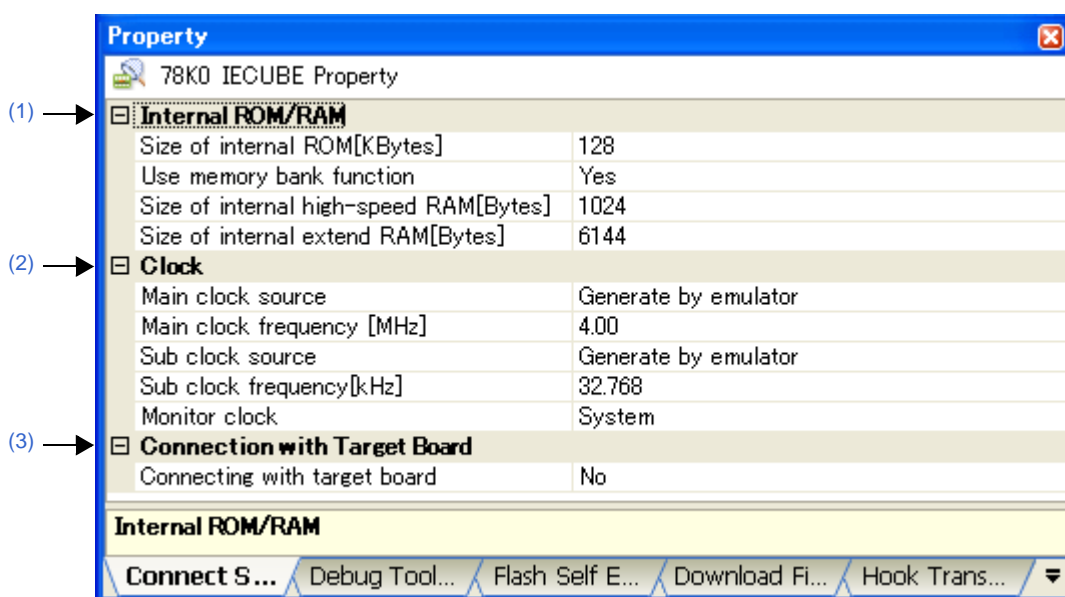

Figure A-6. Property Panel: [Connect Settings] Tab [MINICUBE2]

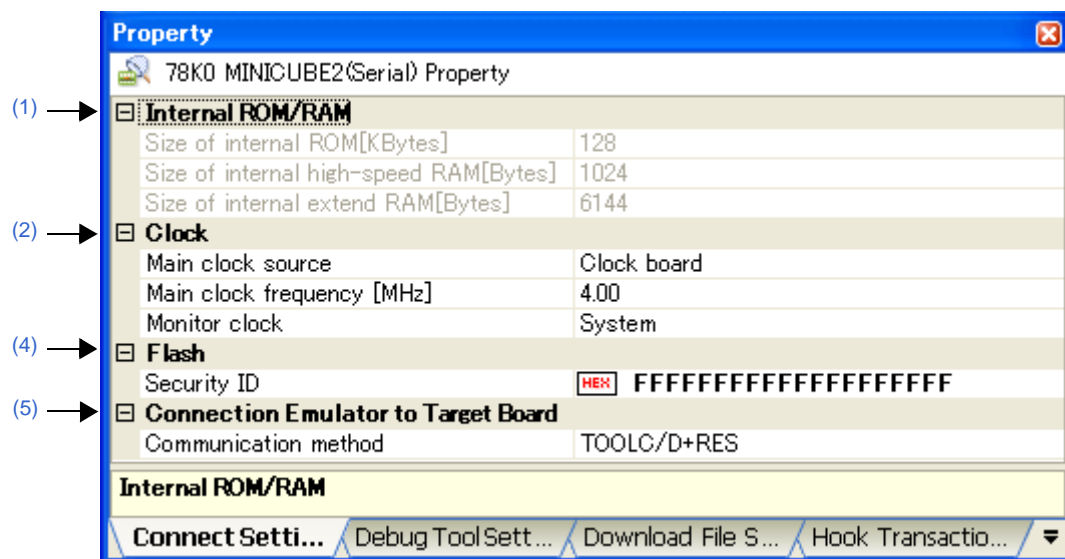
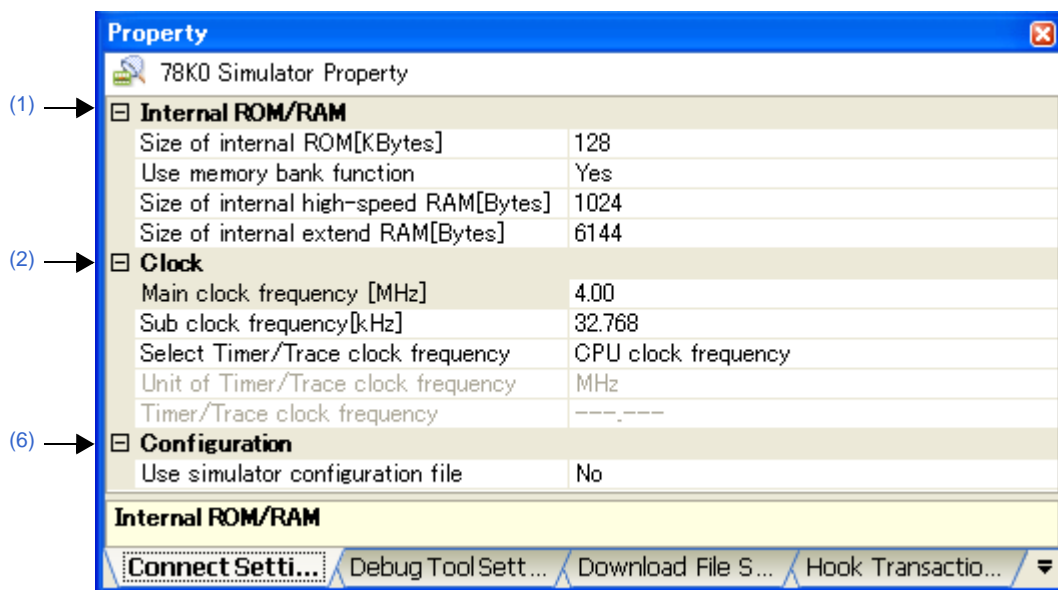

Figure A-7. Property Panel: [Connect Settings] Tab [Simulator]



[Description of each category]

(1) [Internal ROM/RAM]

The detailed information on internal ROM/RAM is displayed and its configuration can be changed.

Caution You should be careful not to overlap the area with other memory mapping area.

Size of internal ROM[KBytes]	Display and change the internal ROM size to emulate (simulate).	
	Default	<p>[IECUBE][Simulator]</p> <ul style="list-style-type: none"> - If [Yes] is selected for the [Use memory bank function] property <i>Internal ROM size + internal bank ROM size</i> - If [No] is selected for the [Use memory bank function] property <i>Internal ROM area</i> <p>[MINICUBE2]</p> <ul style="list-style-type: none"> - When the selected microcontroller provides the memory bank function <i>Internal ROM size + internal bank ROM size</i> - When the selected microcontroller does not provide the memory bank function <i>Internal ROM area</i>
	Modifying	<p>[IECUBE][Simulator]</p> <p>Select from the drop-down list.</p> <p>[MINICUBE2]</p> <p>Changes not allowed</p>
	Available values	<ul style="list-style-type: none"> - If [Yes] is selected for the [Use memory bank function] property An integer multiple of 4 between 52 and 256 (unit: Kbytes) - If [No] is selected for the [Use memory bank function] property An integer multiple of 4 between 4 and 60 (unit: Kbytes)

Use memory bank function [IECUBE] [Simulator]	Specify whether to use the memory bank function. This property appears only when the selected microcontroller provides the memory bank function.	
	Default	Yes
	Modifying	Select from the drop-down list. Note that changes can be made only while disconnecting from the debug tool.
	Available values	Yes
No		Does not use memory bank functions.
Size of internal high-speed RAM[Bytes]	Display and change the internal high-speed RAM size to emulate (simulate).	
	Default	<i>Internal high-speed RAM size of the selected microcontroller</i>
	Modifying	[IECUBE][Simulator] Select from the drop-down list. [MINICUBE2] Changes not allowed
	Available values	An integer multiple of 64 between 64 and 1024 (unit: bytes)
Size of internal extend RAM[Bytes]	Display and change the internal extend RAM size to emulate (simulate).	
	Default	<i>Internal extend RAM size of the selected microcontroller</i>
	Modifying	[IECUBE][Simulator] Select from the drop-down list. [MINICUBE2] Changes not allowed
	Available values	An integer multiple of 512 between 0 and 14336 (unit: bytes)

(2) [Clock]

The detailed information on clocks is displayed and its configuration can be changed.

Main clock source [IECUBE] [MINICUBE2]	Specify the main clock source to input to the CPU.		
	Default	[IECUBE] Generate by emulator [MINICUBE2] Clock board	
	Modifying	Select from the drop-down list. Note that changes can be made only while disconnecting from the debug tool.	
	Available values	Clock board	Uses a clock of the transmitter on the clock board. Note that if there is no transmitter on the clock board, this item does not appear.
		External [IECUBE]	Uses a main clock (square wave) of the target system. Note that if the target power supply cannot be detected, this item does not appear.
Generate by emulator		Uses a clock generated inside IECUBE/MINICUBE2.	

Main clock frequency[MHz]	Specify the main clock frequency in MHz unit. [IECUBE][MINICUBE2] This property appears only when the [Main clock source] property is set to [Generate by emulator].		
	Default	4.00	
	Modifying	Select from the drop-down list or directly enter from the keyboard. Note that changes can be made only while disconnecting from the debug tool.	
	Available values	[IECUBE] - Either one of the following from the drop-down list 1.00, 2.00, 3.00, 3.57, 4.00, 4.19, 4.91, 5.00, 6.00, 8.00, 8.38, 10.00, 12.00, 16.00, 20.00 (unit: MHz) [MINICUBE2] - Either one of the following from the drop-down list 4.00, 8.00, 16.00 (unit: MHz) [Simulator] - Either one of the following from the drop-down list 1.00, 2.00, 3.00, 3.57, 4.00, 4.19, 4.91, 5.00, 6.00, 8.00, 8.38, 10.00, 12.00, 16.00, 20.00 (unit: MHz) - Directly enter the numbers ranged below 0.001 to 99.999 (unit: MHz)	
Sub clock source [IECUBE]	Specify the sub clock source to input to the CPU and peripheral microcontrollers.		
	Default	Generate by emulator	
	Modifying	Select from the drop-down list. Note that changes can be made only while disconnecting from the debug tool.	
	Available values	Clock board	Uses a clock of the transmitter on the clock board. Note that if there is no transmitter on the clock board, this item does not appear.
		External	Uses a main clock (square wave) of the target system. Note that if the target power supply cannot be detected, this item does not appear.
Generate by emulator		Uses a clock generated inside IECUBE.	
Sub clock frequency[kHz] [IECUBE] [Simulator]	Specify the sub clock frequency in kHz unit. [IECUBE] This property appears only when the [Sub clock source] property is set to [Generate by emulator].		
	Default	32.768	
	Modifying	Select from the drop-down list or directly enter from the keyboard.	
	Available values	[IECUBE] 32.768 or 38.40 (unit: kHz) [Simulator] - Either one of the following from the drop-down list 32.768 or 38.40 (unit: kHz) - Directly enter the numbers ranged below 0.001 to 99.999 (unit: kHz)	

Monitor clock [IECUBE][MINICUBE2]]	Specify a clock for monitor programs to operate while the program is stopped.		
	Default	System	
	Modifying	Select from the drop-down list.	
	Available values	System	Operates with main clock.
User		Operates with the clock that the program specified.	
Select Timer/Trace clock frequency [Simulator]	Specify the clock frequency for using timer/trace function.		
	Default	CPU clock frequency	
	Modifying	Select from the drop-down list.	
	Available values	CPU clock frequency	Uses the CPU clock frequency.
Specify clock frequency		Specifies an arbitrary frequency (property items to specify become valid in the lower area).	
Unit of Timer/Trace clock frequency [Simulator]	Specify the unit of the clock frequency for timer/trace. This property appears only when the [Select Timer/Trace clock frequency] property is set to [Specify clock frequency].		
	Default	MHz	
	Modifying	Select from the drop-down list.	
	Available values	MHz	The unit of the frequency is in MHz.
KHz		The unit of the frequency is in kHz.	
Timer/Trace clock frequency [Simulator]	The operation of this property differs depending on the specification with the [Select Timer/Trace clock frequency] property. - When [Specify clock frequency] is specified Specify the clock frequency for timer/trace. - When [CPU clock frequency] is specified, displays the following (changes not allowed) While disconnecting from the debug tool: [---_---] While connecting to the debug tool: [CPU clock frequency]		
	Default	4.00	
	Modifying	Directly enter from the keyboard.	
	Available values	1 kHz to 99.999 MHz Unit is depending on the specification with the [Unit of Timer/Trace clock frequency] property.	

(3) [Connection with Target Board] [IECUBE]

The detailed information on the connection to the target board is displayed and its configuration can be changed.

Connecting with target board	Specify if the target board is connected to IECUBE or not.	
	Default	No
	Modifying	Select from the drop-down list. Note that changes can be made only while disconnecting from the debug tool.
	Available values	Yes
No		Target board is not connected.

(4) [Flash] [MINICUBE2]

The detailed information on the flash memory writing is displayed and its configuration can be changed.

Security ID	Specify a security ID for reading codes in the internal ROM or internal flash memory ^{Note} . This property appears only when the selected microcontroller supports the ROM security function (security ID) for flash memory.	
	Default	FFFFFFFFFFFFFFFFFFFF
	Modifying	Directly enter from the keyboard. Note that changes can be made only while disconnecting from the debug tool.
	Available values	20 digits hexadecimal number (10 bytes)

Note See MINICUBE2 User's Manual for details on the security ID authentication.

(5) [Connection Emulator to Target Board] [MINICUBE2]

The detailed information on the connection to MINICUBE2 is displayed and its configuration can be changed.

Note that this category appears only when a microcontroller in which the communication format can be changed is selected.

Communication method	Specify the port to which to connect MINICUBE2 when performing serial communication between MINICUBE2 and the device in the target system. 1-wire, 2-wire, and 3-wire communication can be specified as the communication format.		
	Default	TOOLC/D+RES	
	Modifying	Select from the drop-down list. Note that changes can be made only while disconnecting from MINICUBE2.	
	Available values	TOOLD ^{Note}	Communicates by 1-wire. In this format, a clock is not supplied for communication between MINICUBE2 and the target microcontroller. Note that the [Main clock source] property disappears and the [Mask TARGET RESET signal] property is automatically fixed to [No].
		TOOLC/D	Communicates by 2-wire. The setting specified in the [Main clock source] property is used.
TOOLD+RES ^{Note}		Communicates by 2-wire. In this format, a clock is not supplied for communication between MINICUBE2 and the target microcontroller. Note that the [Main clock source] property disappears.	
TOOLC/D+RES		Communicates by 3-wire. The setting specified in the [Main clock source] property is used.	

Note This item can be selected only if no oscillator or oscillation circuit is mounted on the clock board.
For details on the communication format, see "(d) [Connection Emulator to Target Board]".

(6) [Configuration] [Simulator]

The detailed information when customizing the simulator is displayed and its configuration can be changed.

Use simulator configuration file	Specify whether to use the simulator configuration file to perform user customization (adding of user models) of the simulator.	
	Default	No
	Modifying	Select from the drop-down list.
	Available values	Yes
No		Does not use the simulator configuration file.
Simulator configuration file	Specify the simulator configuration file to be use. This property appears only when the [Use simulator configuration file] property is set to [Yes].	
	Default	<i>Blank</i>
	Modifying	Directly enter from the keyboard, or specify with the Select Simulator Configuration File dialog box [Simulator] opened by clicking the [...] button. Note that changes can be made only while disconnecting from the debug tool.

[Debug Tool Settings] tab

This tab is used to display the detailed information categorized by the following and the configuration can be changed.

- (1) [Memory]
- (2) [Access Memory While Running]
- (3) [Set Event While Running] [IECUBE]
- (4) [Break]
- (5) [Fail-safe Break] [IECUBE]
- (6) [Power Off Emulation] [MINICUBE2]
- (7) [Trace] [IECUBE][Simulator]
- (8) [Timer] [Simulator]
- (9) [Coverage] [IECUBE][Simulator]
- (10) [Mask for Input Signal] [IECUBE][MINICUBE2]
- (11) [Simulator GUI] [Simulator]

Figure A-8. Property Panel: [Debug Tool Settings] Tab [IECUBE]

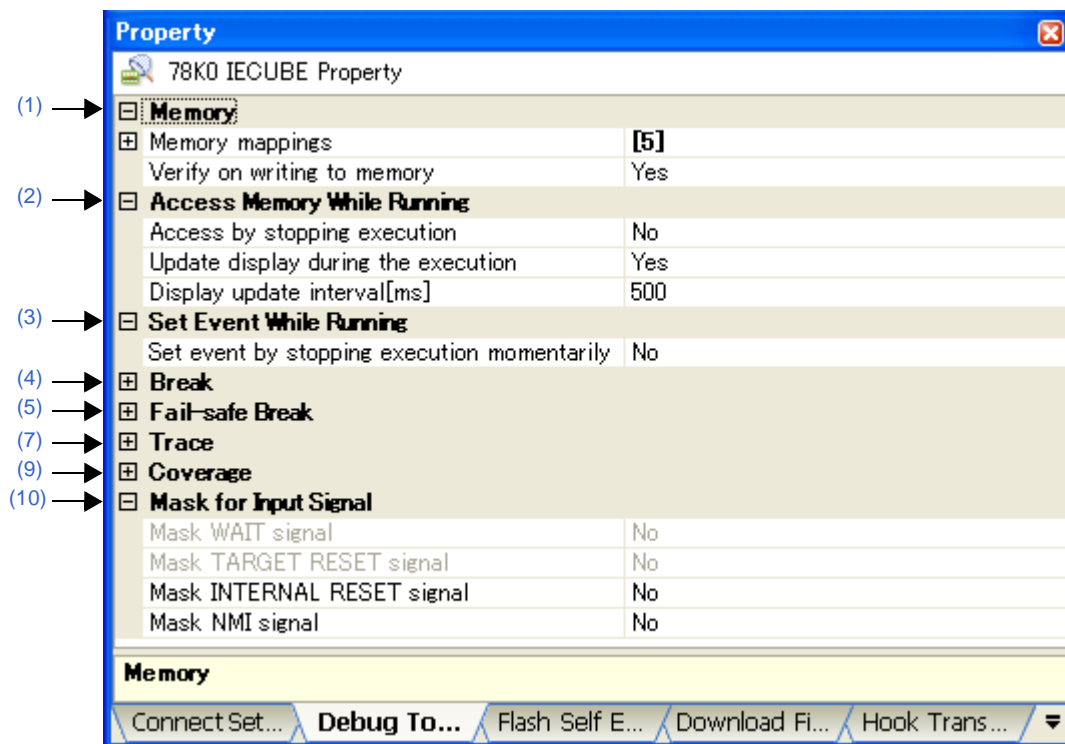

Figure A-9. Property Panel: [Debug Tool Settings] Tab [MINICUBE2]

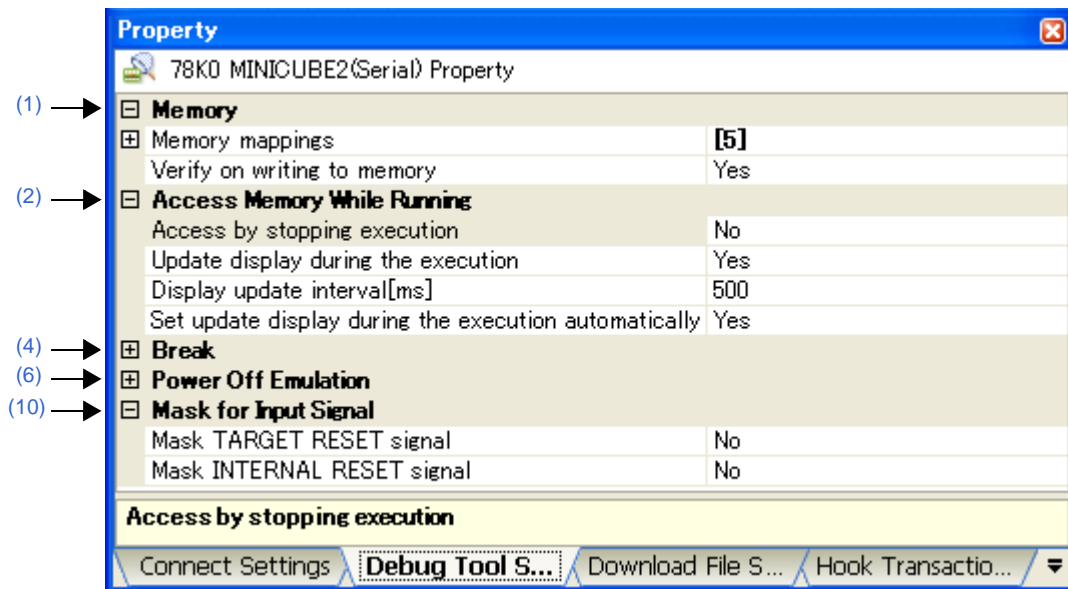
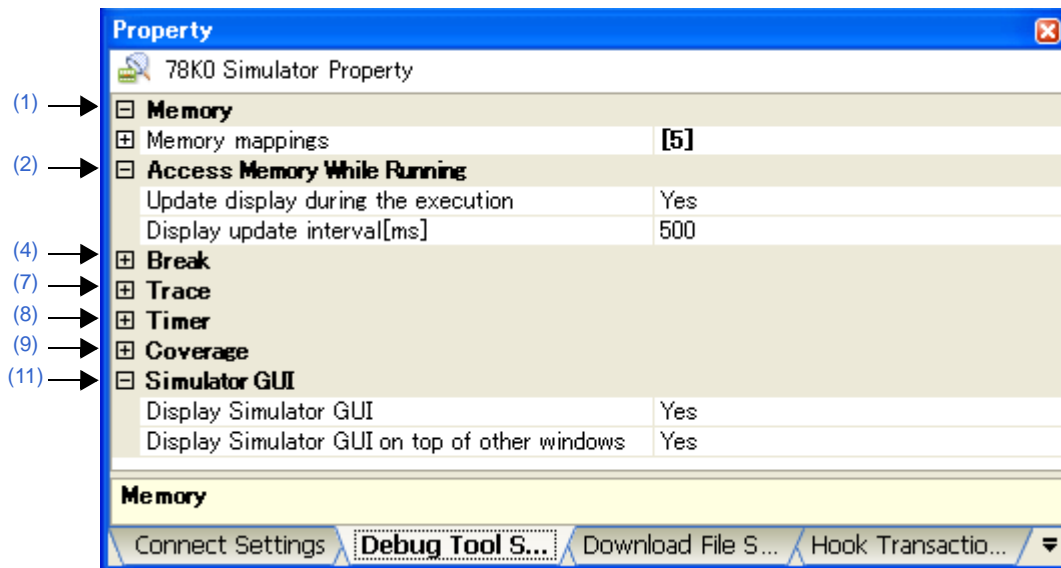

Figure A-10. Property Panel: [Debug Tool Settings] Tab [Simulator]



[Description of each category]

(1) [Memory]

The detailed information on memories is displayed and its configuration can be changed.
 For details on memory types that are displayed, see the "[Memory Mapping dialog box](#)".

Memory mappings	Current memory mapping status is displayed by the types of memory area ^{Note 1} .	
	Default	[Total number of the memory mapping types]
	Modifying	Specify with the Memory Mapping dialog box . The Memory Mapping dialog box is opened when clicking the [...] button appears at right by selecting the mapping value (you cannot change the mapping value on this panel).
	Display Contents	The types of memory area that are displayed are as follows: - Internal ROM area - Internal common ROM area - Internal bank ROM area - Internal high-speed RAM area - Buffer RAM area - Internal extend RAM area - Other RAM area - SFR area - Target memory area - I/O protection area - Emulation ROM area [IECUBE][Simulator] - Emulation RAM area [Simulator] - Non-map area The following detailed information is displayed by clicking the "+" mark of each memory type. - Memory type - Start address - End address - Access width[bits]
Verify on writing to memory [IECUBE] [MINICUBE2]	Specify whether to perform a verify check when data has been written to memory. The timing to execute the verify check is as follows ^{Note 2} : - At when the program is downloaded - At when variables and data are changed in the Watch panel/Memory panel	
	Default	Yes
	Modifying	Select from the drop-down list.
	Available values	Yes
No		Does not execute the verify check.

Notes 1. The type is of the memory mapping area registered in the device file.

2. [MINICUBE2]

Writing to built-in Flash memory does not depend on this setting. Writing to Flash self is always internally verified (excluding read verification).

(2) [Access Memory While Running]

The detailed information on memory accesses is displayed and its configuration can be changed.

Access by stopping execution [IECUBE] [MINICUBE2]	[IECUBE] Specify whether to allow access to the memory area where cannot be accessed while executing a program (target memory area/SFR area/CPU register).	
	[MINICUBE2] Specify whether to allow access to the memory area while executing a program.	
	Default	No
	Modifying	Select from the drop-down list.
Available values	Yes	Temporary stops execution and read/write.
	No	Does not access to the memory during program execution.
Update display during the execution	Specify whether to update the display in the Watch panel/Memory panel during a program execution (the real-time display update function ^{Note}).	
	Default	Yes
	Modifying	Select from the drop-down list.
	Available values	Yes
No		Does not update the display during program execution.
Display update interval[ms]	Specify the interval in 100ms unit to update the contents in the Watch panel/Memory panel display while executing a program. This property appears only when the [Update display during the execution] property is set to [Yes].	
	Default	500
	Modifying	Directly enter from the keyboard.
	Available values	Integer number between 100 and 65500 (rounding up the fractions less than 100 ms).
Set update display during the execution automatically [MINICUBE2]	Update the contents of the display while executing the program by setting the area shown in the Watch panel/Memory panel automatically as much as possible to the target range for the real-time display update function ^{Note} . This property appears only when the [Update display during the execution] property is set to [Yes].	
	Default	Yes
	Modifying	Select from the drop-down list.
	Available values	Yes
No		Does not set the real-time display update function.

Note For details on the real-time display update function, see "(4) [Display/modify the memory contents during program execution](#)".

(3) [Set Event While Running] [IECUBE]

The detailed information on the function of the event setting during program execution is displayed and its configuration can be changed.

Set event by stopping execution momentarily	Specify whether to forcibly pause the execution for events that cannot be set while executing the program. For details on the event types that are affected by this property, see " Table 2-18. Event Types That Can be Set and Deleted during Execution ".	
	Default	No
	Modifying	Select from the drop-down list.
	Available values	Yes
No		Does not allow to set these events during program execution.

(4) [Break]

The detailed information on break functions is displayed and its configuration can be changed.

First using type of breakpoint [IECUBE] [MINICUBE2]	Specify the type of the breakpoint to use with priority when setting it at the source line or the execution address with a one click operation of the mouse in the Editor panel/Disassemble panel .	
	Default	Software break
	Modifying	Select from the drop-down list.
	Available values	Software break
Hardware break		Sets hardware breakpoint with priority.
Stop emulation of peripherals when stopping [IECUBE] [MINICUBE2]	Specify whether to terminate the peripheral emulation while stopping the program execution.	
	Default	No
	Modifying	Select from the drop-down list.
	Available values	Yes
No		Does not terminate the peripheral emulation.
Execute instruction at breakpoint when break [Simulator]	Specify the timing to stop the program execution by breakpoints either after or before the execution of the instruction at the breakpoint.	
	Default	No
	Modifying	Select from the drop-down list.
	Available values	Yes
No		Breaks before executing the instruction.

Note When [Yes] is selected, all of action events currently being set are handled as Hardware Break events (see "[2.14 Set an Action into Programs](#)").

(5) [Fail-safe Break] [IECUBE]

The detailed information on fail-safe break functions is displayed and its configuration can be changed.

Stop when retry over	Specify whether to stop the execution if more than a set number of peripheral RETRY requests is received in succession.				
	Default	Yes			
	Modifying	Select from the drop-down list.			
	Available values	<table border="1"> <tr> <td>Yes</td> <td>Stops when RETRY requests is received in succession.</td> </tr> <tr> <td>No</td> <td>Does not stop even when RETRY requests is received in succession.</td> </tr> </table>	Yes	Stops when RETRY requests is received in succession.	No
Yes	Stops when RETRY requests is received in succession.				
No	Does not stop even when RETRY requests is received in succession.				
Stop when fetched from fetch protected area	Specify whether to stop the execution right after fetching from the fetch protected area.				
	Default	Yes			
	Modifying	Select from the drop-down list.			
	Available values	<table border="1"> <tr> <td>Yes</td> <td>Stops right after fetching.</td> </tr> <tr> <td>No</td> <td>Does not stop even after fetching.</td> </tr> </table>	Yes	Stops right after fetching.	No
Yes	Stops right after fetching.				
No	Does not stop even after fetching.				
Stop when read from read protected area	Specify whether to stop the execution right after reading from the read protected area.				
	Default	Yes			
	Modifying	Select from the drop-down list.			
	Available values	<table border="1"> <tr> <td>Yes</td> <td>Stops right after reading.</td> </tr> <tr> <td>No</td> <td>Does not stop even after reading.</td> </tr> </table>	Yes	Stops right after reading.	No
Yes	Stops right after reading.				
No	Does not stop even after reading.				
Stop when wrote to write protected area	Specify whether to stop the execution right after writing to the write protected area.				
	Default	Yes			
	Modifying	Select from the drop-down list.			
	Available values	<table border="1"> <tr> <td>Yes</td> <td>Stops right after writing.</td> </tr> <tr> <td>No</td> <td>Does not stop even after writing.</td> </tr> </table>	Yes	Stops right after writing.	No
Yes	Stops right after writing.				
No	Does not stop even after writing.				
Stop when access to not-exist SFR	Specify whether to stop the execution right after accessing to SFR that does not exist.				
	Default	Yes			
	Modifying	Select from the drop-down list.			
	Available values	<table border="1"> <tr> <td>Yes</td> <td>Stops right after accessing.</td> </tr> <tr> <td>No</td> <td>Does not stop even after accessing.</td> </tr> </table>	Yes	Stops right after accessing.	No
Yes	Stops right after accessing.				
No	Does not stop even after accessing.				
Stop when read from read protected SFR	Specify whether to stop the execution right after reading from the read protected SFR.				
	Default	Yes			
	Modifying	Select from the drop-down list.			
	Available values	<table border="1"> <tr> <td>Yes</td> <td>Stops right after reading.</td> </tr> <tr> <td>No</td> <td>Does not stop even after reading.</td> </tr> </table>	Yes	Stops right after reading.	No
Yes	Stops right after reading.				
No	Does not stop even after reading.				
Stop when wrote to write protected SFR	Specify whether to stop the execution right after writing to the write protected SFR.				
	Default	Yes			
	Modifying	Select from the drop-down list.			
	Available values	<table border="1"> <tr> <td>Yes</td> <td>Stops right after writing.</td> </tr> <tr> <td>No</td> <td>Does not stop even after writing.</td> </tr> </table>	Yes	Stops right after writing.	No
Yes	Stops right after writing.				
No	Does not stop even after writing.				

Stop when IMS / IXS / BANK register specification error occur	Specify whether to stop the execution right upon setting error to the following register. - IMX (memory-size switching register) - IXS (internal extend RAM-size switching register) - BANK (memory bank-switching register)				
	Default	Yes			
	Modifying	Select from the drop-down list.			
	Available values	<table border="1"> <tr> <td>Yes</td> <td>Stops right after the occurrence of the setting error.</td> </tr> <tr> <td>No</td> <td>Does not stop even after the occurrence of the setting error.</td> </tr> </table>	Yes	Stops right after the occurrence of the setting error.	No
Yes	Stops right after the occurrence of the setting error.				
No	Does not stop even after the occurrence of the setting error.				
Stop when overflowed user stack	Specify whether to stop the execution right after the user stack overflow occurs.				
	Default	No			
	Modifying	Select from the drop-down list.			
	Available values	<table border="1"> <tr> <td>Yes</td> <td>Stops right after the occurrence.</td> </tr> <tr> <td>No</td> <td>Does not stop even after the occurrence.</td> </tr> </table>	Yes	Stops right after the occurrence.	No
Yes	Stops right after the occurrence.				
No	Does not stop even after the occurrence.				
User stack top address	Specify the top address of the user stack.				
	Default	@STEND			
	Modifying	Directly enter from the keyboard.			
	Available values	Address expression from 0 to the "end address of the address space".			
Stop when underflowed user stack	Specify whether to stop the execution right after the user stack underflow occurs.				
	Default	No			
	Modifying	Select from the drop-down list.			
	Available values	<table border="1"> <tr> <td>Yes</td> <td>Stops right after the occurrence.</td> </tr> <tr> <td>No</td> <td>Does not stop even after the occurrence.</td> </tr> </table>	Yes	Stops right after the occurrence.	No
Yes	Stops right after the occurrence.				
No	Does not stop even after the occurrence.				
User stack bottom address	Specify the bottom address of the user stack.				
	Default	@STBEG			
	Modifying	Directly enter from the keyboard.			
	Available values	Address expression from 0 to the "end address of the address space".			
Stop when read from uninitialized RAM	Specify whether to stop the execution right after reading from the RAM that is not initialized.				
	Default	Yes			
	Modifying	Select from the drop-down list.			
	Available values	<table border="1"> <tr> <td>Yes</td> <td>Stops right after reading.</td> </tr> <tr> <td>No</td> <td>Does not stop even after reading.</td> </tr> </table>	Yes	Stops right after reading.	No
Yes	Stops right after reading.				
No	Does not stop even after reading.				
Stop when accessed to non-mapping area	Specify whether to stop the execution right after accessing to the areas where are not memory mapped in the [Memory Mappings] property in the [Memory] category.				
	Default	Yes			
	Modifying	Select from the drop-down list.			
	Available values	<table border="1"> <tr> <td>Yes</td> <td>Stops right after accessing.</td> </tr> <tr> <td>No</td> <td>Does not stop even after accessing.</td> </tr> </table>	Yes	Stops right after accessing.	No
Yes	Stops right after accessing.				
No	Does not stop even after accessing.				

Stop when read from uninitialized RAM	Specify whether to stop the execution right after the operation of the stack pointer that is not initialized.		
	Default	Yes	
	Modifying	Select from the drop-down list.	
	Available values	Yes	Stops right after the operation.
No		Does not stop even after the operation.	
Stop when received fail safe from peripheral	Specify whether to stop the execution right after the fail safe from the peripheral occurs.		
	Default	Yes	
	Modifying	Select from the drop-down list.	
	Available values	Yes	Stops right after the occurrence.
No		Does not stop even after the occurrence.	

(6) [Power Off Emulation] [MINICUBE2]

The detailed information on power off emulation functions is displayed and its configuration can be changed.

Enable Power-off emulation	Specify whether to use the Power off emulation function.		
	Default	No	
	Modifying	Select from the drop-down list.	
	Available values	Yes	Executes the program after CPU reset.
No		Stops the execution of the program after CPU reset.	

(7) [Trace] [IECUBE][Simulator]

The detailed information on trace functions is displayed and its configuration can be changed.

Use trace function [Simulator]	Specify whether to use the trace function ^{Note 1} .		
	Default	No	
	Modifying	Select from the drop-down list.	
	Available values	Yes	Uses trace functions.
No		Does not use trace functions.	
Clear trace memory before running	Specify whether to clear the trace memory before executing.		
	Default	Yes	
	Modifying	Select from the drop-down list.	
	Available values	Yes	Clears the trace memory.
No		Does not clear the trace memory.	

Operation after trace memory is full	Specify the operation after the trace memory is full with the collected trace data.			
	Default	Non stop and overwrite to trace memory		
	Modifying	Select from the drop-down list.		
	Available values	Non stop and overwrite to trace memory	Continues overwriting the older trace data after the trace memory is full.	
		Stop trace	Stops writing the trace data after the trace memory is full (the program execution will not be stopped).	
Stop	Stops writing the trace data after the trace memory is full and the program execution will be stopped.			
Accumulate trace time [Simulator]	Specify whether to display the accumulated tracing time in the Trace panel [IECUBE][Simulator] .			
	Default	No		
	Modifying	Select from the drop-down list.		
	Available values	Yes	Displays the accumulated tracing time.	
No		Displays the trace time with differential value.		
Trace memory size[frames] [Simulator]	Specify the memory size for storing the trace data by the trace frame numbers ^{Note 2} .			
	Default	4K		
	Modifying	Select from the drop-down list.		
	Available values	4K, 8K, 12K, 16K, 20K, 24K, 28K, 32K, 36K, 40K, 44K, 48K, 52K, 56K, 60K, 64K, 128K, 192K, 256K, 320K, 384K, 448K, 512K, 576K, 640K, 704K, 768K, 832K, 896K, 960K, 1M, 2M, 3M		

- Notes 1.** This property is automatically set to [Yes] when selecting [Start Tracing]/[Stop Tracing] from the context menu in the [Editor panel/Disassemble panel](#).
- 2.** The trace frame is a unit for the trace data. Each fetch/write/read uses one trace frame.

(8) [Timer] [Simulator]

The detailed information on timer functions is displayed and its configuration can be changed.

Use timer function	Specify whether to use the timer function.		
	Default	No	
	Modifying	Select from the drop-down list.	
	Available values	Yes	Uses timer functions.
No		Does not use timer functions.	

(9) [Coverage] [IECUBE][Simulator]

The detailed information on coverage functions is displayed and its configuration can be changed.

Use coverage function [Simulator]	Specify whether to use the coverage function.		
	Default	No	
	Modifying	Select from the drop-down list.	
	Available values	Yes	Use coverage functions
No		Does not use coverage functions	

Reuse coverage result	Specify whether to load/save the coverage measurement result when connecting to or disconnecting from the debug tool.	
	[Simulator] This property appears only when the [Use coverage function] property is set to [Yes].	
	Default	No
	Modifying	Select from the drop-down list.
Available values	Yes	Loads/saves the coverage measurement result.
	No	Does not load/save the coverage measurement result.

(10)[Mask for Input Signal] [IECUBE][MINICUBE2]

The detailed information on the masking input signal is displayed and its configuration can be changed.

Mask WAIT signal [IECUBE]	Specify whether to mask WAIT signal to prevent the signal input to emulators.	
	Default	No ^{Note}
	Modifying	Select from the drop-down list.
	Available values	Yes
No		Does not mask WAIT signal.
Mask TARGET RESET signal	Specify whether to mask TARGET RESET signal to prevent the signal input to emulators.	
	Default	No ^{Note}
	Modifying	Select from the drop-down list.
	Available values	Yes
No		Does not mask TARGET RESET signal.
Mask INTERNAL RESET signal	Specify whether to mask INTERNAL RESET signal to prevent the signal input to emulators.	
	Default	No
	Modifying	Select from the drop-down list.
	Available values	Yes
No		Does not mask INTERNAL RESET signal.
Mask NMI signal [IECUBE]	Specify whether to mask NMI signal to prevent the signal input to emulators.	
	Default	No
	Modifying	Select from the drop-down list.
	Available values	Yes
No		Does not mask NMI signal.

Note [IECUBE]

When the [\[Connecting with target board\]](#) property in the [\[Connection with Target Board\] \[IECUBE\]](#) category on the [\[Connect Settings\] tab](#) is set to [No], this property is fixed to [Yes] automatically after connecting to the debug tool (changes not allowed).

(11) [Simulator GUI] [Simulator]

The detailed information on the Simulator GUI is displayed and its configuration can be changed.

Caution After connecting to the debug tool, all the properties in this category will become invalid when a microcontroller whose Simulator does not support peripheral function simulations (instruction simulation version) is selected.

Display Simulator GUI	Specify whether to display the Simulator GUI window .	
	Default	Yes
	Modifying	Select from the drop-down list.
	Available values	Yes
No		Does not display the Simulator GUI window .
Display Simulator GUI on top of other windows	Specify whether to display the Simulator GUI window in the forefront when program execution starts. This property appears only when the [Display Simulator GUI] property is set to [Yes].	
	Default	Yes
	Modifying	Select from the drop-down list.
	Available values	Yes
No		Does not display it in the forefront.

[Flash Self Emulation Settings] tab [IECUBE]

This tab is used to display the detailed information categorized by the following and the configuration can be changed.

- (1) [Flash Self Emulation]
- (2) [Macro Service Error]
- (3) [Security Flag Emulation]

Figure A-11. Property Panel: [Flash Self Emulation Settings] Tab

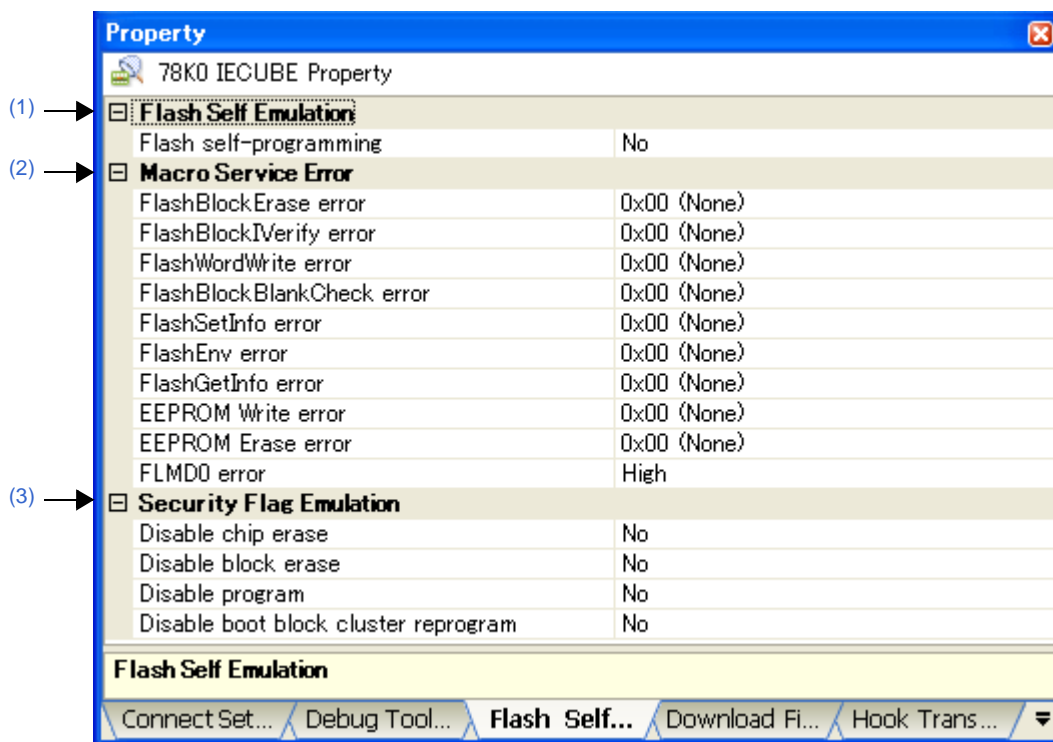

[Description of each category]

(1) [Flash Self Emulation]

The detailed information on flash self programming emulation functions is displayed and its configuration can be changed.

Flash self-programming	Specify whether to use the flash self programming emulation function.		
	Default	No	
	Modifying	Select from the drop-down list.	
	Available values	Yes	Uses the flash self programming emulation function.
No		Does not use the flash self programming emulation function.	

(2) [Macro Service Error]

The detailed information on flash macro service is displayed and its configuration can be changed. The property that appear differs depending on the selected microcontroller.

[Flash macro in the CZ6 (Kx1+) series]

FlashBlockErase error	Specify the error value returned from FlashBlockErase.	
	Default	0x00 (None)
	Modifying	Select from the drop-down list or directly enter from the keyboard.
	Available values	<ul style="list-style-type: none"> - Either one of the following from the drop-down list - 0x00 (None) - 0x05 (Parameter Error) - 0x1A (Erase Error) - Directly enter the numbers ranged below 0x00 to 0xFF in hexadecimal number
FlashBlockVerify error	Specify the error value returned from FlashBlockVerify.	
	Default	0x00 (None)
	Modifying	Select from the drop-down list or directly enter from the keyboard.
	Available values	<ul style="list-style-type: none"> - Either one of the following from the drop-down list - 0x00 (None) - 0x05 (Parameter Error) - 0x1B (Inside Verify Error) - Directly enter the numbers ranged below 0x00 to 0xFF in hexadecimal number
FlashWordWrite error	Specify the error value returned from FlashWordWrite.	
	Default	0x00 (None)
	Modifying	Select from the drop-down list or directly enter from the keyboard.
	Available values	<ul style="list-style-type: none"> - Either one of the following from the drop-down list - 0x00 (None) - 0x05 (Parameter Error) - 0x18 (FLMD Error) - Directly enter the numbers ranged below 0x00 to 0xFF in hexadecimal number
FlashBlockBlankCheck error	Specify the error value returned from FlashBlockBlankCheck.	
	Default	0x00 (None)
	Modifying	Select from the drop-down list or directly enter from the keyboard.
	Available values	<ul style="list-style-type: none"> - Either one of the following from the drop-down list - 0x00 (None) - 0x05 (Parameter Error) - 0x1B (Blank Check Error) - Directly enter the numbers ranged below 0x00 to 0xFF in hexadecimal number

FlashSetInfo error	Specify the error value returned from FlashSetInfo.	
	Default	0x00 (None)
	Modifying	Select from the drop-down list or directly enter from the keyboard.
	Available values	<ul style="list-style-type: none"> - Either one of the following from the drop-down list - 0x00 (None) - 0x05 (Parameter Error) - 0x18 (FLMD Error) - 0x1C (Write Error) - Directly enter the numbers ranged below 0x00 to 0xFF in hexadecimal number
FlashEnv error	Specify the error value returned from FlashEnv.	
	Default	0x00 (None)
	Modifying	Select from the drop-down list or directly enter from the keyboard.
	Available values	<ul style="list-style-type: none"> - Either one of the following from the drop-down list - 0x00 (None) - 0x05 (Parameter Error) - Directly enter the numbers ranged below 0x00 to 0xFF in hexadecimal number
FlashGetInfo error	Specify the error value returned from FlashGetInfo.	
	Default	0x00 (None)
	Modifying	Select from the drop-down list or directly enter from the keyboard.
	Available values	<ul style="list-style-type: none"> - Either one of the following from the drop-down list - 0x00 (None) - 0x05 (Parameter Error) - Directly enter the numbers ranged below 0x00 to 0xFF in hexadecimal number
EEPROM Write error	Specify the error value returned from EEPROM Write.	
	Default	0x00 (None)
	Modifying	Select from the drop-down list or directly enter from the keyboard.
	Available values	<ul style="list-style-type: none"> - Either one of the following from the drop-down list - 0x00 (None) - 0x05 (Parameter Error) - 0x18 (FLMD Error) - 0x1C (Write Error) - 0x1D (MRG12 Error) - 0x1E (Blank Error) - Directly enter the numbers ranged below 0x00 to 0xFF in hexadecimal number

EEPROM Erase error	Specify the error value returned from EEPROM Erase.	
	Default	0x00 (None)
	Modifying	Select from the drop-down list or directly enter from the keyboard.
	Available values	<ul style="list-style-type: none"> - Either one of the following from the drop-down list - 0x00 (None) - 0x05 (Parameter Error) - 0x1A (Erase Error) - Directly enter the numbers ranged below 0x00 to 0xFF in hexadecimal number

[Flash macro in the MF2 (Kx2+) series]

FlashBlockErase error	Specify the error value returned from FlashBlockErase.	
	Default	0x00 (None)
	Modifying	Select from the drop-down list or directly enter from the keyboard.
	Available values	<ul style="list-style-type: none"> - Either one of the following from the drop-down list - 0x00 (None) - 0x05 (Parameter Error) - 0x10 (Protect Error) - 0x1A (Erase Error) - 0x1F (Stop by Interrupt) - Directly enter the numbers ranged below 0x00 to 0xFF in hexadecimal number
FlashBlockVerify error	Specify the error value returned from FlashBlockVerify.	
	Default	0x00 (None)
	Modifying	Select from the drop-down list or directly enter from the keyboard.
	Available values	<ul style="list-style-type: none"> - Either one of the following from the drop-down list - 0x00 (None) - 0x05 (Parameter Error) - 0x1B (Inside Verify Error) - 0x1F (Stop by Interrupt) - Directly enter the numbers ranged below 0x00 to 0xFF in hexadecimal number
FlashWordWrite error	Specify the error value returned from FlashWordWrite.	
	Default	0x00 (None)
	Modifying	Select from the drop-down list or directly enter from the keyboard.
	Available values	<ul style="list-style-type: none"> - Either one of the following from the drop-down list - 0x00 (None) - 0x05 (Parameter Error) - 0x10 (Protect Error) - 0x1C (Write Error) - 0x1F (Stop by Interrupt) - Directly enter the numbers ranged below 0x00 to 0xFF in hexadecimal number

FlashBlockBlankCheck error	Specify the error value returned from FlashBlockBlankCheck.	
	Default	0x00 (None)
	Modifying	Select from the drop-down list or directly enter from the keyboard.
	Available values	<ul style="list-style-type: none"> - Either one of the following from the drop-down list - 0x00 (None) - 0x05 (Parameter Error) - 0x1B (Blank Check Error) - 0x1F (Stop by Interrupt) - Directly enter the numbers ranged below 0x00 to 0xFF in hexadecimal number
FlashSetInfo error	Specify the error value returned from FlashSetInfo.	
	Default	0x00 (None)
	Modifying	Select from the drop-down list or directly enter from the keyboard.
	Available values	<ul style="list-style-type: none"> - Either one of the following from the drop-down list - 0x00 (None) - 0x05 (Parameter Error) - 0x10 (Protect Error) - 0x1A (Erase Error) - 0x1B (Inside Verify Error) - 0x1C (Write Error) - 0x1F (Stop by Interrupt) - Directly enter the numbers ranged below 0x00 to 0xFF in hexadecimal number
FlashEnv error	Specify the error value returned from FlashEnv. This property does not appear after connecting from the debug tool.	
	Default	0x00 (None)
	Modifying	Select from the drop-down list or directly enter from the keyboard.
	Available values	<ul style="list-style-type: none"> - Either one of the following from the drop-down list - 0x00 (None) - Directly enter the numbers ranged below 0x00 to 0xFF in hexadecimal number
FlashGetInfo error	Specify the error value returned from FlashGetInfo.	
	Default	0x00 (None)
	Modifying	Select from the drop-down list or directly enter from the keyboard.
	Available values	<ul style="list-style-type: none"> - Either one of the following from the drop-down list - 0x00 (None) - 0x05 (Parameter Error) - 0x20 (Read Error) - Directly enter the numbers ranged below 0x00 to 0xFF in hexadecimal number

EEPROM Write error	Specify the error value returned from EEPROM Write.	
	Default	0x00 (None)
	Modifying	Select from the drop-down list or directly enter from the keyboard.
	Available values	<ul style="list-style-type: none"> - Either one of the following from the drop-down list - 0x00 (None) - 0x05 (Parameter Error) - 0x10 (Protect Error) - 0x1C (Write Error) - 0x1D (MRG12 Error) - 0x1E (Blank Error) - 0x1F (Stop by Interrupt) - Directly enter the numbers ranged below 0x00 to 0xFF in hexadecimal number
EEPROM Erase error	Specify the error value returned from EEPROM Erase. This property does not appear after connecting to the debug tool.	
	Default	0x00 (None)
	Modifying	Select from the drop-down list or directly enter from the keyboard.
	Available values	<ul style="list-style-type: none"> - Either one of the following from the drop-down list - 0x00 (None) - Directly enter the numbers ranged below 0x00 to 0xFF in hexadecimal number

[Common to the CZ6 (Kx1+) series/MF2 (Kx2+) series]

FLMD0 error	Specify the error value returned from FLMD0. This property appears only when the target board is disconnected from IECUBE.	
	Default	High
	Modifying	Select from the drop-down list.
	Available values	High
Low		

(3) [Security Flag Emulation]

The detailed information on the security flag emulation function is displayed and its configuration can be changed.

Disable chip erase	Specify whether to emulate to disable chip erase.	
	Default	No
	Modifying	Select from the drop-down list.
	Available values	Yes
No		Does not emulate to disable chip erase.
Disable block erase	Specify whether to emulate to disable block erase.	
	Default	No
	Modifying	Select from the drop-down list.
	Available values	Yes
No		Does not emulate to disable block erase.
Disable program	Specify whether to emulate to disable writing.	
	Default	No
	Modifying	Select from the drop-down list.
	Available values	Yes
No		Does not emulate to disable writing.
Disable boot block cluster reprogram	Specify whether to emulate to disable rewrite boot area. This property does not appear after connecting to the debug tool if the CZ6 (Kx1+) series is used.	
	Default	No
	Modifying	Select from the drop-down list.
	Available values	Yes
No		Does not emulate to disable rewrite boot area.

[Download File Settings] tab

This tab is used to display the detailed information categorized by the following and the configuration can be changed. For details on the download function, see "2.5 Download/Upload Programs".

- (1) [Download]
- (2) [Debug Information]

Figure A-12. Property Panel: [Download File Settings] Tab

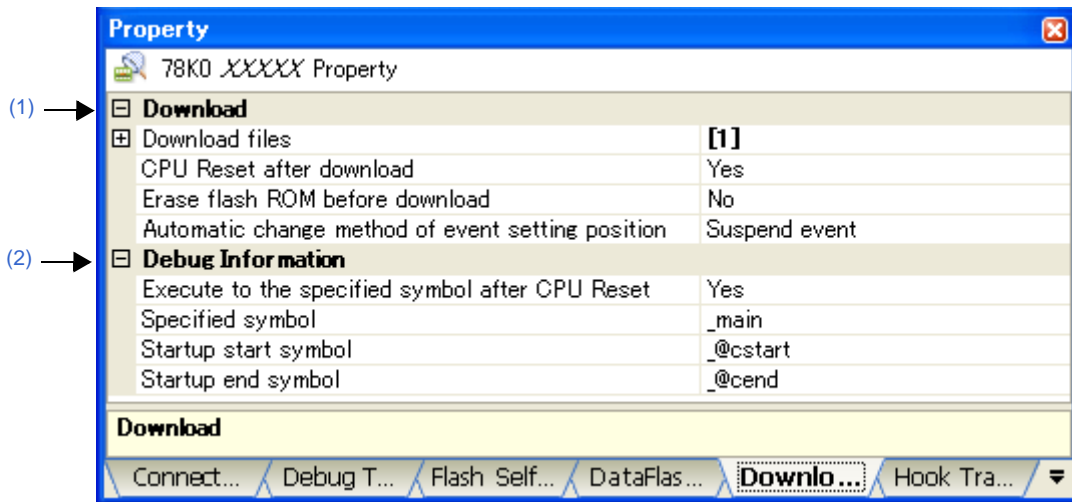

[Description of each category]

(1) [Download]

The detailed information on download is displayed and its configuration can be changed.

Download files	Specify the file to download ^{Note 1} . The names of files to be downloaded and the download conditions are listed in the lower area.	
	Default	[Number of files to download]
	Modifying	Specify with the Download Files dialog box . The Download Files dialog box is opened when clicking the [...] button appears at right by selecting this property (you cannot specify the file to download on this panel).
CPU Reset after download	Specify whether to reset the CPU after downloading.	
	Default	Yes
	Modifying	Select from the drop-down list.
	Available values	Yes Resets the CPU after downloading.
	No	Does not reset the CPU after downloading.

Erase flash ROM before download	Specify whether to erase the flash ROM before downloading.		
	Default	No	
	Modifying	Select from the drop-down list.	
	Available values	Yes	Erases the flash ROM before downloading.
No		Does not erase the flash ROM before downloading.	
Automatic change method of event setting position	Specify how to perform the setting again if the file is downloaded again, and the location (address) set for the currently set event changes to midway in the instruction ^{Note 2} .		
	Default	Suspend event	
	Modifying	Select from the drop-down list.	
	Available values	Move to the head of instruction	Sets the event to the top address of the instruction.
Suspend event		Disables the event (suspended state).	

- Notes 1.** Files specified as build targets in a main project or sub-project cannot be deleted from the target files to download (These files are automatically registered as download files by default).
See "[Table 2-1. Type of Files That Can be Downloaded](#)" for downloadable file format.
- 2.** This property setting is only appears to the location setting of events without debug information. The location setting of events with debug information is always moved to the beginning of the source text line.

(2) [Debug Information]

The detailed information on debugging is displayed and its configuration can be changed.

Execute to the specified symbol after CPU Reset	Specify whether to execute the program to the specified symbol position after CPU reset.		
	Default	Yes	
	Modifying	Select from the drop-down list.	
	Available values	Yes	Executes the program to the specified symbol position after CPU reset.
No		Does not execute the program after CPU reset.	
Specified symbol	Specify the position at which the program is stop after CPU reset. This property appears only when the [Execute to the specified symbol after CPU Reset] property is set to [Yes].		
	Default	_main	
	Modifying	Directly enter from the keyboard.	
	Available values	Address expression from 0 to the "end address of the address space".	
Startup start symbol	Specify the start symbol of the text area of the startup routine.		
	Default	_@cstart	
	Modifying	Directly enter from the keyboard.	
	Available values	Address expression from 0 to the "end address of the address space".	

Startup end symbol	Specify the end symbol of the text area of the startup routine.	
	Default	_ <i>@cend</i>
	Modifying	Directly enter from the keyboard.
	Available values	Address expression from 0 to the <i>"end address of the address space"</i> .

[Hook Transaction Settings] tab

This tab is used to display the detailed information categorized by the following and the configuration can be changed. For details on the hook transaction, see "2.16 Use Hook Function".

- (1) [Hook Transaction Settings]

Figure A-13. Property Panel: [Hook Transaction Settings] Tab

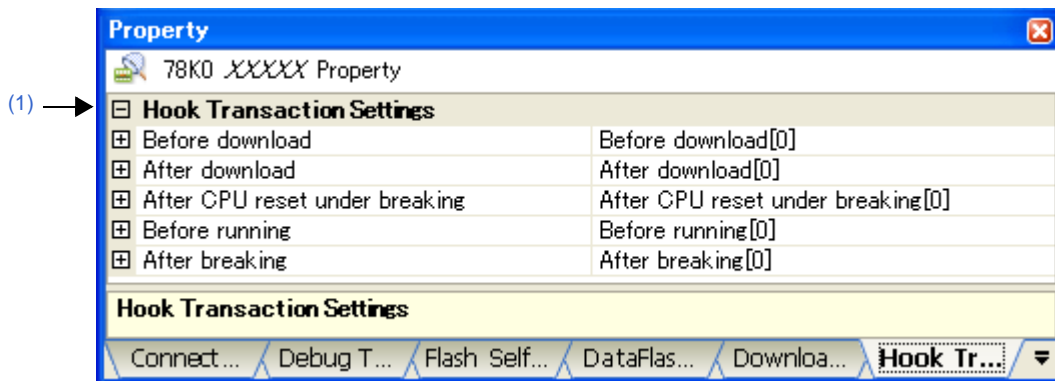

[Description of each category]

- (1) [Hook Transaction Settings]

The detailed information on the hook transaction is displayed and its configuration can be changed.

Before download	Specify the process to proceed right before downloading. Automatically rewrite the SFR/CPU register specified in this field right before downloading the load module file to the specified numbers.	
	Default	Before download[0] ("[]" is the current number of specified processes.)
	Modifying	Specify with the Text Edit dialog box . The Text Edit dialog box is opened when clicking the [...] button appears at right by selecting this property (you cannot specify the process on this panel).
	Available values	Format: - SFR name/CPU register name + space + specified value Maximum characters: 64 (for one process) Maximum number of process: 128
After download	Specify the process to proceed right after downloading. Automatically rewrite the SFR/CPU register specified in this field right after downloading the load module file to the specified numbers.	
	Default	After download[0] ("[]" is the current number of specified processes.)
	Modifying	Specify with the Text Edit dialog box . The Text Edit dialog box is opened when clicking the [...] button appears at right by selecting this property (you cannot specify the process on this panel).
	Available values	Format: - SFR name/CPU register name + space + specified value Maximum characters: 64 (for one process) Maximum number of process: 128

After CPU reset under breaking	Specify the process to proceed right after CPU reset during break. Automatically rewrite the SFR/CPU register specified in this field right after CPU reset to the specified numbers.	
	Default	After CPU reset under breaking[0] ("[]" is the current number of specified processes.)
	Modifying	Specify with the Text Edit dialog box . The Text Edit dialog box is opened when clicking the [...] button appears at right by selecting this property (you cannot specify the process on this panel).
	Available values	Format: - <i>SFR name/CPU register name + space + specified value</i> Maximum characters: 64 (for one process) Maximum number of process: 128
Before running	Specify the process to proceed right before execution. Automatically rewrite the SFR/CPU register specified in this field right before the execution of the program to the specified numbers.	
	Default	Before running[0] ("[]" is the current number of specified processes.)
	Modifying	Specify with the Text Edit dialog box . The Text Edit dialog box is opened when clicking the [...] button appears at right by selecting this property (you cannot specify the process on this panel).
	Available values	Format: - <i>SFR name/CPU register name + space + specified value</i> Maximum characters: 64 (for one process) Maximum number of process: 128
After breaking	Specify the process to proceed right after the break. Automatically rewrite the SFR/CPU register specified in this field right after the program break to the specified numbers.	
	Default	After breaking[0] ("[]" is the current number of specified processes.)
	Modifying	Specify with the Text Edit dialog box . The Text Edit dialog box is opened when clicking the [...] button appears at right by selecting this property (you cannot specify the process on this panel).
	Available values	Format: - <i>SFRname/CPU register name + space + specified value</i> Maximum characters: 64 (for one process) Maximum number of process: 128

Editor panel

This panel is used to display and edit text files/source files.

Furthermore, the source level debugging (see "2.7.3 Execute programs in steps") and the code coverage measurement result display [IECUBE][Simulator] (see "2.13 Measure Coverage [IECUBE][Simulator]") can be performed when connected to the debug tool and the downloaded source file is opened in this panel.

The file is opened by automatically distinguishing the encoding (Shift_JIS/EUC-JP/UTF-8) and the new line code (LF/CR) of the file, and when it is saved, the format are retained. The encoding and the new line code, however, can be changed via the [Save Settings dialog box](#).

This panel can be multiply opened (up to 100 panels).

- Remarks 1.** When a project is closed, all of the Editor panels displaying a file being registered in the project are closed.
2. When a file is excluded from a project, the Editor panel displaying the file is closed.
 3. A message is displayed when the downloaded lode module file is older than the source file to open.

Figure A-14. Editor Panel

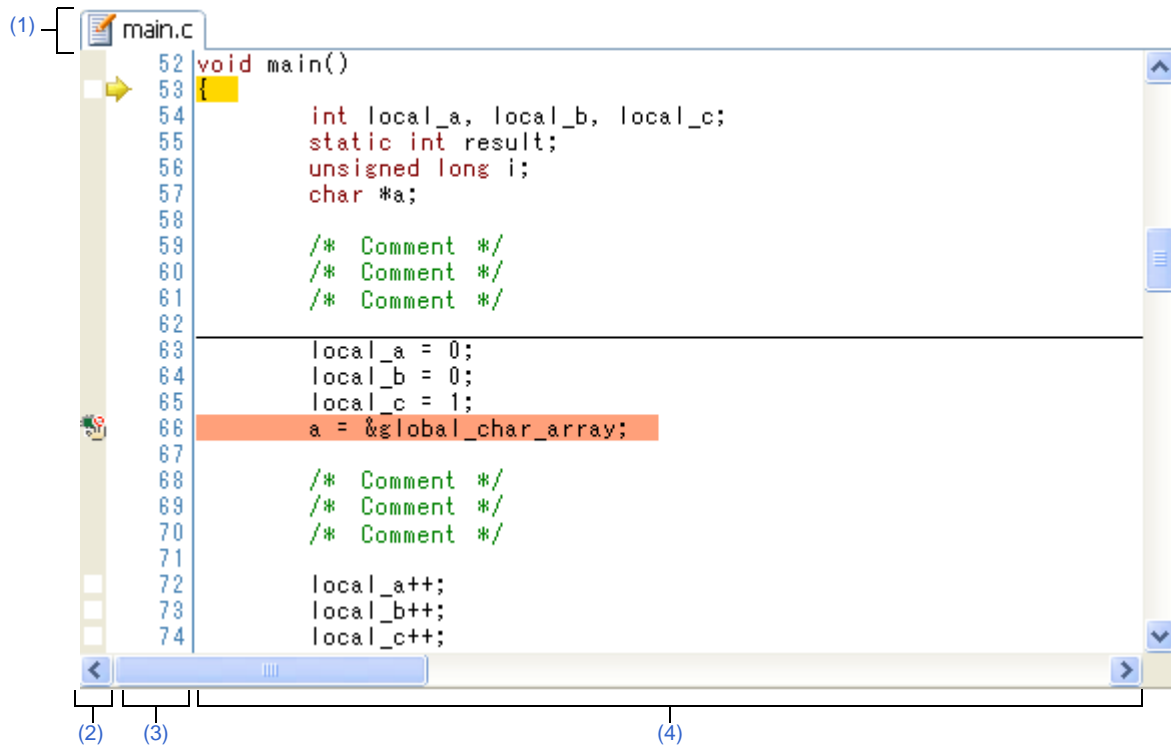
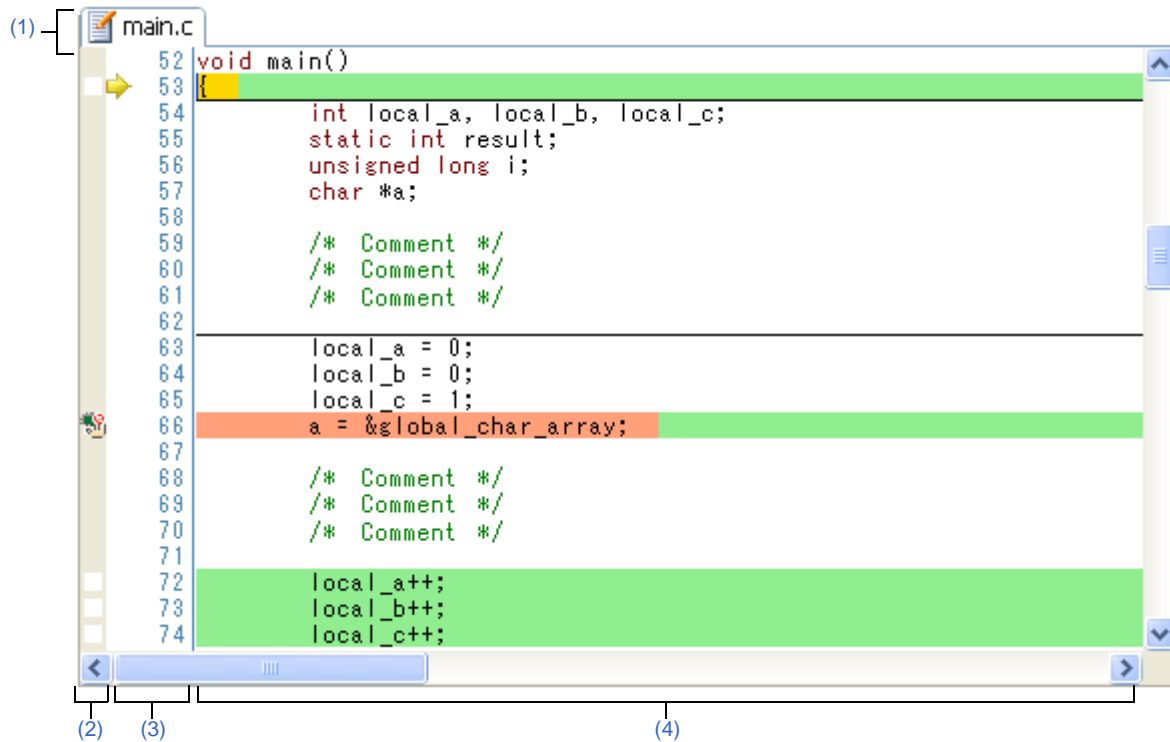

Figure A-15. Editor Panel (When Code Coverage Measurement Result Is Displayed)



This section describes the following.

- [How to open]
- [Description of each area]
- [[File] menu (Editor panel-dedicated items)]
- [[Edit] menu (Editor panel-dedicated items)]
- [Context menu]

[How to open]

- On the [Project Tree panel](#), double-click the file.
- Automatically opens after downloading the load module file with debug information.
- On the [Project Tree panel](#), select the file and then select [Open] from the context menu.
- On the [Project Tree panel](#), select [Add] >> [Add New File...] from the context menu and then create a text file/source file.
- On the [Disassemble panel/Call Stack panel/Trace panel \[IECUBE\]\[Simulator\]/Watch panel](#), select [Jump to Source] from the context menu.
- Automatically opens if there is a source text line correspond to the current PC value when the current PC value is forcibly changed or the program stops executing.

[Description of each area]

(1) Title bar

The name of the opened text file/source file is displayed.

Marks that are displayed at the end of the file name indicate as follows:

Mark	Description
*	The contents of the editing file is changed.
!	Update time and date of the source file opened are later than the one of the downloaded load module file in the case the text file, which is contained in the load module file downloaded in the connected debug tool as debug information, is opened.
(Uneditable)	The opened text file is write disabled.
<i>ID number</i>	The same text file is multiply opened.

(2) Event area

This area is valid only when connected to the debug tool and the downloaded source file is opened.

If the source text line can be converted to the corresponding address, events can be set to the line with background color in white (if the background color of the line is gray, events cannot be set to the line).

In addition, the [Event mark](#) corresponding to an event that has been currently set is displayed.

This area is provided with the following functions.

(a) Setting/deleting breakpoints

By clicking where you want to set a breakpoint with mouse, the breakpoints can be set easily.

The breakpoint is set to the instruction at the start address corresponding to the clicked line.

Once a breakpoint is set, an [Event mark](#) is displayed at the line that is set. In addition, the detailed information about the set breakpoint is reflected in the [Events panel](#).



When this operation is performed at a place where any one of the event marks is already being displayed, that event is deleted and the setting of breakpoints cannot be done.

Note that the setting of events can be done only for those lines where the background color is shown in white.

See "[2.8.2 Stop the program at the arbitrary position \(breakpoint\)](#)" for details on how to set the breakpoint.

(b) Changes event status

Event status can be changed from the following menu displayed by right-clicking the event mark.

Enable Event	Changes the selected event state to a Valid state . Event occurs when the specified condition is met. When the event mark () which indicates that multiple events have been set is selected, all of the events that have been set are enabled.
Disable Event	Changes the selected event state to an Invalid state . Event does not occur when the specified condition is met. When the event mark () which indicates that multiple events have been set is selected, all of the events that have been set are disabled.
Delete Event	Deletes the selected event. When the event mark () which indicates that multiple events have been set is selected, all of the events that have been set are deleted.
View Event Detailed Setup	Opens the Events panel to display the detailed information of the selected event.

(c) Pop-up display

By superimposing the mouse cursor on the [Event mark](#), the name of the event, the detailed information for the event and the comments added to the event are pop-up displayed.

When multiple events have been set in the applicable place, information for each event, up to a maximum of three events, is listed and displayed.

Remark If the updated time and date of the downloaded load module file are older than the source file opened, this whole area is warned in blue (the color depends on the configuration in the [\[General - Font and Color\] category](#) of the [Option dialog box](#)).

Figure A-16. Event Area Warned in Blue

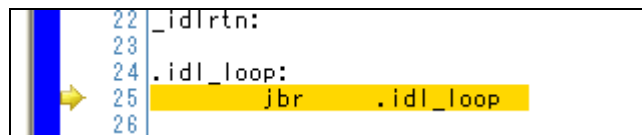
**(3) Line number area**

The line number of the opened text file/source file is displayed.

In addition, when connected to the debug tool and the downloaded source file is opened, the current PC mark (👉) that corresponds to the current PC position (PC register value) is displayed.

Note that the current PC mark is only displayed if the current PC value corresponds to the source text line, when the current PC position is modified or the state of the debug tool is changed from execution to stop.

(4) Characters area

The character strings of text files/source files are displayed and edited.

This area is provided with the following functions.

Remark The following items can be customized by setting the [Option dialog box](#).

- Display fonts
- Tab interval
- Display/hide/colors of control characters (control codes including a blank symbol)
- Colors of reserved words/comments

(a) Characters editing

Characters can be entered from the keyboard.

Various shortcut keys can be used to enhance the edit function.

(b) Tag jump

If the information of a file name, a line number and a column number exists in the line at the caret position, selecting [Tag Jump] from the context menu opens the file in the Editor panel and jumps to the corresponding line and the corresponding column (if the Editor panel is already opened, jump to the panel).

See "[Table 2-3. Operation of Tag Jump](#)" for details on the operation of the tag jump.

(c) Current PC line display

When the current PC position (PC register value) corresponds to the source text lines, those lines are shown highlighted (the highlighting color depends on the configuration in the [\[General - Font and Color\] category](#) of the [Option dialog box](#)).

This function is only enabled when connected to the debug tool and the source file is opened.

(d) Lines with breakpoints display

Lines where the breakpoints are set are shown highlighted (the highlighting color depends on the configuration in the [\[General - Font and Color\]](#) category of the [Option dialog box](#)).

This function is only enabled when connected to the debug tool and the source file is opened.

(e) Code coverage measurement result display [IECUBE][Simulator]

When the coverage function is valid^{Note}, lines corresponding to the specified coverage measurement area are shown highlighted based on the code coverage measurement result that is acquired by executing the program. See "[2.13 Measure Coverage \[IECUBE\]\[Simulator\]](#)" for details on the coverage measurement.

This function is only enabled when connected to the debug tool and the source file is opened.

Note [IECUBE]

The coverage function is always valid.

(f) Pop-up display of variables

By superimposing the mouse cursor on variables, variable values are pop-up displayed.

The display format of the variable value is same as "[Table A-9. Display Format of Watch-Expressions \(Default\)](#)" depending on the type of the variable.

This function is only enabled when connected to the debug tool and the source file is opened.

(g) Setting of various events

Various events can be set to the addresses/lines where the caret currently exists by selecting [\[Break Settings\]](#), [\[Trace Settings\]](#) or [\[Timer Settings\]](#) from the context menu.

The corresponding [Event mark](#) is displayed in the [Event area](#) by setting the event. In addition, the detailed information about the set event is reflected in the [Events panel](#).

Note, however, that the setting of events can be done only for those lines where the background color is shown in white in the event area.

This function is only enabled when connected to the debug tool and the source file is opened.

See the following for details on how to set events.

- "[2.8.3 Stop the program with the access to variables/SFRs](#)"
- "[2.11.3 Collect execution history in the arbitrary section](#)"
- "[2.11.4 Collect execution history when the condition is met](#)"
- "[2.12.2 Measure execution time in the arbitrary section \[IECUBE\]\[Simulator\]](#)"

Remark A breakpoint can be set or deleted easily in the [Event area](#) as well (see "[\(a\) Setting/deleting breakpoints](#)").

(h) Registering watch-expression

Variable names of C language, CPU registers, SFR, and assembler symbols can be registered in the [Watch panel](#) as watch-expressions.

See "[\(1\) Register a watch-expression](#)" for details on how to operate it.

This function is only enabled when connected to the debug tool and the source file is opened.

(i) File monitor

The following function for monitoring is provided to manage source files.

- A message is displayed when the downloaded lode module file is older than the source file to open.
- If the contents of the currently displayed file are changed not with CubeSuite, a message is displayed to indicate whether to save the file. You can either select yes or no.

[[File] menu (Editor panel-dedicated items)]

The following items are exclusive for the [File] menu in the Editor panel (other items are common to all the panels).

Close <i>file name</i>	Closes the currently editing Editor panel. When the contents of the panel have not been saved, a confirmation message is displayed.
Save <i>file name</i>	Overwrites the contents of the currently editing Editor panel. Note that when the file has never been saved or the file is write disabled, the same operation is applied as the selection in [Save <i>file name</i> As...].
Save <i>file name</i> As...	Opens the Save As dialog box to newly save the contents of the currently editing Editor panel.
<i>File name</i> Save Option...	Opens the Save Settings dialog box to change the encoding and new line code of the file being opened in the currently editing Editor panel.
Page Setup...	Opens the Windows dialog box to set the page layout.
Print...	Opens the Windows dialog box for printing the contents of the currently editing Editor panel.

[[Edit] menu (Editor panel-dedicated items)]

The following items are exclusive for [Edit] menu in the Editor panel (other items are all invalid).

Undo	Cancels the previous operation and restores the characters and the caret position (up to 100 times).
Redo	Cancels the previous [Undo] operation and restores the characters and the caret position.
Cut	Cuts the selected character string and copies it to the clipboard.
Copy	Copies the contents of the selected range to the clipboard as character string(s).
Paste	Inserts (insert mode) or overwrites (overwrite mode) the characters that are copied on the clipboard into the caret position.
Delete	Deletes one character at the caret position. When there is a selection area, all the characters in the area are deleted.
Select All	Selects all the characters from beginning to the end in the currently editing text file.
Find...	Opens the Search and Replace dialog box with selecting [Quick Search] tab. When there is a selection area, search is only taken place in the selection area.
Replace...	Opens the Search and Replace dialog box with selecting [Quick Replace] tab. When there is a selection area, replace is only taken place in the selection area.
Move...	Opens the Go to the Location dialog box to move the caret to the specified line.

[Context menu]

[Characters area/Line number area (while disconnecting from the debug tool)]

Jump to Function	Jumps to the function that is selected or at the caret position regarding the selected characters and the words at the caret position as functions (see "(4) Jump to functions ").
Back To Last Cursor Position	Goes back to the position before operating [Jump to Function].
Forward To Next Cursor Position	Forwards to the position before operating [Back To Last Cursor Position].
Tag Jump	Jumps to the corresponding line and column in the corresponding file if the information of a file name, a line number and a column number exists in the line at the caret position (see "(b) Tag jump ").
Cut	Deletes the selected character string(s) and copies them to the clipboard.
Copy	Copies the contents of the selected range to the clipboard as character string(s).
Paste	Inserts the contents of the clipboard into the caret position.
Open in New Panel	Opens a new Editor panel with the same contents as the current Editor panel (the title bar of the newly opened Editor panel displays the file name and ID number). The Editor panel can be opened up to 100 panels.

[Characters area/Line number area (while connecting to the debug tool)]

Register to Watch1	Registers a selected character string or a word at the caret position to the Watch panel (Watch1) as a watch-expression (the judgment of the word depends on current build tool). Note that this item becomes invalid when no corresponding address exists in the line at caret.
Register Action Event...	Opens the Action Events dialog box to set an action event to the corresponding address of the line at the caret position ^{Note} . Note that this item becomes invalid when no corresponding address exists in the line at caret.
Go to Here	Executes the program from the address indicated by the current PC value to the address corresponding to the line at the caret position ^{Note} . If the corresponding address of the line at the caret position does not exist, the program is executed to the corresponding address of the lower valid line. This item becomes invalid during execution of a program.
Set PC to Here	Sets the address of the line at the current caret position to the current PC value ^{Note} . Note that this item becomes invalid when no corresponding address exists in the line at caret, or during the execution of a program.
Move...	Opens the Go to the Location dialog box to move the caret to the specified line.
Jump to Function	Jumps to the function that is selected or at the caret position regarding the selected characters and the words at the caret position as functions (see "(4) Jump to functions ").
Back To Last Cursor Position	Goes back to the position before operating [Jump to Function].
Forward To Next Cursor Position	Forwards to the position before operating [Back To Last Cursor Position].
Tag Jump	Jumps to the corresponding line and column in the corresponding file if the information of a file name, a line number and a column number exists in the line at the caret position (see "(b) Tag jump ").

Break Settings	The following cascade menus are displayed to set the break-related event. Note that events can be set only for lines for which events can be set (see "(2) Event area").
Set Hardware Break	Sets a breakpoint (Hardware Break event) to the line at the caret position (see "2.8.2 Stop the program at the arbitrary position (breakpoint)") ^{Note} .
Set Software Break [IECUBE][MINICUBE2]	Sets a breakpoint (Software Break event) to the line at the caret position (see "2.8.2 Stop the program at the arbitrary position (breakpoint)") ^{Note} .
Set Read Break to	Sets a break event with read access condition to the line at the caret or the selected variable (global variable/static variable inside functions/file-internal static variable)/SFR (see "(1) Set a break event to a variable/SFR").
Set Write Break to	Sets a break event with write access condition to the line at the caret or the selected variable (global variable/static variable inside functions/file-internal static variable)/SFR (see "(1) Set a break event to a variable/SFR").
Set R/W Break to	Sets a break event with read/write access condition to the line at the caret or the selected variable (global variable/static variable inside functions/file-internal static variable)/SFR (see "(1) Set a break event to a variable/SFR").
Break Option	Opens the Property panel to set the break function.
Trace Settings [IECUBE][Simulator]	The following cascade menus are displayed to set the trace-related event. Note that events can be set only for lines for which events can be set (see "(2) Event area").
Start Tracing	Sets a Start Tracing event to start collecting the trace data when the line at the caret is executed (see "2.11.3 Collect execution history in the arbitrary section") ^{Note} . [Simulator] In addition, the selecting of the [Use trace function] property in the [Trace] [IECUBE][Simulator] category on the Property panel is automatically set to [Yes].
Stop Tracing	Sets a Stop Tracing event to stop collecting the trace data when the line at the caret is executed (see "2.11.3 Collect execution history in the arbitrary section") ^{Note} . [Simulator] In addition, the selecting of the [Use trace function] property in the [Trace] [IECUBE][Simulator] category on the Property panel is automatically set to [Yes].
Record R/W Value	Sets a Point Trace event to record the access value as the trace data when the line at the caret or the selected variable (global variable/static variable inside functions/file-internal static variable)/SFR is read/ write accessed (see "(1) When an access to variables/SFRs occurs").
Show Trace Result	Opens the Trace panel [IECUBE][Simulator] and displays the acquired trace data.
Trace Settings	Opens the Property panel to set the trace function.
Timer Settings [IECUBE][Simulator]	The following cascade menus are displayed to set the timer-related event (see "2.12.2 Measure execution time in the arbitrary section [IECUBE][Simulator]"). Note that events can be set only for lines for which events can be set (see "(2) Event area").
Start timer	Sets a Start Timer event to start measuring the execution time of the program when the line at caret is executed ^{Note} . [Simulator] In addition, the selecting of the [Use timer function] property in the [Timer] [Simulator] category on the Property panel is automatically set to [Yes].
Stop timer	Sets a Stop Timer event to stop measuring the execution time of the program when the line at caret is executed ^{Note} . [Simulator] In addition, the selecting of the [Use timer function] property in the [Timer] [Simulator] category on the Property panel is automatically set to [Yes].
View Result of Timer	Opens the Events panel and displays only timer-related events.

Clear Coverage Information	Clears all the coverage measurement results currently being stored in the debug tool. Note that this item appears only when the debug tool used supports the coverage function.
Jump to Disassemble	Opens the Disassemble panel and jumps to the address corresponding to the line at the caret ^{Note} . Note that this item becomes invalid when no corresponding address exists in the line at caret.
Cut	Deletes the selected character string(s) and copies them to the clipboard.
Copy	Copies the contents of the selected range to the clipboard as character string(s).
Paste	Inserts the contents of the clipboard into the caret position.
Open in New Panel	Opens a new Editor panel with the same contents as the current Editor panel (the title bar of the newly opened Editor panel displays the file name and ID number).

Note A message is displayed if these items are selected when the downloaded lode module file is older than the opened source file.

[Event area] [[IECUBE](#)][[MINICUBE2](#)]

Hardware Break First	The type of break that can be set by a one click operation of the mouse is set as a hardware breakpoint (this is reflected in the setting of the [First using type of breakpoint] property in the [Break] category on the Property panel).
Software Break First	The type of break that can be set by a one click operation of the mouse is set as a software breakpoint (this is reflected in the setting of the [First using type of breakpoint] property in the [Break] category on the Property panel).

Memory panel

This panel is used to display the contents of the memory and change the memory value (see "2.9.1 Display/change the memory").

Up to a maximum of four of these panels can be opened. Each panel is identified by the names "Memory1", "Memory2", "Memory3", and "Memory4" on the title bar.

The display contents are automatically updated when the value of the memory changes after a program is executed (when the execution is done in steps, the display is updated after each step).

In addition, by enabling the Real-time display update function, it is also possible to update the display contents in real-time even while a program is being executed.

This panel appears only when connected to the debug tool.

Figure A-17. Memory Panel

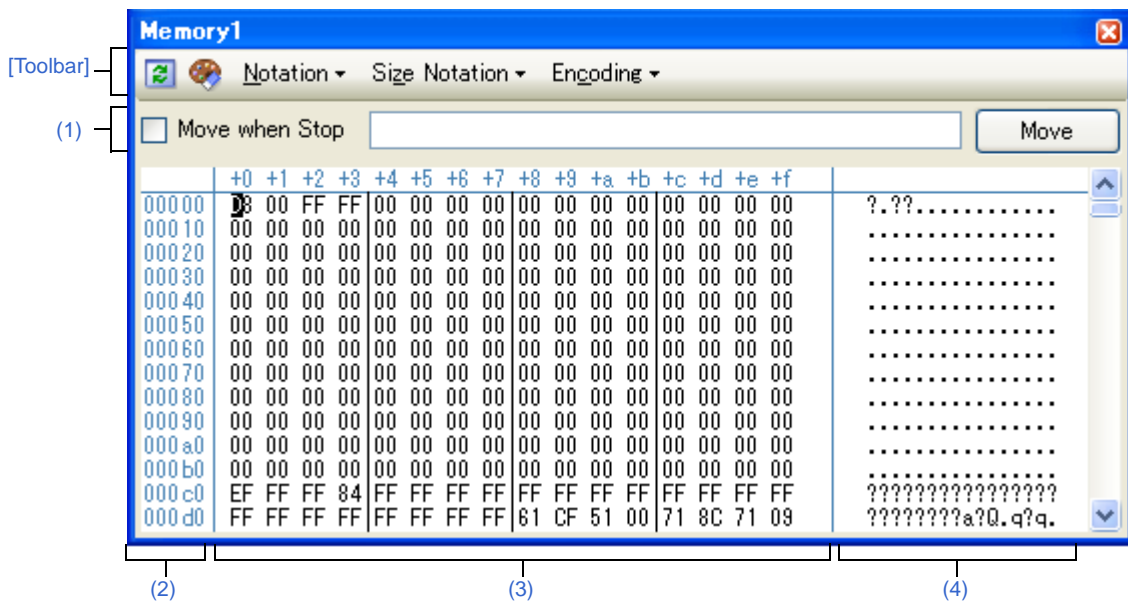

This section describes the following.

- [How to open]
- [Description of each area]
- [Toolbar]
- [[File] menu (Memory panel-dedicated items)]
- [[Edit] menu (Memory panel-dedicated items)]
- [Context menu]

[How to open]

- From the [View] menu, select [Memory] >> [Memory 1-4].

[Description of each area]

(1) Display position specification area

It is possible to specify the display start position of the memory contents by specifying an address expression. The follow the steps below.

(a) Specify an address expression

Directly input the address expression of the memory value address to display in the text box. You can specify an input expression with up to 1024 characters. The result of the expression is treated as the display start position address.

Note that if an address value greater than the microcontroller address space is specified, the upper address value is masked.

In addition, an address value greater than the value expressed within 32 bits cannot be specified.

(b) Specify automatic/manual evaluation of the address expression

The timing to change the display start position can be determined by specifying in the [Move when Stop] check box and the [Move] button.

[Move when Stop]	<input checked="" type="checkbox"/>	The caret is moved to the address which is automatically calculated from the address expression after the program is stopped.
	<input type="checkbox"/>	The address expression is not automatically evaluated after the program is stopped. Click the [Move] button to manually evaluate the address expression.
[Move] button		When the [Move when Stop] check box is not checked, click this button to evaluate the address expression and move the caret to the result address of the evaluation.

Remark If the specified address expression is the symbol and its size can be recognized, everything from the start address to the end address of that symbol is displayed selected.

(2) Address area

The address of the memory is displayed (hexadecimal number notation fixing).

The address width corresponds to the one in memory space of the specified microcontroller in the project.

This area cannot be edited.

(3) Memory value area

The value of the memory is displayed and changed.

The display starts from address "0" by default.

Specification of the display notation (radix and size) for the memory value is performed by selecting the buttons on the toolbar or [Notation]/[Size Notation] from the context menu (it is hexadecimal number/ 8-bit width in the default condition).

The meanings of the marks and colors displayed as memory values are as follows (character colors and background colors depend on the configuration in the [General - Font and Color] category of the Option dialog box):

Display Example (Default)			Description
00	Character color	Blue	Memory value that the user is changing Press the [Enter] key to write to the target memory.
	Background color	Standard color	
00 (Under line)	Character color	Standard color	Memory value of the address whose symbol has been defined (Registering watch-expression can be performed).
	Background color	Standard color	
00	Character color	Pink	Memory value for which the Real-time display update function is being operated
	Background color	Standard color	
00	Character color	Brown	Memory value that has been changed because of the execution of a program ^{Note} . To reset the highlighting, select the  button on the toolbar.
	Background color	Cream	

Display Example (Default)			Description
??	Character color	Gray	Area that are non-mapped, rewrite is restricted (such as SFR area/ I/O protection area), or memory which was not able to acquire a value.
	Background color	Standard color	
**	Character color	Standard color	A case where a area other than a real-time display update area is displayed and specified during execution of a program, or memory which was not able to acquire a value.
	Background color	Standard color	

Note Just before execution of a program, only the memory value in the address range for which the Memory panel had been displayed becomes the target.
 In addition, the value is not highlighted if it is same for before and after the execution of the program.

This area is provided with the following functions.

(a) Pop-up display

The following contents are pop-up displayed based on the nearest existing symbol forward from the address the mouse is designating when hovering the mouse cursor over the memory value.

Note that if there is no symbol information (the underlining is non-display), no pop-up display is done.

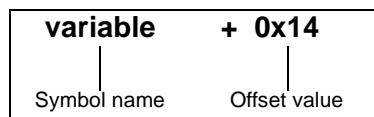

Symbol name	Indicates the name of the symbol.
Offset value	When a symbol has not been defined for the addresses, the offset value from the nearest symbol exists forward is displayed (hexadecimal number notation fixing).

(b) Real-time display update function

Using the real-time display update function enables to display/modify the value of the memory contents not only while the program is stopped, but also in execution.

See "(4) [Display/modify the memory contents during program execution](#)" for details on the real-time display update function.

(c) Changing memory values

Directly edit from the keyboard after moving the caret to the memory value to be edited.

The color of the memory value changes when it is in editing. Press the [Enter] key to write the edited value to the target memory (if the [Esc] key is pressed before the [Enter] key is pressed, the editing is cancelled).

See "(3) [Modify the memory contents](#)" for details on the method for changing the memory value.

(d) Searching/initializing memory value

The [Memory Search dialog box](#) is opened to search the memory contents in the specified address range by selecting [Find...] from the context menu.

In addition, the [Memory Initialize dialog box](#) is opened to change the memory contents collectively in the specified address range by selecting [Fill...] from the context menu.

(e) Copying and pasting

By selecting a range of memory values with the mouse, the contents of the range can be copied to the clipboard as a character string, and these contents can be pasted to the caret position.

These operations are performed by the selecting from the context menu or selecting from the [Edit] menu.

However, the paste operation is possible only when the character string to be pasted and the display notation (radix and size) of the area match.

If the display notation does not match, a message is displayed.

The character codes and character strings that can be handled by this area are as follows.

If character strings other than these are pasted, a message is displayed.

Character code	ASCII
Character string	0, 1, 2, 3, 4, 5, 6, 7, 8, 9, a, b, c, d, e, f, A, B, C, D, E, F

(f) Registering watch-expression

A memory value with underline indicates that a symbol has been defined in the address, and its symbol can be registered as a watch-expression.

After selecting the memory value or placing the caret on the memory value, the symbol name of the address is registered in the [Watch panel](#) (Watch1) as a watch-expression by selecting [Register to Watch1] from the context menu.

Caution A memory value without underline cannot be registered as a watch-expression.

(g) Saving the contents of memory values

The [Data Save dialog box](#) can be opened by selecting the [File] menu >> [Save Memory Data As...], and the contents of this panel can be saved in a text file (*.txt) or CSV file (*.csv).

See "(7) [Save the memory contents](#)" for details on the method for saving the contents of memory values.

(4) Character string area

Character codes that are converted from memory values are displayed.

Specification of the character code can be specified by clicking the button on the toolbar or selecting [Encoding] from the context menu item.

This area is provided with the following functions.

(a) Changing the character string

A character string can be changed only when [ASCII] has been selected as the character code.

Directly edit from the keyboard after moving the caret to the character string to be edited.

The color of the character string changes when it is in editing. Press the [Enter] key to write the edited value to the target memory (if the [Esc] key is pressed before the [Enter] key is pressed, the editing is cancelled).

(b) Copying and pasting

















By selecting a range of character strings with the mouse, the contents of the range can be copied to the clipboard as a character string, and these contents can be pasted to the caret position.

These operations are performed by the selecting from the context menu or selecting from the [Edit] menu.

However, the paste operation is possible only when [ASCII] has been selected as the character code. If other than [ASCII] is selected, a message is displayed.

[Toolbar]

The buttons below become invalid during execution of a program.

	Acquires the latest data from the debug tool, and updates the contents of this panel.
	Resets highlighting of values that have been changed by executing a program.
Notation	The following buttons to change the notation of memory values are displayed. The following cascade menus are displayed to specify the notation of memory values.
	Displays memory values in hexadecimal number (default).
	Displays memory values in signed decimal number.
	Displays memory values in unsigned decimal number.
	Displays memory values in octal number.
	Displays memory values in binary number.
Size Notation	The following buttons to change the notation of sizes of memory values are displayed.
	Displays memory values in 4-bit width.
	Displays memory values in 8-bit width (default).
	Displays memory values in 16-bit width.
	Displays memory values in 32-bit width.
	Displays memory values in 64-bit width.
Encoding	The following buttons to change the encoding of character strings are displayed.
	Displays character strings in ASCII code (default).
	Displays character strings in Shift_JIS code.
	Displays character strings in EUC-JP code.
	Displays character strings in UTF-8 code.

[[File] menu (Memory panel-dedicated items)]

The following items are exclusive for the [File] menu in the Memory panel (other items are common to all the panels). Note that all these items are invalid during execution of a program.

Save Memory Data	Overwrites the contents of this panel to the previously saved text file (*.txt)/CSV file (*.csv) (see "(g) Saving the contents of memory values"). Note that when the file has never been saved or the file is write disabled, the same operation is applied as the selection in [Save Memory Data As...].
Save Memory Data As...	Opens the Data Save dialog box to newly save the contents of this panel to the specified text file (*.txt)/CSV file (*.csv) (see "(g) Saving the contents of memory values").

[[Edit] menu (Memory panel-dedicated items)]

The following items are exclusive for [Edit] menu in the Memory panel (other items are all invalid).
Note that all these items are invalid during execution of a program.

Copy	Copies the contents of the selected range to the clipboard as character string(s).
Paste	Pastes the character string(s) copied in the clipboard to the caret position. - To the memory value area: See "(e) Copying and pasting". - To the character string area: See "(b) Copying and pasting".
Find...	Opens the Memory Search dialog box . The search is operated either in the Memory value area or the Character string area , in which a caret is.

[Context menu]

Register to Watch1	Registers the symbol at the caret to the Watch panel (Watch1). At this time, since it is registered as a variable name, the symbol name that is displayed changes depending on the scope. Note that this item becomes invalid when no symbol has been defined in the address corresponding to the memory value at the caret position (see "(f) Registering watch-expression").
Find...	Opens the Memory Search dialog box . The search is operated either in the Memory value area or the Character string area , in which a caret is. This item becomes invalid during execution of a program.
Fill...	Opens the Memory Initialize dialog box .
Refresh	Acquires the latest data from the debug tool, and updates the contents of this panel. This item becomes invalid during execution of a program.
Copy	Copies the contents of the selected range to the clipboard as character string(s). This item becomes invalid during execution of a program.
Paste	Pastes the character string(s) copied in the clipboard to the caret position. This item becomes invalid during execution of a program. - To the memory value area: See "(e) Copying and pasting". - To the character string area: See "(b) Copying and pasting".
Notation	The following cascade menus are displayed to specify the notation of memory values. The items below become invalid during execution of a program.
Hexadecimal	Displays memory values in hexadecimal number (default).
Signed Decimal	Displays memory values in signed decimal number.
Unsigned Decimal	Displays memory values in unsigned decimal number.
Octal	Displays memory values in octal number.
Binary	Displays memory values in binary number.

Size Notation	The following cascade menus are displayed to specify the notation of sizes of memory values. The items below become invalid during execution of a program.
4 Bits	Displays memory values in 4-bit width.
1 Byte	Displays memory values in 8-bit width (default).
2 Bytes	Displays memory values in 16-bit width.
4 Bytes	Displays memory values in 32-bit width.
8 Bytes	Displays memory values in 64-bit width.
Encoding	The following cascade menus are displayed to specify the character code in the character string area. The items below become invalid during execution of a program.
ASCII	Displays character strings in ASCII code (default).
Shift_JIS	Displays character strings in Shift_JIS code.
EUC-JP	Displays character strings in EUC-JP code.
UTF-8	Displays character strings in UTF-8 code.
Highlight Accessed	Highlights memory values that have changed by execution of a program if this item is checked (default). This item becomes invalid during execution of a program.
Periodic Updating	The following cascade menus are displayed to set for the real-time display update function (see "(b) Real-time display update function "). This item becomes invalid during execution of a program.
Periodic Updating Options	Opens the Property panel to set for the real-time display update function.

Disassemble panel

This panel is used to display the results of disassembling the contents of the memory (disassembled text), and execute line assembly (see "2.6.4 Perform line assembly").

Furthermore, the instruction level debugging (see "2.7.3 Execute programs in steps") and the code coverage measurement result display [IECUBE][Simulator] (see "2.13 Measure Coverage [IECUBE][Simulator]") can be performed in this panel.

Up to a maximum of four of these panels can be opened. Each panel is identified by the names "Disassemble1", "Disassemble2", "Disassemble3" and "Disassemble4" on the title bar.

The source text in the source file corresponding to the code data can also be displayed by setting to the mixed display mode (default).

This panel appears only when connected to the debug tool.

Caution A step execution is performed in instruction level units when the focus is in this panel (see "2.7.3 Execute programs in steps").

Figure A-18. Disassemble Panel (When Mixed Display Mode Is Selected)

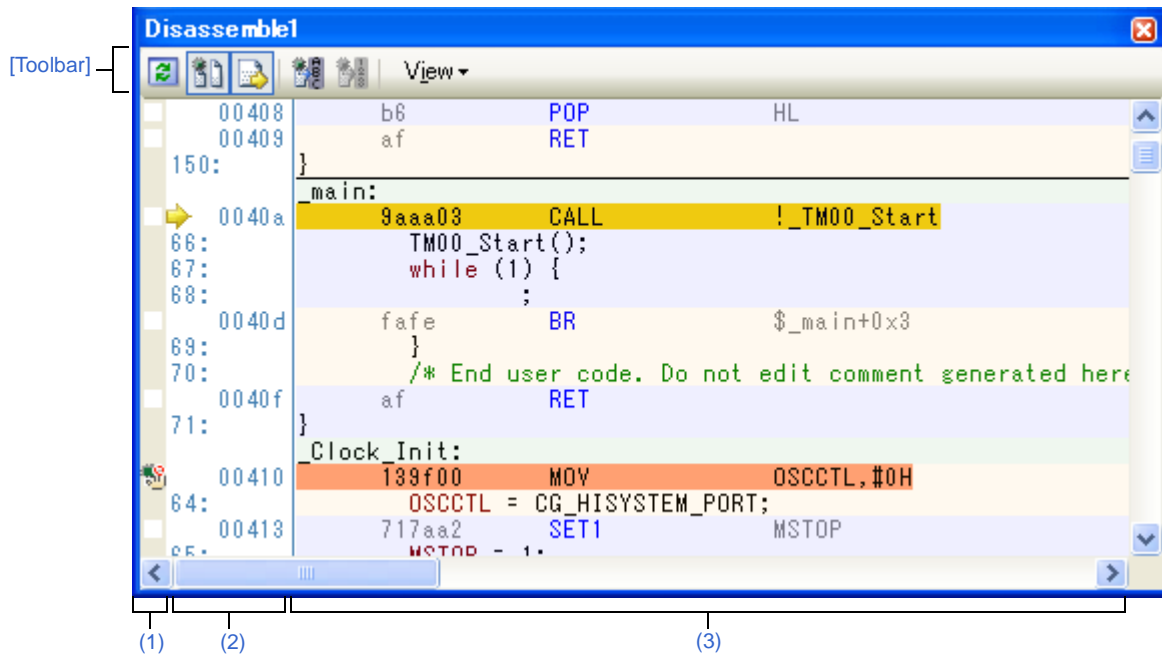

Figure A-19. Disassemble Panel (When Mixed Display Mode Is Not Selected)

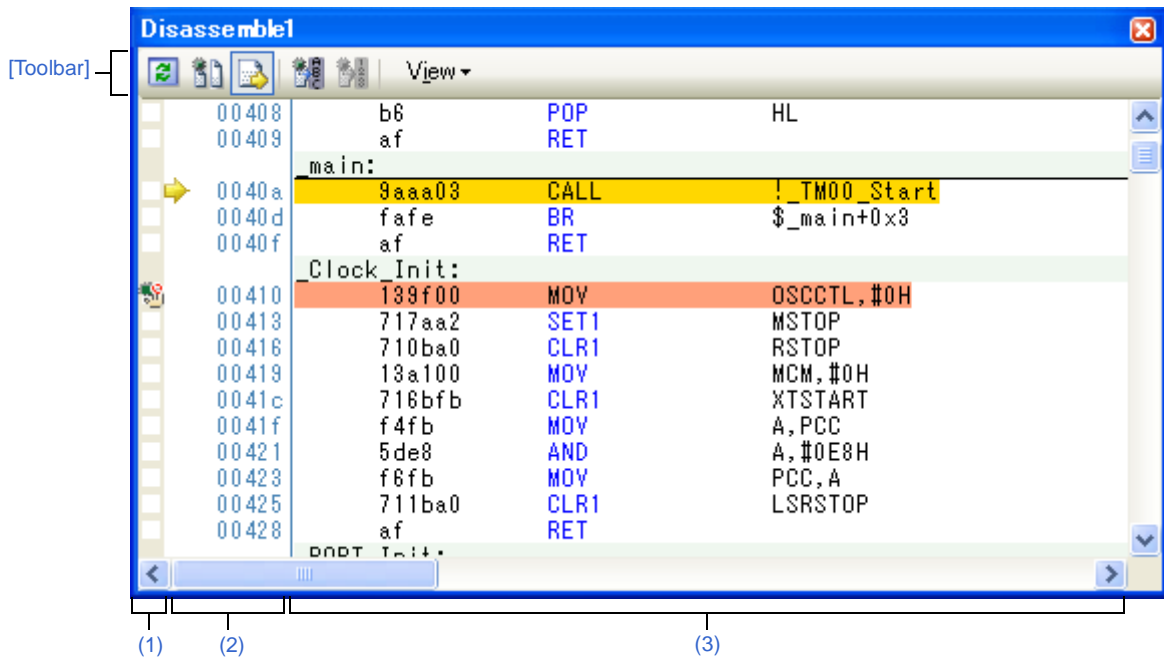
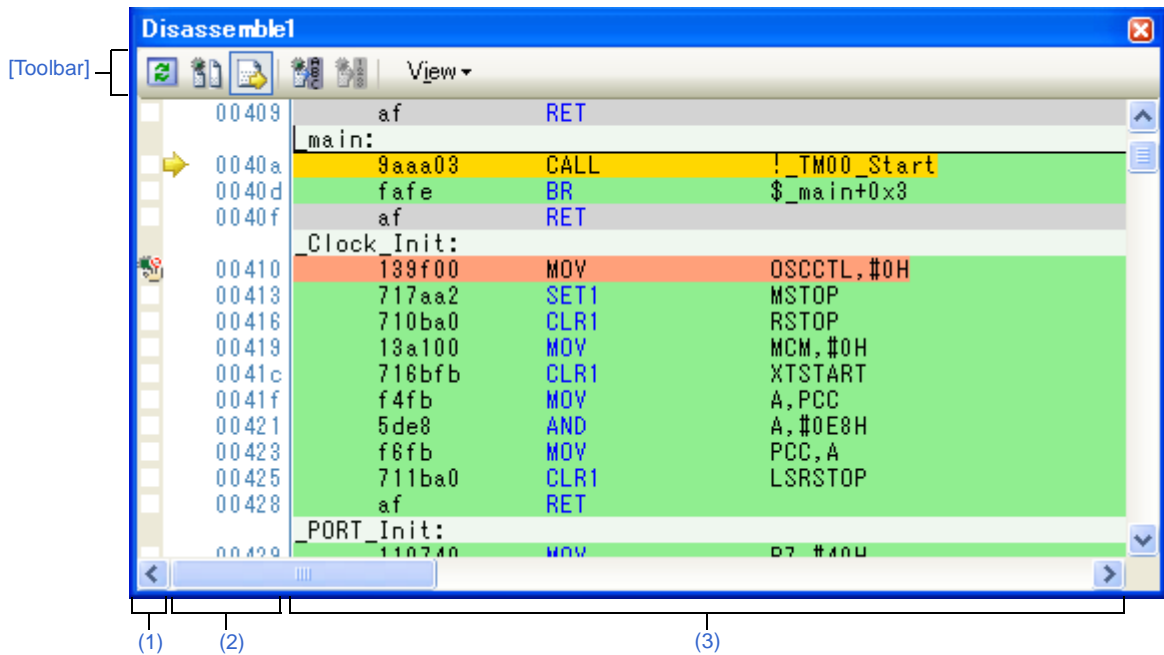

Figure A-20. Disassemble Panel (When Code Coverage Measurement Result Is Displayed)



This section describes the following.

- [How to open]
- [Description of each area]
- [Toolbar]
- [[File] menu (Disassemble panel-dedicated items)]
- [[Edit] menu (Disassemble panel-dedicated items)]
- [Context menu]

[How to open]

- From the [View] menu, select [Disassemble] >> [Disassemble 1 - 4].

[Description of each area]**(1) Event area**

The lines for which events can be set are shown with the background color in white (this mean that events cannot be set for those lines whose background color in gray).

In addition, the [Event mark](#) corresponding to an event that has been currently set is displayed.

This area is provided with the following functions.

(a) Setting/deleting breakpoints

By clicking where you want to set a breakpoint with the mouse, the breakpoint can be set easily.

The breakpoint is set to the instruction at the start address of the clicked line.

Once the breakpoint is set, the [Event mark](#) is displayed at the line that is set. In addition, the detailed information about the set breakpoint is reflected in the [Events panel](#).



When this operation is performed at a place where any one of the event marks is already being displayed, that event is deleted and the setting of breakpoints cannot be done.

Note that the setting of events can be done only for those lines where the background color is shown in white.

See "[2.8.2 Stop the program at the arbitrary position \(breakpoint\)](#)" for details on how to set the breakpoint.

(b) Changes event status

Event status can be changed from the following menu displayed by right-clicking the event mark.

Enable Event	Changes the selected event state to a Valid state . Event occurs when the specified condition is met. When the event mark () which indicates that multiple events have been set is selected, all of the events that have been set are enabled.
Disable Event	Changes the selected event state to an Invalid state . Event does not occur when the specified condition is met. When the event mark () which indicates that multiple events have been set is selected, all of the events that have been set are disabled.
Delete Event	Deletes the selected event. When the event mark () which indicates that multiple events have been set is selected, all of the events that have been set are deleted.
View Event Detailed Setup	Opens the Events panel to display the detailed information of the selected event.

(c) Pop-up display

By superimposing the mouse cursor on the [Event mark](#), the name of the event, the detailed information for the event and the comments added to the event are pop-up displayed.

When multiple events have been set in the applicable place, information for each event, up to a maximum of three events, is listed and displayed.

(2) Address area

The address per line to start disassembling is displayed (hexadecimal number notation fixing).

In addition, the current PC mark () that corresponds to the current PC position (PC register value) is displayed.

The address width corresponds to the one in memory space of the specified microcontroller in the project.

For the source text line in the mixed display mode, line numbers (xxx:) in the source file correspond to the start address are displayed.

Remark The display digit differs depending on the setting of the [Use memory bank function] property of the [Internal ROM/RAM] category in the [Connect Settings] tab of the Property panel.

In addition, when the selected microcontroller has a built-in memory bank, the maximum size of addresses differs depending on the number of memory banks being set (if the number of memory banks is 5, the maximum address is 0x4FFFF).

This area is provided with the following functions.

(a) Pop-up display

By superimposing the mouse cursor on a address or line number, the following information is pop-up displayed.

Address	Format: <Label name> + <Offset value> Example1: main + 0x10 Example2: sub function + 0x20
Source line number	Format: <File name> # <Line number> Example1: main.c#40 Example2: main.c#100

(3) Disassemble area

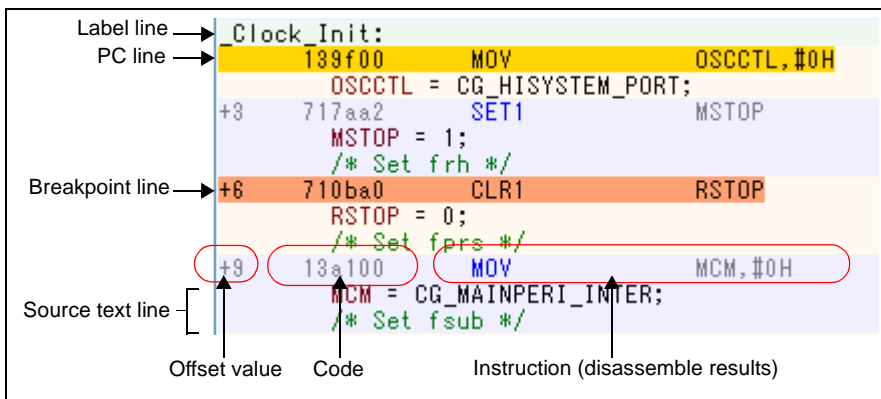

The labels that have been defined at the start address, the code data, disassembled mnemonics and the corresponding source text, etc., are displayed as follows:

Figure A-21. Display Contents of the Disassemble Area (In the Case of the Mixed Display Mode)



Label line	The label is displayed when a label is defined for the address, and its corresponding line is shown highlighted in lightgreen.
Offset value	The offset value from the nearest label is displayed when a label is defined for the address ^{Note 1} .
Code	The code that is the target of disassembly is displayed in hexadecimal number.
Instruction	Instruction is displayed as the result of disassembling. The mnemonics are shown highlighted in blue.
Source text line	The source text corresponding to the code data is displayed ^{Note 2} .

PC line	A line corresponding to an address of the current PC (PC register value) is shown highlighted ^{Note 3} .
Breakpoint line	A line at which a breakpoint is set is shown highlighted ^{Note 3} .

- Notes 1.** Offset values are not displayed by default.
Offset values can be displayed by clicking the  button on the toolbar or selecting [Show Offset] from the context menu.
- 2.** The source text can be set to non-display by clicking the  button (toggle) on the toolbar or removing the check for [Mixed Display] from the context menu (this option is checked by default).
- 3.** The highlighting color depends on the configuration in the [General - Font and Color] category of the Option dialog box.

This area is provided with the following functions.

(a) Line assembly

Instructions and code displayed in this panel can be edited (line assembly).
See "2.6.4 Perform line assembly" for details on how to operate it.

(b) Program execution by instruction level

Execution can be controlled at the instruction level unit by step executing a program in a state where there is a focus on this panel.
See "2.7.3 Execute programs in steps" for details on how to operate it.

(c) Setting of various events

Various events can be set to the addresses/lines where the caret currently exists by selecting [Bread Settings], [Trace Settings] or [Timer Settings] from the context menu.

The corresponding [Event mark](#) is displayed in the [Event area](#) when an event is set. In addition, the detailed information about the set event is reflected in the [Events panel](#).

+Note, however, that the setting of events can be done only for those lines where the background color is shown in white in the event area.

See the following for details on how to set events.

- "2.8.3 Stop the program with the access to variables/SFRs"
- "2.11.3 Collect execution history in the arbitrary section"
- "2.11.4 Collect execution history when the condition is met"
- "2.12.2 Measure execution time in the arbitrary section [IECUBE][Simulator]"

Remark A breakpoint can be set or deleted easily in the [Event area](#) as well (see "(a) Setting/deleting breakpoints").

(d) Registering watch-expression

Variable names of C language, CPU registers, SFR, and assembler symbols can be registered in the [Watch panel](#) as watch-expressions.

See "(1) Register a watch-expression" for details on how to operate it.

(e) Moving to symbol definition place

By clicking the  button on the toolbar or selecting [Move to Symbol] from the context menu in a state where the caret has been moved to an instruction that has referenced a symbol, the caret position is moved to the address where the symbol at the caret position has been defined.

In addition, when following on this operation you click on the  button on the toolbar or select [Back to Address] from the context menu, the caret position is returned to the instruction that has referenced a symbol before the caret was moved (the address value of the instruction that has referenced a symbol is displayed in Address).

(f) Jump to source line and memory

By selecting [Jump to Source] from the context menu, the Editor panel is opened with moving the caret to the source line corresponding to the address at the current caret position (if the Editor panel is already opened, jump to the panel).

In addition, by similarly selecting [Jump to Memory], the Memory panel (Memory1) is opened with moving the caret to the memory value corresponding to the address at the current caret position (if the Memory panel (Memory1) is already opened, jump to the panel).

(g) Code coverage measurement result display [IECUBE][Simulator]

When the coverage function is valid^{Note}, lines corresponding to the specified coverage measurement area are shown highlighted based on the code coverage measurement result that is acquired by executing the program. See "2.13 Measure Coverage [IECUBE][Simulator]" for details on the coverage measurement.

Note [IECUBE]











The coverage function is always valid.

(h) Saving the contents of disassembled data

The Data Save dialog box can be opened by selecting the [File] menu >> [Save Disassemble Data As...], and the contents of this panel can be saved in a text file (*.txt) or CSV file (*.csv).

See "(5) Save the disassembled text contents" for details on the method for saving the contents of disassembled data.

[Toolbar]

	Acquires the latest data from the debug tool, and updates the contents of this panel. This item becomes invalid during execution of a program.
	Sets to the mixed display mode and displays the correspondence between the disassembled data and the source text (default).
	Specifies the caret position so that it follows the current PC value.
	Moves the caret to the define position of the selected symbol.
	Moves the caret to the position (address) immediately before it is moved with the  button.
View	The following buttons to set the display contents in the disassemble area are displayed.
	Displays the offset value of the label. The offset value from the nearest label is displayed when a label is defined for the address.
	Displays the address value in the format "symbol + offset value" (default). Note that when a symbol has been defined as the address value, only the symbol is displayed.
	Displays the name of the register by its function name (default).
	Displays the name of the register by its absolute name.

[[File] menu (Disassemble panel-dedicated items)]

The following items are exclusive for the [File] menu in the Disassemble panel (other items are common to all the panels).

Note that all these items are invalid during execution of a program.

Save Disassemble Data	Overwrites the contents of the disassembling to the previously saved text file (*.txt)/CSV file (*.csv) (see "(h) Saving the contents of disassembled data "). Note that when the file has never been saved or the file is write disabled, the same operation is applied as the selection in [Save Disassemble Data As...].
Save Disassemble Data As...	Opens the Data Save dialog box to newly save the contents of the disassembling to the specified text file (*.txt)/CSV file (*.csv) (see "(h) Saving the contents of disassembled data ").

[[Edit] menu (Disassemble panel-dedicated items)]

The following items are exclusive for the [Edit] menu in the Disassemble panel (other items are all invalid).

Copy	When a line is selected, copies the contents of the selected line to the clipboard as a character string. In the case of the edit mode, copies the selected character string to the clipboard.
Rename	Changes to the edit mode to edit the instruction/code at the caret position (see "2.6.4 Perform line assembly "). This item becomes invalid during execution of a program.
Find...	Opens the Search and Replace dialog box with selecting the [Whole Search] tab.
Replace...	Opens the Search and Replace dialog box with selecting the [Whole Replace] tab.
Move...	Opens the Go to the Location dialog box to move the caret to the specified address.

[Context menu]

[Disassemble area and Address area]

Register to Watch1	Registers the selected character string or the word at the caret position to the Watch panel (Watch1) as a watch-expression (the judgment of the word depends on current build tool). At this time, since it is registered as a variable name, the symbol name that is displayed changes depending on the scope.
Register Action Event...	Opens the Action Events dialog box to set an action event to the address at the caret position.
Go to Here	Executes the program from the address indicated by the current PC value to the address corresponding to the line at the caret position. This item becomes invalid during execution of a program.
Set PC to Here	Sets the address of the line at the current caret position to the current PC value. This item becomes invalid during execution of a program.
Move...	Opens the Go to the Location dialog box to move the caret to the specified address.
Move to Symbol	Moves the caret to the define position of the selected symbol.
Back to Address	Moves the caret to the position (<i>address</i>) immediately before it is moved by [Move to Symbol]. Note that this item becomes invalid when no symbol name is displayed in the address.

Break Settings	The following cascade menus are displayed to set the break-related event. Note that breakpoints can be set only for lines for which events can be set (see "(1) Event area").
Set Hardware Break	Sets a breakpoint (Hardware Break event) to the address at the caret position (see "2.8.2 Stop the program at the arbitrary position (breakpoint)").
Set Software Break [IECUBE][MINICUBE2]	Sets a breakpoint (Software Break event) to the address at the caret position (see "2.8.2 Stop the program at the arbitrary position (breakpoint)").
Set Read Break to	Sets a break event with read access condition to the address at the caret or the selected variable (global variable/static variable inside functions/file-internal static variable)/SFR (see "(1) Set a break event to a variable/SFR").
Set Write Break to	Sets a break event with write access condition to the address at the caret or the selected variable (global variable/static variable inside functions/file-internal static variable)/SFR (see "(1) Set a break event to a variable/SFR").
Set R/W Break to	Sets a break event with read/write access condition to the address at the caret or the selected variable (global variable/static variable inside functions/file-internal static variable)/SFR (see "(1) Set a break event to a variable/SFR").
Break Option	Opens the Property panel to set the break function.
Trace Settings [IECUBE][Simulator]	The following cascade menus are displayed to set the trace-related event. Note that events can be set only for lines for which events can be set (see "(1) Event area").
Start Tracing	Sets a Start Tracing event to start collecting the trace data when an instruction of an address at the caret position is executed (see "2.11.3 Collect execution history in the arbitrary section"). [Simulator] In addition, the selecting of the [Use trace function] property in the [Trace] [IECUBE][Simulator] category on the Property panel is automatically set to [Yes].
Stop Tracing	Sets a Stop Tracing event to stop collecting the trace data when an instruction of an address at the caret position is executed (see "2.11.3 Collect execution history in the arbitrary section"). [Simulator] In addition, the selecting of the [Use trace function] property in the [Trace] [IECUBE][Simulator] category on the Property panel is automatically set to [Yes].
Record R/W Value	Sets a Point Trace event to record the access value as the trace data when the address at the caret or the selected variable (global variable/static variable inside functions/file-internal static variable)/SFR is read/ write accessed (see "(1) When an access to variables/SFRs occurs").
Show Trace Result	Opens the Trace panel [IECUBE][Simulator] and displays the acquired trace data.
Trace Settings	Opens the Property panel to set the trace function.
Timer Settings [IECUBE][Simulator]	The following cascade menus are displayed to set the timer-related event (see "2.12.2 Measure execution time in the arbitrary section [IECUBE][Simulator]"). Note that events can be set only for lines for which events can be set (see "(1) Event area").
Start timer	Sets a Start Timer event to start measuring the execution time of the program when an instruction of an address at the caret position is executed. [Simulator] In addition, the selecting of the [Use timer function] property in the [Timer] [Simulator] category on the Property panel is automatically set to [Yes].
Stop timer	Sets a Stop Timer event to stop measuring the execution time of the program when an instruction of an address at the caret position is executed. [Simulator] In addition, the selecting of the [Use timer function] property in the [Timer] [Simulator] category on the Property panel is automatically set to [Yes].
View Result of Timer	Opens the Events panel and displays only timer-related events.

Clear Coverage Information	Clears all the coverage measurement results currently being stored in the debug tool. Note that this item appears only when the debug tool used supports the coverage function.
Edit Disassemble	Changes to the edit mode to edit the instruction of the line at the caret position (see " 2.6.4 Perform line assembly "). This item becomes invalid during execution of a program.
Edit Code	Changes to the edit mode to edit the code of the line at the caret position (see " 2.6.4 Perform line assembly "). This item becomes invalid during execution of a program.
View	The following cascade menus to set the display contents in the disassemble area are displayed.
Show Offset	Displays the offset value of the label. The offset value from the nearest label is displayed when a label is defined for the address.
Show Symbol	Displays the address value in the format "symbol + offset value" (default). Note that when a symbol has been defined as the address value, only the symbol is displayed.
Show Function Name	Displays the name of the register by its function name (default).
Show Absolute Name	Displays the name of the register by its absolute name.
Mixed Display	Sets to the mixed display mode and displays the correspondence between the disassembled data and the source text (default).
Jump to Source	Opens the Editor panel and jumps to the source line corresponding to the address at the caret position in this panel.
Jump to Memory	Opens the Memory panel (Memory1) and jumps to the memory value corresponding to the address at the caret position in this panel.

[Event area] [IECUBE][MINICUBE2]

Hardware Break First	The type of break that can be set by a one click operation of the mouse is set as a hardware breakpoint (this is reflected in the setting of the [First using type of breakpoint] property in the [Break] category on the Property panel).
Software Break First	The type of break that can be set by a one click operation of the mouse is set as a software breakpoint (this is reflected in the setting of the [First using type of breakpoint] property in the [Break] category on the Property panel).

CPU Register panel

This panel is used to display the contents of the CPU register (general-purpose registers and control registers) and change the CPU register values (see "2.9.2 Display/change the CPU register").

This panel appears only when connected to the debug tool.

Remark When the separator line of each area in this panel is double-clicked, the width of the area changes to the shortest possible size that can display the contents of the area.

Figure A-22. CPU Register Panel

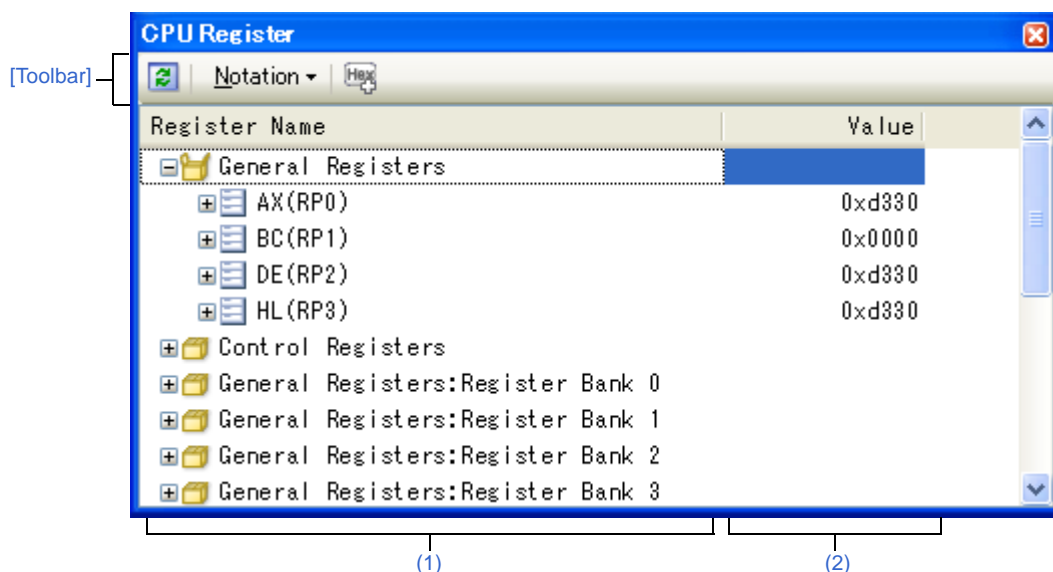

This section describes the following.

- [How to open]
- [Description of each area]
- [Toolbar]
- [[File] menu (CPU Register panel-dedicated items)]
- [[Edit] menu (CPU Register panel-dedicated items)]
- [Context menu]

[How to open]

- From the [View] menu, select [CPU Register].

[Description of each area]



(1) [Register Name] area

The types of register are classified as categories (folders), and a list of the respective register names is displayed.

Note that neither category names nor register names can be edited and deleted.

The meanings of the icons are as follows:

	Indicates that the register name belonging to this category is displayed. When you double-click on the icon, or click on the "-" mark, the category is closed and the register name is hidden.
	Indicates that the register name belonging to this category is hidden. When you double-click on the icon, or click on the "+" mark, the category is opened and the register name is displayed.

	Indicates the name of the register. When you double-click on the icon, or click on the "+" or "-" marks, the name of the register part is displayed or hidden.
	Indicates the name of the register part.

Category names and register names displayed are as follows (number of "+" marks before register names indicates the depth of the display level):

Table A-3. Category Names and Register Names in the CPU Register Panel

Category Name	Register Name (Alias)	Bit Width	Description
General-purpose register	+ AX(RP0)	16	General-purpose register (current register bank)
	++ X(R0)	8	
	++ A(R1)	8	
	+ BC(RP1)	16	
	++ C(R2)	8	
	++ B(R3)	8	
	+ DE(RP2)	16	
	++ E(R4)	8	
	++ D(R5)	8	
	+ HL(RP3)	16	
	++ L(R6)	8	
++ H(R7)	8		
Control register	+ PC	16	Program counter
	+ PC	20	Program counter ^{Note 1}
	+ PSW	8	Program status word
	++ IE	1	Interrupt enable flag
	++ Z	1	Zero flag
	++ RBS1	1	Register bank selection flag
	++ AC	1	Auxiliary carry flag
	++ RBS0	1	Register bank selection flag
	++ ISP	1	In service priority flag
	++ CY	1	Carry flag
	+ SP	16	Stack pointer

Category Name	Register Name (Alias)	Bit Width	Description
General-purpose register: Register bank <i>n</i> ^{Note 2}	+ AX(RP0): Register bank <i>n</i>	16	General-purpose register (current register bank)
	++ X(R0): Register bank <i>n</i>	8	
	++ A(R1): Register bank <i>n</i>	8	
	+ BC(RP1): Register bank <i>n</i>	16	
	++ C(R2): Register bank <i>n</i>	8	
	++ B(R3): Register bank <i>n</i>	8	
	+ DE(RP2): Register bank <i>n</i>	16	
	++ E(R4): Register bank <i>n</i>	8	
	++ D(R5): Register bank <i>n</i>	8	
	+ HL(RP3): Register bank <i>n</i>	16	
	++ L(R6): Register bank <i>n</i>	8	
	++ H(R7): Register bank <i>n</i>	8	

- Notes 1.** The current bank number is added to the 4 upper-order bits and displayed.
 If a PC value is set, then the 4 upper-order bits will be set automatically to the SFR BANK register.
 Note, however, that it will be displayed as a four-digit number if the following setting is made: on the [Property panel](#), on the [\[Connect Settings\] tab](#), in the [Internal ROM/RAM] category, the [Use memory bank function] property is set to [No].
- 2.** "*n*" indicates the number of the register bank (*n* = 0, 1, 2, 3).

This area is provided with the following functions.

(a) Registering watch-expression

CPU registers/categories can be registered in the [Watch panel](#) as watch-expressions.
 See "(1) [Register a watch-expression](#)" for details on how to operate it.

- Remarks 1.** When you have registered a watch-expression with a category as the object, all of the CPU registers belonging to that category are registered as watch-expressions.
- 2.** A scope specification is automatically added to a registered watch-expression.

(2) [Value] area

The values of each CPU register are displayed and changed.
 The radix of a data value can be selected by the button on the toolbar or the context menu item. In addition, a display format adding the value in hexadecimal number constantly can also be selected as well.
 The meanings of the colors of the CPU register values are as follows (character colors and background colors depend on the configuration in the [\[General - Font and Color\] category](#) of the [Option dialog box](#)):

Display Example (Default)			Description
0x0	Character color	Blue	The value of the CPU register that the user is changing Press the [Enter] key to write to the target memory.
	Background color	Standard color	
0x0	Character color	Brown	The value of the CPU register that has been changed because of the execution of a program The highlighting is rest by executing again the program.
	Background color	Cream	

This area is provided with the following functions.

(a) Changing the CPU register value

To edit the CPU register value, change the value directly from the keyboard after double-clicking on the value to be edited (press the [Enter] key to cancel the edit mode).











After you edit the value of the CPU register, it is written to the target memory of the debug tool by pressing the [Enter] key or moving the focus to outside the edit region.

(b) Saving the contents of the CPU register

The [Save As dialog box](#) can be opened by selecting the [File] menu >> [Save CPU Register Data As...], and all the contents of this panel can be saved in a text file (*.txt) or CSV file (*.csv).

See "(4) [Save the CPU register contents](#)" for details on the method for saving the contents of the CPU register.

[Toolbar]

	Acquires the latest data from the debug tool, and updates the contents of this panel. This item becomes invalid during execution of a program.
Notation	The following buttons to change the notation of a data value are displayed.
	Displays the value of the selected item (including sub-items) in the default notation (default).
	Displays the value of the selected item (including sub-items) in hexadecimal number.
	Displays the value of the selected item (including sub-items) in signed decimal number.
	Displays the value of the selected item (including sub-items) in unsigned decimal number.
	Displays the value of the selected item (including sub-items) in octal number.
	Displays the value of the selected item (including sub-items) in binary number.
	Displays the character string of the selected item (including sub-items) in ASCII code. If the character size is 2 bytes and above, it is displayed with the characters for each 1 byte arranged side-by-side.
	Displays the value of the selected item in Float. Note that when the value is not 4-byte data, displays it in the default notation.
	Displays the value of the selected item in Double. Note that when the value is not 8-byte data, displays it in the default notation.
	Adds the value in hexadecimal number enclosing with "()" at the end of the value.

[[File] menu (CPU Register panel-dedicated items)]

The following items are exclusive for the [File] menu in the CPU Register panel (other items are common to all the panels).

Note that all these items are invalid during execution of a program.

Save CPU Register Data	Overwrites the contents of this panel to the previously saved text file (*.txt)/CSV file (*.csv) (see "(b) Saving the contents of the CPU register "). Note that when the file has never been saved or the file is write disabled, the same operation is applied as the selection in [Save CPU Register Data As...].
Save CPU Register Data As...	Opens the Save As dialog box to newly save the contents of this panel to the specified text file (*.txt)/CSV file (*.csv) (see "(b) Saving the contents of the CPU register ").

[[Edit] menu (CPU Register panel-dedicated items)]

The following items are exclusive for [Edit] menu in the CPU Register panel (other items are all invalid).

Cut	Deletes the selected character string and copies it to the clipboard. This item becomes valid only when the character string is being edited.
Copy	Copies the selected character string to the clipboard during editing. If a line is selected, copies the register or the category to the clipboard. The copied item can be pasted to the Watch panel .
Paste	Pasts the character string copied in the clipboard to the caret position. This item becomes valid only when the character string is being edited.
Select All	Selects all the items of this panel.
Find...	Opens the Search and Replace dialog box with selecting the [Whole Search] tab.
Replace...	Opens the Search and Replace dialog box with selecting the [Whole Replace] tab.

[Context menu]

Register to Watch1	Registers the selected register or category to the Watch panel (Watch1).
Copy	Copies the selected character string to the clipboard during editing. If a line is selected, copies the register or the category to the clipboard. The copied item can be pasted to the Watch panel .
Notation	The following cascade menus to specify the notation of a data value are displayed.
AutoSelect	Displays the value of the selected item (including sub-items) in the default notation (default).
Hexadecimal	Displays the value of the selected item (including sub-items) in hexadecimal number.
Signed Decimal	Displays the value of the selected item (including sub-items) in signed decimal number.
Unsigned Decimal	Displays the value of the selected item (including sub-items) in unsigned decimal number.
Octal	Displays the value of the selected item (including sub-items) in octal number.
Binary	Displays the value of the selected item (including sub-items) in binary number.
ASCII	Displays the character string of the selected item (including sub-items) in ASCII code. If the character size is 2 bytes and above, it is displayed with the characters for each 1 byte arranged side-by-side.
Float	Displays the value of the selected item in Float. Note that when the value is not 4-byte data, displays it in the default notation.
Double	Displays the value of the selected item in Double. Note that when the value is not 8-byte data, displays it in the default notation.
Include Hexadecimal Value	Adds the value in hexadecimal number enclosing with "()" at the end of the value.

SFR panel

This panel is used to display the contents of the SFR and change the SFR values (see "2.9.3 Display/change the SFR").

This panel appears only when connected to the debug tool.

Caution The SFR that cause the microcontroller to operate when it is read is read-protected and therefore cannot be read ("?" is displayed in the value).

To read the value of read-protected SFR, select [Force Read Value] from the context menu.

Remark When the separator line of each area in this panel is double-clicked, the width of the area changes to the shortest possible size that can display the contents of the area.

Figure A-23. SFR Panel

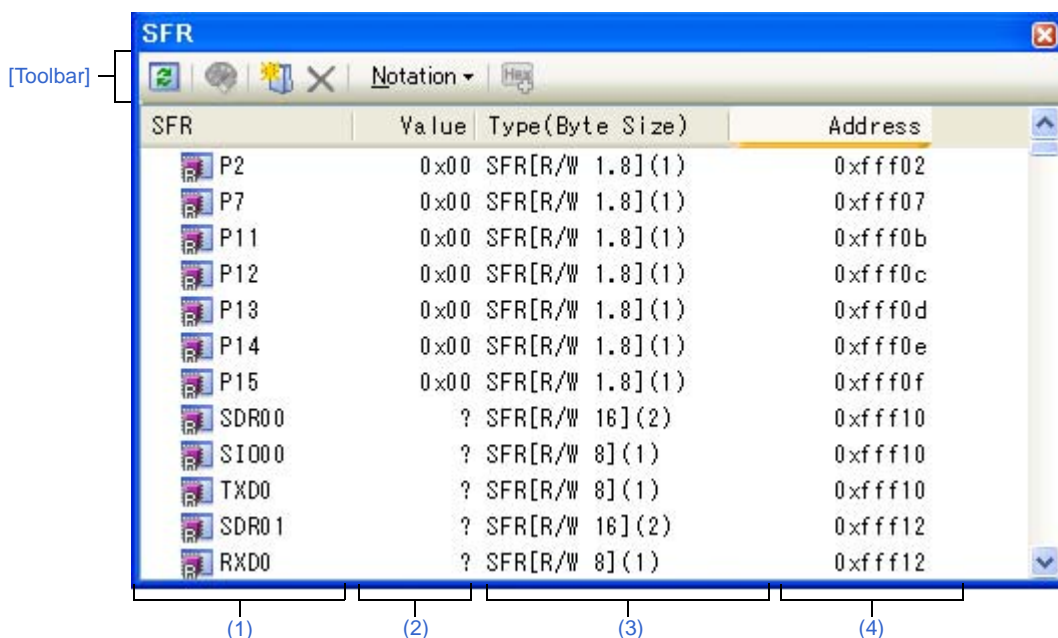

This section describes the following.



- [How to open]
- [Description of each area]
- [Toolbar]
- [[File] menu (SFR panel-dedicated items)]
- [[Edit] menu (SFR panel-dedicated items)]
- [Context menu]

[How to open]

- From the [View] menu, select [SFR].

[Description of each area]**(1) [SFR] area**

The types of SFR are classified as categories (folders), and a list of the respective SFR name is displayed. The meanings of the icons are as follows:

	Indicates that the SFR name belonging to this category is displayed. When you double-click on the icon, or click on the "-" mark, the category is closed and the SFR name is hidden.
	Indicates that the SFR name belonging to this category is hidden. When you double-click on the icon, or click on the "+" mark, the category is opened and the SFR name is displayed.
	Indicates the name of the SFR.

Remark The category names are sorted in character code order by clicking on the header part of this area (the SFR names in the category are also similarly sorted).

This area is provided with the following functions.

(a) Tree editing

The each SFR can be categorized (by folders) and displayed in the tree view.

To create a category, Click the  button on the toolbar or select [Create Category] from the context menu after moving the caret to a SFR name to create a category, and then input a desired name from the keyboard (up to 1024 characters).

To delete a category, select the category then click the  button on the toolbar or select [Delete] from the context menu. However, the categories that can be deleted are only the empty categories.

To rename the created category, select the category then do either one of the following.

- Click the name again, then directly rename the category name.
- Select the [Edit] menu >> [Rename], then directly rename the category name.
- Press the [F2] key, then directly rename the category name.

By directly dragging and dropping the SFR in the created category, each SFR is displayed in the categorized tree view.

Also, the display order of the categories and the SFR names (upper or lower position) can be changed easily by drag and drop operation.

- Cautions 1. Categories cannot be created within categories.**
2. SFRs cannot be added or deleted.

(b) Registering a watch-expression

Variable names of C language, CPU registers, SFR, and assembler symbols can be registered in the [Watch panel](#) as watch-expressions.

See "(1) [Register a watch-expression](#)" for details on how to operate it.

- Remarks 1.** When you have registered a watch-expression with a category as the object, all of SFR belonging to that category are registered as watch-expressions.
2. A scope specification is automatically added to a registered watch-expression.

(2) [Value] area

The value of SFR is displayed and changed.

The radix of a data value can be selected by the button on the toolbar or the context menu item. In addition, a display format adding the value in hexadecimal number constantly can also be selected as well.

The meanings of the marks and colors displayed as SFR values are as follows (character colors and background colors depend on the configuration in the [\[General - Font and Color\]](#) category of the [Option dialog box](#)):

Display Example (Default)			Description
0x0	Character color	Blue	The value of the SFR that the user is changing (press the [Enter] key to write to the target memory).
	Background color	Standard color	
0x0	Character color	Brown	The value of the SFR that has been changed because of the execution of a program To reset the highlighting, select the  button on the toolbar or [Reset Color] from the context menu.
	Background color	Cream	
?	Character color	Gray	The value of the SFR that is a read-protected object ^{Note}
	Background color	Standard color	

Note An SFR for which the microcontroller ends up being activated by a read operation is shown.
To read the value of read-protected SFR, select [Force Read Value] from the context menu.

Caution The timing for acquiring the values differs in the case of a 1 byte/2 bytes SFR and that of 1 bit SFRs that have been allocated to a 1 byte/2 bytes SFR. Owing to this, there are also cases where the values differ even if the value of the same SFR is displayed.

Remark The values are sorted in ascending order of the numerical values by clicking on the header part of this area.

This area is provided with the following functions.

(a) Changing SFR values

To edit the SFR value, change the value directly from the keyboard after double-clicking on the value to be edited (press the [Esc] key to cancel the edit mode).

After you edit the value of the SFR, it is written to the register of the debug tool by pressing the [Enter] key, or moving the focus to outside the edit region.

Note that it is not possible to change the values of SFRs during program execution.

You can use ASCII characters also to the values of SFRs.

- Examples 1.** When the numeric "0x41" is written to the SFR "P0"
>> "0x41" is written in the port "P0".
- 2.** When the ASCII character "A" is written to the SFR "P0"
>> "0x41" is written in the port "P0".

Caution The value of the read-only SFR cannot be edited.

(b) Saving the contents of the SFR

The [Save As dialog box](#) can be opened by selecting the [File] menu >> [Save SFR Data As...], and all the contents of the SFR can be saved in a text file (*.txt) or CSV file (*.csv).

See "(5) [Save the SFR contents](#)" for details on the method for saving the contents of the SFR.

(3) [Type (Byte Size)] area

The type information of each SFR is displayed in the following formats.

- <Type of SFR> [<Access attribute> <All accessible sizes>](<Size>)

Access attribute	One of the following is displayed as the access attribute.	
	R	Read only
	W	Write only
	R/W	Read/Write
All accessible sizes	All accessible sizes are demarcated by a comma and listed in order of the smallest size in bit units.	
Size	The size of the SFR is displayed. It is displayed by supplying the unit, in byte units in the event that it can be displayed in byte units, and in bit units in the event that it can be displayed on in bit units.	

- Examples 1.** 「The case of "SFR [R/W 1.8] (1 byte)"
An SFR that is readable/writable and 1 bit accessible/8 bit accessible, and whose size is 1 byte
- 2.** 「The case of "SFR [R/W 1] (1 bit)"
An SFR that is readable/writable and 1 bit accessible, and whose size is 1 byte

Remark The type information is sorted in the character code order by clicking on the header part of this area.

(4) [Address] area





The address that each SFR is mapped is displayed (hexadecimal number notation fixing).







However, in the case of the bit register, it is displayed by providing a bit offset value like the following examples.

- Examples 1.** The case of "0xFF40"
This is allocated to the address "0xFF40"
- 2.** The case of "0xFF40.4"
This is allocated to bit 4 of the address "0xFF40.4" (bit register)

Remark The addresses are sorted in ascending order of numerical values by clicking on the header part of this area.

[Toolbar]

	Acquires the latest data from the debug tool, and updates the contents of this panel. Note that the values of read-protected SFR are not re-read. This item becomes invalid during execution of a program.
	Resets highlighting of the selected SFR whose value has been changed by executing a program. Note that this item becomes invalid during execution of a program.
	Adds a new category (folder). Directly input the category name in the text box. There are no restrictions on the number of categories that can be created anew (however, it is not possible to create a category inside a category). Note that this item becomes invalid during execution of a program.
	Deletes the selected character string(s). If an empty category is in a select state, its category is deleted (it is not possible to delete SFRs).

Notation	The following buttons to change the notation of a data value are displayed.
	Displays the value of the selected item in hexadecimal number (default).
	Displays the value of the selected item in signed decimal number.
	Displays the value of the selected item in unsigned decimal number.
	Displays the value of the selected item in octal number.
	Displays the value of the selected item in binary number.
	Displays the value of the selected item in ASCII code.
	Adds the value in hexadecimal number enclosing with "()" at the end of the value of the selected item.

[[File] menu (SFR panel-dedicated items)]

The following items are exclusive for the [File] menu in the SFR panel (other items are common to all the panels). Note that all these items are invalid during execution of a program.

Save SFR Data	Overwrites the contents of this panel to the previously saved text file (*.txt)/CSV file (*.csv) (see "(b) Saving the contents of the SFR"). Note that when the file has never been saved or the file is write disabled, the same operation is applied as the selection in [Save SFR Data As...].
Save SFR Data As...	Opens the Save As dialog box to newly save the contents of this panel to the specified text file (*.txt)/CSV file (*.csv) (see "(b) Saving the contents of the SFR").

[[Edit] menu (SFR panel-dedicated items)]

The following items are exclusive for [Edit] menu in the SFR panel (other items are all invalid).

Cut	Deletes the selected character string(s) and copies them to the clipboard (it is not possible to cut SFRs/categories).
Copy	Copies the contents of the selected range to the clipboard as character string(s). If the SFR(s)/category(s) are selected, copies them to the clipboard. The copied item can be pasted to the Watch panel .
Paste	If texts are in editing, pastes the contents of the clipboard to the caret position (it is not possible to paste SFRs/categories).
Delete	Deletes the selected character string(s). If an empty category is in a select state, its category is deleted (it is not possible to delete SFRs).
Select All	If texts are in editing, selects all the character strings. If texts are not in editing, selects all the SFRs/categories.
Rename	Edits the name of the selected category.
Find...	Opens the Search and Replace dialog box with selecting [Whole Search] tab.
Replace...	Opens the Search and Replace dialog box with selecting [Whole Replace] tab.
Move...	Opens the Go to the Location dialog box to move the caret to the specified SFR.

[Context menu]

Register to Watch1	Registers the selected SFR or category to the Watch panel (Watch1).
Refresh	Acquires the latest data from the debug tool, and updates the contents of this panel. Note that the values of read-protected SFR are not re-read. This item becomes invalid during execution of a program.
Force Read Value	Forcibly reads once the value of the read-protected SFR.
Move...	Opens the Go to the Location dialog box .
Create Category	Adds a new category (folder). Directly input the category name in the text box. There are no restrictions on the number of categories that can be created anew (however, it is not possible to create a category inside a category). Note that this item becomes invalid during execution of a program.
Copy	Copies the contents of the selected range to the clipboard as character string(s). If the SFR(s)/category(s) are selected, copies them to the clipboard. The copied item can be pasted to the Watch panel .
Delete	Deletes the selected character string(s). If an empty category is in a select state, its category is deleted (it is not possible to delete SFRs).
Notation	The following cascade menus are displayed to specify the notation.
Hexadecimal number	Displays the value of the selected item in hexadecimal number (default).
Signed Decimal	Displays the value of the selected item in signed decimal number.
Unsigned decimal number	Displays the value of the selected item in unsigned decimal number.
Octal	Displays the value of the selected item in octal number.
Binary	Displays the value of the selected item in binary number.
ASCII	Displays the value of the selected item in ASCII code.
Include Hexadecimal Value	Adds the value in hexadecimal number enclosing with "()" at the end of the value of the selected item.
Reset Color	Resets highlighting of the selected SFR whose value has been changed by executing a program.

Local Variables panel

This panel is used to display the contents of the local variable and change the local variable values (see "2.9.5 Display/change local variables").

This panel appears only when connected to the debug tool.

Caution Nothing is displayed on this panel during execution of a program. When the execution of a program is stopped, items in each area are displayed.

Remark When the separator line of each area in this panel is double-clicked, the width of the area changes to the shortest possible size that can display the contents of the area.

Figure A-24. Local Variables Panel

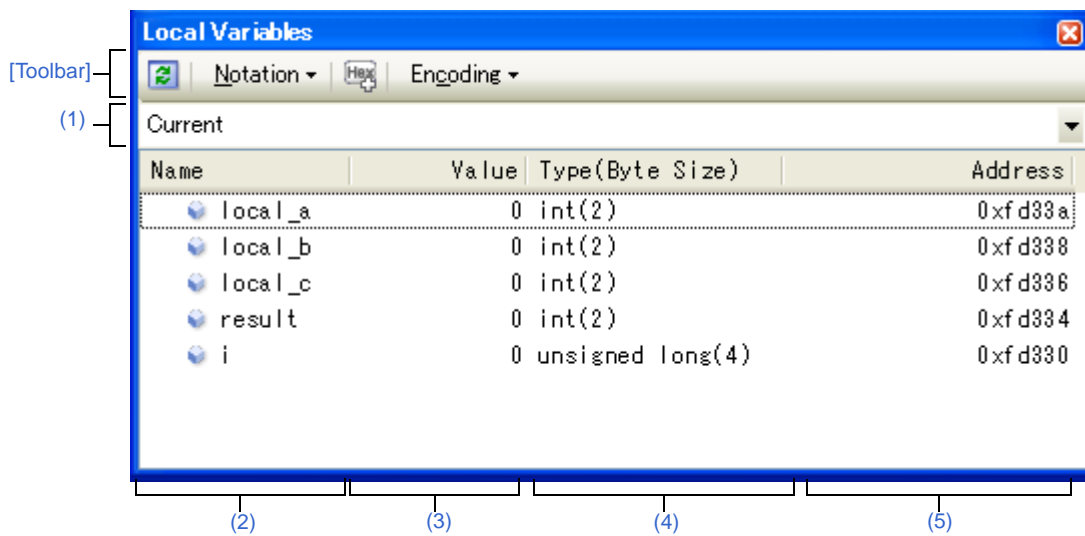

This section describes the following.

- [How to open]
- [Description of each area]
- [Toolbar]
- [[File] menu (Local Variables panel-dedicated items)]
- [[Edit] menu (Local Variables panel-dedicated items)]
- [Context menu]

[How to open]

- From the [View] menu, select [Local Variable].

[Description of each area]

(1) Scope area

Select the scope of the local variable to be displayed from the following drop-down list.

Item	Operation
Current	Displays local variables in the scope of the current PC value.

Item	Operation
<Depth> <Function name() [file name#line number]> ^{Note}	Displays local variables in the scope of the calling function. After the program is executed, the scope that is selected is maintained as long as the selected scope exists.

Note The calling functions displayed in the [Call Stack panel](#) are displayed.

(2) [Name] area



The local variable name or function name is displayed.

The argument of the function is also displayed as the local variable.

In addition, the hierarchical structure is displayed in tree format for arrays, pointer variables, and structures or unions.

This area cannot be edited.

The meanings of the icons are as follows:

	Indicates the variable. Auto, Internal Static, and Register variables are also displayed ^{Note} . In addition, the hierarchical structure is displayed in tree format for arrays, pointer variables, and structures or unions. If "+" mark exist at the top of the name, the next structure is expanded by clicking it (the mark changes to "-" after the expansion).	
	Array	All elements in the array
	Pointer variables	Variables that the pointer designates If the pointer designates a pointer, add "+" mark and expand it by clicking the mark. Note that if the pointer designates an unknown, "?" mark is displayed.
	Structures/Unions	All the member of structures/unions
	Indicates the argument.	
	Indicates the function.	

Note When Auto variables are used to display local variables, accurate values cannot be displayed at a prologue ("{"") or epilogue ("}") of a function. (The Auto variable addresses are the relative addresses from the address pointed to by the stack pointer (SP), so their addresses are not determined until the SP value is determined in the function. The SP is manipulated via prologues or epilogues, so the accurate value cannot be displayed.

This area is provided with the following functions.

(a) Registering watch-expression

Variable names of C language can be registered in the [Watch panel](#) as watch-expressions.

See "(1) [Register a watch-expression](#)" for details on how to operate it.

Remark A scope specification is automatically added to a registered watch-expression.

(b) Jump to memory

By selecting [Jump to Memory] from the context menu, the [Memory panel](#) (Memory1) opens with moving the caret to the source line corresponding to the address where the selected local variable is disposed (if the Memory panel (Memory1) is already opened, jump to the panel).

(3) [Value] area

The value of the local variable is displayed and changed.

The notation of a data value can be selected by the button on the toolbar or the context menu item. In addition, a display format adding the value in hexadecimal number constantly can also be selected as well.

The meanings of the marks and colors displayed as the values of the local variables are as follows (character colors and background colors depend on the configuration in the [\[General - Font and Color\]](#) category of the [Option dialog box](#)):

Display Example (Default)			Description
0x0	Character color	Blue	The value of the local variable that the user is changing Press the [Enter] key to write to the target memory.
	Background color	Standard color	
0x0	Character color	Brown	The value of the local variable that have been changed because of the execution of a program ^{Note} The highlighting is rest by executing again the program.
	Background color	Cream	
?	Character color	Gray	When the value of the local variable cannot be acquired
	Background color	Standard color	

Note Variables that the name stays same from the start point where the program started executing to the breakpoint and their values are changed are the target.

This area is provided with the following functions.

(a) Changing the local variable/argument value

To edit the local variable value or the argument value, select the value to edit, then change the value directly from the keyboard after clicking again on it (press the [Esc] key to cancel the edit mode).

After you edit the value of the local variable or the argument, it is written to the target memory of the debug tool by pressing the [Enter] key or moving the focus to outside the edit region.

See "(2) [Modify the contents of local variables](#)" for details on the method for changing the local variable/argument value.

(b) Saving the contents of the local variable

The [Save As dialog box](#) can be opened by selecting the [File] menu >> [Save Local Variables Data As...], and all the contents of this panel can be saved in a text file (*.txt) or CSV file (*.csv).

See "(3) [Save the contents of local variables](#)" for details on the method for saving the contents of the local variable.

(4) [Type (Byte Size)] area

The type name of the local variable is displayed. The notation accords with the description of C language.

For an array, an element number is displayed in "[]". For a function, its size (number of bytes) is displayed in "()".

This area cannot be edited.















(5) [Address] area

The address of the local variable is displayed. When a variable is assigned to the register, the name of the register is displayed.

This area cannot be edited.

[Toolbar]

The buttons below become invalid during execution of a program.

	Acquires the latest data from the debug tool, and updates the contents of this panel.
Notation	The following buttons to specify the notation of values are displayed.
	Displays values on this panel in the default notation according to the type of variable (default).
	Displays values on this panel in hexadecimal number.
	Displays values on this panel in decimal number.
	Displays values on this panel in octal number.
	Displays values on this panel in binary number.
	Displays array indexes on this panel in decimal number (default).
	Displays array indexes on this panel in hexadecimal number.
	Displays values on this panel in Float. Note that when the value is not 4-byte data, or has the type information, displays it in the default notation.
	Displays values on this panel in Double. Note that when the value is not 4-byte data, or has the type information, displays it in the default notation.
	Adds the value in hexadecimal number enclosing with "()" at the end of the value.
Encoding	The following buttons to specify the encoding of character variables are displayed.
	Displays character variables in ASCII code (default).
	Displays character variables in Shift_JIS code.
	Displays character variables in EUC-JP code.
	Displays character variables in UTF-8 code.

[[File] menu (Local Variables panel-dedicated items)]

The following items are exclusive for the [File] menu in the Local Variables panel (other items are common to all the panels).

Note that all these items are invalid during execution of a program.

Save Local Variables Data	Overwrites the contents of this panel to the previously saved text file (*.txt)/CSV file (*.csv) (see "(b) Saving the contents of the local variable"). Note that when the file has never been saved or the file is write disabled, the same operation is applied as the selection in [Save Local Variables Data As...].
Save Local Variables Data As...	Opens the Save As dialog box to newly save the contents of this panel to the specified text file (*.txt)/CSV file (*.csv) (see "(b) Saving the contents of the local variable").

[[Edit] menu (Local Variables panel-dedicated items)]

The following items are exclusive for [Edit] menu in the Local Variables panel (other items are all invalid).

Copy	Copies the contents of the selected line or the character string to the clipboard.
Select All	Selects all the items of this panel.
Rename	Changes to the edit mode to edit the selected local variable value (see "(2) Modify the contents of local variables "). This item becomes invalid during execution of a program.
Find...	Opens the Search and Replace dialog box with selecting the [Whole Search] tab.
Replace...	Opens the Search and Replace dialog box with selecting the [Whole Replace] tab.

[Context menu]

All the items from the context menu become invalid during execution of a program.

Register to Watch1	Registers the selected local variable to the Watch panel (Watch1).
Copy	Copies the contents of the selected line or the character string to the clipboard.
Notation	The following cascade menus to specify the notation of values are displayed.
AutoSelect	Displays values on this panel in the default notation according to the type of variable (default).
Hexadecimal	Displays values on this panel in hexadecimal number.
Decimal	Displays values on this panel in decimal number.
Octal	Displays values on this panel in octal number.
Binary	Displays values on this panel in binary number.
Decimal Notation for Array Index	Displays array indexes on this panel in decimal number (default).
Hexadecimal Notation for Array Index	Displays array indexes on this panel in hexadecimal number.
Float	Displays values on this panel in Float. Note that when the value is not 4-byte data, or has the type information, displays it in the default notation.
Double	Displays values on this panel in Double. Note that when the value is not 4-byte data, or has the type information, displays it in the default notation.
Include Hexadecimal Value	Adds the value in hexadecimal number enclosing with "()" at the end of the value.
Encoding	The following cascade menus to specify the encoding of character variables are displayed.
ASCII	Displays character variables in ASCII code (default).
Shift_JIS	Displays character variables in Shift_JIS code.
EUC-JP	Displays character variables in EUC-JP code.
UTF-8	Displays character variables in UTF-8 code.
Jump to Memory	Opens the Memory panel (Memory1) and jumps to the memory value corresponding to the address of the selected line in this panel.

Watch panel

This panel is used to display the contents of the registered watch-expressions and change their values (see "2.9.6 Display/change watch-expressions").

Up to a maximum of four of these panels can be opened. Each panel is identified by the names "Watch1", "Watch2", "Watch3", and "Watch4" on the title bar, and the watch-expressions can be registered/deleted/moved individually.

Watch-expressions can be registered in this panel as well as in the Editor panel, Disassemble panel, Memory panel, CPU Register panel, Local Variables panel or SFR panel.

When the panel is closed with registered watch-expressions, the panel closes but the information on the registered watch-expressions is retained. Therefore, if the same panel is opened again, it is opened with the watch-expressions registered.

The display contents are automatically updated when the value of the watch-expression changes after a program is executed (when the execution is done in steps, the display is updated after each step).

In addition, by enabling the Real-time display update function, it is also possible to update the display contents in real-time even while a program is being executed.

This panel appears only when connected to the debug tool.

Remark When the separator line of each area in this panel is double-clicked, the width of the area changes to the shortest possible size that can display the contents of the area.

Figure A-25. Watch Panel

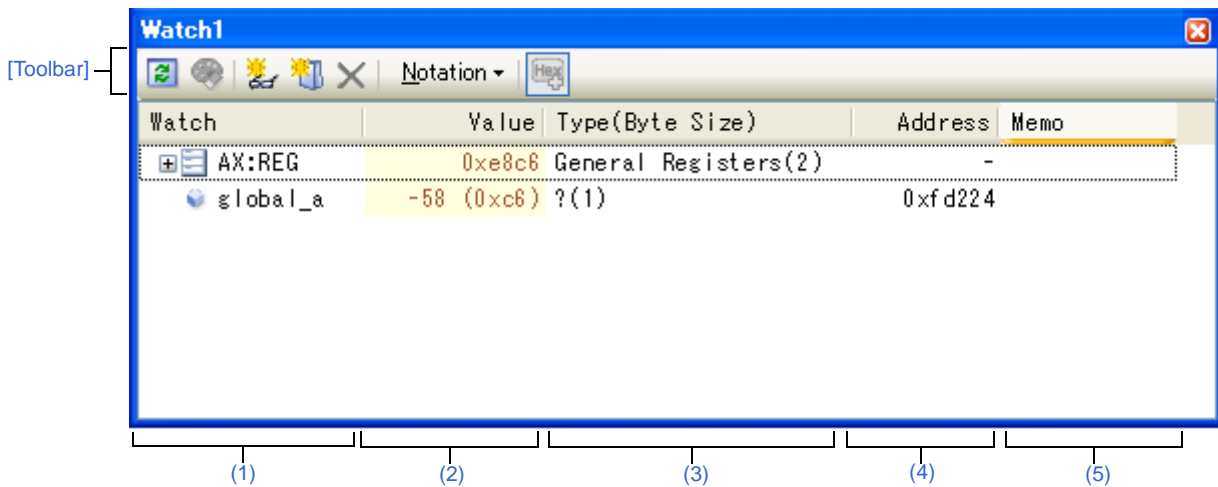

This section describes the following.

- [How to open]
- [Description of each area]
- [Toolbar]
- [[File] menu (Watch panel-dedicated items)]
- [[Edit] menu (Watch panel-dedicated items)]
- [Context menu]

[How to open]

- From the [View] menu, select [Watch] >> [Watch 1 - 4].







[Description of each area]**(1) [Watch] area**

All the registered watch-expressions are displayed in a list.

Clicking the title of the list in this area sorts the watch-expressions in the list in alphabetical order.

Categories (folders) can be created to categorize the watch-expressions and display them in the tree view (see "(a) [Tree editing](#)").

The meanings of the icons are as follows:

	Indicates that the watch-expression belonging to this category is displayed. When you double-click on the icon, or click on the "-" mark, the category is closed and the watch-expression is hidden.
	Indicates that the watch-expression belonging to this category is hidden. When you double-click on the icon, or click on the "+" mark, the category is opened and the watch-expression is displayed.
	Indicates that the watch-expression is a variable. At the top of the watch-expression represents arrays, pointer type variables, and structures/unions, "+"/"- mark is displayed. Click the mark to Expand/shrink display .
	Indicates that the watch-expression is a function.
	Indicates that the watch-expression is SFR.
	Indicates that the watch-expression is CPU register. At the top of the watch-expression that has the lower level register (part of the register), "+"/"- mark is displayed. Click the mark to Expand/shrink display .

This area is provided with the following functions.

(a) Tree editing

Watch-expressions can be categorized (by folders) and displayed in the tree view.

To create a category, click the  button on the toolbar or select [Create Category] from the context menu after moving the caret to the position to create a category, and then input a desired name from the keyboard.

To delete a category, select the category then click the  button on the toolbar or select [Delete] from the context menu.

To rename the created category, select the category then do either one of the following.

- Click the name again, then directly rename the category name.
- Select the [Edit] menu >> [Rename], then directly rename the category name.
- Press the [F2] key, then directly rename the category name.

By directly dragging and dropping the registered watch-expression in the created category, each category is displayed in the categorized tree view.

Also, the display order of the categories and the watch-expressions (upper or lower position) can be changed easily by drag and drop operation.

- Cautions 1. Categories cannot be created within categories.**
- 2. Up to 64 categories can be created in one watch panel (if this restriction is violated, a message appears).**

Remark Drag and drop the watch-expressions/categories in other watch panel (Watch1 to Watch4) to copy them.

(b) Expand/shrink display

At the top of the watch-expression represents arrays, pointer type variables, structures/unions, and registers (with the name of the part), "+"/"-" mark is displayed. Click the mark to expand the contents ("+" mark is changed to "-" after the expansion).

Watch-Expression	Contents When Expanded
Array	All elements in the array Select [Encoding] >> [ASCII] from the context menu to display the value as a string (up to 256 characters). Note, however, that any characters that cannot be displayed in the encoding will be shown as periods ".".
Pointer type variable	Variables that the pointer designates
Structure/Union	All the member of structure/union
Register	Name of the bit/bit string that constructs register Example) AX register A register X register

(c) Registering new watch-expression

There are three ways as follows to register new watch-expressions.

<1> Register from other panels

Do either one of the following to register watch-expressions in other panels.

- Drag and drop the target character string in this area in the desired watch panel (Watch1 to Watch4).
- Select [Register to Watch1] from the context menu after selecting the target character string or place the caret on either of the target character string (the target is automatically decided).
- Select the [Edit] menu >> [Paste] in this area in the desired watch panel (Watch1 to Watch4) after selecting the [Edit] menu >> [Copy] for the target character string.

The relationship between panels that can use this operation and targets that can be registered as watch-expressions is as follows:

Table A-4. Relationship between Panels and Targets That Can be Registered as Watch-Expressions

Panel Name	Targets That can be Registered as Watch-Expressions
Editor panel	Variable names of C language, CPU registers, SFR, and assembler symbols
Disassemble panel	Variable names of C language, CPU registers, SFR, and assembler symbols
CPU Register panel	CPU registers ^{Note}
Local Variables panel	Variable names of C language (local variables)
SFR panel	SFR ^{Note}

Note The scope-specification is automatically added to the registered watch-expression.

<2> **Directly register in the Watch panel**

Click the  button on the toolbar or select [Add New Watch] from the context menu in the desired watch panel (Watch1 to Watch4) to display an entry box for a new watch-expression in the bottom of this area.

Directly input a watch-expression from the keyboard in the [Watch] area in the entry box then press the [Enter] key.

The input format of the watch-expression is as follows:

Table A-5. Input Format of Watch-Expression

Watch-Expression	Value to Display
Variable name of C language	Value of C language variable
<i>Watch-expression</i> [<i>Watch-expression</i>]	Element of array
<i>Watch-expression</i> Member name	Member of structures/unions
<i>Watch-expression</i> -> Member name	Member of structures/unions that pointer designates
* <i>Watch-Expression</i>	Value of pointer variable
CPU register name	Value of the CPU register
SFR name	SFR value
Label, EQU symbol and immediate address	Values of label, EQU symbol and immediate address
Bit symbol	Bit symbol value

Watch-expressions can be registered with specifying the scope. The scope specifications with watch-expression registration are as follows:

Table A-6. Scope Specification of C language Used with Watch-Expression Registration

Scope Specification	Load Module File Name	Source File Name	Function Name	Variable Name
prog\$file#func#var	prog	file	func	var
prog\$file#var	prog	file	global	var
prog\$var	prog	global	global	var
file#func#var	current	file	func	var
file#var	current	file	global	var
var	current	current	current	var

Table A-7. Scope Specification of CPU Register with Watch-Expression Registration

Scope Specification	Register Bank	Name of CPU Register
AX:RB0	Register bank 0	AX
AX:REG	Current register bank	AX

Table A-8. Scope Specification of SFR with Watch-Expression Registration

Scope Specification	Name of SFR
P0:SFR	P0
P0	P0

- Remarks 1.** If the same name exists either in C language variables, CPU registers or SFR, and they are registered without specifying scopes, the symbol is resolved in the following order and the value is displayed.
- Variable of C language > CPU registers > SFR
- If "\$" is specified at the top of the watch-expression, the symbol is resolved in the following order and the value is displayed.
- CPU registers > SFR > Variable of C language
2. If the same name exists in the local variable and the global variable, and their symbol names are only registered without specifying scopes, the symbol is resolved and the value is displayed based on the scope of the current PC value.
 3. When watch-expressions are registered from the [SFR panel](#) or the [CPU Register panel](#), the scope specification is automatically added.
 4. When only "AX" is specified as a watch-expression, the value of the AX register in the current register bank is displayed.

<3> Register from other application

Select a character string of a variable of C language, CPU register, SFR or assembler symbol from an external editor then do either one of the following.

- Drag and drop the target character string in this area in the desired watch panel (Watch1 to Watch4).
- Select the [Edit] menu >> [Paste] in this area in the desired watch panel (Watch1 to Watch4) after copying the target character string.

Caution Up to 128 watch-expressions can be registered in one watch panel (if this restriction is violated, a message appears).

- Remarks 1.** Each watch-expression registered in each watch panel (Watch1 to Watch4) is managed in each panel and saved as the user information of the project.
2. More than one watch-expression with the same name can be registered.

(d) Editing watch-expression

To edit the registered watch-expression, double-click the watch-expression to be edited to change the watch-expression to edit mode then directly edit from the keyboard (press the [Esc] key to cancel the edit mode). After editing the watch-expression, press the [Enter] key to complete the editing.

(e) Deleting watch-expression

To delete the registered watch-expression, select the watch-expression(s) to be deleted then click the  button on the toolbar or select [Delete] from the context menu.

(f) Setting of various events

Various events can be set to the selected watch-expression by selecting [Access Break] or [Trace Output] from the context menu.

If an access event is set, the mark of the watch-expression is changed (the event mark of a break event is displayed under the icon of the watch-expression in layers).

When an event is set, the detailed information about the set event is reflected in the [Events panel](#).

Note that events are only set to the watch-expressions that are global variables, static variables inside functions, or file-internal static variables.

See the following for details on how to set events.

- "2.8.3 Stop the program with the access to variables/SFRs"
- "2.11.4 Collect execution history when the condition is met"

(g) Jump to the address with memory definition

By selecting [Jump to Memory] from the context menu, the [Memory panel](#) (Memory1) opens with moving the caret to the address in which the selected watch-expression is defined (if the Memory panel (Memory1) is already opened, jump to the panel).

Note that this operation is disabled when more than one watch-expression is selected at the same time or the CPU register/SFR is selected.

(2) [Value] area

The value of the registered watch-expression is displayed and changed (if the watch-expression is a function pointer, the function name is displayed in this area).

Notations and encodes can be selected by the button on the toolbar or the context menu item. In addition, a display format adding the value in hexadecimal number constantly can also be selected as well.

The default display format of the values is automatically decided depending on the type of the watch-expression.

Table A-9. Display Format of Watch-Expressions (Default)

Type of Watch-Expression	Display Format
char, signed char, unsigned char	ASCII code with hexadecimal number
short, signed short, short int, signed short int, int, signed, signed int, long, signed long, long int, signed long int	Signed decimal number with hexadecimal number
unsigned short, unsigned short int, unsigned, unsigned int, unsigned long, unsigned long int	Unsigned decimal number with hexadecimal number
float	Float (when the size is 4-byte) with hexadecimal number
double, long double	Double (when the size is 8-byte) with hexadecimal number
Pointers to char, signed char, unsigned char	Characters Encoding: ASCII
Pointers to other than char, signed char, unsigned char	Hexadecimal number
Arrays of char, signed char, unsigned char types	Characters Encoding: ASCII
bit, boolean, _boolean	Unsigned decimal number with hexadecimal number
Enumeration type	Enumeration constant value with hexadecimal number
Label, address of immediate value, EQU symbol	Signed decimal number with hexadecimal number
bit symbol	Unsigned decimal number with hexadecimal number
Others	Hexadecimal number

The meanings of the marks and colors displayed as the values of watch-expressions are as follows (character colors and background colors depend on the configuration in the [\[General - Font and Color\]](#) category of the [Option dialog box](#)):

Display Example (Default)			Description
0x0	Character color	Blue	The value of the watch-expression that the user is changing Press the [Enter] key to write to the target memory.
	Background color	Standard color	
0x0	Character color	Pink	The value of the watch-expression that is displayed with the Real-time display update function
	Background color	Standard color	
0x0	Character color	Brown	The value of the watch-expression that has been changed because of the execution of a program To reset the highlighting, select the  button on the toolbar or [Reset Color] from the context menu.
	Background color	Cream	
?	Character color	Gray	Variable that does not exist is registered as a watch-expression or the value of the watch-expression cannot be retrieved (variable is out of the scope)
	Background color	Standard color	

- Remarks 1.** The SFR that cause the microcontroller to operate when it is read is read-protected and therefore cannot be read. To read the value of read-protected SFR, select [Force Read Value] from the context menu.
- Each watch-expression acquires the value in the order it was registered.
As the timing to acquire a value is different, the values displayed may be different if the same SFR is registered more than once.
 - When a hexadecimal value is also given, then values in the specified notation and hexadecimal values are read separately. For this reason, the values with the specified notation and the hexadecimal values may differ due to the time lag between being read.

This area is provided with the following functions.

(a) Real-time display update function

Using the real-time display update function enables to display/modify the value of the watch-expression not only while the program is stopped, but also in execution.

See "(4) [Display/modify the memory contents during program execution](#)" for details on the real-time display update function.

(b) Changing values of watch-expressions

To edit the value of the watch-expression, change the value directly from the keyboard after double-clicking on the value to be edited (press the [Esc] key to cancel the edit mode).

After you edit the value of the watch-expression, it is written to the target memory of the debug tool by pressing the [Enter] key, or moving the focus to outside the edit region.

See "(6) [Modify the contents of watch-expressions](#)" for detail on how to change values of watch-expressions.

(c) Saving the contents of watch-expressions

By selecting the [File] menu >> [Save Watch Data As...], the [Save As dialog box](#) can be opened, and all the contents of this panel can be saved in a text file (*.txt) or CSV file (*.csv).

See "(8) [Save the contents of watch-expressions](#)" for details on the method for saving the contents of watch-expressions.

(3) [Type (Byte Size)] area

The type information of watch-expressions with the following format is displayed.

Watch-Expression	Display Format	
Single CPU register	<Types of CPU register> (<Size ^{Note 1} >)	
Single SFR	<SFR type> (<Access attribute> <Access type><Size ^{Note 1} >)	
	Access attribute	R: Read only W: Write only R/W: Read/Write only
	Access type	1: Bit accessible 8: Byte accessible 16: Word accessible
Unknown	?	
Others	<Watch-expression type that follow the C compiler's determination ^{Note 2} > (<Size ^{Note 1} >)	

Notes 1. The size of the watch-expression is displayed in bytes.

However, for bit SFR or C language bit field, the size is displayed in bits and "bits" is added to the end of the number.

2. Types to be treated are displayed when compiling the watch-expression.

(4) [Address] area

The address that each watch-expression is mapped is displayed (hexadecimal number notation fixing).

If the watch-expression is single CPU register or is unknown, "-" or "?" is displayed instead.

Remark When the watch-expression is the bit SFR, the bit-offset value is also displayed.

Example When the bit register is allocated to bit 4 of the address "0xFF40"

Display example:0xFF40.4

(5) [Memo] area

The user can write comments for the watch-expressions/categories.

Each comment for a watch-expression/category written in this area is saved individually as the user information of the project. Therefore, when any of the watch-expression/category is deleted, the comment corresponding to it is also deleted.















Note that when arrays or register are displayed expanded, the comment cannot be input for each element.

To edit the comment, input the character strings directly from the keyboard after double-clicking on the item to be edited (press the [Esc] key to cancel the edit mode).

Up to 256 character strings can be input (line feed code is ignored).

After editing the character strings, complete the editing by pressing the [Enter] key or moving the focus to outside the edit region.

[Toolbar]

	Reacquires all the values of the registered watch-expression and updates the display. Note that read-protected SFR values are not re-read. This item becomes invalid during execution of a program.
	Resets highlighting of the selected watch-expression whose value has been changed by executing a program. This item becomes invalid during execution of a program.
	Registers a new watch-expression. Directly input the watch-expression in the text box (see "(c) Registering new watch-expression") Note that up to 128 watch-expressions can be registered in one watch panel.
	Adds a new category (folder). Directly input the category name in the text box. Note that up to 64 categories can be created in one watch panel (categories cannot be created in categories).
	Deletes the selected character string(s). If the watch-expression(s)/category(s) are selected, deletes them (except when the expanded item of the watch-expression is selected).
Notation	The following buttons to change the notation of a data value are displayed.
	Displays the value of the selected watch-expression in the default notation (see "Table A-9. Display Format of Watch-Expressions (Default)") according the type of variable (default).
	Displays the value of the selected item in hexadecimal number.
	Displays the value of the selected item in signed decimal number.
	Displays the value of the selected item in unsigned decimal number.
	Displays the value of the selected item in octal number.
	Displays the value of the selected item in binary number.
	Displays the value of the selected item in ASCII code.
	Displays the value of the selected item in Float. Note that this item becomes valid only when the selected watch-expression value is 4-byte data.
	Displays the value of the selected item in Double. Note that this item becomes valid only when the selected watch-expression value is 8-byte data.
	Adds the value in hexadecimal number enclosing with "("" at the end of the value of the selected item (except the item displayed in hexadecimal number).

[[File] menu (Watch panel-dedicated items)]

The following items are exclusive for the [File] menu in the Watch panel (other items are common to all the panels).
Note that all these items are invalid during execution of a program.

Save Watch Data	Overwrites the contents of this panel to the previously saved text file (*.txt)/CSV file (*.csv) (see "(c) Saving the contents of watch-expressions"). Note that when the file has never been saved or the file is write disabled, the same operation is applied as the selection in [Save Watch Data As...].
Save Watch Data As...	Opens the Save As dialog box to newly save the contents of this panel to the specified text file (*.txt)/CSV file (*.csv) (see "(c) Saving the contents of watch-expressions").

[[Edit] menu (Watch panel-dedicated items)]

The following items are exclusive for [Edit] menu in the Watch panel (other items are all invalid).

Cut	Deletes the selected character string(s) and copies them to the clipboard. If the watch-expression(s)/category(s) are selected, deletes them (except when the expanded item of the watch-expression is selected).
Copy	Copies the contents of the selected range to the clipboard as character string(s). If the watch-expression(s)/category(s) are selected, copies them to the clipboard (except when the expanded item of the watch-expression is selected).
Paste	If texts are in editing, pastes the contents of the clipboard to the caret position. If texts are not in editing and the watch-expression(s) are copied in the clipboard, registers them to the caret position.
Delete	Deletes the selected character string(s). If the watch-expression(s)/category(s) are selected, deletes them (except when the expanded item of the watch-expression is selected).
Select All	If texts are in editing, selects all the character strings. If texts are not in editing, selects all the watch-expressions/categories.
Rename	Renames the selected watch-expression/category.
Find...	Opens the Search and Replace dialog box with selecting the [Whole Search] tab.
Replace...	Opens the Search and Replace dialog box with selecting the [Whole Replace] tab.

[Context menu]

Access Break	This item becomes valid only when the selected watch-expression is the global variable, the static variable inside functions, the file-internal static variable, or SFR. The following cascade menus are displayed to set the access break event (see "(1) Set a break event to a variable/SFR ").
Set Read Break to	Sets a break event with read access condition to the selected watch-expression.
Set Write Break to	Sets a break event with write access condition to the selected watch-expression.
Set R/W Break to	Sets a break event with read/write access condition to the selected watch-expression.
Trace Output [IECUBE][Simulator]	This item becomes valid only when the selected watch-expression is the global variable, the static variable inside functions, the file-internal static variable, or SFR. The following cascade menus are displayed to set the trace-related event (see "(1) When an access to variables/SFRs occurs "). The corresponding Event mark is displayed at the top of the watch-expression when an event is set.
Record Reading Value	Sets a Point Trace event to record the values in the trace memory when the selected watch-expression is accessed for read.
Record Writing Value	Sets a Point Trace event to record the values in the trace memory when the selected watch-expression is accessed for write.
Record R/W Value	Sets a Point Trace event to record the values in the trace memory when the selected watch-expression is accessed for read/write.
Trace	Opens the Trace panel [IECUBE][Simulator] and displays the acquired trace data.

Periodic Updating	The following cascade menus are displayed to set for the real-time display update function (see " (a) Real-time display update function "). This item becomes invalid during execution of a program.
Periodic Updating Options	Opens the Property panel to set for the real-time display update function.
Refresh	Reacquires all the values of the registered watch-expression and updates the display. Note that the values of read-protected SFR are not re-read. This item becomes invalid during execution of a program.
Force Read Value	Forcibly reads once the values of the read-protected SFR. This item becomes invalid during execution of a program.
Add New Watch	Registers a new watch-expression. Directly input the watch-expression in the text box (see " (c) Registering new watch-expression ") Note that up to 128 watch-expressions can be registered in one watch panel.
Create Category	Adds a new category (folder). Directly input the category name in the text box. Note that up to 64 categories can be created in one watch panel (categories cannot be created in categories).
Delete	Deletes the selected character string(s). If the watch-expression(s)/category(s) are selected, deletes them (except when the expanded item of the watch-expression is selected).
Cut	Deletes the selected character string(s) and copies them to the clipboard. If the watch-expression(s)/category(s) are selected, deletes them (except when the expanded item of the watch-expression is selected).
Copy	Copies the contents of the selected range to the clipboard as character string(s). If the watch-expression(s)/category(s) are selected, copies them to the clipboard (except when the expanded item of the watch-expression is selected).
Paste	If texts are in editing, pastes the contents of the clipboard to the caret position. If texts are not in editing and the watch-expression(s) are copied in the clipboard, registers them to the caret position.

Notation	The following cascade menus are displayed to specify the notation.
AutoSelect	Displays the value of the selected watch-expression in the default notation (see " Table A-9. Display Format of Watch-Expressions (Default) ") according the type of variable (default).
Hexadecimal number	Displays the value of the selected item in hexadecimal number.
Signed Decimal	Displays the value of the selected item in signed decimal number.
Unsigned decimal number	Displays the value of the selected item in unsigned decimal number.
Octal	Displays the value of the selected item in octal number.
Binary	Displays the value of the selected item in binary number.
ASCII	Displays the value of the selected item in ASCII code.
Include Hexadecimal Value	Adds the value in hexadecimal number enclosing with "(")" at the end of the value of the selected item (except the item displayed in hexadecimal number).
Float	Displays the value of the selected item in Float. Note that when the selected watch-expression value is not 4-byte data, or has the type information, displays it in the default notation (see " Table A-9. Display Format of Watch-Expressions (Default) ").
Double	Displays the value of the selected item in Double. Note that when the selected watch-expression value is not 8-byte data, or has the type information, displays it in the default notation (see " Table A-9. Display Format of Watch-Expressions (Default) ").
Decimal Notation for Array Index	Displays array indexes on this panel in decimal number (default).
Hexadecimal Notation for Array Index	Displays array indexes on this panel in hexadecimal number.
Encoding	The following cascade menus are displayed to specify the character code.
ASCII	Displays the value of the selected item in ASCII code (default).
Shift_JIS	Displays the value of the selected item in Shift_JIS code.
EUC-JP	Displays the value of the selected item in EUC-JP code.
UTF-8	Displays the value of the selected item in UTF-8 code.
Size Notation	The following cascade menus are displayed to specify the size notation.
1 Bytes	Displays the value of the selected item as 8-bit data.
2 Bytes	Displays the value of the selected item as 16-bit data.
4 Bytes	Displays the value of the selected item as 32-bit data.
Jump to Memory	Opens the Memory panel (Memory1) and jumps to the address which the selected watch-expression is defined (see " (g) Jump to the address with memory definition ").
Reset Color	Resets highlighting of the selected watch-expression whose value has been changed by executing a program. This item becomes invalid during execution of a program.

Call Stack panel

This panel is used to display the call stack information for the function call (see "2.10.1 Display call stack information"). This panel appears only when connected to the debug tool.

Caution Nothing is displayed on this panel during execution of a program.
When the execution of a program is stopped, items in each area are displayed.

Remark When the separator line of each area in this panel is double-clicked, the width of the area changes to the shortest possible size that can display the contents of the area.

Figure A-26. Call Stack Panel

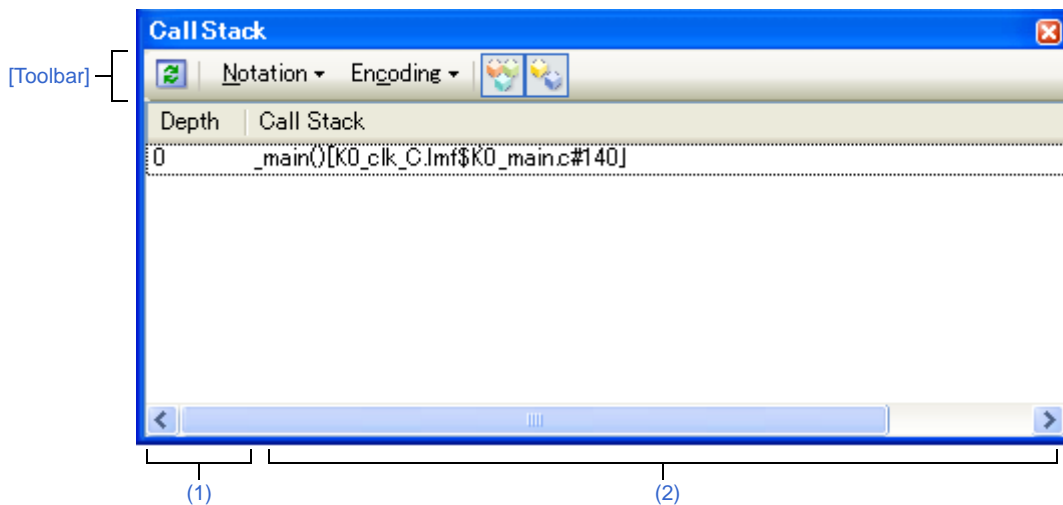

This section describes the following.

- [How to open]
- [Description of each area]
- [Toolbar]
- [[File] menu (Call Stack panel-dedicated items)]
- [[Edit] menu (Call Stack panel-dedicated items)]
- [Context menu]

[How to open]

- From the [View] menu, select [Call Stack].

[Description of each area]

(1) [Depth] area

The depth of the call is displayed.

The line at the current PC position becomes 0 and incremented numbers from 1 is added to the calling function in the order.

(2) [Call Stack] area

The current source position and the call stack information pushed on the stack (position of the calling function and arguments of a each function, etc.) are displayed.

The display format in this area differs depending on the selection condition of the  button on the toolbar, or of [Show Parameter]/[Show Module File Name] from the context menu.

Condition	Display Format
- Display arguments - Display module file name	<Function>(<Argument>=<Argument Value ^{Note} >, ...)[<Module file name>\$<File name>#<Line number>] (default)
- Display arguments - Do not display module file name	<Function>(<Argument>=<Argument value ^{Note} >, ...)[<File Name>#<Line number>]
- Do not display arguments - Display module file name	<Function>()[<Module file name>\$<File name>#<Line number>]
- Do not display arguments - Do not display module file name	<Function>()[<File name>#<Line number>]

Note When the argument value is character string, up to 20 characters can be displayed.

Remark Array arguments are passed as pointers rather than arrays (C language specification). For this reason, if the argument is an array, it is displayed as a pointer.

This area is provided with the following functions.

(a) Jump to source line and disassemble

By selecting [Jump to Source] from the context menu, the [Editor panel](#) is opened with moving the caret to the source line corresponding to the calling function at the current caret position (if the Editor panel is already opened, jump to the panel).

In addition, similarly by selecting [Jump to Disassemble], the [Disassemble panel](#) (Disassemble1) is opened with moving the caret to the address corresponding to the calling function at the current caret position (if the Disassemble panel is already opened, jump to the panel (Disassemble1)).

Remark It is possible to jump to the target source line by double-clicking on that line as well.













(b) Saving the contents of call stack information

By selecting the [File] menu >> [Save Call Stack Data As...], the [Save As dialog box](#) can be opened, and all the contents of this panel can be saved in a text file (*.txt) or CSV file (*.csv).

See "(4) [Save the contents of call stack information](#)" for details on the method for saving the contents of call stack information.

[Toolbar]

The buttons below become invalid during execution of a program.

	Acquires the latest data from the debug tool, and updates the contents of this panel.
Notation	The following buttons to specify the notation of values are displayed.
	Displays values on this panel in the default notation according to the type of variable (default).
	Displays values on this panel in hexadecimal number.
	Displays values on this panel in decimal number.
	Displays values on this panel in octal number.
	Displays values on this panel in binary number.
Encoding	The following buttons to specify the encoding of character variables are displayed.
	Displays character variables in ASCII code (default).
	Displays character variables in Shift_JIS code.
	Displays character variables in EUC-JP code.
	Displays character variables in UTF-8 code.
	Displays the call stack information with the module file name (default).
	Displays the call stack information with the parameters (arguments) of the function call (default).

[[File] menu (Call Stack panel-dedicated items)]

The following items are exclusive for the [File] menu in the Call Stack panel (other items are common to all the panels). Note that all these items are invalid during execution of a program.

Save Call Stack Data	Overwrites the contents of this panel to the previously saved text file (*.txt)/CSV file (*.csv) (see "(b) Saving the contents of call stack information"). Note that when the file has never been saved or the file is write disabled, the same operation is applied as the selection in [Save Call Stack Data As...].
Save Call Stack Data As...	Opens the Save As dialog box to newly save the contents of this panel to the specified text file (*.txt)/CSV file (*.csv) (see "(b) Saving the contents of call stack information").

[[Edit] menu (Call Stack panel-dedicated items)]

The following items are exclusive for [Edit] menu in the Call Stack panel (other items are all invalid).

Copy	Copies the contents of the selected line to the clipboard.
Select All	Selects all the items of this panel.
Find...	Opens the Search and Replace dialog box with selecting the [Whole Search] tab.
Replace...	Opens the Search and Replace dialog box with selecting the [Whole Replace] tab.

[Context menu]

All the items from the context menu become invalid during execution of a program.

Copy	Copies the contents of the selected line to the clipboard.
Show Module File Name	Displays the call stack information with the module file name (default).
Show Parameter	Displays the call stack information with the parameters (arguments) of the function call (default).
Notation	The following cascade menus to specify the notation of values are displayed.
AutoSelect	Displays values on this panel in the default notation according to the type of variable (default).
Hexadecimal	Displays values on this panel in hexadecimal number.
Decimal	Displays values on this panel in decimal number.
Octal	Displays values on this panel in octal number.
Binary	Displays values on this panel in binary number.
Encoding	The following cascade menus to specify the encoding of character variables are displayed.
ASCII	Displays character variables in ASCII code (default).
Shift_JIS	Displays character variables in Shift_JIS code.
EUC-JP	Displays character variables in EUC-JP code.
UTF-8	Displays character variables in UTF-8 code.
Jump to Disassemble	Opens the Disassemble panel (Disassemble1) and jumps to the address corresponding to the calling function of the selected line in this panel.
Jump to Source	Opens the Editor panel and jumps to the source line corresponding to the calling function of the selected line in this panel.
Jump to Local Variable at This Time	Opens the Local Variables panel to display the local variable corresponding to the selected line.

Trace panel [IECUBE][Simulator]

This panel is used to display trace data recording the execution history of the program (see "2.11 Collect Execution History of Programs [IECUBE][Simulator]").

The trace data displays by mixing the disassembled text and source text by default, but it is also possible to display either one of these by selecting the [Display mode](#).

After the execution of the program is stopped, the display position is automatically updated such that the latest trace data is displayed.

This panel appears only when connected to the debug tool.

Remark When the separator line of each area in this panel is double-clicked, the width of the area changes to the shortest possible size that can display the contents of the area.

Figure A-27. Trace Panel

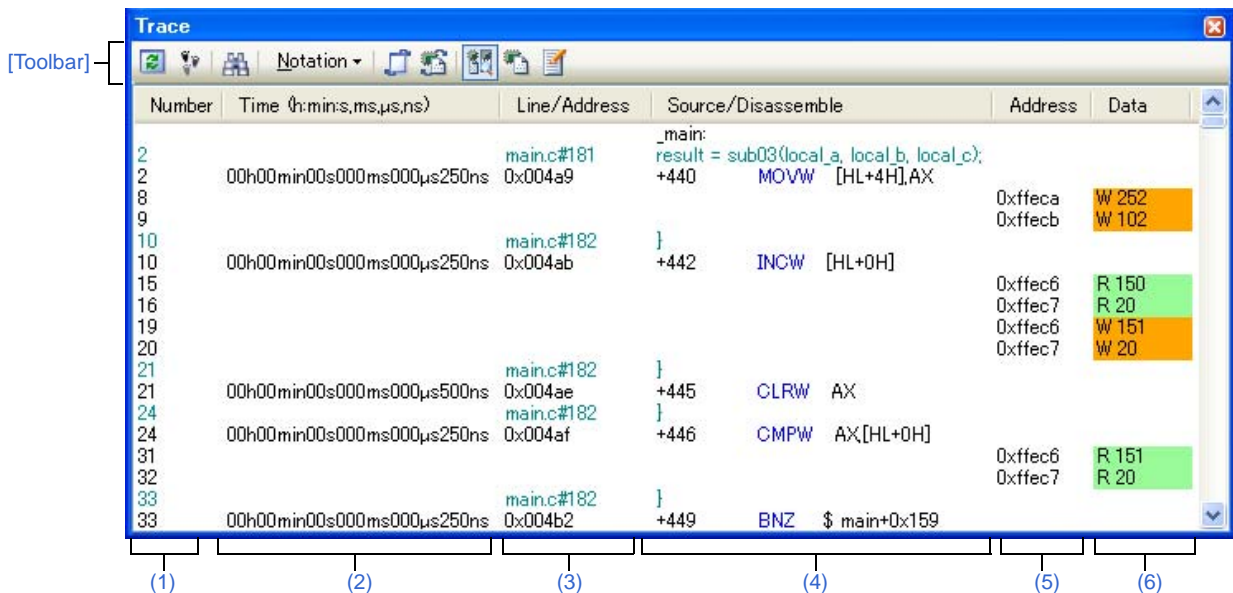

This section describes the following.

- [How to open]
- [Description of each area]
- [Toolbar]
- [[File] menu (Trace panel-dedicated items)]
- [[Edit] menu (Trace panel-dedicated items)]
- [Context menu]

[How to open]

- From the [View] menu, select [Trace].
- On the [Editor panel/Disassemble panel](#), select [Trace Settings] >> [Show Trace Result] from the context menu.

[Description of each area]

(1) [Number] area

The trace number showing the position is displayed.

(2) [Time (h:min:s,ms,µs,ns)] area

This area displays the time required from the execution start of the program to the execution start of an instruction of each frame or generation of memory access cause.

The time is displayed in units of "hours, minutes, seconds, milliseconds, microseconds and nanoseconds".

If overflow occurs, this area is displayed in invalid color (gray)

Remark [Simulator]

The question of whether to set the time display as an integrated value or differential value depends on the setting of the [Accumulate trace time] property on the [Trace] category in the [Debug Tool Settings] tab of the Property panel.

(3) [Line/Address] area

The address of the assemble code or the line number of a source file is displayed.

The notation of a data value can be selected by the button on the toolbar or the context menu item.

The display formats are as follows:

Type of Display Line	Display Format
Instruction (disassemble results)	<Address>
Source text	<File name>#<Line number>
Label	-
Point trace results	-
Break cause	-

Remark Since the following execution histories are not displayed, the line numbers displayed are not consecutive numbers.

- CPU register access
- Operand access
- Invalid fetch

(4) [Source/Disassemble] area

The collected trace data is displayed as follows.

The items displayed in this area differ depending on the selection of the display mode (see "(a) Display mode").

Figure A-28. Display Contents of the [Source/Disassemble] Area (Default)

Label	The label is displayed when a label is defined for the address.
Offset value	The offset value from the nearest label is displayed when a label is defined for the address.
Instruction (disassemble results)	The corresponding instructions are displayed as the result of disassembling when the Mixed display mode or Disassemble display mode is selected ^{Note 1} . The mnemonics are shown highlighted.

Source text	<p>The corresponding source text is displayed when the Mixed display mode or Source display mode is selected.</p> <p>In addition, when the value of a variable^{Note 2} or an SFR that is accessed during execution of a source line can be analyzed, that value is displayed in the following format at the end of the source line.</p> <ul style="list-style-type: none"> - <<<Variable name = Variable value>>> - <<<SFR name = SFR value>>> <p>Example: a=b; <<<a=5>>></p> <p>The results of the Point Trace are displayed as same as format above.</p> <p>However, when a place where no debugging information is present is executed, "<No Debug Information>" is displayed.</p>
Break cause	The reason why the program has broken down is displayed.

- Notes 1.** At a frame for which not all the trace data was fetched, "(LOST)" is displayed. In this case, the corresponding line is shown in error color (the error color depends on the configuration in the [\[General - Font and Color\] category](#) of the [Option dialog box](#)).
- 2.** When there is a memory access, a symbol will be interpreted as a variable and displayed only if a symbol is assigned to the accessed address. Note, however, that only variables of up to 2 bytes are supported. If multiplication or other code is processed by the standard libraries, the label of the SADDR area used by the standard library may be shown.

This area is provided with the following functions.

(a) Display mode

It is possible to select the following three display modes by selection of a button on the toolbar or the context menu.

Display Mode	Display Contents
Mixed display mode	Displays the instruction (disassemble results), labels, source text (corresponding source line), point trace results, and break causes (default).
Disassemble display mode	Displays the instruction (disassemble results), labels, point trace results, and break causes.
Source display mode	Displays the source text (corresponding source line) and break causes. However, when a place where no debugging information is present is executed, "<No Debug Information>" is displayed.

(b) Jumping to source line or disassemble

By selecting [\[Jump to Source\]](#) from the context menu, the [Editor panel](#) opens with moving the caret to the source line corresponding to the line at the current caret position (if the Editor panel is already opened, jump to the panel).

In addition, similarly by selecting [\[Jump to Disassemble\]](#), the [Disassemble panel](#) (Disassemble1) is opened with moving the caret to the address corresponding to the fetch address of the line at the current caret position (if the Disassemble panel is already opened, jump to the panel (Disassemble1)).

(c) Linking with other panels

By clicking the  button on the toolbar, or selecting [\[Window Connecting\] >> \[Connect Source Window\]/\[Connect Disassemble Window\]](#) from the context menu, it is possible to link and display the corresponding places on the [Editor panel/Disassemble panel](#), with the address of the caret position on this panel used as the pointer (no movement of the focus is done).

(d) Pop-up display

By superimposing the mouse cursor on a line, all the area (item) data corresponding to that line is displayed as a pop-up in tandem shape.

(e) Saving trace data

The [Data Save dialog box](#) can be opened by selecting the [File] menu >> [Save Trace Data As...], and the contents of this panel can be saved in a text file (*.txt) or CSV file (*.csv).

See "[2.11.8 Save the contents of execution history](#)" for details on the method for saving trace data.

(5) [Address] area

The target address of memory access is displayed.

However, in the event of access to SFR, the SFR name is displayed instead of the address (when a plurality is accessed these are displayed in the following lines).

The radix of a data value can be selected by the button on the toolbar or the context menu item.

(6) [Data] area

The accessed data value and the access type at that time are displayed.

However, CPU register access is not displayed.





The notation of a data value can be selected by the button on the toolbar or the context menu item.

The display format of the data value and the access type are as follows (character colors and background colors depend on the configuration in the [\[General - Font and Color\]](#) category of the [Option dialog box](#)):

Display Example (Default)			Memory Access Type
	Character color	Standard color	Read access
	Background color	Palegreen	
	Character color	Standard color	Write access
	Background color	Orange	
	Character color	Standard color	Read and write access
	Background color	Paleturquoise	
	Character color	Standard color	Vector read access
	Background color	Palegreen	

[Toolbar]

	Acquires the latest data from the debug tool, and updates the contents of this panel. This item becomes invalid during execution of a program.
	Clears the trace memory and the display of this panel (initialized). This item becomes invalid during execution of a program.
	Opens the Trace Search dialog box [IECUBE][Simulator] .
Notation	The following buttons to change the notation of a data value are displayed. This item becomes invalid during execution of a program.
	Displays values on this panel in hexadecimal number (default).
	Displays values on this panel in decimal number.
	Displays values on this panel in octal number.
	Displays values on this panel in binary number.

	Links with the Editor panel .
	Links with the Disassemble panel .
	Sets to the Mixed display mode as the display mode (default). This item becomes invalid during execution of a program.
	Sets to the Disassemble display mode as the display mode. This item becomes invalid during execution of a program.
	Sets to the Source display mode as the display mode. This item becomes invalid during execution of a program.

[[File] menu (Trace panel-dedicated items)]

The following items are exclusive for the [File] menu in the Trace panel (other items are common to all the panels). Note that all these items are invalid during execution of a program.

Save Trace Data	Overwrites the contents of this panel to the previously saved text file (*.txt)/CSV file (*.csv) (see "(e) Saving trace data "). Note that when the file has never been saved or the file is write disabled, the same operation is applied as the selection in [Save Trace Data As...].
Save Trace Data As...	Opens the Data Save dialog box to newly save the contents of this panel to the specified text file (*.txt)/CSV file (*.csv) (see "(e) Saving trace data ").

[[Edit] menu (Trace panel-dedicated items)]

The following items are exclusive for [Edit] menu in the Trace panel (other items are all invalid). Note that all these items are invalid during execution of a program.

Copy	Copies the contents of the selected line to the clipboard (multiple line selections impossible).
Find...	Opens the Trace Search dialog box [IECUBE][Simulator].

[Context menu]

Clear Trace	Clears the trace memory and the display of this panel (initialized). This item becomes invalid during execution of a program.
Find...	Opens the Trace Search dialog box [IECUBE][Simulator]. This item becomes invalid during execution of a program.
Copy	Copies the contents of the selected line to the clipboard (multiple line selections impossible). This item becomes invalid during execution of a program.
Mixed Display	Sets to the Mixed display mode as the display mode. This item becomes invalid during execution of a program.
Disassemble View	Sets to the Disassemble display mode as the display mode. This item becomes invalid during execution of a program.
Source View	Sets to the Source display mode as the display mode. This item becomes invalid during execution of a program.

Notation	The following cascade menus are displayed to specify the notation. This item becomes invalid during execution of a program.
Hexadecimal number	Displays values on this panel in hexadecimal number (default).
Decimal	Displays values on this panel in decimal number.
Octal	Displays values on this panel in octal number.
Binary	Displays values on this panel in binary number.
Window Connecting	The following cascade menus are displayed to link with other panels (see "(c) Linking with other panels ").
Connect Source Window	Links with the Editor panel .
Connect Disassemble Window	Links with the Disassemble panel .
Jump to Disassemble	Opens the Disassemble panel (Disassemble1) and jumps to the fetch address corresponding to the selected line in this panel.
Jump to Source	Opens the Editor panel and jumps to the source line corresponding to the selected line in this panel.

Events panel

This panel is used to display the detailed information about the events that are set on the [Editor panel/Disassemble panel/Watch panel](#). On this panel, you can change the setting state of the event between valid/invalid and delete the event (see "2.15 Manage Events").

This panel appears only when connected to the debug tool.

- Remarks 1.** See "2.15.6 Notes for setting events" for more information about the setting of events.
- 2.** When the separator line of each area in this panel is double-clicked, the width of the area changes to the shortest possible size that can display the contents of the area.

Figure A-29. Events Panel

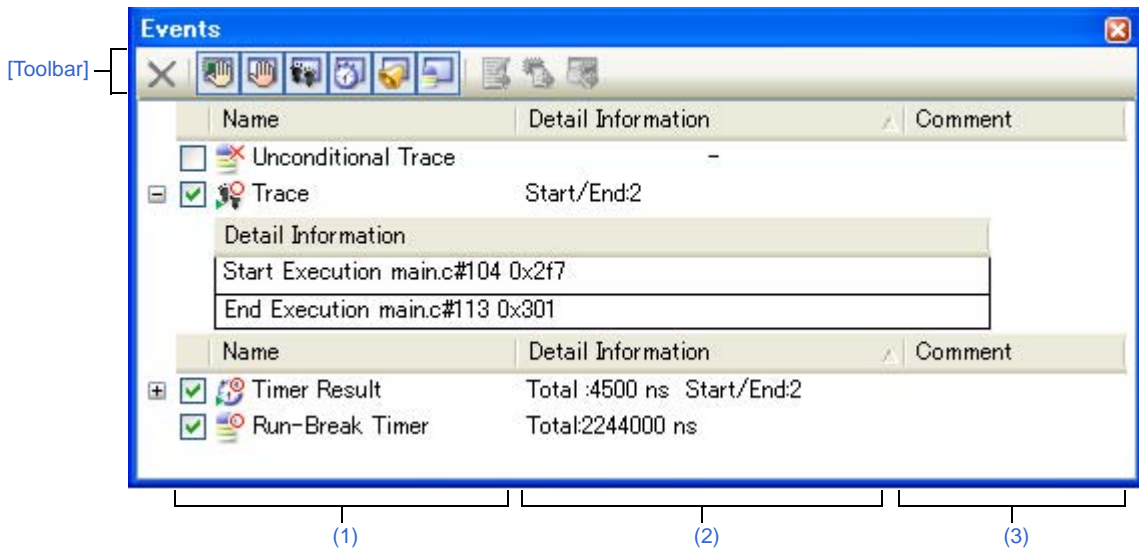

This section describes the following.

- [\[How to open\]](#)
- [\[Description of each area\]](#)
- [\[Toolbar\]](#)
- [\[\[Edit\] menu \(Events panel-dedicated items\)\]](#)
- [\[Context menu\]](#)

[How to open]

- From the [View] menu, select [Event].
- **[IECUBE][Simulator]**
On the [Editor panel/Disassemble panel](#), select [Timer Settings] >> [View Result of Timer] from the context menu.

[Description of each area]

(1) [Name] area

A list of the event names that have currently been set is displayed in the following format.

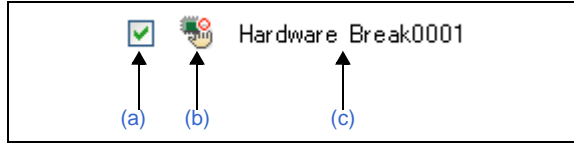

Remark It is possible to limit the event to be displayed by clicking the button on the toolbar (see "[Toolbar]").

(a) Check box

The setting state of the event is displayed/changed.

Note that the **Event mark** is changed depending on the setting state of the event.

<input checked="" type="checkbox"/>	Valid state	Event occurs when the specified condition is met. It is possible to set the event to an invalid state by removing the check.
<input type="checkbox"/>	Invalid state	Event does not occur when the specified condition is met. It is possible to set the event to a valid state by removing the check.
<input type="checkbox"/>	Suspended state	The conditions that have been specified cannot be set with the program of the debugging target. It is not possible to operate the check box.

- Remarks 1.** Both of the Timer Start event and Timer Stop event is must be set for the Timer Result event. Therefore, it is not possible to set a particular event to a valid state by only the setting of one of these (at the same time as both events are set, they are treated as grouped events as a Timer Result).
2. It is not possible to set the Run-Break Timer event to an invalid/suspended state.
 3. The setting of the Unconditional Trace event and the Trace event to valid or invalid state is exclusively controlled. Therefore, the Unconditional Trace event, which is a built-in event, is valid state by default, but if either a Start Tracing event/Stop Tracing event is set, it automatically becomes invalid state, and the Trace event, which is a event name that is collectively called with a Start Tracing event and a Stop Tracing event, becomes valid state. Conversely, if the set Trace event is invalid state, the Unconditional Trace event automatically becomes valid state.

(b) Event mark

The event mark shows the type of event, and in addition shows the current setting state.

The meanings of the marks displayed are as follows:

Table A-10. Event Mark

Event Type	Valid State	Invalid State	Suspended State	Note
Hardware Break				-
Software Break [IECUBE] [MINICUBE2]				-
Unconditional Trace [IECUBE] [Simulator]			None	-
Run-Break Timer		None	None	-
Trace [IECUBE] [Simulator]				Used only in the Events panel
Start Tracing				Used only in the Editor panel / Disassemble panel
Stop Tracing				
Timer Result [IECUBE] [Simulator]				Used only in the Events panel
Start Timer				Used only in the Editor panel / Disassemble panel
Stop Timer				
Point Trace [IECUBE] [Simulator]				-
Printf (Action event)				-
Setting of two or more events	Note 1	Note 2	Note 3	Used only in the Editor panel / Disassemble panel

- Notes**
1. There is one or more event with valid state.
 2. There is no event with valid state and at least one event with invalid state.
 3. All the set events are suspended state

(c) Event name

The event type and ID number are displayed as the event name.

A number from 0001 is automatically provided as the ID number for each event (no renumbering of the ID number is done even in the event that an event that has been set once is deleted).

Event types that are displayed are as follows:

Table A-11. Event Type

Event Type	Description
Hardware Break (Break ^{Note 1})	Breaks the program when the condition is met while the debug tool monitors the break condition all the time during program execution. -> See " 2.8.2 Stop the program at the arbitrary position (breakpoint) " -> See " 2.8.3 Stop the program with the access to variables/SFRs "
Software Break (Break ^{Note 1}) [IECUBE] [MINICUBE2]	Breaks the program when the instruction, which an address code to break is rewritten for the break instruction, is executed. -> See " 2.8.2 Stop the program at the arbitrary position (breakpoint) "
Unconditional Trace	Automatically collects the trace data with start of a program execution, and stops collecting the trace data with stop of the program execution. This event cannot be deleted because of the built-in event ^{Note 2} (this event is set to a Valid state by default). -> See " 2.11.2 Collect execution history until stop of the execution "
Run-Break Timer	Automatically measures the execution time of a program with start of the program execution, and stops the measurement with stop of the program execution. This event cannot be deleted because of the built-in event ^{Note 2} (this event is set to a Valid state by default). -> See " 2.12.1 Measure execution time until stop of the execution "
Trace [IECUBE] [Simulator]	Starts/stops collecting the trace data when the condition specified with "Start Tracing" and "Stop Tracing" is met (this event is displayed when a Start Tracing event or a Stop Tracing event is set). -> See " 2.11.3 Collect execution history in the arbitrary section "
Timer Result [IECUBE] [Simulator]	Starts/stops measuring the execution time of a program when the condition specified with "Start Timer" and "Stop Timer" is met (this event is displayed when a Start Timer event or a Stop Timer event is set). -> See " 2.12.2 Measure execution time in the arbitrary section [IECUBE][Simulator] "
Point Trace [IECUBE] [Simulator]	Records the information as the trace data when accessing the specified variable or SFR during the execution of a program. -> See " 2.11.4 Collect execution history when the condition is met "
Printf	Executes printf command in software processing after temporary stopping a program in execution at an arbitrary position (action event). -> See " 2.14.1 Inset printf "

Notes 1. A breakpoint that is set by a one click operation of the mouse is displayed "Break" (see "[\(2\) Set a breakpoint](#)").

2. This is set in the debug tool by default.

Remark The following event types are also displayed when an event (breakpoint or break event) is set via the Function panel/Variable panel of the analyze tool (Program Analyzer)

- In the case of a breakpoint at a function: "Break at start of function"

- In the case of a break event to a variable: "Access break to variable"

(2) [Detail Information] area

Detailed information about each event is displayed.

The contents of the information that is displayed differ depending on the event type as follows:

Table A-12. Detailed Information with Event Type

Event Type	Display Contents ^{Note 1}	
Hardware Break (Condition: execution)	Format1	<Condition to occur> <File name#Line number> <Address>
	Example	Before Execution main.c#39 0x100
		After Execution sub.c#100 0x200
		Before Execution - 0x300
		Execution main.c#39 0x300 [Simulator]
	Format2	<Condition to occur> <Symbol + Offset> <Address>
	Example	Before Execution funcA + 0x10 0x100
		After Execution funcB + 0x20 0x200
		Before Execution - 0x300
	Hardware Break (Condition: access)	Format1
Example		Read main.c#variable1 0x100 - 0x101 == 0x5
		Write sub.c#variable2 0x200 - 0x200 == 0x7
		Read/Write sub2.c#variable3 0x300 - 0x303 == 0x8
Format2		<Condition to occur> <File name#Function name# Variable name> <Address(range)> <Comparison condition> <Comparison value>
Example		Read main.c#func1#variable1 0x100 - 0x101 == 0x10
Format3		<Condition to occur> <Variable name> <Address(range)> <Comparison condition> <Comparison value>
Example	Write variable1 0x100 - 0x101 == 0x10	
Software Break [IECUBE] [MINICUBE2]	Format1	<Condition to occur> <File name#Line number> <Address>
	Example	Before Execution main.c#40 0x102
		Before Execution sub.c#101 0x204
	Format2	<Condition to occur> <Symbol + Offset> <Address>
Example	Before Execution funcA + 0x12 0x102	
Unconditional Trace [IECUBE] [Simulator]	Format	-
	Example	-
Run-Break Timer	Format	Total: <Total execution time>
	Example	Total: 1000ms
		Total: OVERFLOW

Event Type	Display Contents ^{Note 1}	
Trace [IECUBE] [Simulator] (Condition: execution)	Format	Total of Start/End: <Total number of Start tracing/Stop tracing events> Note 2 <Start/End> <Detailed information of Start tracing/Stop tracing>
	Example	Total of Start/End: 4 - Start After Execution main.c#1000x300 - Start After Execution funcA + 0x1000x300 - End After Execution main.c#2000x100 - End After Execution funcA + 0x100x100
Timer Result [IECUBE] [Simulator] (Condition: execution)	Format	Total:<Total execution time > Total of Start/End: <Total number of Start timer/Stop timer> ^{Note 2} - <Total execution time> <Pass Count> <Average> <Max> <Min> - <Start/End> <Detailed information of Start timer/Stop timer>
	Example	Total: 10ms Total of Start/End: 4 - Total: 10ms Pass Count: 5 Average: 2ms Max: 4ms Min: 1ms - Start After Execution main.c#1000x300 - Start After Execution funcA + 0x300x100 - End After Execution main.c#1000x300 - End After Execution funcA + 0x500x100
Point Trace [IECUBE] [Simulator] (Condition: access)	Format1	<Condition to occur> <Variable name> <Address(range)>
	Example	Read variable1 0x100 - 0x101
	Format2	<Condition to occur> <File name# Variable name> <Address(range)>
	Example	Write sub.c#variable2 0x200 - 0x200
	Format3	<Condition to occur> <File name#Function name# Variable name> <Address(range)>
	Example	Read/Write sub.c#func1#variabl3 0x300 - 0x303
Printf (Action event)	Format	<Condition to occur> <File name#Line number> <Address> <Setting of Printf event>
	Example	Before Execution main.c#39 0x100 aaa, bbb, ccc
		After Execution sub.c#100 0x200 Result of aaa : aaa

Notes 1. Following are the details on the display format.

<Condition to occur>	Display one of the following conditions. [IECUBE][MINICUBE2] Execution: Before Execution or After Execution Access: Read, Write, Read/Write [Simulator] Execution: Execution Access: Read, Write, Read/Write
----------------------	--

<File name#Line number>	Shows the line number of the source. Display format is the same as the watch type scope specification expression. For those events set in the Disassemble panel , display <Line number> in the format <Symbol + offset> in the condition below. - Line information exists and the specified position that the event is set not the top of the line information - Line information does not exist and symbol information exists. Show <Line number> in "-" in the following condition. - Line information and symbol information does not exist.
<Variable name>	Shows the variable name in the source file. Display format is the same as the watch type scope specification expression.
<Comparison condition>	Condition to compare (==) is shown. If the comparison value is not specified, comparison condition is not shown.
<Comparison value>	Comparison value is shown. If the comparison value is not specified, comparison condition is not shown.
<Address>	Address in the memory area is shown (only in hex number).
<Start/End>	Shows whether the contents of the detailed information is start event or the stop event.
<Pass Count>	Shows the measurement result of the pass count of the timer. If a timer overflow occurs (see " 2.12.3 Measurable time ranges "), or if the illegal value was acquired, "OVERFLOW" is displayed.
<Total>	Shows the measurement result of the timer total execution time. The unit is either of ns/ μ s/ms/s/min (if, however, the unit is in "min", a value in "s" unit also appears). If a timer overflow occurs (see " 2.12.3 Measurable time ranges "), or if the illegal value was acquired, "OVERFLOW" is displayed.
<Average>	Shows the measurement result of average execution of the timer. The unit is either of ns/ μ s/ms/s/min (if, however, the unit is in "min", a value in "s" unit also appears).
<Max>	Shows the measurement result of the maximum execution time of the timer. The unit is either of ns/ μ s/ms/s/min (if, however, the unit is in "min", a value in "s" unit also appears).
<Min>	Shows the measurement result of the minimum execution time of the timer. The unit is either of ns/ μ s/ms/s/min (if, however, the unit is in "min", a value in "s" unit also appears).
<Set print event>	Shows the variable expression and the character strings specified in the Action Events dialog box .

- Click this line to display the detailed information of the lower lines.











(3) [Comment] area

The user can write comments for each event that has been set.

To input comments, click on this area, or select [Edit Comment] from the context menu after selecting the event in which you want to input comments, and then input directly the desired text from the keyboard (the edit mode is cancelled by pressing down the [Esc] key).

After editing the comments, complete the editing by pressing the [Enter] key or moving the focus to outside the edit region. Up to a maximum of 256 characters can be inputted for the comments, and this is saved as the settings of the user during use.

[Toolbar]

	Deletes the selected event. Note that it is not possible to delete the built-in events (Unconditional Trace event and Run-Break Timer event).
	Displays events related to the Hardware Break (default).
 [IECUBE][MINICUBE2]	Displays events related to the Software Break (default).
 [IECUBE][Simulator]	Displays events related to the trace (default).
 [IECUBE][Simulator]	Displays events related to the timer (default).
	Displays events related to the action event (Printf event) (default).
	Displays events related to the built-in event (Unconditional Trace event/Run-Break Timer event) (default).
	Opens the Editor panel and jumps to the source line corresponding to the address where the selected event ^{Note} is being set.
	Opens the Disassemble panel and jumps to the disassemble results corresponding to the address where the selected event ^{Note} is being set.
	Opens the Memory panel and jumps to the memory corresponding to the address where the selected event ^{Note} is being set.

Note Events other than Trace events, Timer Result events and built-in events (Unconditional Trace events/Run-Break Timer events) can be objects of this button.

[[Edit] menu (Events panel-dedicated items)]

The following items are exclusive for [Edit] menu in the Events panel (other items are all invalid).

Delete	Deletes the selected event. Note that it is not possible to delete the built-in events (Unconditional Trace event and Run-Break Timer event).
Select All	Selects all the events displayed on the panel.
Find...	Opens the Search and Replace dialog box with selecting [Whole Search] tab.
Replace...	Opens the Search and Replace dialog box with selecting [Whole Replace] tab.

[Context menu]

Enable Event	Enables the selected event (valid state).
Disable Event	Disables the selected event (invalid state).
Delete	Deletes the selected event. Note that it is not possible to delete the built-in events (Unconditional Trace event and Run-Break Timer event).
Select All	Selects all the events of this panel.
View Select	The following cascade menus are displayed to limit the event type to be displayed. All of the items have been selected by default.
Hardware Break	Displays events related to the Hardware Break.
Software Break	Displays events related to the Software Break.
Timer Event	Displays events related to the timer.
Trace Event	Displays events related to the trace.
Action Event	Displays events related to the action event (Printf event).
Built-in Event	Displays events related to the built-in event (Unconditional Trace event/Run-Break Timer event).
Timer Settings	The following cascade menus are displayed to do the settings related to the timer. However, this item is valid only when a timer-related event has been selected.
Init Timer	Initializes the timer used by the selected event (except for the Run-Break Timer).
Nanosecond	Displays the Timer Results of the selected event in nanosecond units.
Microsecond	Displays the Timer Results of the selected event in microsecond units.
Millisecond	Displays the Timer Results of the selected event in millisecond units.
Second	Displays the Timer Results of the selected event in second units.
Minute	Displays the Timer Results of the selected event in minute units.
Jump to Memory	Opens the Memory panel (Memory1) and jumps to the memory corresponding to the address where the selected event ^{Note} is being set.
Jump to Disassemble	Opens the Disassemble panel (Disassemble1) and jumps to the disassemble results corresponding to the address where the selected event ^{Note} is being set.
Jump to Source	Opens the Editor panel and jumps to the source line corresponding to the address where the selected event ^{Note} is being set.
Edit Comment	Sets to the edit mode to input comments for the selected event. When comments are already present, all of that character string is set to a select state.

Note Events other than Trace events, Timer Result events and built-in events (Unconditional Trace events/Run-Break Timer events) can be objects of this button.

Output panel

This panel is used to display operation logs for various components (debug tool, design tool, build tool, etc.) provided by CubeSuite, in addition to results of batch searches by the Search and Replace dialog box and a Printf event (see "2.14.1 Inset printf").

The messages are classified by the message origination tool and displayed on the individual tabs.

Figure A-30. Output Panel

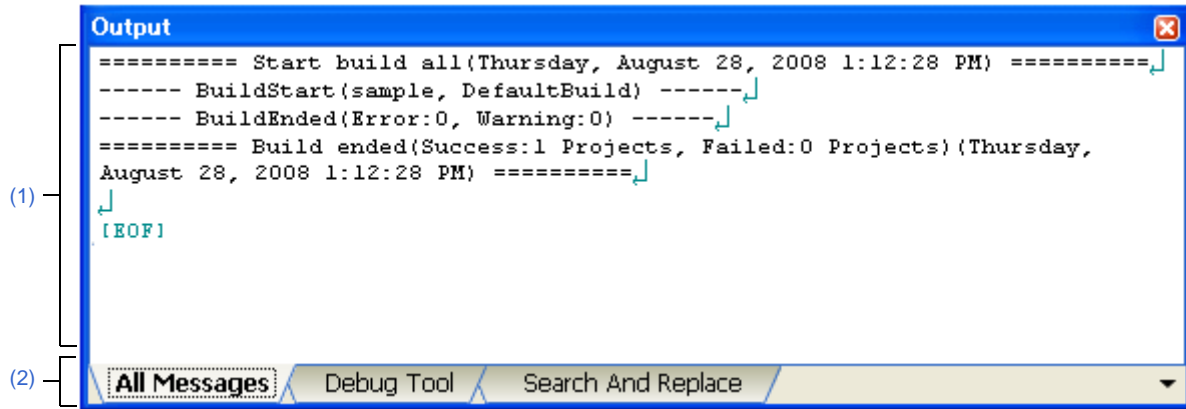

This section describes the following.

- [How to open]
- [Description of each area]
- [[File] menu (Output panel-dedicated items)]
- [[Edit] menu (Output panel-dedicated items)]
- [Context menu]

[How to open]

- From the [View] menu, select [Output].

[Description of each area]

(1) Message area

The output messages of each tool, search results and results by a Printf event are displayed.

In the case of search results (batch search), every time a search is performed, a new message will be displayed after the previous message is cleared (except for the [All Messages] tab).

The colors of message display differ with the type of message as shown below (character colors and background colors depend on the configuration in the [General - Font and Color] category of the Option dialog box).

Message Type	Display Example (Default)		Description	
Normal message	AaBbCc	Character color	Black	Displayed with information notices
		Background color	White	
Warning message	AaBbCc	Character color	Blue	Displayed with warnings about operations
		Background color	Standard color	
Error message	AaBbCc	Character color	Red	Displayed when there is a critical error, or when execution is not possible due to a operational mistake
		Background color	Light gray	

This area is provided with the following functions.

(a) Tag jump

By double-clicking on the output message, the [Editor panel](#) is opened and the number of the corresponding line in the corresponding file is displayed.

This allows you to jump from error messages that are output when building, etc. to the corresponding error line in the source file.

(b) Help display

If there is a caret on the line where a warning message or error message is being displayed, you can select [Help for Message] from the context menu. You can also display help for that line's message by pressing the [F1] key.

(c) Saving a log

The [Save As dialog box](#) can be opened by selecting the [File] menu >> [Save Output-tab name As...], and the contents that are displayed on the currently selected tab can be saved in a text file (*.txt) (messages on deselected tabs will not be saved).

(2) Tab selection area

Select the tab that indicates the origin of message.

The following tabs are available for the debug tool.

Tab Name	Description
All Messages	Displays operation logs for all components (debug tool, design tool, build tool, etc.) provided by CubeSuite in order of output.
Debug Tool	Displays messages output from the debug tool. Display only operation logs for the debug tool out of those for various components (debug tool, design tool, build tool, etc.) provided by CubeSuite.
Search And Replace	Displays the batch search results from the Search and Replace dialog box.

Caution Even if a new message is output on a deselected tab, tab selection will not automatically switch. In this case, "" mark will be added in front of the tab name, indicating that a new message has been output.

[[File] menu (Output panel-dedicated items)]

The following items are exclusive for the [File] menu in the Output panel (other items are common to all the panels). Note that all these items are invalid during execution of a program.

Save Output-tab name	Overwrites the contents that are displayed on the currently selected tab to the preciously saved text file (see "(c) Saving a log"). Note that when the file has never been saved or the file is write disabled, the same operation is applied as the selection in [Save Output-tab name As...]. This item becomes invalid while building.
Save Output-file name As...	Opens the Save As dialog box to newly save the contents that are displayed on the currently selected tab to the specified text file (*.txt) (see "(c) Saving a log").

[[Edit] menu (Output panel-dedicated items)]

The following items are exclusive for [Edit] menu in the Output panel (other items are all invalid).

Copy	Copies the contents of the selected range to the clipboard as character string(s).
Select All	Selects all the messages displayed on the currently selected tab.
Find...	Opens the Search and Replace dialog box with selecting [Quick Search] tab.
Replace...	Opens the Search and Replace dialog box with selecting [Whole Replace] tab.

[Context menu]

Copy	Copies the contents of the selected range to the clipboard as character string(s).
Select All	Selects all the messages displayed on the currently selected tab.
Clear	Deletes all the messages displayed on the currently selected tab.
Tag Jump	Opens the Editor panel and jumps to the number of the corresponding line in the corresponding file of the message at the caret position.
Stop Searching	<p> Cancels the search currently being executed.</p> <p> This is invalid when a search is not being executed.</p>
Help for Message	<p> Displays help for the message on the current caret position.</p> <p> This only applies to warning messages and error messages.</p>

Memory Mapping dialog box

This dialog box is used to set the memory mapping for each type of memory.

Caution If you are not connected to a debug tool, then only memory mapping areas added by user is displayed.

Connecting to a debug tool (see "2.4.1 Connect the debug tool to CubeSuite") will display details for each memory type.

Figure A-31. Memory Mapping Dialog Box [IECUBE][MINICUBE2]

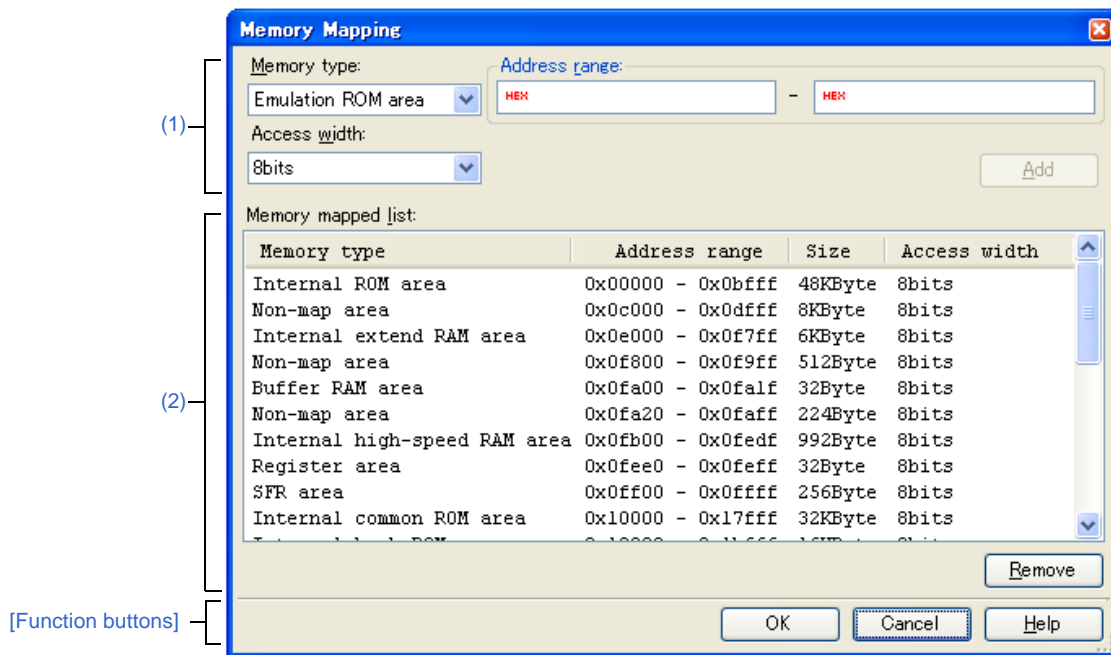
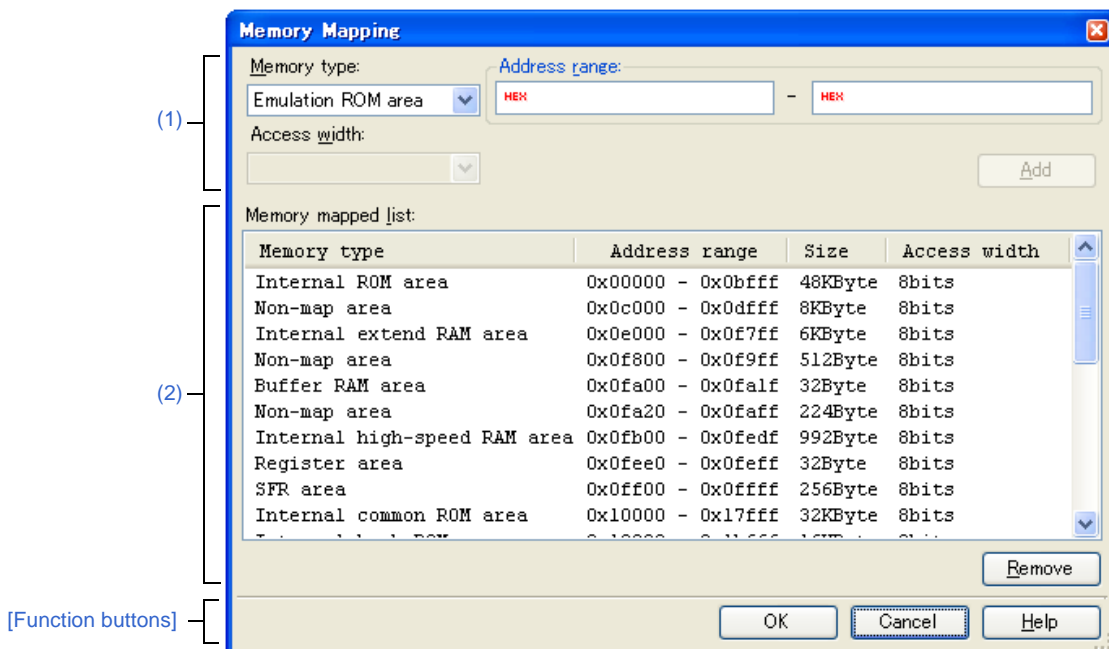

Figure A-32. Memory Mapping Dialog Box [Simulator]



This section describes the following.

- [\[How to open\]](#)
- [\[Description of each area\]](#)
- [\[Function buttons\]](#)

[How to open]

- On the [\[Debug Tool Settings\]](#) tab of the [Property panel](#), click the [...] button displayed by selecting one of the values of the [\[Memory mappings\]](#) property in the [\[Memory\]](#) category.

Caution This dialog box cannot be opened during execution of a program.

[Description of each area]

(1) Added memory mapping specification area

Specify the information for a newly added memory mapping.

(a) [Memory type]

Select the memory type for the memory mapping to be added from the following drop-down list. The item selected by default differs depending on the debug tool to use.

Emulation ROM area [IECUBE][Simulator]	Adds the Emulation ROM area. [IECUBE]: The IECUBE alternate ROM is used. [Simulator]: The simulator alternate ROM is used.
Emulation RAM area [Simulator]	Adds the Emulation RAM area. The simulator alternate RAM is used.
Target memory area	Adds the target memory area.
I/O protection area	Adds the I/O protection area ^{Note} .

Note The I/O protected area is an area protected from access by the debug function.

The address range set to I/O protected area cannot be accessed from the [Memory panel](#) (i.e., it can only be accessed via executing the load module). I/O protected area mapping is only possible within the target memory area.

Remark External memory area and guarded areas (areas where access is prohibited) are treated as non-mapped areas. For this reason, if a mapping overlaps a guarded area, then a message will inform the user that the mapping overlaps a non-mapped area.

See the manual of our microcontroller for details onfor details onfor details on the mapping information of external memory areas and guarded areas.

Mapping attributes and their sizes that can be set are as follows:

Table A-13. Settable Mapping Attribute

Attribute	Debug Tool		
	IECUBE	MINICUBE2	Simulator
Emulation ROM area	✓ ^{Note}	—	✓
Emulation RAM area	—	—	✓
Target memory area	✓ ^{Note}	✓	✓
I/O protection area	✓	✓	✓

✓ : Valid (Mapping unit: 1 byte)

— : Invalid

Note The target memory area and the emulation ROM area can be mapped to a total of four.

(b) [Address range]

Specify the start address and end address for the memory mapping to be added.

Directly input a hexadecimal number into the text box for each.

In the case of the following settings, however, new memory mappings cannot be added. Clicking the [Add] button in this area causes an error message to be displayed.

- If the specified address range duplicates a separate memory area when [Target memory area] is selected as the memory type
- If the specified address range cannot be put into a single target memory area when [I/O protection area] is selected as the memory type

(c) [Access width] [IECUBE][MINICUBE2]

Select the access width of the memory mapping to be added from the following drop-down list (direct input is not possible).

In the case where [I/O protection area] is selected as the memory type, the access width must be set to the same value as the access width of the target memory area.

8bits	Sets the access width of the memory mapping to be added to 8 bits (default).
-------	--

(d) Button

Button	Function
Add	Adds the content specified in this area to memory mapping. The added memory mapping is displayed in the [Memory mapped list] area . The changes will not take effect until the [OK] button is clicked.

(2) [Memory mapped list] area

(a) List display

Information about the memory mapping added in the [Added memory mapping specification area](#) and the microcontroller's internal memory mapping is displayed. This area cannot be edited.

Memory type	Displays the following memory types. - Internal ROM area ^{Note 1, 2} - Internal common ROM area - Internal bank ROM area - Internal high speed RAM area - Buffer RAM area - Internal extend RAM area - Other RAM area - SFR area - Target memory area - Emulation ROM area [IECUBE][Simulator] - Emulation RAM area [Simulator] - Non-map area - I/O protection area
Address range	Displays the address range as <Start address> - <End address>. Display is fixed as "0x"-prefixed hexadecimal numbers.
Size	Displays size as a decimal number (unit: bytes/Kbytes ^{Note 3}).
Access width	Displays the access width (unit: bits).

- Notes 1.** This item does not appear when the selected microcontroller is a ROMless product.
 In the case that internal emulation ROM area exists in the emulator, however, "Internal ROM area" will be displayed only when the [Size of internal ROM [KBytes]] property of the [Internal ROM/RAM] category is set to a value greater than "0" in the [\[Connect Settings\] tab](#) of the [Property panel](#).
- 2. [IECUBE][Simulator]**
 Displays of the following memory areas differ depending on the [Use memory bank function] property of the [Internal ROM/RAM] category in the [\[Connect Settings\] tab](#) of the [Property panel](#).

Memory Area	Setting of [Use memory bank function] Property	
	Yes	No
Internal ROM area	Not displayed	Displayed
Internal common ROM area	Displayed	Not displayed
Internal bank ROM area	Displayed	Not displayed

[MINICUBE2]

Displays of the following memory areas differ depending on whether the memory bank function is supported by the selected microcontroller.

Memory Area	Supported Memory Bank Function	Not Supported Memory Bank Function
Internal ROM area	Not displayed	Displayed
Internal common ROM area	Displayed	Not displayed
Internal bank ROM area	Displayed	Not displayed

- 3.** Only in the case of multiple of 1024, displays in kilobyte units.

(b) Button

Button	Function
Remove	<p>Deletes the memory mapping selected in this area.</p> <p>The memory areas that can be deleted are the Target memory area, I/O protection area, Emulation ROM area [Simulator], or the Emulation RAM area [Simulator] (the microcontroller's internal memory mapping cannot be deleted).</p> <p>In the case where you have attempted to delete a target memory area that is specified as an I/O protection area, however, a message will be displayed. The selected target memory area and the I/O protection area mapped to that area will both be deleted only if you click the [OK] button.</p>

[Function buttons]

Button	Function
OK	Sets the currently specified memory mapping to the debug tool and closes this dialog box.
Cancel	Cancels memory mapping changes and closes this dialog box.
Help	Displays the help for this dialog box.

Download Files dialog box

This dialog box is used to select files for downloading and configure download conditions (see "2.5 Download/Upload Programs").

Note that files specified as build targets in a project (main project or sub-project) are automatically registered as download targets (they can be unregistered).

Figure A-33. Download Files Dialog Box

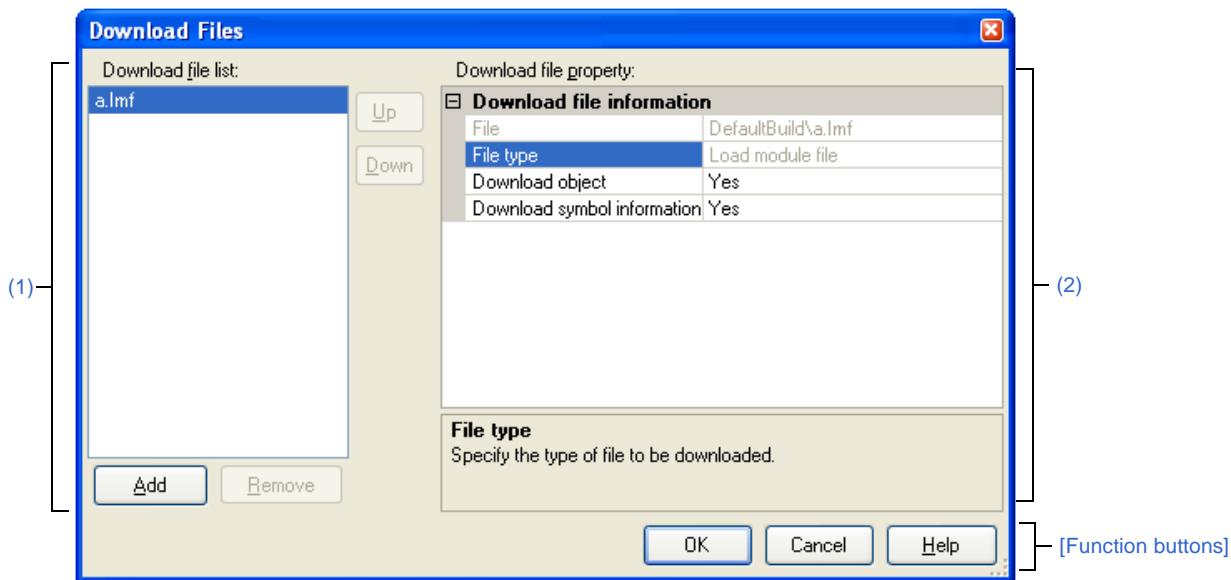

This section describes the following.

- [How to open]
- [Description of each area]
- [Function buttons]

[How to open]

- On the [Download File Settings] tab of the Property panel, click the [...] button displayed by selecting the [Download files] property in the [Download] category.

Caution This dialog box cannot be opened during execution of a program.

[Description of each area]

(1) [Download file list] area

(a) List display

Displays a list of files to download. The names of files specified as build targets in a project (main project or sub-project) are displayed by default (they can be removed).

Files are downloaded in the order that they are displayed here.

To add a new file to be downloaded, click the [Add] button in this area, then in the [Download file property] area, specify the download conditions of the file to add.

(b) Button

Button	Function
Up	Moves the selected file up one row in the list. Clicking this for the top file in the list has no effect.
Down	Moves the selected file down one row in the list. Clicking this for the bottom file in the list has no effect.
Add	Adds an empty item "-" to the list, and selects it. Specify the download conditions of the file to add in the [Download file property] area . Note that this button will be disabled if 20 files have already been registered.
Delete	Deletes the selected file from the list. Note, however, that this button is disabled if the selected file is a project build target.

- Remarks 1.** By superimposing the mouse cursor on a file name, the pass information of the file is pop-up displayed.
- 2.** By dragging a file name with the mouse, the display order in the list can be changed.
Note, however, that the order of a project build target cannot be changed.

(2) [\[Download file property\] area](#)

(a) [\[Download file information\]](#)

This area is used to display or edit the download conditions of the file selected in the [\[Download file list\] area](#). It can also be used to specify the download conditions of new download files added via the [\[Add\]](#) button.

File	Specify the name of the file to download (up to 259 characters).	
	Default	<i>File name</i> (but it will be blank for newly added files)
	Modifying	Directly enter from the keyboard, or specify with the Select Download File dialog box opened by clicking the [...] button ^{Note 1} appears at right by selecting this item.
	Available values	See " Table 2-1. Type of Files That Can be Downloaded "
File type	Specify the type of the file to download.	
	Default	Load module file
	Modifying	Select from the drop-down list.
	Available values	Either of the following [When a microcontroller with memory bank function] - Load module file - Hex file[Bank] (For memory banks) - Hex file[64KB] (When memory capacity is 64 KB or lower) - Binary data file[Bank] (For memory banks) - Binary data file[64KB] (When memory capacity is 64 KB or lower) [When a microcontroller without memory bank function] - Load module file - Hex file - Binary data file

Offset	This item appears only when the file to download is in hex format. Specify the offset from the address at which the file's download is to start.	
	Default	0x0
	Modifying	Directly enter from the keyboard.
	Available values	[When a microcontroller with memory bank function] 0x0 to 0xFFFF in hexadecimal number [When a microcontroller without memory bank function] 0x0 to 0xFFFF in hexadecimal number
Start address	This item appears only when the file to download is in binary format. Specify the address at which to start the file's download.	
	Default	0x0
	Modifying	Directly enter from the keyboard.
	Available values	[When a microcontroller with memory bank function] 0x0 to 0xFFFF in hexadecimal number [When a microcontroller without memory bank function] 0x0 to 0xFFFF in hexadecimal number
Download object	This item appears only when the file to download is in load module format. Specify whether to download the object information from the specified file.	
	Default	Yes
	Modifying	Select from the drop-down list.
	Available values	Yes Downloads object information. No Does not download object information.
Download symbol information	This item appears only when the file to download is in load module format. Specify whether to download the symbol information from the specified file ^{Note 2} .	
	Default	Yes
	Modifying	Select from the drop-down list.
	Available values	Yes Downloads symbol information. No Does not download symbol information.

- Notes 1.** When a file specified as build target in the project is selected in the [\[Download file list\]](#) area, or when the program is executing, the [...] button does not appear.
- 2.** If the symbol information have not been downloaded, the source level debugging cannot be performed.

[Function buttons]

Button	Function
OK	Finishes the download file setup, and closes this dialog box.
Cancel	Cancels any changes to the download files, and closes this dialog box.
Help	Displays the help for this dialog box.

Text Edit dialog box

This dialog box is used to input/modify character strings.

Figure A-34. Text Edit Dialog Box

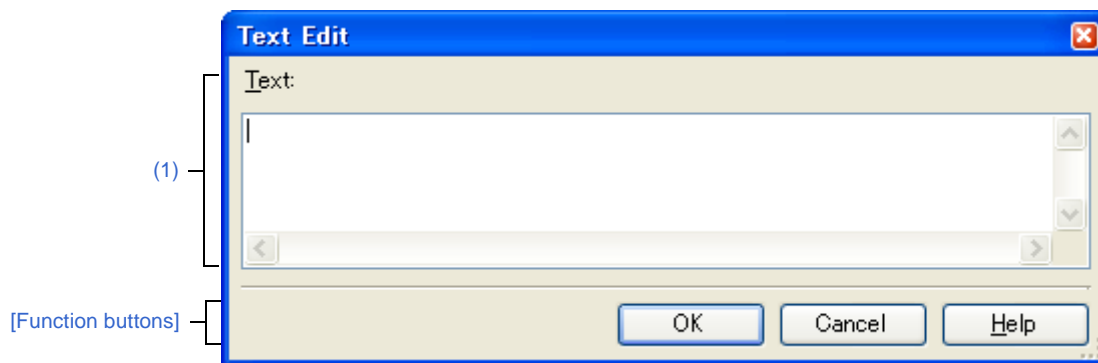

This section describes the following.

- [How to open]
- [Description of each area]
- [Function buttons]

[How to open]

- On the [Hook Transaction Settings] tab of the Property panel, click the [...] button displayed by selecting one of the property in the [Hook Transaction Settings] category.

[Description of each area]

(1) [Text] area

Input/modify character strings in this area.

[Function buttons]

Button	Function
OK	Sets the input character strings to the caller panel/dialog box and closes this dialog box.
Cancel	Closes this dialog box.
Help	Displays the help for this dialog box.

Action Events dialog box

This dialog box is used to configure Printf events as action events (see "2.14 Set an Action into Programs").

A Printf event momentarily stops the execution of the program at a specified location, and executes the printf command via software processing. When a Printf event is set, the program momentarily stops immediately before executing the command at the location where this event is set, and the value of the variable expression specified in this dialog box is output to the [Output panel](#).

This dialog box only appears when connected to the debug tool.

- Cautions 1.** Also see "2.15.6 Notes for setting events" for details on Printf events (e.g. limits on the number of enabled events).
- 2.** Once a Printf event has been set, its variable expression cannot be edited. If you need to edit a variable expression, first delete the Printf event and then create a new one.

Figure A-35. Action Events Dialog Box

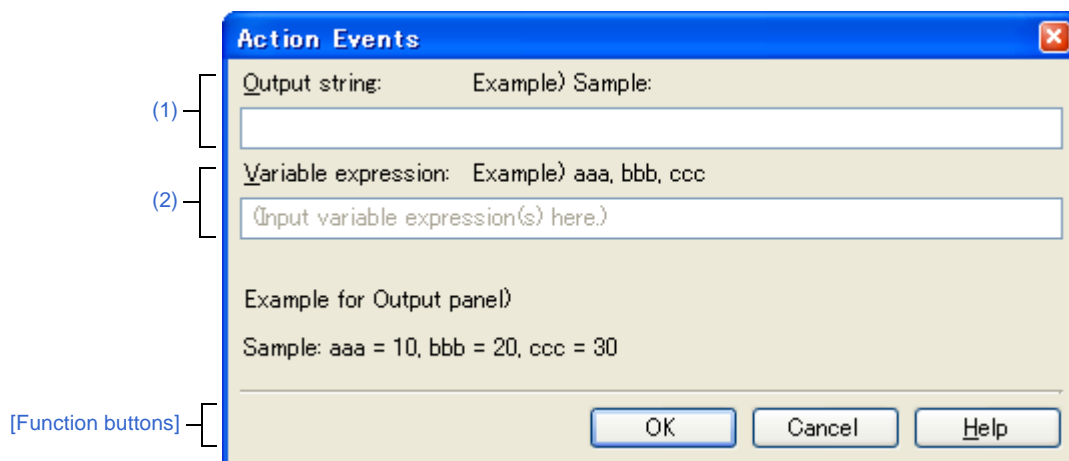

This section describes the following.

- [\[How to open\]](#)
- [\[Description of each area\]](#)
- [\[Function buttons\]](#)

[How to open]

- On the [Editor panel](#), move the caret to the line where you wish to set a Printf event, then select [Register Action Event...] from the context menu.
- On the [Disassemble panel](#), move the caret to the address where you wish to set a Printf event, then select [Register Action Event...] from the context menu.

[Description of each area]

(1) [Output string] area

Type in the string to add to the [Output panel](#) directly via the keyboard (up to 1024 characters). Note that the output string can only be one line (spaces allowed).

(2) [Variable expression] area

Specify the variable expression(s) for the Printf event.

Type a variable expression directly into the text box (up to 1024 characters).

You can specify up to 10 variable expressions for a single Printf event by separating them with commas (",").

If this dialog box is opens with a variable expression selected in the [Editor panel /Disassemble panel](#), the selected variable expression appears as the default.

The basic input format that can be specified as variable expressions and the values output by Printf event are as follows:

Table A-14. Relationship between Variable Expressions and Output Value (Printf Event)

Variable Expression	Output Value
Variable name of C language	Value of C language variable
<i>Variable expression</i> [<i>Variable expression</i>]	Element of array
<i>Variable expression</i> Member name	Member of structure/union
<i>Variable expression</i> -> Member name	Member of structure/union that pointer designates
* <i>Variable expression</i>	Value of pointer variable
CPU register name	Value of the CPU register
SFR name	SFR value
Label, EQU symbol and immediate address	Values of label, EQU symbol and immediate address
Bit symbol	Bit symbol value

Caution A variable expression including an arithmetic expression (e.g. "+"/"-") cannot be specified.

Remark The output result format by the Printf event in the [Output panel](#) are as follows:

Figure A-36. Output Result Format of Printf Event

Specified characters *Variable expression 1* = Value 1, *Variable expression 2* = Value 2, *Variable expression 3* = Value 3, ...

<i>Specified characters</i>	Characters specified with [Output string]
<i>Variable expression 1 - 10</i>	Characters specified with [Variable expression]
<i>Value 1 - 10</i>	Value of variable corresponds to " <i>Variable expression 1 - 10</i> " (Displayed as a decimal number followed by the hexadecimal equivalent in parentheses ()) Note that if the specified variable expression cannot be acquired, "?" is output. If the variable is of type char, then it is displayed as a character.

[Function buttons]

Button	Function
OK	Finishes configuring the Printf event, and sets it at the caret position in the Editor panel/Disassemble panel .
Cancel	Cancels the Printf event setup and closes this dialog box.
Help	Displays the help for this dialog box.

Save Settings dialog box

This dialog box is used to specify the encoding and the new line code of the file being edited in the [Editor panel](#).

Figure A-37. Save Settings Dialog Box

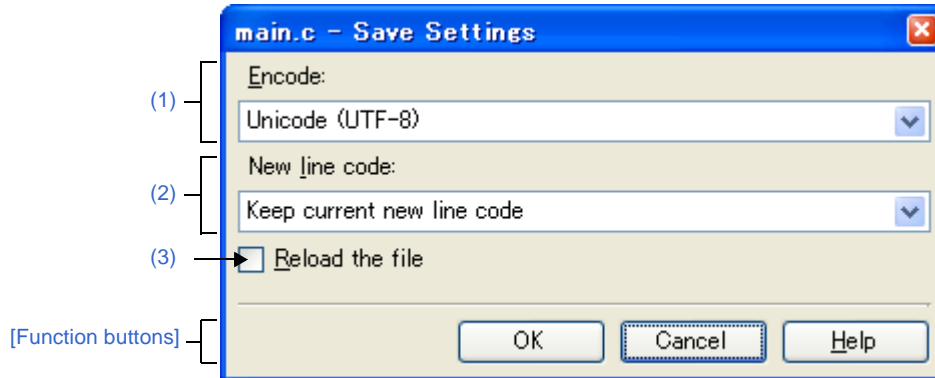

This section describes the following.

- [\[How to open\]](#)
- [\[Description of each area\]](#)
- [\[Function buttons\]](#)

[How to open]

- On the [Editor panel](#), select [*File name Save Settings...*] from the [File] menu.

[Description of each area]

(1) [Encode] area

Specify the encoding to be set from the drop-down list.

The items in the drop-down list appear in the following order.

Note that encodings that are either overlapped or non-supported by the OS currently being used do not appear.

- *A current encoding of the file (default)*
- *A regulation encoding of the OS currently being used*
- Unicode (UTF-8)
- Japanese (Shift-JIS)
- Japanese (JIS-Allow 1 byte Kana - SO/SI)
- Japanese (EUC)

(2) [New line code] area

Specify the new line code to be set from the drop-down list.

Either of the following can be selected.

- Keep current new line code
- Windows (CR LF)
- Macintosh (CR)
- Unix (LF)

(3) [Reload the file]

<input checked="" type="checkbox"/>	Reloads the file with the specified encoding and new line code when the [OK] button is clicked.
<input type="checkbox"/>	Does not reload the file when the [OK] button is clicked (default).

[Function buttons]

Button	Function
OK	Sets the specified encoding and new line code to the file and closes this dialog box. When the [Reload the file] check box is selected, reloads the file with the specified encoding and new line code, and closes this dialog box.
Cancel	Cancel the setting and closes this dialog box.
Help	Displays the help for this dialog box.

Memory Initialize dialog box

This dialog box is used to initialize memory (see "(6) [Modify the memory contents in batch \(initialize\)](#)").
The memory area in the specified address range is repeatedly overwritten with the specified initial data pattern.

Figure A-38. Memory Initialize Dialog Box

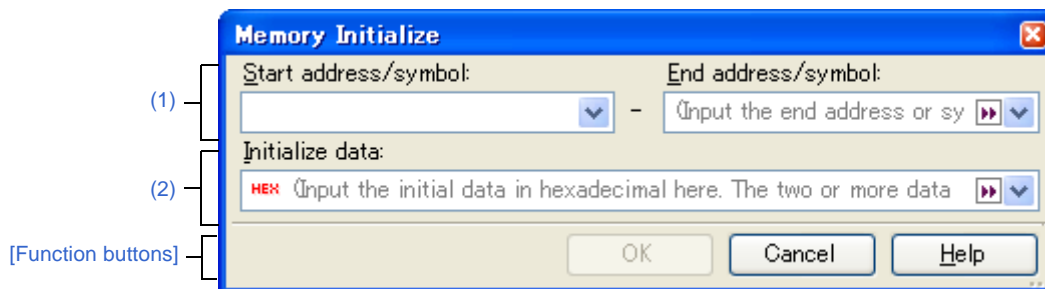

This section describes the following.

- [\[How to open\]](#)
- [\[Description of each area\]](#)
- [\[Function buttons\]](#)

[How to open]

- On the [Memory panel](#), select [\[Fill...\]](#) from the context menu.

[Description of each area]

(1) Range specification area

Specify the range of memory address to initialize via the [\[Start address/symbol\]](#) and [\[End address/symbol\]](#). You can either type address expressions directly into the text boxes (up to 1024 characters), or select them from the input history via the drop-down list (up to 10 items).

The results of calculating the address expressions you have entered are treated as start and end addresses, respectively.

Note that address values greater than the microcontroller address space cannot be specified.

(2) [Initialize data] area

Specify the initial value(s) with which to overwrite the memory.

You can either type the initial value into the text box directly in hexadecimal number (the value need not start with "0x"), or select one from the input history via the drop-down list (up to 10 items).

You can specify more than one initial value. Specify up to 16 values of up to 4 bytes (8 characters) each, separated by spaces.

Each initial data value is parsed from the end of the string, with each two characters interpreted as a byte.

If the string has an odd number of characters, then the first character is interpreted as one byte.

Example Endianness specified by debug tool is little endian

Input Character String (Initialization Data)	How Data is Overwritten (in Bytes)
1	01
0 12	00 12
00 012 345	00 12 00 45 03
000 12 000345	00 00 12 45 03 00

[Function buttons]

Button	Function
OK	The memory area in the specified address range is repeatedly overwritten with the specified initial data pattern. If the end address is reached in the middle of the pattern, then writing ends at that point.
Cancel	Cancels the memory initialization and closes this dialog box.
Help	Displays the help for this dialog box.

Memory Search dialog box

This dialog box is used to search memory (see "(5) Search the memory contents").

Search in either the [Memory value area](#) or [Character string area](#) where the caret was located in the [Memory panel](#) immediately before this dialog box opened.

Figure A-39. Memory Search Dialog Box

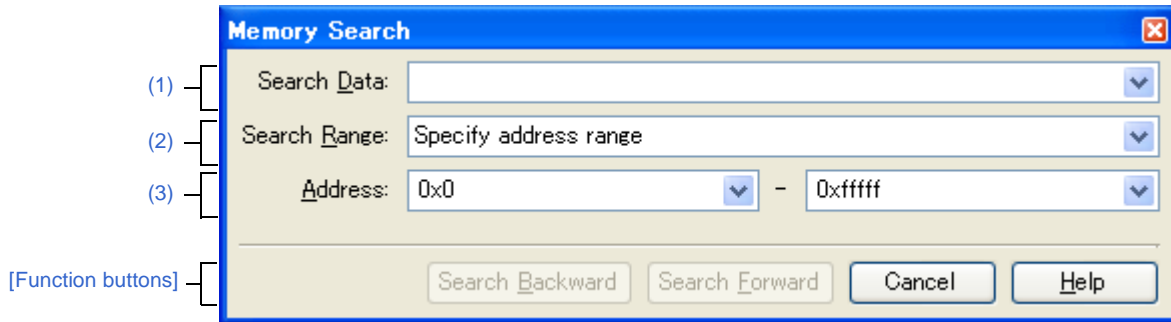

This section describes the following.

- [\[How to open\]](#)
- [\[Description of each area\]](#)
- [\[Function buttons\]](#)

[How to open]

- On the [Memory panel](#), select [\[Find...\]](#) from the context menu.

[Description of each area]

(1) [Search Data] area

Specify data to search.

You can either type a value directly into the text box (up to 256 bytes), or select one from the input history via the drop-down list (up to 10 items).

If the search is performed in the [Memory value area](#) of the [Memory panel](#), the value must be entered in the same display format (notation and size) as that area.

If the search is performed in the [Character string area](#), then the target of the search must be a string. The specified string is converted into the encoding format displayed in that area, and searched for.

If a memory value was selected immediately prior to opening this dialog box, then that value will appear as default.

(2) [Search Range] area

Select the range to search from the following drop-down list.

Specify address range	Searches in the address range specified in the [Address] area .
<i>Memory mapping</i>	Searches within the selected memory mapping range. This list item displays the memory mappings set in the Memory Mapping dialog box (except the non-mapped area). Display format: <memory type> <address range> <size>

(3) [Address] area

This item is only enabled if [Specify address range] is selected in the [Search Range] area.

Specify the range of memory address to search via the start and end addresses. You can either type address expressions directly into the text boxes (up to 1024 characters), or select them from the input history via the drop-down list (up to 10 items).

The results of calculating the address expressions you have entered are treated as start and end addresses, respectively.

Note that if an address value^{Note} greater than the microcontroller address space is specified, the upper address value is masked.

In addition, an address value greater than the value expressed within 32 bits cannot be specified.

Note When the selected microcontroller has a built-in memory bank, only the bank area (0xN8000 - 0xNBFFF) can be searched.,in the address range larger than 0x10000.

- Remarks 1.** If the start address field is left blank, it is treated as if "0x0" were specified.
- 2.** If the end address field is left blank, then it is treated as if the maximum value in the microcontroller's address space were specified.

[Function buttons]

Button	Function
Search Backward	Searches upward within the range specified in the [Address] area or the [Search Range] area. The location found by the search is selected in the Memory panel. Note that if an illegal value is specified or while the program is being executed, a message will be appear, and the memory search will not be performed. If focus moves to this dialog box while the memory panel is hidden or another panel has focus, then this button will be disabled.
Search Forward	Searches downward within the range specified in the [Address] area or the [Search Range] area. The location found by the search is selected in the Memory panel. Note that if an illegal value is specified or while the program is being executed, a message will be appear, and the memory search will not be performed. If focus moves to this dialog box while the memory panel is hidden or another panel has focus, then this button will be disabled.
Cancel	Cancels the memory search and closes this dialog box.
Help	Displays the help for this dialog box.

Trace Search dialog box [IECUBE][Simulator]

This dialog box is used to search trace data (see "2.11.7 Search the trace data").
 The search can be performed at the instruction or source level.

Figure A-40. Trace Search Dialog Box

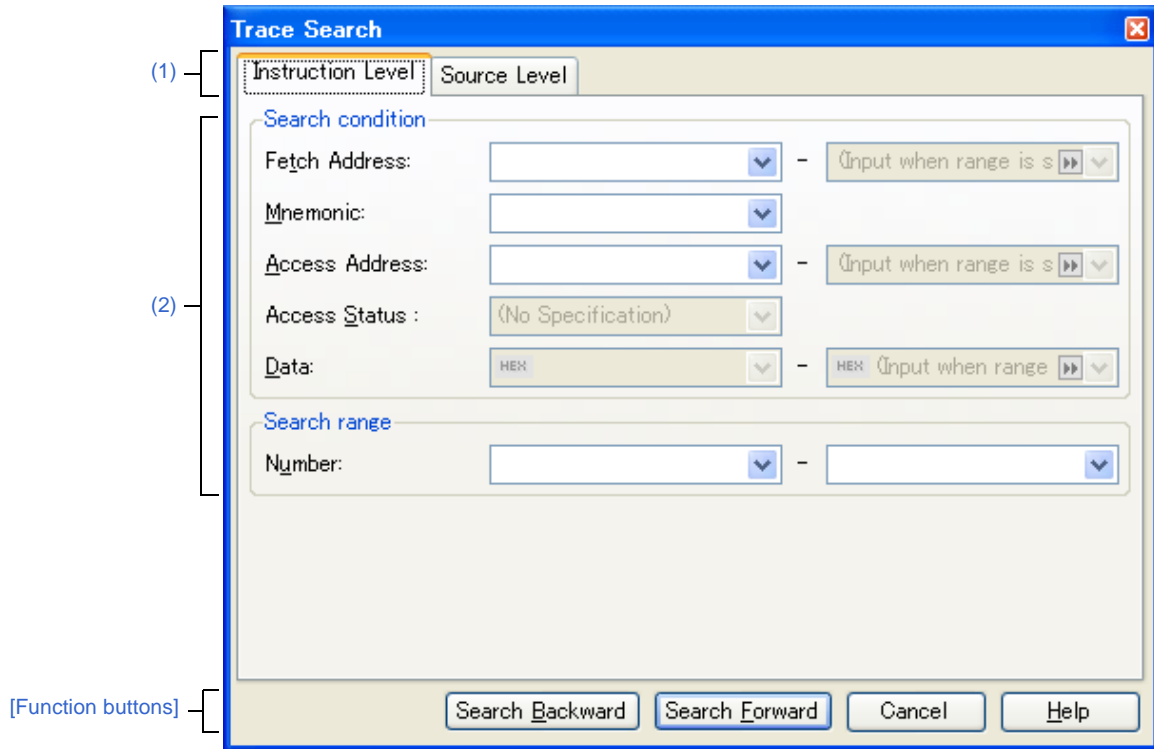

This section describes the following.

- [How to open]
- [Description of each area]
- [Function buttons]

[How to open]

- On the Trace panel [IECUBE][Simulator], select  button on the toolbar.
- On the Trace panel [IECUBE][Simulator], select [Find...] from the context menu.

[Description of each area]

(1) Tab selection area

Select a tab to switch the level of the search.
 This dialog box has the following two tabs.

- [Instruction Level] tab
- [Source Level] tab

(2) Search parameter setup area

Use this area to configure detailed search parameters.

for details on the window elements and how to configure the parameters for a particular tab, see the section for the tab in question.

[Function buttons]

Button	Function
Search Backward	Searches upward (in the direction of larger to smaller numbers) within the specified range. Search matches are selected in the Trace panel [IECUBE][Simulator] . Note that if an illegal value is specified or while the program is being executed, a message will be appear, and the trace data search will not be performed. If focus moves to this dialog box while the Trace panel is hidden or another panel has focus, then this button will be disabled.
Search Forward	Searches forward (in the direction of smaller to larger numbers) within the specified range. Search matches are selected in the Trace panel [IECUBE][Simulator] . Note that if an illegal value is specified or while the program is being executed, a message will be appear, and the trace data search will not be performed. If focus moves to this dialog box while the Trace panel is hidden or another panel has focus, then this button will be disabled.
Cancel	Cancels the trace data search and closes this dialog box.
Help	Displays the help for this dialog box.

[Instruction Level] tab

Use this tab to search the acquired trace data at the instruction level.

Caution If the Trace panel [IECUBE][Simulator] is set to Source display mode, then performing an instruction level search via this tab will not perform the target search correctly. In order to perform an instruction level search, set the mode to Mixed display mode or Disassemble display mode.

Figure A-41. Trace Search Dialog Box: [Instruction Level] Tab

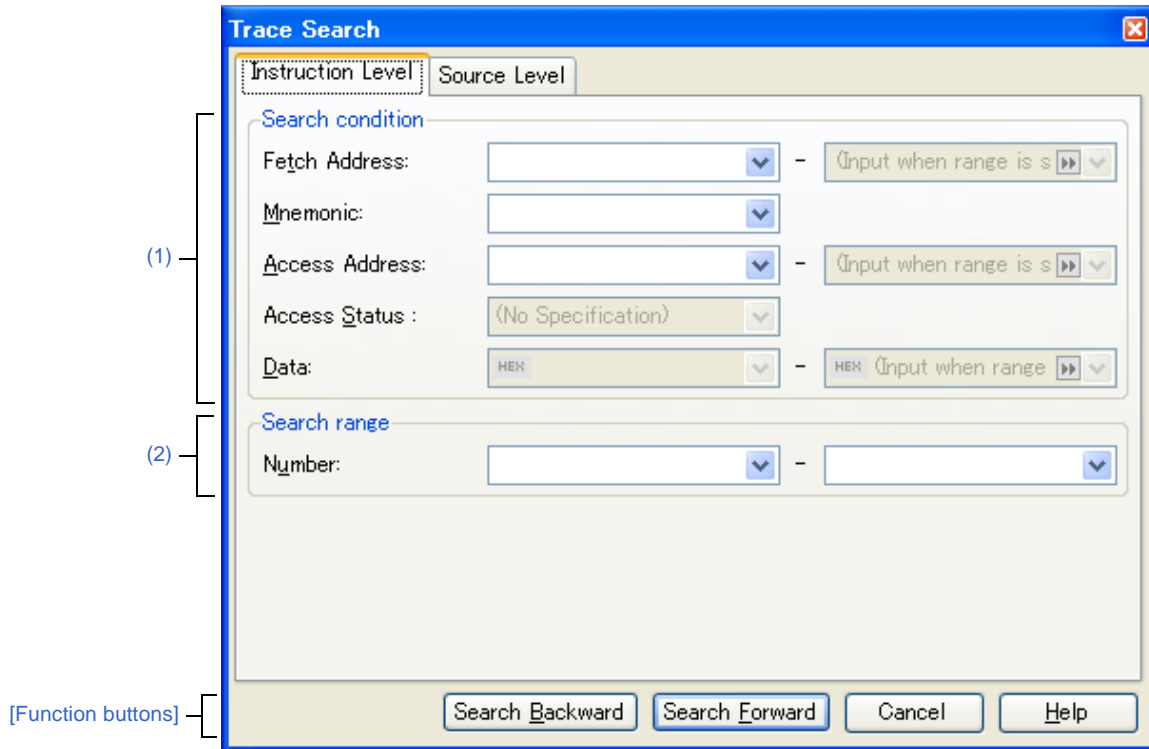

This section describes the following.

- [How to open]
- [Description of each area]
- [Function buttons]

[How to open]

- On the Trace panel [IECUBE][Simulator], select  button on the toolbar.
- On the Trace panel [IECUBE][Simulator], select [Find...] from the context menu.

[Description of each area]

(1) [Search condition] area

(a) [Fetch Address]

Specify the fetch address if it is a required search parameter.
 You can either type address expressions directly into the text boxes, or select them from the input history via the drop-down lists (up to 10 items).
 The fetch address can also be specified as a range. In this case, specify a range by specifying address expressions in both the left and right text boxes.
 If the right-hand text box is blank or contains the text [(Input value when range is specified)], then the fixed address specified in the left-hand text box will be searched.
 Note that if an address value greater than the microcontroller address space is specified, the upper address value is masked.
 In addition, an address value greater than the value expressed within 32 bits cannot be specified.

(b) [Mnemonic]

Specify the mnemonic if it is a required search parameter.
 The specified character strings in this area are searched within the [Source/Disassemble] area of the Trace panel [IECUBE][Simulator].
 You can either type a mnemonic directly into the text boxes, or select one from the input history via the drop-down list (up to 10 items).
 Searches are case-insensitive, and partial matches are also allowed.

(c) [Access Address]

Specify the access address if it is a required search parameter.
 You can either type address expressions directly into the text boxes, or select them from the input history via the drop-down lists (up to 10 items).
 The access address can also be specified as a range. In this case, specify a range by specifying address expressions in both the left and right text boxes.
 If the right-hand text box is blank or contains the text [(Input value when range is specified)], then the fixed address specified in the left-hand text box will be searched.
 Note that if an address value greater than the microcontroller address space is specified, the upper address value is masked.
 In addition, an address value greater than the value expressed within 32 bits cannot be specified.

(d) [Access Status]

This item is only enabled if a value for [Access Address] is specified.
 Select the access type from the following drop-down list.
 Select [No Specification] if you do not wish to limit access types.

(No Specification)
Read/Write
Read
Write
Vector Read
DMA

(e) [Data]

This item is only enabled if a value for [Access Address] is specified.

Specify the access data.

You can either type the data directly into the text boxes (in hexadecimal number), or select it from the input history via the drop-down list (up to 10 items).

The data can also be specified as a range. In this case, specify a range by specifying data in both the left and right text boxes.

If the right-hand text box is blank or contains the text [(Input value when range is specified)], then the fixed data specified in the left-hand text box will be searched.

(2) [Search range] area

(a) [Number]

Specify the range within the trace data to search via the number displayed in the [Number] area of the Trace panel [IECUBE][Simulator].

Specify the starting number in the left text box, and the ending number in the right text box ("0" to "last number" are specified by default).

You can either type the numbers directly into the text boxes (in base-10 format), or select them from the input history via the drop-down lists (up to 10 items).

If the left-hand text box is left blank, it is treated as if "0" were specified.

If the right-hand text box is left blank, it is treated as if the last number were specified.

[Function buttons]

Button	Function
Search Backward	Searches upward (in the direction of larger to smaller numbers) within the specified range. Search matches are selected in the Trace panel [IECUBE][Simulator]. Note that if an illegal value is specified, a message will be appear, and the trace data search will not be performed. If focus moves to this dialog box while the Trace panel is hidden or another panel has focus, then this button will be disabled.
Search Forward	Searches forward (in the direction of smaller to larger numbers) within the specified range. Search matches are selected in the Trace panel [IECUBE][Simulator]. Note that if an illegal value is specified, a message will be appear, and the trace data search will not be performed. If focus moves to this dialog box while the Trace panel is hidden or another panel has focus, then this button will be disabled.
Cancel	Cancels the trace data search and closes this dialog box.
Help	Displays the help for this dialog box.

[Source Level] tab

Use this tab to search the acquired trace data at the source level.

Caution If the **Trace panel [IECUBE][Simulator]** is set to **Disassemble display mode**, then performing an source level search via this tab will not perform the target search correctly. In order to perform an source level search, set the mode to **Mixed display mode** or **Source display mode**.

Figure A-42. Trace Search Dialog Box: [Source Level] Tab

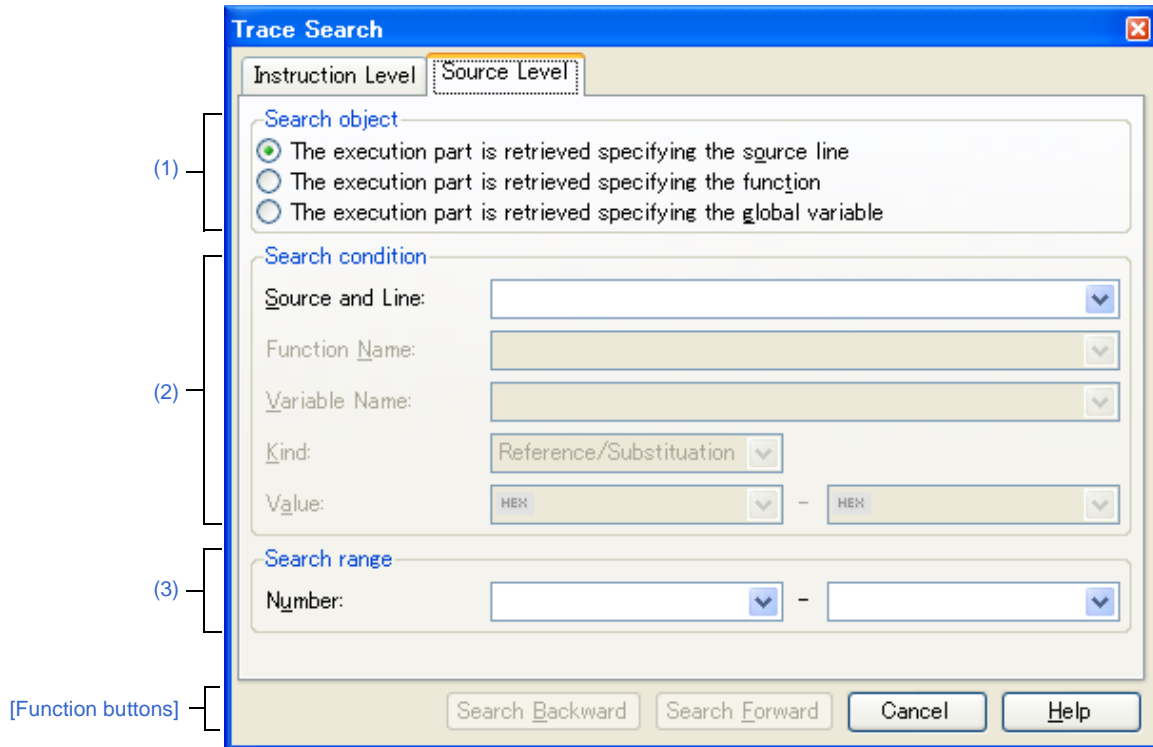

This section describes the following.

- [How to open]
- [Description of each area]
- [Function buttons]

[How to open]

- On the **Trace panel [IECUBE][Simulator]**, select  button on the toolbar.
- On the **Trace panel [IECUBE][Simulator]**, select [Find...] from the context menu.

[Description of each area]**(1) [Search object] area**

Select the search object from the following option buttons.

The execution part is retrieved specifying the source line	Finds the execution location in the specified source line (default). Only [Source and Line] will be enabled as a search parameter.
The execution part is retrieved specifying the function	Finds the execution location in the specified function. Only [Function Name] will be enabled as a search parameter.
The execution part is retrieved specifying the global variable	Finds the location at which the specified global variable was accessed. Only [Variable Name] , [Kind] and [Value] will be enabled as a search parameters.

(2) [Search condition] area**(a) [Source and Line]**

This item is only enabled if [\[The execution part is retrieved specifying the source line\]](#) is selected.

The specified character strings in this area are searched within the [\[Line/Address\]](#) area of the [Trace panel \[IECUBE\]\[Simulator\]](#).

You can either type the character strings of the source line to be find directly into the text box, or select them from the input history via the drop-down list (up to 10 items).

Searches are case-insensitive, and only complete matches are retrieved.

- Examples**
1. main.c#40
 2. main.c
 3. main

(b) [Function Name]

This item is only enabled if [\[The execution part is retrieved specifying the function\]](#) is selected.

You can either type the function name to be find directly into the text box, or select it from the input history via the drop-down list (up to 10 items).

Searches are case-insensitive, and only complete matches are retrieved.

(c) [Variable Name]

This item is only enabled if [\[The execution part is retrieved specifying the global variable\]](#) is selected.

You can either type the variable name to be find directly into the text box, or select it from the input history via the drop-down list (up to 10 items).

Searches are case-insensitive, and only complete matches are retrieved.

(d) [Kind]

This item is only enabled if [\[The execution part is retrieved specifying the global variable\]](#) is selected.

Select the access type ([\[Reference/Substitution\]](#), [\[Reference\]](#), or [\[Substitution\]](#)) from the drop-down list.

(e) [Value]

This item is only enabled if [\[The execution part is retrieved specifying the global variable\]](#) is selected.

Specify the accessed variable value in hexadecimal number.

You can either type a variable value directly into the text box, or select one from the input history via the drop-down list (up to 10 items).

The variable value can also be specified as a range. In this case, specify a range by specifying variable values in both the left and right text boxes.

If the right-hand text box is blank, then access locations with the fixed variable values specified in the left-hand text box will be searched for.

(3) [Search range] area

(a) [Number]

Specify the range within the trace data to search via the number displayed in the [Number] area of the Trace panel [IECUBE][Simulator].

Specify the starting number in the left text box, and the ending number in the right text box ("0" to "last number" are specified by default).

You can either type the numbers directly into the text boxes (in base-10 format), or select them from the input history via the drop-down lists (up to 10 items).

If the left-hand text box is left blank, it is treated as if "0" were specified.

If the right-hand text box is left blank, it is treated as if the last number were specified.

[Function buttons]

Button	Function
Search Backward	Searches upward (in the direction of larger to smaller numbers) within the specified range. Search matches are selected in the Trace panel [IECUBE][Simulator]. Note that if an illegal value is specified, a message will be appear, and the trace data search will not be performed. If focus moves to this dialog box while the Trace panel is hidden or another panel has focus, then this button will be disabled.
Search Forward	Searches forward (in the direction of smaller to larger numbers) within the specified range. Search matches are selected in the Trace panel [IECUBE][Simulator]. Note that if an illegal value is specified, a message will be appear, and the trace data search will not be performed. If focus moves to this dialog box while the Trace panel is hidden or another panel has focus, then this button will be disabled.
Cancel	Cancels the trace data search and closes this dialog box.
Help	Displays the help for this dialog box.

Go to the Location dialog box

This dialog box is used to move the caret to a specified position.

Figure A-43. Go to the Location Dialog Box (for Editor Panel)

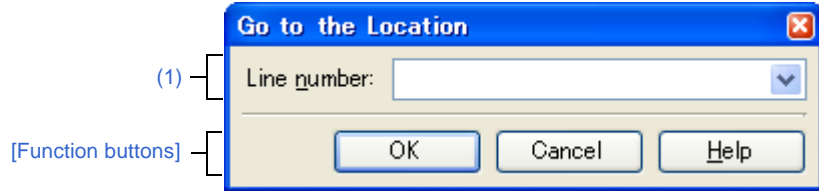

This section describes the following.

- [How to open]
- [Description of each area]
- [Function buttons]

[How to open]

- From the [Edit] menu, select [Move to...].
- On the [Editor panel](#), select [Move to...] from the context menu.
- On the [Disassemble panel](#), select [Move to...] from the context menu.
- On the [SFR panel](#), select [Move to...] from the context menu.

[Description of each area]

(1) [Line number], [Address/Symbol], or [SFR] area

Specify the location to which the caret is jump.

You can either type a location directly into the text box, or select one from the input history via the drop-down list (up to 10 items).

The data to specify various depending on the target panel, as follows:

Target Panel	Data Specified
Editor panel	Line number (base-10)
Disassemble panel	Address expression
SFR panel	SFR name

[Function buttons]

Button	Function
OK	Moves the caret to the specified location, from the beginning of the area displayed in the target panel.
Cancel	Cancels the jump and closes this dialog box.
Help	Displays the help for this dialog box.

Data Save dialog box

This dialog box is used to save data displayed in the [Disassemble panel](#), [Memory panel](#), or [Trace panel](#) [[IECUBE](#)][[Simulator](#)], and save uploaded data (see "2.5.3 [Execute uploading](#)").
 This dialog box only appears when connected to the debug tool.

Figure A-44. Data Save Dialog Box

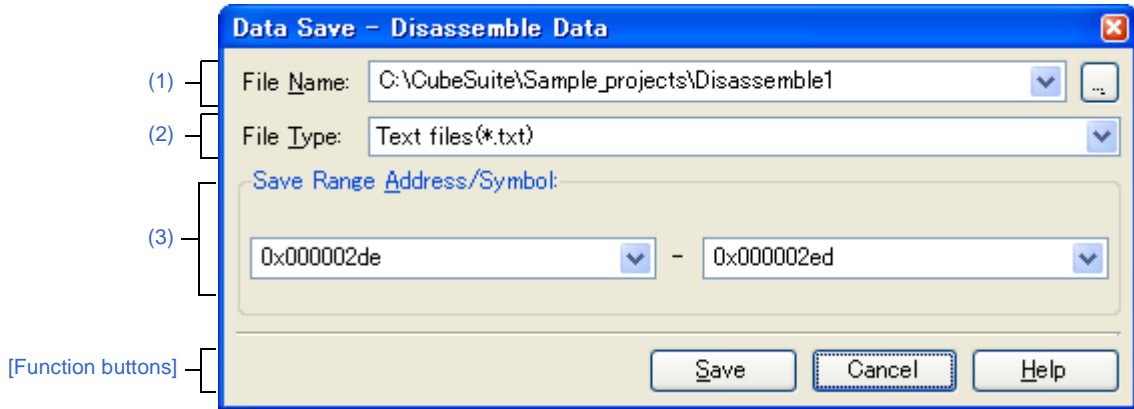

This section describes the following.

- [[How to open](#)]
- [[Description of each area](#)]
- [[Function buttons](#)]

[How to open]

- With the [Disassemble panel](#) in focus, select [[Save Disassemble Data As...](#)] form the [[File](#)] menu.
- With the [Memory panel](#) in focus, select [[Save Memory Data As...](#)] form the [[File](#)] menu.
- With the [Trace panel](#) [[IECUBE](#)][[Simulator](#)] in focus, select [[Save Trace Data As...](#)] form the [[File](#)] menu.
- From the [[Debug](#)] menu, select [[Upload...](#)].

[Description of each area]

(1) [File Name] area

Specify the name of the file to save.

You can either type a filename directly into the text box (up to 259 characters), or select one from the input history via the drop-down list (up to 10 items).

You can also specify the file by clicking the [...] button, and selecting a file via the [Select Data Save File dialog box](#).

(2) [File Type] area

Select the format in which to save the file from the following drop-down list.

The available file formats will differ as follows depending on the type of data being saved.

(a) Saving the data displayed in a panel

Text files (*.txt)	Text format (default)
CSV (Comma-Separated Variables) (*.csv)	CSV format ^{Note}

Note The data is saved with entries separated by commas (,).
If the data contains commas, each entry is surrounded by double quotes (") in order to avoid illegal formatting.

(b) Saving upload data

See "Table 2-2. Type of Files That Can be Uploaded".

(3) [Save Range xxx] area

Specify the range of data to save.

You can either type ranges directly into the text boxes, or select them from the input history via the drop-down lists (up to 10 items).

The method of specifying the ranges will differ as follows depending on the type of data to be saved.

Type of Data	Description
Disassemble panel	Specify the range of addresses to save via the start and end addresses. Ranges can be entered as base-16 numbers or as address expressions. When a range is selected in the panel, that range is specified by default. When there is no selection, then the range currently visible in the panel is specified.
Memory panel	Specify the range of memory to save via the start and end addresses. Ranges can be entered as base-16 numbers or as address expressions. When a range is selected in the panel, that range is specified by default. When there is no selection, then the range currently visible in the panel is specified.
Trace panel [IECUBE][Simulator]	- Specifying a range to save Specify the trace range to save via the start and end trace numbers ^{Note 1} . Ranges can only be entered as base-10 numbers. - Saving all trace data From the drop-down list to the left, select [All Trace Data]. The text box to the right is disabled. All currently acquired trace data will be saved. The range currently visible in the panel is specified by default.
Upload data	Specify the range of memory to save via the start and end addresses ^{Note 2} . Ranges can be entered as base-16 numbers or as address expressions.

Notes 1. These are the numbers shown in the [\[Number\] area](#) of the Trace panel.

2. When a 0x10000 or higher address is specified as the end address, the data is saved for memory banks (see "2.5.3 Execute uploading").

[Function buttons]

Button	Function
Save	Saves the data to a file with the specified filename, in the specified format.
Cancel	Cancel the save and closes this dialog box.
Help	Displays the help for this dialog box.

Progress Status dialog box

This dialog box is used to display the progress of long processes.
 This dialog box closes automatically when the currently executing process completes.

Figure A-45. Progress Status Dialog Box

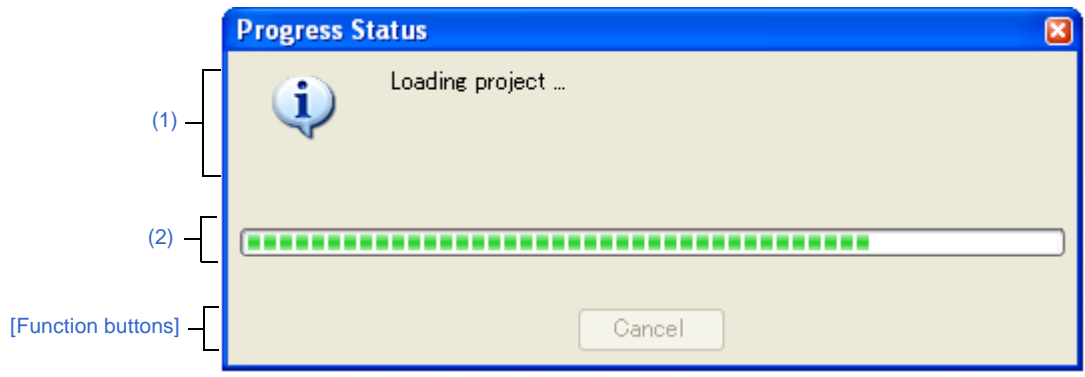

This section describes the following.

- [How to open]
- [Description of each area]
- [Function buttons]

[How to open]

- This dialog box appears automatically when a message is displayed during a long process.

[Description of each area]

(1) Message display area

Displays messages during processing (cannot be edited).

(2) Progress bar

The amount of progress mad toward completing the current progress is indicated by the length of the bar.

The dialog box will automatically close when the progress reaches 100% (the length of the bar reaches the right end).

[Function buttons]

Button	Function
Cancel	Cancels the currently executing process, and closes this dialog box. Note that this button will be disabled if the currently executing process cannot be interrupted.

Option dialog box

This dialog box is used to configure the CubeSuite environment.
 All settings made via this dialog box are saved as preferences for the current user.

Figure A-46. Option Dialog Box

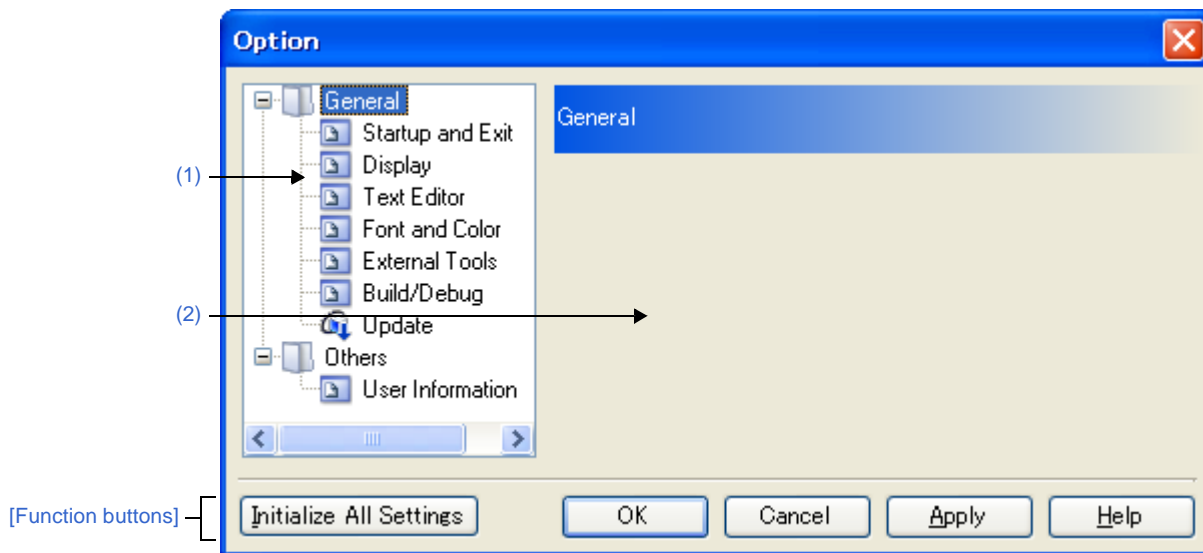

This section describes the following.

- [How to open]
- [Description of each area]
- [Function buttons]

[How to open]

- From the [Tool] menu, select [Option...].

[Description of each area]

(1) Category selection area

Select the items to configure from the following categories.

Category	Description
[General - Startup and Exit] category	Configure startup and shutdown.
[General - Display] category	Configure messages from the application.
[General - Text Editor] category	Configure the text editor.
[General - Font and Color] category	Configure the fonts and colors shown on each panel.
[General - External Tools] category	Configure the startup of external tools.
[General - Build/Debug] category	Configure building and debugging.
[General - Update] category	Configure updating.
[Others - User Information] category	Configure user information.

(2) Setting area

This area is used to configure the various options for the selected category.

For details about configuration for a particular category, see the section for the category in question.

[Function buttons]

Button	Function
Initialize All Settings	Restore all settings on this dialog box to their default values. Note, however, that newly added items in the [General - External Tools] category will not be removed.
OK	Apply all setting and closes this dialog box.
Cancel	Ignore the setting and closes this dialog box.
Apply	Apply all setting (does not close this dialog box).
Help	Display the help of this dialog box.

[General - Font and Color] category

Use this category to configure general settings relating to fonts and colors on each panel.

Figure A-47. Option Dialog Box ([General - Font and Color] Category)

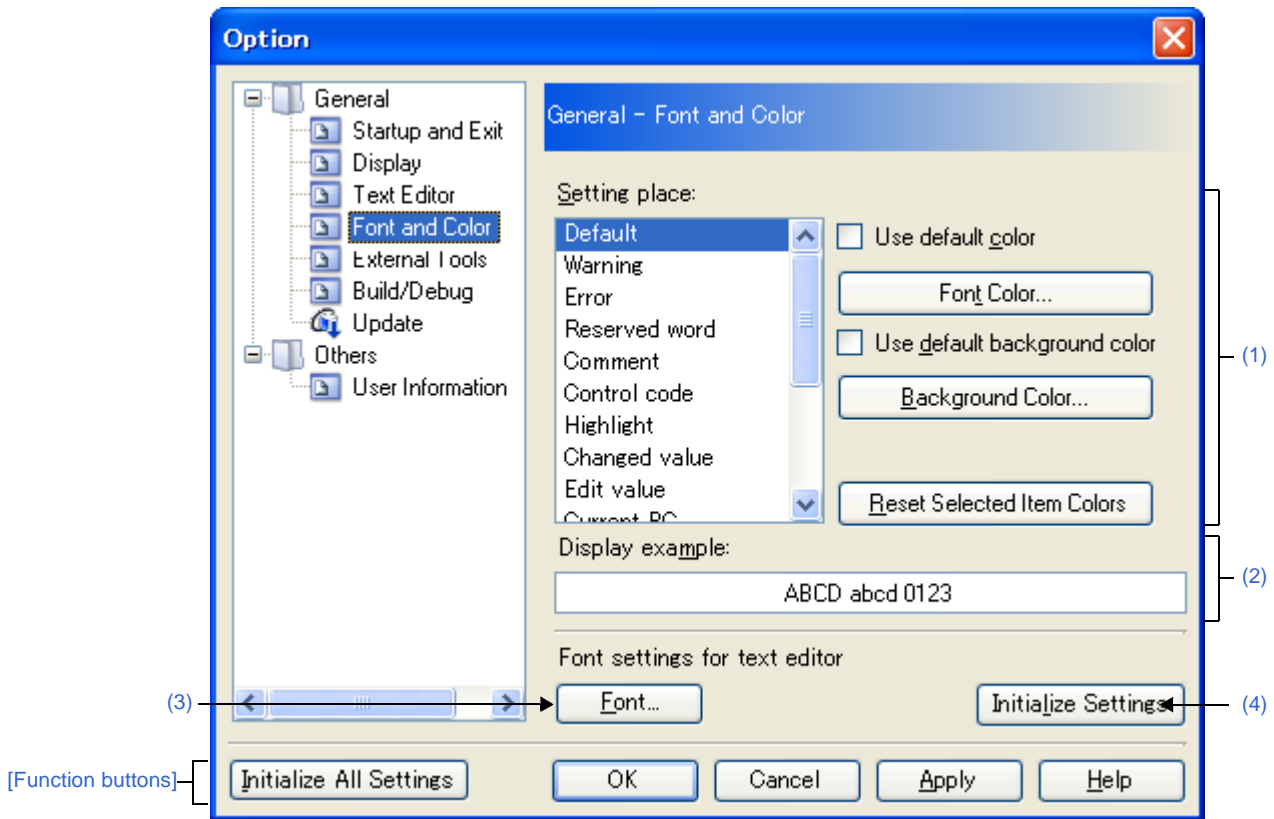

The following items are explained here.

- [How to open]
- [Description of each area]
- [Function buttons]

[How to open]

- From the [Tool] menu, select [Option...].

[Description of each area]

(1) Color options area

Use this area to configure the colors.

(a) [Setting place] area

Select a location from the list for which the color will be specified.

The relationships between the list items and default color settings are as follows:

Item	Example		Description	
Default ^{Note}	AaBbCc	Font color	Black	The standard display color in all windows and panels.
		Background color	White	
Warning	AaBbCc	Font color	Blue	Warning messages are displayed in this color in the Output panel , and file names with warnings are displayed in this color in the Project Tree panel .
		Background color	Default color	
Error	AaBbCc	Font color	Red	Error messages are displayed in this color in the Output panel , and file names with errors are displayed in this color in the Project Tree panel .
		Background color	Whitesmoke	
Reserved word	AaBbCc	Font color	Maroon	The reserved words of your compiler/assembler are displayed in this color in the Editor panel .
		Background color	Default color	
Comment	AaBbCc	Font color	Green	Comments (in the case of a C source file, "/* ... */") are displayed in this color in the Editor panel .
		Background color	Default color	
String literal	AaBbCc	Font color	Gray	String literals are displayed in this color in the Editor panel .
		Background color	Default color	
Control code	AaBbCc	Font color	Darkcyan	Control characters are displayed in this color in the Editor panel .
		Background color	Default color	
Highlight	AaBbCc	Font color	White	Highlighted areas in plug-in products and the like are displayed in this color.
		Background color	Mediumvioletred	
Changed value	AaBbCc	Font color	Sienna	Values changed via the execution of a program are displayed in this color in the Memory panel , CPU Register panel , Local Variables panel , SFR panel and Watch panel .
		Background color	Lightyellow	
Edit value	AaBbCc	Font color	Blue	Values forcibly modified by user are displayed in this color in the Memory panel , CPU Register panel , Local Variables panel , SFR panel and Watch panel .
		Background color	Default color	
Current PC	AaBbCc	Font color	Black	The line with the current PC position is displayed in this color in the Editor panel and Disassemble panel .
		Background color	Gold	
Breakpoint	AaBbCc	Font color	Black	The line at which a breakpoint is set is displayed in this color in the Editor panel and Disassemble panel .
		Background color	Lightsalmon	
Update periodic	AaBbCc	Font color	Deeppink	Areas configured for real-time display updates are shown in this color in the Memory panel and Watch panel .
		Background color	Default color	

Item	Example		Description	
Read or fetch		Font color	Default color	Locations that have been read or fetched are displayed in this color in the Trace panel [IECUBE][Simulator] .
		Background color	Palegreen	
Write		Font color	Default color	Locations that have been written are displayed in this color in the Trace panel [IECUBE][Simulator] .
		Background color	Orange	
Read and write		Font color	Default color	Locations that have been read and written are displayed in this color in the Trace panel [IECUBE][Simulator] .
		Background color	Paleturquoise	
Coverage 100%		Font color	Default color	The line for which code coverage is at 100 % is displayed in this color in the Editor panel and Disassemble panel .
		Background color	Lightgreen	
Coverage 1 - 99%		Font color	Default color	The line for which code coverage is at 1 to 99 % is displayed in this color in the Editor panel and Disassemble panel .
		Background color	Lightpink	
Coverage 0%		Font color	Default color	The line for which code coverage is at 0 % (not yet executed) is displayed in this color in the Editor panel and Disassemble panel .
		Background color	Lightgray	
Invalid		Font color	Gray	Non-mapped areas in the Memory panel and filenames in the Project Tree panel that do not actually exist are displayed in this color.
		Background color	Default color	

Note The [Default] text and background colors depends on the Windows settings of the host computer. Here, we use the Windows defaults, which are black text and white background.

(b) [Use default color]

<input checked="" type="checkbox"/>	Display items selected via the [Setting place] area using the standard text color.
<input type="checkbox"/>	Display items selected via the [Setting place] area with a user-defined text color. The [Font color...] button is enabled.

(c) [Use default background color]

<input checked="" type="checkbox"/>	Display items selected via the [Setting place] area using the standard background color.
<input type="checkbox"/>	Display items selected via the [Setting place] area with a user-defined background color. The [Background Color...] button is enabled.

(d) Buttons

Font Color...	The Edit Colors Dialog Box opens. Specify the text color of the item selected via the [Setting place] area. Note, however, that this button will be disabled if the [Use default color] check box is selected.
Background Color...	The Edit Colors Dialog Box opens. Specify the background color of the item selected via the [Setting place] area. Note, however, that this button will be disabled if the [Use default background color] check box is selected.
Reset Selected Item Colors	Reset the color information for the item selected via the [Setting place] area to the defaults.

Figure A-48. Edit Colors Dialog Box

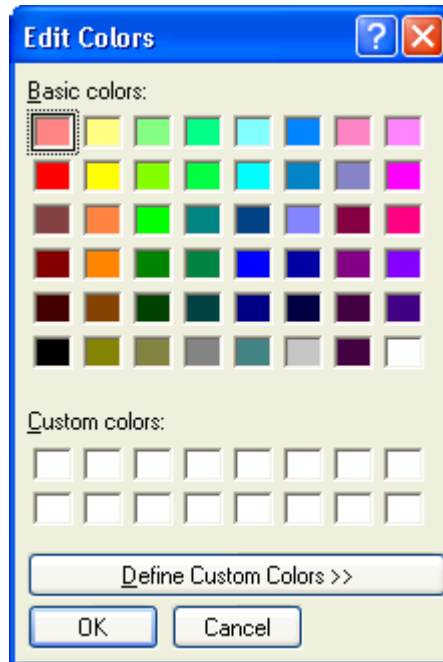

(2) **[Display example] area**

Display sample text using the color and font settings from the [Color options area](#) and the [\[Font settings for text editor\] area](#).

By default the string "AaBbCc" is shown, but you can type an arbitrary string directly into the text box.

(3) **[Font settings for text editor] area**

Click the [\[Font...\]](#) button to open the [Font Dialog Box](#) and configure the fonts for your text editor.

Figure A-49. Font Dialog Box

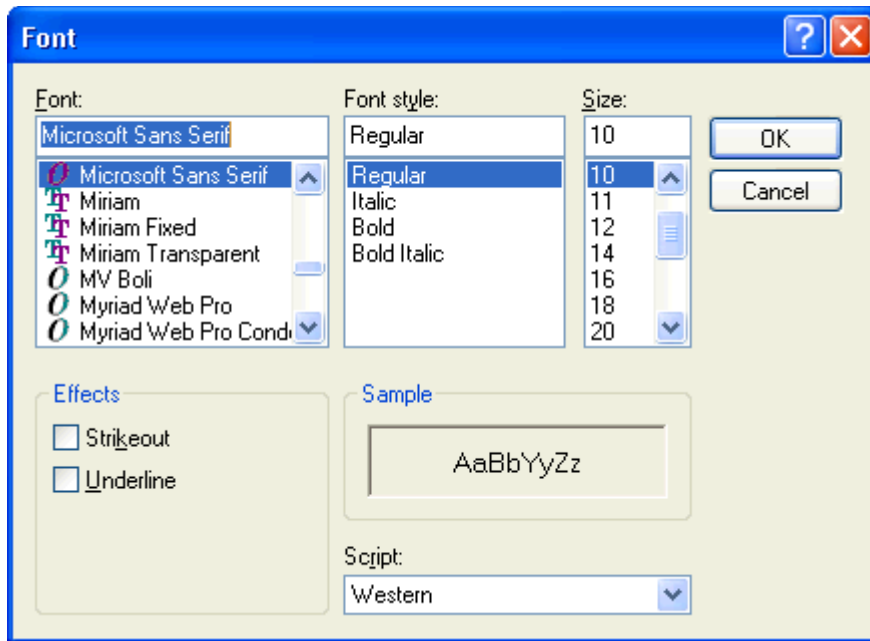

(4) Buttons

Initialize Settings	Returns all currently displayed setting to their default values.
---------------------	--

[Function buttons]

Button	Function
Initialize All Settings	Restore all settings on this dialog box to their default values. Note, however, that newly added items in the [General - External Tools] category will not be removed.
OK	Apply all setting and closes this dialog box.
Cancel	Ignore the setting and closes this dialog box.
Apply	Apply all setting (does not close this dialog box).
Help	Display the help of this dialog box.

[General - Build/Debug] category

Use this category to configure general setting relating to building and debugging.

Figure A-50. Option Dialog Box ([General - Build/Debug] Category)

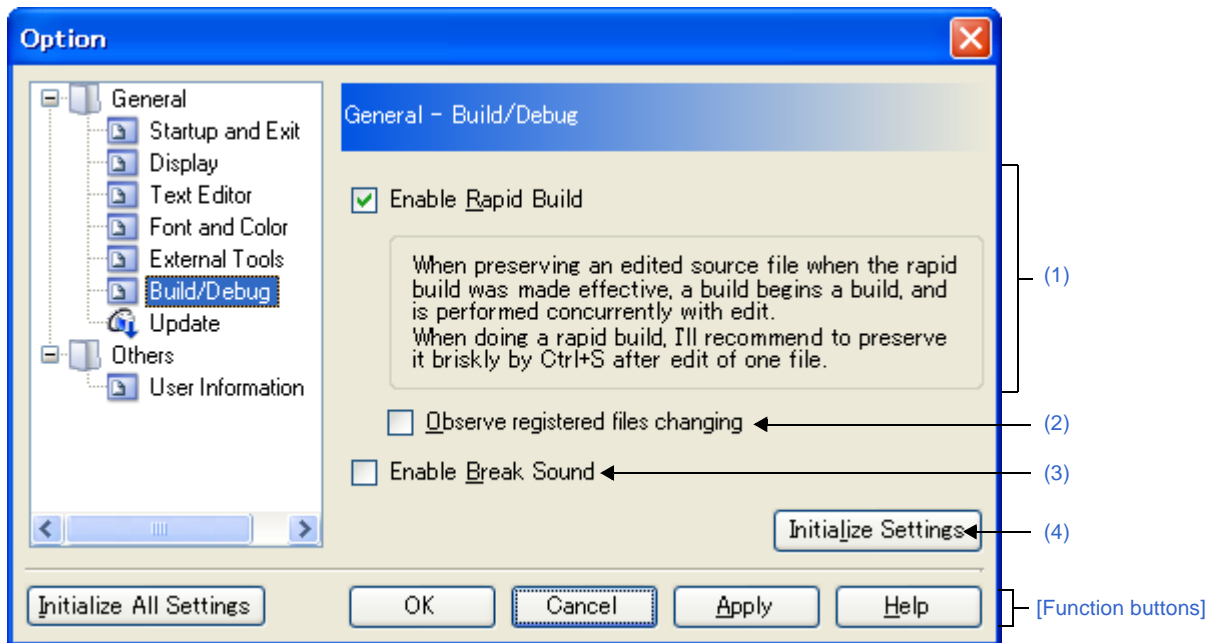

The following items are explained here.

- [How to open]
- [Description of each area]
- [Function buttons]

[How to open]

- From the [Tool] menu, select [Option...].

[Description of each area]

(1) [Enable Rapid Build]

<input checked="" type="checkbox"/>	Enable the rapid build ^{Note} feature (default).
<input type="checkbox"/>	Do not use the rapid build feature.

Note This feature automatically begins a build when the source file being edited is saved. Enabling this feature makes it possible to perform builds while editing source files. If this feature is used, we recommend saving frequently after editing source files.

(2) [Observe registered files changing]

This item is only enabled if the [\[Enable Rapid Build\]](#) check box is selected.

<input checked="" type="checkbox"/>	Start a rapid build when a source file registered in the project is edited or saved by an external text editor or the like.
<input type="checkbox"/>	Do not start a rapid build when a source file registered in the project is edited or saved by an external text editor or the like (default).

Caution Files that are in the project folder and have been registered to the project can be monitored. The rapid build will not finish if this item is selected, and the files to be built have been registered for automatic editing or overwriting (e.g. by commands executed before or after the build).
If the rapid build does not finish, unselect this item, and stop the rapid build.

(3) [Enable Break Sound]

<input checked="" type="checkbox"/>	Beep when the execution of a program is halted due to a break event (Hardware or Software break).
<input type="checkbox"/>	Do not beep when the execution of a program is halted due to a break event (Hardware or Software break) (default).

(4) Buttons

Initialize Settings	Return all currently displayed setting to their default values.
---------------------	---

[Function buttons]

Button	Function
Initialize All Settings	Restore all settings on this dialog box to their default values. Note, however, that newly added items in the [General - External Tools] category will not be removed.
OK	Apply all setting and closes this dialog box.
Cancel	Ignore the setting and closes this dialog box.
Apply	Apply all setting (does not close this dialog box).
Help	Display the help of this dialog box.

Select Download File dialog box

This dialog box is used to select a downloaded file.

Figure A-51. Select Download File Dialog Box

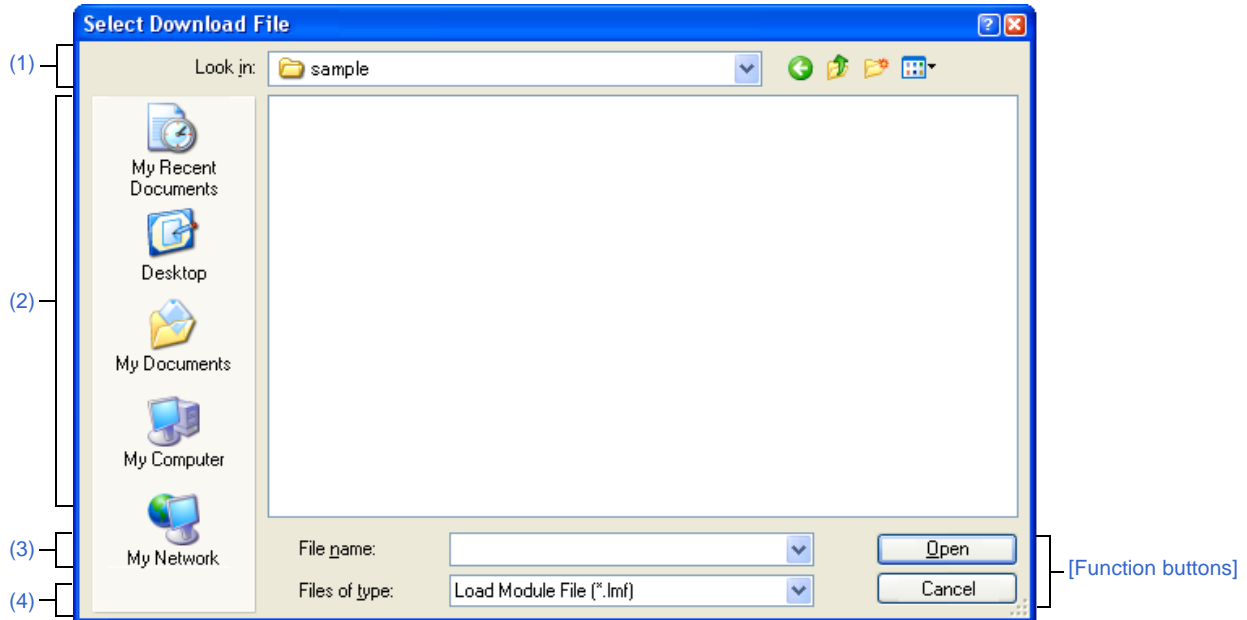

This section describes the following.

- [How to open]
- [Description of each area]
- [Function buttons]

[How to open]

- On the [Download file property] area in the [Download Files dialog box](#), click the [...] button on the [File] item.

[Description of each area]

(1) [Look in] area

Select the folder in which the downloaded file is located from the drop-down list.

(2) List of files area

This area displays a list of files matching the conditions selected in the [Look in] and [Files of type] areas.

(3) [File name] area

Specify the name of the downloaded file.

(4) [Files of type] area

Select the type of the file from the following drop-down list.

Load module file (*.lmf)	Load module format (default)
Hex file (*.hex;*.hxb;*.hxf)	Hex format
Binary data file (*.bin)	Binary format
All files (*.*)	All file formats

[Function buttons]

Button	Function
Open	Adds the specified file to the Download Files dialog box .
Cancel	Closes the dialog box.

Save As dialog box

This dialog box is used to save the contents of the panel into a specified file.

Figure A-52. Save As Dialog Box

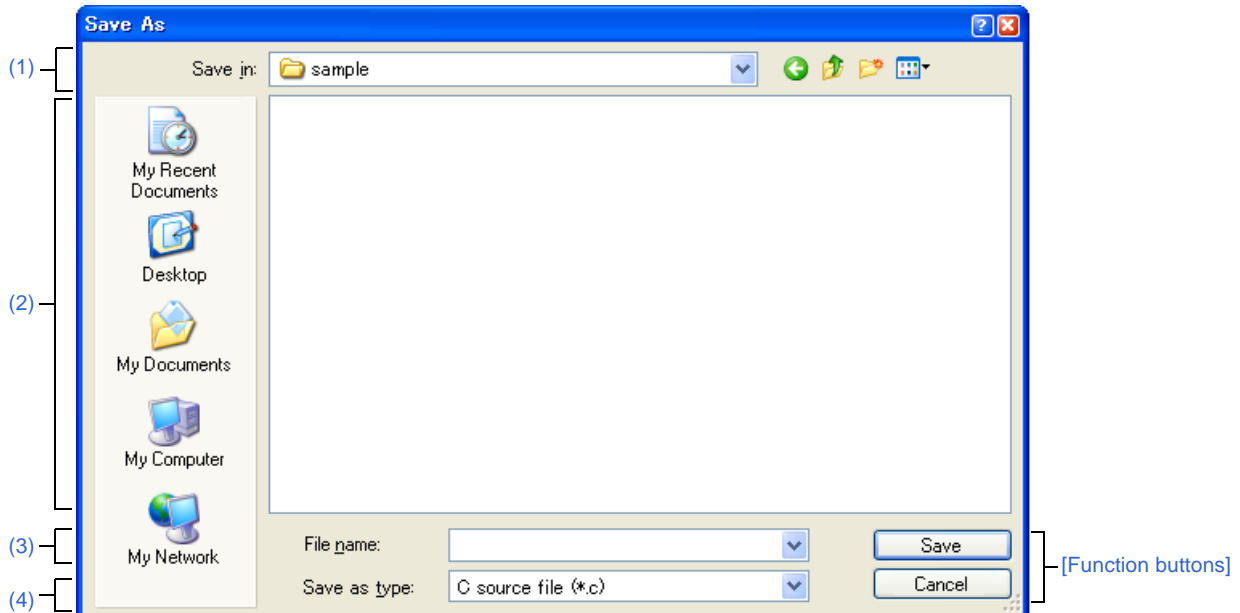

This section describes the following.

- [How to open]
- [Description of each area]
- [Function buttons]

[How to open]

- With the [Editor panel](#) in focus, select [Save file name As...] from the [File] menu.
- With the [CPU Register panel](#) in focus, select [Save CPU Register Data As...] from the [File] menu.
- With the [Watch panel](#) in focus, select [Save Watch Data As...] from the [File] menu.
- With the [SFR panel](#) in focus, select [Save SFR As...]. from the [File] menu.
- With the [Call Stack panel](#) in focus, select [Save Call Stack Data As...] from the [File] menu.
- With the [Local Variables panel](#) in focus, select [Save Local Variable Data As...] from the [File] menu.
- With the [Output panel](#) in focus, select [Save tab name As...] from the [File] menu.

[Description of each area]

(1) [Save in] area

Select the folder in which the file is saved from the drop-down list.

(2) List of files area

This area displays a list of files matching the conditions selected in the [Save in] and [Save as type] areas.

(3) [File name] area

Specify the name of the file to save.

(4) [Save as type] area

(a) Editor panel

The following file types are displayed depending on the file being edited.

Text file (*.txt)	Text format
C source file (*.c)	C language source file
Header file (*.h;*.inc)	Header file
Assemble file (*.asm)	Assembly language source file
Link directive file (*.dr;*.dir)	Link directive file
Function information file (*.fin)	Function information file
Map file (*.map)	Map file
Symbol table file (*.sym)	Symbol table file
Hex file (*.hex;*.hxb;*.hxf)	Hex file

(b) CPU Register panel/Watch panel/SFR panel/Call Stack panel/Local Variables panel

The following file types are displayed.

Select the format in which to save the file from the drop-down list.

Text file (*.txt)	Text format (default)
CSV (Comma-Separated Variables)(*.csv)	CSV format ^{Note}

Note The data is saved with entries separated by commas (,).

If the data contains commas, each entry is surrounded by double quotes (" ") in order to avoid illegal formatting.

(c) Output panel

The following file types are displayed.

The contents can be saved only in text format.

Text file (*.txt)	Text format (default)
-------------------	-----------------------

[Function buttons]

Button	Function
Save	Saves the file with the specified name.
Cancel	Closes the dialog box.

Select Data Save File dialog box

This dialog box is used to select a saved data file.

Figure A-53. Select Data Save File Dialog Box

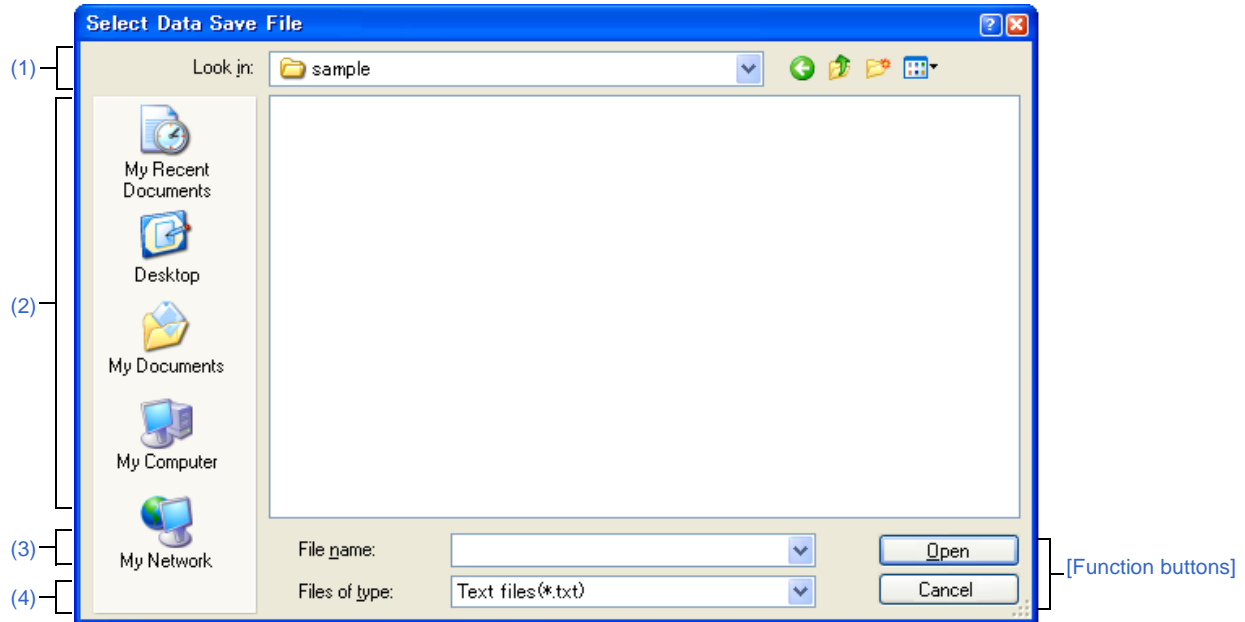

This section describes the following.

- [How to open]
- [Description of each area]
- [Function buttons]

[How to open]

- On the [File Name] area in the [Data Save dialog box](#), click the [...] button.

[Description of each area]

(1) [Look in] area

Select the folder in which the file is located from the drop-down list.

(2) List of files area

This area displays a list of files matching the conditions selected in the [Look in] and [Files of type] areas.

(3) [File name] area

Specify the name of the file to save.

(4) [Files of type] area

Select the type of the file from the following drop-down list.

The available file formats will differ as follows depending on the type of data being saved.

(a) Saving the data displayed in a panel

Text files (*.txt)	Text format (default)
CSV (Comma-Separated Variables)(*.csv)	CSV format ^{Note}

Note The data is saved with entries separated by commas (,).

If the data contains commas, each entry is surrounded by double quotes (" ") in order to avoid illegal formatting.

(b) Saving upload data

See "[Table 2-2. Type of Files That Can be Uploaded](#)".

[Function buttons]

Button	Function
Open	Specifies the specified file in the Data Save dialog box .
Cancel	Closes the dialog box.

Select Simulator Configuration File dialog box [Simulator]

This dialog box is used to select the simulator configuration file to perform use customization (adding of user models) of the simulator.

Figure A-54. Select Simulator Configuration File Dialog Box

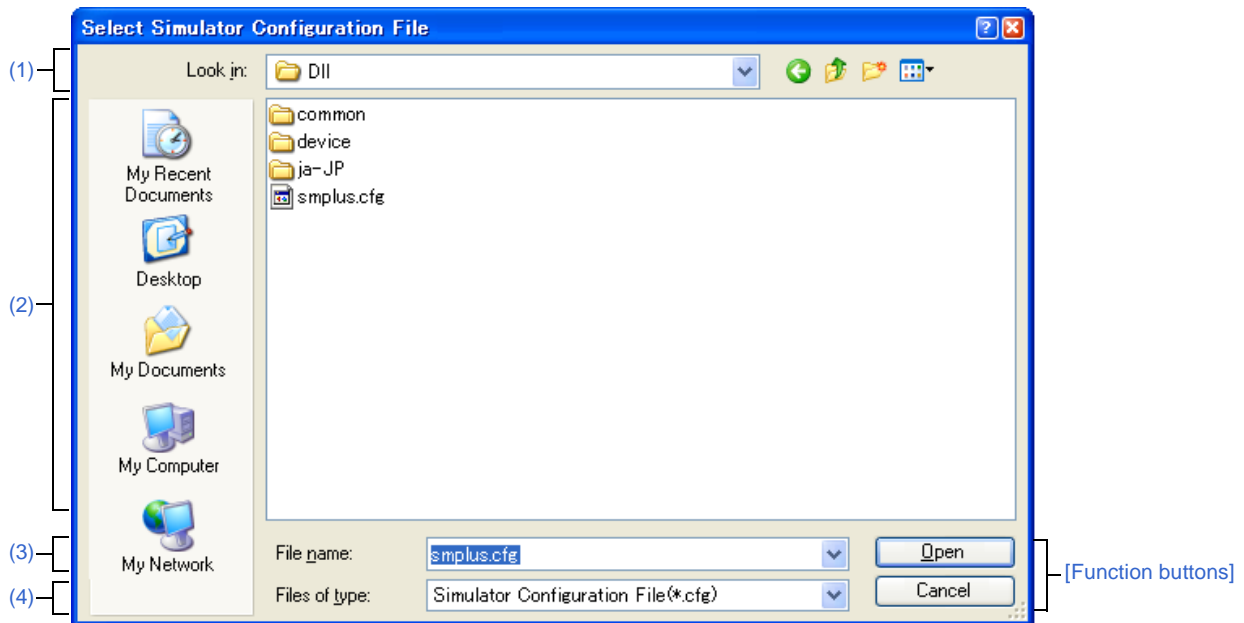

This section describes the following.

- [How to open]
- [Description of each area]
- [Function buttons]

[How to open]

- On the [Connect Settings] tab of the Property panel, click the [...] button displayed by selecting the [Simulator configuration file] property in the [Configuration] category.

[Description of each area]

(1) [Look in] area

Select the folder in which the simulator configuration file is located from the drop-down list.

(2) List of files area

This area displays a list of files matching the conditions selected in the [Look in] and [Files of type] areas.

(3) [File name] area

Specify the name of the simulator configuration file to be use.

(4) [Files of type] area

Select the type of the file from the drop-down list.

Note that it is fixed to "Simulator Configuration File (*.cfg)".

[Function buttons]

Button	Function
Open	Uses the specified simulator configuration file.
Cancel	Closes the dialog box.

Simulator GUI window

This window appears automatically by default after connecting to the debug tool when a microcontroller whose Simulator supports peripheral function simulations is selected and [Simulator] is selected as the debug tool to use (see "2.17 Use the Simulator GUI [Simulator]").

In Simulator GUI, other windows (Signal Data Editor window, Timing Chart window, I/O Panel window, and Serial window) are manipulated from this window.

- Cautions 1.** When a microcontroller whose Simulator does not support peripheral function simulations (instruction simulation version) is selected, this window cannot be opened.
- 2.** This window and windows opened from it cannot be docked to the CubeSuite Main window.
- 3.** The help for this window will not be displayed even if the [F1] key on the keyboard is pressed when no window opened from this window is opened.
To open the help for this window, select the [Help] menu >> [Main Window] on this window.
- 4.** The [x] button on this window's titlebar is invalid (it is invalid even if using the Aero function of Windows Vista). If you wish to close this window, perform the configuration of the Property panel (see "2.17 Use the Simulator GUI [Simulator]").
In addition, do not use the [Alt] + [F4] key to close this window.

Remark The language of titlebar/menubar of this window and windows opened from it depends on the setting of [Regional and Language Options] in [Control Panel] of the host machine used (if this setting is set to [Japan]/[Japanese], their titlebar/menubar are displayed in Japanese).

Figure A-55. Simulator GUI Window

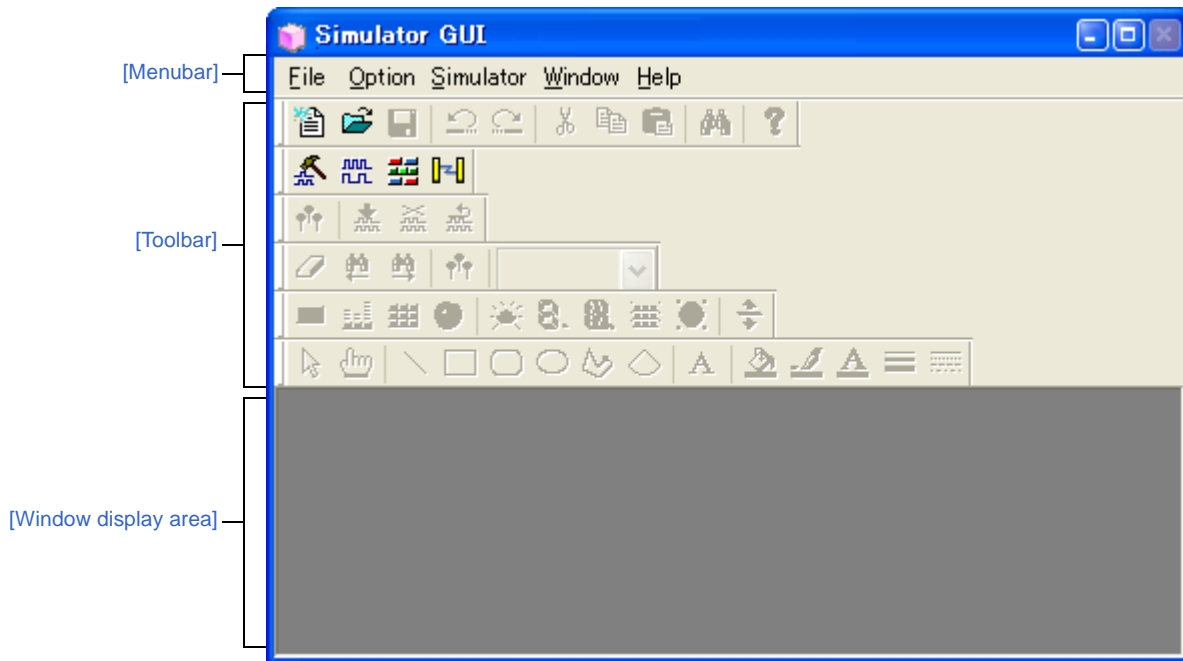



This section describes the following.

- [Menubar]
- [Toolbar]
- [Window display area]

[Menubar]

- (1) [File] menu
- (2) [Edit] menu
- (3) [View] menu
- (4) [Parts] menu
- (5) [Figure] menu
- (6) [Option] menu
- (7) [Simulator] menu
- (8) [Window] menu
- (9) [Help] menu

(1) [File] menu

New File...	Opens a new window for the Simulator GUI window. Same operation as the  button.
Open...	Opens the files handled in the Simulator GUI window. Same operation as the  button.
Close	Closes the window currently having the focus.
Save	Overwrites the contents of the window currently having the focus to the file handled in the Simulator GUI window. Same operation as the  button.
Save As...	Saves the contents of the window currently having the focus to the specified file.

(2) [Edit] menu

This menu varies depending on the window currently having the focus.

For details on this menu items, see "[Dedicated menu]" section in the [Signal Data Editor window](#), [Timing Chart window](#), [I/O Panel window](#), or [Serial window](#).

(3) [View] menu

This menu varies depending on the window currently having the focus.

For details on this menu items, see "[Dedicated menu]" section in the [Signal Data Editor window](#), [Timing Chart window](#), [I/O Panel window](#), or [Serial window](#).

(4) [Parts] menu

This menu is added when the [I/O Panel window](#) is opened.

For details on this menu items, see the [\[Parts\] menu/\[Parts\] toolbar](#).

(5) [Figure] menu





This menu is added when the [I/O Panel window](#) is opened.

For details on this menu items, see the [\[Figure\] menu/\[Figure\] toolbar](#).

(6) [Option] menu

ToolBar	Switches on/off display of the toolbar corresponding to the cascade menu.
Simulator Standard	Selects whether the [Simulator Standard] toolbar is displayed or not.
Simulator Tools	Selects whether the [Simulator Tool] toolbar is displayed or not.
Signal Data Editor	Selects whether the [Signal Data Editor] toolbar is displayed or not.
Timing Chart	Selects whether the [Timing Chart] toolbar is displayed or not.
Parts	Selects whether the [Parts] toolbar is displayed or not.
Figure	Selects whether the [Figure] toolbar is displayed or not.
Customize...	Opens the Customize dialog box .

(7) [Simulator] menu

Signal Data Editor	Opens the Signal Data Editor window . Same operation as the  button.
Timing Chart	Opens the Timing Chart window . Same operation as the  button.
I/O Panel	Opens the I/O Panel window . Same operation as the  button.
Serial	Opens the Serial window . Same operation as the  button.

(8) [Window] menu

Close All	Closes all windows, except this window.
Cascade	Cascade display of the windows in this window.
Tile	Cascade display of the windows in this window.
Arrange Icons	Rearranges the icons in this window.











(9) [Help] menu

Main Window	Displays the help for this window.
Current Window	Displays the help for the current window.





[Toolbar]

- (1) [\[Simulator Standard\] toolbar](#)
- (2) [\[Simulator Tool\] toolbar](#)
- (3) [\[Signal Data Editor\] toolbar](#)
- (4) [\[Timing Chart\] toolbar](#)
- (5) [\[Parts\] toolbar](#)
- (6) [\[Figure\] toolbar](#)

(1) [Simulator Standard] toolbar

	Opens a new window for the Simulator GUI window.
	Opens the files handled in the Simulator GUI window.
	Overwrites the contents of the window currently having the focus to the file handled in the Simulator GUI window.
	Undoes the immediately preceding operation.
	Restores the status undone by the  button.
	Cuts the selected range and saves it to the clipboard.
	Copies the selected range and saves it to the clipboard.
	Pastes the clipboard contents.
	Opens the Search Data dialog box .
	Displays the contents of the help.

(2) [Simulator Tool] toolbar

	Opens the Signal Data Editor window .
	Opens the Timing Chart window .
	Opens the Serial window .
	Opens the I/O Panel window .

(3) [Signal Data Editor] toolbar

This toolbar can be used when the [Signal Data Editor window](#) has the focus.
For details on this toolbar, see the [\[Signal Data Editor toolbar\]](#).

(4) [Timing Chart] toolbar

This toolbar can be used when the [Timing Chart window](#) has the focus.
For details on this toolbar, see the [\[Timing Chart toolbar\]](#).

(5) [Parts] toolbar

This toolbar can be used when the [I/O Panel window](#) has the focus.
For details on this toolbar, see the [\[Parts\] menu/\[Parts\] toolbar](#).

(6) [Figure] toolbar

This toolbar can be used when the [I/O Panel window](#) has the focus.
For details on this toolbar, see the [\[Figure\] menu/\[Figure\] toolbar](#).

[Window display area]

This area is used to display various windows ([Signal Data Editor window](#), [Timing Chart window](#), [I/O Panel window](#), or [Serial window](#)).

The displayed window can be changed in size or an icon can be created in this area.

Customize dialog box

This dialog box is used to set or change the color and fonts for the [Signal Data Editor window](#), [Timing Chart window](#) or [Serial window](#).

Figure A-56. Customize Dialog Box: [Color] Tab (For The Timing Chart Window)

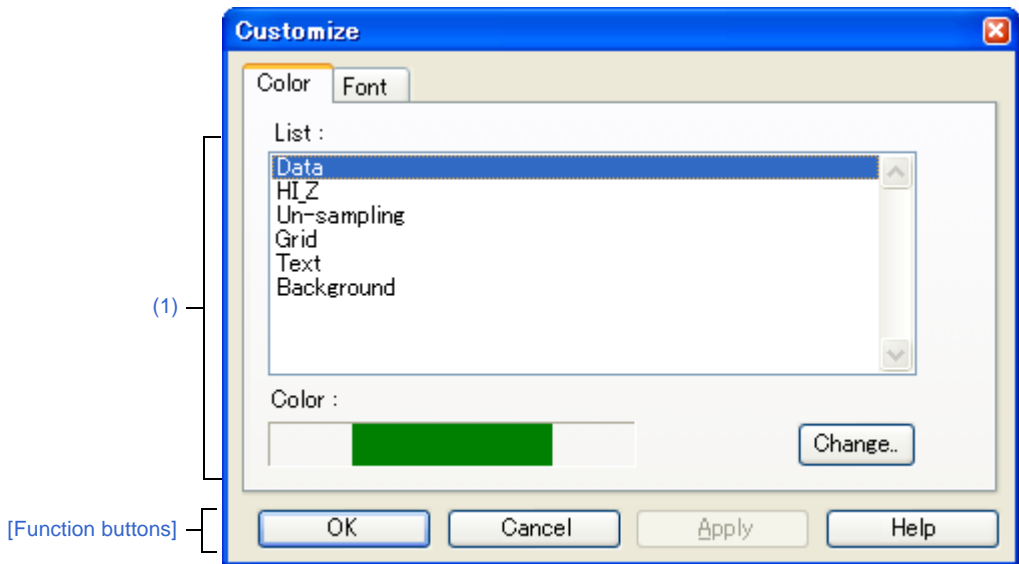
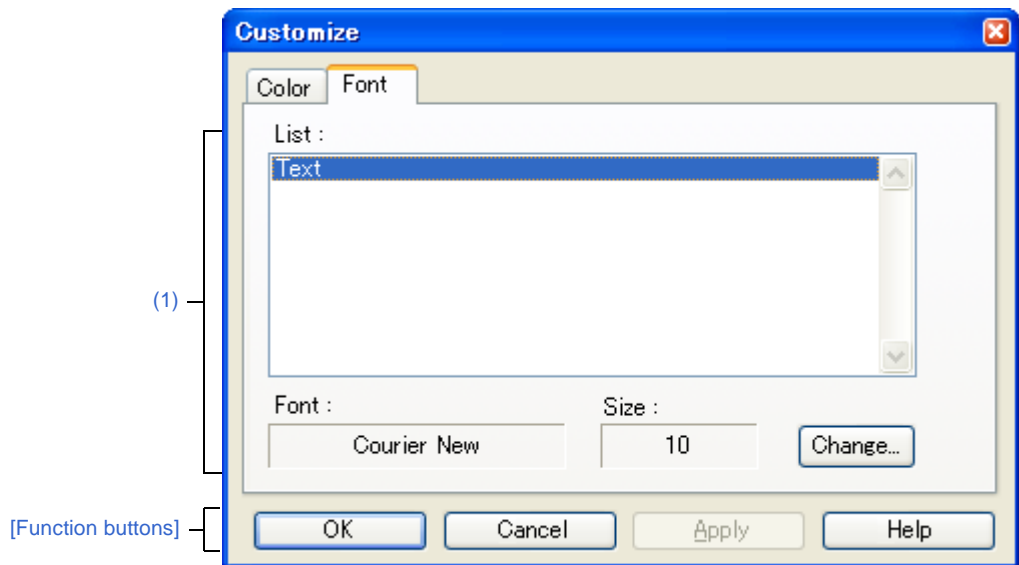

Figure A-57. Customize Dialog Box: [Font] Tab



This section describes the following.

- [How to open]
- [[Color] tab]
- [[Font] tab]
- [Function buttons]

[How to open]

- With the [Signal Data Editor window](#), [Timing Chart window](#) or [Serial window](#) in focus, select [Customize...] from the [Option] menu.

[[Color] tab]

(1) Color setting area

Set and change the color of each part in the window.

List	The parts for which color change is possible are displayed in list form. The parts displayed differ depending on the target window.
Color	The currently set color of the part is displayed when that part is selected from the list.
[Change...] button	The color currently set for the relevant part of each listed item can be changed.

[[Font] tab]

(1) Font setting area

Set and change the text font of each part in the window.

List	The parts for which font change is possible are displayed in list form.
Font	The current font name of the part is displayed, when that part is selected from the list.
Size	The current font size of the part is displayed, when that part is selected from the list.
[Change...] button	The font currently set for the relevant part of each listed item can be changed.

[Function buttons]

Button	Function
OK	Validates the settings and closes this dialog box.
Cancel	Cancels the settings and closes this dialog box.
Apply	Cannot be selected.
Help	Displays the help for this dialog box.

Signal Data Editor window

This window is used to create and edit the signal data that is input to input pins.

The created signal data can be input to the input pin during simulation by selecting the [Edit] menu >> [Signal Input]. This data can also be saved to the signal data file (*.wvi) by selecting the [File] menu >> [Save]/[Save As...] or by saving the project file.

The saved file contents can be restored by selecting the [File] menu >> [Open...] or by loading the project file.

- Cautions 1.** If the saved signal data file is opened or the project file is opened while Simulator GUI is running with a microcontroller different from the one used when the signal data file was created, the settings of pins that are not provided in the microcontroller will not be restored.
- 2.** The main clock and sub clock cannot be input from this window. Set the main clock/sub clock oscillation frequency on the [Connect Settings] tab in the Property panel.
- 3.** If inputting of signals is started during program break, the signals will actually be input when the program is resumed from the break.

- Remarks 1.** The following data can be displayed or edited in this window:
 - Newly created signal data
 - Previously created signal data files
 - File of signal data previously obtained by performing simulation and saving the results as output signal data
- 2.** On the titlebar of this window, "Project file name + Serial number (from 0).wvi" is displayed when the project file has been loaded. However, after having loaded a project file of PM+, then if you save a file as the project file of CubeSuite, "Project file name + CS+ Serial number (from 0).wvi" is displayed on the titlebar.

Figure A-58. Signal Data Editor Window

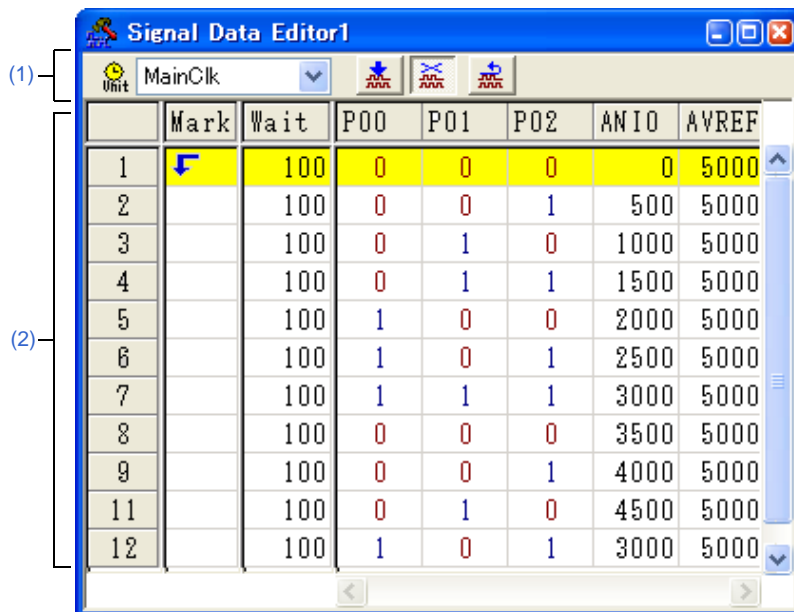

This section describes the following.

- [How to open]
- [Description of each area]
- [Dedicated menu (Signal Data Editor window)]
- [Signal Data Editor toolbar]
- [Context menu]
- [Operation]





[How to open]

- Click the  button
- Select [Signal Data Editor] from the [Simulator] menu.

[Description of each area]

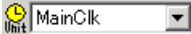
(1) Information bar

It can be specified whether this area is displayed or not, by selecting the [View] menu >> [Information Bar].



	Select the unit of the wait time from the drop-down list. The wait time unit can be changed by selecting the [Edit] menu >> [Time unit].
	If this button is clicked while the program is running, signal input starts. If this button is clicked while the program is stopped, signal input starts automatically the next time the program execution is started.
	If this button is clicked while the program is running, signal input is stopped. If this button is clicked while the program is stopped, signal input does not start automatically even if the program execution is started.
	The current signal input line (line highlighted with yellow) is returned to the beginning.

(2) Client area

	Mark	Wait	P00	P01	RXD0	AN10
1		1024	Z	Z	Z	0
2		128	1	1	0	0
3		128	1	1	0	0
4	16	128	1	1	0	1250
5		128	0	0	1	2500
6		128	1	0	1	4800
7		128	0	0	1	4900
8		128	1	1	1	5000
9		128	0	1	0	5000

Annotations in the image:
 - Pin area: points to the header row (P00, P01, RXD0, AN10)
 - Data area: points to the data rows (lines 1-9)
 - Wait area: points to the Wait column
 - Mark area: points to the Mark column
 - Line number area: points to the line numbers (1-9)

Pin area	Displays the input pin names. The input pin to be used is selected via the Select Pin dialog box opened by clicking the  button on the toolbar or selecting the [Edit] menu >> [Select Pin...]. Data input to pins can be enabled/disabled by selecting the [Edit] menu >> [Pin Status].
----------	---

Line number area	<p>Displays line number.</p> <p>This area is used when performing editing in line units.</p> <p>Note that up to 1,048,576 (= 1M) lines can be specified as the signal data.</p>		
Mark area	<p>Displays the loop information for the specified input value.</p> <p>The loop information is specified by selecting from the context menu or the [Edit] menu >> [Mark] in the relevant field.</p> <p>The following marks are displayed after the loop information has been specified.</p>		
		Loop start location (endless loop)	
		Loop start location (with loop count)	
		Loop end location	
Wait area	<p>Displays as "wait time" the timing at which the specified input value is input to the pins.</p> <p>The wait time is specified by directly writing numeric values in the relevant field.</p> <p>Note that numeric values (decimal code) from 0 to 4,294,967,295 can be specified (values that exceed 4,294,967,295 can be set by using one more line).</p> <p>The wait time unit can be changed by selecting the [Edit] menu >> [Time unit].</p>		
Data area	<p>Displays the input value input to the pins.</p> <p>The input value is specified by directly writing numeric value in the relevant field.</p> <p>Note that the input rules differ as follows according to the pin type.</p>		
	Digital pins	Any one of the following one character	
		0	LOW signal
		1	HIGH signal
		Z	Hi-Z signal (case insensitive)
Analog pins	A decimal value from 0 to 5000 (unit: mV)		

[Dedicated menu (Signal Data Editor window)]

(1) [Edit] menu

Undo	Cannot be selected.
Redo	Cannot be selected.
Cut	Cuts the selected range and saves it to the clipboard.
Copy	Copies the selected range and copies it to the clipboard.
Paste	Pastes the contents of the clipboard to the selected location.
Delete	Deletes the selected range.
Select All	Selects all display data.
Find	Cannot be selected.
Select Pin...	Opens the Select Pin dialog box . The pin(s) for which input signal data is to be created or edited is (are) selected in this dialog box.
Time unit	Selects the wait time unit.
main clock	Main clock (default)
usec	Microsecond
msec	Millisecond

Pin Status	Selects the input status of the selected pin.
Valid	Enables data input to the pin. (default)
Invalid	Disables data input to the pin.
Mark	Sets a mark to the selected Mark area .
Loop Start	Sets the loop start mark.
Loop End	Sets the loop end mark.
Loop Dialog	Opens the Loop dialog box . Sets the details of loop information.
Signal Input	Inputs signal data to the simulator.
Start	Starts signal input.
Stop	Stops signal input.
Reset	Returns the current signal input line to the beginning.





(2) [View] menu

Information Bar	Selects whether the information bar is displayed or not.
-----------------	--

(3) [Option] menu

Customize...	Opens the Customize dialog box .
--------------	--

[Signal Data Editor toolbar]

	Opens the Select Pin dialog box . The pin(s) for which input signal data is to be created or edited is (are) selected in this dialog box.
	If this button is clicked while the program is running, signal input starts. If this button is clicked while the program is stopped, signal input starts automatically the next time the program execution is started.
	If this button is clicked while the program is running, signal input is stopped. If this button is clicked while the program is stopped, signal input does not start automatically even if the program execution is started.
	The current signal input line (line highlighted with yellow) is returned to the beginning.

[Context menu]

The following context menus are available at each area in the [Client area](#).

(1) Pin area

Valid	Enables data input to the pin (default).
Invalid	Disables data input to the pin.
Select Pin...	Opens the Select Pin dialog box . The pin(s) for which input signal data is to be created or edited is (are) selected in this dialog box.

(2) Line number

Cut	Cuts the selected range and saves it to the clipboard.
Copy	Copies the selected range and copies it to the clipboard.
Paste	Pastes the contents of the clipboard to the selected location.
Delete	Deletes the selected range.

(3) Mark area

Cut	Cuts the selected cell and saves it to the clipboard.
Copy	Copies the selected cell and copies it to the clipboard.
Paste	Pastes the contents of the clipboard to the selected location.
Delete	Deletes the selected cell.
Loop Start	Sets the loop start mark.
Loop End	Sets the loop end mark.
Loop Dialog	Opens the Loop dialog box . Sets the details of loop information.

(4) Wait area

Cut	Cuts the data in the selected cell and saves it to the clipboard. The data in the selected cell becomes 0.
Copy	Copies the data in the selected cell and copies it to the clipboard.
Paste	Pastes the contents of the clipboard to the selected location.
Delete	Deletes the data in the selected cell. The data in the selected cell becomes 0.

(5) Data area

Cut	Cuts the data in the selected cell and saves it to the clipboard. The data in the selected cell becomes "Z" (Hi-Z).
Copy	Copies the data in the selected cell and copies it to the clipboard.
Paste	Pastes the contents of the clipboard to the selected location.
Delete	Deletes the data in the selected cell. The data in the selected cell becomes "Z" (Hi-Z).
Start Signal Input	Starts signal input.
Stop Signal Input	Stops signal input.
Reset Signal Input	Returns the current signal input line to the beginning.

[Operation]

- (1) [Pin selection](#)
- (2) [Creating signal data](#)
- (3) [Data copy and paste](#)
- (4) [Single-line editing](#)
- (5) [Signal input](#)
- (6) [Operation at CPU reset](#)

(1) Pin selection

To create the signal data, it is first necessary to select the pin to be used.

Open the [Select Pin dialog box](#) by clicking the  button on the toolbar or selecting the [Edit] menu >> [Select Pin...], and select the pin to be used. Once a pin is selected, its name is displayed in [Pin area](#).

(2) Creating signal data

Create the signal data input to each pin.

(a) Setting of input value

In the Data area, specify the value that is input to each pin (see "[Data area](#)").

(b) Setting of input timing

In the Wait area, specify the timing at which the input value is input to each pin as "wait time" (see "[Wait area](#)").

(c) Setting of the loop information

When loop processing for the signal data specified in step (a) and (b) is needed, specify the loop information.

To specify the loop information, select [Loop Start] from the context menu on the loop start position in the Mark area, and select [Loop End] on the loop stop position.

At this time, the loop count can be specified. In this case, specify the loop count via the [Loop dialog box](#) opened by selecting [Loop Dialog...] from the context menu.

The corresponding loop information marks are displayed if the setting of the loop information is completed (see "[Mark area](#)").

(3) Data copy and paste

The setting values in [Mark area/Wait area/Data area](#) can be copied and pasted.

However, copied data can be pasted only in the same area.

Copy	When one or more (a range of) cells are selected, these cells can be copied by selecting the [Edit] menu >> [Copy] (or pressing the [Ctrl] + [C] key).
Paste	When one or more (a range of) cells are selected, these cells can be pasted by selecting the [Edit] menu >> [Paste] (or pressing the [Ctrl] + [V] key). When multiple (a range of) cells are selected, the copied data is pasted to the cells repeatedly.

(4) Single-line editing

Single lines can be edited by selecting [Line number area](#).

The method is the same as that described in "**(3) Data copy and paste**".



Data pasted during line paste (insertion) is inserted immediately before the selected line.

(5) Signal input

Input the created signal data to the input pins of the simulator while simulation is executed.

At this time, the line whose signal is currently being input (current line) is highlighted in yellow during program breaks (this can be changed via [Inputted current line] item in the [Customize dialog box](#)), in order to display signal input progress.

There are the following types of signal data input operations;

Signal input start	Click the  button, or select the [Edit] menu >> [Signal Input] >> [Start]. As a result, signal input starts from the current signal input line (highlighted line).
Signal input stop	Click the  button, or select the [Edit] menu >> [Signal Input] >> [Stop]. This stops signal input.

Signal reset	Click the  button, or select the [Edit] menu >> [Signal Input] >> [Reset]. This returns the current signal input line to the beginning. If signal reset was performed during signal input, input continues from the beginning.
--------------	--

Remark The signal data input to the selected pin can be controlled by selecting the [Edit] menu >> [Pin Status] >> [Valid]/[Invalid].

(6) Operation at CPU reset

When CPU reset occurs, the current signal input line returns to the beginning.

If a CPU reset occurs during signal input, input continues from the beginning (same operation as the  button).

Loop dialog box

This dialog box is used to perform detailed settings (loop start/stop and loop count) related to the loop information in the [Signal Data Editor window](#).

Figure A-59. Loop Dialog Box

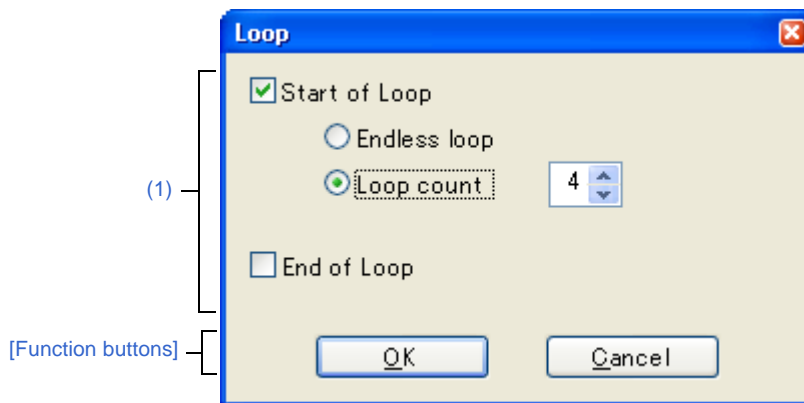

This section describes the following.

- [\[How to open\]](#)
- [\[Description of each area\]](#)
- [\[Function buttons\]](#)

[How to open]

On the [Signal Data Editor window](#), any one of the following;

- Double-click the Mark area.
- Select the Mark area, then select [Mark] >> [Loop Dialog...] from the [Edit] menu.

[Description of each area]

(1) Loop information setting area

Start of Loop	Select this check box to set the Start of Loop.		
	Endless loop	Select this option button to set the Endless Loop.	
	Loop count	Select this option button to set the Loop Count. Sets the count value by spin button.	
		0	Skip loop
		1 to 99	Perform loop the specified count.
End of Loop	Select this check box to set the End of Loop.		

[Function buttons]

Button	Function
OK	Validates the settings and closes this dialog box.
Cancel	Cancel the settings and closes this dialog box.

Select Pin dialog box

This dialog box is used when selecting pins displayed in the [Signal Data Editor window](#) and the [Timing Chart window](#). The pin information set in this dialog box can be saved as a pin information file (*.pin) by clicking the [Save] button. Moreover, the saved file contents can be restored by clicking the [Load] button.

Figure A-60. Select Pin Dialog Box

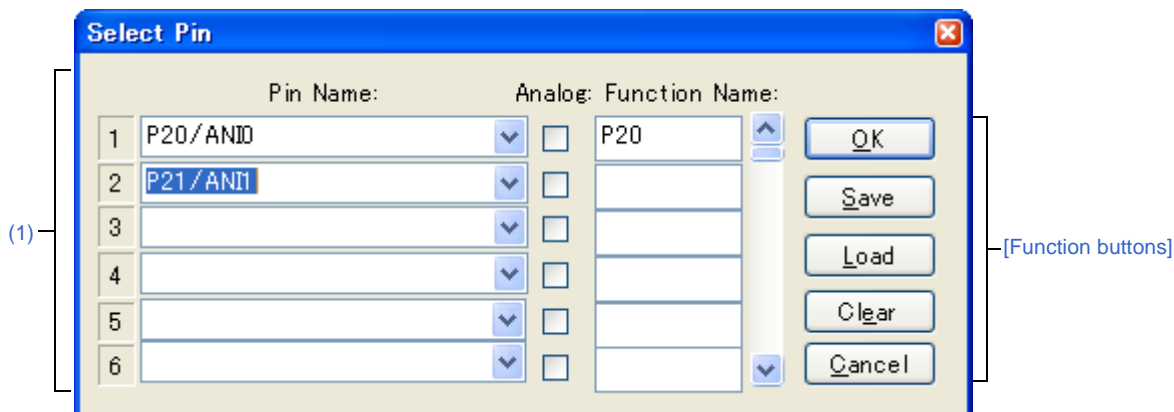

This section describes the following.

- [\[How to open\]](#)
- [\[Description of each area\]](#)
- [\[Function buttons\]](#)

[How to open]

On the [Signal Data Editor window](#)/[Timing Chart window](#), any one of the following;

- Click the  button.
- Select [Select Pin...] from the [Edit] menu.

[Description of each area]

(1) Connection pins setting area

Up to 256 pins can be selected by using the scrollbar located on the right side of the pin name setting area.

Pin Name	This area is used to specify the pin name to be connected. The connection pins can be specified either via direct input or through selection from the drop-down list.
Analog	Select this check box to use the specified pin as an analog pin.
Function Name	This area is used to set a function name for the pin name. When a character string is input in this area, this character string is displayed as a function name in the pin name part. If nothing is specified, the pin name is displayed.

Remark For the pin names that can be specified, see the user's manual of the microcontroller that is used.

[Function buttons]

Button	Function
OK	Validates the settings and closes this dialog box. The pin name (or display name) is applied in the Pin field of the window from where this dialog box was called up.
Save	Saves the display contents to the pin information file (*.pin).
Load	Loads the pin setting information of the specified file (*.pin).
Clear	Deletes the settings.
Cancel	Cancel the settings and closes this dialog box.

Timing Chart window

This window is used to display the output signals and input signals for pins in the form of a timing chart.

This window allows time measurement in main clock units.

The browsed signal data can be saved to the timing chart file (*.wvo) by selecting the [File] menu >> [Save]/[Save As...]. Moreover, the saved file contents can be restored by selecting [File] menu >> [Open...].

If the project file is saved, signal data is not saved but information of the set pins is saved. (Solely saving the project file is sufficient if saving of the measurement result is unnecessary.)

- Cautions 1.** If the saved timing chart file is opened or the project file is opened while Simulator GUI is running with a microcontroller different from the one used when the timing chart file was created, the settings of pins that are not provided in the microcontroller will not be restored.
- 2.** The main clock and sub clock waveforms cannot be displayed in this window. In addition, when using the external bus interface function, the waveforms of pins used for the external bus interface function cannot be displayed.

Figure A-61. Timing Chart Window

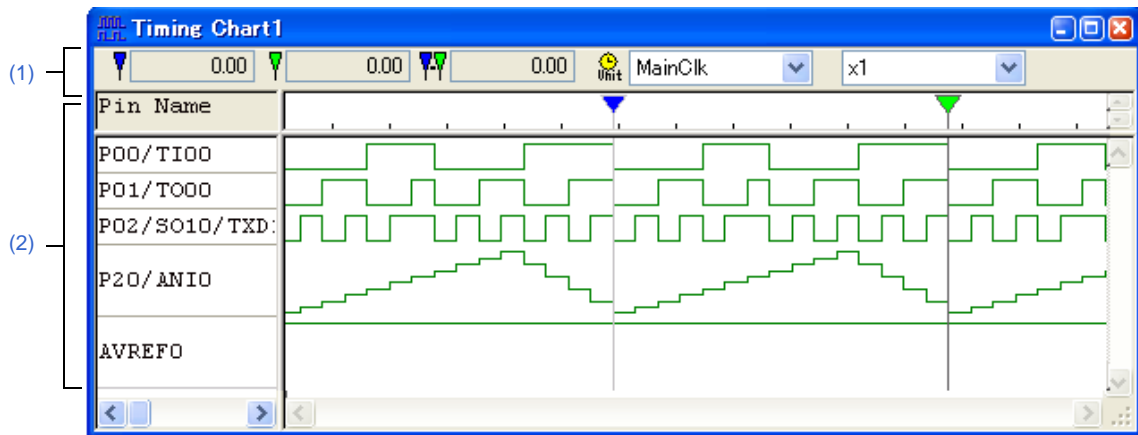

This section describes the following.

- [How to open]
- [Description of each area]
- [Dedicated menu (Timing Chart window)]
- [Timing Chart toolbar]
- [Context menu]
- [Operation]

[How to open]

- Click the  button.
- Select [Timing Chart] from the [Simulator] menu.

[Description of each area]

(1) Information bar

It can be specified whether this area is displayed or not, by selecting the [View] menu >> [Information Bar].

5553364.00	Clock/time count from simulation start until marker A location.
5554860.00	Clock/time count from simulation start until marker B location.
1496.00	Clock/time count between markers A and B. (Displayed as absolute value.)
Unit MainClk	Select from the drop-down list the time unit for the location information of markers A and B. This item can also be set by using [Time unit] in the [Edit] menu or [Time unit] from the context menu.
x1/2	Selects the waveform data display magnification ratio from the drop-down list. If a part of waveform data may be lost as a result of changing the display magnification ratio, the confirmation dialog box is displayed.

- Remarks 1.** Up to 4,294,967,262 clocks can be counted from the simulation start up to the marker position. When the count reaches the maximum value, the counter is cleared to 0 and starts counting again.
- 2.** The menu for setting the magnify ratio appears dimmed during program execution, so changing the ratio is unavailable.

(2) Client area

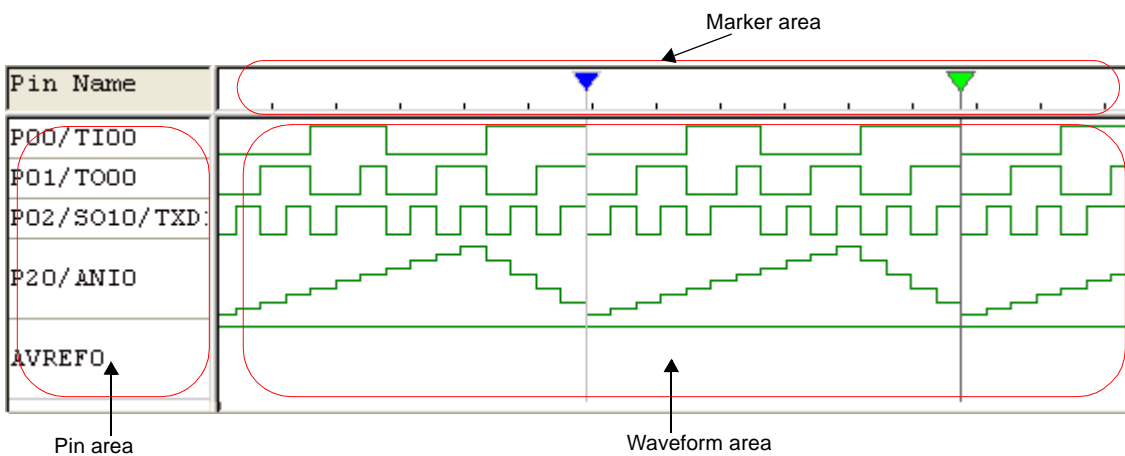

Pin Name area	Displays the names of the pins for which timing chart display is performed. Pin selection is performed by selecting the [Edit] menu >> [Select Pin...] to open the Select Pin dialog box .	
Marker area	Displays the 2 marker headers. These markers can be moved by dragging them with the mouse over this area.	
		Marker A
		Marker B
Waveform area	Performs timing chart display for the data of the pins specified in the Pin area. The following color distinctions are used according to the signal by default.	
	Green	The HIGH and LOW signals of the pins
	Red	High-impedance signals
	Blue	Unsampled signals

- Remarks 1.** When the buffer is full, the data will be overwritten by the latest data starting from the oldest data because the buffer storing the pin data is in a ring buffer format.
 The upper limit of the buffer size is one of the following.
- The number of pin change points: 4,096
 - The number of clocks: 2,147,483,631
 - Horizontal draw width: 134,217,711 pixels
- 2.** The colors and fonts can be changed via the [Customize dialog box](#) opened by selecting the [Option] menu >> [Customize...].

[Dedicated menu (Timing Chart window)]

(1) [Edit] menu

Clear	Deletes all the waveform data.
Find...	Opens the Search Data dialog box . Waveform data search is performed in this dialog box.
Search backward	Searches for the change point of the selected pin in the backward direction (toward the left).
Search forward	Searches for the change point of the selected pin in the forward direction (toward the right).
Select Pin...	Opens the Select Pin dialog box . The pin for which the waveform data is to be displayed is selected in this dialog box.
Time unit	Selects the time unit.
main clock	Main clock (default)
usec	Microsecond
msec	Millisecond





(2) [View] menu

Waveform	Switches on/off display of the Maker area and Waveform area.
Information Bar	Switches on/off display of the information bar.
Zoom	Selects the waveform data display magnification ratio from a cascade menu. If a part of waveform data may be lost as a result of changing the display magnification ratio, the confirmation dialog box is displayed.
x 1/32	Sets the magnification ratio to 1/32.
x 1/16	Sets the magnification ratio to 1/16.
x 1/8	Sets the magnification ratio to 1/8.
x 1/4	Sets the magnification ratio to 1/4.
x 1/2	Sets the magnification ratio to 1/2.
x 1	Sets the magnification ratio to 1.
x 2	Sets the magnification ratio to 2.
x 4	Sets the magnification ratio to 4.
x 8	Sets the magnification ratio to 8.
x 16	Sets the magnification ratio to 16.
x 32	Sets the magnification ratio to 32.

(3) [Option] menu

Customize...	Opens the Customize dialog box .
--------------	--

[Timing Chart toolbar]

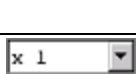
	Deletes all the waveform data.
	Searches for the change point of the selected pin in the backward direction (toward the left).
	Searches for the change point of the selected pin in the forward direction (toward the right).
	Opens the Select Pin dialog box . The pin for which the waveform data is to be displayed is selected in this dialog box.
	Selects the waveform data display magnification ratio from the drop-down list. If a part of waveform data may be lost as a result of changing the display magnification ratio, the confirmation dialog box is displayed.

[Context menu]

The following context menus are available in the [Client area](#).

Clear	Deletes all the waveform data.
Find...	Opens the Search Data dialog box . Waveform data search is performed in this dialog box.
Search backward	Searches for the change point of the selected pin in the backward direction (toward the left).
Search forward	Searches for the change point of the selected pin in the forward direction (toward the right).
Select Pin...	Opens the Select Pin dialog box . The pin for which the waveform data is to be displayed is selected in this dialog box.
Waveform	Switches on/off display of the Maker area and Waveform area.
Time unit	Selects the time unit.
Zoom	Selects the waveform data display magnification ratio. If a part of waveform data may be lost as a result of changing the display magnification ratio, the confirmation dialog box is displayed.
Move MakerA	Moves marker A to the cursor location. The same action can be accomplished by pressing the [Shift] key + left-clicking.
Move MakerB	Moves market B to the cursor location. The same action can be accomplished by pressing the [Ctrl] key + left-clicking.

[Operation]

- (1) [Pin selection](#)
- (2) [Display of timing chart](#)
- (3) [Clearing of timing chart](#)
- (4) [Timing measurement for timing chart](#)
- (5) [Data search function](#)
- (6) [Operation at reset](#)

(1) Pin selection

To display the timing chart, it is first necessary to select the pin to be displayed.

Open the [Select Pin dialog box](#) by selecting the [Edit] menu >> [Select Pin...] and select the pin to be edited. Once a pin is selected, its name is displayed in the [Pin Name area](#).

(2) Display of timing chart

The waveforms of the selected pins are displayed in timing chart form through execution of the program.

Remark The simulation speed can be increased by hiding the timing chart.

To hide the timing chart, select the [View] menu >> [Waveform] (deselect this item).

When the timing chart is hidden, the Maker area and Waveform area appear dimmed and "Display OFF" is displayed in the center.

(3) Clearing of timing chart

Timing chart display is cleared by selecting the [Edit] menu >> [Clear].

(4) Timing measurement for timing chart

The timing between two points can be measured by marking 2 locations using markers A and B.

The time of each marker and the time between markers are displayed in the information bar.

Each marker can be placed at the target position by dragging the marker head. Moreover, it can also be placed at the position of the current mouse cursor by selecting [Move MarkerA]/[Move MarkerB] from the context menu.

The marker that is clicked last becomes the selected marker and can be subjected to the [Data search function](#).

Figure A-62. Maker A And Maker B

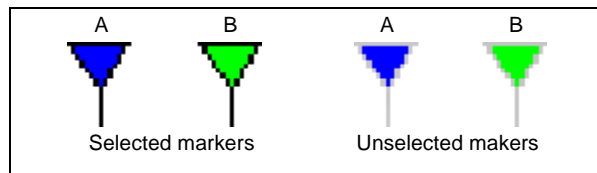
**(5) Data search function**

There are two data search functions for timing charts.

(a) Simple search

Simple search is a function used to search change points for one pin.

Select the name of the pin for which the search is to be performed in the Pin area and then select the [Edit] menu >> [Search backward] or [Search forward].

As a result, the selected marker moves to the data position at which the change point was detected.

(b) Detailed search

In the case of detailed search, search using a combination of data of multiple pins can be executed.

The search data is set in the [Search Data dialog box](#) displayed by selecting the [Edit] menu >> [Find...].

The selected marker moves to the data position that was hit, similarly to simple search results.

(6) Operation at reset

If CPU reset or Simulator GUI reset occurs, the displayed waveforms of the timing chart are all cleared.

Search Data dialog box

This dialog box is used to search the signal data displayed in the [Timing Chart window](#) in detail.

- Cautions**
1. Analog I/O signals cannot be searched.
 2. This dialog box cannot be opened during program execution.

Figure A-63. Search Data Dialog Box

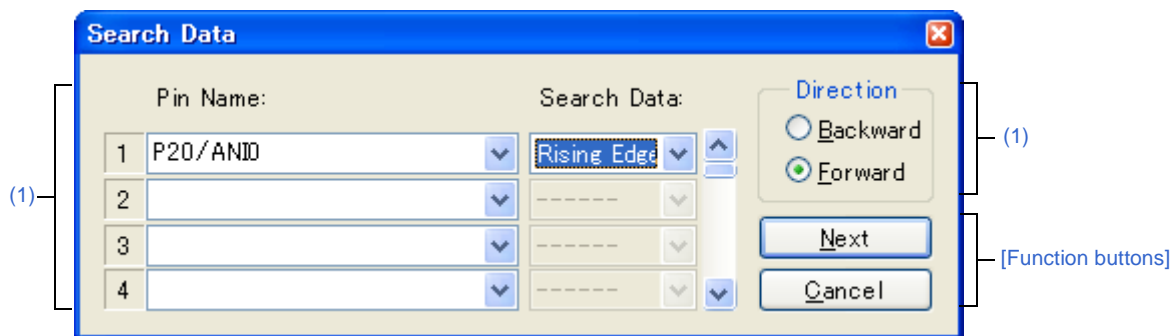

This section describes the following.

- [\[How to open\]](#)
- [\[Description of each area\]](#)
- [\[Function buttons\]](#)

[How to open]

On the [Timing Chart window](#), any one of the following;

- Click the button.
- Select [Find...] from the [Edit] menu.

[Description of each area]

(1) Search pin setting area

When multiple search conditions have been specified, the signal data that meets all these search conditions is searched.

Up to 48 search conditions can be specified by using the scrollbar located on the right side.

Pin Name	This area is used to specify the pin name to be searched. The pins can be specified either via direct input or through selection from the drop-down list. Inputting nothing makes an area off-limit to data search and input in the corresponding [Search Data] is disabled.
----------	--

Search Data	Selects the data from drop-down list. The data is searched for the pin to be specified.	
	-----	Don't care
	Rising Edge	Searches the rising edge of signal data.
	Falling Edge	Searches the falling edge of signal data.
	Rise/Fall Edge	Searches the rising/falling edge of the signal data.
	High	Searches the signal data that is HIGH.
	Low	Searches the signal data that is LOW.
	Hi Z	Searches the signal data that is high impedance.
Direction	Selects the data search direction by selecting one of the exclusive option buttons. When the [Next] button is clicked, the search is performed in the direction specified in this area.	
	Backward	Searches the data backward (data older than the current location).
	Forward	Searches the data forward (data newer than the current location). (default)

[Function buttons]

Button	Function
Next	Searches in the direction specified. When this button is clicked again following search completion, the next data is searched.
Cancel	Stops the data search and closes the dialog box.

I/O Panel window

This window is used to configure a dummy target system, and manipulate created connected parts.

A dummy target system can be constructed by creating and setting connected parts (figure objects and part objects) in this window. The connected parts for which settings have been performed can be moved to any location within the window, and you can manipulate them during simulation to control signal processing.

Information about parts that are placed in the window can be saved to the I/O panel file (*.pnl) by selecting the [File] menu >> [Save]/[Save As...] or by saving the project file.

The saved file contents can be restored by selecting the [File] menu >> [Open...] or by loading the project file.

- Cautions 1.** If the saved I/O panel file is opened while Simulator GUI is running with a microcontroller different from the one used when the file was created, information of the parts connected to the pins that are not provided in the microcontroller will not be restored (the [Pin Name] item in the property dialog boxes for parts remains blank).
- 2.** If inputting of signals is started (by an event such as clicking a button) during program break, the signal level will change in actuality when the program is resumed from the break.

Remark On the titlebar of this window, "Project file name + Serial number (from 0).pnl" is displayed when the project file has been loaded. However, after having loaded a project file of PM+, then if you save a file as the project file of CubeSuite, "Project file name + CS+ Serial number (from 0).pnl" is displayed on the titlebar.

Figure A-64. I/O Panel Window

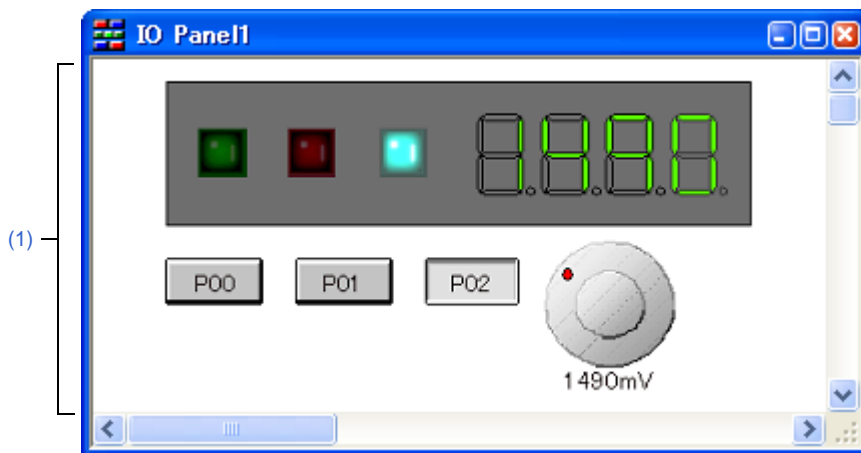

This section describes the following.

- [How to open]
- [Description of each area]
- [Dedicated menu/toolbar (I/O Panel window)]
- [Context menu]
- [Operation]

[How to open]

- Click the  button.
- Select [I/O Panel...] from the [Simulator] menu.

[Description of each area]

(1) Client area

This area is used to create and set connected parts (figure objects and part objects) in order to construct a dummy target system (see "[Operation]").

[Dedicated menu/toolbar (I/O Panel window)]

The menu items and buttons on the toolbar, which are used to perform operations related to this window, are described below.

In the [Parts] and [Figure] menus, similar operations can be performed using the buttons on the toolbar.

- (1) [Edit] menu
- (2) [View] menu
- (3) [Parts] menu/[Parts] toolbar
- (4) [Figure] menu/[Figure] toolbar

(1) [Edit] menu

Select this menu to perform basic editing actions on created objects.

Undo	Undoes the immediately preceding operation, such as object move. Undo can restore up to 5 previous changes.
Redo	Restores the status undone by the [Undo] command.
Cut	Cuts the selected range and saves it to the clipboard.
Copy	Pastes the contents of the clipboard.
Paste	Pastes the contents of the clipboard.
Delete	Deletes the selected range.
Select All	Selects all the objects in the window.
Group	Groups the selected objects.
UnGroup	Ungroups the selected objects.
Bring to Front	Brings the selected object to the front.
Send to Back	Sends the selected object to the back.
Bring Forward	Brings the selected object one panel forward.
Send Backward	Sends the selected object one panel backward.

(2) [View] menu













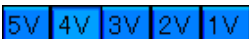





Select this menu to switch the toolbar/status bar display status in this window, or to show/hide various types of information in this window.

ToolBar	Switches on and off the display of two toolbars (Figure/Object).
StatusBar	Switches on and off display of the status bar.
Parts List...	Opens the Parts List dialog box . A list of all the figure/part objects in this window is displayed.
Grid	Shows/hides the window grid.
Properties	Opens the property dialog box of the selected figure/part object.

(3) [Parts] menu/[Parts] toolbar

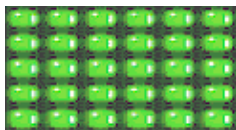
This menu and toolbar are used to select connected parts (part objects) provided by Simulator GUI when newly creating or placing parts (see "(3) Creating part objects").













In this menus, similar operations can be performed using the buttons on the [Parts] toolbar.



Menu Item	Button	Function
Button		Digital input switch
e.g.)		A button can be connected to any pin. A digital input value can be given to the connected pin by clicking the displayed button.
Analog Button		Analog input switches
e.g.)		A button can be connected to any pin. An analog input value can be given to the connected pin by clicking the displayed button.
Key Matrix		A key matrix consists of multiple pins connected in a matrix array, wherein each contact represents a key, and clicking a key results in a specific state.
e.g.)		A key matrix can be connected to any pin, and data can be input using multiple keys.
Level Gauge		Used for inputting analog data such as power supply voltage. Any data within a given range can be set.
e.g.)		Any value within a specified range can be assigned to a pin connected to an A/D converter.
LED		Light Emitting Diode
e.g.)		An LED can be connected to any pin, and the output from the pin can be indicated by switching the LED on or off.
7-Segment LED		A product that consists of 7 LEDs configured to represent a numeric figure.
e.g.)		When the output from the pin assigned to the digit signal is active, the corresponding 7-segment LED switches on or off.
14-Segment LED		A product that consists of 14 LEDs configured to represent an alphabetic character.
e.g.)		When the output from the pin assigned to the digit signal is active, the corresponding 14-segment LED switches on or off.
Matrix LED		A product that consists of multiple LEDs arranged in a matrix array.
e.g.)		When the output from an assigned pin is active, the corresponding 14-segment LED switches on or off.
Buzzer		A buzzer connected to a pin indicates the output information from the connected pin with a bitmap.
e.g.)		
Pull up / Pull down...		Opens the Pull up/Pull down dialog box . Whether a pin is connected to a pull-up/down resistor can be specified via this dialog box.

(4) [Figure] menu/[Figure] toolbar

This menu and toolbar are used to set the operation mode of this window, and select connected parts (figure objects) when newly creating or placing parts (see "(2) Creating figure objects").

In this menus, similar operations can be performed using the buttons on the [Figure] toolbar.

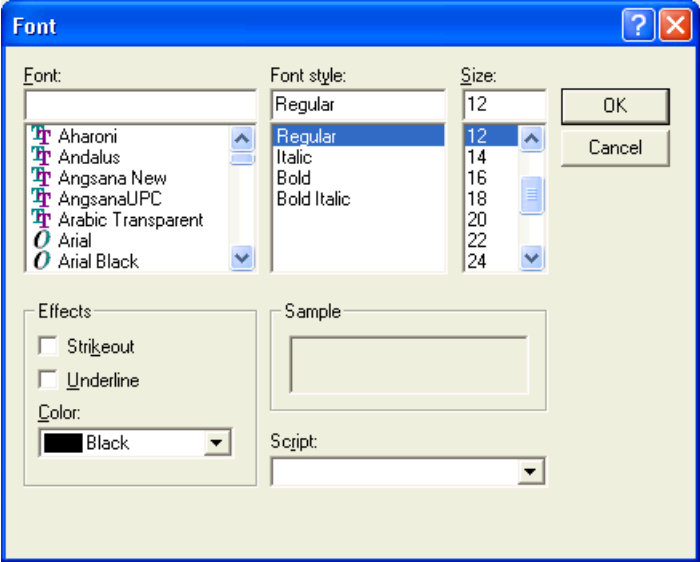
Menu Item	Button	Function
Select		Changes this window's operation mode to the Edit mode . The cursor shape changes into an arrow, enabling the edit of objects.
Simulation Mode		Changes this window's operation mode to the Simulation mode . The cursor shape changes into a hand, enabling simulation of input to connected parts (part objects).
Line		Changes the cursor shape into a cross (+), enabling the drawing of lines.
Rectangle		Changes the cursor shape into a cross (+), enabling the drawing of rectangles.
Rounded Rectangle		Changes the cursor shape into a cross (+), enabling the drawing of rectangles with rounded corners.
Ellipse		Changes the cursor shape into a cross (+), enabling the drawing of ellipses.
Polygon		Changes the cursor shape into a cross (+), enabling the drawing of polygons.
Fan-shaped		Changes the cursor shape into a cross (+), enabling the drawing of fan shapes.
Text		Changes the cursor shape into a cross (+), enabling the drawing of text.
Paste Bitmap...	-	Pastes the selected bitmap file in this window
Color of Line...		Opens the Color dialog box below. The color of the lines of the selected object can be changed to the selected color in this dialog box. 
Color of Fill...		Opens the Color dialog box. The color used for the selected object can be changed to the selected color in this dialog box.

Menu Item	Button	Function
Font...	-	<p>Opens the Font dialog box below</p> <p>The font of the selected object can be changed to the selected font in this dialog box.</p> 
Style of Line		Selects the line style from a cascade menu. The lines of the selected object are changed.
16pt		Sets the line thickness to 16 pt.
12pt		Sets the line thickness to 12 pt.
8pt		Sets the line thickness to 8 pt.
4pt		Sets the line thickness to 4 pt.
2pt		Sets the line thickness to 2 pt.
1pt		Sets the line thickness to 1 pt.
No line		Does not draw lines.
Dotted Line Style		Selects the dotted line style from a cascade menu. The lines of the selected object are changed.
Solid Line		Draw solid lines.
Dash Line		Draw dashed lines.
Dotted Line		Draw dotted lines.
DashDot Line		Draw DashDot lines.
DashDotDot Line		Draw DashDotDot lines.

[Context menu]

In the [Edit mode](#), the following context menus are available.

Copy	Copies the selected objects.
Paste	Pastes the contents of the clipboard.
Delete	Deletes the selected objects.
Group	Selects from a cascade menu.
Group	Groups the selected objects.
Ungroup	Ungroups the selected objects.
Order	Selects from a cascade menu.
Bring to Front	Brings the selected object to the front.
Send to Back	Sends the selected object to the back.
Bring Forward	Brings the selected object one panel forward.
Send Backward	Sends the selected object one panel backward.
Properties	Opens the property dialog box of the selected figure/part object.

[Operation]

How to create objects (figure objects and part objects) to construct a dummy target system, and manipulate them is as follows;

- (1) [Edit mode](#)
- (2) [Creating figure objects](#)
- (3) [Creating part objects](#)
- (4) [Placing objects](#)
- (5) [Inputting text](#)
- (6) [List display of objects](#)
- (7) [The detailed setting for objects](#)
- (8) [Simulation mode](#)

(1) Edit mode

Change the operation mode of this window to "edit mode" to create objects.

The edit mode can be set by any one of the following methods.

- Select the [Figure] menu >> [Select].
- Click the  button on the toolbar.
- Select the [Edit] menu >> [Select All].

(2) Creating figure objects**(a) Line**





Select the [Figure] menu >> [Line] or click the  button on the toolbar.

-> The mouse cursor changes to a cross (+) shape and line drawing becomes possible.

Drag the cursor from the line start position to the end position.

-> The line start position and the line end position are connected by a straight line. (The line thickness and shape are the default settings.)

(b) Rectangle/Rounded rectangle/Fan shape

Select the [Figure] menu >> [Rectangle]/[Rounded Rectangle]/[Ellipse]/[Fan-shaped] or click the  /  /  /  button on the toolbar.

-> The mouse cursor changes to a cross (+) shape and each drawings becomes possible.

Drag the mouse cursor from the top left corner to the bottom right corner of the drawing area (rectangular area).

-> The corresponding figure is displayed in the drawing area, with the mouse position forming the lower right corner.

Drop the figure to fix its size.

-> Rectangles are drawn in the same size as the rectangular area, and other figure shapes are drawn in a size that fits in the rectangular area. (The line thickness and shape are the default settings.)

(c) Polygon

Select the [Figure] menu >> [Polygon] or click the  button on the toolbar.

-> The mouse cursor changes to a cross (+) shape and polygon drawing becomes possible.

Click at each position marking an apex of the polygon.

-> The apexes are linked by a straight line in the order in which they were clicked.

Drawing of the polygon is completed by double-clicking.

-> The line thickness and shape are the default settings.

(d) Pasting a bitmap



You can use an arbitrary bitmap file as a figure object.

Select the [Figure] menu >> [Paste Bitmap], and then select the bitmap file (*.bmp) to be pasted.

-> The corresponding bitmap file is pasted in the default position in this window.

(e) Changing the figure object style

The color or line style of the created figure object can be changed by any one of the following methods.

- Specify with the [Style] tab of the [Object Properties dialog box](#) opened by double-clicking the figure object.
- Select the [Figure] menu >> [Color of Line]/[Color of Fill]/[Style of Line]/[Dotted Line Style] or click the  /  /  button on the toolbar.

(3) Creating part objects

You can create part objects by using connected parts provided by Simulator GUI.

(a) Selecting a part object

Select the part object to be created from the [Parts] menu or the toolbar.

-> The mouse cursor changes to a cross (+) shape.

Click any location.

-> The corresponding part object is created and placed with the clicked location as the top left corner (default size).

(b) Changing the part object style

The style of the created part object can be changed via the [Style] tab of the corresponding property dialog box opened by double-clicking the part object.

For details on the modifiable items, see the section of the property dialog box which is corresponding to the part object (the items differ depending on the part object).

(4) Placing objects**(a) Grid display**

A grid is displayed by selecting the [View] menu >> [Grid].

(b) Selecting objects

The selected types and methods are indicated below.

The selected object(s) is displayed surrounded by a tracker indicating its selected status.

- Single selection

Click the object to be selected.

- Multiple selections

Click the objects to be selected while pressing the [Shift] key.

- Range selection

Drag from the top left corner of the area including the object to be selected, and drop at the lower right corner.

- Select all

Select [Edit] menu>> [Select All].

(c) Moving objects

After selecting the object to be moved (multiple selections possible), then drag and drop it at the move destination.

Remark Objects can be moved using the arrow keys on the keyboard.

If more than half of the part bitmap is hidden when the window size is reduced, however, the selected part cannot be moved by using the arrow keys.

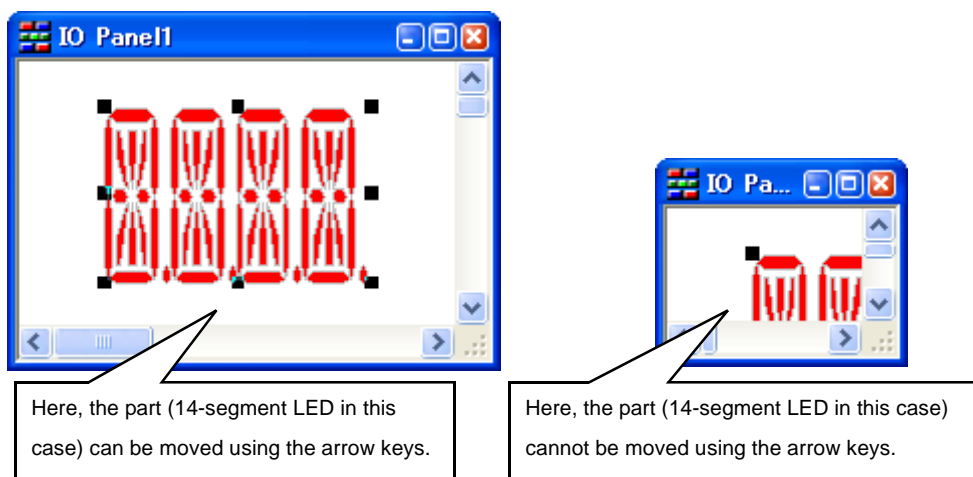
**(d) Changing object size**

After selecting the object whose size is to be changed, then drag the tracker displayed.

(e) Cut/Copy/Paste/Delete/Group/UnGroup an object

After selecting the object, select the corresponding item from the [Edit] menu.

(f) Changing object sequence (Bring to Front/Send to Back/Bring Forward/Send Backward)

After selecting the object, select the corresponding item from the [Edit] menu.

(5) Inputting text

Select [Figure] menu >> [Text] or click the  button on the toolbar.

-> The mouse cursor changes to a cross (+) shape.

Drag the mouse cursor from the top left corner of the character drawing area (rectangular area) to the lower right corner.

-> This rectangular area serves as the character drawing area.

Click in the character drawing area.

-> The cursor is displayed and character input becomes possible.

(6) List display of objects

Figure objects and part objects created in this window can be displayed as a list by selecting the [View] menu >> [Parts List], in addition to display in this window.

(7) The detailed setting for objects

Each created object requires the detailed setting (pin connection information, etc.) in accordance with the target system to be used.

(a) Figure objects

The detailed setting can be performed via the [Object Connection] tab of the [Object Properties dialog box](#) opened by double-clicking the target figure object.

By connecting a object to an output pin, show/hide of the object can be switched depending on the output status of the connected pin.

(b) Part objects

The detailed setting can be performed via the [xxx Connection] tab of the property dialog box opened by double-clicking the target part object.

For details on the settable items, see the section of the property dialog box which is corresponding to the part object (the items differ depending on the part object).

(8) Simulation mode

The part objects whose settings have been completed can be manipulated during simulation (input values can be fed to the simulator). Accordingly you can check the I/O results from these displayed part objects in this window. Change the operation mode of this window to "simulation mode" to manipulate part objects.

The simulation mode can be set by any one of the following methods (the mouse cursor changes to a hand shape).

- Select the [Figure] menu >> [Simulation Mode].
- Click the  button on the toolbar.

Remark For details on input operation, see the section of the property dialog box which is corresponding to the part object

Parts Button Properties dialog box

This property dialog box is used to set or change the pin connection information of buttons, which are one of the connection parts in the [I/O Panel window](#).

Input to the simulator can be done from pin-connected buttons in the [Simulation mode](#).

There are two types of button display styles, figure and bitmap. These styles can be changed on the [\[\[Style\] tab\]](#).

Figure A-65. Parts Button Properties Dialog Box: [Button Connection] Tab

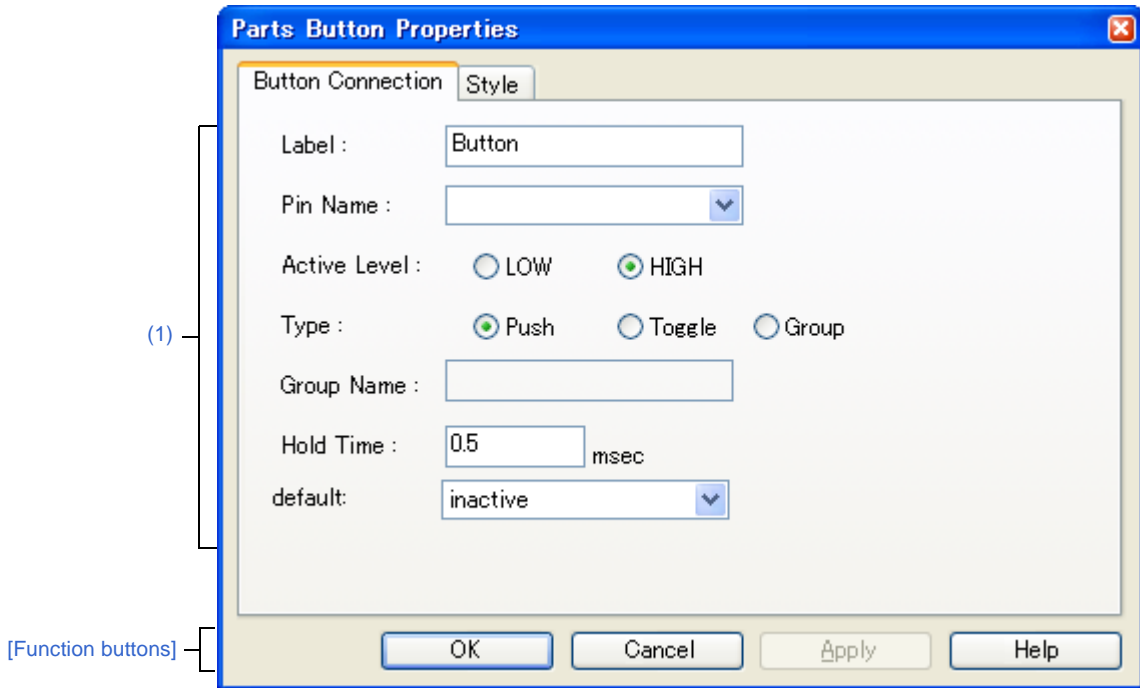
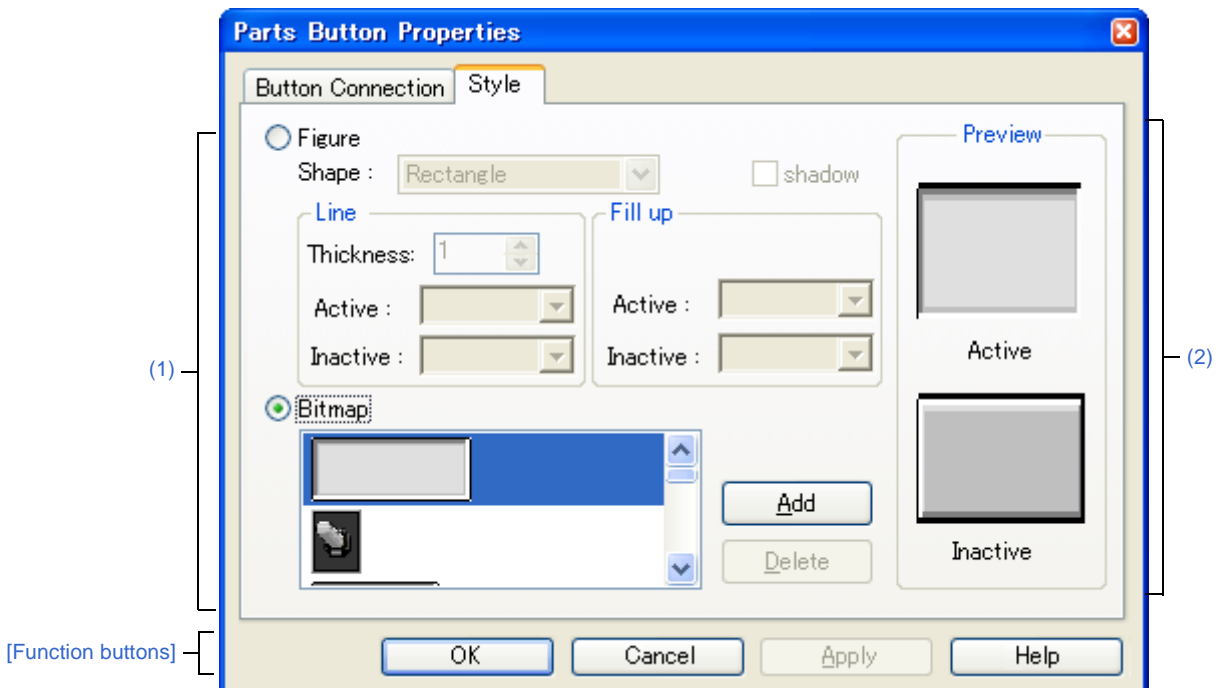

Figure A-66. Parts Button Properties Dialog Box: [Style] Tab



This section describes the following.

- [How to open]
- [[Button Connection] tab]
- [[Style] tab]
- [Function buttons]
- [Operation]

[How to open]

On the I/O Panel window, any one of the following;

- Double-click a part object "Button".
- Select [Properties...] from the context menu on a part object "Button".
- Select a part object "Button", and then select [Properties...] from the [View] menu.

[[Button Connection] tab]

(1) Pin connection information setting area

Label	This area is used to specify the part name. The part name input here is displayed on the button. Moreover, it is also displayed in the Parts List dialog box as the label.	
Pin Name	This area is used to specify the pin name to be connected. The connection pins can be specified either via direct input or through selection from the drop-down list.	
Active Level	The active state is selected with a option button, as follows:	
	LOW	Sets the active level to LOW.
	HIGH	Sets the active level to HIGH (default).
Type	Button types are selected using option buttons, as follows:	
	Push	Makes the button a Push button (default). The [Hold Time] item must be specified.
	Toggle	Makes the button a Toggle button .
	Group	Makes the button a Group button . The [Group Name] item must be specified.
Group Name	This area is used to input the button's group name. Input to this area is possible only when [Group] has been selected in [Type].	
Hold Time	Specify the time (hold time) for which the input value is to be held (default: 0.5msec). The settable range is from 0.001 to 999 (msec). Input to this area is possible only when [Push] has been selected in [Type].	
default	Specify the button status after CPU reset.	
	Not change at reset.	Maintains the button status after CPU reset.
	inactive	Buttons are non-depressed after CPU reset (default).
	active	Buttons are depressed after CPU reset.

Remark For the pin names that can be specified, see the user's manual of the microcontroller that is used.

[[Style] tab]

(1) Style information setting area

Figure	Select this option button to display the button with the following specified figure.		
	Shape	Select the figure shape. Two shapes can be selected: rectangle and ellipse.	
	shadow	Cannot be selected.	
	Line	Specify and change the figure line, as follows. You can change the color of figure line by clicking the pull-down button.	
		Thickness	Specifies the line thickness. Specification is made either using a spin button or through direct input. A value from 1 to 100 can be specified.
		Active	Specifies the color of the line during active display.
		Inactive	Specifies the color of the line during inactive display.
	Fill up	Specify and change the figure filling, as follows. You can change the color of figure filling by clicking the pull-down button.	
		Active	Specifies the fill color during active display.
Inactive		Specifies the fill color during inactive display.	
Bitmap	Select this option button to display the button with the following specified bitmap (default).		
	Selection list	Select a bitmap to be used from the selection list. The selectable bitmaps appear in the selection list.	
	[Add] button	Opens the Entry Bitmap dialog box below to add a new bitmap to the selection list. The bitmap file to be added can be specified either through file selection using the [...] button, or through direct input.	
	[Delete] button	Deletes the currently selected bitmap from the selection list. Note that only the bitmap that have been added by user can be deleted.	

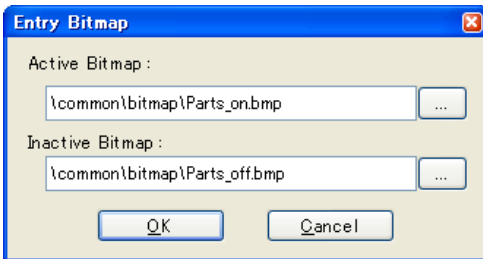

(2) Preview area

This area displays the style of the button currently being specified.

[Function buttons]

Button	Function
OK	Validates the settings and closes this dialog box.
Cancel	Cancels the settings and closes this dialog box.
Apply	Cannot be selected.
Help	Displays the help for this dialog box.

[Operation]

In the [Simulation mode](#), by clicking the displayed button, data can be input to the pin connected to the button. The input format differs depending on the button type (push, toggle, group).

Figure A-67. Connected Parts Display Example (Button)



Push button	Clicking this button causes the active value to be loaded to the connected pin. The active value is held during the hold time, after which it changes to the original value.
Toggle button	Clicking this button loads the active value to the connected pin. The active value is held during the hold time, after which it changes to the original value.
Group button	Clicking this button loads the active value to the connected pin. The value of the Group button having the same group name returns to the original value.

Analog Button Properties dialog box

This property dialog box is used to set or change the pin connection information of analog buttons, which are one of the connection parts in the *I/O Panel window*.

Input to the simulator can be done from pin-connected analog buttons in the *Simulation mode*.

There are two types of analog button display styles, figure and bitmap. These styles can be changed on the *[Style tab]*.

Figure A-68. Analog Button Properties Dialog Box: [Analog Button Connection] Tab

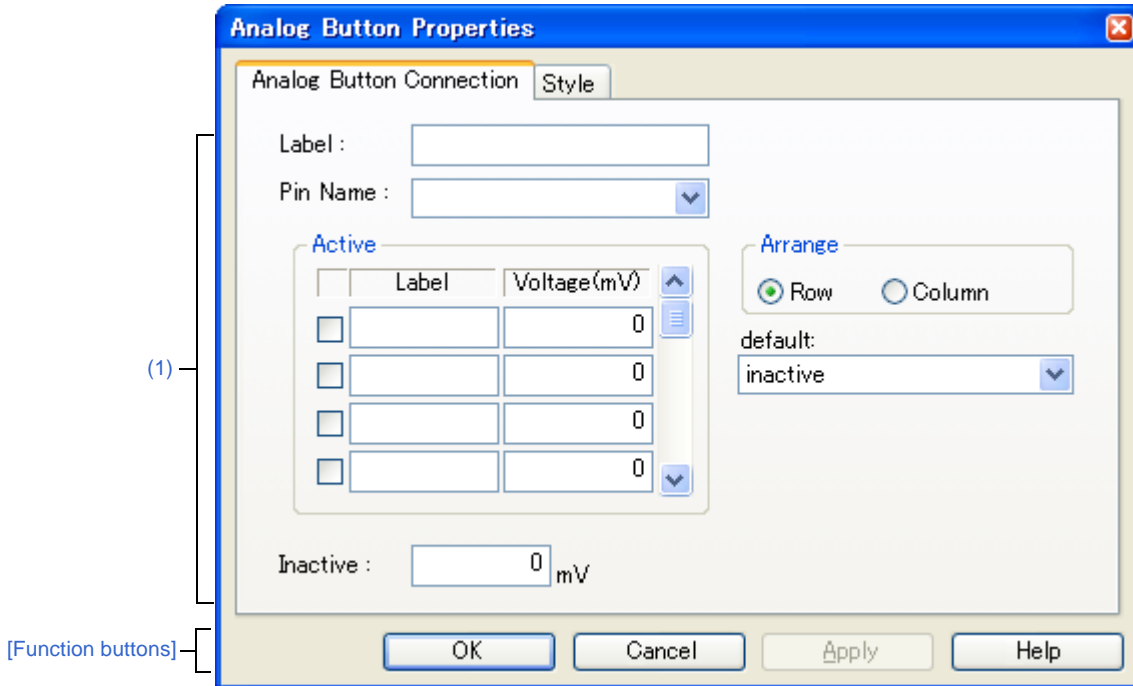
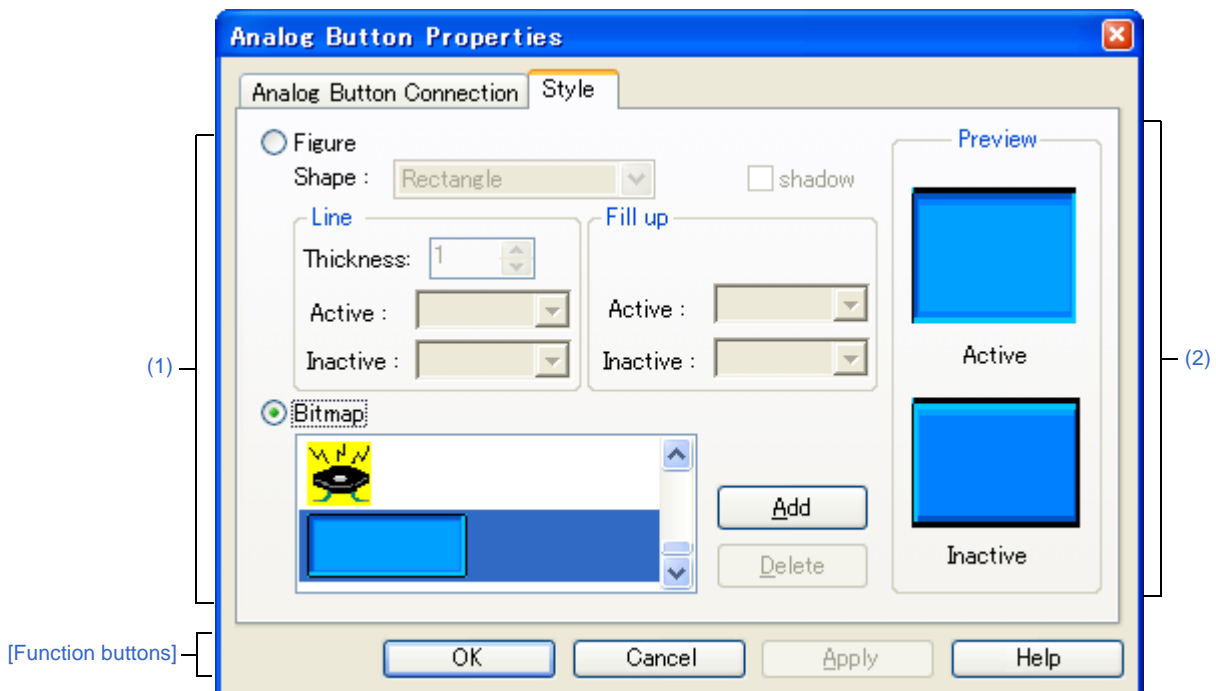

Figure A-69. Analog Button Properties Dialog Box: [Style] Tab



This section describes the following.

- [How to open]
- [[Analog Button Connection] tab]
- [[Style] tab]
- [Function buttons]
- [Operation]

[How to open]

On the I/O Panel window, any one of the following;

- Double-click a part object "Analog Button".
- Select [Properties...] form the context menu on a part object "Analog Button".
- Select a part object "Analog Button", and then select [Properties...] form the [View] menu.

[[Analog Button Connection] tab]

(1) Pin connection information setting area

Label	This area is used to specify the part name. The part name input here is displayed on the button. Moreover, it is also displayed in the Parts List dialog box as the label.	
Pin Name	This area is used to specify the pin name to be connected. The connection pins can be specified either via direct input or through selection from the drop-down list.	
Active	Specify the active state.	
	Check box	Analog buttons are created by the number of selected check boxes.
	Label	Directly input the name to be displayed on each analog button.
	Voltage(mV)	Directly input the voltage to be input when each analog button is clicked, in mV units.
Arrange	Specify the button arrangement using the option button. This setting is available if two or more analog buttons have been created in the Active area. This setting is ignored if there is only one analog button or no analog buttons have been created.	
	Row	Analog buttons will be arranged horizontally (default).
	Column	Analog buttons will be arranged vertically.
default	Maintains the analog button operation after CPU reset.	
	Not change at reset.	Maintains the analog button status immediately before CPU reset, after CPU reset.
	inactive	All of the analog buttons are non-depressed after CPU reset (default).
	Active is 'xxx'yyy(mV)	The analog button specified with "'xxx'(yyy mV) " is depressed after CPU reset.
Inactive	Specify the input level when no analog buttons are depressed.	

Remark For the pin names that can be specified, see the user's manual of the microcontroller that is used.

[[Style] tab]

(1) Style information setting area

Figure	Select this option button to display the analog button with the following specified figure.		
	Shape	Select the figure shape. Two shapes can be selected: rectangle and ellipse.	
	shadow	Cannot be selected.	
	Line	Specify and change the figure line, as follows. You can change the color of figure line by clicking the pull-down button.	
		Thickness	Specifies the line thickness. Specification is made either using a spin button or through direct input. A value from 1 to 100 can be specified.
		Active	Specifies the color of the line during active display.
		Inactive	Specifies the color of the line during inactive display.
	Fill up	Specify and change the figure filling, as follows. You can change the color of figure filling by clicking the pull-down button.	
		Active	Specifies the fill color during active display.
Inactive		Specifies the fill color during inactive display.	
Bitmap	Select this option button to display the analog button with the following specified bitmap (default).		
	Selection list	Select a bitmap to be used from the selection list. The selectable bitmaps appear in the selection list.	
	[Add] button	Opens the Entry Bitmap dialog box below to add a new bitmap to the selection list. The bitmap file to be added can be specified either through file selection using the [...] button, or through direct input.	
	[Delete] button	Deletes the currently selected bitmap from the selection list. Note that only the bitmap that have been added by user can be deleted.	

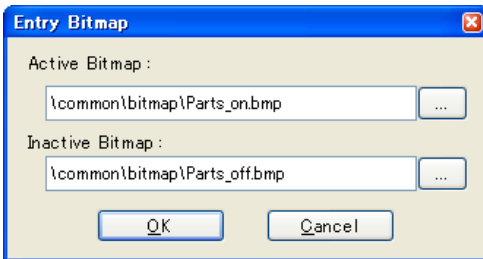

(2) Preview area

This area displays the style of the analog button currently being specified.

[Function buttons]

Button	Function
OK	Validates the settings and closes this dialog box.
Cancel	Cancels the settings and closes this dialog box.
Apply	Cannot be selected.
Help	Displays the help for this dialog box.

[Operation]

In the [Simulation mode](#), while an analog button is depressed, the specified analog voltage value is input to the specified pin.

Clicking the depressed analog button again restores the button to its original state.

Figure A-70. Connected Parts Display Example (Analog Button)

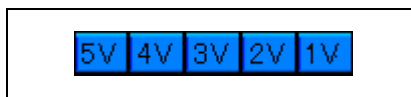

Parts Key Properties dialog box

This property dialog box is used to set or change the pin connection information of a key matrix, which is one of the connection parts in the *I/O Panel window*.

Input to the simulator can be done from pin-connected keys in the *Simulation mode*.

A key matrix consisting of input pins and output pins of up to 16 x 16 can be set.

Either figure or bitmap can be selected as the key matrix display style. These styles can be changed on the *[[Style] tab]*.

Caution When connecting a key matrix to pins, also perform the Pull up/Pull down settings for the connection pins. When a key is pressed, the output value of the output pin connected to that key is input to the input pin connected to that key. The value when the key is not pressed is the value specified in the *Pull up/Pull down dialog box*.

If the Pull up/Pull down settings are not performed, the input pin becomes the high-impedance state. Consequently, the operation of the function that is connected to the input pin becomes undefined.

Figure A-71. Parts Key Properties Dialog Box: [Key Matrix Connection] Tab

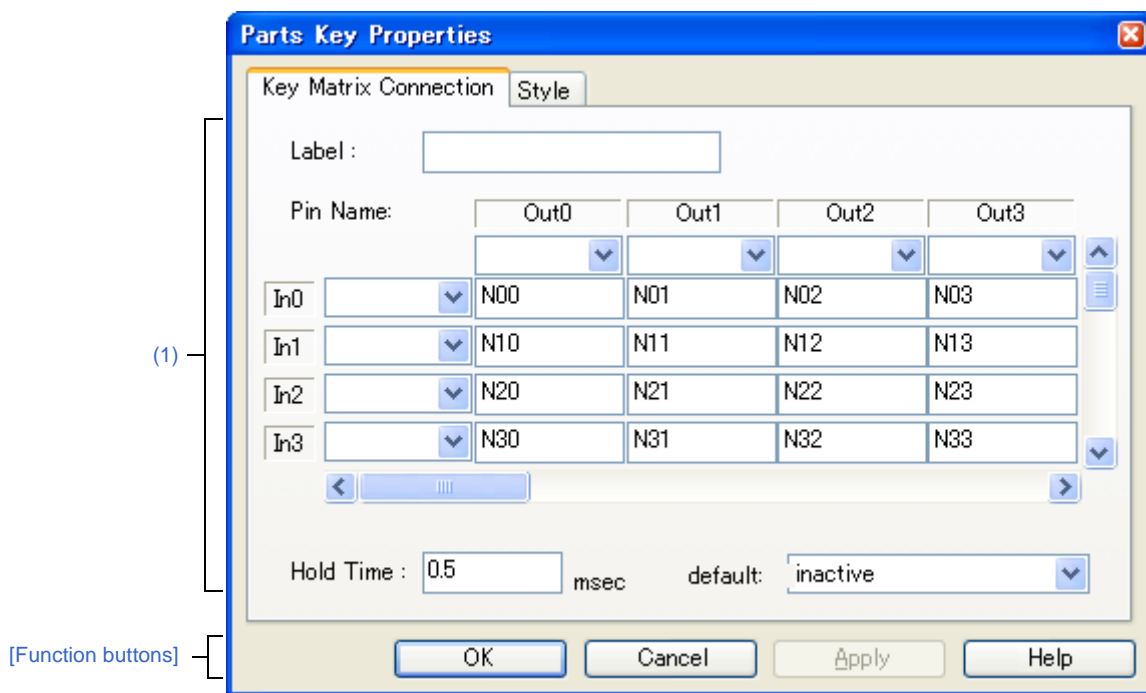
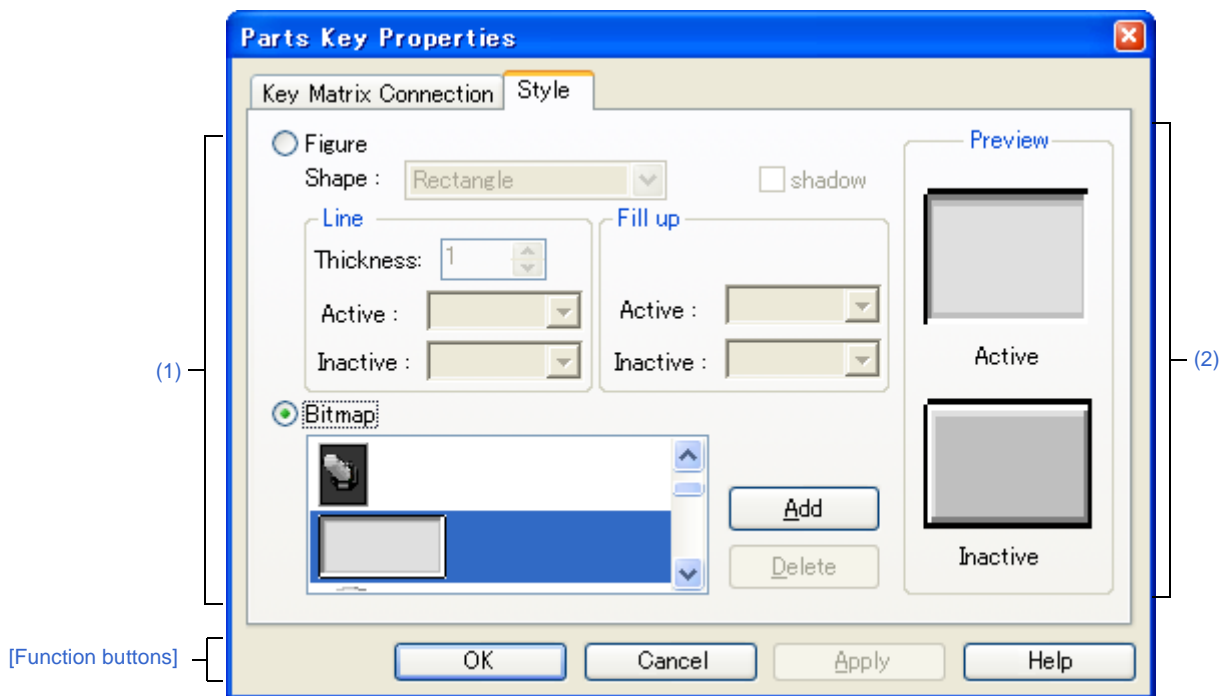

Figure A-72. Parts Key Properties Dialog Box: [Style] Tab



This section describes the following.

- [How to open]
- [[Key Matrix Connection] tab]
- [[Style] tab]
- [Function buttons]
- [Operation]

[How to open]

On the I/O Panel window, any one of the following;

- Double-click a part object "Key matrix".
- Select [Properties...] form the context menu on a part object "Key matrix".
- Select a part object "Key matrix", and then select [Properties...] form the [View] menu.

[[Key Matrix Connection] tab]

(1) Pin connection information setting area

Label	This area is used to specify the part name. The part name input here is also displayed in the Parts List dialog box as the label.
-------	---

Pin Name	This area is used to specify the pin name to be connected (input pins and output pins). The connection pins can be specified either via direct input or through selection from the drop-down list. This area can be used to set 16 x 16 pins using the scrollbar.	
	In0 - In15	Specify input pins.
	Out0 - Out15	Specify output pins.
	N00 - Nff	This area is where the text strings displayed on the keys of the key matrix are specified. Text strings of any length can be specified. The default description string (N number) is not displayed on the keys.
Hold Time	Specify the time (hold time) for which the input value is to be held (default: 0.5msec). The settable range is from 0.001 to 999 (msec). Moreover, when multiple keys for input to the same input pin are pressed during the hold time, only the key that was clicked last is valid.	
default	Specify the key matrix operation after CPU reset.	
	Not change at reset.	The key matrix status does not change after CPU reset.
	inactive	No key matrix buttons are depressed after CPU reset (default).

Remark For the pin names that can be specified, see the user's manual of the microcontroller that is used.

[[Style] tab]

(1) Style information setting area

Figure	Select this option button to display the key matrix with the following specified figure.		
	Shape	Select the figure shape. Two shapes can be selected: rectangle and ellipse.	
	shadow	Cannot be selected.	
	Line	Specify and change the figure line, as follows. You can change the color of figure line by clicking the pull-down button.	
		Thickness	Specifies the line thickness. Specification is made either using a spin button or through direct input. A value from 1 to 100 can be specified.
		Active	Specifies the color of the line during active display.
		Inactive	Specifies the color of the line during inactive display.
	Fill up	Specify and change the figure filling, as follows. You can change the color of figure filling by clicking the pull-down button.	
		Active	Specifies the fill color during active display.
		Inactive	Specifies the fill color during inactive display.

Bitmap	Select this option button to display the key matrix with the following specified bitmap (default).	
	Selection list	Select a bitmap to be used from the selection list. The selectable bitmaps appear in the selection list.
	[Add] button	Opens the Entry Bitmap dialog box below to add a new bitmap to the selection list. The bitmap file to be added can be specified either through file selection using the [...] button, or through direct input.
	[Delete] button	Deletes the currently selected bitmap from the selection list. Note that only the bitmap that have been added by user can be deleted.

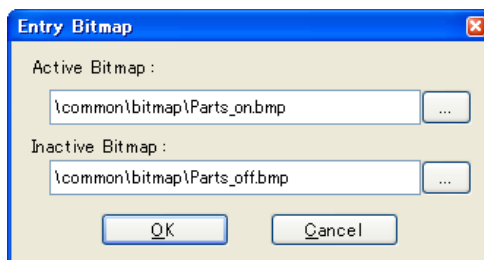

(2) Preview area

This area displays the style of the key matrix currently being specified.

[Function buttons]

Button	Function
OK	Validates the settings and closes this dialog box.
Cancel	Cancels the settings and closes this dialog box.
Apply	Cannot be selected.
Help	Displays the help for this dialog box.

[Operation]

In the [Simulation mode](#), the following operation can be done.

- (1) [Inputting multiple keys simultaneously](#)
- (2) [Locking the key input value](#)

(1) Inputting multiple keys simultaneously

To enter two keys, simultaneously press the key to be input and right-click the mouse to enter the wait status. Then, click the other key. This releases the wait status and enables simultaneous input of both keys. Multiple keys can be simultaneously input by setting the wait status for multiple keys, but if input is to be performed to the same input pin, the key that was input last is valid.

(2) Locking the key input value

To enter two keys, simultaneously press the key to be input and right-click the mouse to enter the wait status. Then, click the other key. This releases the wait status and enables simultaneous input of both keys. Multiple keys can be simultaneously input by setting the wait status for multiple keys, but if input is to be performed to the same input pin, the key that was input last is valid.

Figure A-73. Connected Parts Display Example (Key Matrix)

1	2	3
4	5	6
7	8	9
10	11	12

Parts Level Gauge Properties dialog box

This property dialog box is used to set or change the pin connection information of level gauge, which are one of the connection parts in the [I/O Panel window](#).

Input to the simulator can be done from pin-connected level gauge in the [Simulation mode](#).

Note that the connection pin must be an analog input pin.

There are two types of level gauge display styles, slide and dial. These styles can be changed on the [\[\[Style\] tab\]](#).

Figure A-74. Parts Level Gauge Properties Dialog Box: [Level Gauge Connection] Tab

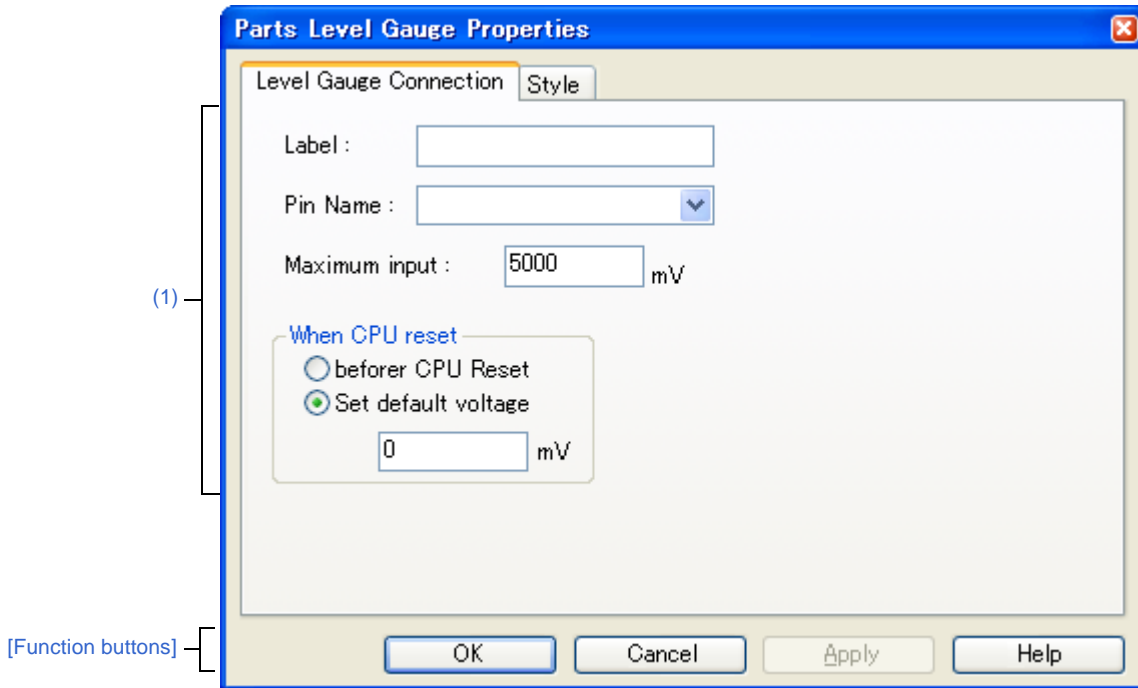
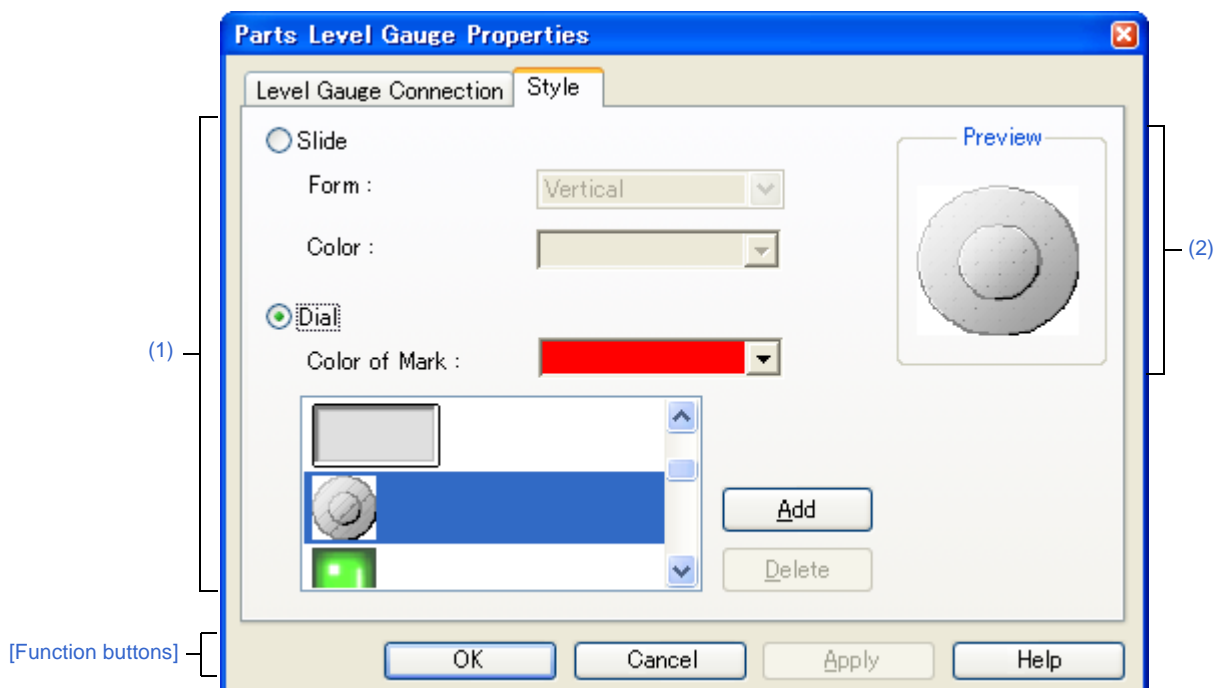

Figure A-75. Parts Level Gauge Properties Dialog Box: [Style] Tab



This section describes the following.

- [How to open]
- [Level Gauge Connection] tab
- [[Style] tab]
- [Function buttons]
- [Operation]

[How to open]

- On the *I/O Panel window*, select a connection part ([Level Gauge]), and then select [Properties...] from the [View] menu.
- On the *I/O Panel window*, double-click a connection part ([Level Gauge]).

[Level Gauge Connection] tab

(1) Pin connection information setting area

Label	This area is used to specify the part name. The part name input here is also displayed in the Parts List dialog box as the label.	
Pin Name	This area is used to specify the pin name to be connected. The connection pins can be specified either via direct input or through selection from the drop-down list.	
Maximum input	This area is used to set the maximum level gauge input value (default: 5000mV). The settable range is from 0 to 65535. The operation range of the level gauge displayed in the <i>I/O Panel window</i> is determined by this specified value.	
When CPU reset	Specify the level gauge operation after CPU reset.	
	before CPU Reset	Maintains the level gauge status of immediately before CPU reset, after CPU reset.
	Set default voltage	The level gauge is set to the specified value after CPU reset (default). Specify the value in mV units. Input a value from 0 to "Maximum input:". (default: 0 mV)

Remark For the pin names that can be specified, see the user's manual of the microcontroller that is used.

[[Style] tab]

(1) Style information setting area

Slide	Select this option button to display the level gauge with the side-type.	
	Form	Select the slide direction (vertical or horizontal) from the drop-down list.
	Color	This area is used to specify or change the slide color. You can change the color by clicking the pull-down button.

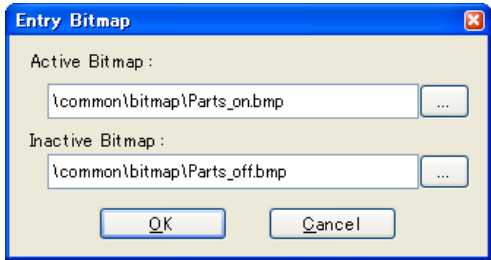
Dial	Select this option button to display the level gauge with the dial-type (default).
Color of Mark	This area is used to specify or change the color of the mark indicating the operating point. You can change the color by clicking the pull-down button.
Selection list	Select a bitmap to be used from the selection list. The selectable bitmaps appear in the selection list.
[Add] button	Opens the Entry Bitmap dialog box below to add a new bitmap to the selection list. The bitmap file to be added can be specified either through file selection using the [...] button, or through direct input. 
[Delete] button	Deletes the currently selected bitmap from the selection list. Note that only the bitmap that have been added by user can be deleted.

(2) Preview area

This area displays the style of the level gauge currently being specified.

[Function buttons]

Button	Function
OK	Validates the settings and closes this dialog box.
Cancel	Cancels the settings and closes this dialog box.
Apply	Cannot be selected.
Help	Displays the help for this dialog box.

[Operation]

In the [Simulation mode](#), analog input from the level gauge is performed through manipulation of the displayed slider or dial.

The value specified in [Maximum input] is the maximum value that can be input.

Input is enabled by selecting the [Figure] menu >> [Simulation Mode].

Figure A-76. Connected Parts Display Example (Level Gauge)

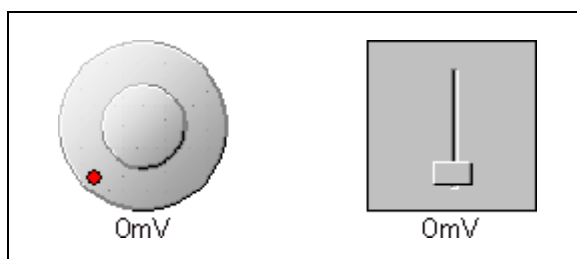

Dial-type level gauge	The displayed analog value changes as the operating point (red circle) on the dial is moved by dragging it with the mouse. When this analog value has become the value that is to be input, release the operating point. As a result, the displayed analog value is input. The operating point can also be moved by clicking the desired location on the dial.
Slide-type level gauge	The displayed analog value changes as the slider button is moved by dragging it with the mouse. When this analog value has become the value that is to be input, release the button. As a result, the displayed analog value is input. The button can also be moved by clicking the desired location on the slider.

Caution If you drag and drop the dial's operation point (red circle) or the slider's knob away from the level gauge, then the voltage displayed in the level gauge will change, but the voltage actually output by the level gauge will not change. Make sure to always drag and drop over the level gauge.

Parts Led Properties dialog box

This property dialog box is used to set or change the pin connection information of LED, which are one of the connection parts in the [I/O Panel window](#).

A pin-connected LED displays the information output from the simulator through lit/unlit display in the [Simulation mode](#). There are two types of LED display styles, figure and bitmap. These styles can be changed on the [\[Style\] tab](#).

Figure A-77. Parts Led Properties Dialog Box: [LED Connection] Tab

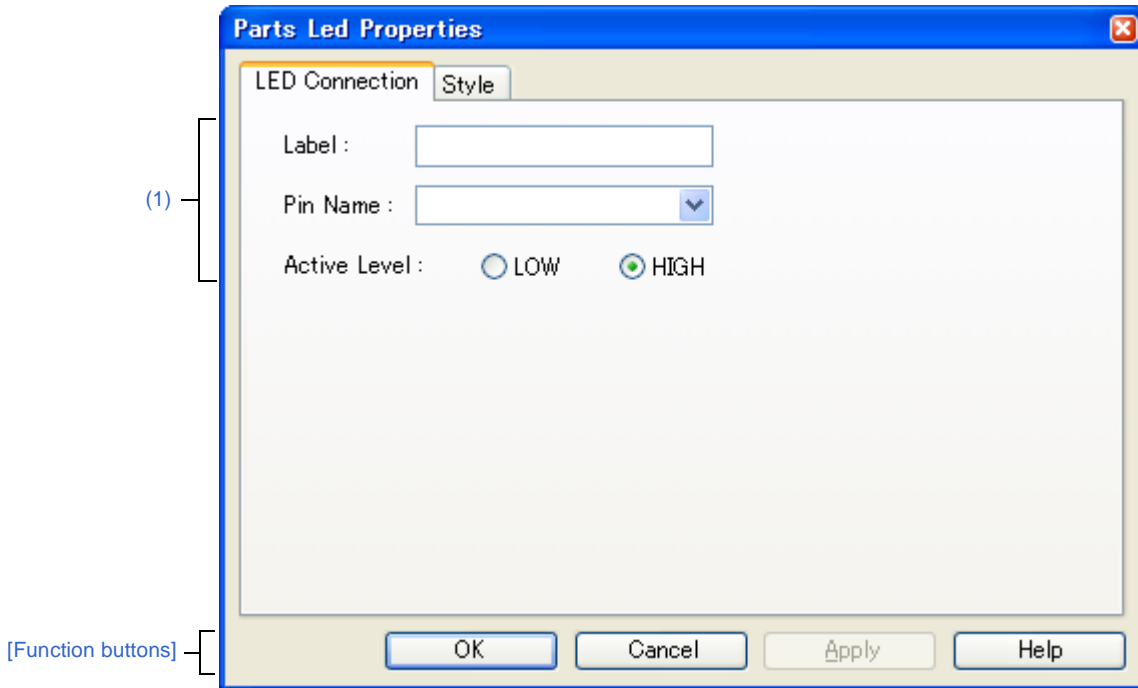
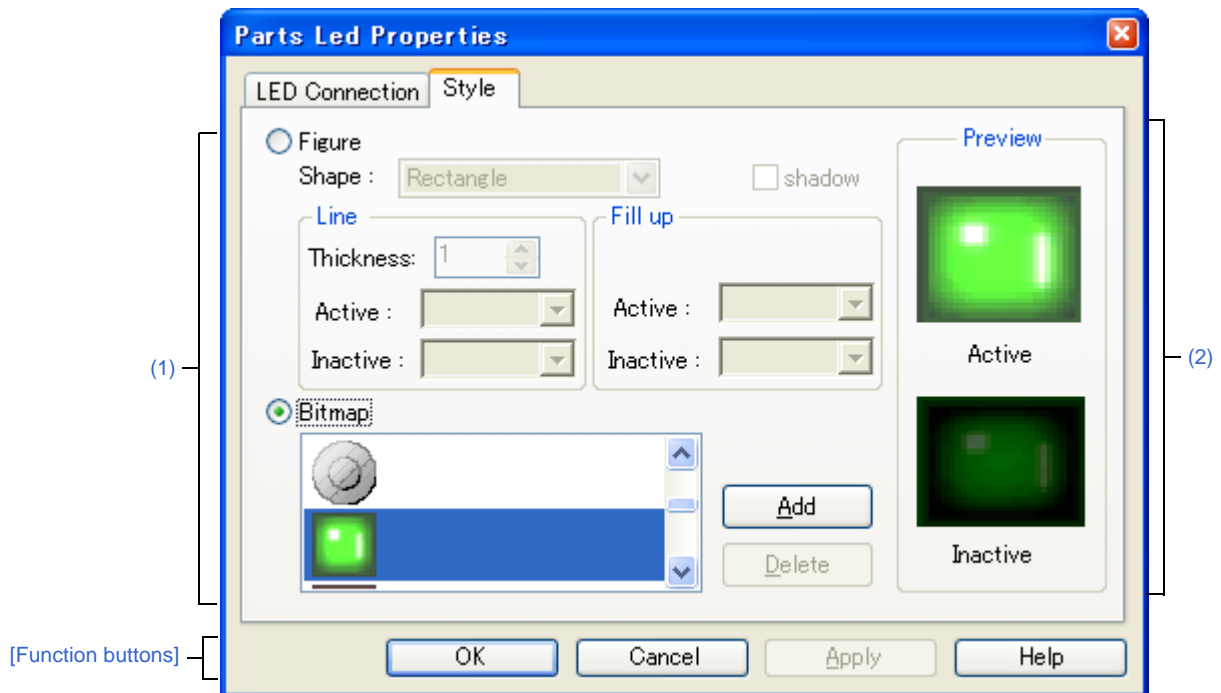

Figure A-78. Parts Led Properties Dialog Box: [Style] Tab



This section describes the following.

- [How to open]
- [[LED Connection] tab]
- [[Style] tab]
- [Function buttons]
- [Operation]

[How to open]

On the I/O Panel window, any one of the following;

- Double-click a part object "LED".
- Select [Properties...] form the context menu on a part object "LED".
- Select a part object "LED", and then select [Properties...] form the [View] menu.

[[LED Connection] tab]

(1) Pin connection information setting area

Label	This area is used to specify the part name. The part name input here is also displayed in the Parts List dialog box as the label.	
Pin Name	This area is used to specify the pin name to be connected (output pin). The connection pins can be specified either via direct input or through selection from the drop-down list.	
Active Level	The active state is selected with a option button, as follows:	
	LOW	Sets the active level to LOW.
	HIGH	Sets the active level to HIGH (default).

Remark For the pin names that can be specified, see the user's manual of the microcontroller that is used.

[[Style] tab]

(1) Style information setting area

Figure	Select this option button to display the LED with the following specified figure.		
	Shape	Select the figure shape. Two shapes can be selected: rectangle and ellipse.	
	shadow	Cannot be selected.	
	Line	Specify and change the figure line, as follows. You can change the color of figure line by clicking the pull-down button.	
		Thickness	Specifies the line thickness. Specification is made either using a spin button or through direct input. A value from 1 to 100 can be specified.
		Active	Specifies the color of the line during active display.
		Inactive	Specifies the color of the line during inactive display.
	Fill up	Specify and change the figure filling, as follows. You can change the color of figure filling by clicking the pull-down button.	
		Active	Specifies the fill color during active display.
		Inactive	Specifies the fill color during inactive display.

Bitmap	Select this option button to display the LED with the following specified bitmap (default).	
	Selection list	Select a bitmap to be used from the selection list. The selectable bitmaps appear in the selection list.
	[Add] button	Opens the Entry Bitmap dialog box below to add a new bitmap to the selection list. The bitmap file to be added can be specified either through file selection using the [...] button, or through direct input.
	[Delete] button	Deletes the currently selected bitmap from the selection list. Note that only the bitmap that have been added by user can be deleted.

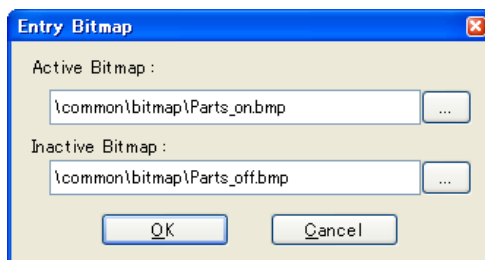

(2) Preview area

This area displays the style of the LED currently being specified.

[Function buttons]

Button	Function
OK	Validates the settings and closes this dialog box.
Cancel	Cancels the settings and closes this dialog box.
Apply	Cannot be selected.
Help	Displays the help for this dialog box.

[Operation]

In the [Simulation mode](#), the output status (active/inactive) of the connected pins is displayed in real-time using two types of bitmaps or figures.

Figure A-79. Connected Parts Display Example (LED)



Parts Segment LED Properties dialog box

This property dialog box is used to set or change the pin connection information of 7-segment LED and 14-segment LED, which are one of the connection parts in the I/O Panel window.

A LED connected to pins displays the information output from the simulator in the Simulation mode.

The segment LED display styles can be changed on the [[Style] tab].

Figure A-80. Parts Segment LED Properties Dialog Box: [SegmentLED Connection] Tab

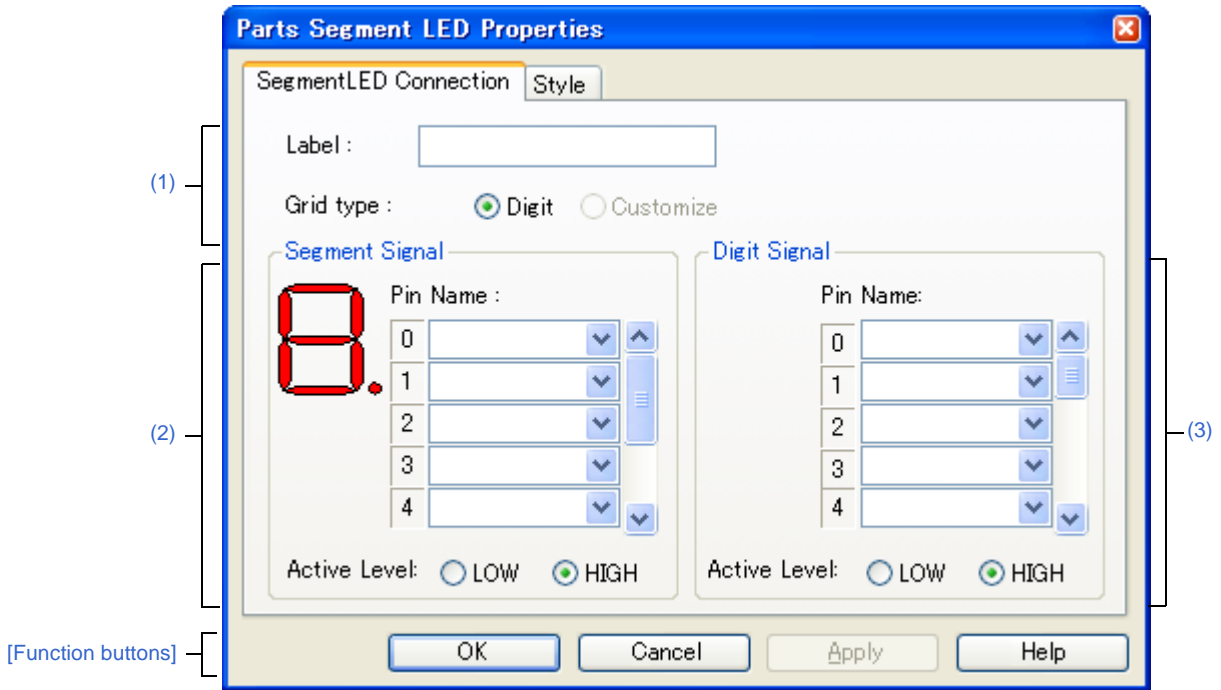
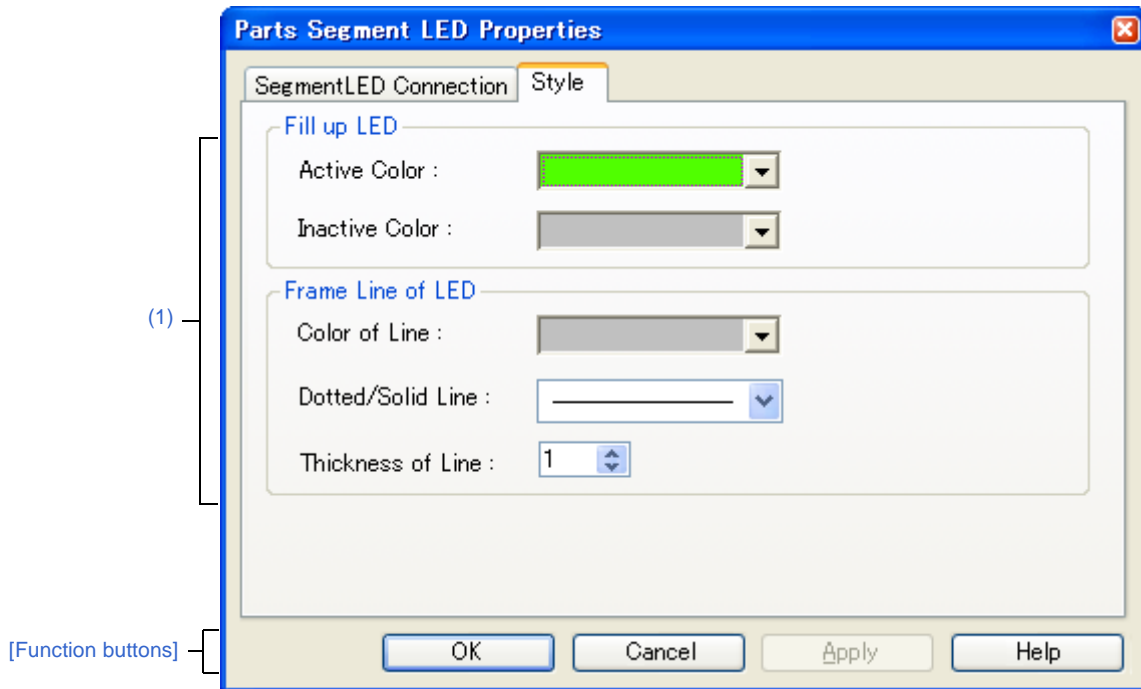

Figure A-81. Parts Segment LED Properties Dialog Box: [Style] Tab



This section describes the following.

- [How to open]
- [[SegmentLED Connection] tab]
- [[Style] tab]
- [Function buttons]
- [Operation]

[How to open]

On the I/O Panel window, any one of the following;

- Double-click a part object "7-segment LED"/"14-segment LED".
- Select [Properties...] form the context menu on a part object "7-segment LED"/"14-segment LED".
- Select a part object "7-segment LED"/"14-segment LED", and then select [Properties...] form the [View] menu.

[[SegmentLED Connection] tab]

(1) Pin connection information setting area

Label	This area is used to specify the part name. The part name input here is also displayed in the Parts List dialog box as the label.	
Grid type	Select the grid signal allocation method from the following. As a result of the selection, the setting in the Digit signal setting area changes.	
	Digit	Connects each segment LED to 1 grid pin. Digit signal settings are performed in the Digit signal setting area (default). 16 digits can be specified for the digit signal. A segment LED of up to 16 digits can be created with 1 segment LED part.
	Customize	Cannot be selected.

(2) Segment signal setting area

Segment Signal	This area is used to specify the pins (output pins) to be connected to the segment signals of the 7-segment LED/14-segment LED, as well as their active level.	
	Figure	This area displays the bitmap of the 7-segment LED/14-segment LED at the top left. When "Pin Name:" is input, the corresponding location is indicated.
	Pin Name	The connection pins can be specified either via direct input or through selection from the drop-down list. The number of segment pins to be connected is 8 in the case of a 7-segment LED, and 15 in the case of a 14-segment LED. Connection to all the segment pins is possible by using the scroll bar on the right side.
	Active Level	The active status can be selected with a option button, as follows:
LOW		Sets the active level to LOW.
HIGH		Sets the active level to HIGH (default).

Remark For the pin names that can be specified, see the user's manual of the microcontroller that is used.

(3) Digit signal setting area

Digit Signal	This area is used to specify 7-segment LED/14-segment LED digits, grid signal connection pins (output pins), and their active level. The connection method changes as follows according to what is specified for [Grid type]. - When [Digit] selected Perform digit signal setting. The maximum number of digit pins that can be connected is 16. Connection to all the digit pins can be done by using the scroll bar on the right side of the area. - When [Customize] selected Cannot be selected.		
	Pin Name	The connection pins can be specified either via direct input or through selection from the drop-down list. As the setting signal, specify the connection pins in a series from the lowermost digit.	
	Active Level	The active status can be selected with a option button, as follows:	
		LOW	Sets the active level to LOW.
HIGH	Sets the active level to HIGH (default).		

Remark For the pin names that can be specified, see the user's manual of the microcontroller that is used.

[[Style] tab]

(1) Style information setting area

Full up LED	This area is used to set and change related to the filling of each cell of the object are performed. You can change the color by clicking the pull-down button.	
	Active Color	Specifies the fill color during active display.
	Inactive Color	Specifies the fill color during inactive display.
Frame Line of LED	This area is used to set and change related to the frame of each cell of the object are performed.	
	Color of Line	Specifies and changes the line color. You can change the color by clicking the pull-down button.
	Dotted/Solid Line	Specifies and changes the line shape (dotted/solid). The desired line shape can be selected from the drop-down list. The line shape can be specified only when the line thickness is "1" in [Thickness of Line].
	Thickness of Line	Specifies and changes the line thickness. The desired line thickness can be specified either via direct input or through selection from the spin button. A value in the range of 1 to 100 (decimal) can be specified.

[Function buttons]

Button	Function
OK	Validates the settings and closes this dialog box.
Cancel	Cancel the settings and closes this dialog box.
Apply	Cannot be selected.
Help	Displays the help for this dialog box.

[Operation]

In the [Simulation mode](#), as the results of 1 simulation, the output information of the connection pins is received and display is performed accordingly. When both the digit/grid signals and segment signals are active output, the segment LED of the corresponding digit/grid light.

Figure A-82. Connected Parts Display Example (7-segment LED)

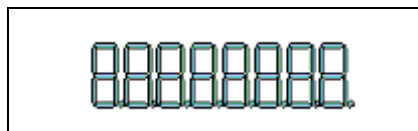

Parts Matrix Led Properties dialog box

This property dialog box is used to set or change the pin connection information of matrix LED, which are one of the connection parts in the I/O Panel window.

A pin-connected matrix LED displays the information output from the simulator through lit/unlit display in the Simulation mode.

There are two types of matrix LED display styles, figure and bitmap. These styles can be changed on the [[Style] tab].

Figure A-83. Parts Matrix Led Properties Dialog Box: [Matrix LED Connection] Tab

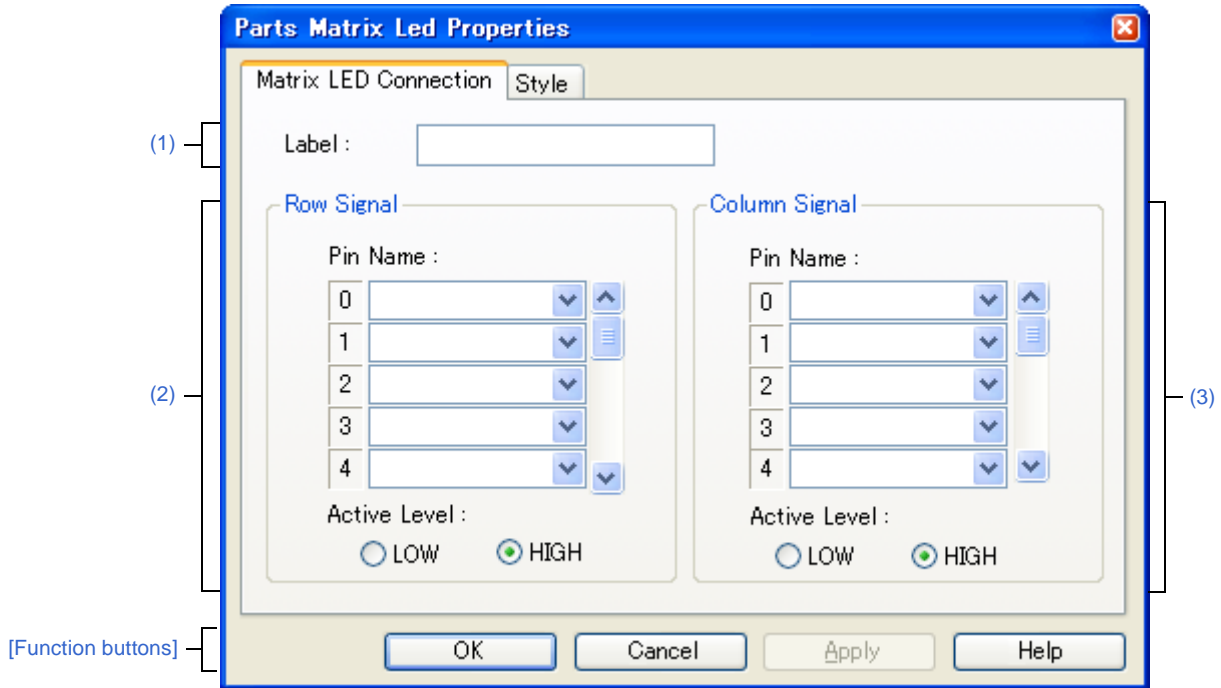
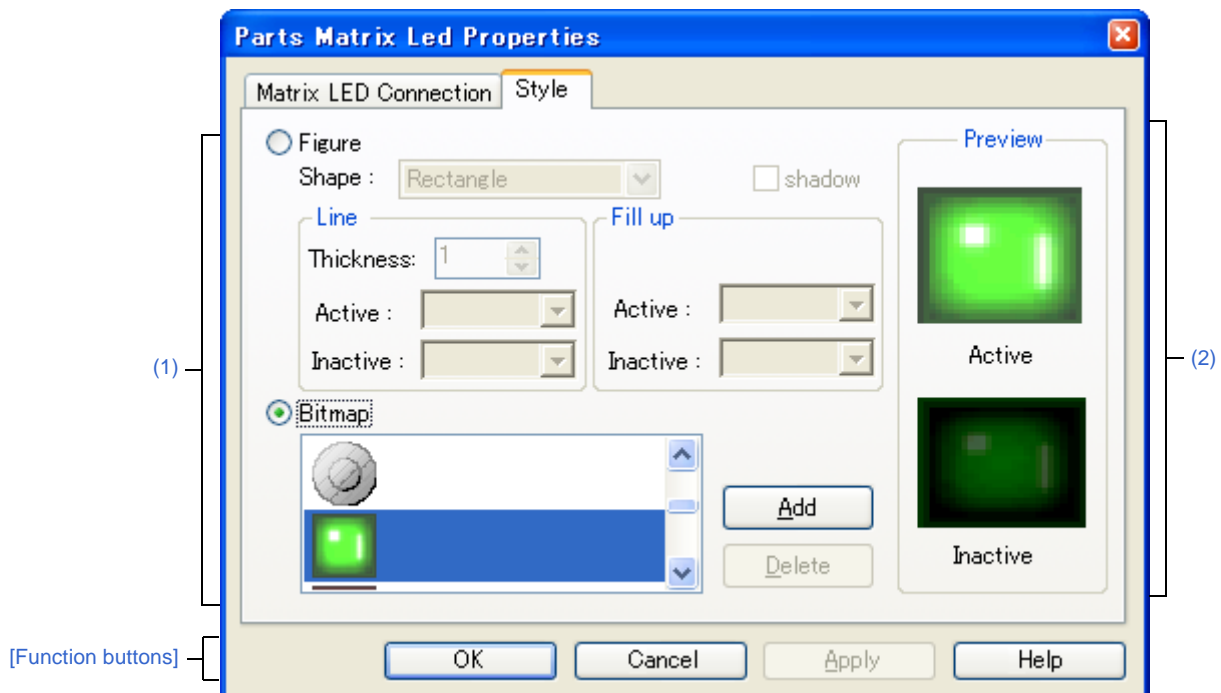

Figure A-84. Parts Matrix Led Properties Dialog Box: [Style] Tab



This section describes the following.

- [How to open]
- [[Matrix LED Connection] tab]
- [[Style] tab]
- [Function buttons]
- [Operation]

[How to open]

On the I/O Panel window, any one of the following;

- Double-click a part object "Matrix LED".
- Select [Properties...] form the context menu on a part object "Matrix LED".
- Select a part object "Matrix LED", and then select [Properties...] form the [View] menu.

[[Matrix LED Connection] tab]

(1) [Label]

Label	This area is used to specify the part name. The part name input here is also displayed in the Parts List dialog box as the label.
-------	---

(2) Row direction signals setting area

Row Signal	This area is used to specify the output pins connected to the matrix LED row direction signals and their active level.			
	Pin Name	A maximum of 16 pins can be connected. Connection to all the row direction signals can be done by using the scrollbar located on the right side of the pin name input area.		
	Active Level	The active status can be selected with a option button, as follows:		
		<table border="1" style="width: 100%;"> <tr> <td style="width: 20%;">LOW</td> <td>Sets the active level to LOW.</td> </tr> <tr> <td>HIGH</td> <td>Sets the active level to HIGH (default).</td> </tr> </table>	LOW	Sets the active level to LOW.
LOW	Sets the active level to LOW.			
HIGH	Sets the active level to HIGH (default).			

Remark For the pin names that can be specified, see the user's manual of the microcontroller that is used.

(3) Column direction signals setting area

Column Signal	This area is used to specify the output pins connected to the matrix LED column direction signals and their active level.			
	Pin Name	The connection pins can be specified either via direct input or through selection from the drop-down list.A maximum of 16 pins can be connected. Connection to all the column direction signals can be done by using the scrollbar located on the right side of the pin name input area.		
	Active Level	The active status can be selected with a option button, as follows:		
		<table border="1" style="width: 100%;"> <tr> <td style="width: 20%;">LOW</td> <td>Sets the active level to LOW.</td> </tr> <tr> <td>HIGH</td> <td>Sets the active level to HIGH (default).</td> </tr> </table>	LOW	Sets the active level to LOW.
LOW	Sets the active level to LOW.			
HIGH	Sets the active level to HIGH (default).			

Remark For the pin names that can be specified, see the user's manual of the microcontroller that is used.

[[Style] tab]

(1) Style information setting area

Figure	Select this option button to display the matrix LED with the following specified figure.		
	Shape	Select the figure shape. Two shapes can be selected: rectangle and ellipse.	
	shadow	Cannot be selected.	
	Line	Specify and change the figure line, as follows. You can change the color of figure line by clicking the pull-down button.	
		Thickness	Specifies the line thickness. Specification is made either using a spin button or through direct input. A value from 1 to 100 can be specified.
		Active	Specifies the color of the line during active display.
		Inactive	Specifies the color of the line during inactive display.
	Fill up	Specify and change the figure filling, as follows. You can change the color of figure filling by clicking the pull-down button.	
		Active	Specifies the fill color during active display.
Inactive		Specifies the fill color during inactive display.	
Bitmap	Select this option button to display the matrix LED with the following specified bitmap (default)		
	Selection list	Select a bitmap to be used from the selection list. The selectable bitmaps appear in the selection list.	
	[Add] button	Opens the Entry Bitmap dialog box below to add a new bitmap to the selection list. The bitmap file to be added can be specified either through file selection using the [...] button, or through direct input.	
	[Delete] button	Deletes the currently selected bitmap from the selection list. Note that only the bitmap that have been added by user can be deleted.	

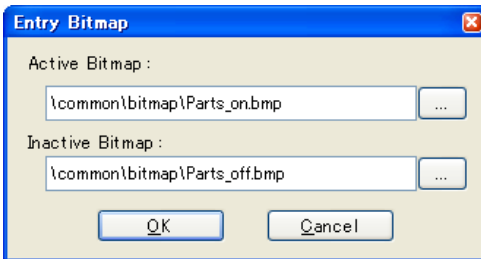

(2) Preview area

This area displays the style of the matrix LED currently being specified.

[Function buttons]

Button	Function
OK	Validates the settings and closes this dialog box.
Cancel	Cancels the settings and closes this dialog box.
Apply	Cannot be selected.
Help	Displays the help for this dialog box.

[Operation]

In the [Simulation mode](#), as the results of 1 simulation, the output information of the connection pins is received and display is performed accordingly. When the matrix intersection of a row pin and column pin is active, the corresponding LED lights.

Figure A-85. Connected Parts Display Example (Matrix LED)

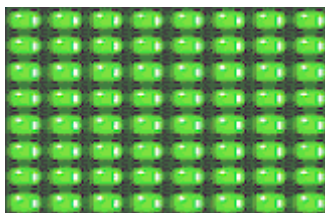

Parts Buzzer Properties dialog box

This property dialog box is used to set or change the pin connection information of a buzzer, which is one of the connection parts in the [I/O Panel window](#).

The pin-connected buzzer displays the information output from the connected pins as a bitmap in the [Simulation mode](#).

The buzzer output can be checked as "display".

There are two types of buzzer display styles, figure and bitmap. These styles can be changed on the [\[\[Style\] tab\]](#).

Figure A-86. Parts Buzzer Properties Dialog Box: [Buzzer Connection] Tab

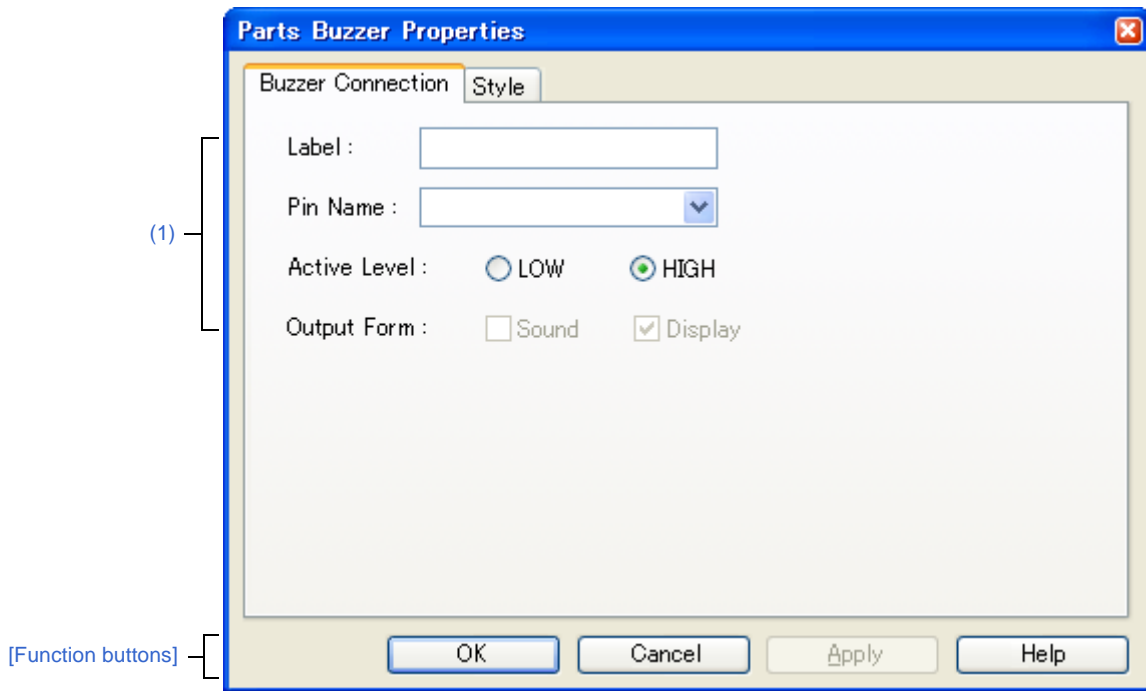
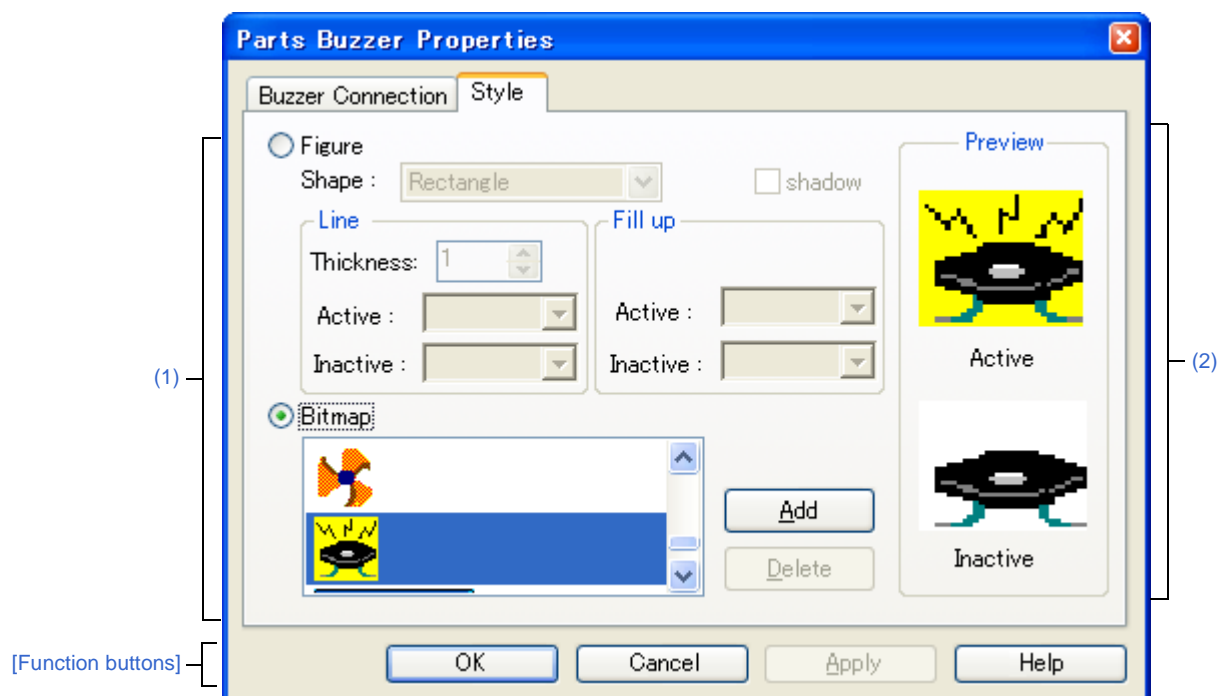

Figure A-87. Parts Buzzer Properties Dialog Box: [Style] Tab



This section describes the following.

- [How to open]
- [[Buzzer Connection] tab]
- [[Style] tab]
- [Function buttons]
- [Operation]

[How to open]

On the I/O Panel window, any one of the following;

- Double-click a part object "Buzzer".
- Select [Properties...] form the context menu on a part object "Buzzer".
- Select a part object "Buzzer", and then select [Properties...] form the [View] menu.

[[Buzzer Connection] tab]

(1) Pin connection information setting area

Label	This area is used to specify the part name. The part name input here is also displayed in the Parts List dialog box as the label.	
Pin Name	This area is used to specify the pin name to be connected (output pin). The connection pins can be specified either via direct input or through selection from the drop-down list.	
Active Level	The active state is selected with a option button, as follows:	
	LOW	Sets the active level to LOW.
	HIGH	Sets the active level to HIGH (default).
Output Form	This item is not allowed to change.	

Remark For the pin names that can be specified, see the user's manual of the microcontroller that is used.

[[Style] tab]

(1) Style information setting area

Figure	Select this option button to display the buzzer with the following specified figure.		
	Shape	Select the figure shape. Two shapes can be selected: rectangle and ellipse.	
	shadow	Cannot be selected.	
	Line	Specify and change the figure line, as follows. You can change the color of figure line by clicking the pull-down button.	
		Thickness	Specifies the line thickness. Specification is made either using a spin button or through direct input. A value from 1 to 100 can be specified.
		Active	Specifies the color of the line during active display.
		Inactive	Specifies the color of the line during inactive display.
	Fill up	Specify and change the figure filling, as follows. You can change the color of figure filling by clicking the pull-down button.	
		Active	Specifies the fill color during active display.
Inactive		Specifies the fill color during inactive display.	
Bitmap	Select this option button to display the buzzer with the following specified bitmap (default).		
	Selection list	Select a bitmap to be used from the selection list. The selectable bitmaps appear in the selection list.	
	[Add] button	Opens the Entry Bitmap dialog box below to add a new bitmap to the selection list. The bitmap file to be added can be specified either through file selection using the [...] button, or through direct input.	
	[Delete] button	Deletes the currently selected bitmap from the selection list. Note that only the bitmap that have been added by user can be deleted.	

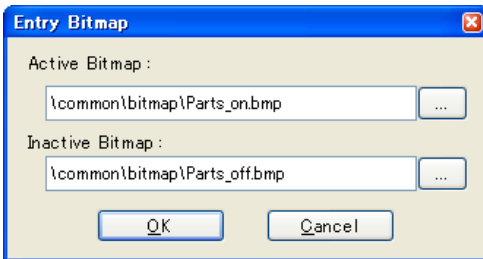

(2) Preview area

This area displays the style of the buzzer currently being specified.

[Function buttons]

Button	Function
OK	Validates the settings and closes this dialog box.
Cancel	Cancels the settings and closes this dialog box.
Apply	Cannot be selected.
Help	Displays the help for this dialog box.

[Operation]

In the [Simulation mode](#), the active level output of the connected pins can be expressed as a bitmap.
 The following bitmaps are displayed according to the pin's output value (active/inactive).

Figure A-88. Connected Parts Display Example (Buzzer)

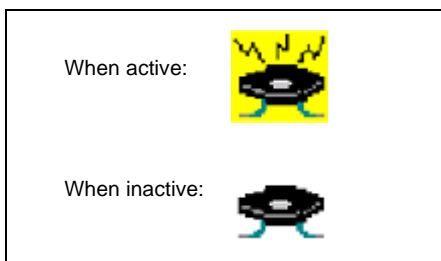

Pull up/Pull down dialog box

This dialog box is used to set or change the pin connection information of the pull-up/pull-down resistors, which are one of the connection parts of the *I/O Panel window*.

The setting method for these connection parts differs from those for other parts. The connection information of all the pins is managed as a group in this dialog box.

Figure A-89. Pull up/Pull down Dialog Box

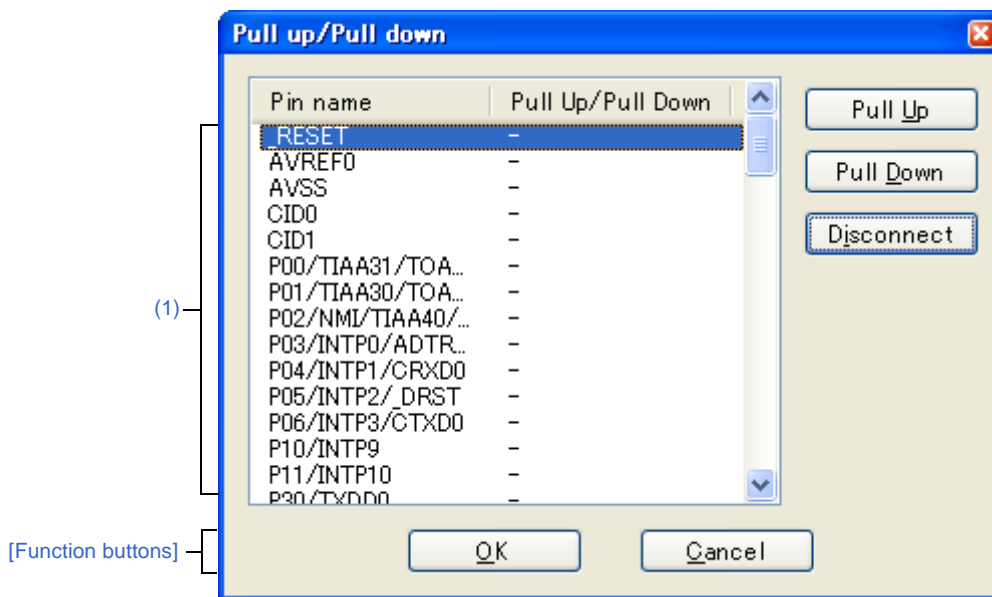

This section describes the following.

- [How to open]
- [Description of each area]
- [Function buttons]

[How to open]

- With the *I/O Panel window* in focus, click the  button or select [Pull up/Pull down...] from the [Parts] menu.

[Description of each area]

(1) Connection information display area

Pin name	Displays the names of the pins that can be connected to pull-up/pull-down resistors.	
Pull Up/Pull Down	Displays the connected status of the pins.	
	Pull Up	Indicates pull-up resistor is connected.
	Pull Down	Indicates pull-down resistor connected.
	-	Indicates no pull-up/pull-down resistor connected.
Buttons	Changes the pin connection information of the pull-up/pull-down resistors.	
	[Pull Up]	Connects the pins selected to pull-up resistors. When connection is completed, "Pull Up" is displayed.
	[Pull Down]	Connects the pins selected to pull-down resistors. When connection is completed, "Pull Down" is displayed.
	[Disconnect]	Cancel the connected status of the pins selected. When connection is completed, "-" is displayed.

[Function buttons]

Button	Function
OK	Validates the settings and closes this dialog box.
Cancel	Cancel the settings and closes this dialog box.

Object Properties dialog box

This property dialog box is used to set or change the connection information fed to the pins of figure object (including text and bitmap) of the I/O Panel window.

Show/hide can be switched for each pin-connected object by the output status of the connected pins in the Simulation mode.

The default status of each signal is active HIGH. Display styles can be changed on the [[Style] tab].

Figure A-90. Object Properties Dialog Box: [Object Connection] Tab

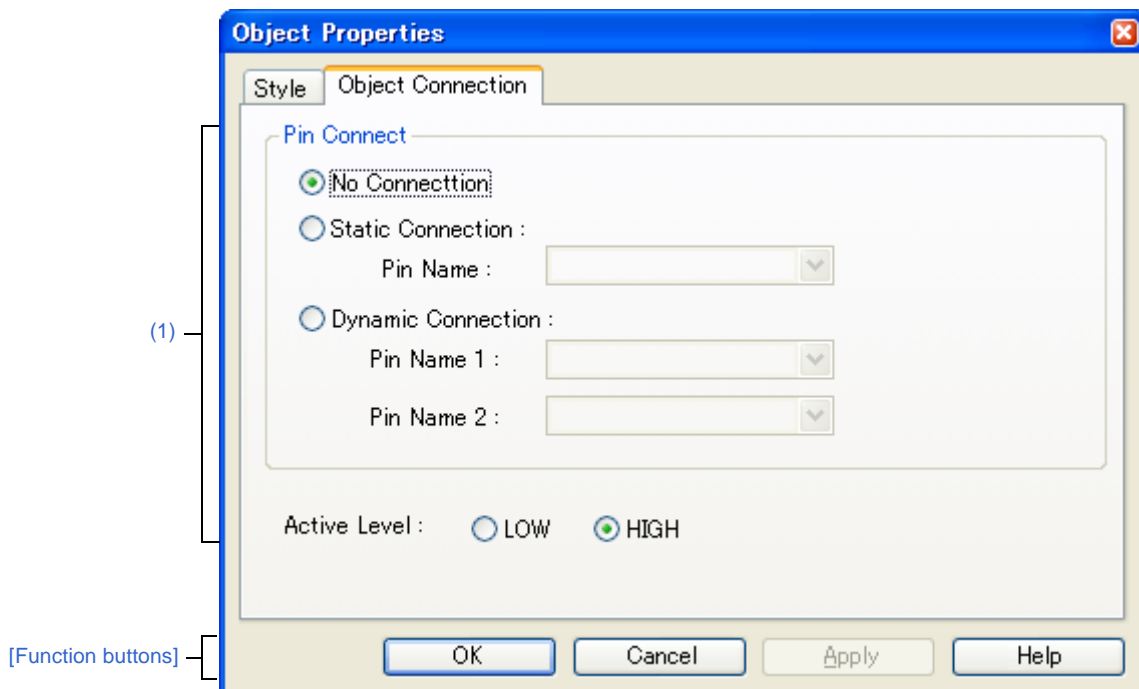
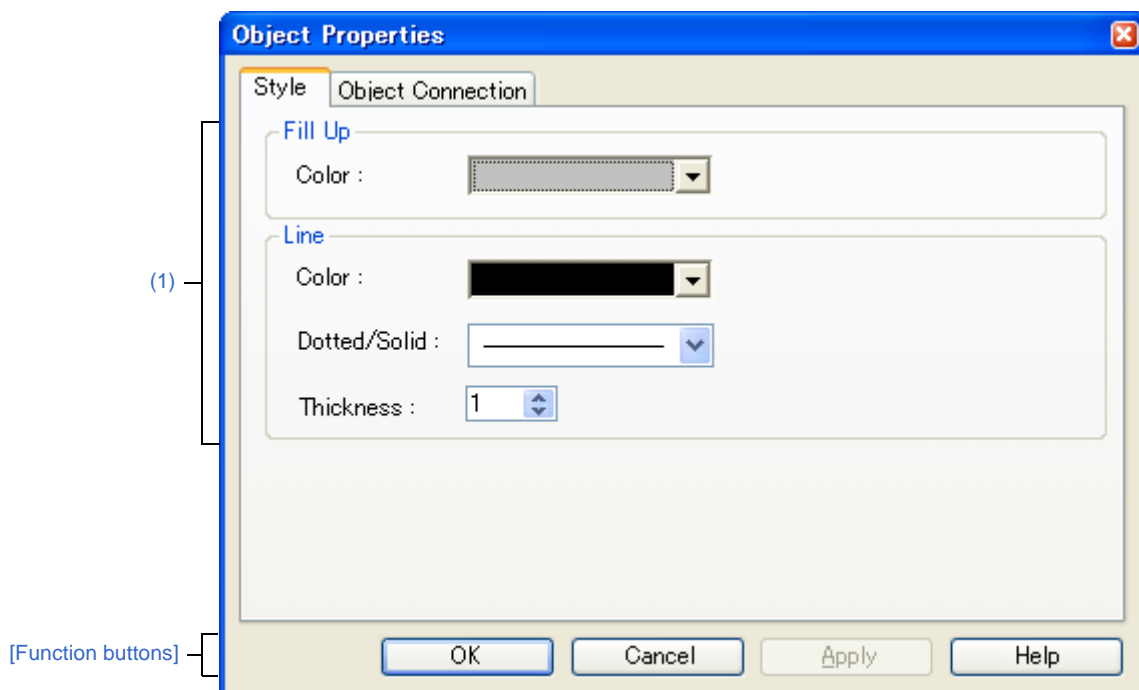

Figure A-91. Object Properties Dialog Box: [Style] Tab



This section describes the following.

- [How to open]
- [[Object Connection] tab]
- [[Style] tab]
- [Function buttons]

[How to open]

On the I/O Panel window, any one of the following;

- Double-click a figure object.
- Select [Properties...] form the context menu on a figure object.
- Select a figure object, and then select [Properties...] form the [View] menu.

[[Object Connection] tab]

(1) Pin connection information setting area

Pin Connect	Select the method for connecting objects and output pins by clicking the corresponding option buttons, and specify the output pin name. As a result of the connection, figure display is switched by the ON/OFF status of the connected output pin.	
	No Connection	The object and pin are not connected (default). Objects not connected to pins are always in the displayed status.
	Static Connection	Connects the figure to 1 output pin. The connection pin can be specified in [Pin Name] either via direct input or through selection from the drop-down list. During simulation, the object is displayed when the specified output signal data is active.
	Dynamic Connection	Connects the figure to 2 output pins. The connection pin can be specified in [Pin Name1] and [Pin Name2] either via direct input or through selection from the drop-down list. During simulation, the object is displayed when the specified output signal 1 data and the specified output signal 2 data are both active.
Active Level	The common active status of each output signal can be selected from the option buttons.	
	LOW	Sets the active level to LOW.
	HIGH	Sets the active level to HIGH (default).

Remark For the pin names that can be specified, see the user's manual of the microcontroller that is used.

[[Style] tab]

(1) Style information setting area

Fill up	Specifies and changes settings related to each object filling ^{Note} , as follows: The area to be filled differs according to the object. <ul style="list-style-type: none"> - Line Not applicable - Rectangle, Ellipse, Rounded Rectangle Inside area enclosed by contour lines - Polygon Inside area enclosed by lines linking apexes - Text Inside text box - Bitmap Inside figure drawing area 	
	Color	Specifies and changes settings of color You can change the color by clicking the pull-down button.
Line	This area is used to perform settings and changes related to the lines of objects. The definition of line for each type of object is provided below. <ul style="list-style-type: none"> - Line All areas of the object - Rectangle, Ellipse, Rounded Rectangle Contour line of the figure - Polygon Lines that link the apexes of the polygon - Text Contour lines of the text box - Bitmap Contour lines of figure drawing area 	
	Color	Specifies and changes the line color. You can change the color by clicking the pull-down button.
	Dotted/ Solid	Specifies and changes line shapes (dotted line/solid line). The desired line shape can be selected from the drop-down list. Note that this item can be changed only when [Thickness] is set to "1".
	Thickness	Specifies and changes the line thickness. The desired line thickness can be specified either via direct input or through selection from the spin button. A value in the range of 1 to 100 (decimal) can be specified.

Note At this time, if the object that have been pasted from a bitmap file, it becomes invisible.

[Function buttons]

Button	Function
OK	Validates the settings and closes this dialog box.
Cancel	Cancels the settings and closes this dialog box.
Apply	Cannot be selected.
Help	Displays the help for this dialog box.

Parts List dialog box

This dialog box displays all the figure objects created in the *I/O Panel window* as well as the pin connection status of part objects.

The pin connection settings for each object can be changed in the property dialog box, which can be opened by double-clicking the relevant object listed in this dialog box, or selecting the relevant object listed in this dialog box and then selecting the [View] menu >> [Properties...].

Figure A-92. Parts List Dialog Box

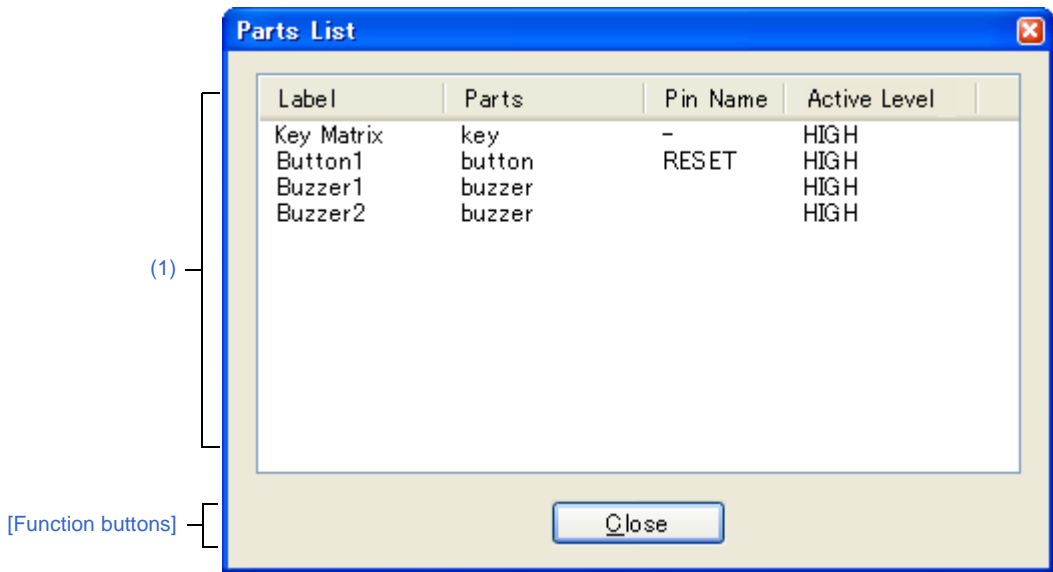

This section describes the following.

- [How to open]
- [Description of each area]
- [Function buttons]

[How to open]

- With the *I/O Panel window* in focus, select [Parts List...] form the [View] menu.

[Description of each area]

(1) Pin connection status display area

Label	Displays the label (name) attached to the object. Nothing is displayed for objects that do not have a label.	
Parts	Displays the part category.	
	rectangle	Straight line, rectangle, ellipse, rounded rectangle, fan shape
	polygon	Polygon
	text	Text
	bitmap	Bitmap
	button	Push button, pull button, group button
	analog button	Analog button
	key	Key matrix
	level gauge	Level gauge
	led	LED
	7segment led	7-segment LED
	14segment led	14-segment LED
	matrix led	Matrix LED
	buzzer	Buzzer
groups	Grouped part	
Pin Name	Displays the pins connected to parts. "- " is displayed for parts that are connected to multiple pins, and a blank is displayed for parts that are unconnected.	
Active Level	Displays the active value set for the part. "- " is displayed for parts that are connected to multiple pins, and a blank is displayed for parts that are unconnected.	

[Function buttons]

Button	Function
Close	Closes the this dialog box.

Serial window

This window is used to communicate with the serial interface provided in the CPU.

Since this window operates as the serial interface of the remote node of the CPU, transmission data from CPU turns into reception data in this window, and transmission data from this window turns into reception data in the CPU.

The following two types of files can be handled in this window.

The transmission/reception data displayed in the top area in this window can be saved to the serial log data file (*.log) (CSV format) by selecting the [File] menu >> [Save]/[Save As...].

Moreover, the transmission data created in the lower part of this window can be saved to the serial transmission data file (*.ser) (CSV format) by clicking the [Save] button (the contents can be restored by clicking the [Load] button).

Saving/restoring the created data can also be performed by saving/loading the project file. In this case, however, data is not saved as a CSV format text file but saved into the project file.

- Cautions 1.** If the saved serial transmission data file is opened or the project file is opened while Simulator GUI is running with a microcontroller different from the one used when the file was created, the settings of the serial interface that are not provided in the microcontroller will not be restored.
- 2.** Multiple instances of this window can be opened. After opening this window, select the serial interface to be verified in the [Serial selection area](#).

Figure A-93. Serial Window

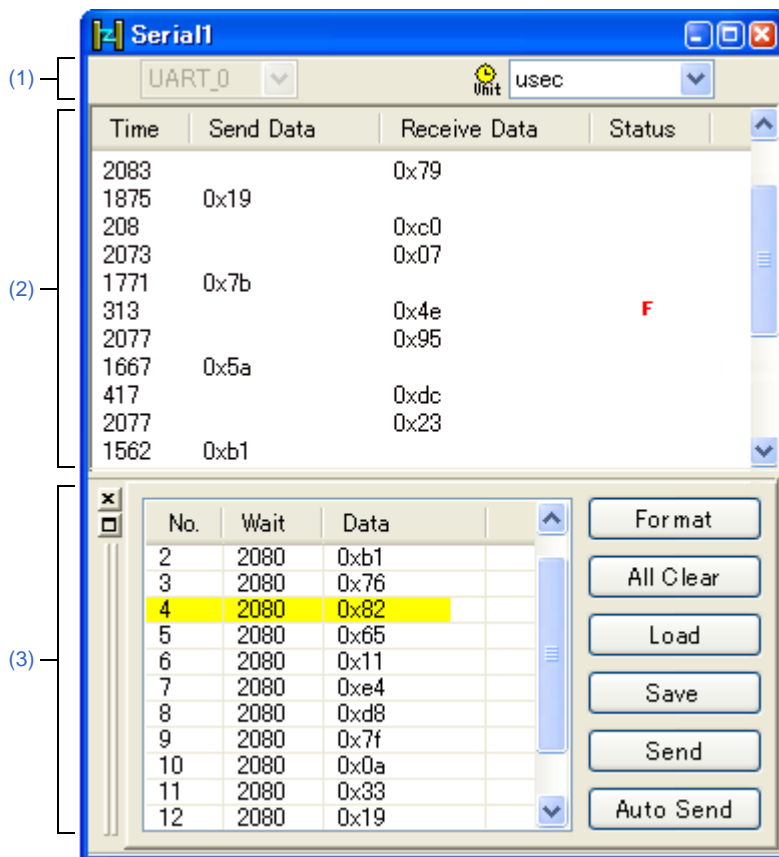

This section describes the following.

- [How to open]
- [Description of each area]
- [Dedicated menu (Serial window)]
- [Context menu]



[How to open]

- Click the  button.
- Select [Serial] from the [Simulator] menu.

[Description of each area]

(1) Serial selection area

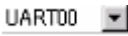
Select the serial interface to be used.

	Select the serial interface to be used from the list of provided serial interfaces (drop-down list) ^{Note} .
	Select from the drop-down list the time information unit applied to [Wait] in the Serial editor area . The time information unit can be changed by selecting the [Edit] menu >> [Time unit].

Note Once selected, the serial interface cannot be changed.
 If you wish to change the serial interface, open the another Serial window newly.

(2) Log display area

Displays the transmission/reception data.

The display timing is when all the bits constituting the data have been received or sent.

Only data from which the start bit, stop bit, and parity bit have been deleted is displayed in this area.

The notation of data can be changed by selecting the [View] menu>> [Numeric Representation] >> [Binary]/[Hexadecimal].

Log display is cleared upon debugger or simulator reset.

Time	Displays the time from the completion of reception/transmission of the previous data until completion of reception/transmission of the current data. The time information unit is specified by selecting the [Edit] menu >> [Time unit].	
Send Data	Displays the data sent by this window (data received by the CPU).	
Receive Data	Displays the data received by this window (data sent by the CPU).	
Status	Displays the status during data reception. When an error occurs, one of the following marks is displayed. When everything is normal, nothing is displayed.	
	P	Parity error (mismatching parity bit)
	F	Framing error (stop bit not detected)

(3) Serial editor area

This area is where the transmission data is created.

This area can be shown or hidden by selecting the [View] menu >> [Serial Editor].

No.	This is a number assigned sequentially from the beginning. It cannot be directly written. The maximum number is 9,999 lines.	
Wait	Specifies the time from the completion of transmission of the immediately previous data until the start of transmission of next data. Valid during transmission using the [Auto send] button. The time information unit is the unit selected by selecting the [Edit] menu >> [Time unit]. The wait value is input by placing the cursor in the Wait field to be edited and double-clicking. One wait value can be written per operation.	
Data	This area is used to edit transmission data. Data can be directly input by placing the cursor in the data field and double-clicking. Data suffixed by "0x" is treated as hexadecimal data, and data suffixed by "0b" is treated as binary data. The default code is the hexadecimal code. If a bit length different from that specified in the Format (UART) dialog box or Format (CSI) dialog box is specified, data from the lower bit is valid. One data can be written per operation.	
Button	Format	Opens the Format (UART) dialog box or Format (CSI) dialog box .
	All Clear	Clears all Serial editor area .
	Load	Loads the contents of the previously saved serial transmission data file (*.ser) and restores them in the Serial editor area . A file created for UART cannot be loaded as a file for CSI and vice versa.
	Save	Saves the contents of the Serial editor area to the specified serial transmission data file (*.ser).
	Send	Sends one of the data selected in the Serial editor area . The next data becomes selected upon completion of transmission. If no data is selected, the first data is sent.
	Auto Send	Makes the data selected in the Serial editor area the first data, and automatically transfers from the data to the bottom of the area. The data transmission time interval is the time specified for Wait.

Caution The help for this window will not be displayed even if the [F1] key on the keyboard is pressed while the cursor is placed in this area.

Remark When the CSI selected in this window is set to master mode, the clock must be supplied for reception. To perform reception, transmission of dummy data is therefore required.

[Dedicated menu (Serial window)]**(1) [Edit] menu**

Insert	Inserts a new line immediately before the selected line.
Cut	Cuts the selected range and saves it to the clipboard.
Copy	Copies the selected range and copies it to the clipboard.
Paste	Pastes the contents of the clipboard to the selected location.
Delete	Deletes the selected range.
Time unit	Selects the time unit.
main clock	Main clock (default)
usec	Microsecond
msec	Millisecond
Format...	Opens the Format (UART) dialog box or Format (CSI) dialog box .

(2) [View] menu

Serial Editor	Selects whether Serial editor area is displayed or not.
Numeric Representation	Changes the notation of the Log display area display method.
Binary	Displays binary numbers.
Hexadecimal	Displays hexadecimal numbers.

(3) [Option] menu

Customize...	Opens the Customize dialog box .
--------------	--

[Context menu]

The following context menus are available in the [Serial editor area](#).

Insert	Inserts a new line immediately before the selected line.
Cut	Cuts the selected range and saves it to the clipboard.
Copy	Copies the selected range and copies it to the clipboard.
Paste	Pastes the contents of the clipboard to the selected location.
Delete	Deletes the selected range.

Format (UART) dialog box

This dialog box is used to set the serial format for the asynchronous serial interface (UART).

Figure A-94. Format (UART) Dialog Box

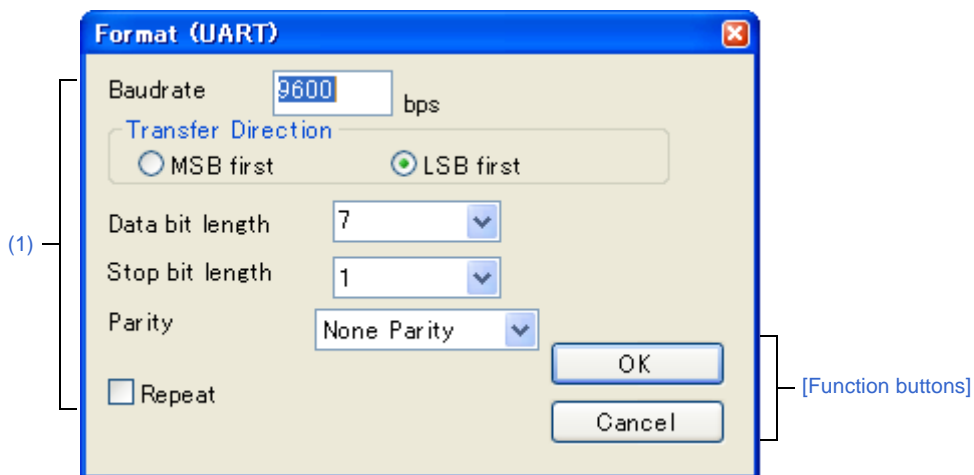

This section describes the following.

- [How to open]
- [Description of each area]
- [Function buttons]

[How to open]

On the [Serial window](#) with the UART serial interface, any one of the following;

- Click the [Format] button.
- Select [Format...] from the [Edit] menu

[Description of each area]

(1) Serial format setting area

Baudrate	Directly input the serial baud rate value as an integer. (Unit: bps)	
Transfer Direction	Select the transfer direction.	
	MSB first	Sets MSB first as the transfer direction.
	LSB first	Sets LSB first as the transfer direction (default).
Data bit length	Select the bit length of the transmission data from the drop-down list, or specify it through direct input (default:7).	
Stop bit length	Select the stop bit length from the drop-down list (default:1).	
Parity	Select the parity information (none parity (default) /odd parity/even parity/0 parity).	

Repeat	Select this item to repeat data transfer when the [Auto Send] button in the Serial window has been clicked.	
	<input checked="" type="checkbox"/>	Following transmission of the last data during automatic transmission, returns to the beginning of the data and performs automatic transmission.
	<input type="checkbox"/>	Following transmission of the last data during automatic transmission, stops transmission (default).

Remark For the selectable range, see the user's manual of the microcontroller that is used.

[Function buttons]

Button	Function
OK	Validates the settings and closes this dialog box.
Cancel	Cancels the settings and closes this dialog box.

Format (CSI) dialog box

This dialog box is used to specify the serial format for the 3-wire serial interface (CSI).

Figure A-95. Format (CSI) Dialog Box

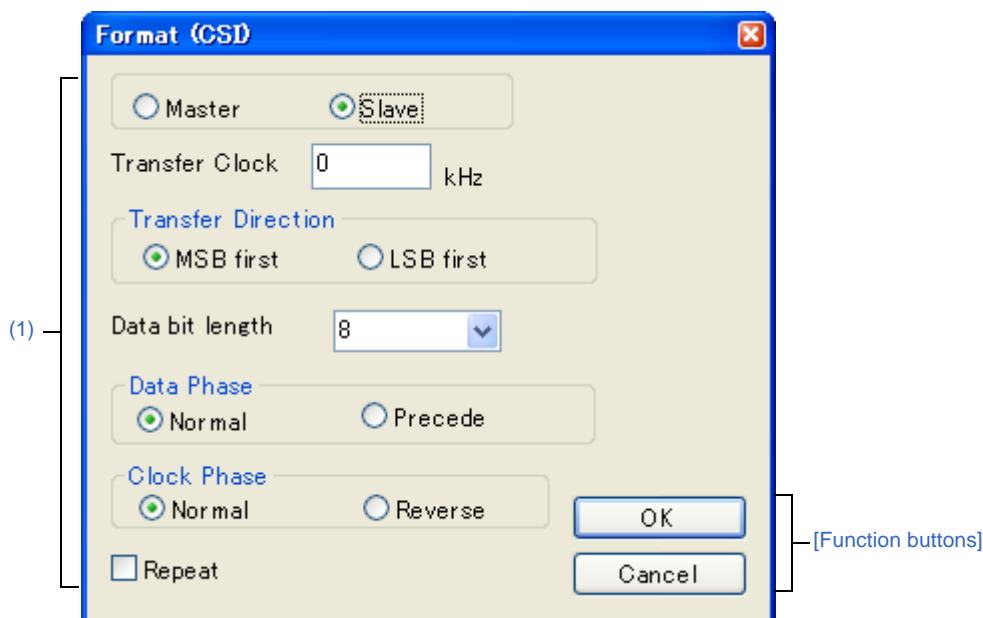

This section describes the following.

- [How to open]
- [Description of each area]
- [Function buttons]
- [Transmission/reception when 3-wire serial interface (CSI) is selected]

[How to open]

On the [Serial window](#) with the CSI serial interface, any one of the following;

- Click the [Format] button.
- Select [Format...] from the [Edit] menu

[Description of each area]

(1) Serial format setting area

Master, Slave	Select the transfer mode.	
	Master	Operates this window as a master. Setting of [Transfer Clock] is required for generating the clock during communication.
	Slave	Operates this window as a slave (default). Communication is performed using the clock of the serial interface provided in the CPU.
Transfer Clock	Directly input the transfer clock value (unit: kHz). Values with decimals can also be set. This item must be set when master is selected.	

Transfer Direction	Select the transfer direction.	
	MSB first	Sets MSB first as the transfer direction (default).
	LSB first	Sets LSB first as the transfer direction.
Data bit length	Select the bit length of the transmission data from the drop-down list, or specify it through direct input (default: 8).	
Data Phase	Select the transmission/reception timing to set the data phase. The data clock phase is set in combination with "Clock Phase" as shown in "Table A-15. Data Clock Phase Settings".	
	Normal	Transmits/receives data at the normal 3-wire serial transmission/reception timing (default).
	Precede	Transmits/receives data at a timing half a clock of the operation clock earlier than the normal 3-wire serial transmission/reception timing.
Clock Phase	Select the transmission/reception clock waveform to set the clock phase. The data clock phase is set in combination with "Data Phase" as shown in "Table A-15. Data Clock Phase Settings".	
	Normal	Operates on the normal 3-wire serial clock. Transfer starts at the falling edge of the clock (default).
	Reverse	Operates on the reverse clock of the normal 3-wire serial clock. Transfer starts at the rising edge of the clock.
Repeat	Select this item to repeat data transfer when the [Auto Send] button in the Serial window has been clicked.	
	<input checked="" type="checkbox"/>	Following transmission of the last data during automatic transmission, returns to the beginning of the data and performs automatic transmission.
	<input type="checkbox"/>	Following transmission of the last data during automatic transmission, stops transmission.

Remark For the selectable range, see the user's manual of the microcontroller that is used.

Table A-15. Data Clock Phase Settings

Data Phase Setting	Clock Phase Setting	Data Clock Phase
Normal	Normal	
Precede	Normal	

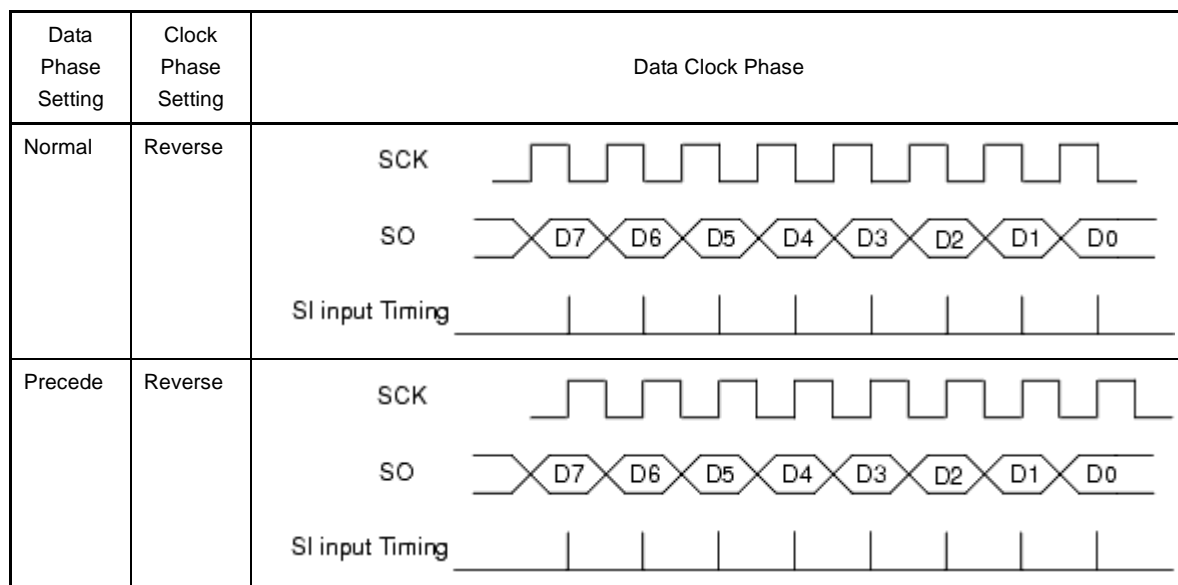

[Function buttons]

Button	Function
OK	Validates the settings and closes this dialog box.
Cancel	Cancel the settings and closes this dialog box.

[Transmission/reception when 3-wire serial interface (CSI) is selected]

The [Serial window](#) when CSI serial interface is selected always operates in the transmission/reception mode regardless of whether [Master] or [Slave] is selected in this dialog box.

When [Master] is selected	Data is transmitted or received immediately after clicking the [Send] button or the [Auto Send] button in the Serial editor area .
When [Slave] is selected	Data becomes ready to be transmitted or received after clicking the [Send] button or the [Auto Send] button in the Serial editor area . Data starts to be transmitted or received when the CSI clock signal is received in the data transmission/reception ready status. This ready status is released when data transmission or reception is completed. (Even if the CSI clock is received, data is not transmitted or received in other than the data transmission/reception ready status.)

Accordingly, when only wanting to reception data in the [Serial window](#) when "Slave" is selected, execute as follows (Reception setting when CSI serial slave is selected):

(1) Set [Repeat]

Set the [Repeat] check box in the [Format (CSI)] dialog box.

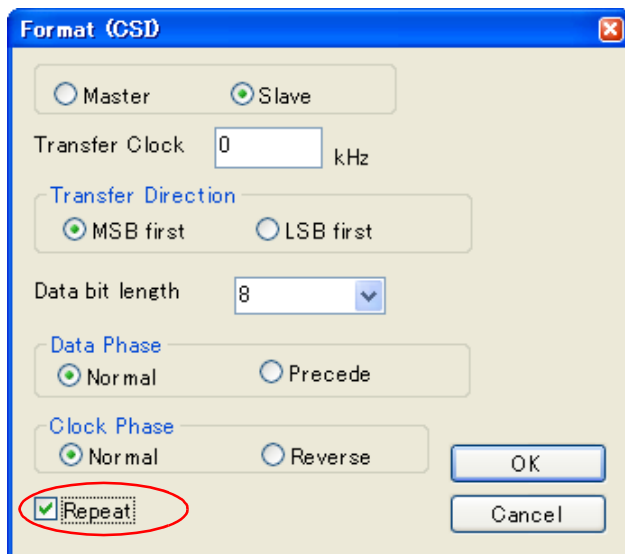

(2) Set Wait time

Set the Wait time to 0 as a dummy setting in the [Serial window](#).

(3) Click the [Auto Send] button

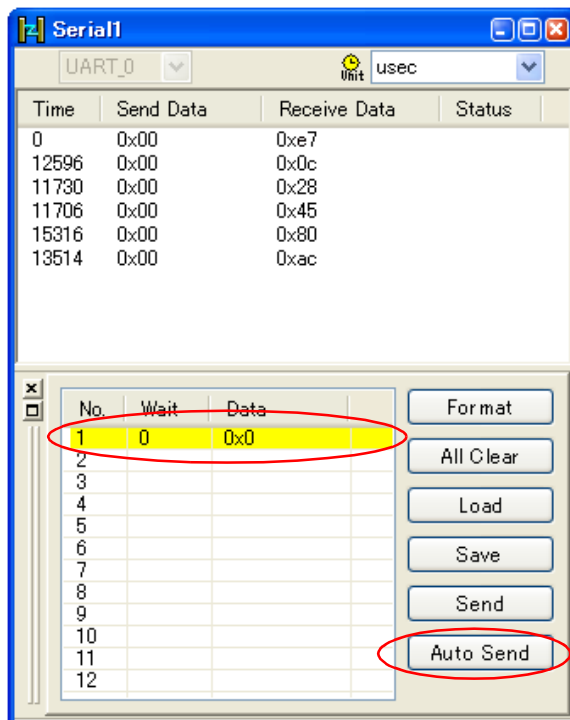

APPENDIX B USER OPEN INTERFACE

Appendix B provides detailed explanations of the user open interface that is one of the functions provided by Simulator GUI.

B.1 Overview

Simulator GUI provides two ways of creating an environment where a target system, as well as a CPU (CPU core + internal peripherals), can be simulated.

One is the *I/O Panel window*, via which a user-friendly simulation environment can be organized through GUI manipulation, by supplying standard components for connection and their manipulation environment.

The other is to create the simulation environment of the target system that uses the user open interface to be explained in this appendix. In this environment, functions that cannot be realized on the *I/O Panel window* can be used if the user programs an external user model.

Figure B-1. Programming Image of User Model

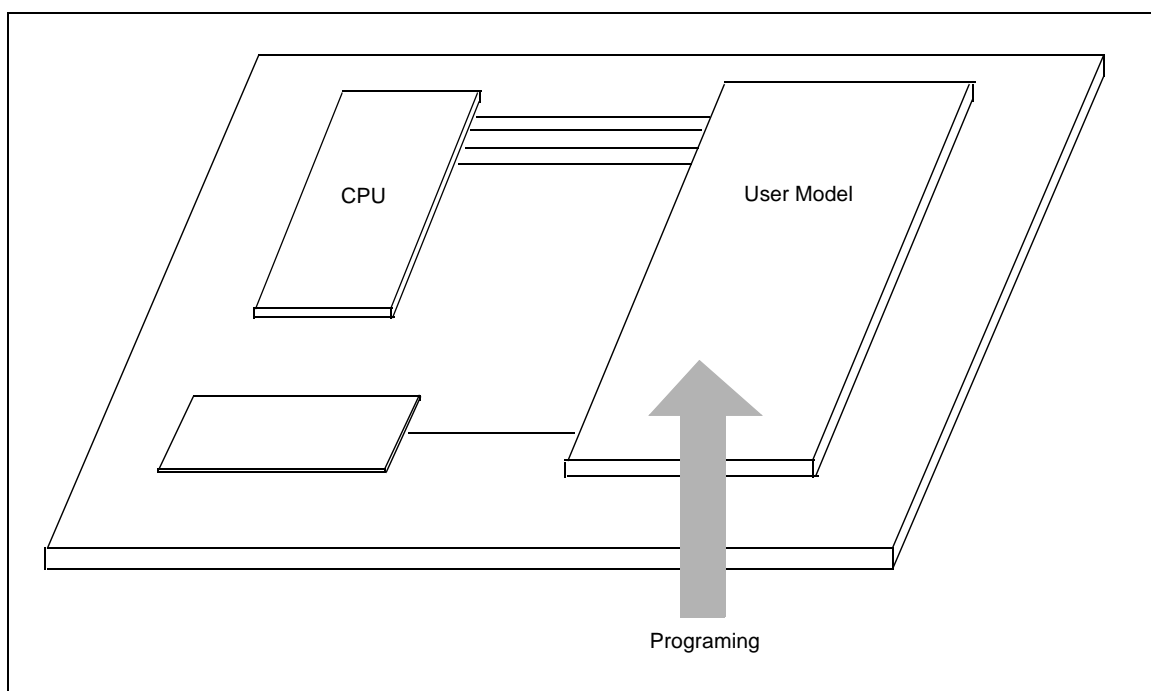

B.1.1 Types of interface functions

Simulator GUI's user open interface supplies the following types of interface functions (see "B.4 Supplied Interface Functions").

Table B-1. Types of Functions Supplied by User Open Interface

Type	Description
Basic interface functions	Basic function of simulation - Initialization notification - Reset notification, etc.
Time interface functions	Cyclic timer function for time-series processing of the user model - Setting of timer - Clearing of timer - Notification of timer time, etc.
Pin interface functions	Pin I/O function - Signal output to pin - Notification of signal input to pin
External bus interface functions ^{Note}	Slave function of external bus - External bus read access notification - External bus write access notification, etc.
Serial interface functions	Serial transmission/reception function - Transmission of serial data - Notification of reception of serial data, etc.
Signal output unit interface functions	Function to output signals in accordance with signal data file - Signal output in accordance with signal data file, etc.

Note When using the external bus interface function, the external memory area to use must be set to [Target memory area] with the [Memory Type] area of the [Memory Mapping dialog box](#).

B.1.2 Interface methods

Simulator GUI's user open interface has the following interface methods.

(1) C language interface

The user open interface consists of a C language API (Application Program Interface) function set. Therefore, program the user model in C language.

(2) Callback function method

The user open interface uses the callback function method as a means to call a program from the system.

The callback function method is that a program (user model) is called by the system (CPU) when it is necessary. This method uses the pointer to the function which is defined on the program (user model). The system (CPU) calls the user program (user model) by using this pointer.

While the provided API functions call the system from the program, the callback function is used to call the program from the system, such as when inputting a signal to a pin.

(3) Event-driven method

The user open interface uses an event-driven method in which processing is described in accordance with occurrence of events.

Therefore, a callback function prepared on the user model side is called if an event such as initialization of simulation, resetting the CPU, signal output to a pin, or access to the external bus occurs on the Simulator GUI side. In addition, a time interface (= timer function) provided to perform time-series processing of a user model also calls a callback function prepared on the user model side when the specified time has elapsed.

B.1.3 Development environment

Use the following development tools to perform programming with the Simulator GUI's user open interface and create a DLL file.

- Microsoft Visual C++ (Ver. 6.00 or later)

B.2 Creating User Model

This section describes how to create a user model.

B.2.1 Program configuration

The following figure shows the program configuration when the Simulator GUI's user open interface is used to expand a system.

Figure B-2. Program Configuration

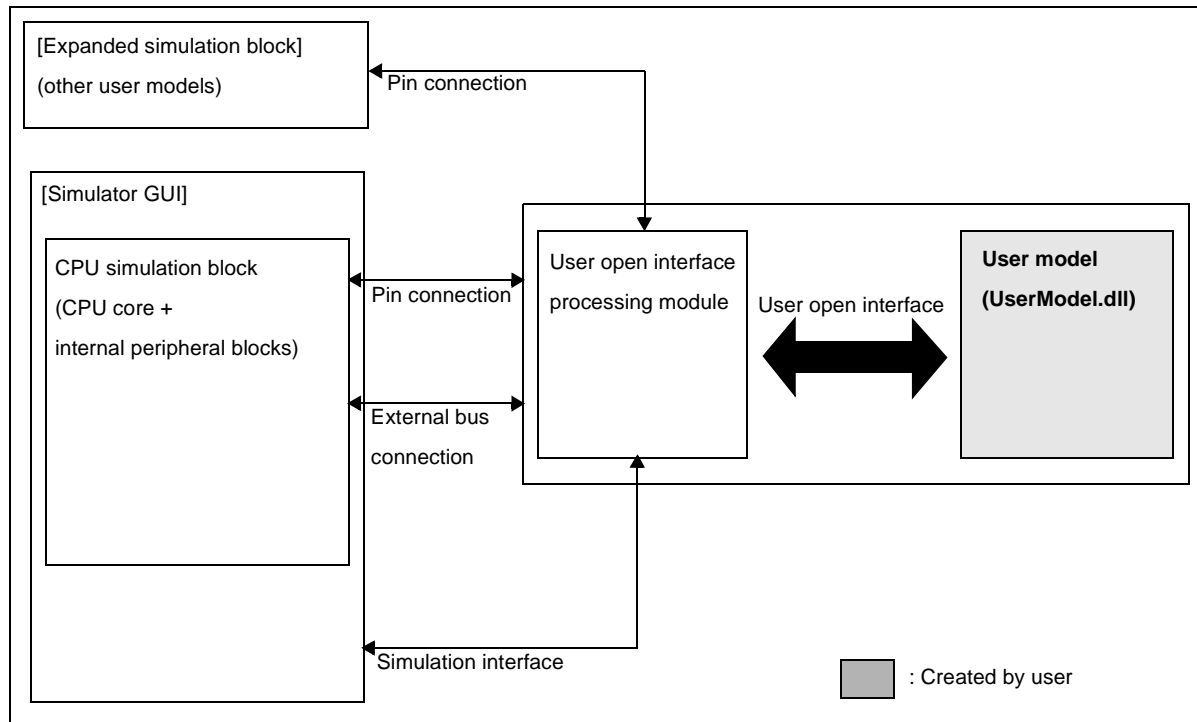

To expand a system, a user model must be created first.

Because the user model operates in conjunction with the simulation system, it interfaces with the user open interface processing module. This interface is the user open interface.

The user model generates resources such as pins and external bus slaves via the user open interface during configuration (processing to configure the simulator that is performed when Simulator GUI is started). By connecting the pins and external bus slaves to the pins and external bus masters of the CPU simulation block, signals can be input to or output from the pins of the CPU simulation block and the external bus can be accessed from the CPU simulation block.

The generated pins and external bus slaves can also be connected to the expansion simulation block (other user models), as well as to the CPU simulation block.

B.2.2 Outline of programming

The user model is programmed in the dynamic link library (DLL) format of WIN32.
 The template of a program file is shown below.

Figure B-3. Template of Program File

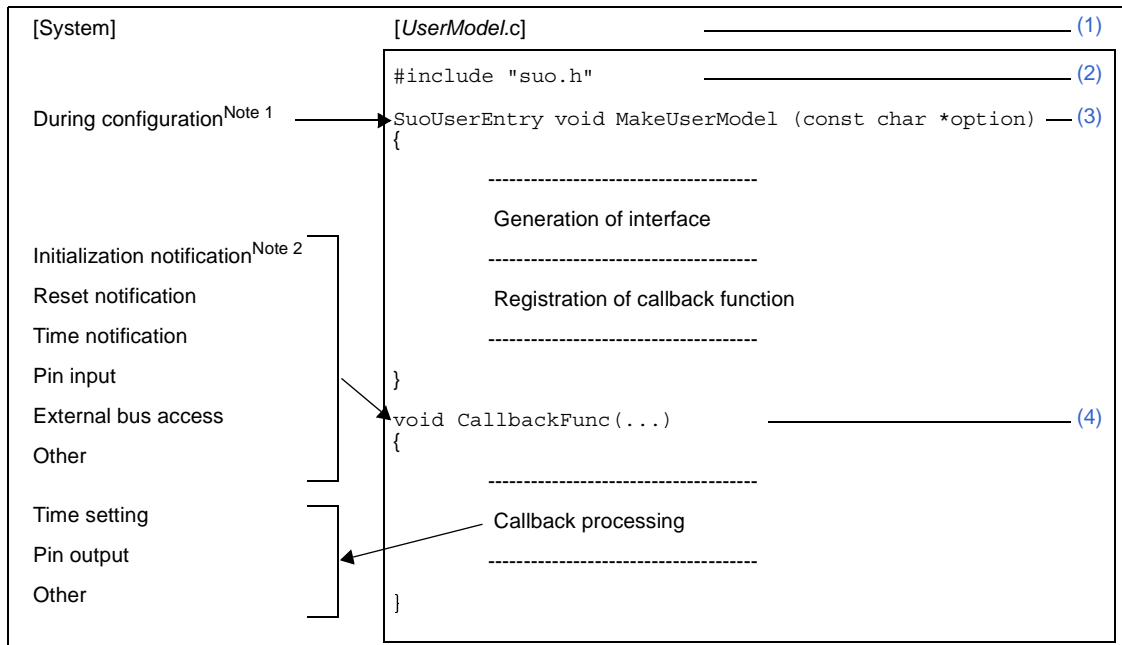

- Notes 1.** "Configuration" means simulator configuration processing that is executed when Simulator GUI is started.
2. An initialization notification is reported only once, immediately after Simulator GUI is started when simulator configuration processing has been completed.

(1) File name

Indicates the file name of the user model to be created.
 The file name can be determined freely (the suffix for a C language file is "*.c").

(2) Include file

Indicates a include file.
 To use the user open interface, the system header file "suo.h" must be included.

(3) MakeUserModel function

Indicates the `MakeUserModel` function that is called from the system during configuration of Simulator GUI.
 Note that the name of this function must be "MakeUserModel".

[Syntax]

```
SuoUserEntry void MakeUserModel(const char *option);
```

The following two types of processing are described in this function.

(a) Interface generation

Because Simulator GUI connects pins and buses during configuration processing when it is started, resources such as pins and buses that are to be connected during configuration must be generated.

To do this, call a function that generates an interface in the [MakeUserModel](#) function and generate an interface (see "[B.4 Supplied Interface Functions](#)"). The necessary resources will be also generated.

(b) Registering callback function

Callback functions can be registered as necessary.

Caution When describing a callback function for initialization, be sure to register it at this time; otherwise callback will not function. This is because initialization notification is reported immediately after the [MakeUserModel](#) function is called.

(4) Callback function

Indicates a callback function.

Two or more callback functions, such as those for initialization notification, reset notification, time notification, pin input, and external bus access, can be created. Describe processing in accordance with the callback contents in the callback function (see "[B.5 User-Defined Functions](#)").

A callback function that has been created must be registered in advance so that it can be called from the system (see "[B.4 Supplied Interface Functions](#)"). The name of a callback function can be determined freely, and the format of the function differs depending on the type of callback.

B.2.3 Example of program file (*UserModel.c*)

```
#include "suo.h"
#include <memory.h>

void Init(void);
void InputP00(SuoHandle handle, int pinValue);
void ReadBUS1(SuoHandle handle, unsigned long addr, int accessSize, unsigned char data[]);
void WriteBUS1(SuoHandle handle, unsigned long addr, int accessSize, const unsigned char data[]);

SuoHandle p00;
SuoHandle p01;
SuoHandle bus1;
unsigned char mem[0x100];

/* MakeUserModel */
SuoUserEntry void MakeUserModel(const char *option)
{
    SuoCreatePin("P00", &p00);
    SuoCreatePin("P01", &p01);
    SuoCreateExtbus("BUS1", 0x200000, 0x100, &bus1);

    SuoSetInitCallback(Init);
    SuoSetInputDigitalPinCallback(p00, InputP00);
    SuoSetReadExtbusCallback(bus1, ReadBUS1);
    SuoSetWriteExtbusCallback(bus1, WriteBUS1);
}

/* callbacks */
void Init(void)
{
    memset(mem, 0, 0x100);
}

void InputP00(SuoHandle handle, int pinValue)
{
    SuoOutputDigitalPin(p01, pinValue);
}

void ReadBUS1(SuoHandle handle, unsigned long addr, int accessSize, unsigned char data[])
{
    memcpy(data, &mem[addr-0x200000], accessSize);
}

void WriteBUS1(SuoHandle handle, unsigned long addr, int accessSize, const unsigned char data[])
{
    memcpy(&mem[addr-0x200000], data, accessSize);
}
```

B.2.4 Compilation and linking

Create a *UserModel.dll* by compiling and linking the created *UserModel.c* and *suolink.cpp*.

Figure B-4. Flow of Compilation and Linking

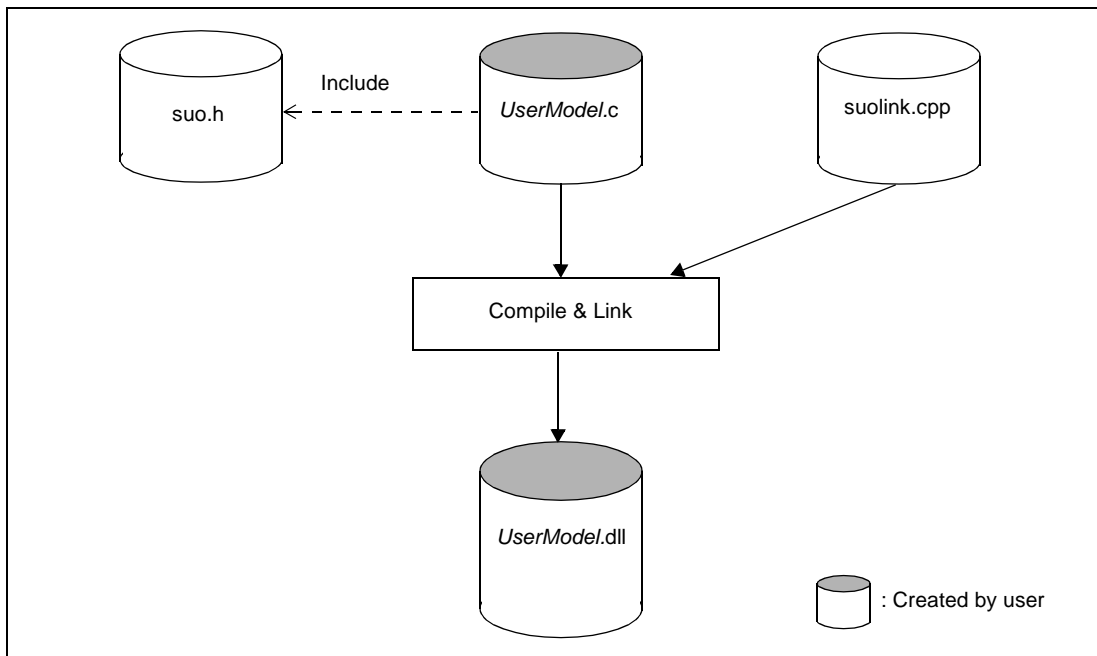

File Name	Description
suo.h	This is a system header file for the user open interface. This file is included by the program (<i>UserModel.c</i>) but is not compiled. Note that "suo.h" is stored in the following folder by default. - <i>Install-folder\CubeSuite\DebugTools\DebugToolK0Simulator\useropen\sys</i>
suolink.cpp	This is a file that performs dynamic link processing with the user open interface processing module of the system. Note that "suolink.cpp" is stored in the following folder by default. - <i>Install-folder\CubeSuite\DebugTools\DebugToolK0Simulator\useropen\sys</i>
<i>UserModel.c</i>	This is the source file of the user model to be created. The file name can be determined freely.
<i>UserModel.dll</i>	This is a binary file of the user model (DLL file). The file name can be determined freely.

Caution To execute a DLL file in an environment in which Microsoft Visual C++ is not installed, the DLL file must be created using the release version.

B.3 Embedding User Model

This section describes how to embed the created user model (*UserModel.dll*) in Simulator GUI.

To embed the user model in Simulator GUI, use a simulator configuration file (*.cfg).

Therefore, when using Simulator GUI embedding the created user model, you need to specify [Yes] with the [Use simulator configuration file] property in the [Configuration] category on the [Connect Settings] tab of the Property panel, and then specify the configuration file to be used with the [Simulator configuration file] property in the category same as above.

B.3.1 Description in simulator configuration file

Describe the user model generation processing, processing to connect pins and an external buses and so on in the simulator configuration file.

- (1) [User model generation processing](#)
- (2) [Pin connection](#)
- (3) [External bus connection](#)
- (4) [Other processing](#)

(1) User model generation processing

```
UserModel1 = Device("USEROPEN", "UserModel1.dll UserOption1");
```

(a) *UserModel1*

UserModel1 is a variable that indicates the generated user model. The variable name can be determined freely by user.

(b) Device function

The Device function is used to create a user model.

(c) "USEROPEN"

"USEROPEN" is a user open interface processing module (system module).

(d) *UserModel1.dll*

UserModel1.dll is the binary file (DLL format) of the user model to be created in "B.2 Creating User Model".

The file name can be determined freely by user.

Specify a relative path or absolute path from the folder where the simulator configuration file exists as the file path.

Caution Do not use single-byte spaces for specifying the path name; otherwise, the user model will not be created.

(e) *UserOption1*

UserOption1 is an option character string for *UserModel1.dll*. This character string is passed to the "option" parameter of the [MakeUserModel](#) function as is.

(2) Pin connection

```
wire1 = Wire(1); --- (a)
wire1 += cpu.Port("PinName1"); --- (b)
wire1 += UserModel1.Port("UserPinName1"); --- (c)
```

(a) Generation of a wire

Generate a wire (= line that connects pins) by using the Wire function.

Be sure to specify "1" for the argument of the Wire function.

wire1 is a variable that indicates the generated wire. The variable name can be determined freely.

(b) Connection of the wire and CPU

Connect one end of the wire to a pin of the CPU.

Specify the name of the external CPU pin to be connected by using uppercase characters, as "*PinName1*" (note that lowercase characters cannot be used). Enclose the pin name between double quotation marks ("").

(c) Connection of the wire and user model

Connect the other end of the wire to a pin of the user model.

Specify the name of the user model pin to be connected as "*UserPinName1*" (pin name generated in the [MakeUserModel](#) function). Enclose the pin name between double quotation marks ("").

Add this line to connect two or more user model pins to the same wire.

(3) External bus connection

```
extbus1 = BUS(n); --- (a)
extbus1 += cpu.BusMasterIF("EXTBUS"); --- (b)
extbus1 += UserModel1.BusSlaveIF("UserExtbusName1"); --- (c)
```

(a) Generation of a bus

Generate a bus by using the BUS function.

Argument *n* of the BUS function is the data bus bit width. This may be 8, 16, or 32.

extbus1 is a variable that indicates the generated bus. The variable name can be determined freely.

(b) Connection of the bus and CPU

Connect one end of the bus to the external bus master of the CPU.

Specify the external bus master "EXTBUS" for the argument.

(c) Connection of the bus and user model

Connect the other end of the bus to the external bus of the user model.

Specify the name of the external bus of the user model to be connected as "*UserExtbusName1*" (the external bus name generated in the [MakeUserModel](#) function). Enclose the external bus name between double quotation marks ("").

Add this line to connect two or more user model external buses.

(4) Other processing

In addition to the above, the formulaic connections for the main clock notification pin and the reset notification pin shown below is required to operate the user open interface.

```

clock1 = Wire(1); --- (a)
clock1 += cpu.DebuggerPseudoPort("debugger_pseudo_pin_main_clkout"); --- (b)
clock1 += UserModel1.Port("gui_pseudo_pin_clock_notice"); --- (c)
reset1 = Wire(1); --- (d)
reset1 += cpu.DebuggerPseudoPort("debugger_pseudo_pin_reset_notice"); --- (e)
reset1 += UserModel1.Port("gui_pseudo_pin_reset_notice"); --- (f)
    
```

(a) Generation of a wire

Generate a wire (= line that connects pins) by using the Wire function.
 Be sure to specify "1" for the argument of the Wire function.
clock1 is a variable that indicates the generated wire. The variable name can be determined freely.

(b) Connection of the wire and main clock notification pin

Connect one end of the wire to Simulator GUI's main clock notification pin.
 Specify "debugger_pseudo_pin_main_clkout" for the argument.

(c) Connection of the wire and user model

Connect the other end of the wire to a pin of the user model.
 Specify "gui_pseudo_pin_clock_notice" for the argument.

(d) Generation of a wire

Generate a wire (= line that connects pins) by using the Wire function.
 Be sure to specify "1" for the argument of the Wire function.
reset1 is a variable that indicates the generated wire. The variable name can be determined freely.

(e) Connection of the wire and reset notification pin

Connect one end of the wire to Simulator GUI's reset notification pin.
 Specify "debugger_pseudo_pin_reset_notice" for the argument.

(f) Connection of the wire and user model

Connect the other end of the wire to a pin of the user model.
 Specify "gui_pseudo_pin_reset_notice" for the argument.

B.3.2 Example of simulator configuration file

An example of the simulator configuration file is shown below.
 In this example, the following connection processing is performed.

Type of Connection	CPU		User Model (SampleModel.dll)	
Pin	"P00/INTP0"	P00 pin	"P00"	Pin manipulating P00
	"P30/TXD1"	Serial output pin	"RXD"	Serial input pin
	"P31/RXD1"	Serial input pin	"TXD"	Serial output pin
External bus	"EXTBUS"	External bus master	"EXTBUS1"	External bus slave 1
	"EXTBUS"	External bus master	"EXTBUS2"	External bus slave 2

```
cpu = CPU('a');
# -----
# SampleModel description
# -----

# Generate SampleModel.dll
model = Device("USEROPEN", "SampleModel.dll -a -b");

# Connect PIN (CPU.P00-MODEL.P00)
wire_P00 = Wire(1);
wire_P00 += cpu.Port("P00/INTP0");
wire_P00 += model.Port("P00");

# Connect PIN (CPU.TXD1-MODEL.RXD)
wire_RXD = Wire(1);
wire_RXD += cpu.Port("P30/TXD1");
wire_RXD += model.Port("RXD");

# Connect PIN (CPU.RXD1-MODEL.TXD)
wire_TXD = Wire(1);
wire_TXD += cpu.Port("P31/RXD1");
wire_TXD += model.Port("TXD");

# Connect BUS (CPU.EXTBUS-MODEL.EXTBUS1)
extbus = BUS(32);
extbus += cpu.BusMasterIF("EXTBUS");
extbus += model.BusSlaveIF("EXTBUS1");
extbus += model.BusSlaveIF("EXTBUS2");

# Connect Pseudo PIN
wire_clock = Wire(1);
wire_clock += cpu.DebuggerPseudoPort("debugger_pseudo_pin_main_clkout");
wire_clock += model.Port("gui_pseudo_pin_clock_notice");
wire_reset = Wire(1);
wire_reset += cpu.DebuggerPseudoPort("debugger_pseudo_pin_reset_notice");
wire_reset += model.Port("gui_pseudo_pin_reset_notice");
```

B.4 Supplied Interface Functions

This section describes the interface functions supplied by Simulator GUI as the user open interface.

B.4.1 Overview

The supplied interface functions are listed below.

Table B-2. List of Supplied Interface Functions

Type	Function Name	Outline of Function
Basic interface functions	SuoSetInitCallback	Registers initialization callback.
	SuoSetResetCallback	Registers reset callback.
	SuoGetMainClock	Acquires the cycle of the main clock for simulation.
Time interface functions	SuoCreateTimer	Generates timer interface.
	SuoGetTimerHandle	Acquires timer handle.
	SuoSetTimer	Sets cyclic timer.
	SuoKillTimer	Stops cyclic timer.
	SuoSetNotifyTimerCallback	Registers timer time notification callback.
Pin interface functions	SuoCreatePin	Generates pin interface.
	SuoGetPinHandle	Acquires pin interface handle.
	SuoOutputDigitalPin	Outputs digital pin value.
	SuoOutputAnalogPin	Outputs analog pin value.
	SuoOutputHighImpedance	Outputs high-impedance for the pin.
	SuoSetInputDigitalPinCallback	Registers digital pin value input callback.
	SuoSetInputAnalogPinCallback	Registers analog pin value input callback.
	SuoSetInputHighImpedanceCallback	Registers pin high-impedance state report callback.
External bus interface functions ^{Note}	SuoCreateExtbus	Generates external bus interface.
	SuoGetExtbusHandle	Acquires external bus interface handle.
	SuoSetReadExtbusCallback	Registers external bus read access callback.
	SuoSetWriteExtbusCallback	Registers external bus write access callback.

Type	Function Name	Outline of Function
Serial interface functions	SuoCreateSerialUART	Generates serial interface (UART type).
	SuoCreateSerialCSI	Generates serial interface (CSI type).
	SuoGetSerialHandle	Acquires serial interface handle.
	SuoSetSerialParameterUART	Sets serial parameter (UART type).
	SuoSetSerialParameterCSI	Sets serial parameter (CSI type).
	SuoGetSerialParameterUART	Acquires serial parameter (UART type).
	SuoGetSerialParameterCSI	Acquires serial parameter (CSI type).
	SuoSendSerialData	Performs serial transmission (1 data).
	SuoSendSerialDataList	Performs serial transmission (more than one data).
	SuoSendSerialFile	Performs serial transmission (serial transmission data file).
	SuoSetNotifySentSerialCallback	Registers serial transmission end notification callback.
SuoSetReceiveSerialCallback	Registers serial reception callback.	
Signal output unit interface functions	SuoCreateWave	Generates signal output unit interface.
	SuoGetWaveHandle	Acquires signal output unit interface handle.
	SuoSendWaveFile	Performs transmission via signal output unit.
	SuoSetNotifySentWaveCallback	Registers signal output unit transmission end notification callback.

Note When using the external bus interface function, the external memory area to use must be set to [Target memory area] with the [Memory Type] area of the [Memory Mapping dialog box](#).

B.4.2 Basic interface functions

The basic interface functions that are supplied by Simulator GUI are as follows:

Function Name	Outline of Function
SuoSetInitCallback	Registers initialization callback.
SuoSetResetCallback	Registers reset callback.
SuoGetMainClock	Acquires the cycle of the main clock for simulation.

SuoSetInitCallback

Registers initialization callback.

Caution A callback function is not executed unless this function is called in the [MakeUserModel](#) function.

[Syntax]

```
#include    "suo.h"
void      SuaSetInitCallback(SuoInitCallback func);
```

[Argument(s)]

Argument	Description
<i>func</i>	Pointer to the user-defined function that performs initialization processing (see " InitFunc ")

[Return value]

None

[Description]

- This function registers the user-defined function that performs initialization processing.
- The function registered by this function is called only once, when Simulator GUI is started.
- If NULL is specified for *func*, registration is canceled.

[Example]

```
#include    "suo.h"
void InitFunc(void);

/* MakeUserModel */
SuoUserEntry void MakeUserModel(const char *option)
{
    .....
    SuaSetInitCallback(InitFunc);          /* Set initialize function */
}

/* Initialize function */
void InitFunc(void){
    .....
}
```

SuoSetResetCallback

Registers reset callback.

[Syntax]

```
#include    "suo.h"
void      SuoSetResetCallback(SuoResetCallback func);
```

[Argument(s)]

Argument	Description
<i>func</i>	Pointer to the user-defined function that performs reset processing (see " ResetFunc ")

[Return value]

None

[Description]

- This function registers the user-defined function that performs reset processing.
- The registered function is called when the CPU is reset.
- If NULL is specified for *func*, registration is canceled.

[Example]

```
#include    "suo.h"
void ResetFunc(void);

void func1(void)
{
    .....
    SuoSetResetCallback(ResetFunc);    /* Set reset function */
}

/* Reset function */
void ResetFunc(void) {
    .....
}
```

SuoGetMainClock

Acquires the cycle of the main clock for simulation.

Caution This function cannot be called in the [MakeUserModel](#) function. It can only be called in a callback function.

[Syntax]

```
#include "suo.h"
int SuoGetMainClock(unsigned long* time);
```

[Argument(s)]

Argument	Description
<i>time</i>	Location where the main clock cycle value (unit: pS) is to be stored.

[Return value]

Macro	Description
SUO_NOERROR	Normal completionNormal completion
<i>Error number</i>	Exit with error (abend) (see " B.4.8 Error numbers ")

[Description]

- This function is used to acquire the cycle of the main clock for the simulation environment currently being executed.

[Example]

```
#include "suo.h"
unsigned long time;

void func1(void)
{
    .....
    SuoGetMainClock(&time); /* Get main clock */
}
```

B.4.3 Time interface functions

The time interface functions that are supplied by Simulator GUI are as follows:

Function Name	Outline of Function
SuoCreateTimer	Generates timer interface.
SuoGetTimerHandle	Acquires timer handle.
SuoSetTimer	Sets cyclic timer.
SuoKillTimer	Stops cyclic timer.
SuoSetNotifyTimerCallback	Registers timer time notification callback.

SuoCreateTimer

Generates timer interface.

Caution This function can only be called in the [MakeUserModel](#) function. An error occurs if it is called at any other timing.

[Syntax]

```
#include "suo.h"
int     SuaCreateTimer(const char* timerName, SuaHandle* handle);
```

[Argument(s)]

Argument	Description
<i>timerName</i>	Name of the timer
<i>handle</i>	Location where the handle of the timer interface is to be stored

[Return value]

Macro	Description
SUO_NOERROR	Normal completion
<i>Error number</i>	Exit with error (abend) (see "B.4.8 Error numbers")

[Description]

- This function generates a timer interface.
- The generated timer interface is associated with the name specified for *timerName*.
- If this function is successful, the handle of the generated timer interface can be obtained. The timer interface can then be controlled by specifying this handle.
- The handle can also be obtained by using the [SuoGetTimerHandle](#) function.

[Example]

```
#include "suo.h"
SuaHandle hTim1;

SuoUserEntry void MakeUserModel(const char *option)
{
    .....
    SuaCreateTimer("TIM1", &hTim1);      /* Create "TIM1" */
}
```

SuoGetTimerHandle

Acquires timer handle.

[Syntax]

```
#include    "suo.h"
SuoHandle  SuaGetTimerHandle(const char* timerName);
```

[Argument(s)]

Argument	Description
<i>timerName</i>	Name of the timer

[Return value]

Macro	Description
<i>Handle of the specified timer interface</i>	Normal completion
NULL	Exit with error (abend)

[Description]

- This function is used to obtain the handle of the specified timer interface.
- Specify the name specified by the [SuoCreateTimer](#) function as *timerName* (if a different name is specified, NULL is returned).

[Example]

```
#include    "suo.h"
SuoHandle  hTim1;

void func1(void)
{
    .....
    hTim1 = SuaGetTimerHandle("TIM1");      /* Get handle of "TIM1" */
}
```

SuoSetTimer

Sets cyclic timer.

Caution This function cannot be called in the [MakeUserModel](#) function. It can only be called in a callback function.

[Syntax]

```
#include "suo.h"
int SuoSetTimer(SuoHandle handle, int timeUnit, unsigned long timeValue);
```

[Argument(s)]

Argument	Description
<i>handle</i>	Handle of the timer interface
<i>timeUnit</i>	Time unit (specify any of the following) - SUO_MAINCLK : Main clock cycle units - SUO_USEC : Microsecond units
<i>timeValue</i>	Timer cycle time

[Return value]

Macro	Description
SUO_NOERROR	Normal completion
<i>Error number</i>	Exit with error (abend) (see " B.4.8 Error numbers ")

[Description]

- This function sets a cyclic timer for the specified timer interface.
- The cycle time is specified by the value of *timeValue* in units of *timeUnit* ("0" cannot be specified for *timeValue*).
- The timer starts operating immediately after this function is called. The timer continues operating until it is stopped by the [SuoKillTimer](#) function.
- If a timer notification function has been registered by the [SuoSetNotifyTimerCallback](#) function, the timer notification function is called in each cycle.
- If this function is called for the timer that is currently operating, the timer is reset and starts operating with the specified cycle time.

[Example]

```
#include "suo.h"
SuoHandle hTim1;

void func1(void)
{
.....
    SuoSetTimer(hTim1, SUO_USEC, 20);    /* Invoke 20us cyclic timer */
}
```

SuoKillTimer

Stops cyclic timer.

Caution This function cannot be called in the [MakeUserModel](#) function. It can only be called in a callback function.

[Syntax]

```
#include "suo.h"
int SuoKillTimer(SuoHandle handle);
```

[Argument(s)]

Argument	Description
<i>handle</i>	Handle of the timer interface

[Return value]

Macro	Description
SUO_NOERROR	Normal completion
<i>Error number</i>	Exit with error (abend) (see " B.4.8 Error numbers ")

[Description]

- This function stops the cyclic timer of the specified timer interface.
- If the timer is operating, the timer is stopped. If the timer is stopped, nothing is done (in this case, an error does not occur).

[Example]

```
#include "suo.h"
SuoHandle hTim1;

void func1(void)
{
    .....
    SuoKillTimer(hTim1);    /* Stop timer */
}
```

SuoSetNotifyTimerCallback

Registers timer time notification callback.

[Syntax]

```
#include    "suo.h"
int        SuoSetNotifyTimerCallback(SuoHandle handle, SuoNotifyTimerCallback func);
```

[Argument(s)]

Argument	Description
<i>handle</i>	Handle of the timer interface
<i>func</i>	Pointer to the user-defined function that reports the time of the timer (see "NotifyTimerFunc")

[Return value]

Macro	Description
SUO_NOERROR	Normal completion
<i>Error number</i>	Exit with error (abend) (see "B.4.8 Error numbers")

[Description]

- This function registers a user-defined function that performs processing when the time of the timer is reported.
- The registered function is called in every timer cycle of the specified timer interface.
- If NULL is specified for *func*, registration is canceled.

[Example]

```
#include    "suo.h"
void NotifyTimerFunc(SuoHandle handle);
SuoHandle hTim1;
void func1(void)
{
    .....
    SuoSetNotifyTimerCallback(hTim1, NotifyTimerFunc);    /* Set notify-timer function */
}

/* Notify-timer function */
void NotifyTimerFunc(SuoHandle handle)
{
    .....
}
```

B.4.4 Pin interface functions

The pin interface functions that are supplied by Simulator GUI are as follows:

Function Name	Outline of Function
SuoCreatePin	Generates pin interface.
SuoGetPinHandle	Acquires pin interface handle.
SuoOutputDigitalPin	Outputs digital pin value.
SuoOutputAnalogPin	Outputs analog pin value.
SuoOutputHighImpedance	Outputs high-impedance for the pin.
SuoSetInputDigitalPinCallback	Registers digital pin value input callback.
SuoSetInputAnalogPinCallback	Registers analog pin value input callback.
SuoSetInputHighImpedanceCallback	Registers pin high-impedance state report callback.

SuoCreatePin

Generates pin interface.

Caution This function can only be called in the [MakeUserModel](#) function. An error occurs if it is called at any other timing.

[Syntax]

```
#include "suo.h"
int SuoCreatePin(const char* pinName, SuoHandle* handle);
```

[Argument(s)]

Argument	Description
<i>pinName</i>	Name of the pin
<i>handle</i>	Location where the handle of the pin interface is to be stored

[Return value]

Macro	Description
SUO_NOERROR	Normal completion
<i>Error number</i>	Exit with error (abend) (see " B.4.8 Error numbers ")

[Description]

- This function generates a pin interface.
- The generated pin interface is associated with the name specified for *pinName*. Also, the pin specified as *pinName* is generated.
- If this function is successful, the handle of the generated pin interface can be obtained. The pin interface can then be controlled by specifying this handle.
The handle can also be obtained by using the [SuoGetPinHandle](#) function.

[Example]

```
#include "suo.h"
SuoHandle hPinP00;
SuoHandle hPinABC;

SuoUserEntry void MakeUserModel(const char *option)
{
    .....
    SuoCreatePin("P00", &hPinP00); /* Create "P00" */
    SuoCreatePin("ABC", &hPinABC); /* Create "ABC" */
}
```

SuoGetPinHandle

Acquires pin interface handle.

[Syntax]

```
#include    "suo.h"
SuoHandle  SuoGetPinHandle(const char* pinName);
```

[Argument(s)]

Argument	Description
<i>pinName</i>	Name of the pin

[Return value]

Macro	Description
<i>Handle of the specified pin interface</i>	Normal completion
NULL	Exit with error (abend)

[Description]

- This function is used to obtain the handle of the specified pin interface.
- Specify the name of a function specified by the [SuoCreatePin](#) function as *pinName* (if a different name is specified, NULL is returned).

[Example]

```
#include    "suo.h"
SuoHandle  hPinP00;

void func1(void)
{
    .....
    hPinP00 = SuoGetPinHandle("P00");      /* Get handle of "P00" */
}
```

SuoOutputDigitalPin

Outputs digital pin value.

Caution This function cannot be called in the [MakeUserModel](#) function. It can only be called in a callback function.

[Syntax]

```
#include "suo.h"
int     SuaOutputDigitalPin(SuoHandle handle, int pinValue);
```

[Argument(s)]

Argument	Description
<i>handle</i>	Handle of the pin interface
<i>pinValue</i>	Digital output value (specify any of the following) - SUO_HIGH (=1): HIGH value - SUO_LOW (=0): LOW value

[Return value]

Macro	Description
SUO_NOERROR	Normal completion
<i>Error number</i>	Exit with error (abend) (see " B.4.8 Error numbers ")

[Description]

- This function outputs a digital data signal specified with *pinValue* to the specified pin interface.
- To output an analog data signal, use the [SuoOutputAnalogPin](#) function.

[Example]

```
#include "suo.h"
SuoHandle hPinP00;

void func1(void)
{
    .....
    SuaOutputDigitalPin(hPinP00, SUO_HIGH);    /* Output HIGH */
}
```

SuoOutputAnalogPin

Outputs analog pin value.

Caution This function cannot be called in the [MakeUserModel](#) function. It can only be called in a callback function.

[Syntax]

```
#include "suo.h"
int SuoOutputAnalogPin(SuoHandle handle, double pinValue);
```

[Argument(s)]

Argument	Description
<i>handle</i>	Handle of the pin interface
<i>pinValue</i>	Analog output value (unit: V)

[Return value]

Macro	Description
SUO_NOERROR	Normal completion
<i>Error number</i>	Exit with error (abend) (see " B.4.8 Error numbers ")

[Description]

- This function outputs an analog data signal specified with *pinValue* to the specified pin interface.
- Specify *pinValue* in V (volts), as floating-point data.
- To output a digital data signal, use the [SuoOutputDigitalPin](#) function.

[Example]

```
#include "suo.h"
SuoHandle hPinP00;

void func1(void)
{
    .....
    SuoOutputAnalogPin(hPinP00, 3.5); /* Output 3.5V */
}
```

SuoOutputHighImpedance

Outputs high-impedance for the pin.

Caution This function cannot be called in the [MakeUserModel](#) function. It can only be called in a callback function.

[Syntax]

```
#include    "suo.h"
int        SuoOutputHighImpedance(SuoHandle handle);
```

[Argument(s)]

Argument	Description
<i>handle</i>	Handle of the pin interface

[Return value]

Macro	Description
SUO_NOERROR	Normal completion
<i>Error number</i>	Exit with error (abend) (see " B.4.8 Error numbers ")

[Description]

- This function is used to output high-impedance for the specified digital/analog pin interface.

[Example]

```
#include    "suo.h"
SuoHandle hPinP00;

void func1(void)
{
    .....
    SuoOutputHighImpedance(hPinP00);    /* Output High Impedance */
}
```

SuoSetInputDigitalPinCallback

Registers digital pin value input callback.

[Syntax]

```
#include "suo.h"
int SuoSetInputDigitalPinCallback(SuoHandle handle, SuoInputDigitalPinCallback func);
```

[Argument(s)]

Argument	Description
<i>handle</i>	Handle of the pin interface
<i>func</i>	Pointer to a user-defined function that performs digital pin input processing (see " InputDigitalPin-Func ")

[Return value]

Macro	Description
SUO_NOERROR	Normal completion
<i>Error number</i>	Exit with error (abend) (see " B.4.8 Error numbers ")

[Description]

- This function is used to register a user-defined function that performs digital pin input processing.
- The registered function is called when a signal is input to the specified pin.
- If NULL is specified for *func*, registration is canceled.

[Example]

```
#include "suo.h"
void InputDigitalPinFunc(SuoHandle handle, int pinValue);
SuoHandle hPinP00;

void func1(void)
{
    .....
    SuoSetInputDigitalPinCallback(hPinP00, InputDigitalPinFunc); /* Set input-digital-pin function */
}

/* Input-digital-pin function */
void InputDigitalPinFunc(SuoHandle handle, int pinValue)
{
    .....
}
```

SuoSetInputAnalogPinCallback

Registers analog pin value input callback.

[Syntax]

```
#include    "suo.h"
int        SuoSetInputAnalogPinCallback(SuoHandle handle, SuoInputAnalogPinCallback func);
```

[Argument(s)]

Argument	Description
<i>handle</i>	Handle of the pin interface
<i>func</i>	Pointer to a user-defined function that performs analog pin input processing (see " InputAnalogPinFunc ")

[Return value]

Macro	Description
SUO_NOERROR	Normal completion
<i>Error number</i>	Exit with error (abend) (see " B.4.8 Error numbers ")

[Description]

- This function is used to register a user-defined function that performs analog pin input processing.
- The registered function is called when a signal is input to the specified pin.
- If NULL is specified for *func*, registration is canceled.

[Example]

```
#include    "suo.h"
void InputAnalogPinFunc(SuoHandle handle, double pinValue);
SuoHandle hPinP00;

void func1(void)
{
    .....
    SuoSetInputAnalogPinCallback(hPinP00, InputAnalogPinFunc); /* Set input-analog-pin function */
}

/* Input-analog-pin function */
void InputAnalogPinFunc(SuoHandle handle, double pinValue)
{
    .....
}
```

SuoSetInputHighImpedanceCallback

Registers pin high-impedance state report callback.

[Syntax]

```
#include    "suo.h"
int  SuoSetInputHighImpedanceCallback(SuoHandle handle, SuoInputHighImpedanceCallback func);
```

[Argument(s)]

Argument	Description
<i>handle</i>	Handle of the pin interface
<i>func</i>	Pointer to a user-defined function that performs processing when all the connected pins enter the high-impedance state (see " InputHighImpedanceFunc ")

[Return value]

Macro	Description
SUO_NOERROR	Normal completion
<i>Error number</i>	Exit with error (abend) (see " B.4.8 Error numbers ")

[Description]

- This function is used to register the user-defined function that performs processing when all the pins connected to digital/analog pins enter the high-impedance state.
- If NULL is specified for *func*, registration is canceled.

[Example]

```
#include    "suo.h"
void InputHighImpedanceFunc(SuoHandle handle);
SuoHandle hPinP00;

void func1(void)
{
    .....
    SuoSetInputHighImpedanceCallback(hPinP00, InputHighImpedanceFunc);
                                     /* Set input-high-impedance function */
}

/* Input-high-impedance function */
void InputHighImpedanceFunc(SuoHandle handle)
{
    .....
}
```

B.4.5 External bus interface functions

The external bus interface functions that are supplied by Simulator GUI are as follows:

Function Name	Outline of Function
SuoCreateExtbus	Generates external bus interface.
SuoGetExtbusHandle	Acquires external bus interface handle.
SuoSetReadExtbusCallback	Registers external bus read access callback.
SuoSetWriteExtbusCallback	Registers external bus write access callback.

Caution When using the external bus interface function, the external memory area to use must be set to [Target memory area] with the [Memory Type] area of the [Memory Mapping dialog box](#).

SuoCreateExtbus

Generates external bus interface.

- Cautions 1.** This function can only be called in the [MakeUserModel](#) function. An error occurs if it is called at any other timing.
- 2.** When using the external bus interface function, the external memory area to use must be set to [Target memory area] with the [Memory Type] area of the [Memory Mapping dialog box](#).

[Syntax]

```
#include "suo.h"
int SuoCreateExtbus(const char* extbusName, unsigned long addr, unsigned long size,
SuoHandle* handle);
```

[Argument(s)]

Argument	Description
<i>extbusName</i>	Name of the external bus
<i>addr</i>	The first address of the external memory area
<i>size</i>	Size of the external memory area
<i>handle</i>	Location where the handle of the external bus interface is to be stored

[Return value]

Macro	Description
SUO_NOERROR	Normal completion
<i>Error number</i>	Exit with error (abend) (see " B.4.8 Error numbers ")

[Description]

- This function is used to generate an external bus interface.
- The generated external bus interface is associated with the name specified for *extbusName*.
- If this function is successful, the handle of the generated external bus interface can be obtained. The external bus interface can then be controlled by specifying this handle.
The handle can also be obtained by using the [SuoGetExtbusHandle](#) function.

[Example]

```
#include    "suo.h"
SuoHandle hExtbus1;

SuoUserEntry void MakeUserModel(const char *option)
{
    .....
    SuoCreateExtbus("EXTBUS1", 0x200000, 0x1000, &hExtbus1);    /* Create "EXTBUS1" */
}
```

SuoGetExtbusHandle

Acquires external bus interface handle.

[Syntax]

```
#include    "suo.h"
SuoHandle  SuaGetExtbusHandle(const char* extbusName);
```

[Argument(s)]

Argument	Description
<i>extbusName</i>	Name of the external bus

[Return value]

Macro	Description
<i>Handle of the specified external bus interface</i>	Normal completion
NULL	Exit with error (abend)

[Description]

- This function is used to obtain the handle of the specified external bus interface.
- Specify the name specified by the [SuoCreateExtbus](#) function as *extbusName* (if a different name is specified, NULL is returned).

[Example]

```
#include    "suo.h"
SuoHandle  hExtbus1;

void func1(void)
{
    .....
    hExtbus1 = SuaGetExtbusHandle("EXTBUS1");    /* Get handle of "EXTBUS1" */
}
```

SuoSetReadExtbusCallback

Registers external bus read access callback.

[Syntax]

```
#include    "suo.h"
int        SuoSetReadExtbusCallback(SuoHandle handle, SuoReadExtbusCallback func);
```

[Argument(s)]

Argument	Description
<i>handle</i>	Handle of the external bus interface
<i>func</i>	Pointer to a user-defined function that performs read access processing of an external bus (see "ReadExtbusFunc")

[Return value]

Macro	Description
SUO_NOERROR	Normal completion
<i>Error number</i>	Exit with error (abend) (see "B.4.8 Error numbers")

[Description]

- This function is used to register a user-defined function that performs read access processing of an external bus.
- The registered function is called if a read request is issued to the specified external bus (in the registered address range).
- If NULL is specified for *func*, registration is canceled.

[Example]

```
#include    "suo.h"
void ReadExtbusFunc(SuoHandle handle, unsigned long addr, int accessSize, unsigned char data[]);
SuoHandle hExtbus1;

void func1(void)
{
    .....
    SuoSetReadExtbusCallback(hExtbus1, ReadExtbusFunc);    /* Set read-external-bus function */
}

/* Read-external-bus function */
void ReadExtbusFunc(SuoHandle handle, unsigned long addr, int accessSize, unsigned char data[])
{
    .....
}
```

SuoSetWriteExtbusCallback

Registers external bus write access callback.

[Syntax]

```
#include    "suo.h"
int        SuoSetWriteExtbusCallback(SuoHandle handle, SuoWriteExtbusCallback func);
```

[Argument(s)]

Argument	Description
<i>handle</i>	Handle of the external bus interface
<i>func</i>	Pointer to a user-defined function that performs write access processing of an external bus (see " WriteExtbusFunc ")

[Return value]

Macro	Description
SUO_NOERROR	Normal completion
<i>Error number</i>	Exit with error (abend) (see " B.4.8 Error numbers ")

[Description]

- This function is used to register a user-defined function that performs write access processing of an external bus.
- The registered function is called when a write request is issued to the specified external bus (in the registered address range).
- If NULL is specified for *func*, registration is canceled.

[Example]

```
#include "suo.h"
void WriteExtbusFunc(SuoHandle handle, unsigned long addr, int accessSize, const unsigned char data[]);
SuoHandle hExtbus1;

void func1(void)
{
    .....
    SuoSetWriteExtbusCallback(hExtbus1, WriteExtbusFunc); /* Set write-external-bus function */
}

/* Write-external-bus function */
void WriteExtbusFunc(SuoHandle handle, unsigned long addr, int accessSize, const unsigned char data[])
{
    .....
}
```

B.4.6 Serial interface functions

The serial interface functions that are supplied by Simulator GUI are as follows:

Function Name	Outline of Function
SuoCreateSerialUART	Generates serial interface (UART type).
SuoCreateSerialCSI	Generates serial interface (CSI type).
SuoGetSerialHandle	Acquires serial interface handle.
SuoSetSerialParameterUART	Sets serial parameter (UART type).
SuoSetSerialParameterCSI	Sets serial parameter (CSI type).
SuoGetSerialParameterUART	Acquires serial parameter (UART type).
SuoGetSerialParameterCSI	Acquires serial parameter (CSI type).
SuoSendSerialData	Performs serial transmission (1 data).
SuoSendSerialDataList	Performs serial transmission (more than one data).
SuoSendSerialFile	Performs serial transmission (serial transmission data file).
SuoSetNotifySentSerialCallback	Registers serial transmission end notification callback.
SuoSetReceiveSerialCallback	Registers serial reception callback.

SuoCreateSerialUART

Generates serial interface (UART type).

Caution This function can only be called in the [MakeUserModel](#) function. An error occurs if it is called at any other timing.

[Syntax]

```
#include "suo.h"

int SuoCreateSerialUART(const char* serialName, const char* pinNameTXD, const char*
pinNameRXD, SuoHandle* handle);
```

[Argument(s)]

Argument	Description
<i>serialName</i>	Name of the serial
<i>pinNameTXD</i>	Name of the transmit data pin used by the serial
<i>pinNameRXD</i>	Name of the receive data pin used by the serial
<i>handle</i>	Location where the handle of the serial interface is to be stored

[Return value]

Macro	Description
SUO_NOERROR	Normal completion
<i>Error number</i>	Exit with error (abend) (see "B.4.8 Error numbers")

[Description]

- This function is used to generate a serial interface (UART type).
- The generated serial interface is associated with the name specified for *serialName*. In addition, pins specified as *pinNameTXD* and *pinNameRXD* are also generated.
- If this function is successful, the handle of the generated serial interface can be obtained. The serial interface can then be controlled by specifying this handle.
The handle can also be obtained by using the [SuoGetSerialHandle](#) function.

[Example]

```
#include "suo.h"
SuoHandle hUart1;

SuoUserEntry void MakeUserModel(const char *option)
{
    .....
    SuoCreateSerialUART("UART1", "TXD1", "RXD1", &hUart1); /* Create "UART1" */
}
```

SuoCreateSerialCSI

Generates serial interface (CSI type).

Caution This function can only be called in the [MakeUserModel](#) function. An error occurs if it is called at any other timing.

[Syntax]

```
#include "suo.h"

int SuoCreateSerialCSI(const char* serialName, const char* pinNameSO, const char*
pinNameSI, const char* pinNameSCK, SuoHandle* handle);
```

[Argument(s)]

Argument	Description
<i>serialName</i>	Name of the serial
<i>pinNameSO</i>	Name of the transmit data pin used by the serial
<i>pinNameSI</i>	Name of the receive data pin used by the serial
<i>pinNameSCK</i>	Name of the clock pin used by the serial
<i>handle</i>	Location where the handle of the serial interface is to be stored

[Return value]

Macro	Description
SUO_NOERROR	Normal completion
<i>Error number</i>	Exit with error (abend) (see "B.4.8 Error numbers")

[Description]

- This function is used to generate a serial interface (CSI type).
- The generated serial interface is associated with the name specified for *serialName*. In addition, the pins specified as *pinNameSO*, *pinNameSI*, and *pinNameSCK* are also generated.
- If this function is successful, the handle of the generated serial interface can be obtained. The serial interface can then be controlled by specifying this handle.
The handle can also be obtained by using the [SuoGetSerialHandle](#) function.

[Example]

```
#include    "suo.h"
SuoHandle hCsi1;

SuoUserEntry void MakeUserModel(const char *option)
{
    .....
    SuoCreateSerialCSI("CSI1", "S01", "SI1", "SCK1", &hCsi1);    /* Create "CSI1" */
}
```

SuoGetSerialHandle

Acquires serial interface handle.

[Syntax]

```
#include    "suo.h"
SuoHandle  SuoGetSerialHandle(const char* serialName);
```

[Argument(s)]

Argument	Description
<i>serialName</i>	Name of the serial

[Return value]

Macro	Description
<i>Handle of the specified serial interface</i>	Normal completion
NULL	Exit with error (abend)

[Description]

- This function is used to obtain the handle of the specified serial interface.
- Specify the name specified by the [SuoCreateSerialUART](#) or [SuoCreateSerialCSI](#) function as *serialName* (if a different name is specified, NULL is returned).

[Example]

```
#include    "suo.h"
SuoHandle  hSerial1;

void func1(void)
{
    .....
    hSerial1 = SuoGetSerialHandle("SERIAL1");    /* Get handle of "SERIAL1" */
}
```

SuoSetSerialParameterUART

Sets serial parameter (UART type).

Caution This function cannot be called in the [MakeUserModel](#) function. It can only be called in a callback function.

[Syntax]

```
#include "suo.h"
int SuoSetSerialParameterUART(SuoHandle handle, const SuoSerialParameterUART* param);
```

[Argument(s)]

Argument	Description
<i>handle</i>	Handle of the serial interface
<i>param</i>	Location where the parameters of the serial interface (UART type) are to be stored Specify a pointer to SuoSerialParameterUART structure ^{Note} .

Note The configuration of SuoSerialParameterUART structure is as follows:

```
typedef struct {
    unsigned long baudrate;          /* Baud rate */
    int direction;                  /* Transfer direction */
    int dataLength;                 /* Data bit length */
    int stopLength;                 /* Stop bit length */
    int parity;                     /* Parity */
} SuoSerialParameterUART;
```

Parameter (UART Type)	Value	Description
Baud rate	<i>Baud rate value</i>	Unit: bps
Transfer direction	SUO_MSBFIRST	MSB first
	SUO_LSBFIRST	LSB first
Data bit length	1 to 32	-
Stop bit length	1 or 2	-
Parity	SUO_NONEPARITY	No parity
	SUO_ZEROPARITY	0 parity (During transmission: parity 0, During reception: no parity check)
	SUO_ODDPARITY	Odd parity
	SUO_EVENPARITY	Even parity

[Return value]

Macro	Description
SUO_NOERROR	Normal completion
<i>Error number</i>	Exit with error (abend) (see "B.4.8 Error numbers")

[Description]

- This function is used to set parameters (UART type) related to the serial operation of the specified serial interface.

The default values of the parameters are as follows:

- Baud rate: 9600 bps
- Transfer direction: LSB first
- Data bit length: 7 bits
- Stop bit length: 1 bit
- Parity: None

[Example]

```
#include "suo.h"
SuoHandle hUart1;

void func1(void)
{
    SuoSerialParameterUART param;
    .....
    param.baudrate = 19200; /* 19200 bps */
    param.direction = SUO_LSBFIRST; /* LSB First */
    param.dataLength = 8; /* databit 8 bit */
    param.stopLength = 1; /* stopbit 1 bit */
    param.parity = SUO_EVENPARITY; /* even parity */
    SuoSetSerialParameterUART(hUart1, &param); /* Set parameter of UART1 */
}
```

SuoSetSerialParameterCSI

Sets serial parameter (CSI type).

Caution This function cannot be called in the [MakeUserModel](#) function. It can only be called in a callback function.

[Syntax]

```
#include "suo.h"
int SuoSetSerialParameterCSI(SuoHandle handle, const SuoSerialParameterCSI* param);
```

[Argument(s)]

Argument	Description
<i>handle</i>	Handle of the serial interface
<i>param</i>	Location where the parameters of the serial interface (CSI type) are to be stored Specify a pointer to SuoSerialParameterCSI structure ^{Note} .

Note The configuration of SuoSerialParameterCSI structure is as follows:

```
typedef struct {
    int mode; /* Operation mode */
    unsigned long frequency; /* Frequency of transfer clock */
    int phase; /* Phase */
    int direction; /* Transfer direction */
    int datalength; /* Data bit length */
} SuoSerialParameterCSI;
```

Parameter (CSI Type)	Value	Description	
Operation mode	SUO_MASTER	Master operation	
	SUO_SLAVE	Slave operation	
Frequency of transfer clock	<i>Frequency</i>	Unit: Hz Note that "0" cannot be specified if master operation.	
Phase	0	Normal phase	See "Table B-3."
	SUO_PRECEDEDATA	Data output first	
	SUO_REVERSELOCK	Clock reversal	
	SUO_PRECEDEDATA SUO_REVERSELOCK	Specifies both data output first and clock reversal.	
Transfer direction	SUO_MSBFIRS	MSB first	
	SUO_LSBFIRST	LSB first	
Data bit length	1 to 32	-	

Table B-3. CSI Phase Types (SuoSetSerialParameterCSI Function)

Value of Phase	Phase
0	
SUO_PRECEDEDATA	
SUO_REVERSELOCK	
SUO_PRECEDEDATA SUO_REVERSELOCK	

[Return value]

Macro	Description
SUO_NOERROR	Normal completion
<i>Error number</i>	Exit with error (abend) (see "B.4.8 Error numbers")

[Description]

- This function is used to set parameters (CSI type) related to the serial operation of the specified serial interface. The default values of the parameters are as follows:
 - Operation mode : Slave
 - Frequency of transfer clock : 0
 - Phase : Normal phase
 - Transfer direction : MSB first
 - Data bit length : 8 bits
- When operating as the master for CSI communication, transmission of dummy data is required for reception because the CSI is the communication mode that performs transmission/reception in response to the clock output from the master.

Remark If the CSI pin waveform is checked in the [Timing Chart window](#) while CSI communication is not performed, an unexpected level will be monitored.

The expected level will be output after communication starts, so this issue does not affect the actual operation.

- SCK pin (in slave mode) : High level is output (which should be high impedance).
- SO pin : High level is output (which should be low level).

[Example]

```
#include "suo.h"

SuoHandle hCs11;
void func1(void)
{
    SuoSerialParameterCSI param;
    .....
    param.mode          = SUO_SLAVE;          /* slave */
    param.frequency     = 1000000;          /* 1MHz */
    param.phase         = 0;                 /* normal */
    param.direction     = SUO_LSBFIRST;     /* LSB First */
    param.dataLength    = 8;                 /* databit 8bit */
    SuoSetSerialParameterCSI(hCs11, &param); /* Set parameter of CSI1 */
}
```

SuoGetSerialParameterUART

Acquires serial parameter (UART type).

Caution This function cannot be called in the [MakeUserModel](#) function. It can only be called in a callback function.

[Syntax]

```
#include "suo.h"
int SuoGetSerialParameterUART(SuoHandle handle, SuoSerialParameterUART* param);
```

[Argument(s)]

Argument	Description
<i>handle</i>	Handle of the serial interface
<i>param</i>	Location where the parameters of the serial interface (UART type) are to be stored Specify a pointer to SuoSerialParameterUART structure ^{Note} .

Note For details on SuoSerialParameterUART structure, see the [SuoSetSerialParameterUART](#) function.

[Return value]

Macro	Description
SUO_NOERROR	Normal completion
<i>Error number</i>	Exit with error (abend) (see " B.4.8 Error numbers ")

[Description]

- This function is used to obtain the parameters (UART type) related to serial operation of the specified serial interface.

[Example]

```
#include "suo.h"
SuoHandle hUart1;

void func1(void)
{
    SuoSerialParameterUART param;
    .....
    SuoGetSerialParameterUART(hUart1, &param); /* Get parameter of UART1 */
    .....
}
```

SuoGetSerialParameterCSI

Acquires serial parameter (CSI type).

Caution This function cannot be called in the [MakeUserModel](#) function. It can only be called in a callback function.

[Syntax]

```
#include "suo.h"
int SuoGetSerialParameterCSI(SuoHandle handle, SuoSerialParameterCSI* param);
```

[Argument(s)]

Argument	Description
<i>handle</i>	Handle of the serial interface
<i>param</i>	Location where the parameters of the serial interface (UART type) are to be stored Specify a pointer to SuoSerialParameterCSI structure ^{Note} .

Note For details on SuoSerialParameterCSI structure, see the [SuoSetSerialParameterCSI](#) function.

[Return value]

Macro	Description
SUO_NOERROR	Normal completion
<i>Error number</i>	Exit with error (abend) (see " B.4.8 Error numbers ")

[Description]

- This function is used to obtain the parameters (CSI type) related to serial operation of the specified serial interface.

[Example]

```
#include "suo.h"
SuoHandle hCsi1;

void func1(void)
{
    SuoSerialParameterCSI param;
    .....
    SuoGetSerialParameterCSI(hCsi1, &param); /* Get parameter of CSI1 */
    .....
}
```

SuoSendSerialData

Performs serial transmission (1 data).

- Cautions 1.** Be sure to use the [SuoSendSerialDataList](#) function (for serial transmission of multiple data units) when executing continuous UART transmission.
- 2.** If this function is called using [NotifySentSerialFunc](#) function (serial transmission completion report callback function), transmission start is delayed for half the baud rate cycle of UART.
- 3.** This function cannot be called in the [MakeUserModel](#) function. It can only be called in a call-back function.

[Syntax]

```
#include "suo.h"
int SuoSendSerialData(SuoHandle handle, unsigned long data);
```

[Argument(s)]

Argument	Description
<i>handle</i>	Handle of the serial interface
<i>data</i>	Transmit data (1 data)

[Return value]

Macro	Description
SUO_NOERROR	Normal completion
<i>Error number</i>	Exit with error (abend) (see "B.4.8 Error numbers")

[Description]

- This function is used to start transmitting one serial data.
- It takes time to complete transmitting the serial data. If you want to know the timing of transmission completion, set the transmission end notification function by using the [SuoSetNotifySentSerialCallback](#) function.
- If this function is called for a serial interface that is currently transmitting data, an error occurs.

[Example]

```
#include "suo.h"
SuoHandle hSerial1;

void func1(void)
{
    .....
    SuoSendSerialData(hSerial1, 0x80); /* Send 0x80 */
}
```

SuoSendSerialDataList

Performs serial transmission (more than one data).

Caution This function cannot be called in the [MakeUserModel](#) function. It can only be called in a callback function.

[Syntax]

```
#include "suo.h"
int SuoSendSerialDataList(SuoHandle handle, long count, unsigned long dataList[]);
```

[Argument(s)]

Argument	Description
<i>handle</i>	Handle of the serial interface
<i>count</i>	Number of data to be transmitted (1 to 32767)
<i>dataList[]</i>	Transmit data Specify an array consisting of the number of data to be transmitted.

[Return value]

Macro	Description
SUO_NOERROR	Normal completion
<i>Error number</i>	Exit with error (abend) (see "B.4.8 Error numbers")

[Description]

- This function is used to start transmitting two or more serial data.
- It takes time to complete transmission of the serial data. If you want to know the timing of transmission completion, set the transmission end notification function by using the [SuoSetNotifySentSerialCallback](#) function.
- If this function is called for a serial interface that is currently transmitting data, an error occurs.

[Example]

```
#include "suo.h"
SuoHandle hSerial1;

void func1(void)
{
    unsigned long dataList[6] = {0x73, 0x65, 0x72, 0x69, 0x61, 0x6c};
    .....
    SuoSendSerialDataList(hSerial1, 6, dataList); /* Send dataList */
}
```

SuoSendSerialFile

Performs serial transmission (serial transmission data file).

Caution This function cannot be called in the [MakeUserModel](#) function. It can only be called in a callback function.

[Syntax]

```
#include "suo.h"
int SuoSendSerialFile(SuoHandle handle, const char* serialFile);
```

[Argument(s)]

Argument	Description
<i>handle</i>	Handle of the serial interface
<i>serialFile</i>	Name of the serial transmission data file that has been saved after being edited on the Serial window Note that if <i>serialFile</i> is specified by a relative path, it is treated as relative to the path of the user model (<i>UserModel.dll</i>).

[Return value]

Macro	Description
SUO_NOERROR	Normal completion
<i>Error number</i>	Exit with error (abend) (see "B.4.8 Error numbers")

[Description]

- This function is used to start transmitting serial data described in a serial transmission data file (*.ser) that has been saved after being edited on the [Serial window](#).
- It takes time to complete transmission of the serial data. If you want to know the timing of transmission completion, set the transmission end notification function by using the [SuoSetNotifySentSerialCallback](#) function.
- If this function is called for a serial interface that is currently transmitting data, an error occurs.

[Example]

```
#include "suo.h"
SuoHandle hSerial1;

void func1(void)
{
    .....
    SuoSendSerialFile(hSerial1, "foo.ser"); /* Send serial data on "foo.ser" */
}
```

SuoSetNotifySentSerialCallback

Registers serial transmission end notification callback.

[Syntax]

```
#include "suo.h"
int SuoSetNotifySentSerialCallback(SuoHandle handle, SuoNotifySentSerialCallback func);
```

[Argument(s)]

Argument	Description
<i>handle</i>	Handle of the serial interface
<i>func</i>	Pointer to a user-defined function that performs processing when serial transmission is completed (see "NotifySentSerialFunc")

[Return value]

Macro	Description
SUO_NOERROR	Normal completion
<i>Error number</i>	Exit with error (abend) (see "B.4.8 Error numbers")

[Description]

- This function is used to register a user-defined function that performs processing when serial transmission is completed.
- The registered function is called when one or more serial data specified to be transmitted have been completely transmitted.
- If NULL is specified for *func*, registration is canceled.

[Example]

```
#include "suo.h"
void NotifySentSerialFunc(SuoHandle handle);
SuoHandle hSerial1;

void func1(void)
{
    .....
    SuoSetNotifySentSerialCallback(hSerial1, NotifySentSerialFunc);
                                     /* Set notify-sent-serial function */
}
/* Notify-sent-serial function */
void NotifySentSerialFunc(SuoHandle handle)
{
    .....
}
```

SuoSetReceiveSerialCallback

Registers serial reception callback.

[Syntax]

```
#include    "suo.h"
int        SuoSetReceiveSerialCallback(SuoHandle handle, SuoReceiveSerialCallback func);
```

[Argument(s)]

Argument	Description
<i>handle</i>	Handle of the serial interface
<i>func</i>	Pointer to a user-defined function that performs processing when serial data is received (see "ReceiveSerialFunc")

[Return value]

Macro	Description
SUO_NOERROR	Normal completion
<i>Error number</i>	Exit with error (abend) (see "B.4.8 Error numbers")

[Description]

- This function is used to register a user-defined function that performs processing when serial data is received.
- The registered function is called when one serial data has been received.
- If NULL is specified for *func*, registration is canceled.

[Example]

```
#include    "suo.h"
void ReceiveSerialFunc(SuoHandle handle, unsigned long data, int status);
SuoHandle hSerial1;

void func1(void)
{
    .....
    SuoSetReceiveSerialCallback(hSerial1, ReceiveSerialFunc);
                                     /* Set receive-serial function */
}
/* Receive-serial function */
void ReceiveSerialFunc(SuoHandle handle, unsigned long data, int status)
{
    .....
}
```

B.4.7 Signal output unit interface functions

The signal output unit interface functions that are supplied by Simulator GUI are as follows:

Function Name	Outline of Function
SuoCreateWave	Generates signal output unit interface.
SuoGetWaveHandle	Acquires signal output unit interface handle.
SuoSendWaveFile	Performs transmission via signal output unit.
SuoSetNotifySentWaveCallback	Registers signal output unit transmission end notification callback.

SuoCreateWave

Generates signal output unit interface.

Caution This function can only be called in the [MakeUserModel](#) function. An error occurs if it is called at any other timing.

[Syntax]

```
#include "suo.h"
int SuoCreateWave(const char* waveName, int count, const char* pinNameList[], SuoHandle* handle);
```

[Argument(s)]

Argument	Description
<i>waveName</i>	Name of the signal output unit
<i>count</i>	Number of pins used by the signal output unit
<i>pinNameList[]</i>	Names of the pins used by the signal output unit Specify names in an array equivalent to the number of pins.
<i>handle</i>	Location where the handle of the signal output unit interface is to be stored

[Return value]

Macro	Description
SUO_NOERROR	Normal completion
<i>Error number</i>	Exit with error (abend) (see "B.4.8 Error numbers")

[Description]

- This function is used to generate a signal output unit interface.
- The generated signal output unit interface is associated with the name specified for *waveName*. In addition, the pins specified by *count* and *pinNameList* are also generated.
- If this function is successful, the handle of the generated signal output unit interface can be obtained. The signal output unit interface can then be controlled by specifying this handle.
The handle can also be obtained by using the [SuoGetWaveHandle](#) function.

[Example]

```
#include "suo.h"
SuoHandle hWave1;

SuoUserEntry void MakeUserModel(const char *option)
{
    .....
    char* pinNameList[4] = {"P00", "P01", "P02", "P03"};
    SuoCreateWave("WAVE1", 4, pinNameList, &hWave1);    /* Create "WAVE1" */
}
```

SuoGetWaveHandle

Acquires signal output unit interface handle.

[Syntax]

```
#include    "suo.h"
SuoHandle  SuoGetWaveHandle(const char* waveName);
```

[Argument(s)]

Argument	Description
<i>waveName</i>	Name of the signal output unit

[Return value]

Macro	Description
<i>Handle of the signal output unit interface</i>	Normal completion
NULL	Exit with error (abend)

[Description]

- This function is used to obtain the handle of the specified signal output unit interface.
- Specify the name specified by the [SuoCreateWave](#) function as *waveName* (if a different name is specified, NULL is returned).

[Example]

```
#include    "suo.h"
SuoHandle  hWave1;

void func1(void)
{
    .....
    hWave1 = SuoGetWaveHandle("WAVE1");      /* Get handle of "WAVE1" */
}
```

SuoSendWaveFile

Performs transmission via signal output unit.

Caution This function cannot be called in the [MakeUserModel](#) function. It can only be called in a callback function.

[Syntax]

```
#include "suo.h"
int SuoSendWaveFile(SuoHandle handle, const char* waveFile);
```

[Argument(s)]

Argument	Description
<i>handle</i>	Handle of the signal output unit interface
<i>waveFile</i>	Name of the signal data file that has been saved after being edited on the Signal Data Editor window Note that if <i>waveFile</i> is specified by a relative path, it is treated as relative to the path of the user model (<i>UserModel.dll</i>).

[Return value]

Macro	Description
SUO_NOERROR	Normal completion
<i>Error number</i>	Exit with error (abend) (see "B.4.8 Error numbers")

[Description]

- This function is used to start transmitting a signal value whose timing is described in a signal data file (*.wvi) that has been saved after being edited on the [Signal Data Editor window](#).
- It takes time to complete transmitting the signal data file. If you want to know the timing of transmission completion, set the transmission end notification function by using the [SuoSetNotifySentWaveCallback](#) function.
- If this function is called for a signal output unit interface that is currently transmitting data, the data being transmitted is canceled and the newly specified data is transmitted.

[Example]

```
#include "suo.h"
SuoHandle hWave1;

void func1(void)
{
    .....
    SuoSendWaveFile(hSerial1, "foo.wvi"); /* Send pin data on "foo.wvi" */
}
```

SuoSetNotifySentWaveCallback

Registers signal output unit transmission end notification callback.

[Syntax]

```
#include    "suo.h"
int        SuoSetNotifySentWaveCallback(SuoHandle handle, SuoNotifySentWaveCallback func);
```

[Argument(s)]

Argument	Description
<i>handle</i>	Handle of the signal output unit interface
<i>func</i>	Pointer to a user-defined function that performs processing when transmission by the signal output unit is completed (see "NotifySentWaveFunc")

[Return value]

Macro	Description
SUO_NOERROR	Normal completion
<i>Error number</i>	Exit with error (abend) (see "B.4.8 Error numbers")

[Description]

- This function is used to register a user function that performs processing when transmission by the signal output unit is completed.
- The registered function is called when all signal data specified to be transmitted have been completely transmitted.
- If NULL is specified for *func*, registration is canceled.

[Example]

```
#include    "suo.h"
void NotifySentWaveFunc(SuoHandle handle);
SuoHandle hWave1;

void func1(void)
{
    .....
    SuoSetNotifySentWaveCallback(hWave1, NotifySentWaveFunc);
                                     /* Set notify-sent-wave function */
}
/* Notify-sent-wave function */
void NotifySentWaveFunc(SuoHandle handle)
{
    .....
}
```

B.4.8 Error numbers

The meanings of error numbers (macro names) that are returned from the supplied interface function as return values are as follows:

Note that an error number is indicated by a macro name defined by the supplied header file (suo.h).

Table B-4. List of Error Numbers (Macro Names)

Error number (Macro Name)	Description
SUO_NOERROR	Normal completion
SUO_CANTALLOC	Memory cannot be allocated.
SUO_ILLIFNAME	The interface name is not correct. NULL or "" is specified for the interface name. Or, an interface name that has not been generated is specified for a handle acquisition function.
SUO_ILLHANDLE	The handle is not correct. A handle other than that of the generated interface is specified.
SUO_ILLPARAM	The argument (parameter) is not correct. A value other than those that can be specified is specified as a argument (parameter).
SUO_CANTCALL	The function cannot be called. A function that can be called only by the MakeUserModel function is called by another function. Or, a function that can be called by a function other than the MakeUserModel function is called by the MakeUserModel function.
SUO_CONFLICTRES	The resources to be generated conflict. Two or more names that are the same as an interface name or pin name generated in the MakeUserModel function exist.
SUO_ILLFILENAME	The file name is not correct. NULL or a name including an invalid character is specified for a file name.
SUO_CANTOPENFILE	The signal data file cannot be opened. The signal data file does not exist, or is not permitted to be read.
SUO_ILLFILEFMT	[Serial transmission data file] The file cannot be opened. The file does not exist, is not permitted to be read, or the file name is not correct. [Signal data file] The file format is not correct. NULL or a name including an invalid character is specified for a file name.
SUO_ILLFILECONT	The file contents are not correct. The contents of data described in the file include a contradiction, or no data exists in the file.
SUO_ILLPINNAME	The pin name is not correct. NULL or "" is specified for the pin name.
SUO_ILLADDRRANGE	The address range is not correct. The address range is not valid.
SUO_UNDERSENDING	Already being transmitted. New transmission cannot be started because transmission is in progress.

B.5 User-Defined Functions

This section describes the user-defined functions that user creates.

The user-defined functions are listed below.

Table B-5. List of User-Defined Functions

Function Name	Outline of Function
MakeUserModel	MakeUserModel entry function
InitFunc	Initialization callback function
ResetFunc	Reset callback function
NotifyTimerFunc	Timer time notification callback function
InputDigitalPinFunc	Digital pin input value callback function
InputAnalogPinFunc	Analog pin input value callback function
InputHighImpedanceFunc	Pin high-impedance state report callback function
ReadExtbusFunc	External bus read access callback function
WriteExtbusFunc	External bus write access callback function
NotifySentSerialFunc	Serial interface transmission end notification callback function
ReceiveSerialFunc	Serial interface reception callback function
NotifySentWaveFunc	Serial interface reception callback function

MakeUserModel

Creates the resources to be used as the entry function of the user model.

Caution Because `MakeUserModel` is a static entry function of the user model, this function name must be used.

[Syntax]

```
#include "suo.h"
SuoUserEntry void MakeUserModel(const char *option);
```

[Argument(s)]

Argument	Description
<i>option</i>	Option character string specified in the simulator configuration file Note that if no option is specified in the simulator configuration file, NULL character (" ") is assumed.

[Return value]

None

[Description]

- This function must be used to generate the resources to be used with the user model. Any function other than this function cannot generate the resources.
- This function must be used to register a callback function as necessary. In particular, an initialization callback function must be registered by this function (because the initialization timing has passed even if a function is registered by a function other than this function).

[Example]

```
#include "suo.h"
SuoHandle hTim1;
SuoHandle hPinP00;
SuoHandle hExtbus1;

void InitFunc(void);
void ResetFunc(void);

SuoUserEntry void MakeUserModel(const char *option)
{
    /* Create source */
    SuoCreateTimer("TIM1", &hTim1);           /* Create "TIM1" */
    SuoCreatePin("P00", &hPinP00);          /* Create "P00" */
    SuoCreateExtbus("EXTBUS1", 0x200000, 0x1000, &hExtbus1); /* Create "EXTBUS1" */

    /* Set callbacks */
    SuoSetInitCallback(InitFunc);           /* Set initialize function */
    SuoSetResetCallback(ResetFunc);        /* Set reset function */
}
```

InitFunc

Performs the initialization processing as a callback function.

Caution **InitFunc** is a place holder for a user-defined function name, so this function name does not have to be used.

[Syntax]

```
#include "suo.h"
void InitFunc (void);
```

[Argument(s)]

None

[Return value]

None

[Description]

- InitFunc describes initialization processing.
- Use the [SuoSetInitCallback](#) function to register InitFunc as a callback function.

ResetFunc

Performs the reset processing as a callback function.

Caution ResetFunc is a place holder for a user-defined function name, so this function name does not have to be used.

[Syntax]

```
#include "suo.h"
void ResetFunc (void);
```

[Argument(s)]

None

[Return value]

None

[Description]

- ResetFunc describes the reset processing.
- Use the [SuoSetResetCallback](#) function to register ResetFunc as a callback function.

NotifyTimerFunc

Performs the processing when the timer time is reported, as a callback function.

Caution **NotifyTimerFunc** is a place holder for a user-defined function name, so this function name does not have to be used.

[Syntax]

```
#include "suo.h"
void NotifyTimerFunc (SuoHandle handle);
```

[Argument(s)]

Argument	Description
<i>handle</i>	Handle of the timer interface

[Return value]

None

[Description]

- NotifyTimerFunc describes the processing when the timer time is reported.
- Use the [SuoSetNotifyTimerCallback](#) function to register NotifyTimerFunc as a callback function.

InputDigitalPinFunc

Performs the digital pin input processing, as a callback function.

Caution `InputDigitalPinFunc` is a place holder for a user-defined function name, so this function name does not have to be used.

[Syntax]

```
#include "suo.h"
void InputDigitalPinFunc (SuoHandle handle, int pinValue);
```

[Argument(s)]

Argument	Description
<i>handle</i>	Handle of the pin interface
<i>pinValue</i>	Digital input value (specify any of the following) <ul style="list-style-type: none"> - SUO_HIGH (=1): HIGH value - SUO_LOW (=0): LOW value

[Return value]

None

[Description]

- `InputDigitalPinFunc` describes the digital pin input processing.
- Use the [SuoSetInputDigitalPinCallback](#) function to register `InputDigitalPinFunc` as a callback function.

InputAnalogPinFunc

Performs the analog pin input processing, as a callback function.

Caution InputAnalogPinFunc is a place holder for a user-defined function name, so this function name does not have to be used.

[Syntax]

```
#include "suo.h"
void InputAnalogPinFunc (SuoHandle handle, double pinValue);
```

[Argument(s)]

Argument	Description
<i>handle</i>	Handle of the pin interface
<i>pinValue</i>	Value (analog value) input to the pin (unit: V)

[Return value]

None

[Description]

- InputAnalogPinFunc describes the analog pin input processing.
- Use the [SuoSetInputAnalogPinCallback](#) function to register InputAnalogPinFunc as a callback function.

InputHighImpedanceFunc

Performs the processing when all the pins connected to digital/analog pins enter the high-impedance state, as a call-back function.

Caution InputHighImpedanceFunc is a place holder for a user-defined function name, so this function name does not have to be used.

[Syntax]

```
#include    "suo.h"
void      InputHighImpedanceFunc (SuoHandle handle);
```

[Argument(s)]

Argument	Description
<i>handle</i>	Handle of the pin interface

[Return value]

None

[Description]

- InputHighImpedanceFunc is used to describe the processing when all the pins connected to digital/analog pins enter the high-impedance state.
- Use the [SuoSetInputHighImpedanceCallback](#) function to register InputHighImpedanceFunc as a callback function.

ReadExtbusFunc

Performs the read access processing of an external bus, as a callback function.

Caution `ReadExtbusFunc` is a place holder for a user-defined function name, so this function name does not have to be used.

[Syntax]

```
#include "suo.h"
void ReadExtbusFunc (SuoHandle handle, unsigned long addr, int accessSize, unsigned char data[]);
```

[Argument(s)]

Argument	Description
<i>handle</i>	Handle of the external bus interface
<i>addr</i>	Address
<i>accessSize</i>	Access size
<i>data[]</i>	Data storage area As many data as the access size must be stored.

[Return value]

None

[Description]

- `ReadExtbusFunc` describes the read access processing of an external bus.
- Data must be stored in *data[]*.
- Use the [SuoSetReadExtbusCallback](#) function to register `ReadExtbusFunc` as a callback function.

WriteExtbusFunc

Performs the write access processing of an external bus, as a callback function.

Caution WriteExtbusFunc is a place holder for a user-defined function name, so this function name does not have to be used.

[Syntax]

```
#include "suo.h"

void WriteExtbusFunc (SuoHandle handle, unsigned long addr, int accessSize, const unsigned char data[]);
```

[Argument(s)]

Argument	Description
<i>handle</i>	Handle of the external bus interface
<i>addr</i>	Address
<i>accessSize</i>	Access size
<i>data[]</i>	Data storage area As many data as the access size must be stored.

[Return value]

None

[Description]

- WriteExtbusFunc describes the write access processing of an external bus.
- Use the [SuoSetWriteExtbusCallback](#) function to register WriteExtbusFunc as a callback function.

NotifySentSerialFunc

Performs the processing when transmission by a serial interface has been completed, as a callback function.

Caution `NotifySentSerialFunc` is a place holder for a user-defined function name, so this function name does not have to be used.

[Syntax]

```
#include "suo.h"
void NotifySentSerialFunc (SuoHandle handle);
```

[Argument(s)]

Argument	Description
<i>handle</i>	Handle of the serial interface

[Return value]

None

[Description]

- `NotifySentSerialFunc` describes the processing when transmission by a serial interface has been completed.
- Use the [SuoSetNotifySentSerialCallback](#) function to register `NotifySentSerialFunc` as a callback function.

ReceiveSerialFunc

Performs the processing during reception by a serial interface, as a callback function.

Caution ReceiveSerialFunc is a place holder for a user-defined function name, so this function name does not have to be used.

[Syntax]

```
#include "suo.h"
void ReceiveSerialFunc (SuoHandle handle, unsigned long data, int status);
```

[Argument(s)]

Argument	Description
<i>handle</i>	Handle of the serial interface
<i>data</i>	Received serial data
<i>status</i>	Receive status (specify any of the following) - 0 : Normal reception - SUO_PARITYERR : Parity error (if parity bit does not match) - SUO_FRAMINGERR : Framing error (if stop bit is not detected)

[Return value]

None

[Description]

- ReceiveSerialFunc describes the processing during reception by a serial interface.
- Use the [SuoSetReceiveSerialCallback](#) function to register ReceiveSerialFunc as a callback function.

NotifySentWaveFunc

Performs the processing to be performed when transmission by a signal output unit has been completed, as a callback function.

Caution `NotifySentWaveFunc` is a place holder for a user-defined function name, so this function name does not have to be used.

[Syntax]

```
#include "suo.h"
void NotifySentWaveFunc (SuoHandle handle);
```

[Argument(s)]

Argument	Description
<i>handle</i>	Handle of the signal output unit interface

[Return value]

None

[Description]

- `NotifySentWaveFunc` describes the processing to be performed when transmission by a signal output unit has been completed.
- Use the [SuoSetNotifySentWaveCallback](#) function to register `NotifySentWaveFunc` as a callback function.

B.6 Sample Program (Timer Model)

This section describes a sample program (timer model) of a user model created by using the Simulator GUI's user open interface.

B.6.1 Overview

Timer model is a sample program using a timer interface. It outputs a value to a pin at fixed time intervals.

B.6.2 Configuration

The timer model generates the PIN pin and TIM timer. The generated PIN pin is connected to the PDH pin of the CPU.

Figure B-5. Timer Model Configuration

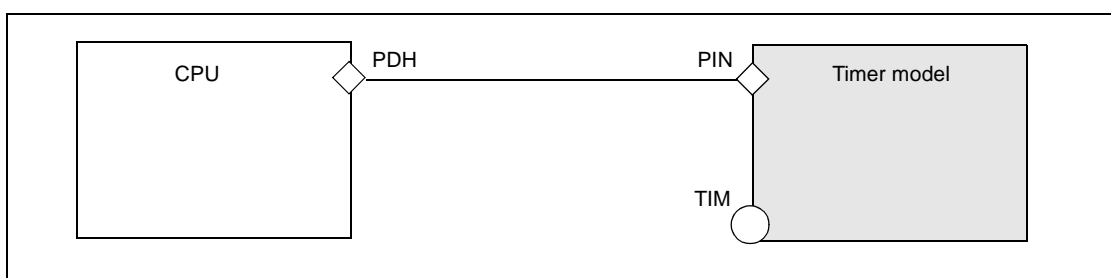

B.6.3 Operation

The timer model calculates a predetermined time by using the timer interface, and alternately outputs a low level and a high level to the PDH pin. The output value and output time are as shown below.

Figure B-6. Timer Model Operation

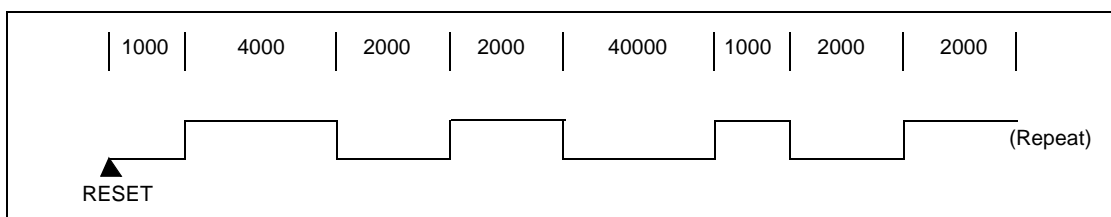

B.6.4 Project file

The following table shows the setting information of the Visual C++ project file of the Timer model.

Table B-6. Setting Information of Timer Model

Information	Description
Project type	Win32 Dynamic-Link Library
Source file	suolink.c, uo_timer.c
Path of include file	Folder storing suo.h

B.6.5 Details of program

The following shows the sample programs of the timer model.

- (1) Source file of timer model (uo_timer.c)
- (2) Simulator configuration file (smplus.cfg)
- (3) Source file of target program (lm_timer.c)

(1) Source file of timer model (uo_timer.c)

```

#include <windows.h>
#include "suo.h"

/* Handle */
SuoHandle hTIM;
SuoHandle hPIN;

/* Wave-Table */
#define MAXWAVE 8
struct _WaveTable {
    unsigned longtime;          /* Wait Time [usec] */
    int pinValue;              /* Pin Value (SUO_HIGH or SUO_LOW) */
} waveTable[MAXWAVE] = {
    1000, SUO_HIGH,
    4000, SUO_LOW,
    2000, SUO_HIGH,
    2000, SUO_LOW,
    4000, SUO_HIGH,
    1000, SUO_LOW,
    2000, SUO_HIGH,
    2000, SUO_LOW
};
int waveIndex;

/* Declare */
void Reset(void);
void NotifyTimer(SuoHandle handle);
void puterr(int error);

/* MakeUserModel */
void SuoUserEntry MakeUserModel(const char *option)
{
    int error;
    /* Create interface */
    if((error = SuoCreateTimer("TIM", &hTIM)) != SUO_NOERROR){
        puterr(error);
        return;
    }
}

```

```
if((error = SuoCreatePin("PIN", &hPIN)) != SUO_NOERROR){
    perror(error);
    return;
}

/* Set callback */
SuoSetResetCallback(Reset);
SuoSetNotifyTimerCallback(hTIM, NotifyTimer);
}

/* Reset callback */
void Reset(void)
{
    int error;

    /* Initialize Wave-Table index */
    waveIndex = 0;

    /* Output LOW(initial value) to PIN */
    if((error = SuoOutputDigitalPin(hPIN, SUO_LOW)) != SUO_NOERROR){
        perror(error);
        return;
    }

    /* Set wait time */
    if((error = SuoSetTimer(hTIM, SUO_USEC, waveTable[waveIndex].time)) != SUO_NOERROR){
        perror(error);
        return;
    }
}

/* NotifyTimer callback */
void NotifyTimer(SuoHandle handle)
{
    int error;

    /* Output value to PIN */
    if((error = SuoOutputDigitalPin(hPIN, waveTable[waveIndex].pinValue)) != SUO_NOERROR){
        perror(error);
        return;
    }

    /* Set next Wave-Table index */
    waveIndex++;
    if(waveIndex >= MAXWAVE){
        waveIndex = 0;
    }
}
```

```

/* Set wait time */
if((error = SuoSetTimer(hTIM, SUO_USEC, waveTable[waveIndex].time)) != SUO_NOERROR){
    puterr(error);
    return;
}
}

/* Report error */
void puterr(int error)
{
    char message[80];
    wprintf(message, "The user open interface error (0x%04x) occurred.", error);
    MessageBox(NULL, message, "ERROR", MB_OK|MB_ICONERROR);
}

```

(2) Simulator configuration file (smplus.cfg)

```

cpu = CPU('a');

#=====
# UO_TIMER description (CPU=uPD70F3261Y)
#=====

#---- Create UserOpen -----
uo_timer = Device("USEROPEN", "Release\uo_timer.dll");

#---- Pseudo Pin connection -----
wire_clock = Wire(1);
wire_clock += cpu.DebuggerPseudoPort("debugger_pseudo_pin_main_clkout");
wire_clock += uo_timer.Port("gui_pseudo_pin_clock_notice");
wire_reset = Wire(1);
wire_reset += cpu.DebuggerPseudoPort("debugger_pseudo_pin_reset_notice");
wire_reset += uo_timer.Port("gui_pseudo_pin_reset_notice");

#---- PIN connection -----
# UO_TIMER.PIN <--> CPU.PDH0
wire_PIN = Wire(1);
wire_PIN += uo_timer.Port("PIN");
wire_PIN += cpu.Port("PDH0");

```

(3) Source file of target program (Im_timer.c)

```
/* Target Program for UO_TIMER */

#pragma ioreg

void main( )
{
    unsigned char value;

    PMDH.0 = 1;          /* set port-input mode */
    PMDH.1 = 0;          /* set port-output mode */

    while( 1 ){
        value = PDH.0;   /* input signal from "PDH0" */
        PDH.1 = value;   /* output signal to "PDH1" */
    }
}
```

APPENDIX C INDEX

A

Access to variables ... 65
 Access width ... 249
 Action event ... 114, 238, 242, 243
 Action Events dialog box ... 256
 Address range ... 249
 Analog Button Properties dialog box ... 329
 Array ... 209, 215
 Auto variables ... 209

B

Basic interface functions ... 389
 SuoGetMainClock ... 392
 SuoSetInitCallback ... 390
 SuoSetResetCallback ... 391

Binary data format ... 45
 Break ... 32, 38
 Break cause ... 231
 Breakpoint ... 63
 Built-in event ... 95, 242, 243

C

Call stack information ... 225
 Call Stack panel ... 225
 Callback function ... 376
 Clock ... 19, 28, 35
 Code ... 191
 Code coverage ... 111
 Collect execution history of program ... 93
 Collect Execution History of the Program ... 93
 Clear the trace memory ... 100
 Collect execution history from the start to stop of the
 execution ... 95
 Collect execution history in the arbitrary section
 ... 95
 Collect execution history when the condition is met
 ... 97
 Configure the trace operation ... 93

Display collected execution history ... 98
 Save the contents of execution history ... 105
 Search the trace data ... 100

Configuration ... 36
 Configure the trace operation ... 93
 Connect to/disconnect from debug tool ... 40
 Control register ... 79, 197
 Coverage Measurement ... 111
 Configure the coverage measurement ... 111
 Display the coverage measurement result ... 112
 CPU Register panel ... 197
 Current PC mark ... 175, 190
 Current PC position ... 175, 190
 Customize dialog box ... 297

D

Data coverage ... 111
 Data Save dialog box ... 273
 DDM function ... 73, 90
 Debug information ... 168
 Debug toolbar ... 133
 Debug-dedicated project ... 41
 Delete breakpoint ... 65
 Disassemble display mode ... 99, 231
 Disassemble panel ... 188
 Disassembled text ... 53, 188
 Display and change programs ... 49
 Display the result of disassembling ... 53
 Perform line assembly ... 57
 Display format of watch-expression ... 218
 Display information on function call from stack ... 91
 Display call stack information ... 91
 Save the contents of call stack information ... 92
 Display and change programs
 Display and change programs ... 49
 Display the result of disassembling. ... 53
 Display/change the memory, register and variable ... 71

- Display/change global variables/static variables ... 83
- Display/change local variables ... 83
- Display/change the CPU register ... 79
- Display/change the memory ... 71
- Display/change the SFR ... 81
- Display/change watch-expression ... 85
- Download ... 26, 41, 167
- Download condition ... 45, 252
- Download Files dialog box ... 252
- E**
- Editor panel ... 172
- Event area ... 174, 190
- Event mark ... 237
- Event type ... 238
- Events panel ... 235
- Execute programs ... 59
 - Execute programs ... 59
 - Execute programs in steps ... 61
 - Reset microcontroller (CPU) ... 59
- External bus interface functions ... 409
 - SuoCreateExtbus ... 410
 - SuoGetExtbusHandle ... 412
 - SuoSetReadExtbusCallback ... 413
 - SuoSetWriteExtbusCallback ... 414
- F**
- Fail-safe break function ... 23, 68
- Features ... 11
- File monitor ... 176
- Flash ... 29
- Flash macro service ... 160
- Flash self programming emulation function ... 24, 160
- Font ... 278
- Format (CSI) dialog box ... 371
- Format (UART) dialog box ... 369
- G**
- General-purpose register ... 79, 197
- Global variable ... 83
- Go to Here ... 60
- Go to the Location dialog box ... 272
- H**
- Hardware Break ... 63, 237, 238
- Hex format ... 45
- Hook transaction ... 170
- How to connect to debug tool ... 40
- How to disconnect from debug tool ... 40
- I**
- I/O Panel window ... 316
- I/O protection area ... 248
- InitFunc ... 445
- Initial value ... 260
- Input format of watch-expression ... 216
- InputAnalogPinFunc ... 449
- InputDigitalPinFunc ... 448
- InputHighImpedanceFunc ... 450
- Instruction level debugging ... 49
- Interface functions ... 387
 - Basic interface functions ... 389
 - External bus interface functions ... 409
 - Pin interface functions ... 400
 - Serial interface functions ... 416
 - Signal output unit interface functions ... 435
 - Time interface functions ... 393
- Internal Static variables ... 209
- L**
- Label ... 230
- Label name ... 191
- Line assembly ... 57, 192
- Load module file ... 41
- Local variable ... 83
- Local Variables panel ... 208
- Loop dialog box ... 306
- M**
- Macro service error ... 24
- Main clock source ... 144
- Main window ... 130
- MakeUserModel ... 443

- Manage events ... 116
 - Change the setting state of the event ... 116
 - Delete the set events ... 117, 118
 - Display only particular event types ... 117
 - Event types that can be set and deleted during execution ... 119
 - Jump to the event address ... 117
 - Maximum number of enabled events ... 118
- Mask for input signal ... 24, 33
- Maximum number of enabled events ... 118
- Measure Execution Time of the Program ... 107
 - Measurable time ranges ... 110
 - Measure execution time from the start to stop of the execution ... 107
 - Measure execution time in the arbitrary section ... 108
- Measurement of the execution time of the program ... 107
- Memory access ... 22, 31, 38
- Memory Initialize dialog box ... 260
- Memory mapping ... 21, 30, 37, 248
- Memory Mapping dialog box ... 247
- Memory Search dialog box ... 262
- Memory settings ... 21, 37
- Memory type ... 248
- Menubar ... 131
- Mixed display mode ... 99, 231
- Move to ... 51
- Move to the specified address ... 54
- Move to the symbol defined location ... 55
- N**
- NotifySentSerialFunc ... 453
- NotifySentWaveFunc ... 455
- NotifyTimerFunc ... 447
- O**
- Offset value ... 191, 230
- Operating environment ... 17
- Option dialog box ... 276
 - [General - Build/Debug] category ... 283
 - [General - Font and Color] category ... 278
- Output panel ... 244
- P**
- Parts Button Properties dialog box ... 325
- Parts Buzzer Properties dialog box ... 353
- Parts Key Properties dialog box ... 333
- Parts Led Properties dialog box ... 342
- Parts Level Gauge Properties dialog box ... 338
- Parts List dialog box ... 363
- Parts Matrix Led Properties dialog box ... 349
- Parts Segment LED Properties dialog box ... 345
- Pin interface functions ... 400
 - SuoCreatePin ... 401
 - SuoGetPinHandle ... 402
 - SuoOutputAnalogPin ... 404
 - SuoOutputDigitalPin ... 403
 - SuoOutputHighImpedance ... 405
 - SuoSetInputAnalogPinCallback ... 407
 - SuoSetInputDigitalPinCallback ... 406
 - SuoSetInputHighImpedanceCallback ... 408
- Point Trace ... 238
- Point Trace event ... 97
- Pointer type variable ... 215
- Pointer variables ... 209
- Pop-up display of variables ... 176
- Power off emulation function ... 32, 156
- Printf ... 237, 238
- Printf event ... 114, 256
- Progress Status dialog box ... 275
- Project Tree panel ... 137
- Property panel ... 139
 - [Connect Settings] tab ... 142
 - [Debug Tool Settings] tab ... 149
 - [Download File Settings] tab ... 167
 - [Flash Self Emulation Eettings] tab ... 160
 - [Hook Transaction Settings] tab ... 170
- Pull up/Pull down dialog box ... 357
- R**
- Rapid build function ... 57

- ReadExtbusFunc ... 451
- Read-protected object ... 204
- Real-time display update function ... 73
- ReceiveSerialFunc ... 454
- Register bank ... 199
- Register variables ... 209
- Registering a watch-expression ... 213
- Registering watch-expression ... 86
- Reset ... 59
- ResetFunc ... 446
- Return out execution ... 62, 133, 134
- RRM function ... 90
- Run-Break time ... 107
- Run-Break Timer ... 237, 238
- Run-Break Timer event ... 107

- S**
- Sample program ... 456
- Save As dialog box ... 287
- Save Settings dialog box ... 258
- Scope specification ... 83
- Search Data dialog box ... 314
- Security flag emulation ... 25, 166
- Security ID ... 147
- Select Data Save File dialog box ... 289
- Select Download File dialog box ... 285
- Select Pin dialog box ... 307
- Select Simulator Configuration File dialog box. ... 291
- Serial interface functions ... 416
 - SSuoCreateSerialCSI ... 419
 - SuoCreateSerialUART ... 417
 - SuoGetSerialHandle ... 421
 - SuoGetSerialParameterCSI ... 428
 - SuoGetSerialParameterUART ... 427
 - SuoSendSerialData ... 429
 - SuoSendSerialDataList ... 430
 - SuoSendSerialFile ... 431
 - SuoSetNotifySentSerialCallback ... 432
 - SuoSetReceiveSerialCallback ... 434
 - SuoSetSerialParameterCSI ... 424
 - SuoSetSerialParameterUART ... 422
- Serial transmission data file ... 365
- Serial window ... 365
- Set action into the program ... 114
 - Inset printf ... 114
- Set PC to Here ... 61
- Settable mapping attribute ... 249
- Setting state of the event ... 116
- SFR panel ... 202
- Signal Data Editor window ... 299
- Signal data file ... 299
- Signal output unit interface functions ... 435
 - SuoCreateWave ... 436
 - SuoGetWaveHandle ... 438
 - SuoSendWaveFile ... 439
 - SuoSetNotifySentWaveCallback ... 440
- Simulator GUI window ... 293
- Software Break ... 63, 237, 238
- Source display mode ... 99, 231
- Start Timer ... 237
- Start Timer event ... 108, 238
- Start Tracing ... 237
- Start Tracing event ... 95, 238
- Statusbar ... 134
- Step execution ... 61
- Step in execution ... 61, 132, 134
- Step over execution ... 62, 132, 134
- Stop program ... 63
 - Access to variables ... 65
 - Manually stop the execution ... 63
 - Stop at the arbitrary position ... 63
- Stop Timer ... 237
- Stop Timer event ... 108, 238
- Stop Tracing ... 237
- Stop Tracing event ... 95, 238
- Structure ... 209, 215
- Sub clock ... 145
- Summary ... 11
- SuoCreateExtbus ... 410
- SuoCreatePin ... 401
- SuoCreateSerialCSI ... 419
- SuoCreateSerialUART ... 417

SuoCreateTimer ... 394
 SuoCreateWave ... 436
 SuoGetExtbusHandle ... 412
 SuoGetMainClock ... 392
 SuoGetPinHandle ... 402
 SuoGetSerialHandle ... 421
 SuoGetSerialParameterCSI ... 428
 SuoGetSerialParameterUART ... 427
 SuoGetTimerHandle ... 395
 SuoGetWaveHandle ... 438
 SuoKillTimer ... 398
 SuoOutputAnalogPin ... 404
 SuoOutputDigitalPin ... 403
 SuoOutputHighImpedance ... 405
 SuoSendSerialData ... 429
 SuoSendSerialDataList ... 430
 SuoSendSerialFile ... 431
 SuoSendWaveFile ... 439
 SuoSetInitCallback ... 390
 SuoSetInputAnalogPinCallback ... 407
 SuoSetInputDigitalPinCallback ... 406
 SuoSetInputHighImpedanceCallback ... 408
 SuoSetNotifySentSerialCallback ... 432
 SuoSetNotifySentWaveCallback ... 440
 SuoSetNotifyTimerCallback ... 399
 SuoSetReadExtbusCallback ... 413
 SuoSetReceiveSerialCallback ... 434
 SuoSetResetCallback ... 391
 SuoSetSerialParameterCSI ... 424
 SuoSetSerialParameterUART ... 422
 SuoSetTimer ... 396
 SuoSetWriteExtbusCallback ... 414

T

Tag jump ... 52, 175, 245
 Target board ... 20
 Target range for the RRM function ... 74
 Targets that can be registered as watch-expressions
 ... 86
 Text Edit dialog box ... 255
 Time interface functions ... 393

SuoCreateTimer ... 394
 SuoGetTimerHandle ... 395
 SuoKillTimer ... 398
 SuoSetNotifyTimerCallback ... 399
 SuoSetTimer ... 396

Timer ... 38
 Timer Result ... 237, 238
 Timer Result event ... 108
 Timing chart file ... 309
 Timing Chart window ... 309
 Trace event ... 95
 Trace frame ... 95
 Trace memory ... 156, 93
 Trace number ... 230
 Trace panel ... 229
 Trace Search dialog box ... 264
 Type of breakpoint ... 153

U

Unconditional Trace ... 238
 Unconditional Trace event ... 95, 117
 Union ... 209, 215
 Upload ... 41, 47, 48
 Use hook function ... 120
 User model ... 378
 User open interface ... 375
 User-defined functions ... 442

- InitFunc ... 445
- InputAnalogPinFunc ... 449
- InputDigitalPinFunc ... 448
- InputHighImpedanceFunc ... 450
- MakeUserModel ... 443
- NotifySentSerialFunc ... 453
- NotifySentWaveFunc ... 455
- NotifyTimerFunc ... 447
- ReadExtbusFunc ... 451
- ReceiveSerialFunc ... 454
- ResetFunc ... 446
- WriteExtbusFunc ... 452

V

Verify ... 151

W

Watch panel ... 213

Watch-expression ... 85, 213

Window reference ... 128

WriteExtbusFunc ... 452

Revision Record

Rev.	Date	Description	
		Page	Summary
1.00	Oct 01, 2010	-	First Edition issued

CubeSuite Ver.1.40 User's Manual: 78K0 Debug

Publication Date: Rev.1.00 Oct 1, 2010

Published by: Renesas Electronics Corporation

**SALES OFFICES****Renesas Electronics Corporation**<http://www.renesas.com>Refer to "<http://www.renesas.com/>" for the latest and detailed information.**Renesas Electronics America Inc.**2880 Scott Boulevard Santa Clara, CA 95050-2554, U.S.A.
Tel: +1-408-588-6000, Fax: +1-408-588-6130**Renesas Electronics Canada Limited**1101 Nicholson Road, Newmarket, Ontario L3Y 9C3, Canada
Tel: +1-905-898-5441, Fax: +1-905-898-3220**Renesas Electronics Europe Limited**Dukes Meadow, Millboard Road, Bourne End, Buckinghamshire, SL8 5FH, U.K
Tel: +44-1628-585-100, Fax: +44-1628-585-900**Renesas Electronics Europe GmbH**Arcadiastrasse 10, 40472 Düsseldorf, Germany
Tel: +49-211-65030, Fax: +49-211-6503-1327**Renesas Electronics (China) Co., Ltd.**7th Floor, Quantum Plaza, No.27 ZhiChunLu Haidian District, Beijing 100083, P.R.China
Tel: +86-10-8235-1155, Fax: +86-10-8235-7679**Renesas Electronics (Shanghai) Co., Ltd.**Unit 204, 205, AZIA Center, No.1233 Lujiazui Ring Rd., Pudong District, Shanghai 200120, China
Tel: +86-21-5877-1818, Fax: +86-21-6887-7858 / -7898**Renesas Electronics Hong Kong Limited**Unit 1601-1613, 16/F., Tower 2, Grand Century Place, 193 Prince Edward Road West, Mongkok, Kowloon, Hong Kong
Tel: +852-2886-9318, Fax: +852 2886-9022/9044**Renesas Electronics Taiwan Co., Ltd.**7F, No. 363 Fu Shing North Road Taipei, Taiwan
Tel: +886-2-8175-9600, Fax: +886 2-8175-9670**Renesas Electronics Singapore Pte. Ltd.**1 HarbourFront Avenue, #06-10, Keppel Bay Tower, Singapore 098632
Tel: +65-6213-0200, Fax: +65-6278-8001**Renesas Electronics Malaysia Sdn.Bhd.**Unit 906, Block B, Menara Amcorp, Amcorp Trade Centre, No. 18, Jln Persiaran Barat, 46050 Petaling Jaya, Selangor Darul Ehsan, Malaysia
Tel: +60-3-7955-9390, Fax: +60-3-7955-9510**Renesas Electronics Korea Co., Ltd.**11F., Samik Lavied' or Bldg., 720-2 Yeoksam-Dong, Kangnam-Ku, Seoul 135-080, Korea
Tel: +82-2-558-3737, Fax: +82-2-558-5141

CubeSuite Ver.1.40



Renesas Electronics Corporation

R20UT0262EJ0100