

ISL9440CEVAL1Z

Triple PWM Step-Down Synchronous Buck Controller and One LDO

AN1482  
Rev 0.00  
June 30, 2009

The ISL9440CEVAL1Z evaluation board features the ISL9440C. The ISL9440C is quad-output controller that integrates three PWM synchronous buck controllers and one low-dropout linear regulator controller. The ISL9440C offers programmable soft-start, independent enable functions and integrates OV/OC/OT protection. The current mode control architecture and internal compensation network keep peripheral component counts minimized. 600kHz switching frequency can minimize inductor size while the strong gate driver is able to deliver 12A to each PWM channel.

Table 1 shows the difference in terms of ISL944xx family features.

TABLE 1. FEATURES OF ISL944xx FAMILY

PART NUMBER	EARLY WARNING	SWITCHING FREQUENCY (kHz)	SOFT-STARTING TIME (ms)
ISL9440	YES	300	1.7
ISL9440A	YES	600	1.7
ISL9441	NO	300	1.7
ISL9440B	YES	300	PROGRAMMABLE
ISL9440C	YES	600	PROGRAMMABLE

The ISL9440CEVAL1Z is easy to set up to evaluate the performance of the ISL9440C. Please refer to the “Electrical Specifications” for typical performance summary.

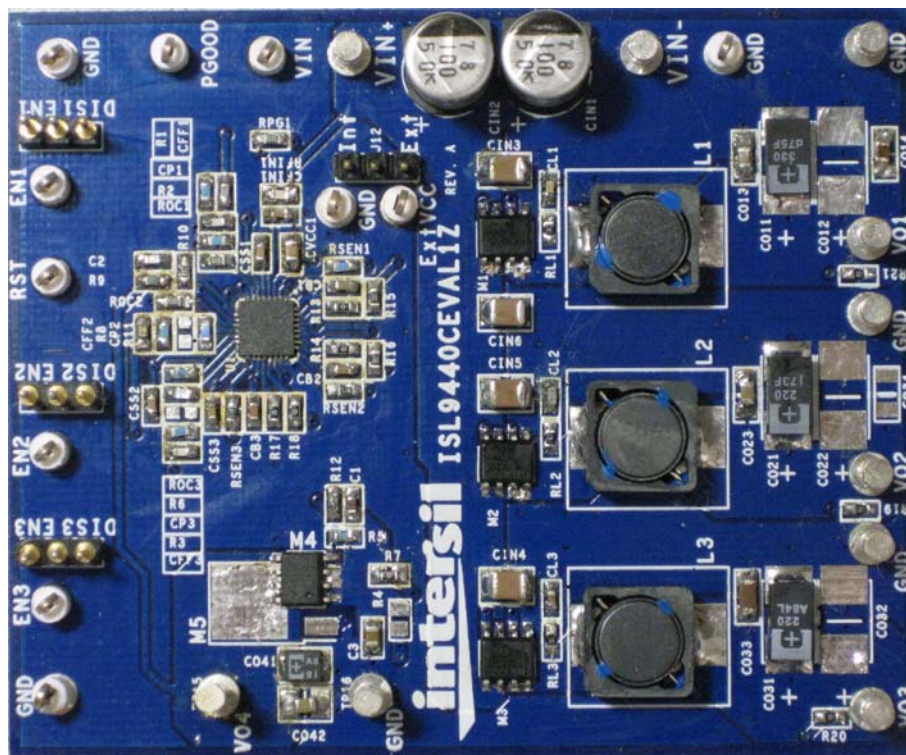

FIGURE 1. ISL9440CEVAL1Z EVALUATION BOARD

## Electrical Specifications

Recommended operation conditions unless otherwise noted. Refer to schematic and typical performance curves.

PARAMETER	TEST CONDITIONS	MIN	TYP	MAX	UNITS
$V_{IN}$	All outputs are in regulation	6.0	12	16	V
$V_{OUT1}$		0.97	1.00	1.03	V
$V_{OUT2}$		3.25	3.32	3.4	V
$V_{OUT3}$		4.85	5.0	5.15	V
$V_{OUT4}$		2.43	2.50	2.57	V
PWM1 Rated Current	$V_{IN} = 12V$ , $T_A = +25^\circ C$ , No forced airflow, All three PWM outputs are fully loaded		6	7	A
PWM2 Rated Current			6	7	A
PWM3 Rated Current			4	5	A
LDO Rated Current	$R7 = 0\Omega$ , $R4$ is not populated		0.8	1.0	A
$V_{OUT1}$ Peak-to-Peak Ripple	$V_{IN} = 12V$ , All three PWM outputs are fully loaded, Oscilloscope is with full bandwidth		19.8		mV <sub>P-P</sub>
$V_{OUT2}$ Peak-to-Peak Ripple			59.6		mV <sub>P-P</sub>
$V_{OUT3}$ Peak-to-Peak Ripple			66.5		mV <sub>P-P</sub>

### What's Inside

The Evaluation Board Kit contains the following materials:

- The ISL9440CEVAL1Z
- The ISL9440B, ISL9440C datasheet
- This EVAL KIT document

### Recommended Equipment

The following materials are recommended to perform testing:

- 0V to 20V Power Supply with at least 10A Source Current Capability
- Three Electronic Loads Capable of Sinking Current up to 7A
- Digital Multimeters (DMMs)
- 100MHz Quad-Trace Oscilloscope
- Signal Generator (for load transient tests)

### Quick Test Guide

1. Ensure that the circuit is correctly connected to the supply and electronic loads prior to applying any power. Please refer to Figure 2 for proper set-up.
2. Connect Jumpers J3, J4 and J5 in the ENx positions.
3. Turn on the power supply
4. Adjust input voltage  $V_{IN}$  within the specified range and observe output voltage. The output voltage variation should be within 3%.
5. Adjust load current within the specified range and observe output voltage. The output voltage variation should be within 3%.
6. Use oscilloscope to observe output voltage ripple and Phase node ringing. For accurate measurement, refer to Figure 3 for proper test set-up.

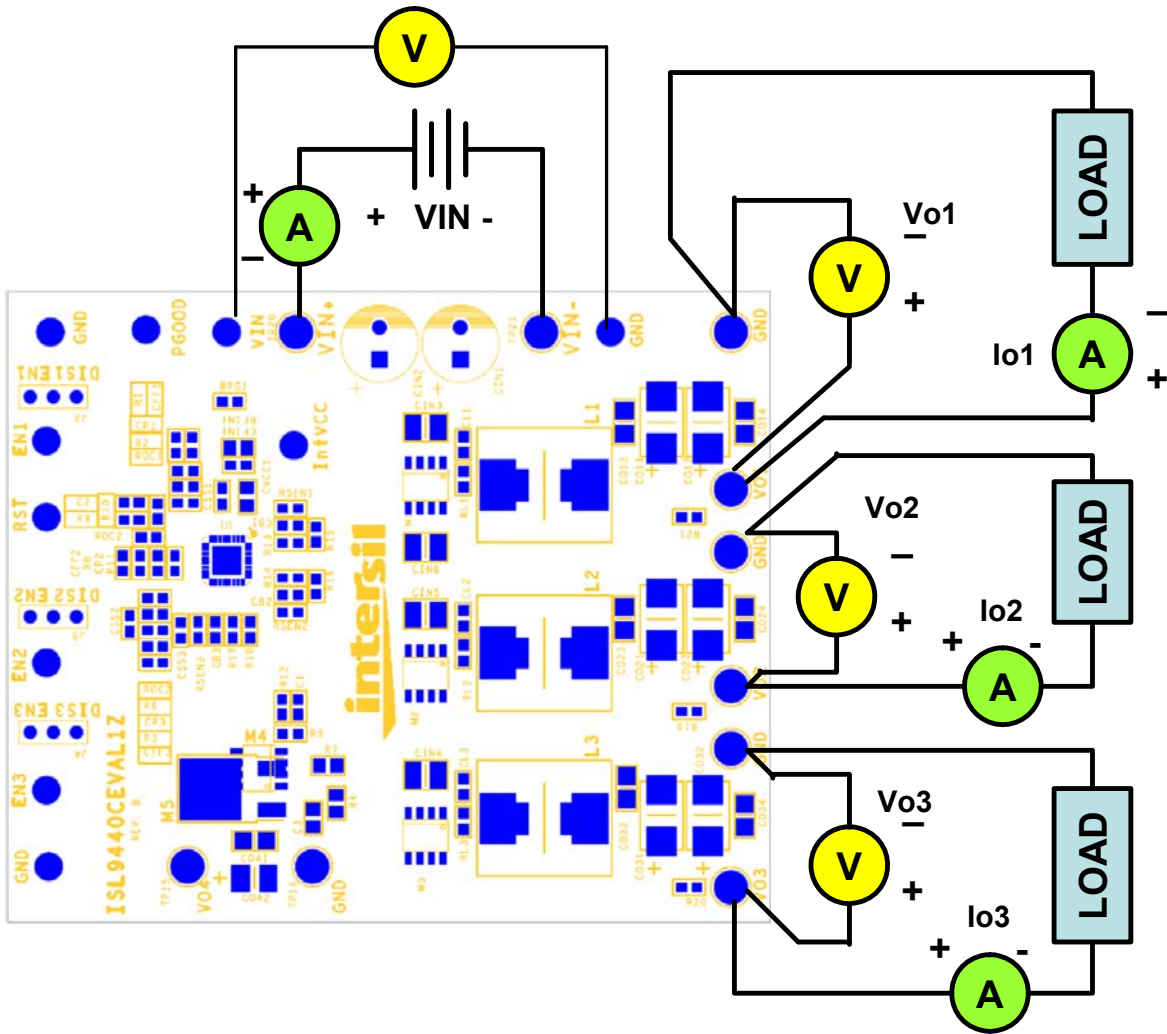

FIGURE 2. PROPER TEST SET-UP

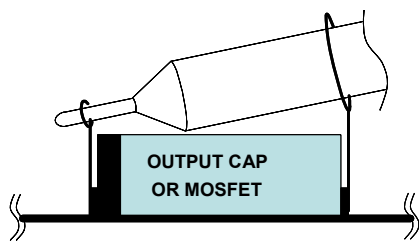

FIGURE 3. PROPER PROBE SET-UP TO MEASURE OUTPUT RIPPLE AND PHASE NODE RINGING

### Load Transient Circuit Set-up

1. Select a SOIC8 N-Channel MOSFET with  $V_{DS}$  breakdown > 20V.
2. Install the load transient circuit as indicated on the schematic. Refer to Figure 4 for detail.
3. R27, R22 and R25 are 10k $\Omega$  resistors for discharging the MOSFET gates.
4. R26, R23 and R24 are current sensing resistors to monitor the load step. For accurate measurement, please use 5% tolerance sensing resistor or better. To alleviate thermal stress, use 0.1 $\Omega$  or smaller resistance. The resistance of the sensing resistors sets the current scale on the oscilloscope.
5. Apply pulse square waveform across R27, R22 or R25. The duty cycle of the pulse waveform should be small (<5%) to limit thermal stress on current sensing resistor and the MOSFETs (M8, M6 or M7)
6. The amplitude of the clock sets the current step amplitude. Adjust the clock amplitude and slew rate to set the current step and slew rate.
7. Monitor overshoot and undershoot at corresponding output.

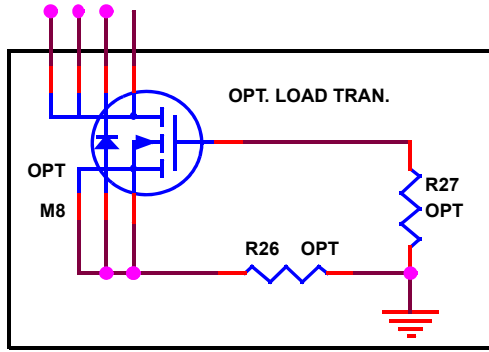

FIGURE 4. LOAD TRANSIENT CIRCUIT FOR PWM1

**Typical Evaluation Board Performance Curves**  $V_{IN} = 12V$ , Unless Otherwise Noted.

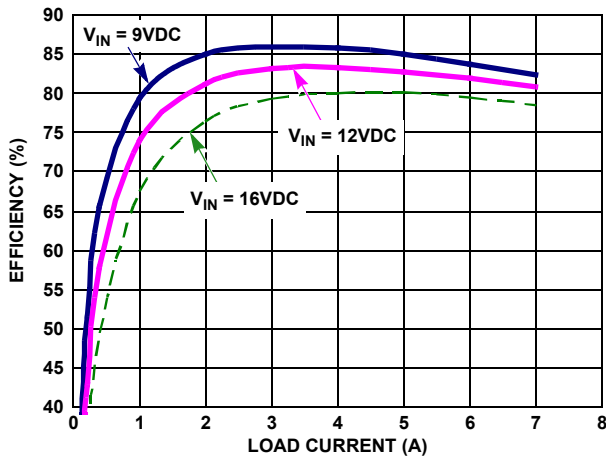

FIGURE 5. PWM1 EFFICIENCY vs LOAD ( $V_O = 1.0V$ )

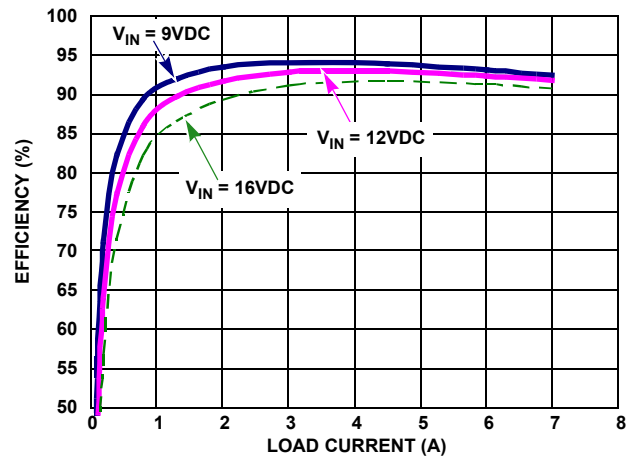

FIGURE 6. PWM2 EFFICIENCY vs LOAD ( $V_O = 3.3V$ )

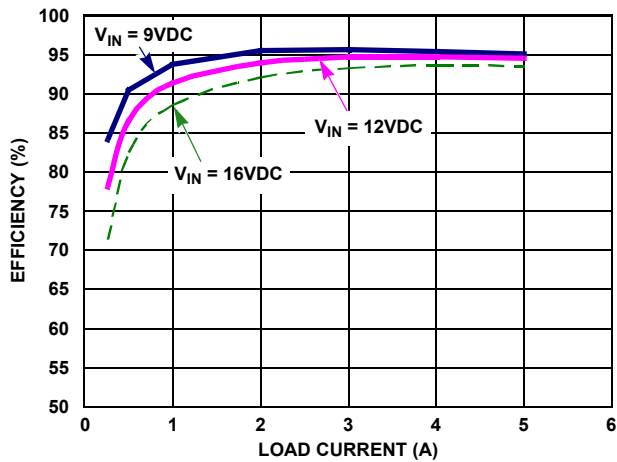

FIGURE 7. PWM3 EFFICIENCY vs LOAD ( $V_O = 5.0V$ )

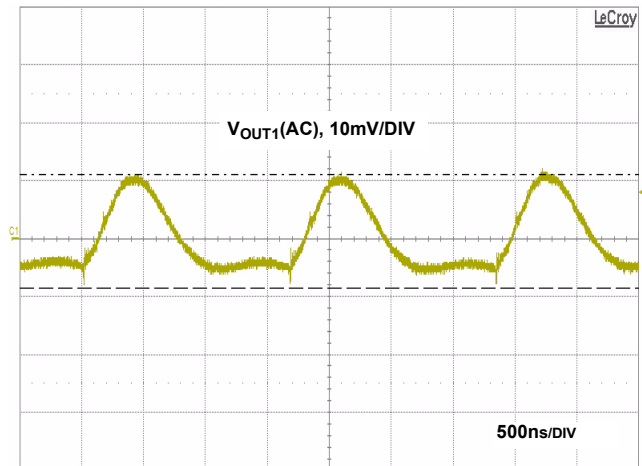
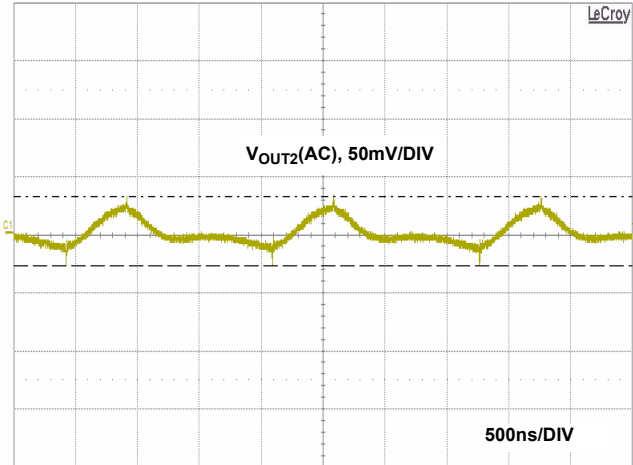

FIGURE 8. PWM1 OUTPUT RIPPLE UNDER MAX LOAD ( $V_{IN} = 12V$ ,  $I_{O1} = I_{O2} = 6A$ ,  $I_{O3} = 4A$ , FULL BANDWIDTH)

**Typical Evaluation Board Performance Curves**

$V_{IN} = 12V$ , Unless Otherwise Noted. (Continued)



**FIGURE 9. PWM2 OUTPUT RIPPLE UNDER MAX LOAD**  
 $(V_{IN} = 12V, I_{O1} = I_{O2} = 6A, I_{O3} = 4A, \text{FULL BANDWIDTH})$

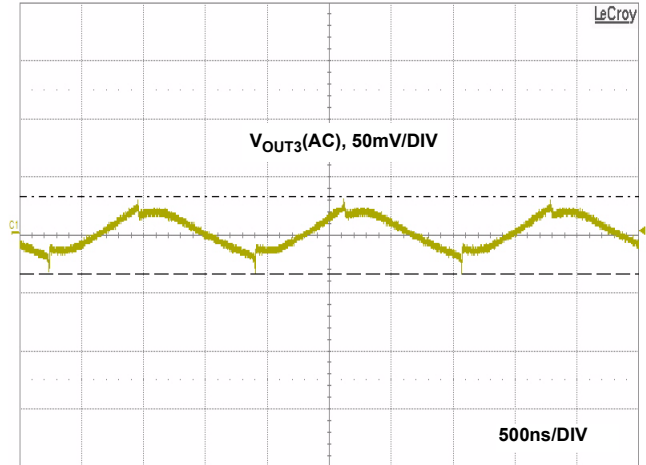

**FIGURE 10. PWM3 OUTPUT RIPPLE UNDER MAX LOAD**  
 $(V_{IN} = 12V, I_{O1} = I_{O2} = 6A, I_{O3} = 4A, \text{FULL BANDWIDTH})$

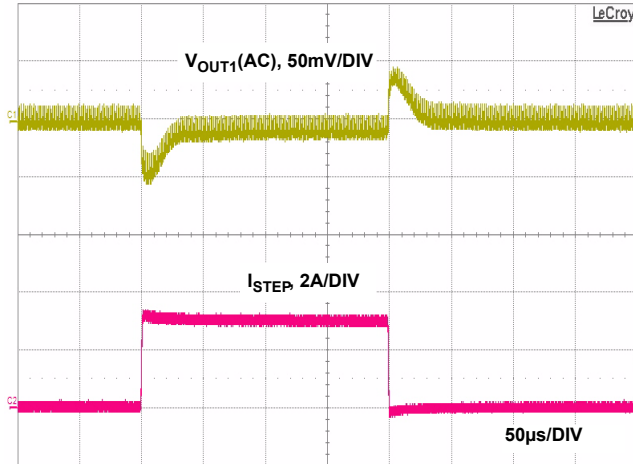

**FIGURE 11. PWM1 LOAD TRANSIENT RESPONSE**  
 (LOAD STEP FROM 1.5A TO 4.5A)

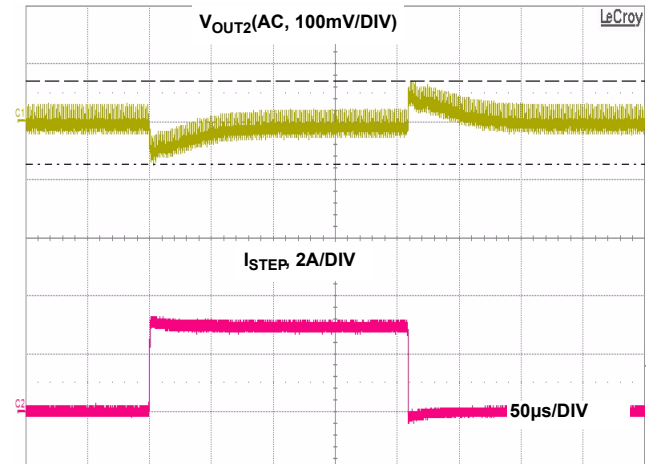

**FIGURE 12. PWM2 LOAD TRANSIENT RESPONSE**  
 (LOAD STEP FROM 1.5A TO 4.5A)

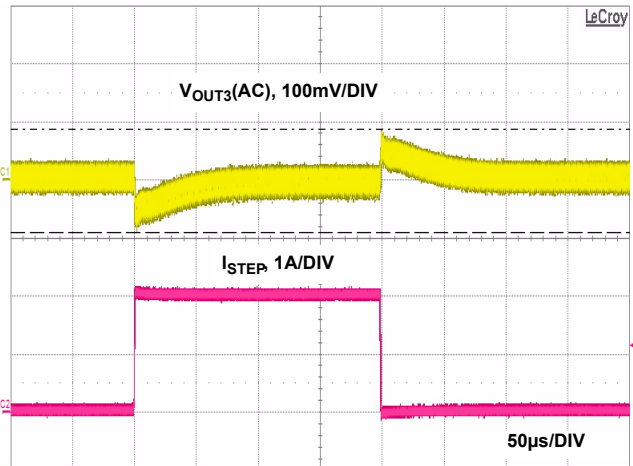

**FIGURE 13. PWM3 LOAD TRANSIENT RESPONSE**  
 (LOAD STEP FROM 1A TO 3A)

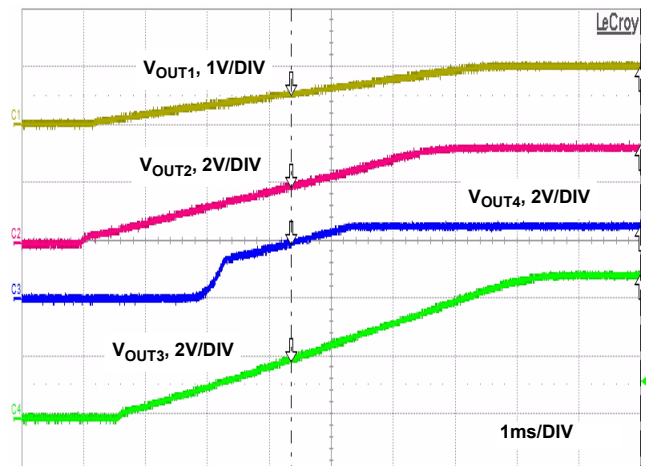

**FIGURE 14. SOFT START WAVEFORMS**



# Schematic

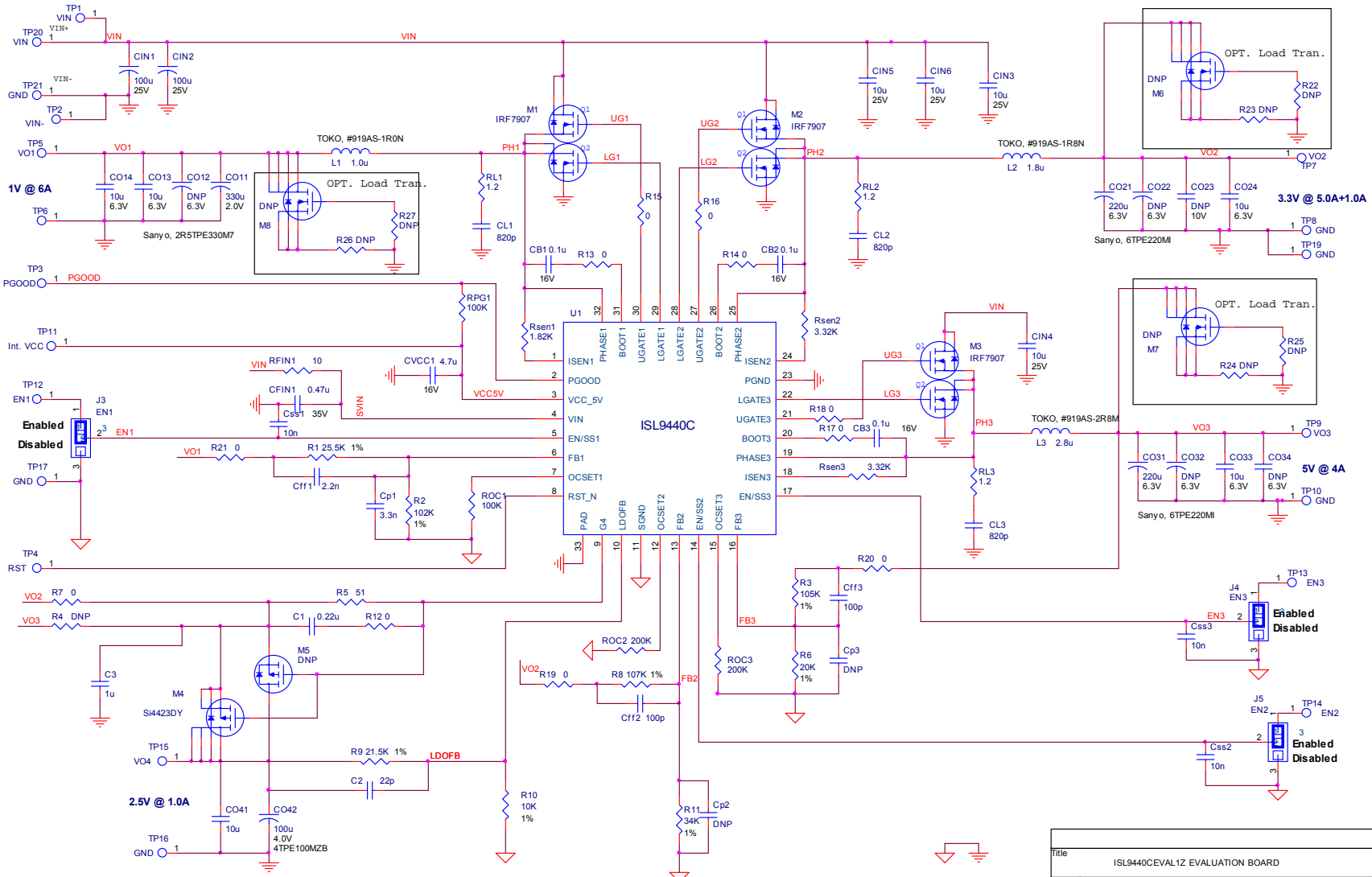

Title		
ISL9440CEVAL1Z EVALUATION BOARD		
Size	Document Number	Rev
	<Doc>	B
Date:	Monday, May 11, 2009	Sheet 1 of 1

TABLE 2. BILL OF MATERIALS

ESSENTIAL COMPONENTS						
ITEM	QTY	PART REFERENCE	VALUE	DESCRIPTION	PART #	MANUFACTURER
1	3	CB1, CB2, CB3	0.1 $\mu$ F	CAP Ceramic X5R, 16V, SMD, 0603,		Generic
2	1	CFIN1	0.47 $\mu$ F	CAP Ceramic X5R, 25V, SMD, 0603,		Generic
3	2	CIN1, CIN2	100 $\mu$ F	Alum. Elec. CAP 25V		Panasonic
4	4	CIN3, CIN4, CIN5, CIN6	10 $\mu$ F	CAP Ceramic X5R, 25V, SMD, 1206,		Generic
5	3	CL1, CL2, CL3	820pF	CAP Ceramic X5R, 16V, SMD, 0603,		Generic
6	1	CO11	330 $\mu$ F	POSCAP, 2.0V, SMD, D2E	2R5TPE330M7	Sanyo
7	5	CO13, CO14, CO24, CO33, CO41	10 $\mu$ F	CAP Ceramic X5R, 6.3V, SMD, 0805		Generic
8	2	CO21, CO31	220 $\mu$ F	POSCAP, 6.3V, SMD, D2E	6TPE220MI	Sanyo
9	1	CO42	100 $\mu$ F	POSCAP, 4.0V, SMD, B	4TPE100MZB	Sanyo
10	1	CVCC1	4.7 $\mu$ F	CAP Ceramic X5R, 16V, SMD, 0805,		Generic
11	1	Cff1	2.2nF	CAP Ceramic, SMD, 0603,		Generic
12	2	Cff2, Cff3	100pF	CAP Ceramic, SMD, 0603,		Generic
13	1	Cp1	3.3nF	CAP Ceramic, SMD, 0603,		Generic
14	3	Css1, Css2, Css3	10nF	CAP Ceramic, SMD, 0603,		Generic
15	1	C1	0.22 $\mu$ F	CAP Ceramic X5R, 16V, SMD, 0603,		Generic
16	1	C2	22pF	CAP Ceramic, SMD, 0603,		Generic
17	1	C3	1 $\mu$ F	CAP Ceramic, 6.3V,SMD, 0603,		Generic
18	1	L1	1.0 $\mu$ H	SHIELDED INDUCTOR	#919AS-1R0N	TOKO
19	1	L2	1.8 $\mu$ H	SHIELDED INDUCTOR	#919AS-1R8N	TOKO
20	1	L3	2.8 $\mu$ H	SHIELDED INDUCTOR	#919AS-2R8M	TOKO
21	3	M1, M2, M3		Dual N MOSFET, 30V , SOIC8	IRF7907	International Rectifier
22	1	M4		P MOSFET, SOIC8	Si4423DY	Vishay
23	1	R <sub>FIN1</sub>	10 $\Omega$	RESISTOR, SMD, 0805, 10%		Generic
24	3	RL1, RL2, RL3	1.2 $\Omega$	RESISTOR, SMD, 0603, 10%		Generic
25	2	RPG1, ROC1	100k $\Omega$	RESISTOR, SMD, 0603,1%		Generic
26	2	ROC2, ROC3	200k $\Omega$	RESISTOR, SMD, 0603,1%		Generic
27	1	R <sub>SEN1</sub>	1.82k $\Omega$	RESISTOR, SMD, 0603,1%		Generic
28	2	R <sub>SEN2</sub> , R <sub>SEN3</sub>	3.32k $\Omega$	RESISTOR, SMD, 0603,1%		Generic
29	1	R1	25.5k $\Omega$	RESISTOR, SMD, 0603,1%		Generic
30	1	R2	102k $\Omega$	RESISTOR, SMD, 0603,1%		Generic
31	1	R3	105k $\Omega$	RESISTOR, SMD, 0603,1%		Generic
32	1	R5	51 $\Omega$	RESISTOR, SMD, 0603,1%		Generic
33	1	R6	20k $\Omega$	RESISTOR, SMD, 0603,1%		Generic
34	1	R8	107k $\Omega$	RESISTOR, SMD, 0603,1%		Generic
35	1	R9	21.5k $\Omega$	RESISTOR, SMD, 0603,1%		Generic
36	1	R10	10k $\Omega$	RESISTOR, SMD, 0603,1%		Generic
37	1	R11	34k $\Omega$	RESISTOR, SMD, 0603,1%		Generic
38	1	U1	-	QUAD OUTPUT CONTROLLER	ISL9440C	Intersil

TABLE 2. BILL OF MATERIALS (Continued)

OPTIONAL COMPONENTS OR RESISTOR JUMPERS						
ITEM	QTY	REFERENCE	VALUE	DESCRIPTION	PART #	MANUFACTURER
39	10	R7, R12, R13, R14, R15, R16, R17, R18, R19, R20, R21	0	RESISTOR Jumpers, SMD, 0603, 10%		Generic
40	3	CO12, CO22, CO32	DNP			
41	2	CO23, CO34	DNP			
42	2	Cp2, Cp3	DNP			
43	1	M5	DNP	P MOSFET TO-252		
44	3	M6, M7, M8	DNP	N MOSFET		
45	4	R4, R22, R25, R27	DNP	RESISTOR, SMD, 0603		
46	3	R23, R24, R26	DNP	RESISTOR, SMD, 1206		
EVALUATION BOARD HARDWARES						
ITEM	QTY	REFERENCE	VALUE	DESCRIPTION	PART #	MANUFACTURER
47	3	J3, J4, J5	-	3 Head Jumper	68000-236HLF	Generic
48	11	TP1, TP2, TP3, TP4, TP6, TP17, TP11, TP12, TP13, TP14, TP7	-	TEST POINT	5007	Keystone
49	9	TP8, TP10, TP16, TP19, TP21, TP9, TP5, TP15, TP20	GND	TURRET	1514-2	Keystone



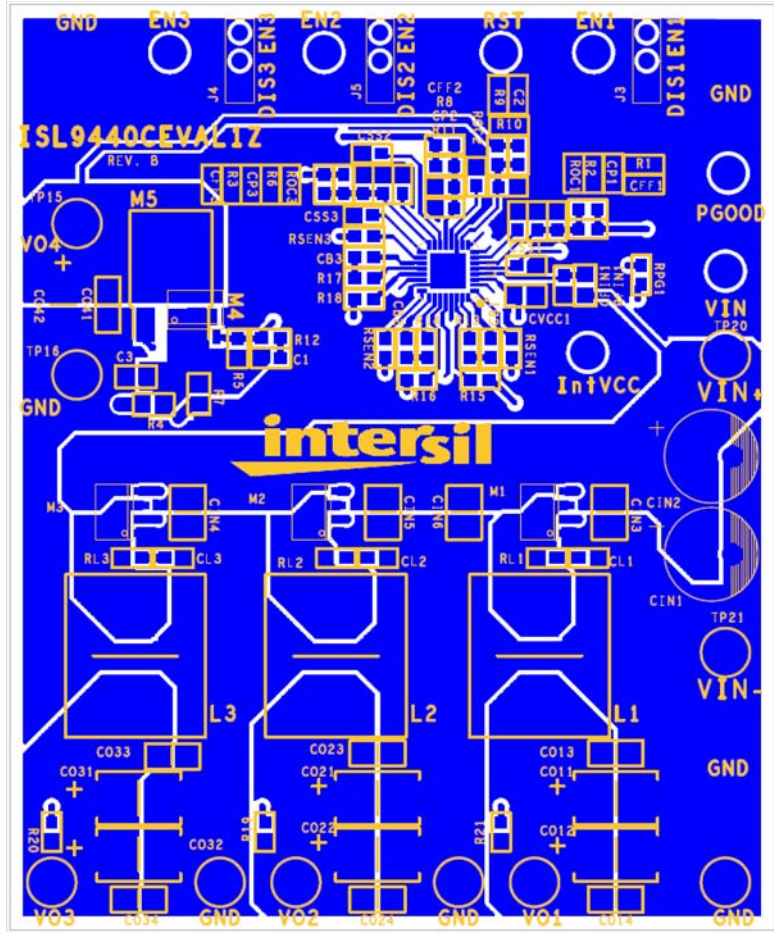

FIGURE 16. TOP LAYER

ISL9440CEVAL1Z PCB Layout

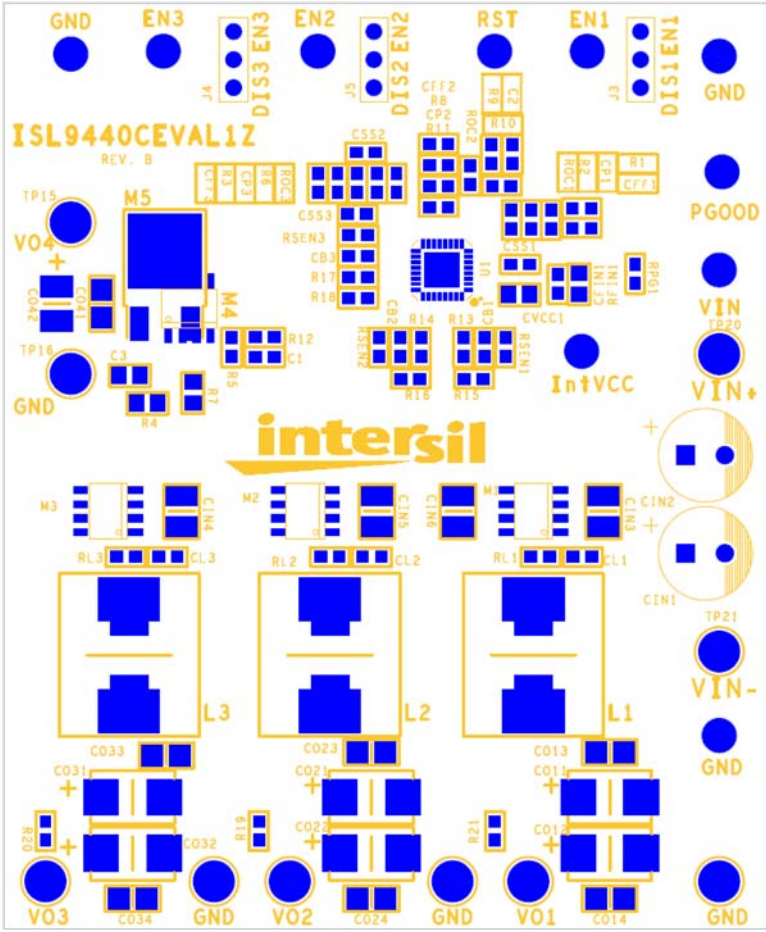

FIGURE 15. TOP COMPONENTS

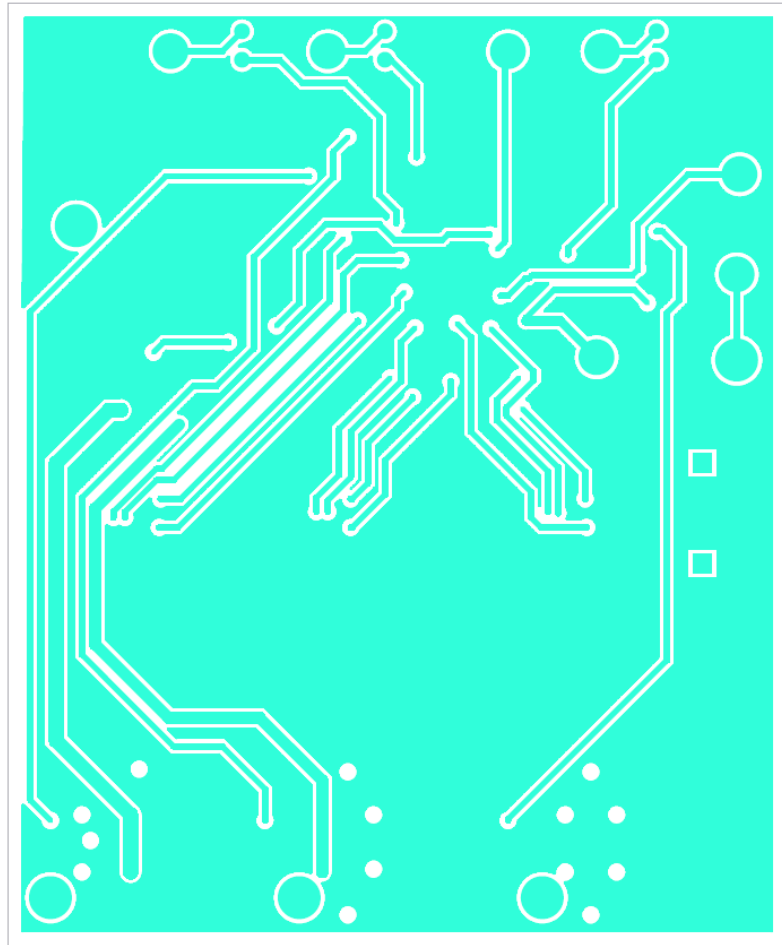

FIGURE 18. THIRD LAYER

**ISL9440CEVAL1Z PCB Layout** (Continued)

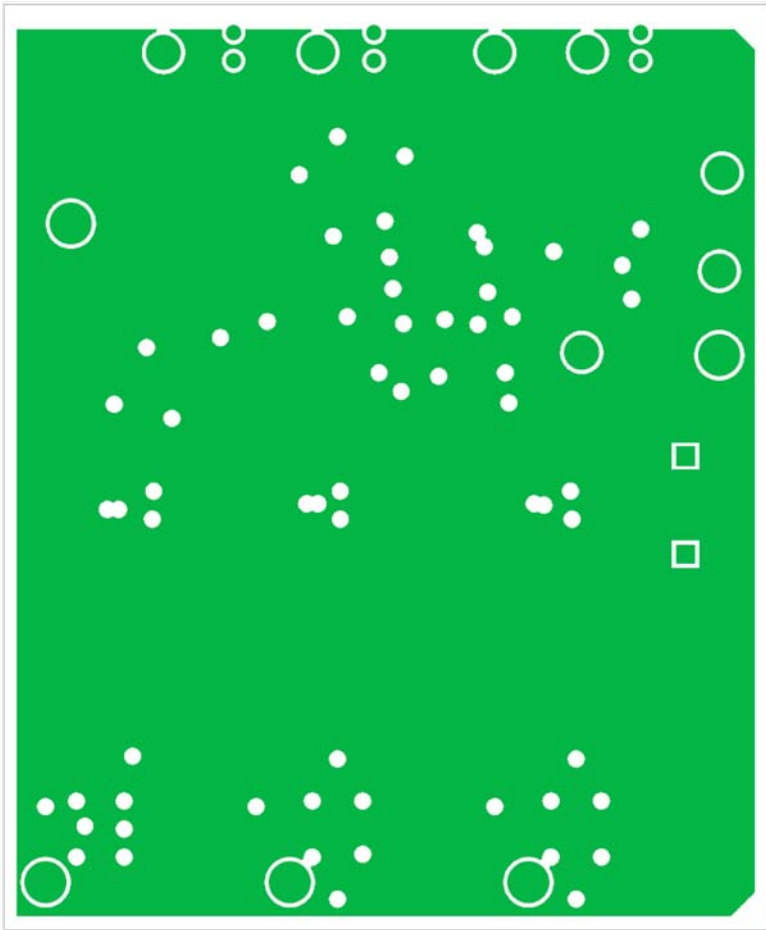

FIGURE 17. SECOND LAYER (SOLID GROUND)

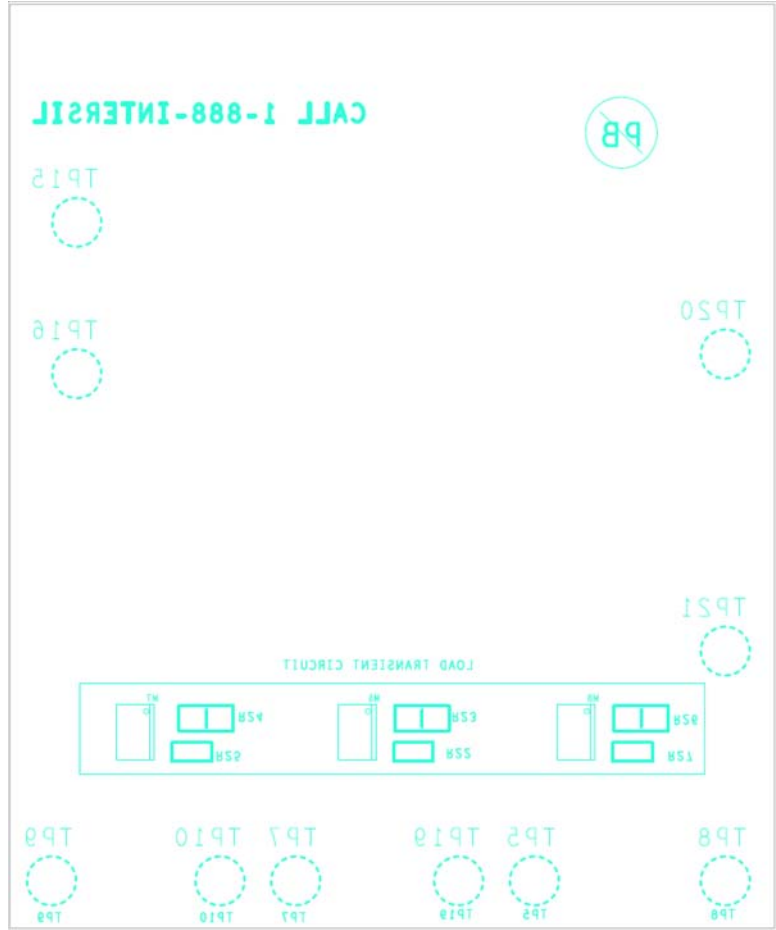

FIGURE 20. BOTTOM COMPONENTS (MIRRORED)

ISL9440CEVAL1Z PCB Layout (Continued)

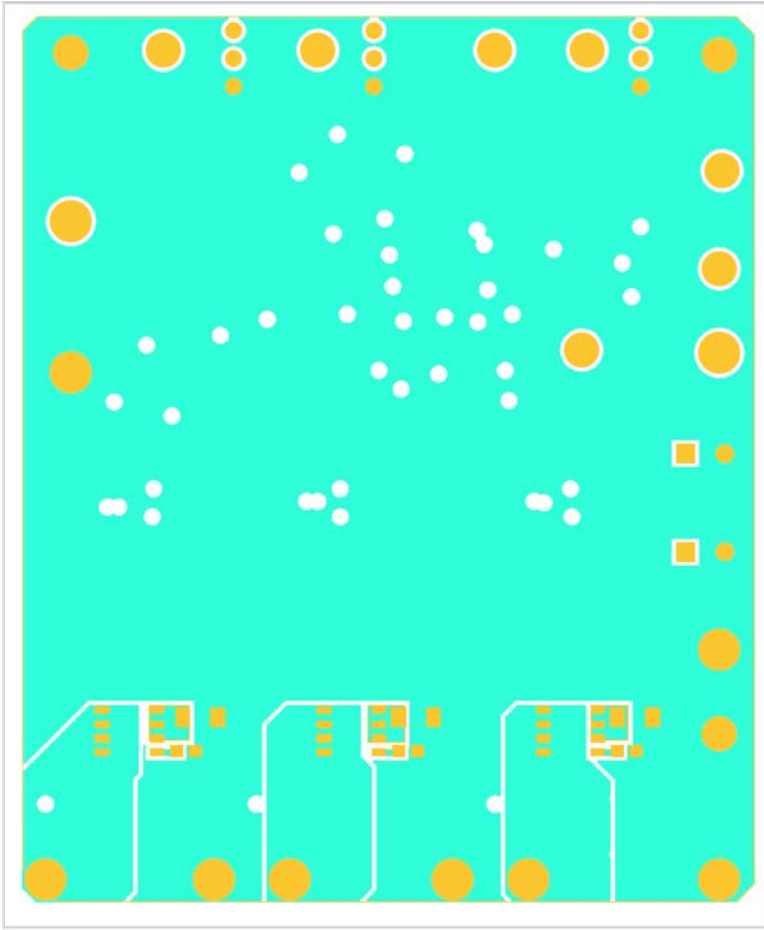

FIGURE 19. BOTTOM LAYER (MIRRORED)

## Notice

1. Descriptions of circuits, software and other related information in this document are provided only to illustrate the operation of semiconductor products and application examples. You are fully responsible for the incorporation or any other use of the circuits, software, and information in the design of your product or system. Renesas Electronics disclaims any and all liability for any losses and damages incurred by you or third parties arising from the use of these circuits, software, or information.
2. Renesas Electronics hereby expressly disclaims any warranties against and liability for infringement or any other claims involving patents, copyrights, or other intellectual property rights of third parties, by or arising from the use of Renesas Electronics products or technical information described in this document, including but not limited to, the product data, drawings, charts, programs, algorithms, and application examples.
3. No license, express, implied or otherwise, is granted hereby under any patents, copyrights or other intellectual property rights of Renesas Electronics or others.
4. You shall not alter, modify, copy, or reverse engineer any Renesas Electronics product, whether in whole or in part. Renesas Electronics disclaims any and all liability for any losses or damages incurred by you or third parties arising from such alteration, modification, copying or reverse engineering.
5. Renesas Electronics products are classified according to the following two quality grades: "Standard" and "High Quality". The intended applications for each Renesas Electronics product depends on the product's quality grade, as indicated below.  
"Standard": Computers; office equipment; communications equipment; test and measurement equipment; audio and visual equipment; home electronic appliances; machine tools; personal electronic equipment; industrial robots; etc.  
"High Quality": Transportation equipment (automobiles, trains, ships, etc.); traffic control (traffic lights); large-scale communication equipment; key financial terminal systems; safety control equipment; etc.  
Unless expressly designated as a high reliability product or a product for harsh environments in a Renesas Electronics data sheet or other Renesas Electronics document, Renesas Electronics products are not intended or authorized for use in products or systems that may pose a direct threat to human life or bodily injury (artificial life support devices or systems; surgical implantations; etc.), or may cause serious property damage (space system; undersea repeaters; nuclear power control systems; aircraft control systems; key plant systems; military equipment; etc.). Renesas Electronics disclaims any and all liability for any damages or losses incurred by you or any third parties arising from the use of any Renesas Electronics product that is inconsistent with any Renesas Electronics data sheet, user's manual or other Renesas Electronics document.
6. When using Renesas Electronics products, refer to the latest product information (data sheets, user's manuals, application notes, "General Notes for Handling and Using Semiconductor Devices" in the reliability handbook, etc.), and ensure that usage conditions are within the ranges specified by Renesas Electronics with respect to maximum ratings, operating power supply voltage range, heat dissipation characteristics, installation, etc. Renesas Electronics disclaims any and all liability for any malfunctions, failure or accident arising out of the use of Renesas Electronics products outside of such specified ranges.
7. Although Renesas Electronics endeavors to improve the quality and reliability of Renesas Electronics products, semiconductor products have specific characteristics, such as the occurrence of failure at a certain rate and malfunctions under certain use conditions. Unless designated as a high reliability product or a product for harsh environments in a Renesas Electronics data sheet or other Renesas Electronics document, Renesas Electronics products are not subject to radiation resistance design. You are responsible for implementing safety measures to guard against the possibility of bodily injury, injury or damage caused by fire, and/or danger to the public in the event of a failure or malfunction of Renesas Electronics products, such as safety design for hardware and software, including but not limited to redundancy, fire control and malfunction prevention, appropriate treatment for aging degradation or any other appropriate measures. Because the evaluation of microcomputer software alone is very difficult and impractical, you are responsible for evaluating the safety of the final products or systems manufactured by you.
8. Please contact a Renesas Electronics sales office for details as to environmental matters such as the environmental compatibility of each Renesas Electronics product. You are responsible for carefully and sufficiently investigating applicable laws and regulations that regulate the inclusion or use of controlled substances, including without limitation, the EU RoHS Directive, and using Renesas Electronics products in compliance with all these applicable laws and regulations. Renesas Electronics disclaims any and all liability for damages or losses occurring as a result of your noncompliance with applicable laws and regulations.
9. Renesas Electronics products and technologies shall not be used for or incorporated into any products or systems whose manufacture, use, or sale is prohibited under any applicable domestic or foreign laws or regulations. You shall comply with any applicable export control laws and regulations promulgated and administered by the governments of any countries asserting jurisdiction over the parties or transactions.
10. It is the responsibility of the buyer or distributor of Renesas Electronics products, or any other party who distributes, disposes of, or otherwise sells or transfers the product to a third party, to notify such third party in advance of the contents and conditions set forth in this document.
11. This document shall not be reprinted, reproduced or duplicated in any form, in whole or in part, without prior written consent of Renesas Electronics.
12. Please contact a Renesas Electronics sales office if you have any questions regarding the information contained in this document or Renesas Electronics products.  
(Note 1) "Renesas Electronics" as used in this document means Renesas Electronics Corporation and also includes its directly or indirectly controlled subsidiaries.  
(Note 2) "Renesas Electronics product(s)" means any product developed or manufactured by or for Renesas Electronics.

(Rev.4.0-1 November 2017)



### SALES OFFICES

Renesas Electronics Corporation

<http://www.renesas.com>

Refer to "<http://www.renesas.com/>" for the latest and detailed information.

**Renesas Electronics America Inc.**  
1001 Murphy Ranch Road, Milpitas, CA 95035, U.S.A.  
Tel: +1-408-432-8888, Fax: +1-408-434-5351

**Renesas Electronics Canada Limited**  
9251 Yonge Street, Suite 8309 Richmond Hill, Ontario Canada L4C 9T3  
Tel: +1-905-237-2004

**Renesas Electronics Europe Limited**  
Dukes Meadow, Millboard Road, Bourne End, Buckinghamshire, SL8 5FH, U.K  
Tel: +44-1628-651-700, Fax: +44-1628-651-804

**Renesas Electronics Europe GmbH**  
Arcadiastrasse 10, 40472 Düsseldorf, Germany  
Tel: +49-211-6503-0, Fax: +49-211-6503-1327

**Renesas Electronics (China) Co., Ltd.**  
Room 1709 Quantum Plaza, No.27 ZhichunLu, Haidian District, Beijing, 100191 P. R. China  
Tel: +86-10-8235-1155, Fax: +86-10-8235-7679

**Renesas Electronics (Shanghai) Co., Ltd.**  
Unit 301, Tower A, Central Towers, 555 Langao Road, Putuo District, Shanghai, 200333 P. R. China  
Tel: +86-21-2226-0888, Fax: +86-21-2226-0999

**Renesas Electronics Hong Kong Limited**  
Unit 1601-1611, 16/F., Tower 2, Grand Century Place, 193 Prince Edward Road West, Mongkok, Kowloon, Hong Kong  
Tel: +852-2265-6688, Fax: +852-2886-9022

**Renesas Electronics Taiwan Co., Ltd.**  
13F, No. 363, Fu Shing North Road, Taipei 10543, Taiwan  
Tel: +886-2-8175-9600, Fax: +886-2-8175-9670

**Renesas Electronics Singapore Pte. Ltd.**  
80 Bendemeer Road, Unit #06-02 Hyflux Innovation Centre, Singapore 339949  
Tel: +65-6213-0200, Fax: +65-6213-0300

**Renesas Electronics Malaysia Sdn.Bhd.**  
Unit 1207, Block B, Menara Amcorp, Amcorp Trade Centre, No. 18, Jln Persiaran Barat, 46050 Petaling Jaya, Selangor Darul Ehsan, Malaysia  
Tel: +60-3-7955-9390, Fax: +60-3-7955-9510

**Renesas Electronics India Pvt. Ltd.**  
No.777C, 100 Feet Road, HAL 2nd Stage, Indiranagar, Bangalore 560 038, India  
Tel: +91-80-67208700, Fax: +91-80-67208777

**Renesas Electronics Korea Co., Ltd.**  
17F, KAMCO Yangjae Tower, 262, Gangnam-daero, Gangnam-gu, Seoul, 06265 Korea  
Tel: +82-2-558-3737, Fax: +82-2-558-5338