

ISL70417SEH

Radiation Hardened 40V Quad Precision Low Power Operational Amplifiers

FN7962
Rev.5.00
Oct 24, 2019

The [ISL70417SEH](#) contains four very high precision amplifiers featuring the perfect combination of low noise vs power consumption. Low offset voltage, low I_{BIAS} current and low temperature drift making them the ideal choice for applications requiring both high DC accuracy and AC performance. The combination of high precision, low noise, low power and small footprint provides the user with outstanding value and flexibility relative to similar competitive parts.

Applications for these amplifiers include precision active filters, medical and analytical instrumentation, precision power supply controls, and industrial controls.

The ISL70417SEH is offered in a 14 Ld hermetic ceramic flatpack package. The device is offered in an industry standard pin configuration and operates across the extended temperature range from -55°C to +125°C.

Applications

- Precision instrumentation
- Spectral analysis equipment
- Active filter blocks
- Thermocouples and RTD reference buffers
- Data acquisition
- Power supply control

Features

- Electrically screened to DLA SMD# [5962-12228](#)
- Low input offset voltage. **±110µV, maximum**
- Superb offset temperature coefficient. . . **1µV/°C, maximum**
- Input bias current **±5nA, maximum**
- Input bias current TC **±5pA/°C, maximum**
- Low current consumption **440µA**
- Voltage noise **8nV/√Hz**
- Wide supply range **4.5V to 40V**
- Operating temperature range. **-55°C to +125°C**
- Radiation environment
 - SEB LET_{TH} (V_S = ±20V) **73.9MeV • cm²/mg**
 - Total dose, high dose rate. **300krad(Si)**
 - Total dose, low dose rate **100krad(Si)***
 - SEL immune (SOI process)

* Product capability established by initial characterization. The EH version is acceptance tested on a wafer-by-wafer basis to 50krad(Si) at low dose rate.

Related Literature

For a full list of related documents, visit our website

- [ISL70417SEH](#) product page

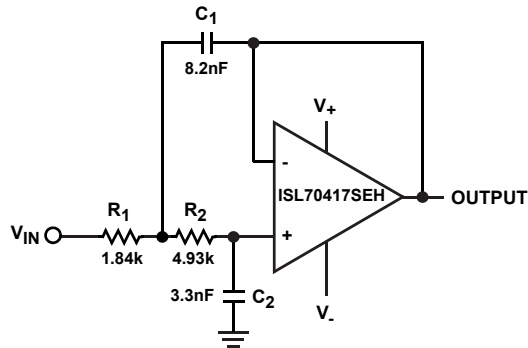

SALLEN-KEY LOW PASS FILTER (f_c = 10kHz)

FIGURE 1. TYPICAL APPLICATION

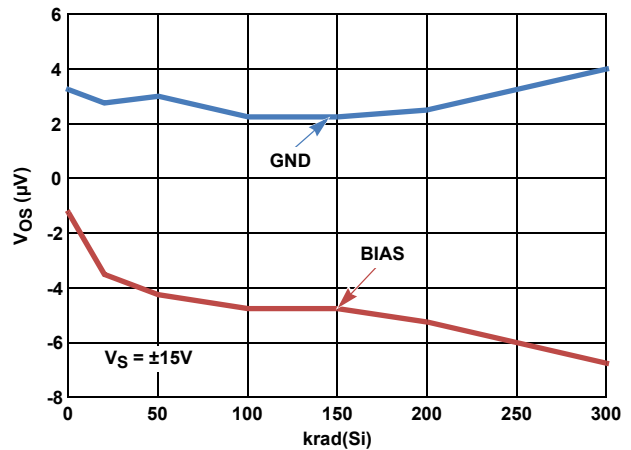

FIGURE 2. V_{OS} SHIFT vs HIGH DOSE RATE RADIATION

Ordering Information

ORDERING SMD NUMBER (Note 2)	PART NUMBER (Note 1)	TEMPERATURE RANGE (°C)	PACKAGE (RoHS COMPLIANT)	PKG. DWG. #
5962F1222801VXC	ISL70417SEHVF	-55 to +125	14 Ld Flatpack	K14.A
N/A	ISL70417SEHF/PROTO (Note 3)	-55 to +125	14 Ld Flatpack	K14.A
5962F1222801V9AX	ISL70417SEHVX	-55 to +125	DIE	
N/A	ISL70417SEHX/SAMPLE (Note 3)	+25	DIE	
N/A	ISL70417SEHEVAL1Z (Note 4)	Evaluation Board		

NOTES:

1. These Pb-free Hermetic packaged products employ 100% Au plate - e4 termination finish, which is RoHS compliant and compatible with both SnPb and Pb-free soldering operations.
2. Specifications for Rad Hard QML devices are controlled by the Defense Logistics Agency Land and Maritime (DLA). The SMD numbers listed must be used when ordering.
3. The /PROTO and /SAMPLE are not rated or certified for Total Ionizing Dose (TID) or Single Event Effect (SEE) immunity. These parts are intended for engineering evaluation purposes only. The /PROTO parts meet the electrical limits and conditions across temperature specified in the DLA SMD and are in the same form and fit as the qualified device. The /SAMPLE parts are capable of meeting the electrical limits and conditions specified in the DLA SMD at +25 °C only. The /SAMPLE parts do not receive 100% screening across temperature to the DLA SMD electrical limits. These part types do not come with a Certificate of Conformance because they are not DLA qualified devices.
4. Evaluation board uses the /PROTO parts and /PROTO parts are not rated or certified for Total Ionizing Dose (TID) or Single Event Effect (SEE) immunity.

Pin Configuration

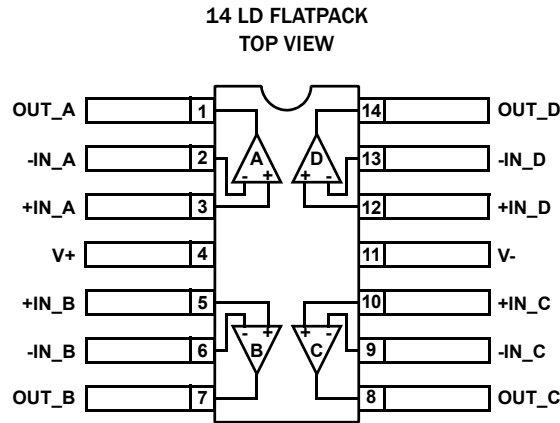

Pin Descriptions

PIN NUMBER	PIN NAME	EQUIVALENT CIRCUIT	DESCRIPTION
1	OUT_A	Circuit 2	Amplifier A output
2	-IN_A	Circuit 1	Amplifier A inverting input
3	+IN_A	Circuit 1	Amplifier A noninverting input
4	V+	Circuit 3	Positive power supply
5	+IN_B	Circuit 1	Amplifier B noninverting input
6	-IN_B	Circuit 1	Amplifier B inverting input
7	OUT_B	Circuit 2	Amplifier B output
8	OUT_C	Circuit 2	Amplifier C output
9	-IN_C	Circuit 1	Amplifier C inverting input
10	+IN_C	Circuit 1	Amplifier C noninverting input
11	V-	Circuit 3	Negative power supply
12	+IN_D	Circuit 1	Amplifier D noninverting input
13	-IN_D	Circuit 1	Amplifier D inverting input
14	OUT_D	Circuit 2	Amplifier D output

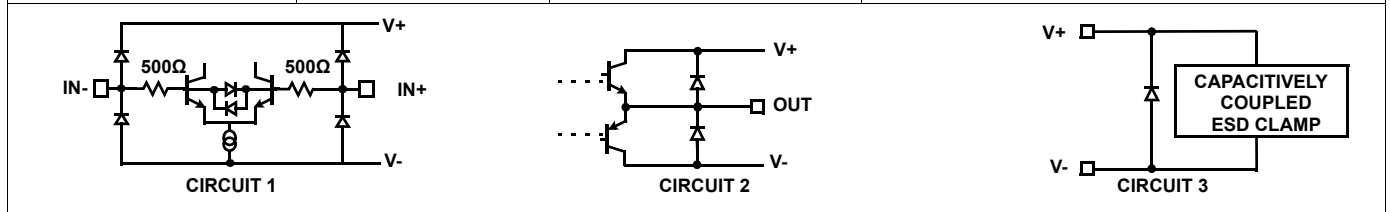

Absolute Maximum Ratings

Maximum Supply Voltage	42V
Maximum Supply Voltage (LET = 73.9MeV•cm ² /mg)	40V
Maximum Differential Input Current	20mA
Maximum Differential Input Voltage	20V
Minimum/Maximum Input Voltage	V-- 0.5V to V+ + 0.5V
Maximum/Minimum Input Current for Input Voltage >V+ or <V--	±20mA
Output Short-Circuit Duration (1 output at a time)	Indefinite
ESD Rating	
Human Body Model (Tested per MIL-PRF-883 3015.7)	2kV
Machine Model (Tested per EIA/JESD22-A115-A)	300V
Charged Device Model (Tested per JESD22-C101D)	2kV

Thermal Information

Thermal Resistance (Typical)	θ_{JA} (°C/W)	θ_{JC} (°C/W)
14 Ld Flatpack (Notes 5, 6)	105	15
Maximum Storage Temperature Range	-65°C to +150°C	
Maximum Junction Temperature (T _{JMAX})	+150°C	

Recommended Operating Conditions

Ambient Operating Temperature Range	-55°C to +125°C
Maximum Operating Junction Temperature	+150°C
Supply Voltage	4.5V (±2.25V) to 30V (±15V)

CAUTION: Do not operate at or near the maximum ratings listed for extended periods of time. Exposure to such conditions can adversely impact product reliability and result in failures not covered by warranty.

NOTES:

- θ_{JA} is measured with the component mounted on a low effective thermal conductivity test board in free air. See [TB379](#) for details.
- For θ_{JC} , the "case temp" location is the center of the ceramic on the package underside.

Electrical Specifications (V_S ±15V) V_{CM} = 0, V_O = 0V, T_A = +25°C, unless otherwise noted. **Boldface limits apply across the operating temperature range, -55°C to +125°C; over a total ionizing dose of 300krad(Si) with exposure at a high dose rate of 50 to 300krad(Si)/s; and over a total ionizing dose of 50krad(Si) with exposure at a low dose rate of <10mrad(Si)/s.**

PARAMETER	DESCRIPTION	TEST CONDITIONS	MIN (Note 7)	TYP	MAX (Note 7)	UNIT
V _{OS}	Input Offset Voltage			10	85	μV
					110	μV
TCV _{OS}	Offset Voltage Drift			0.1	1	μV/°C
I _B	Input Bias Current		-2.5	0.08	2.50	nA
		T _A = -55°C, +125°C	-5		5	nA
		T _A = +25°C, post radiation	-15		15	nA
TCI _B	Input Bias Current Temperature Coefficient		-5	1	5	pA/°C
I _{OS}	Input Offset Current		-2.50	0.08	2.50	nA
		T _A = -55°C, +125°C	-3		3	nA
		T _A = +25°C, post radiation	-6		6	nA
TCI _{OS}	Input Offset Current Temperature Coefficient		-3	0.42	3	pA/°C
V _{CM}	Input Voltage Range	Guaranteed by CMRR test	-13		13	V
CMRR	Common-Mode Rejection Ratio	V _{CM} = -13V to +13V	120	145		dB
			120			dB
PSRR	Power Supply Rejection Ratio	V _S = ±2.25V to ±20V	120	145		dB
			120			dB
A _{VOL}	Open-Loop Gain	V _O = -13V to +13V, R _L = 10kΩ to ground	3,000	14,000		V/mV
V _{OH}	Output Voltage High	R _L = 10kΩ to ground	13.5	13.7		V
			13.2			V
		R _L = 2kΩ to ground	13.30	13.55		V
			13.0			V

Electrical Specifications ($V_S \pm 15V$) $V_{CM} = 0$, $V_O = 0V$, $T_A = +25^\circ C$, unless otherwise noted. **Boldface limits apply across the operating temperature range, $-55^\circ C$ to $+125^\circ C$; over a total ionizing dose of 300krad(Si) with exposure at a high dose rate of 50 to 300krad(Si)/s; and over a total ionizing dose of 50krad(Si) with exposure at a low dose rate of <10 krad(Si)/s. (Continued)**

PARAMETER	DESCRIPTION	TEST CONDITIONS	MIN (Note 7)	TYP	MAX (Note 7)	UNIT
V_{OL}	Output Voltage Low	$R_L = 10k\Omega$ to ground		-13.7	-13.5	V
					-13.2	V
		$R_L = 2k\Omega$ to ground		-13.55	-13.30	V
					-13.0	V
I_S	Supply Current/Amplifier			0.44	0.53	mA
					0.68	mA
I_{SC}	Short-Circuit Current			43		mA
V_{SUPPLY}	Supply Voltage Range	Guaranteed by PSRR	± 2.25		± 20	V
AC SPECIFICATIONS						
GBWP	Gain Bandwidth Product	$A_V = 1k$, $R_L = 2k\Omega$		1.5		MHz
e_{nVp-p}	Voltage Noise V_{p-p}	0.1Hz to 10Hz		0.25		μV_{p-p}
e_n	Voltage Noise Density	$f = 10Hz$		10		nV/ \sqrt{Hz}
		$f = 100Hz$		8.2		nV/ \sqrt{Hz}
		$f = 1kHz$		8		nV/ \sqrt{Hz}
		$f = 10kHz$		8		nV/ \sqrt{Hz}
i_n	Current Noise Density	$f = 1kHz$		0.1		pA/ \sqrt{Hz}
THD + N	Total Harmonic Distortion	1kHz, $G = 1$, $V_O = 3.5V_{RMS}$, $R_L = 2k\Omega$		0.0009		%
		1kHz, $G = 1$, $V_O = 3.5V_{RMS}$, $R_L = 10k\Omega$		0.0005		%
TRANSIENT RESPONSE						
SR	Slew Rate, V_{OUT} 20% to 80%	$A_V = 11$, $R_L = 2k\Omega$, $V_O = 4V_{p-p}$	0.3	0.5		V/ μs
			0.2			V/ μs
t_r , t_f Small Signal	Rise Time 10% to 90% of V_{OUT}	$A_V = 1$, $V_{OUT} = 50mV_{p-p}$, $R_L = 10k\Omega$ to V_{CM}		130	450	ns
					625	ns
	Fall Time 90% to 10% of V_{OUT}	$A_V = 1$, $V_{OUT} = 50mV_{p-p}$, $R_L = 10k\Omega$ to V_{CM}		130	600	ns
					700	ns
t_s	Settling Time to 0.1% 10V Step; 10% to V_{OUT}	$A_V = -1$, $V_{OUT} = 10V_{p-p}$, $R_L = 5k\Omega$ to V_{CM}		21		μs
	Settling Time to 0.01% 10V Step; 10% to V_{OUT}	$A_V = -1$, $V_{OUT} = 10V_{p-p}$, $R_L = 5k\Omega$ to V_{CM}		24		μs
	Settling Time to 0.1% 4V Step; 10% to V_{OUT}	$A_V = -1$, $V_{OUT} = 4V_{p-p}$, $R_L = 5k\Omega$ to V_{CM}		13		μs
	Settling Time to 0.01% 4V Step; 10% to V_{OUT}	$A_V = -1$, $V_{OUT} = 4V_{p-p}$, $R_L = 5k\Omega$ to V_{CM}		18		μs
t_{OL}	Output Positive Overload Recovery Time	$A_V = -100$, $V_{IN} = 0.2V_{p-p}$, $R_L = 2k\Omega$ to V_{CM}		5.6		μs
	Output Negative Overload Recovery Time	$A_V = -100$, $V_{IN} = 0.2V_{p-p}$, $R_L = 2k\Omega$ to V_{CM}		10.6		μs
OS+	Positive Overshoot	$A_V = 1$, $V_{OUT} = 10V_{p-p}$, $R_f = 0\Omega$, $R_L = 2k\Omega$ to V_{CM}		15		%
					33	%
OS-	Negative Overshoot	$A_V = 1$, $V_{OUT} = 10V_{p-p}$, $R_f = 0\Omega$, $R_L = 2k\Omega$ to V_{CM}		15		%
					33	%

Electrical Specifications ($V_S \pm 5V$), $V_{CM} = 0$, $V_O = 0V$, $T_A = +25^\circ C$, unless otherwise noted. **Boldface limits apply across the operating temperature range, $-55^\circ C$ to $+125^\circ C$; over a total ionizing dose of 300krad(Si) with exposure at a high dose rate of 50 to 300krad(Si)/s; and over a total ionizing dose of 50krad(Si) with exposure a low dose rate of <10 mrad(Si)/s.**

PARAMETER	DESCRIPTION	CONDITIONS	MIN (Note 7)	TYP	MAX (Note 7)	UNIT				
V_{OS}	Input Offset Voltage			10	150	μV				
					250	μV				
TCV_{OS}	Offset Voltage Drift			0.1	1	$\mu V/^\circ C$				
I_B	Input Bias Current			-2.50	0.18	2.50				
						$T_A = -55^\circ C, +125^\circ C$	-5	5	nA	
						$T_A = +25^\circ C$, post radiation	-15	15	nA	
TCI_B	Input Bias Current Temperature Coefficient		-5	1	5	$\mu A/^\circ C$				
I_{OS}	Input Offset Current			-2.5	0.3	2.5				
						$T_A = -55^\circ C, +125^\circ C$	-3	3	nA	
						$T_A = +25^\circ C$, post radiation	-6	6	nA	
TCI_{OS}	Input Offset Current Temperature Coefficient		-3	0.42	3	$\mu A/^\circ C$				
V_{CM}	Input Voltage Range		-3		3	V				
CMRR	Common-Mode Rejection Ratio	$V_{CM} = -3V$ to $+3V$		120	145	dB				
				120		dB				
PSRR	Power Supply Rejection Ratio	$V_S = \pm 2.25V$ to $\pm 5V$		120	145	dB				
				120		dB				
A_{VOL}	Open-Loop Gain	$V_O = -3.0V$ to $+3.0V$ $R_L = 10k\Omega$ to ground	3,000	14,000		V/mV				
V_{OH}	Output Voltage High	$R_L = 10k\Omega$ to ground		3.5	3.7	V				
						3.2	V			
						$R_L = 2k\Omega$ to ground	3.30	3.55	V	
						3.0	V			
V_{OL}	Output Voltage Low	$R_L = 10k\Omega$ to ground			-3.7	-3.5				
						-3.2	V			
						$R_L = 2k\Omega$ to ground		-3.55	-3.30	V
						-3.0	V			
I_S	Supply Current/Amplifier			0.44	0.53	mA				
						0.68	mA			
I_{SC}	Short-Circuit Current			43		mA				
AC SPECIFICATIONS										
GBWP	Gain Bandwidth Product	$A_V = 1k$, $R_L = 2k\Omega$		1.5		MHz				
e_{np-p}	Voltage Noise	0.1Hz to 10Hz		0.25		μV_{p-p}				
e_n	Voltage Noise Density	$f = 10Hz$			12	nV/\sqrt{Hz}				
						$f = 100Hz$	8.6	nV/\sqrt{Hz}		
						$f = 1kHz$	8	nV/\sqrt{Hz}		
						$f = 10kHz$	8	nV/\sqrt{Hz}		
i_n	Current Noise Density	$f = 1kHz$		0.1		$\mu A/\sqrt{Hz}$				

Electrical Specifications ($V_S \pm 5V$), $V_{CM} = 0$, $V_O = 0V$, $T_A = +25^\circ C$, unless otherwise noted. **Boldface limits apply across the operating temperature range, $-55^\circ C$ to $+125^\circ C$; over a total ionizing dose of 300krad(Si) with exposure at a high dose rate of 50 to 300krad(Si)/s; and over a total ionizing dose of 50krad(Si) with exposure a low dose rate of <10 mrads(Si)/s. (Continued)**

PARAMETER	DESCRIPTION	CONDITIONS	MIN (Note 7)	TYP	MAX (Note 7)	UNIT
TRANSIENT RESPONSE						
SR	Slew Rate, V_{OUT} 20% to 80%	$A_V = 11$, $R_L = 2k\Omega$, $V_O = 4V_{P-P}$		0.5		V/ μ s
t_r , t_f , Small Signal	Rise Time 10% to 90% of V_{OUT}	$A_V = 1$, $V_{OUT} = 50mV_{P-P}$, $R_L = 10k\Omega$ to V_{CM}		130		ns
	Fall Time 90% to 10% of V_{OUT}	$A_V = 1$, $V_{OUT} = 50mV_{P-P}$, $R_L = 10k\Omega$ to V_{CM}		130		ns
t_s	Settling Time to 0.1% 4V Step; 10% to V_{OUT}	$A_V = -1$, $V_{OUT} = 4V_{P-P}$, $R_L = 5k\Omega$ to V_{CM}		12		μ s
	Settling Time to 0.01% 4V Step; 10% to V_{OUT}	$A_V = -1$, $V_{OUT} = 4V_{P-P}$, $R_L = 5k\Omega$ to V_{CM}		19		μ s
t_{OL}	Output Positive Overload Recovery Time	$A_V = -100$, $V_{IN} = 0.2V_{P-P}$, $R_L = 2k\Omega$ to V_{CM}		7		μ s
	Output Negative Overload Recovery Time	$A_V = -100$, $V_{IN} = 0.2V_{P-P}$, $R_L = 2k\Omega$ to V_{CM}		5.8		μ s
OS+	Positive Overshoot	$A_V = 1$, $V_{OUT} = 10V_{P-P}$, $R_f = 0\Omega$, $R_L = 2k\Omega$ to V_{CM}		15		%
OS-	Negative Overshoot	$A_V = 1$, $V_{OUT} = 10V_{P-P}$, $R_f = 0\Omega$, $R_L = 2k\Omega$ to V_{CM}		15		%

NOTE:

7. Compliance to datasheet limits is assured by one or more methods: production test, characterization and/or design.

Typical Performance Curves

$V_S = \pm 15V$, $V_{CM} = 0V$, $R_L = \text{Open}$, $T_A = +25^\circ C$, unless otherwise specified.

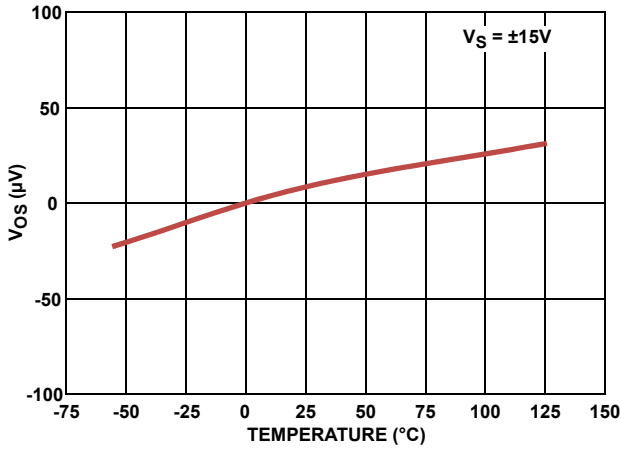

FIGURE 3. V_{OS} vs TEMPERATURE

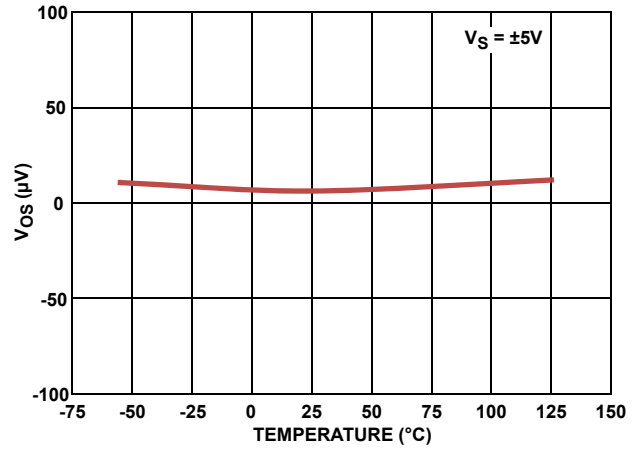

FIGURE 4. V_{OS} vs TEMPERATURE

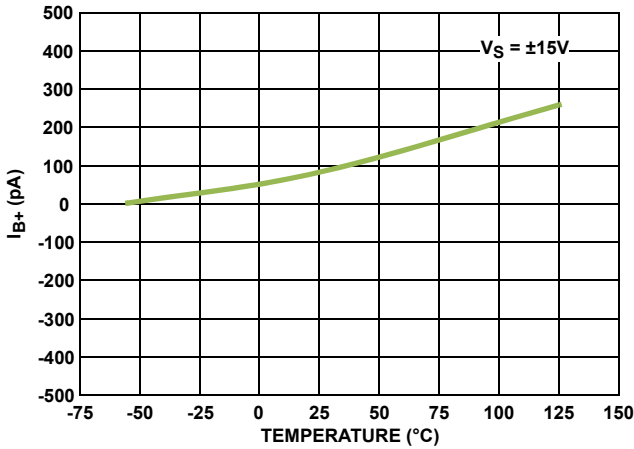

FIGURE 5. I_{B+} vs TEMPERATURE

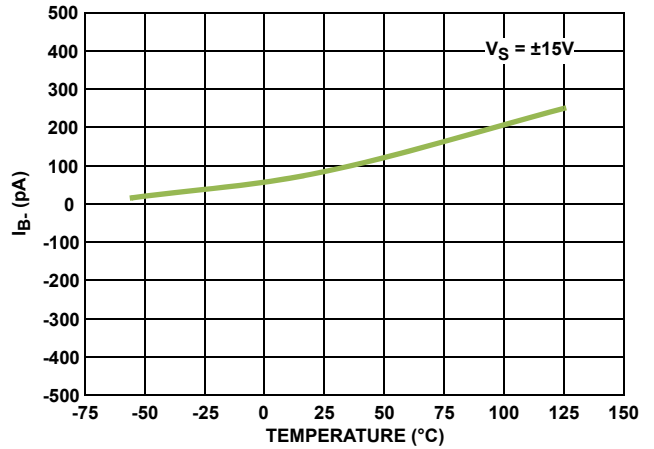

FIGURE 6. I_{B-} vs TEMPERATURE

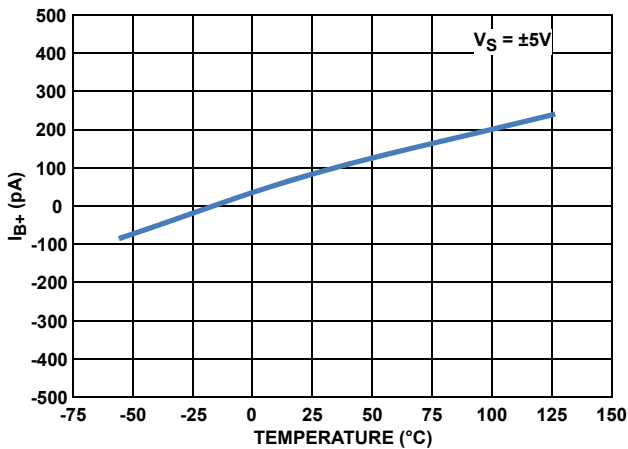

FIGURE 7. I_{B+} vs TEMPERATURE

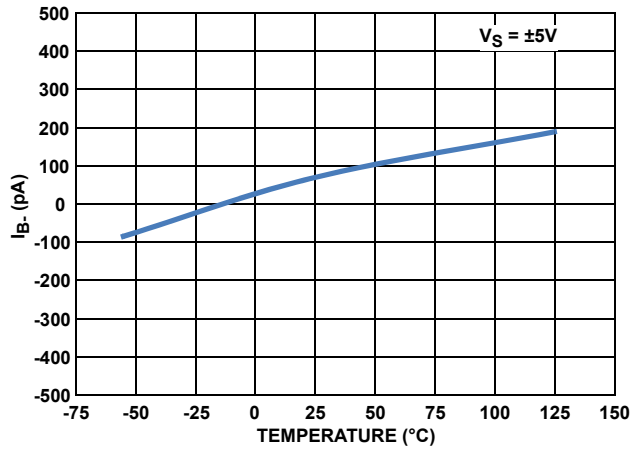

FIGURE 8. I_{B-} vs TEMPERATURE

Typical Performance Curves $V_S = \pm 15V, V_{CM} = 0V, R_L = \text{Open}, T_A = +25^\circ C$, unless otherwise specified. (Continued)

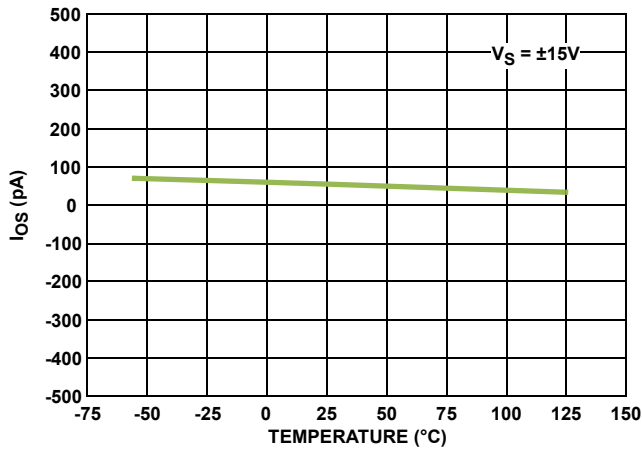

FIGURE 9. I_{OS} vs TEMPERATURE

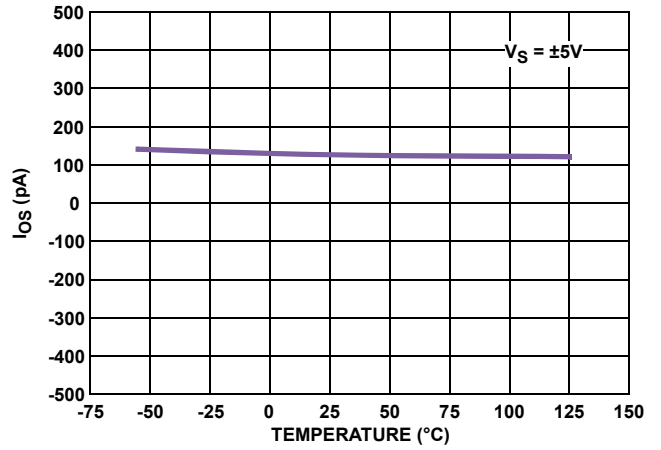

FIGURE 10. I_{OS} vs TEMPERATURE

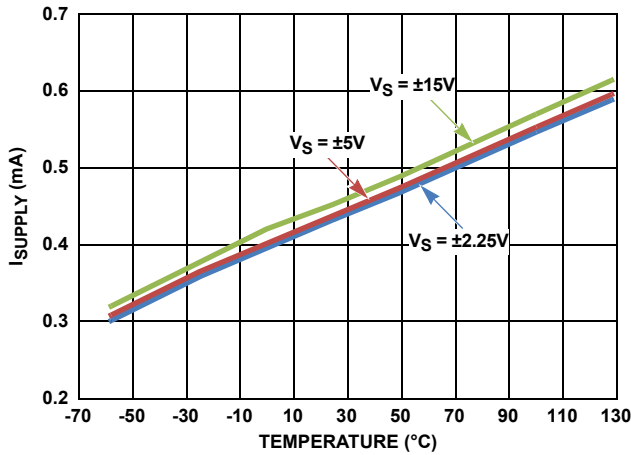

FIGURE 11. SUPPLY CURRENT PER AMPLIFIER vs TEMPERATURE

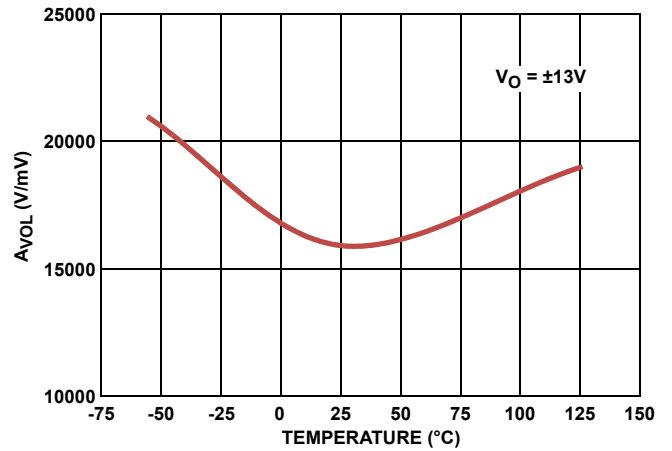

FIGURE 12. A_{VOL} vs TEMPERATURE

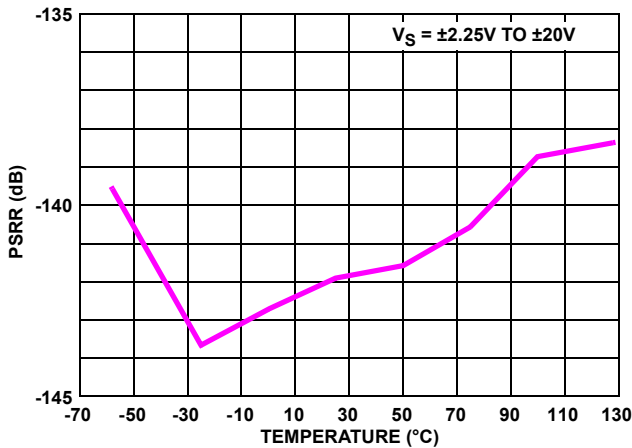

FIGURE 13. PSRR vs TEMPERATURE

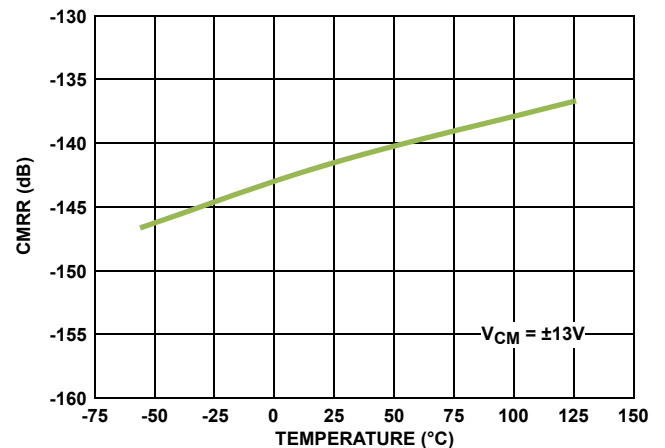

FIGURE 14. CMRR vs TEMPERATURE

Typical Performance Curves $V_S = \pm 15V, V_{CM} = 0V, R_L = \text{Open}, T_A = +25^\circ C$, unless otherwise specified. (Continued)

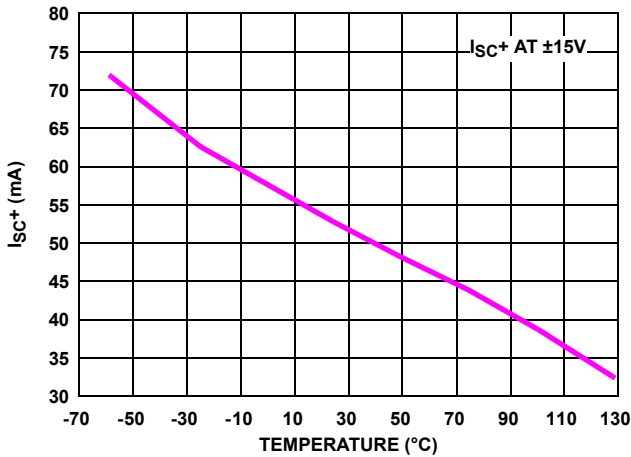

FIGURE 15. SHORT-CIRCUIT CURRENT vs TEMPERATURE

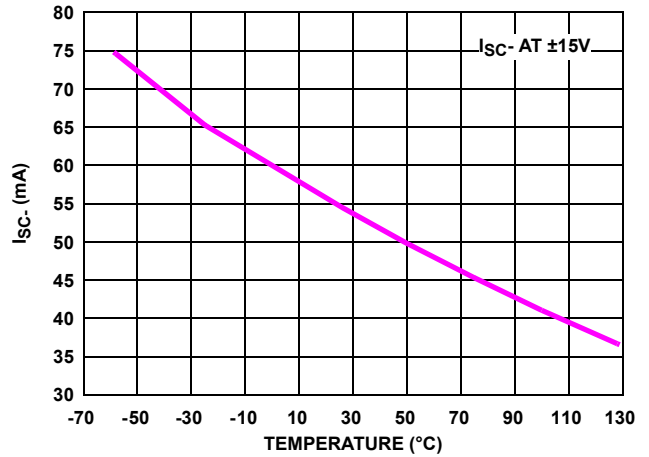

FIGURE 16. SHORT-CIRCUIT CURRENT vs TEMPERATURE

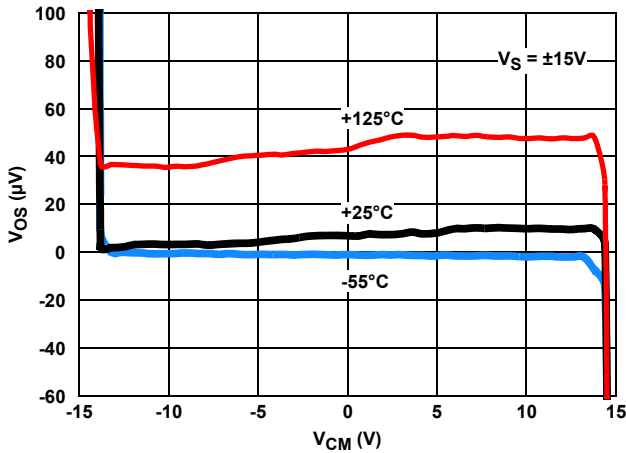

FIGURE 17. INPUT V_{OS} vs INPUT COMMON-MODE VOLTAGE, $V_S = \pm 15$

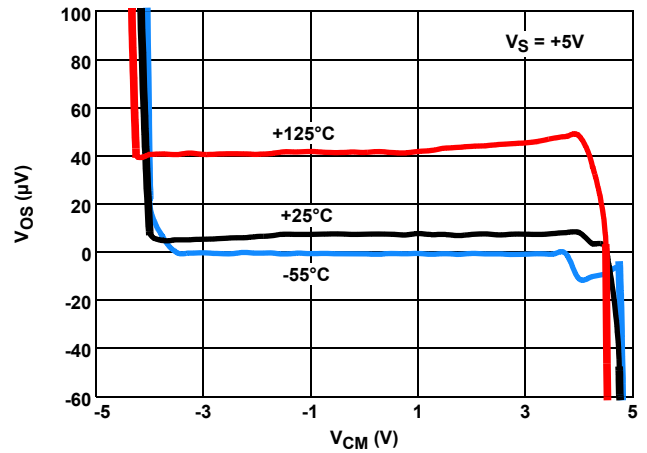

FIGURE 18. INPUT V_{OS} vs INPUT COMMON-MODE VOLTAGE, $V_S = \pm 5V$

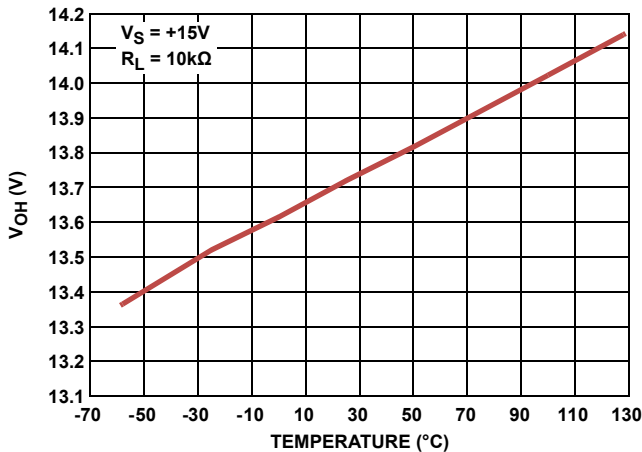

FIGURE 19. V_{OUT} vs TEMPERATURE

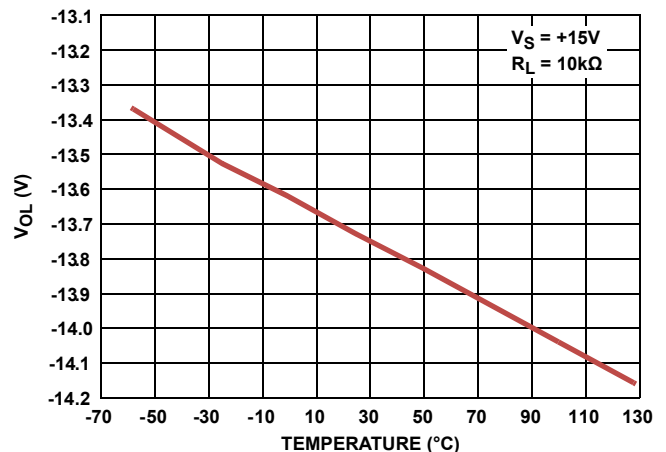

FIGURE 20. V_{OUT} vs TEMPERATURE

Typical Performance Curves $V_S = \pm 15V, V_{CM} = 0V, R_L = \text{Open}, T_A = +25^\circ C$, unless otherwise specified. (Continued)

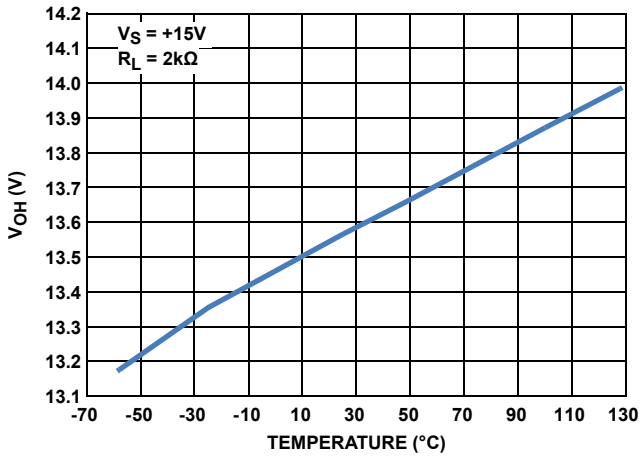

FIGURE 21. V_{OH} vs TEMPERATURE

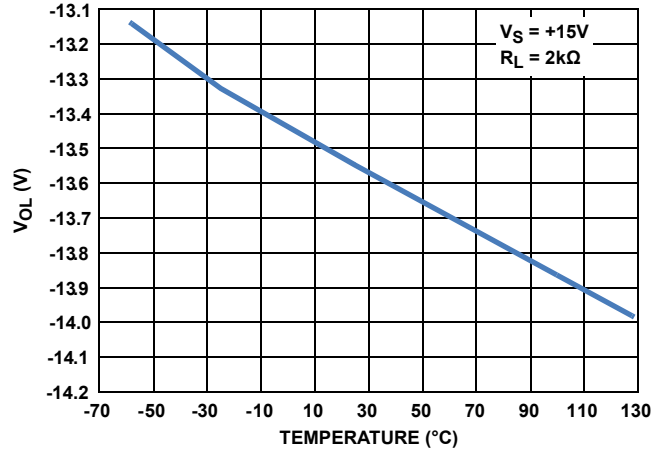

FIGURE 22. V_{OL} vs TEMPERATURE

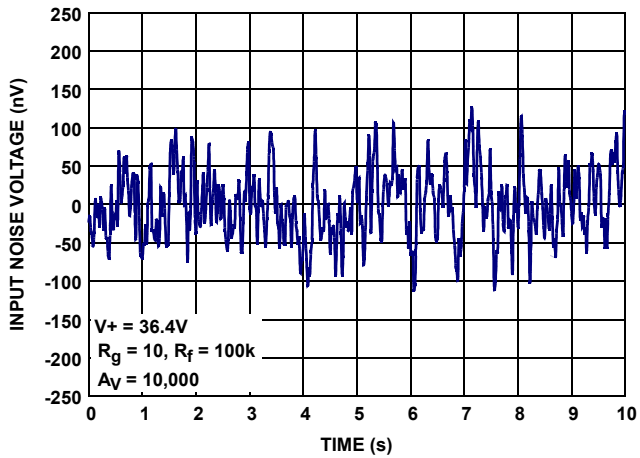

FIGURE 23. INPUT NOISE VOLTAGE 0.1Hz TO 10Hz

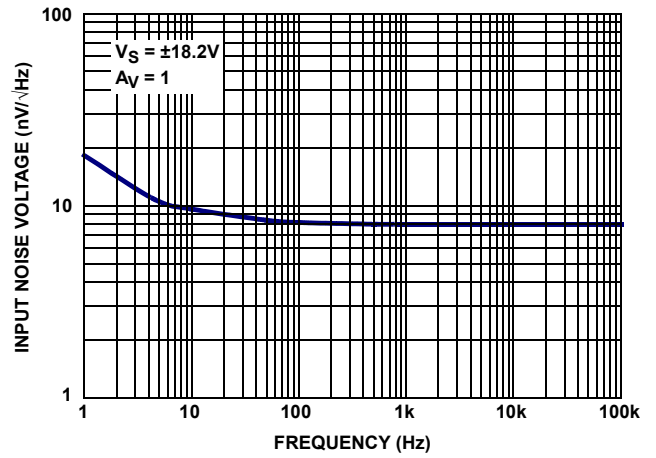

FIGURE 24. INPUT NOISE VOLTAGE SPECTRAL DENSITY

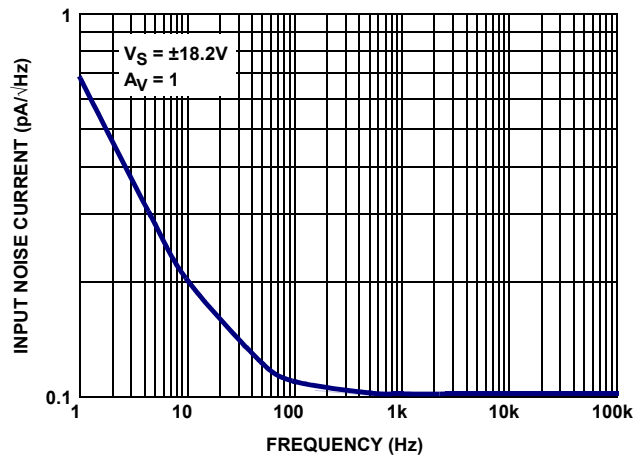

FIGURE 25. INPUT NOISE CURRENT SPECTRAL DENSITY

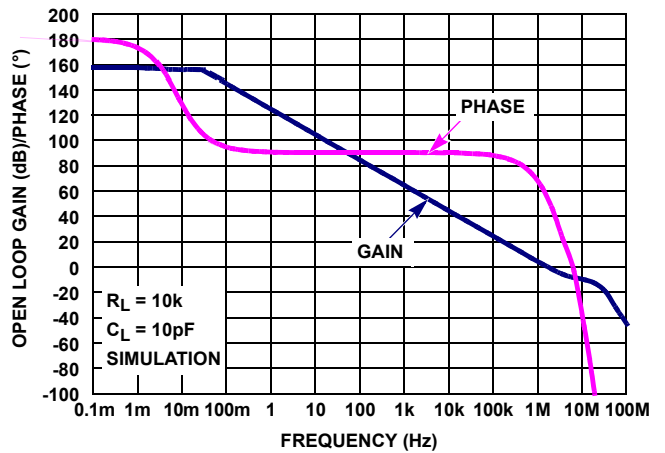

FIGURE 26. OPEN-LOOP GAIN, PHASE vs FREQUENCY, $R_L = 10k\Omega, C_L = 10pF$

Typical Performance Curves $V_S = \pm 15V, V_{CM} = 0V, R_L = \text{Open}, T_A = +25^\circ C$, unless otherwise specified. (Continued)

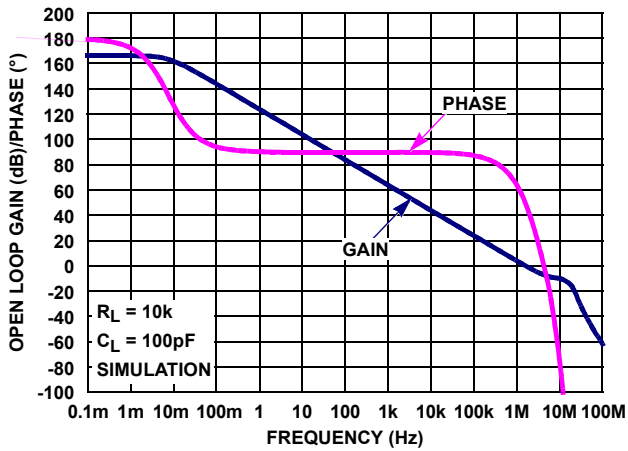

FIGURE 27. OPEN-LOOP GAIN, PHASE vs FREQUENCY, $R_L = 10k\Omega, C_L = 100pF$

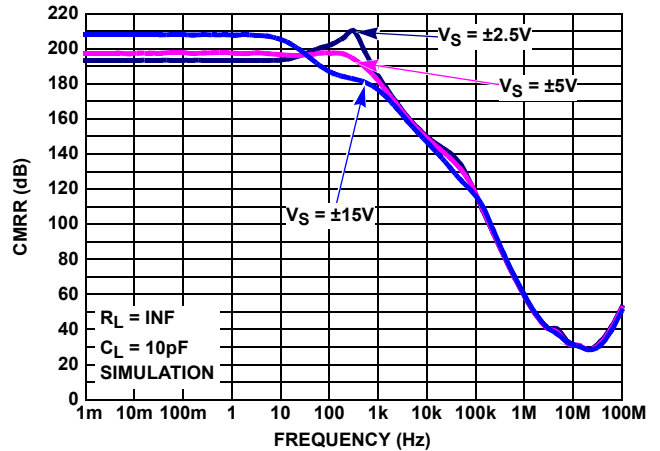

FIGURE 28. CMRR vs FREQUENCY, $V_S = \pm 2.25, \pm 5V, \pm 15V$

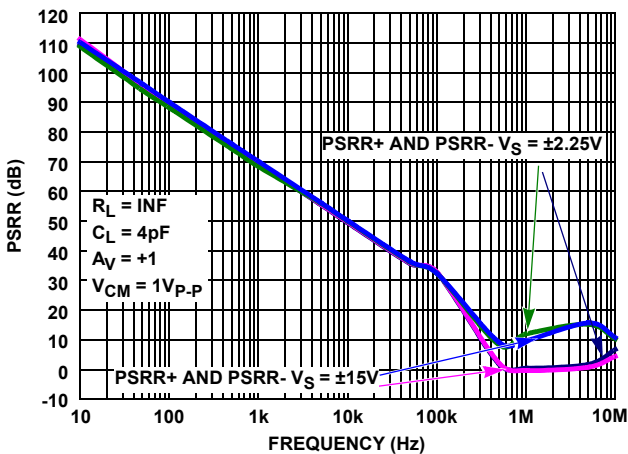

FIGURE 29. PSRR vs FREQUENCY, $V_S = \pm 5V, \pm 15V$

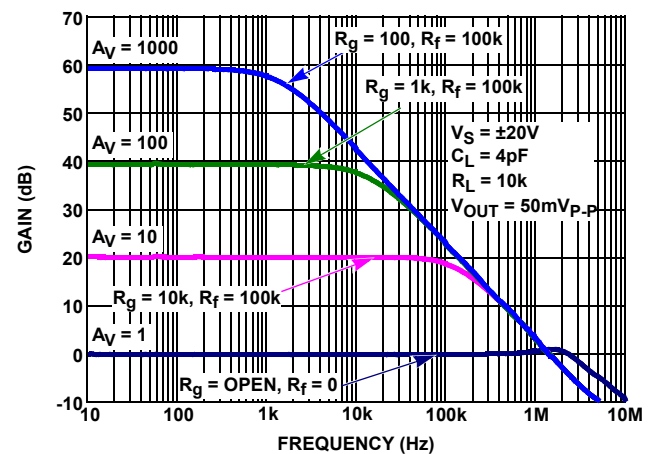

FIGURE 30. FREQUENCY RESPONSE vs CLOSED LOOP GAIN

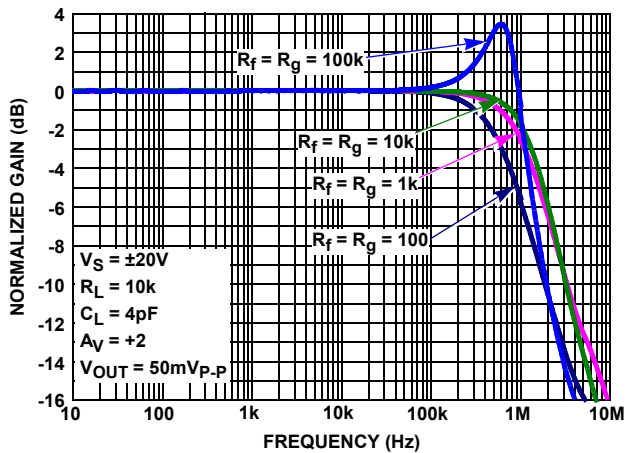

FIGURE 31. FREQUENCY RESPONSE vs FEEDBACK RESISTANCE R_f/R_g

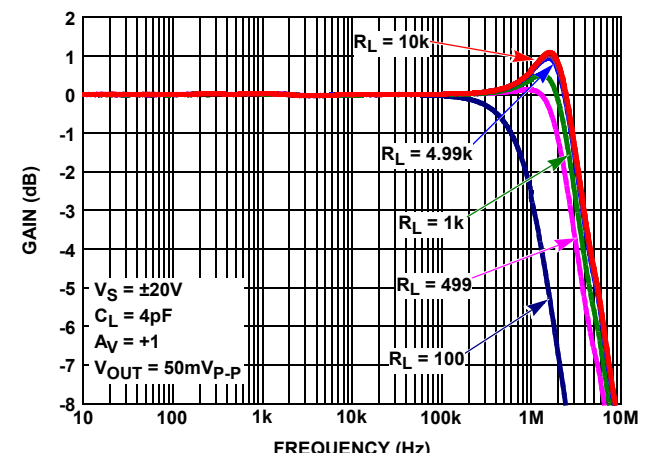

FIGURE 32. GAIN vs FREQUENCY vs R_L

Typical Performance Curves $V_S = \pm 15V, V_{CM} = 0V, R_L = \text{Open}, T_A = +25^\circ C$, unless otherwise specified. (Continued)

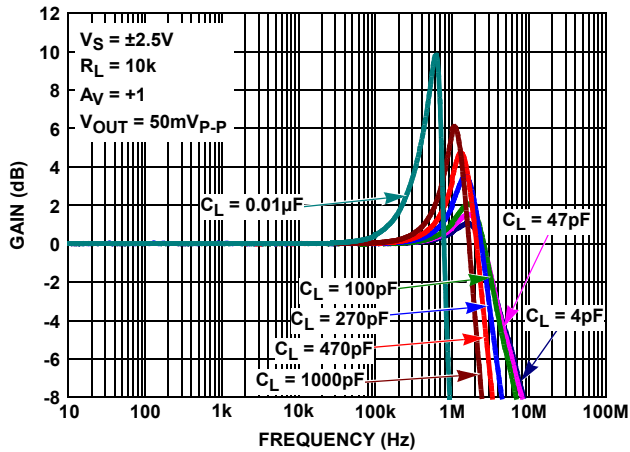

FIGURE 33. GAIN vs FREQUENCY vs C_L

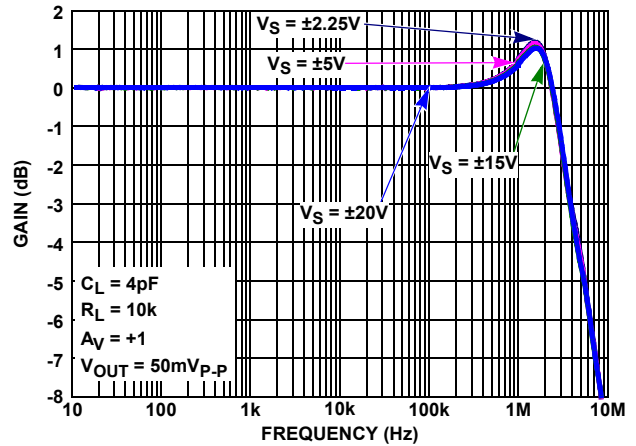

FIGURE 34. GAIN vs FREQUENCY vs SUPPLY VOLTAGE

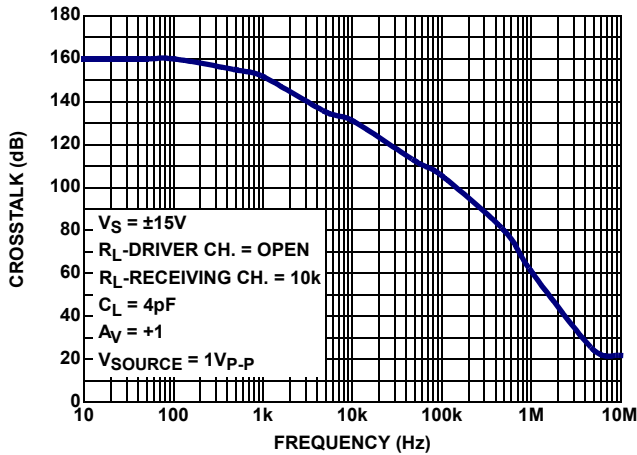

FIGURE 35. CROSSTALK, $V_S = \pm 15V$

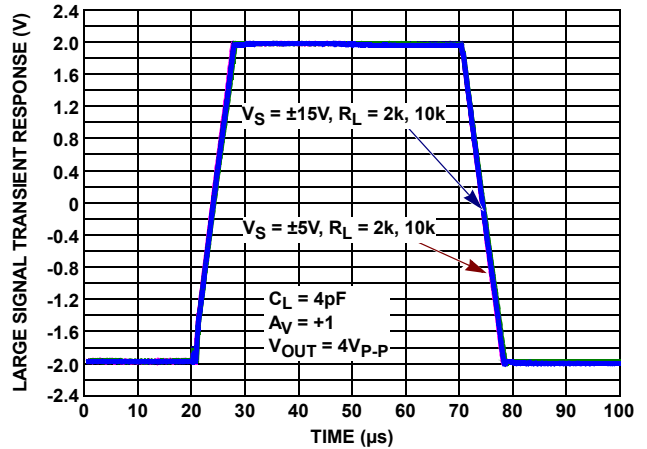

FIGURE 36. LARGE SIGNAL TRANSIENT RESPONSE vs $R_L, V_S = \pm 5V, \pm 15V$

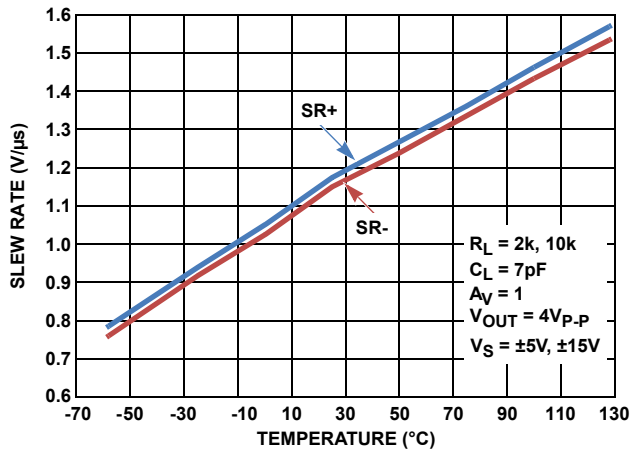

FIGURE 37. SLEW RATE vs TEMPERATURE $V_S = \pm 5V, \pm 15V$

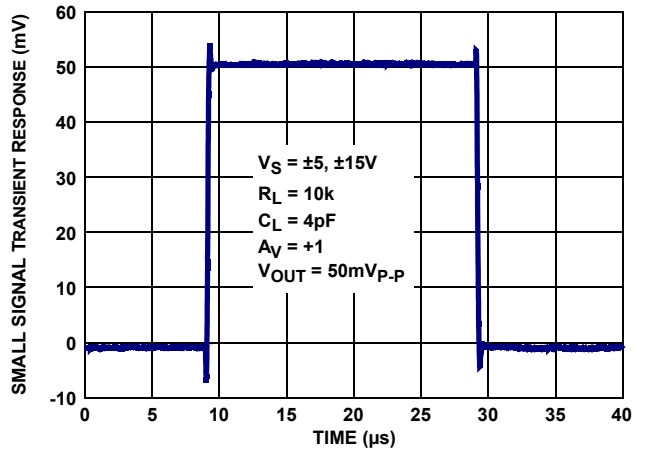

FIGURE 38. SMALL SIGNAL TRANSIENT RESPONSE, $V_S = \pm 5V, \pm 15V$

Typical Performance Curves

$V_S = \pm 15V$, $V_{CM} = 0V$, $R_L = \text{Open}$, $T_A = +25^\circ C$, unless otherwise specified. (Continued)

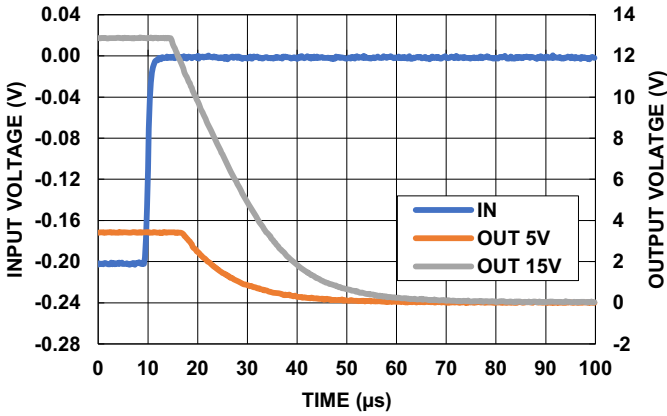

FIGURE 39. POSITIVE OUTPUT OVERLOAD RESPONSE TIME,
 $V_S = \pm 5V, \pm 15V$, $R_L = 2k$, $C_L = 4pF$, $A_V = -100$, $R_f = 100k$,
 $R_g = 1k$, $V_{IN} = 200mV_{p-p}$

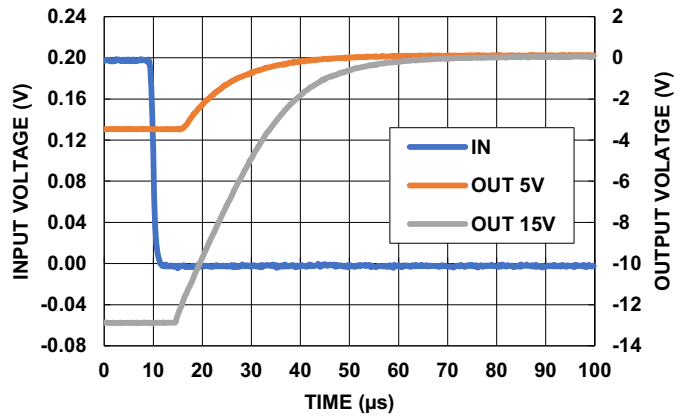

FIGURE 40. NEGATIVE OUTPUT OVERLOAD RESPONSE TIME,
 $V_S = \pm 5V, \pm 15V$, $R_L = 2k$, $C_L = 4pF$, $A_V = -100$, $R_f = 100k$,
 $R_g = 1k$, $V_{IN} = 200mV_{p-p}$

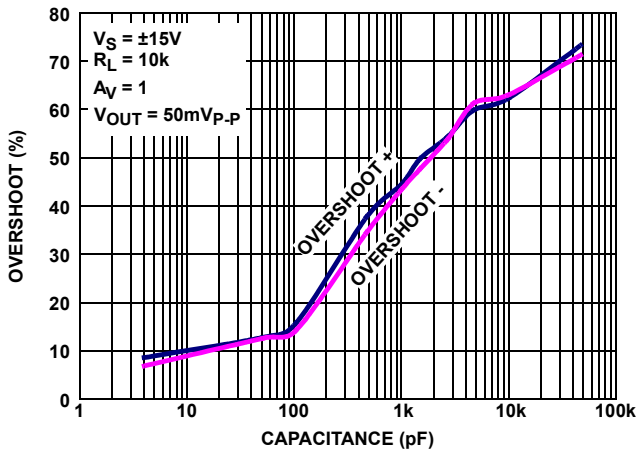

FIGURE 41. % OVERSHOOT vs LOAD CAPACITANCE, $V_S = \pm 15V$

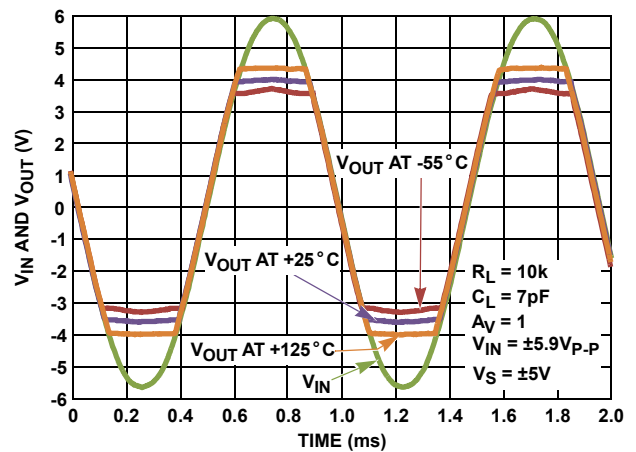

FIGURE 42. OUTPUT PHASE REVERSAL RESPONSE vs TEMPERATURE

Post High Dose Radiation Characteristics

Unless otherwise specified, $V_S \pm 15V$, $V_{CM} = 0$, $V_O = 0V$, $T_A = +25^\circ C$. This data is typical mean test data post radiation exposure at a high dose rate of 50 to 300rad(Si)/s. This data is intended to show typical parameter shifts due to high dose rate radiation. These are not limits nor are they guaranteed.

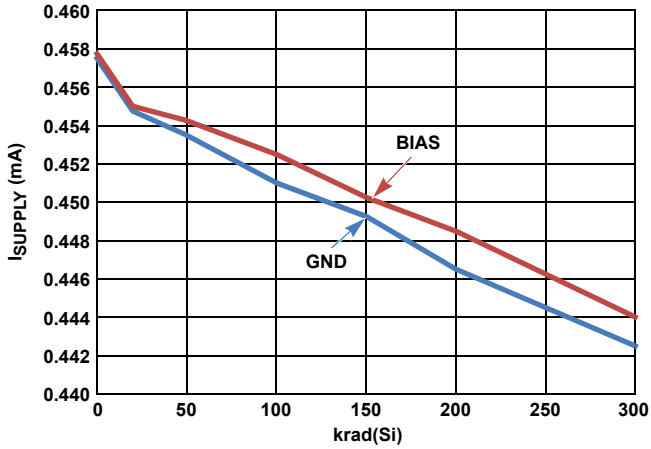

FIGURE 43. SUPPLY CURRENT PER AMP vs HIGH DOSE RATE RADIATION

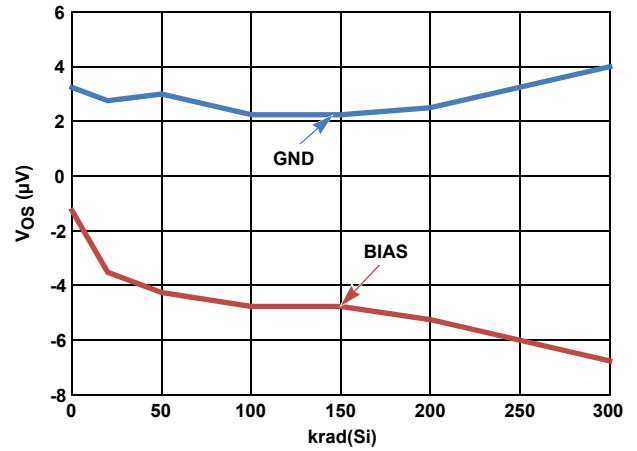

FIGURE 44. V_{OS} vs HIGH DOSE RATE RADIATION

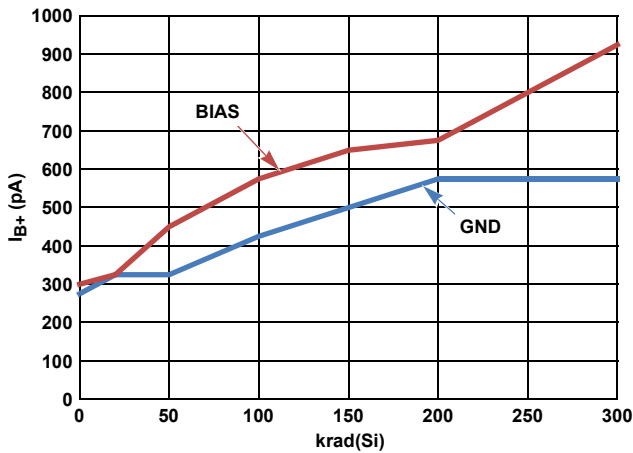

FIGURE 45. I_{B+} vs HIGH DOSE RATE RADIATION

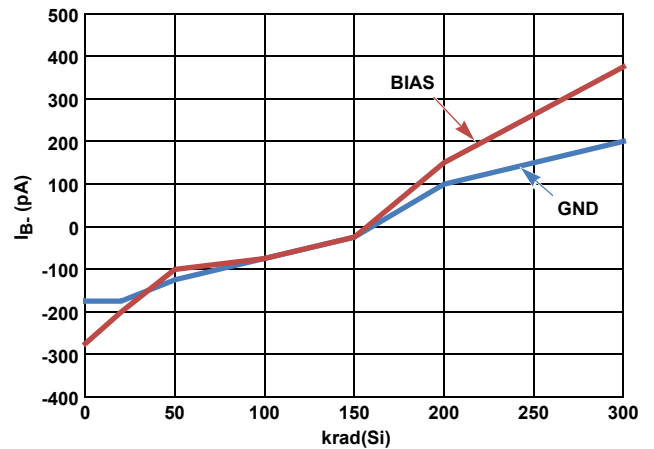

FIGURE 46. I_{B-} vs HIGH DOSE RATE RADIATION

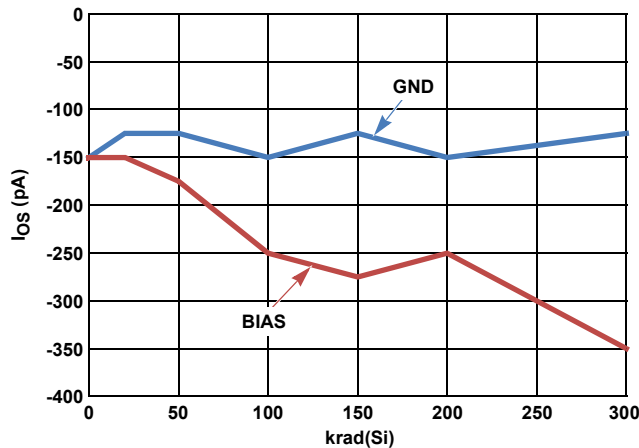

FIGURE 47. I_{OS} vs HIGH DOSE RATE RADIATION

Post Low Dose Radiation Characteristics

Unless otherwise specified, $V_S \pm 15V$, $V_{CM} = 0$, $V_O = 0V$, $T_A = +25^\circ C$. This data is typical mean test data post radiation exposure at a low dose rate of $<10\text{mrad(Si)/s}$. This data is intended to show typical parameter shifts due to low dose rate radiation. These are not limits nor are they guaranteed

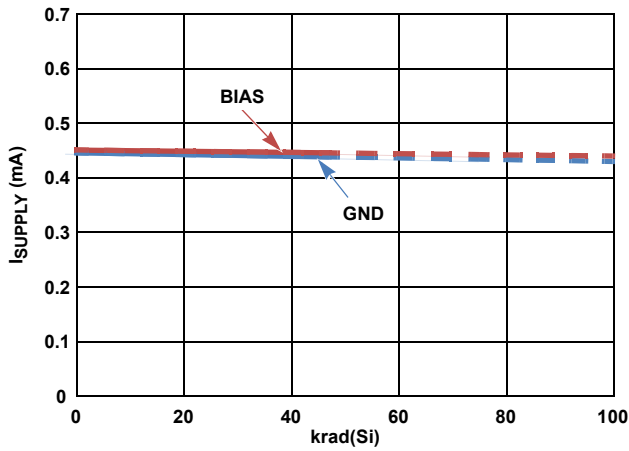

FIGURE 48. SUPPLY CURRENT PER AMP vs LOW DOSE RATE RADIATION

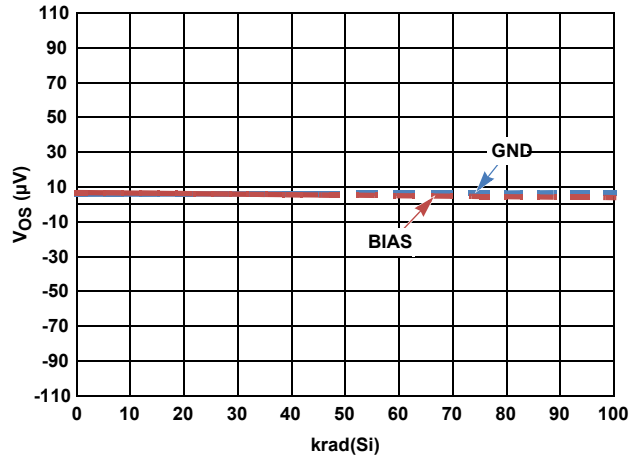

FIGURE 49. V_{OS} vs LOW DOSE RATE RADIATION

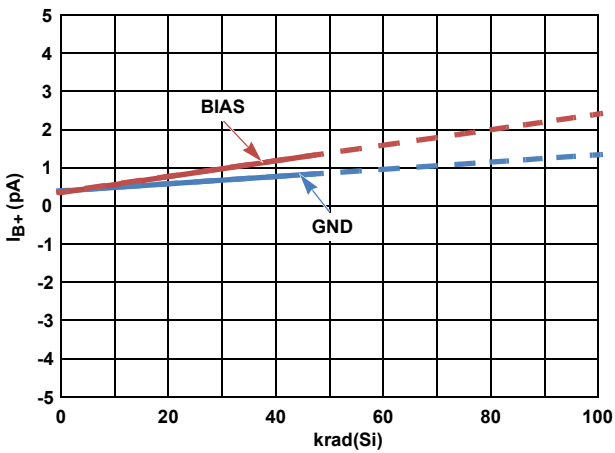

FIGURE 50. I_{B+} vs LOW DOSE RATE RADIATION

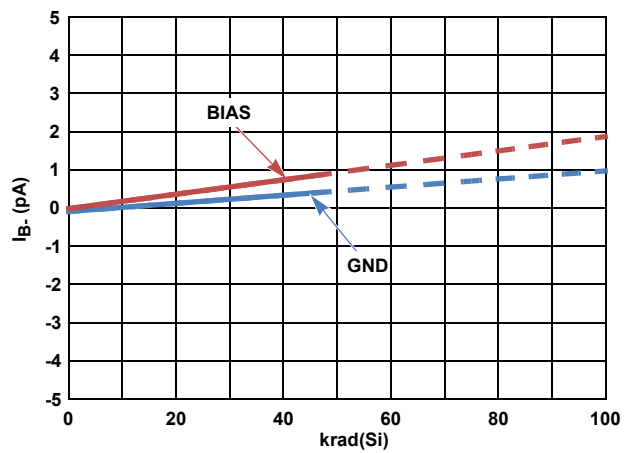

FIGURE 51. I_{B-} vs LOW DOSE RATE RADIATION

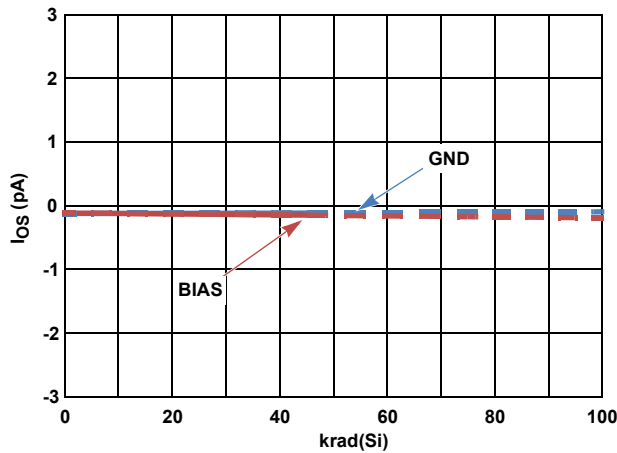

FIGURE 52. I_{OS} vs LOW DOSE RATE RADIATION

Applications Information

Functional Description

The ISL70417SEH contains four low noise precision op amps. These devices are fabricated in a new precision 40V complementary bipolar DI process. A super-beta NPN input stage with input bias current cancellation provides low input bias current (180pA typical), low input offset voltage (13 μ V typical), low input noise voltage (8nV/ $\sqrt{\text{Hz}}$), and low 1/f noise corner frequency (\sim 8Hz). These amplifiers also feature high open loop gain (14kV/mV) for excellent CMRR (145dB) and THD+N performance (0.0005% at 3.5V_{RMS}, 1kHz into 2k Ω). A complementary bipolar output stage enables high capacitive load drive without external compensation.

Operating Voltage Range

The devices are designed to operate over the 4.5V (\pm 2.25V) to 40V (\pm 20V) voltage range and are fully characterized at 10V (\pm 5V) and 30V (\pm 15V). The Power Supply Rejection Ratio (PSRR) typically exceeds 140dB over the full operating voltage range and 120dB minimum across the -55 $^{\circ}$ C to +125 $^{\circ}$ C temperature range. The worst case common-mode input voltage range over temperature is 2V to each rail. With \pm 15V supplies, CMRR performance is typically >130dB over temperature. The minimum CMRR performance across the -55 $^{\circ}$ C to +125 $^{\circ}$ C temperature range is >120dB for power supply voltages from \pm 5V (10V) to \pm 15V (30V).

Input Performance

The super-beta NPN input pair provides excellent frequency response while maintaining high input precision. High NPN beta (>1000) reduces input bias current while maintaining good frequency response, low input bias current and low noise. Input bias cancellation circuits provide additional bias current reduction to <5nA, and excellent temperature stabilization. [Figures 6 through 8 on page 8](#) show the high degree of bias current stability at \pm 5V and \pm 15V supplies that is maintained across the -55 $^{\circ}$ C to +125 $^{\circ}$ C temperature range. The low bias current TC also produces very low input offset current TC, which reduces DC input offset errors in precision, high impedance amplifiers.

The +25 $^{\circ}$ C maximum input offset voltage (V_{OS}) is 75 μ V at \pm 15V supplies. Input offset voltage temperature coefficients (V_{OSTC}) is a maximum of \pm 1.0 μ V/ $^{\circ}$ C. The V_{OS} temperature behavior is smooth ([Figures 3 and 4 on page 8](#)) maintaining constant TC across the entire temperature range.

Input ESD Diode Protection

The input terminals (IN+ and IN-) have internal ESD protection diodes to the positive and negative supply rails, series connected 500 Ω current limiting resistors and an anti-parallel diode pair across the inputs ([Figure 53](#)).

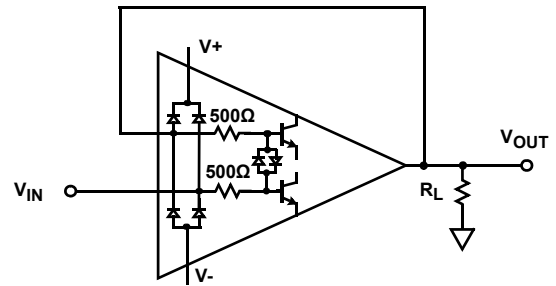

FIGURE 53. INPUT ESD DIODE CURRENT LIMITING - UNITY GAIN

The series resistors limit the high feed-through currents that can occur in pulse applications when the input dV/dt exceeds the 0.5V/ μ s slew rate of the amplifier. Without the series resistors, the input can forward-bias the anti-parallel diodes causing current to flow to the output resulting in severe distortion and possible diode failure.

[Figure 36 on page 13](#) provides an example of distortion free large signal response using a 4V_{P-P} input pulse with an input rise time of <1ns. The series resistors enable the input differential voltage to be equal to the maximum power supply voltage (40V) without damage.

In applications where one or both amplifier input terminals are at risk of exposure to high voltages beyond the power supply rails, current limiting resistors may be needed at the input terminal to limit the current through the power supply ESD diodes to 20mA maximum.

Output Current Limiting

The output current is internally limited to approximately \pm 45mA at +25 $^{\circ}$ C and can withstand a short-circuit to either rail as long as the power dissipation limits are not exceeded. This applies to only 1 amplifier at a time for the quad op amp. Continuous operation under these conditions may degrade long term reliability. [Figures 15 and 16 on page 10](#) show the current limit variation with temperature.

Output Phase Reversal

Output phase reversal is a change of polarity in the amplifier transfer function when the input voltage exceeds the supply voltage. The ISL70417SEH is immune to output phase reversal, even when the input voltage is 1V beyond the supplies.

Power Dissipation

It is possible to exceed the +150°C maximum junction temperatures under certain load and power supply conditions. It is therefore important to calculate the maximum junction temperature (T_{JMAX}) for all applications to determine if power supply voltages, load conditions, or package type need to be modified to remain in the safe operating area. These parameters are related using [Equation 1](#):

$$T_{JMAX} = T_{MAX} + \theta_{JA} \times P_{D_{MAXTOTAL}} \quad (\text{EQ. 1})$$

where:

- $P_{D_{MAXTOTAL}}$ is the sum of the maximum power dissipation of each amplifier in the package ($P_{D_{MAX}}$).

- $P_{D_{MAX}}$ for each amplifier can be calculated using [Equation 2](#):

$$P_{D_{MAX}} = V_S \times I_{q_{MAX}} + (V_S - V_{OUTMAX}) \times \frac{V_{OUTMAX}}{R_L} \quad (\text{EQ. 2})$$

where:

- T_{MAX} = Maximum ambient temperature
- θ_{JA} = Thermal resistance of the package
- $P_{D_{MAX}}$ = Maximum power dissipation of 1 amplifier
- V_S = Total supply voltage
- $I_{q_{MAX}}$ = Maximum quiescent supply current of 1 amplifier
- V_{OUTMAX} = Maximum output voltage swing of the application

Package Characteristics

Weight of Packaged Device

0.6043 Grams (typical)

Lid Characteristics

Finish: Gold

Potential: Unbiased

Case Isolation to Any Lead: $20 \times 10^9 \Omega$ (minimum)

Die Characteristics

Die Dimensions

2028 μm x 2568 μm (80 mils x 101 mils)

Thickness: 483 μm \pm 25 μm (19 mils \pm 1 mil)

Interface Materials

GLASSIVATION

Type: Nitrox

Thickness: 15kÅ

TOP METALLIZATION

Type: AlCu (99.5%/0.5%)

Thickness: 30kÅ

BACKSIDE FINISH

Silicon

PROCESS

Dielectrically Isolated Complementary Bipolar - PR40

ASSEMBLY RELATED INFORMATION

SUBSTRATE POTENTIAL

Floating

ADDITIONAL INFORMATION

WORST CASE CURRENT DENSITY

$< 2 \times 10^5 \text{ A/cm}^2$

Metallization Mask Layout

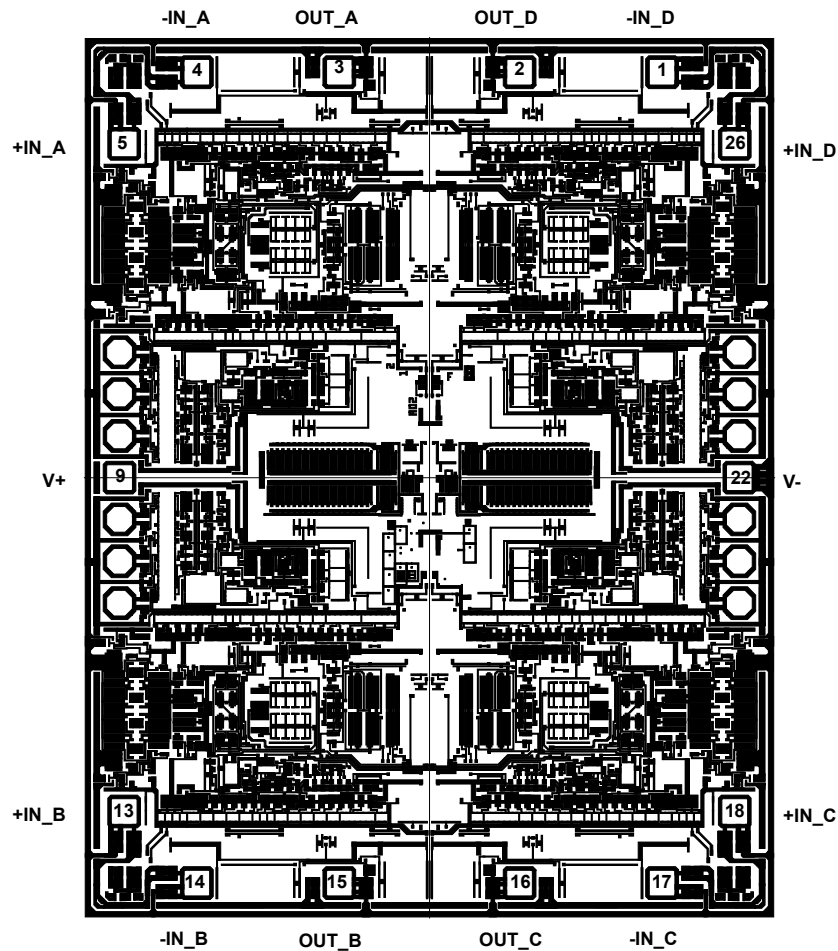

TABLE 1. DIE LAYOUT X-Y COORDINATES

PAD NAME	PAD NUMBER	X (μm)	Y (μm)	dX (μm)	dY (μm)	BOND WIRES PER PAD
OUT_A	3	-256	1152	70	70	1
-IN_A	4	-661	1152	70	70	1
+IN_A	5	-867.5	948.5	70	70	1
V+	9	-880.5	0	70	70	1
+IN_B	13	-867.5	-948.5	70	70	1
-IN_B	14	-661	-1152	70	70	1
OUT_B	15	-256	-1152	70	70	1
OUT_C	16	256	-1152	70	70	1
-IN_C	17	661	-1152	70	70	1
+IN_C	18	867.5	-948.5	70	70	1
V-	22	880.5	0	70	70	1
+IN_D	26	867.5	948.5	70	70	1
-IN_D	1	661	1152	70	70	1
OUT_D	2	256	1152	70	70	1

NOTE:

8. Origin of coordinates is the center of die.

Revision History

The revision history provided is for informational purposes only and is believed to be accurate, but not warranted. Please go to web to make sure you have the latest Revision.

DATE	REVISION	CHANGE
Oct 24, 2019	FN7962.5	Updated links throughout. Updated Related Literature. Added Notes 3 and 4. Updated temperature for /SAMPLE in ordering information table. Updated Figures 39 and 40. Removed About Intersil section. Updated disclaimer.
Jul 20, 2016	FN7962.4	Updated to tighten the IOS post radiation spec from $\pm 10\text{nA}$ to $\pm 6\text{nA}$. SMD was updated with this change on 5/18/2016.
Jan 11, 2016	FN7962.3	Page 4 Electrical Spec table: V_{OS} - changed MAX from 75 to 85 I_B - 1st row, changed MIN/MAX from: MIN -1/MAX 1 to: MIN -2.5/MAX 2.5 2nd row, added Test Conditions $T_A = -55^\circ\text{C}$, $+125^\circ\text{C}$ and unbolded MIN/MAX values Added 3rd row, Test Conditions $T_A = +25^\circ\text{C}$, post radiation and MIN -1.5 MAX 1.5 I_{OS} - 1st row, changed MIN/MAX from: MIN -1.5/MAX 1.5 to: MIN -2.5/MAX 2.5 2nd row, added Test Conditions $T_A = -55^\circ\text{C}$, $+125^\circ\text{C}$ and unbolded MIN/MAX values Added row, Test Conditions $T_A = +25^\circ\text{C}$, post radiation and MIN -1.5 MAX 1.5 Page 6 Electrical Spec table: I_B - 1st row, changed MIN/MAX from: MIN -1/MAX 1 to: MIN -2.5/MAX 2.5 2nd row, added Test Conditions $T_A = -55^\circ\text{C}$, $+125^\circ\text{C}$ and unbolded MIN/MAX values Added 3rd row, Test Conditions $T_A = +25^\circ\text{C}$, post radiation and MIN -1.5 MAX 1.5 I_{OS} - 1st row, changed MIN/MAX from: MIN -1.5/MAX 1.5 to: MIN -2.5/MAX 2.5 2nd row, added Test Conditions $T_A = -55^\circ\text{C}$, $+125^\circ\text{C}$ and unbolded MIN/MAX values Added row, Test Conditions $T_A = +25^\circ\text{C}$, post radiation and MIN -1.5 MAX 1.5 Page 13 - corrected x-axis on Figure 33 from: 10Hz to 10MHz to: 10Hz to 100MHz
Jul 24, 2014	FN7962.2	Updated Features bullet on page 1 as follows: From: <ul style="list-style-type: none"> - SEL/SEB LET_{TH} ($V_S = \pm 20\text{V}$) 73.9 MeV • cm²/mg - Total Dose, High Dose Rate 300krad(Si) - Total Dose, Low Dose Rate 100krad(Si) * To: <ul style="list-style-type: none"> - SEB LET_{TH} ($V_S = \pm 20\text{V}$) 73.9 MeV • cm²/mg - Total dose, high dose rate 300krad(Si) - Total dose, low dose rate 100krad(Si) * - SEL immune (SOI process) Updated the Ordering Information table on page 2 as follows: Removed MSL and added SMD note. Changed Products verbiage to About Intersil verbiage.
Oct 4, 2012	FN7962.1	SMD numbers in Ordering Information table corrected. changed from: 5962R1222801VXC 5962R1222801V9AX to: 5962F1222801VXC 5962F1222801V9AX
Jul 2, 2012	FN7962.0	Initial Release

Package Outline Drawing

For the most recent package outline drawing, see [K14.A](#).

Ceramic Metal Seal Flatpack Packages (Flatpack)

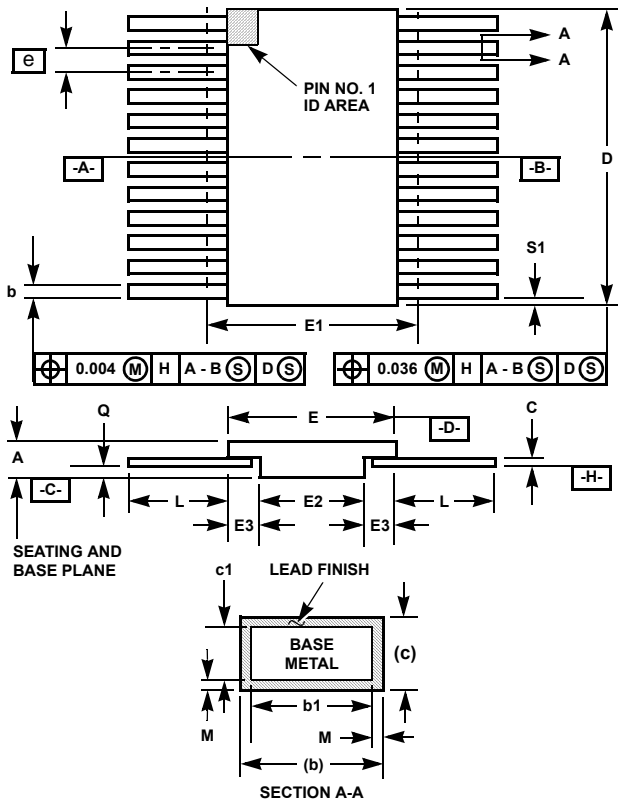

**K14.A MIL-STD-1835 CDFP3-F14 (F-2A, CONFIGURATION B)
14 LEAD CERAMIC METAL SEAL FLATPACK PACKAGE**

SYMBOL	INCHES		MILLIMETERS		NOTES
	MIN	MAX	MIN	MAX	
A	0.045	0.115	1.14	2.92	-
b	0.015	0.022	0.38	0.56	-
b1	0.015	0.019	0.38	0.48	-
c	0.004	0.009	0.10	0.23	-
c1	0.004	0.006	0.10	0.15	-
D	-	0.390	-	9.91	3
E	0.235	0.260	5.97	6.60	-
E1	-	0.290	-	7.11	3
E2	0.125	-	3.18	-	-
E3	0.030	-	0.76	-	7
e	0.050 BSC		1.27 BSC		-
k	0.008	0.015	0.20	0.38	2
L	0.270	0.370	6.86	9.40	-
Q	0.026	0.045	0.66	1.14	8
S1	0.005	-	0.13	-	6
M	-	0.0015	-	0.04	-
N	14		14		-

Rev. 0 5/18/94

NOTES:

1. Index area: A notch or a pin one identification mark shall be located adjacent to pin one and shall be located within the shaded area shown. The manufacturer's identification shall not be used as a pin one identification mark. Alternately, a tab (dimension k) may be used to identify pin one.
2. If a pin one identification mark is used in addition to a tab, the limits of dimension k do not apply.
3. This dimension allows for off-center lid, meniscus, and glass overrun.
4. Dimensions b1 and c1 apply to lead base metal only. Dimension M applies to lead plating and finish thickness. The maximum limits of lead dimensions b and c or M shall be measured at the centroid of the finished lead surfaces, when solder dip or tin plate lead finish is applied.
5. N is the maximum number of terminal positions.
6. Measure dimension S1 at all four corners.
7. For bottom-brazed lead packages, no organic or polymeric materials shall be molded to the bottom of the package to cover the leads.
8. Dimension Q shall be measured at the point of exit (beyond the meniscus) of the lead from the body. Dimension Q minimum shall be reduced by 0.0015 inch (0.038mm) maximum when solder dip lead finish is applied.
9. Dimensioning and tolerancing per ANSI Y14.5M - 1982.
10. Controlling dimension: INCH.

Notice

1. Descriptions of circuits, software and other related information in this document are provided only to illustrate the operation of semiconductor products and application examples. You are fully responsible for the incorporation or any other use of the circuits, software, and information in the design of your product or system. Renesas Electronics disclaims any and all liability for any losses and damages incurred by you or third parties arising from the use of these circuits, software, or information.
 2. Renesas Electronics hereby expressly disclaims any warranties against and liability for infringement or any other claims involving patents, copyrights, or other intellectual property rights of third parties, by or arising from the use of Renesas Electronics products or technical information described in this document, including but not limited to, the product data, drawings, charts, programs, algorithms, and application examples.
 3. No license, express, implied or otherwise, is granted hereby under any patents, copyrights or other intellectual property rights of Renesas Electronics or others.
 4. You shall not alter, modify, copy, or reverse engineer any Renesas Electronics product, whether in whole or in part. Renesas Electronics disclaims any and all liability for any losses or damages incurred by you or third parties arising from such alteration, modification, copying or reverse engineering.
 5. Renesas Electronics products are classified according to the following two quality grades: "Standard" and "High Quality". The intended applications for each Renesas Electronics product depends on the product's quality grade, as indicated below.
 - "Standard": Computers; office equipment; communications equipment; test and measurement equipment; audio and visual equipment; home electronic appliances; machine tools; personal electronic equipment; industrial robots; etc.
 - "High Quality": Transportation equipment (automobiles, trains, ships, etc.); traffic control (traffic lights); large-scale communication equipment; key financial terminal systems; safety control equipment; etc.Unless expressly designated as a high reliability product or a product for harsh environments in a Renesas Electronics data sheet or other Renesas Electronics document, Renesas Electronics products are not intended or authorized for use in products or systems that may pose a direct threat to human life or bodily injury (artificial life support devices or systems; surgical implantations; etc.), or may cause serious property damage (space system; undersea repeaters; nuclear power control systems; aircraft control systems; key plant systems; military equipment; etc.). Renesas Electronics disclaims any and all liability for any damages or losses incurred by you or any third parties arising from the use of any Renesas Electronics product that is inconsistent with any Renesas Electronics data sheet, user's manual or other Renesas Electronics document.
 6. When using Renesas Electronics products, refer to the latest product information (data sheets, user's manuals, application notes, "General Notes for Handling and Using Semiconductor Devices" in the reliability handbook, etc.), and ensure that usage conditions are within the ranges specified by Renesas Electronics with respect to maximum ratings, operating power supply voltage range, heat dissipation characteristics, installation, etc. Renesas Electronics disclaims any and all liability for any malfunctions, failure or accident arising out of the use of Renesas Electronics products outside of such specified ranges.
 7. Although Renesas Electronics endeavors to improve the quality and reliability of Renesas Electronics products, semiconductor products have specific characteristics, such as the occurrence of failure at a certain rate and malfunctions under certain use conditions. Unless designated as a high reliability product or a product for harsh environments in a Renesas Electronics data sheet or other Renesas Electronics document, Renesas Electronics products are not subject to radiation resistance design. You are responsible for implementing safety measures to guard against the possibility of bodily injury, injury or damage caused by fire, and/or danger to the public in the event of a failure or malfunction of Renesas Electronics products, such as safety design for hardware and software, including but not limited to redundancy, fire control and malfunction prevention, appropriate treatment for aging degradation or any other appropriate measures. Because the evaluation of microcomputer software alone is very difficult and impractical, you are responsible for evaluating the safety of the final products or systems manufactured by you.
 8. Please contact a Renesas Electronics sales office for details as to environmental matters such as the environmental compatibility of each Renesas Electronics product. You are responsible for carefully and sufficiently investigating applicable laws and regulations that regulate the inclusion or use of controlled substances, including without limitation, the EU RoHS Directive, and using Renesas Electronics products in compliance with all these applicable laws and regulations. Renesas Electronics disclaims any and all liability for damages or losses occurring as a result of your noncompliance with applicable laws and regulations.
 9. Renesas Electronics products and technologies shall not be used for or incorporated into any products or systems whose manufacture, use, or sale is prohibited under any applicable domestic or foreign laws or regulations. You shall comply with any applicable export control laws and regulations promulgated and administered by the governments of any countries asserting jurisdiction over the parties or transactions.
 10. It is the responsibility of the buyer or distributor of Renesas Electronics products, or any other party who distributes, disposes of, or otherwise sells or transfers the product to a third party, to notify such third party in advance of the contents and conditions set forth in this document.
 11. This document shall not be reprinted, reproduced or duplicated in any form, in whole or in part, without prior written consent of Renesas Electronics.
 12. Please contact a Renesas Electronics sales office if you have any questions regarding the information contained in this document or Renesas Electronics products.
- (Note1) "Renesas Electronics" as used in this document means Renesas Electronics Corporation and also includes its directly or indirectly controlled subsidiaries.
- (Note2) "Renesas Electronics product(s)" means any product developed or manufactured by or for Renesas Electronics.

(Rev.4.0-1 November 2017)

Corporate Headquarters

TOYOSU FORESIA, 3-2-24 Toyosu,
Koto-ku, Tokyo 135-0061, Japan
www.renesas.com

Contact Information

For further information on a product, technology, the most up-to-date version of a document, or your nearest sales office, please visit:
www.renesas.com/contact/

Trademarks

Renesas and the Renesas logo are trademarks of Renesas Electronics Corporation. All trademarks and registered trademarks are the property of their respective owners.