

F2912

High Reliability SP2T RF Switch

The F2912 is a high reliability, low insertion loss, 50Ω SP2T absorptive RF switch designed for a multitude of wireless and other RF applications. This device covers a broad frequency range from 9kHz to 9000MHz. In addition to providing low insertion loss, the F2912 also delivers excellent linearity and isolation performance while providing a 50Ω termination to the unused RF input port.

The F2912 uses a single positive supply voltage of 3.3V supporting three states using either 3.3V or 1.8V user-selectable control voltage. An added feature includes a Mode CTL pin allowing the user to control the device with either 1-pin or 2-pin control.

Competitive Advantage

The F2912 provides extremely low insertion loss; particularly important for RF receiver front-end use.

- ✓ Insertion Loss : 0.4dB at 1GHz
- ✓ IIP3: +66dBm
- ✓ RF1 to RF2 Isolation: 74dB at 1GHz
- ✓ Negative supply voltage not required
- ✓ Extended temperature -55°C to +125°C

Features

- Very low insertion loss: 0.4dB at 1GHz
- High Input IP3: +66dBm
- RF1 to RF2 Isolation: 74dB at 1GHz
- 1-pin or 2-pin device control option
- Low DC current; 20μA using 3.3V logic
- Single positive supply voltage: 3.3V
- 3.3V or 1.8V user-selectable control logic
- Operating temperature -55°C to +125°C
- 4 x 4 mm 20-VFQFPN package

Applications

- Base Station 2G, 3G, 4G
- Portable Wireless
- Repeaters and E911 systems
- Digital Pre-Distortion
- Point to Point Infrastructure
- Public Safety Infrastructure
- WIMAX Receivers and Transmitters
- Military Systems, JTRS radios
- RFID handheld and portable readers
- Cable Infrastructure
- Wireless LAN
- Test / ATE Equipment

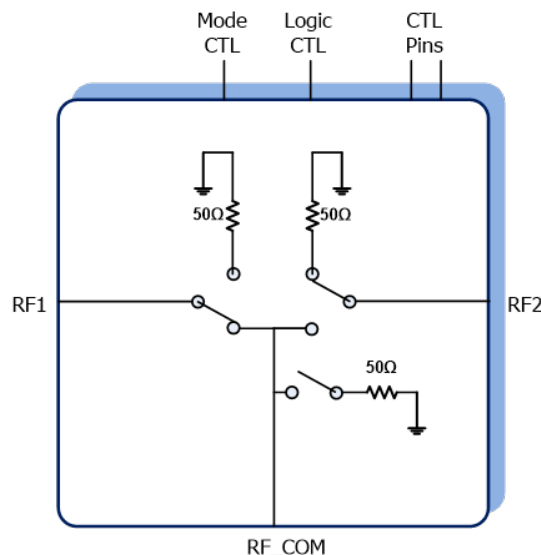

Figure 1. Functional Block Diagram

Contents

1. Pin Information	3
1.1 Pin Assignments	3
1.2 Pin Descriptions	3
2. Specifications	4
2.1 Absolute Maximum Ratings	4
2.2 Thermal Specifications and Moisture Characteristics	4
2.3 Recommended Operating Conditions	5
2.4 Electrical Specifications	5
2.5 Control Modes	8
3. Typical Operating Conditions (TOC)	9
3.1 Typical Operating Conditions (1)	10
3.2 Typical Operating Conditions (2)	11
3.3 Typical Operating Conditions (3)	12
3.4 Typical Operating Conditions (4)	13
3.5 Typical Operating Conditions (5)	14
3.6 Typical Operating Conditions (6)	15
3.7 Typical Operating Conditions Histograms [N = 4800, T _{case} = 25°C]	16
4. Application Information	17
4.1 Default Start-up	17
4.2 Power Supplies	17
4.3 Control Pin Interface	17
4.4 Pin Compatibility	17
5. EVKit Operation	18
5.1 EVKit Picture (top)	18
5.2 EvKit Picture (bottom)	20
5.3 EVkit / Applications Circuit	21
5.4 EVKit BOM	21
6. Package Outline Drawings	22
7. Ordering Information	22
8. Revision History	22

1. Pin Information

1.1 Pin Assignments

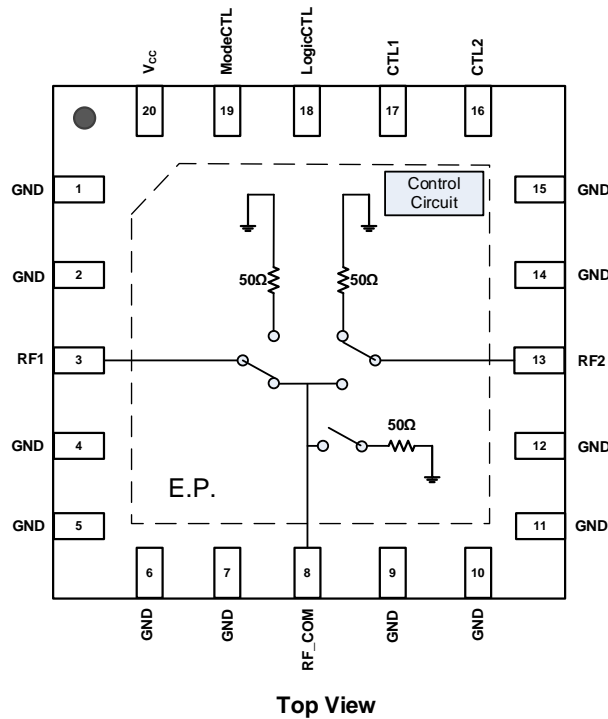

1.2 Pin Descriptions

Pin Number	Pin Name	Description
1, 2, 4, 5, 6, 7, 9, 10, 11, 12, 14, 15	GND	Ground these pins as close to the device as possible.
3	RF1	RF1 Port. Matched to 50Ω. If this pin is not 0 V DC, then an external coupling capacitor must be used.
8	RF_COM	RF Common Port. Matched to 50Ω. If this pin is not 0 V DC, then an external coupling capacitor must be used.
13	RF2	RF2 Port. Matched to 50Ω. If this pin is not 0 V DC, then an external coupling capacitor must be used.
16	CTL2	Control 2 – See Table 1 and Table 2 Switch Control Truth Tables for proper logic setting.
17	CTL1	Control 1 – See Table 1 and Table 2 Switch Control Truth Tables for proper logic setting.
18	LogicCTL	Logic Control – See Table 4 Logic Control Truth Table. Apply V _{CC} to select 1.8 V logic control or GND for 3.3 V logic control.
19	ModeCTL	Mode Control – See Table 3 Mode Control Truth Table. Apply V _{CC} to select 1-pin control or GND for 2-pin control.
20	V _{CC}	Power Supply. Bypass to GND with capacitors shown in the Typical Application Circuit as close as possible to pin.
21	— EP	Exposed Pad. Internally connected to GND. Solder this exposed pad to a PCB pad that uses multiple ground vias to provide heat transfer out of the device into the PCB ground planes. These multiple via grounds are also required to achieve the specified RF performance.

2. Specifications

2.1 Absolute Maximum Ratings

Parameter	Symbol	Min	Max	Units
VCC to GND	V _{CC}	-0.3	+3.9	V
CTL1, CTL2, LogicCTL	V _{CNTL}	-0.3	V _{CC} + 0.3	V
RF1, RF2, RF_Com	V _{RF}	-0.3	+0.3	V
Maximum Junction Temperature	T _{Jmax}		+140	°C
Storage Temperature Range	T _{ST}	-65	+150	°C
Lead Temperature (soldering, 10s)	T _{LEAD}		+260	°C
ElectroStatic Discharge – HBM (JEDEC/ESDA JS-001-2012)	V _{ESDHBM}		Class 2 (2000)	V
ElectroStatic Discharge – CDM (JEDEC 22-C101F)	V _{ESDCDM}		Class IV (1500)	V

RF Power For Case Temperatures up to +85°C*

RF1, RF2 (RF1 or RF2 is connected to RF_COM, State 3 and 2)	+33 dBm
RF1, RF2 (RF1 or RF2 is NOT connected to RF_COM, State 1, 2 and 3)	+24 dBm
RF_COM (RF_COM port is NOT connected to RF1 or RF2, State 1)	+24 dBm

RF Power For Case Temperatures up to +105 °C*

RF1, RF2 (RF1 or RF2 is connected to RF_COM, State 3 and 2)	+33 dBm
RF1, RF2 (RF1 or RF2 is NOT connected to RF_COM, State 1, 2 and 3)	+21 dBm
RF_COM (RF_COM port is NOT connected to RF1 or RF2, State 1)	+21 dBm

RF Power For Case Temperatures up to +120 °C*

RF1, RF2 (RF1 or RF2 is connected to RF_COM, State 3 and 2)	+27 dBm
RF1, RF2 (RF1 or RF2 is NOT connected to RF_COM, State 1, 2 and 3)	+18 dBm
RF_COM (RF_COM port is NOT connected to RF1 or RF2, State 1)	+18 dBm

* Note: These Absolute Maximum RF power limits are reduced if the RF frequency is lower than 400MHz.

Stresses above those listed above may cause permanent damage to the device. Functional operation of the device at these or any other conditions above those indicated in the operational section of this specification is not implied. Exposure to absolute maximum rating conditions for extended periods may affect device reliability.

2.2 Thermal Specifications and Moisture Characteristics

Thermal Resistance (Typical)	θ_{JA} (°C/W) [1]	θ_{JC} (°C/W) [2]
20-TQFN package	60	3.9
Moisture Sensitivity Rating (Per J-STD-020): MSL1	-	-

2.3 Recommended Operating Conditions

Parameter	Symbol	Conditions	Min	Typ	Max	Units
Supply Voltage	V_{CC}	Using 3.3V logic (Pin 18 low)	2.7		3.6	V
		Using 1.8V logic (Pin 18 high)	3.15		3.45	
Operating Temperature Range	T_{CASE}	Case Temperature	-55		+125	°C
RF Frequency Range	F_{RF}		0.009		9000	MHz
RF1 Port Impedance	Z_{RF1}			50		Ω
RF2 Port Impedance	Z_{RF2}			50		
RF_COM Port Impedance	Z_{RF_COM}			50		

2.4 Electrical Specifications

Typical Application Circuit, $V_{CC} = +3.3V$, $T_C = +25^\circ C$, $F_{RF} = 1GHz, 2GHz$, and or $4GHz$ as noted below. Input power = $0dBm$ or $+13dBm/$ tone unless otherwise stated. PCB board trace and connector losses are de-embedded unless otherwise noted.

Parameter	Symbol	Conditions	Min	Typ	Max	Units
Logic Input High Threshold	V_{IH}	For all control pins Pin 18 low for 3.3V logic	0.7 x V_{CC}		3.6	V
		For all control pins Pin 18 high for 1.8V logic	1.1 ^[1]		2	
Logic Input Low Threshold	V_{IL}	For all control pins Pin 18 low for 3.3V logic			0.3 x V_{CC}	V
		For all control pins Pin 18 high for 1.8V logic			0.63	V
Logic Current	I_{IH}, I_{IL}	For all control pins		180	500	nA
DC Current	I_{CC}	Pin 18 low for 3.3V logic		20	25	μA
		Pin 18 high for 1.8V logic		126	153	
Insertion Loss RF1/RF2 to RF_COM (State 2 or 3)	IL	RF = 1.0GHz		0.4	0.6	dB
		RF = 2.0GHz		0.5	0.7	
		RF = 4.0GHz		0.6	0.8	
		RF = 6.0GHz		0.61	0.9 ^[2]	
		RF = 8.1GHz		0.81	1.0	
		RF = 9.0GHz		1.00	1.4	

Parameter	Symbol	Conditions	Min	Typ	Max	Units
Isolation RF1 / RF2 to RF_COM (State 2 or 3)	ISO ₁	RF = 1.0GHz	58	61.5		dB
		RF = 2.0GHz	52	57		
		RF = 4.0GHz	50	52		
		RF = 6.0GHz	45	53		
		RF = 8.1GHz	30	33		
		RF = 9.0GHz	26	29		
Isolation RF1 to RF2 (State 2 or 3)	ISO ₂	RF = 1.0GHz	71	74		dB
		RF = 2.0GHz	60	62		
		RF = 4.0GHz	46	47		
		RF = 6.0GHz	36	38		
		RF = 8.1GHz	27	31		
		RF = 9.0GHz	23	27		
Return Loss RF_COM (State 1)	RL ₁	RF = 1.0GHz		27		dB
		RF = 2.0GHz		24		
		RF = 4.0GHz		20		
		RF = 6.0GHz		12		
		RF = 8.1GHz		11		
		RF = 9.0GHz		9		
Return Loss RF_COM (State 2 or 3)	RL ₂	RF = 1.0GHz		25		dB
		RF = 2.0GHz		23		
		RF = 4.0GHz		26		
		RF = 6.0GHz		18		
		RF = 8.1GHz		20		
		RF = 9.0GHz		15		
Return Loss RF1, RF2 (State 1)	RL ₃	RF = 1.0GHz		27		dB
		RF = 2.0GHz		27		
		RF = 4.0GHz		20		
		RF = 6.0GHz		18		
		RF = 8.1GHz		14		
		RF = 9.0GHz		10		

Parameter	Symbol	Conditions	Min	Typ	Max	Units
Return Loss RF1, RF2 (State 2 or 3)	RL ₄	RF = 1.0GHz		26		dB
		RF = 2.0GHz		25		
		RF = 4.0GHz		21		
		RF = 6.0GHz		17		
		RF = 8.1GHz		14		
		RF = 9.0GHz		10		
Input IP2 RF1 / RF2 (State 2 or 3)	IIP2	RF = 1.0GHz		102		dBm
		RF = 2.0GHz		110		
		RF = 3.0GHz		110		
Input IP3 RF1 / RF2 (State 2 or 3)	IIP3	RF = 1.0GHz		66		dBm
		RF = 2.0GHz		64		
		RF = 3.0GHz		64		
Input 1dB compression RF1 / RF2 (State 2 or 3) ^[3]	IP1dB	F _{RF} = 2.0GHz	29	30		dBm
Switching Time	T _{SW}	RF = 1.0GHz 50% control to 90% RF		1.1		μs
		RF = 1GHz 50% control to 10% RF		0.5		
Maximum Switching Frequency	SW _{FREQ}			25		kHz
Maximum video feed-through RF_COM port	VIDFT	5MHz to 1GHz Measured with 2.5ns risetime, 0 to 3.3V control pulse		5		mV _{pp}
Maximum spurious level on any RF port ^[4]	Spur _{MAX}	RF ports terminated into 50Ω		-145		dBm

1. Items in min/max columns in **bold italics** are confirmed by test.
2. Items in min/max columns that are not bold/italics are confirmed by Design Characterization.
3. The input 1dB compression point is a linearity figure of merit. Refer to Absolute Maximum Ratings section for the maximum RF input power.
4. Spurious due to on-chip negative voltage generator. Typical generator fundamental frequency is 2.2MHz.

2.5 Control Modes

The F2912 switch states are designed to be controlled by using either a 2-pin logic control (see Table 1) or a 1-pin logic control (see Table 2). Table 3 describes the settings to enable one or two pin control. The F2912 also has the ability to be controlled by 3V or 1.8V control logic based on the setting of Pin 18 (see Table 4). See Pin Compatibility in the Applications Information section for more details.

Table 1. Switch Control Truth Table for 2-Pin Logic Control (ModeCTL = GND)

State	Control pin input		RF1, RF2 Input / Output	
	CTL1 (Pin 17)	CTL2 (Pin 16)	RF1 to RF Com	RF2 to RF Com
1	Low	Low	OFF	OFF
2	Low	High	OFF	ON
3	High	Low	ON	OFF
4 ^[1]	High	High	N/A	N/A

1. CTRL1 = High and CTRL2 = High is an unsupported switch state.

Table 2. Switch Control Truth Table for 1-Pin Logic Control (ModeCTL = VCC)

State	Control pin input		RF1, RF2 Input / Output	
	CTL1 (Pin 17)	CTL2 (Pin 16)	RF1 to RF Com	RF2 to RF Com
2	Don't Care	High	OFF	ON
3	Don't Care	Low	ON	OFF

Table 3. Mode Control Truth Table to Set for 1 or 2 pin Logic Control

ModeCTL (Pin 19)	Pin Control Mode
GND	2-pin control: CTL1 and CTL2
VCC	1-pin control: CTL2

Notes:

1. When RF1 and RF2 ports are both open (State 1), all 3 RF ports are terminated to an internal 50Ω termination resistor.
2. When RF1 or RF2 port is open (State 2 or State 3 OFF condition), the open port is connected to an internal 50Ω termination resistor.
3. When RF1 or RF2 port is closed (State 2 or State 3 ON condition), the closed port is connected to the RF Com port.

Table 4. Logic Control (pin 18) Truth Table

LogicCTL (Pin 18)	Logic Voltage
VCC	1.8 V
GND	3.3 V

3. Typical Operating Conditions (TOC)

Unless otherwise noted for the Typical Operating Conditions graphs on the following pages, the following conditions apply.

1. EVKit connector and trace losses de-embedded
2. $V_{CC} = 3.3V$
3. $T_{AMB} = 25^{\circ}C$
4. Small signal parameters measured with $PIN = 0dBm$
5. Two tone tests $PIN = +13 dBm/$ tone with 50MHz tone spacing for $FRF > 500MHz$
6. $Z_S = Z_L = 50\Omega$

3.1 Typical Operating Conditions (1)

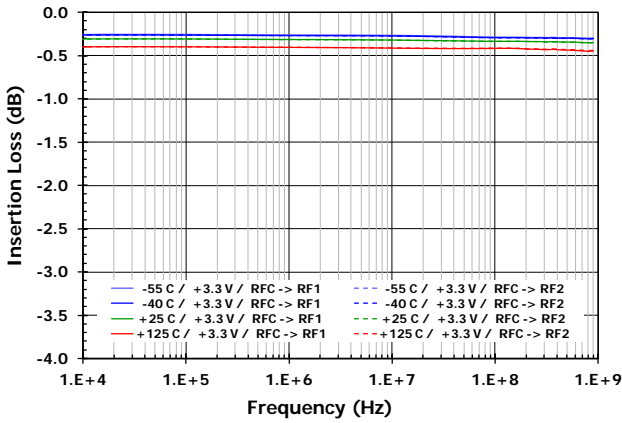

Figure 2. Insertion Loss vs. Temperature

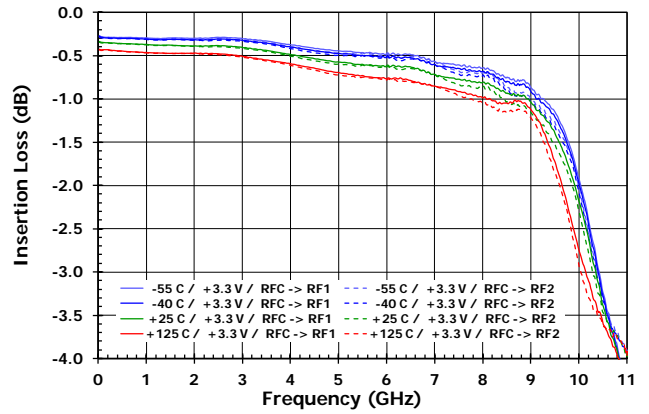

Figure 3. Insertion Loss vs. Temperature

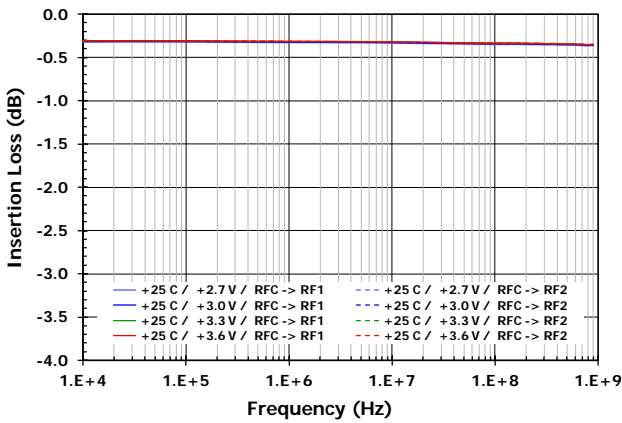

Figure 4. Insertion Loss vs. Voltage

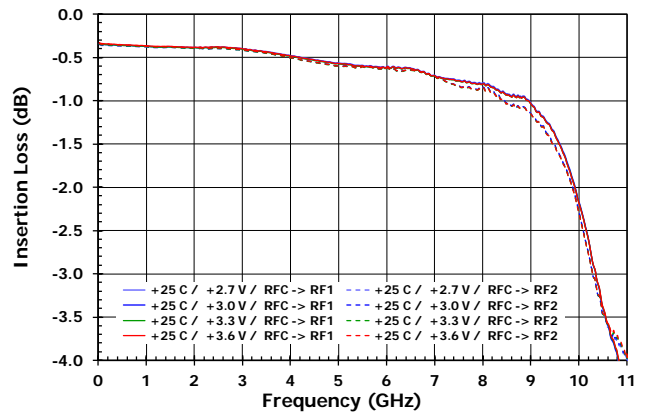

Figure 5. Insertion Loss vs. Voltage

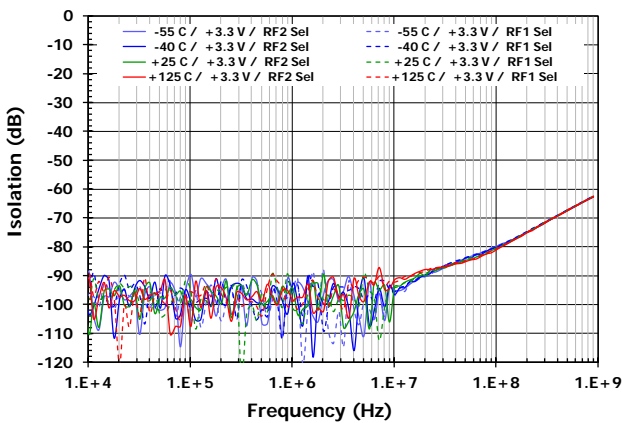

Figure 6. Isolation vs. Temperature [RFC → RF1 / RF2]

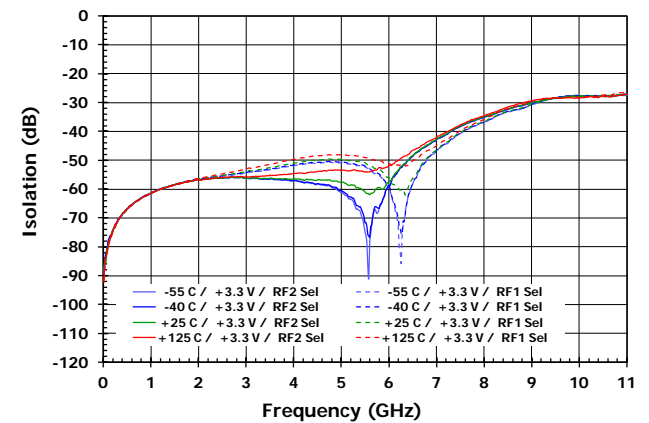

Figure 7. Isolation vs. Temperature [RFC → RF1 / RF2]

3.2 Typical Operating Conditions (2)

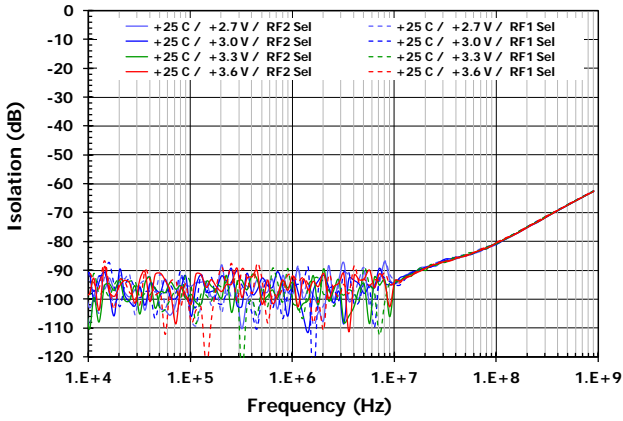

Figure 8. Isolation vs. Voltage [RFC → RF1 / RF2]

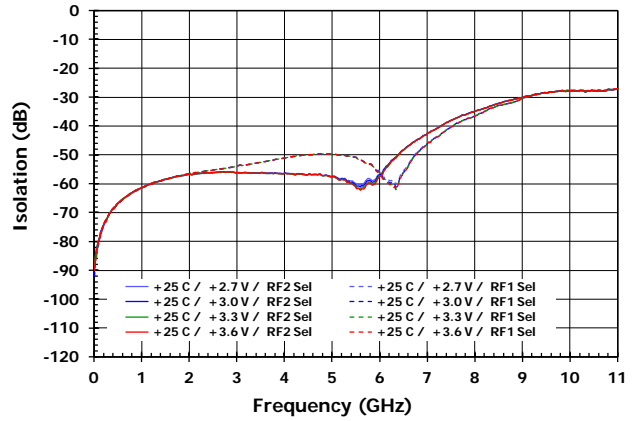

Figure 9. Isolation vs. Voltage [RFC → RF1 / RF2]

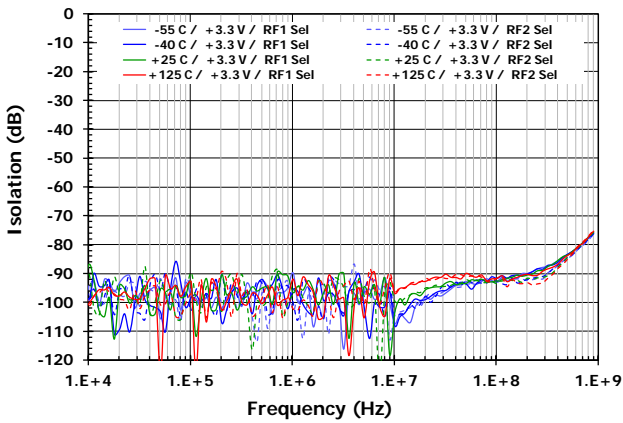

Figure 10. Isolation vs. Temperature [RF1 → RF2]

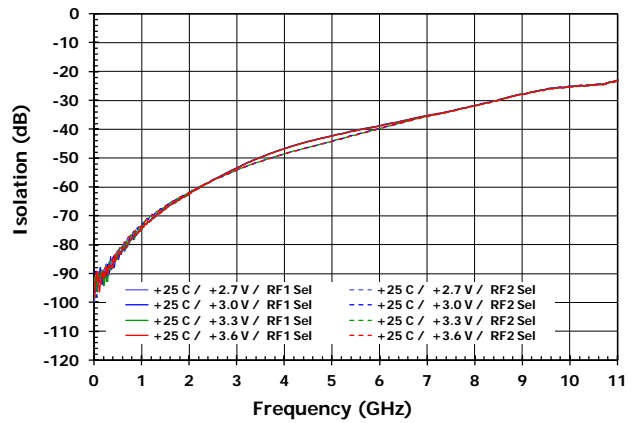

Figure 11. Isolation vs. Temperature [RF1 → RF2]

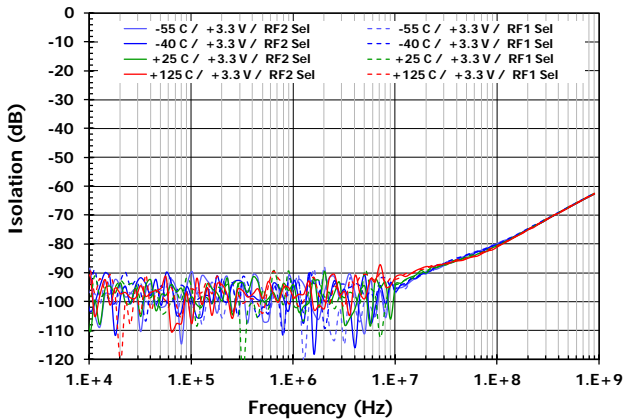

Figure 12. Isolation vs. Voltage [RF1 → RF2]

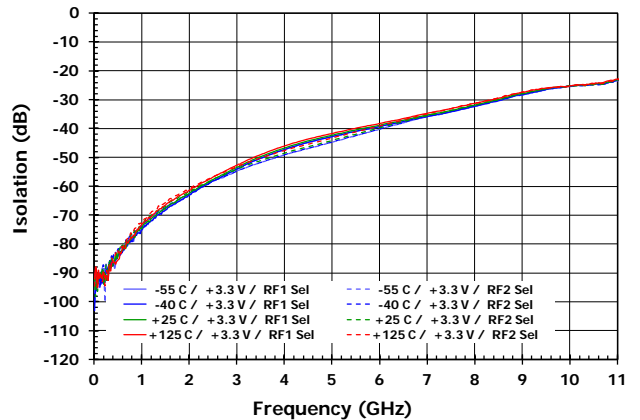

Figure 13. Isolation vs. Voltage [RF1 → RF2]

3.3 Typical Operating Conditions (3)

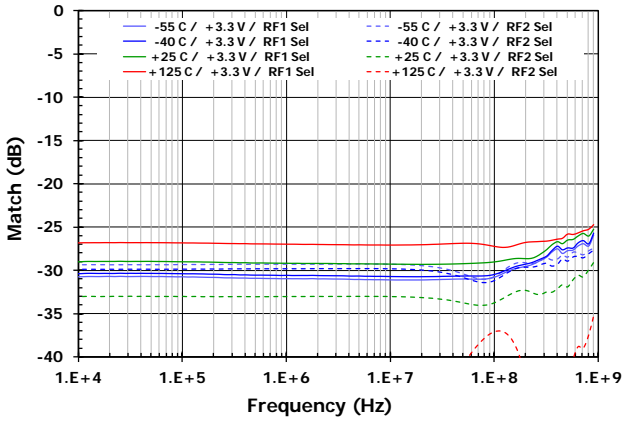

Figure 14. RF1 Return Loss vs. Temperature

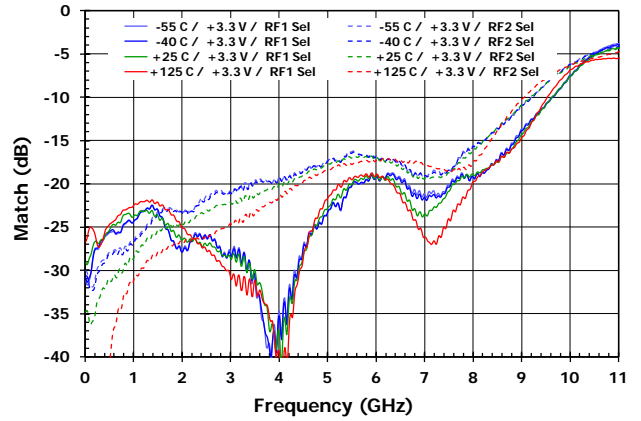

Figure 15. RF1 Return Loss vs. Temperature

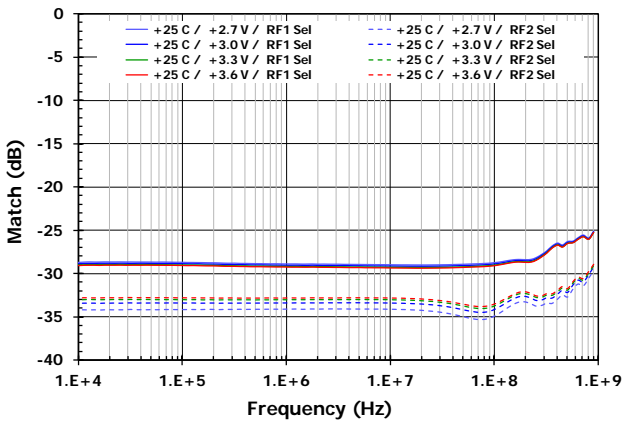

Figure 16. RF1 Return Loss vs. Voltage

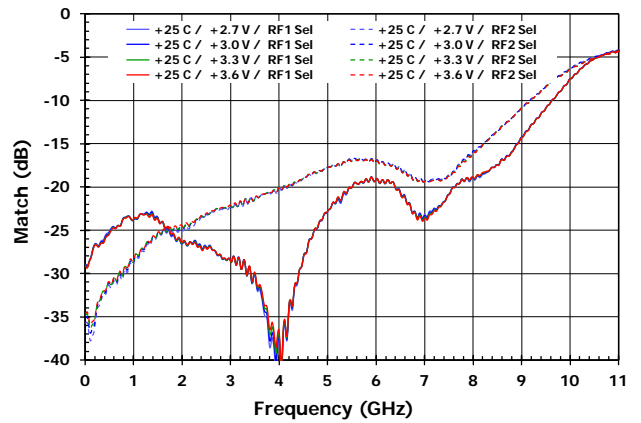

Figure 17. RF1 Return Loss vs. Voltage

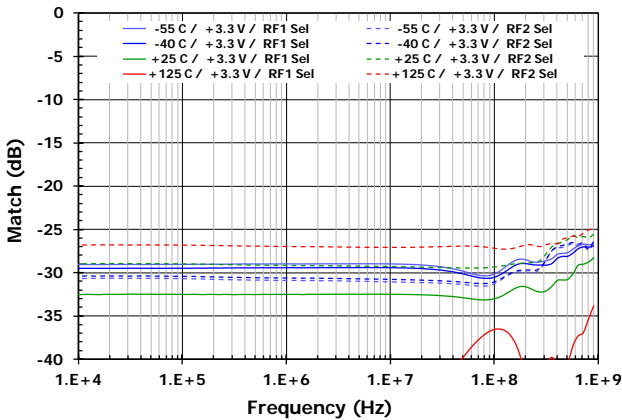

Figure 18. RF2 Return Loss vs. Temperature

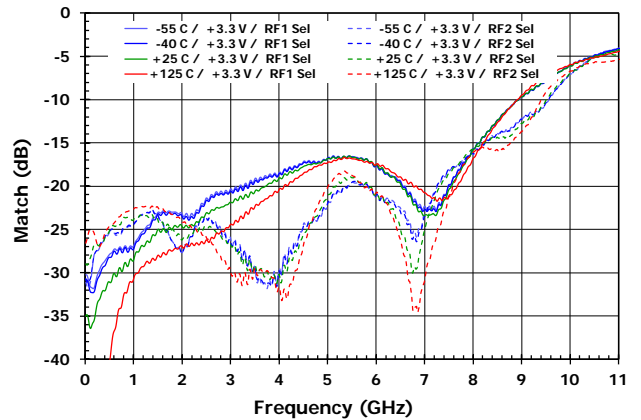

Figure 19. RF2 Return Loss vs. Temperature

3.4 Typical Operating Conditions (4)

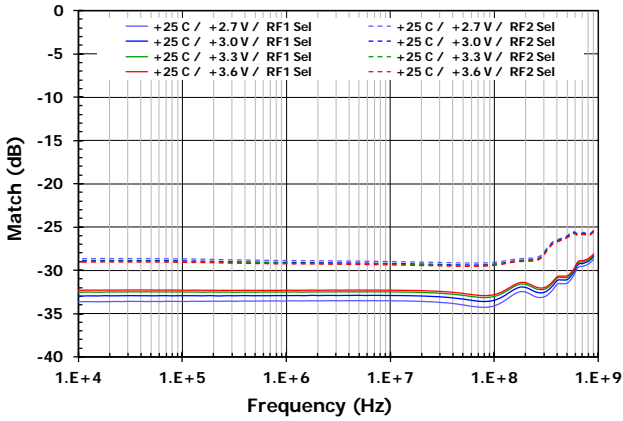

Figure 20. RF2 Return Loss vs. Voltage

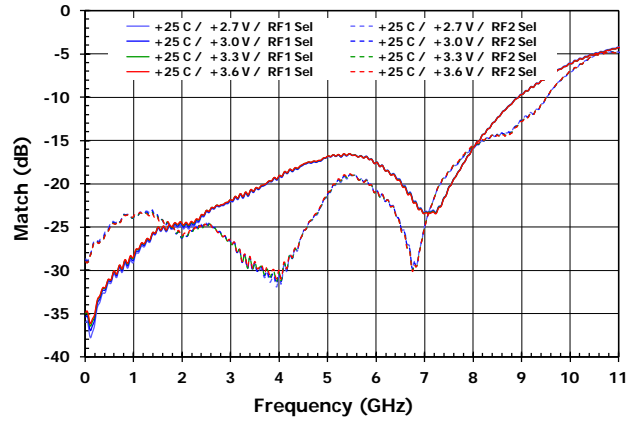

Figure 21. RF2 Return Loss vs. Voltage

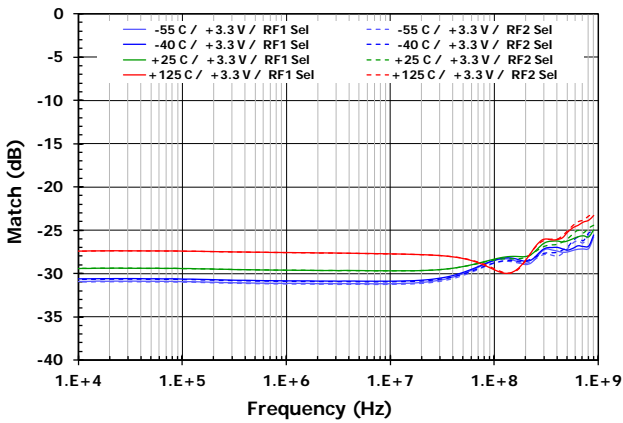

Figure 22. RFC Return Loss vs. Temperature

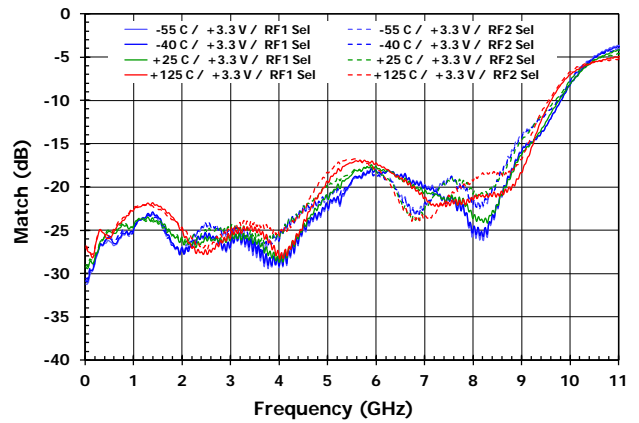

Figure 23. RFC Return Loss vs. Temperature

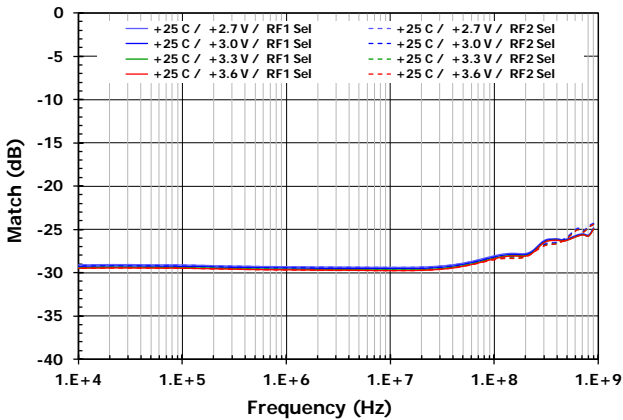

Figure 24. RFC Return Loss vs. Voltage

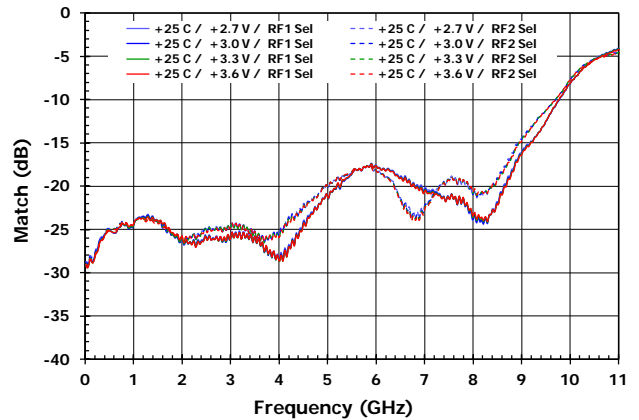

Figure 25. RFC Return Loss vs. Voltage

3.5 Typical Operating Conditions (5)

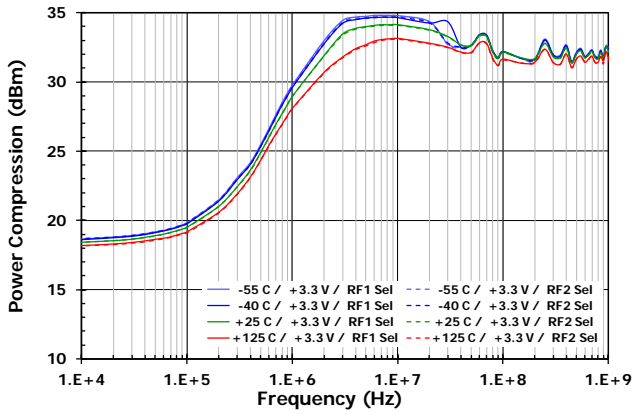

Figure 26. Input Power Compression vs. Temperature

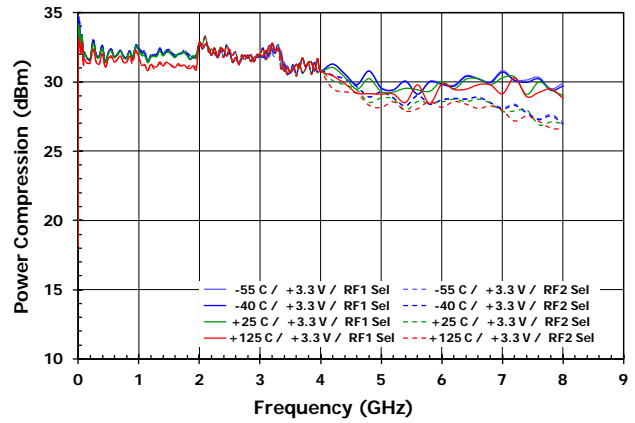

Figure 27. Input Power Compression vs. Temperature

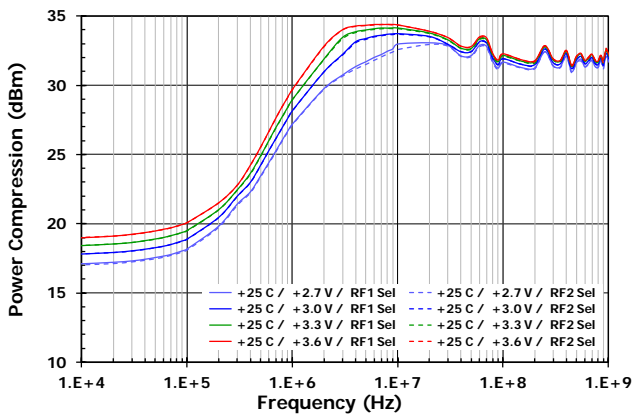

Figure 28. Input Power Compression vs. Voltage

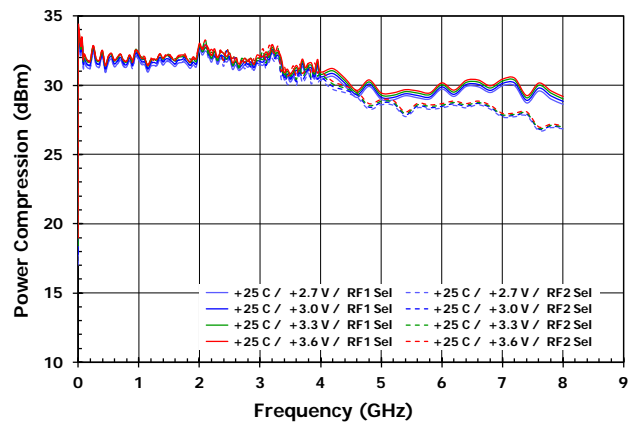

Figure 29. Input Power Compression vs. Voltage

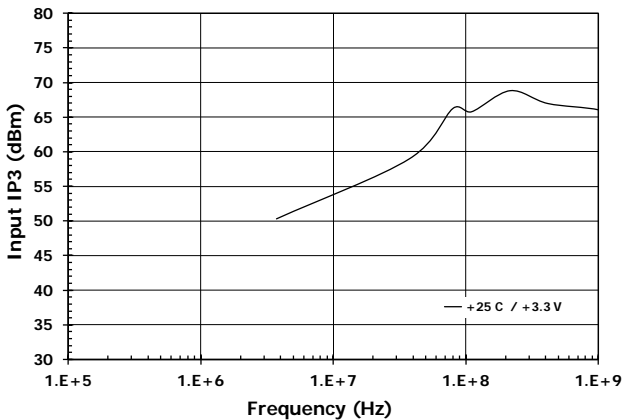

Figure 30. Input IP3

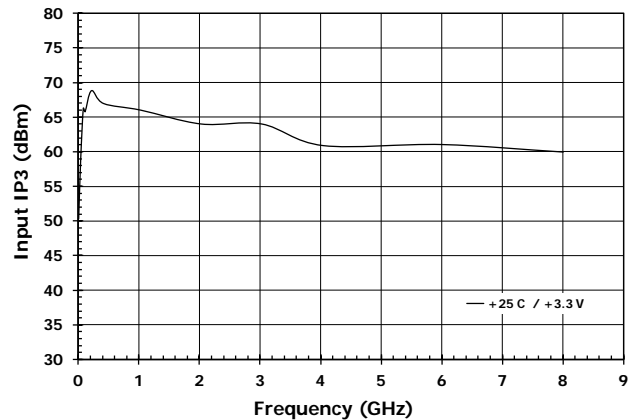

Figure 31. Input IP3

3.6 Typical Operating Conditions (6)

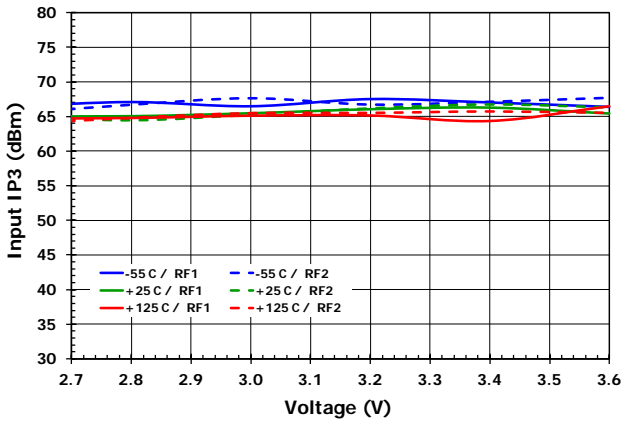

Figure 32. Input IP3 [2GHz]

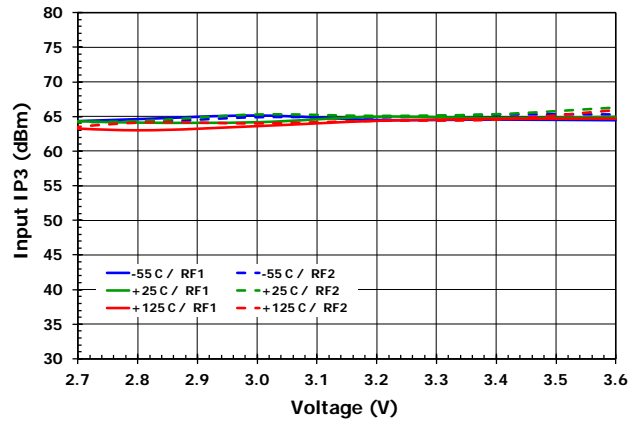

Figure 33. Input IP3 [3GHz]

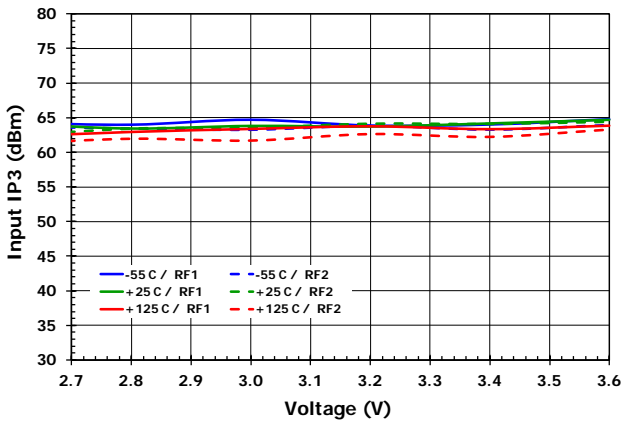

Figure 34. Input IP3 [4GHz]

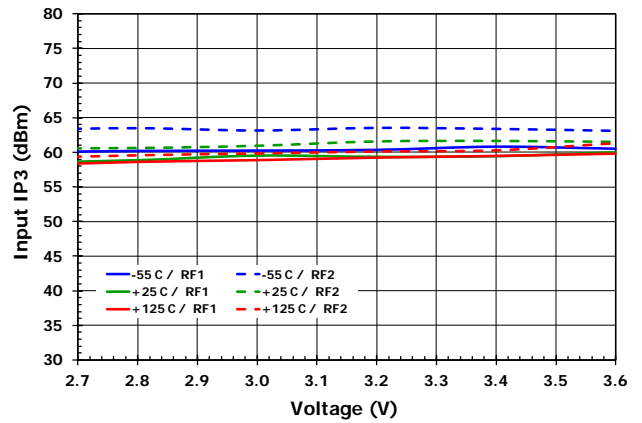

Figure 35. Input IP3 [6GHz]

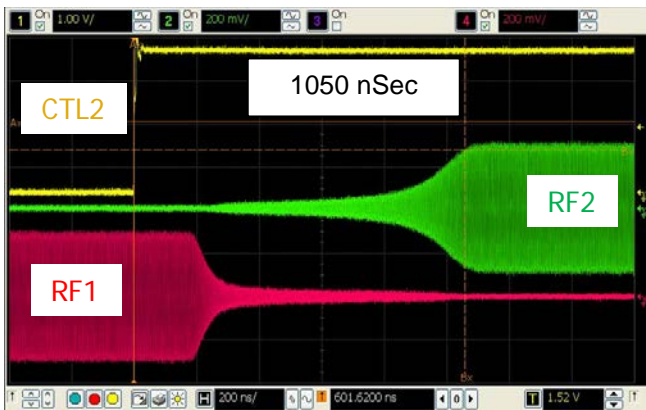

Figure 36. Switching Time [T_{AMB} = 25°C, 3.3V]

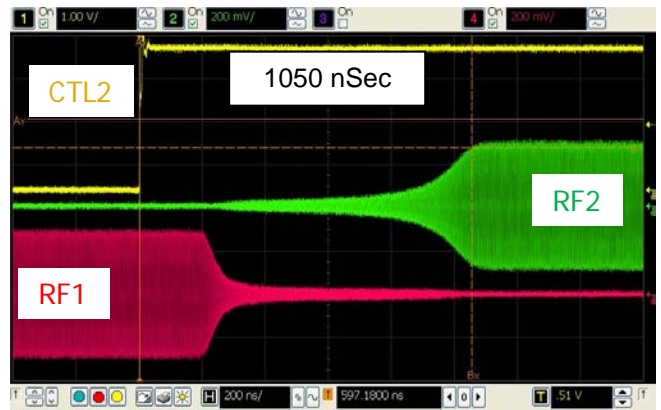

Figure 37. Switching Time [T_{AMB} = -40°C, 3.3V]

3.7 Typical Operating Conditions Histograms [N = 4800, T_{case} = 25°C]

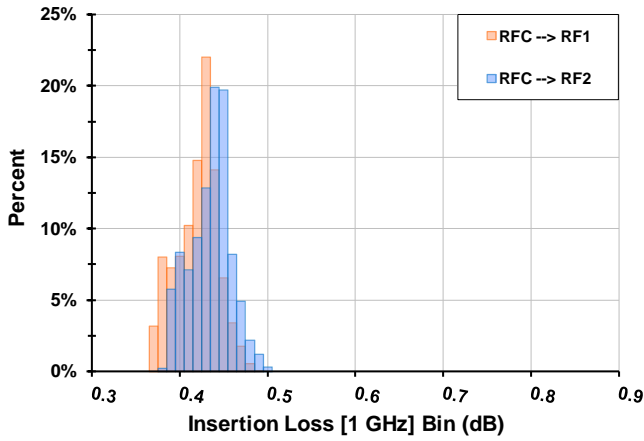

Figure 38. Insertion Loss [RF = 1GHz]

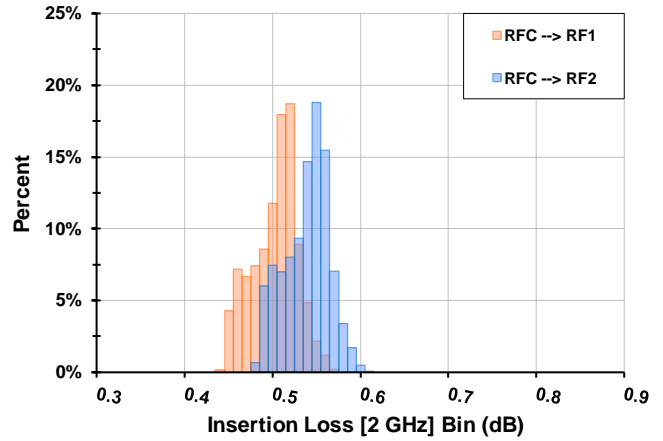

Figure 39. Insertion Loss [RF = 2GHz]

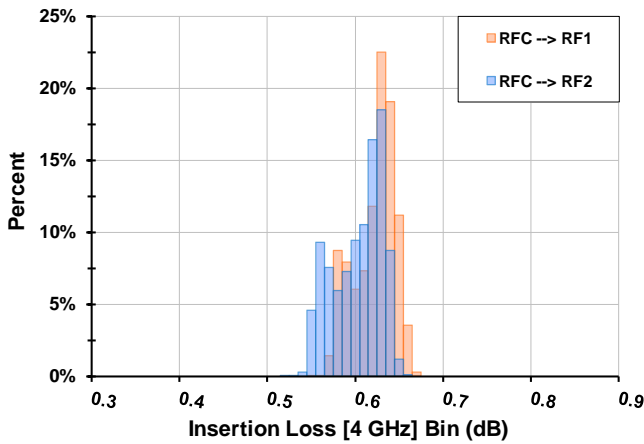

Figure 40. Insertion Loss [RF = 4GHz]

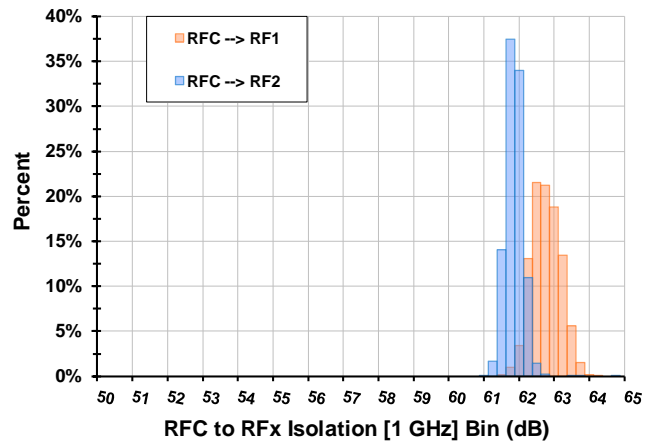

Figure 41. Isolation [RF = 1GHz]

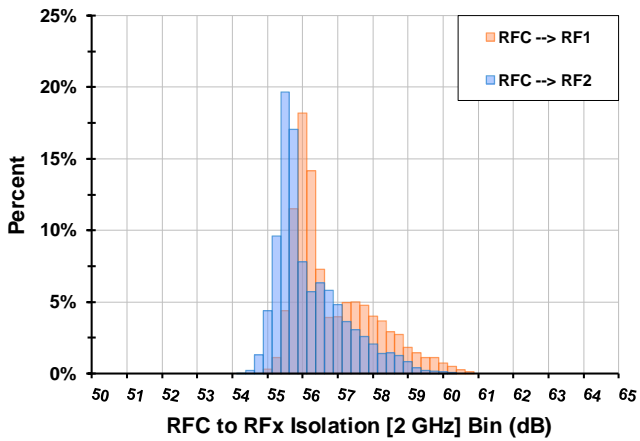

Figure 42. Isolation [RF = 2GHz]

4. Application Information

4.1 Default Start-up

Control pins include no internal pull-down resistors to logic LOW or pull-up resistors to logic HIGH. Upon start-up, all control pins should be set to logic LOW (0) thereby enabling 2 pin switch control, opening both RF1 and RF2 paths, and setting logic control voltage to 3.3 V (see above tables for LOW logic states).

4.2 Power Supplies

A common VCC power supply should be used for all pins requiring DC power. All supply pins should be bypassed with external capacitors to minimize noise and fast transients. Supply noise can degrade noise figure and fast transients can trigger ESD clamps and cause them to fail. Supply voltage change or transients should have a slew rate smaller than $1V / 20\mu s$. In addition, all control pins should remain at 0V ($\pm 0.3V$) while the supply voltage ramps or while it returns to zero.

4.3 Control Pin Interface

If control signal integrity is a concern and clean signals cannot be confirmed due to overshoot, undershoot, ringing, etc., the following circuit at the input of each control pin is recommended. This applies to control pins 16, 17, 18, and 19 as shown below.

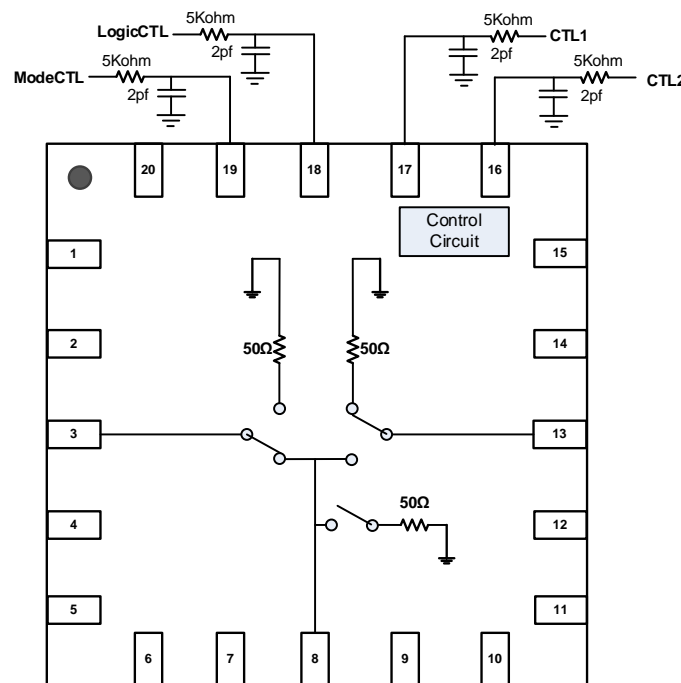

Figure 43. Control Pin Interface Diagram

4.4 Pin Compatibility

The F2912 switch is compatible with other supplier parts which only support two wire control and 3V logic. Other suppliers' parts with limited functionality have pins 18 and 19 grounded. Grounding pins 18 and 19 on the F2912 will make it fully compatible with the other products.

Per Table 3 when pin 19 is grounded, the F2912 is set for 2-wire control.

Per Table 4 when pin 18 is grounded, the F2912 is set for 3.3V control logic. JEDEC 3.3V logic (JESD8C.01) allows logic high to be as low as 2.7V which the F2912 supports.

Contact your Renesas representative for more information about compatibility with other suppliers' products.

5. EVKit Operation

The F2912 EVkit has a number of control features available. Please refer to the EVkit Application Circuit and EVkit Picture for connections to this part. All bias and logic controls are done using J7 as an interface.

See Table 5 for the function of each pin on J7.

Table 5. EVkit J7 Interface Table

J7 Pin	Pin Name	Connections
1	V _{CC}	Pin to supply V _{CC} from an external power supply.
2	GND	Pin to supply GND from an external power supply.
3	ModeCTL	Leave this pin open to select 1-pin control. A pull up resistor on the EVkit provides a logic high. If 2-pin control is desired, ground this pin by using a two pin shunt between this pin and pin 4 (GND). See Tables 1, 2, and 3 for 1-pin and 2-pin control logic.
4	GND	Pin available to shunt to pin 3 to provide a logic low.
5	LogicCTL	If using 1.8V logic for CTL1 and CTL2, leave this pin open. A pull-up resistor on the kit provides a logic high. If 3.3V logic is used then ground this pin by using a two pin shunt between this pin and pin 6 (GND).
6	GND	Pin available to shunt to pin 5 to provide a logic low.
7	CTL1	Used to control the switch state when using the 2-pin control method. Leave this pin open to allow the EVkit pull-up resistor to provide a logic high. Connect to pin 8 (GND) with a two pin shunt if a logic low is desired. Actual logic levels applied to this pin depend on the setting of LogicCTL pin. This device can be damage if the incorrect logic level is applied to this pin.
8	GND	Pin available to shunt to pin 7 to provide a logic low.
9	CTL2	Used to control the switch state when using the 1-pin or 2-pin control method. Leave this pin open to allow the EVkit pull-up resistor to provide a logic high. Connect to pin 10 (GND) with a two pin shunt if a logic low is desired. Actual logic levels applied to this pin depend on the setting of LogicCTL pin. This device can be damage if the incorrect logic level is applied to this pin.
10	GND	Pin available to shunt to pin 9 to provide a logic low.
11	1.8VSEL	If using 3.3V CTL1 and CTL2 logic, connect this pin to pin 12 (V _{CC}) using a two pin shunt. If using 1.8V logic then leave this pin open. ^[1]
12	V _{CC}	Internally connected on PCB to V _{CC} on pin.
13	1.8VSEL	If using 1.8V CTL1 and CTL2 logic, connect this pin to pin 14 (1.8VSEL2) using a two pin shunt. If using 3.3V logic then leave this pin open. ^[1]
14	1.8VSEL2	If using 1.8V CTL1 and CTL2 logic, connect this pin to pin 13 (1.8VSEL) using a two pin shunt. If using 3.3V logic then leave this pin open. ^[1]

1. Never configure the kit to have two pin shunts for both Pin 11 to Pin 12 and Pin 13 to Pin 14.

5.1 EVKit Picture (top)

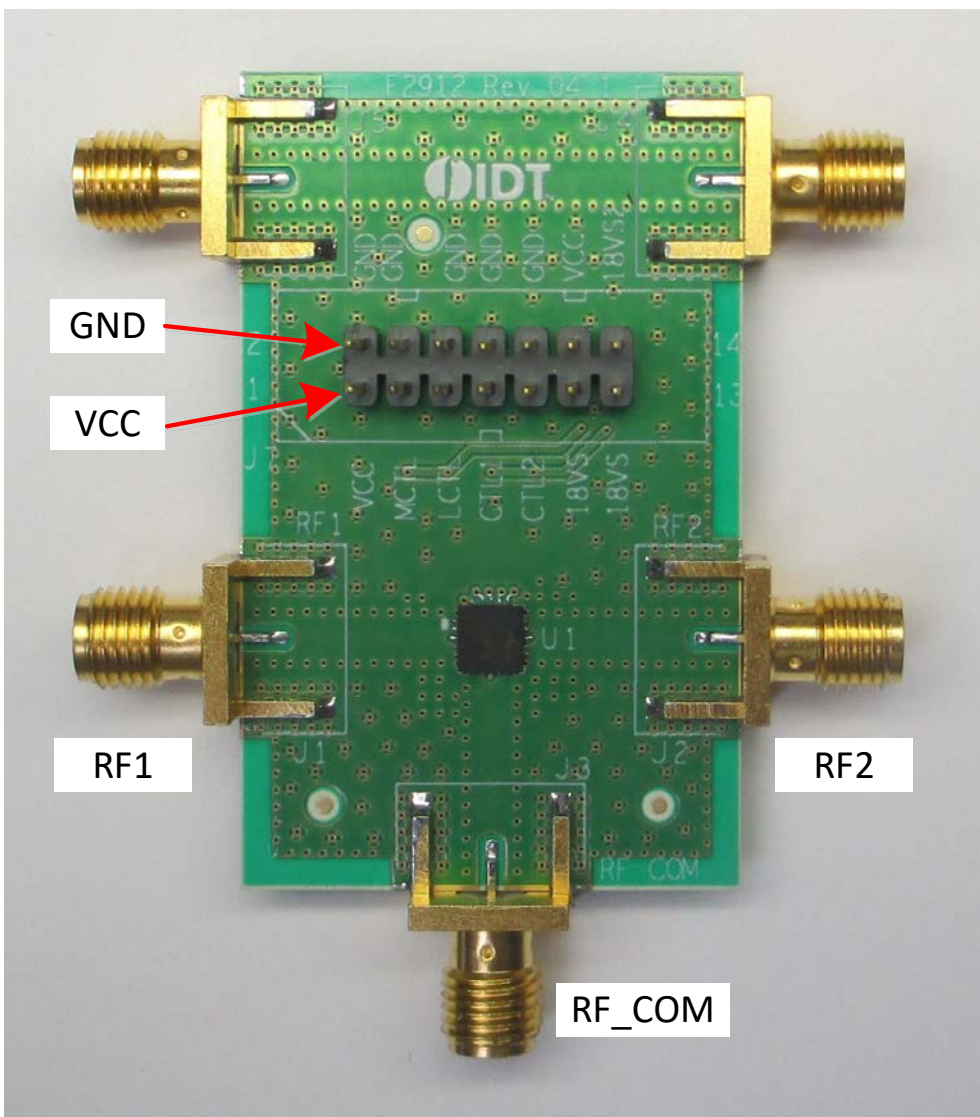

5.2 EvKit Picture (bottom)

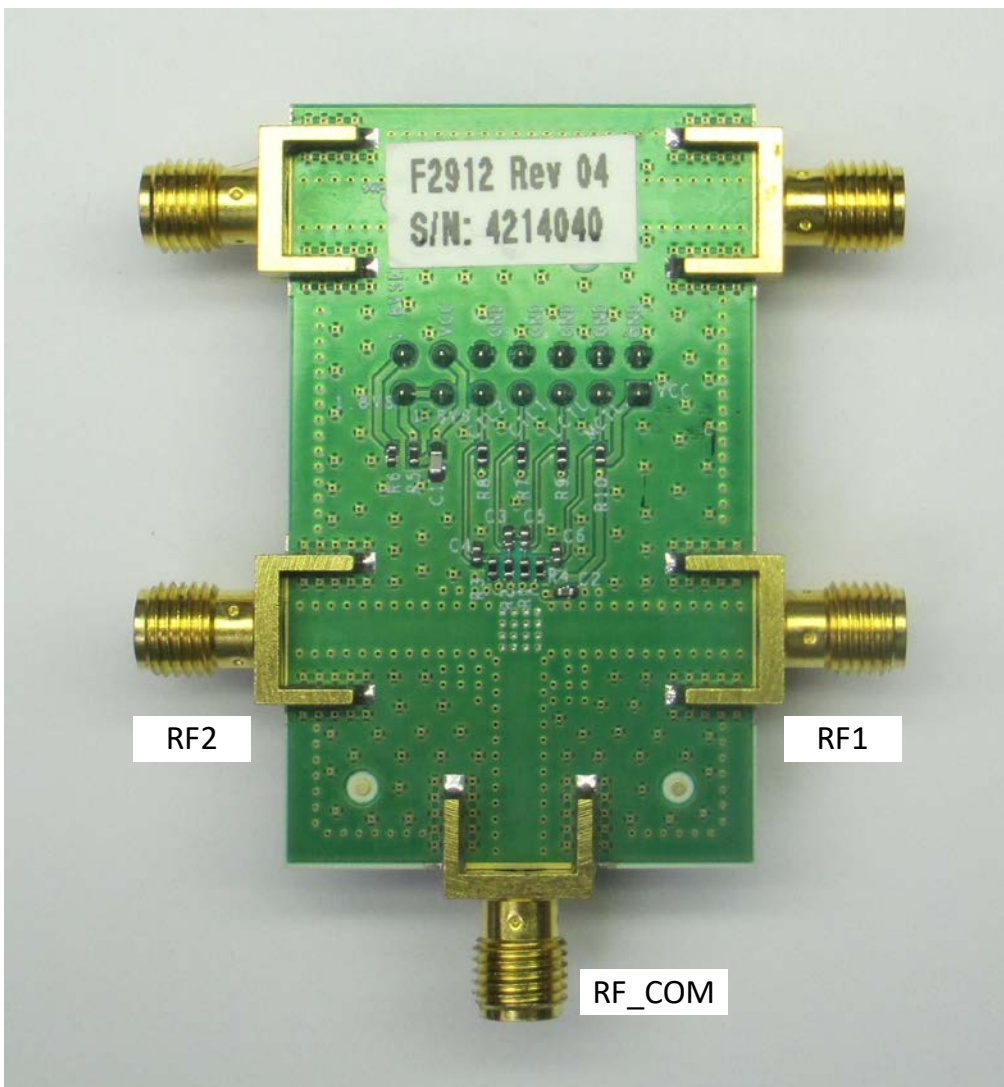

5.3 EVkit / Applications Circuit

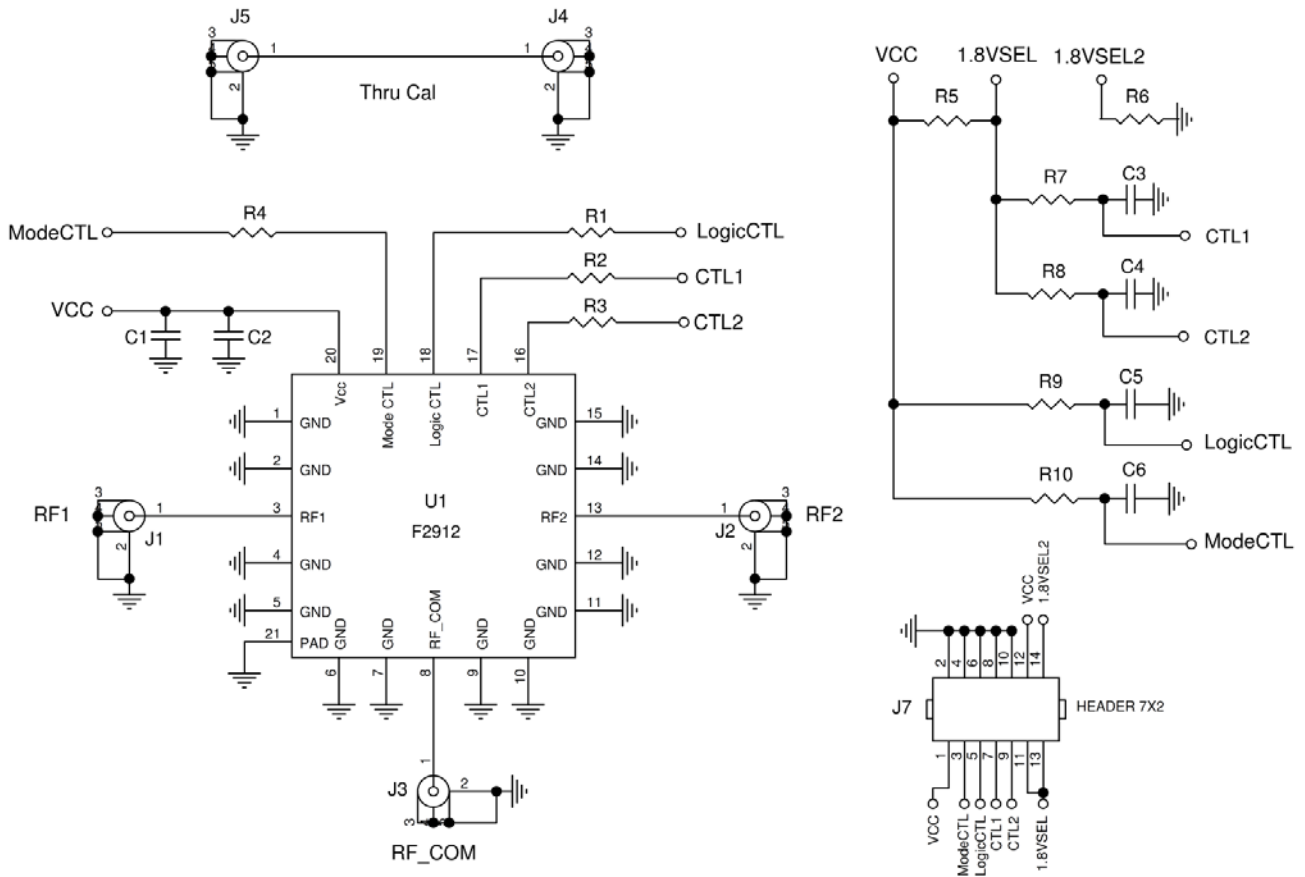

5.4 EVKit BOM

Part Reference	QTY	Description	Mfr. Part #	Mfr.
C1	1	1000pF ±5%, 50V, C0G Ceramic Capacitor (0603)	GRM1885C1H102J	Murata
C2	1	0.1µF ±10%, 16V, X7R Ceramic Capacitor (0402)	GRM155R71C104K	Murata
C3 – C6	4	100pF ±5%, 50V, C0G Ceramic Capacitor (0402)	GRM1555C1H101J	Murata
R1 – R4	4	100 ohm ±1%, 1/10W, Resistor (0402)	ERJ-2RKF1000X	Panasonic
R5	1	15 kohm ±1%, 1/10W, Resistor (0402)	ERJ-2RKF1502X	Panasonic
R6	1	18 kohm ±1%, 1/10W, Resistor (0402)	ERJ-2RKF1802X	Panasonic
R7 – R10	4	100 kohm ±1%, 1/10W, Resistor (0402)	ERJ-2RKF1003X	Panasonic
J1 – J5	5	SMA Edge Launch (0.375 inch pitch ground tabs)	142-0701-851	Emerson Johnson
J7	1	CONN HEADER VERT 7x2 POS GOLD	N2514-6002-RB	3M
U1	1	SP2T Switch 4 mm x 4 mm QFN20-EP	F2912NCGI	Renesas
	1	Printed Circuit Board	F2912 EVKIT REV 4.1	Renesas

6. Package Outline Drawings

The package outline drawings are located at the end of this document and are accessible from the Renesas website (see Ordering Information for POD links). The package information is the most current data available and is subject to change without revision of this document.

7. Ordering Information

Part Number	Package Description	Carrier Type	Temperature Range
F2912NCGI	20-VFQFPN , 4 × 4 × 0.75 mm	Tray	-55°C to +125°C
F2912NCGI8		Tape and Reel	

8. Revision History

Revision	Date	Description
1.04	Sep 20, 2021	<ul style="list-style-type: none"> ▪ Added note to Table 1. ▪ Reformatted to latest datasheet template.
1.03	Apr 1, 2016	<ul style="list-style-type: none"> ▪ Added data for low frequency operation (9kHz). ▪ Added data for higher frequency operation (9GHz).
1.02	Sep 4, 2015	<ul style="list-style-type: none"> ▪ Updated to new datasheet format throughout document. ▪ Added recommended PCB land pattern information. ▪ Added pin compatible information.
1.01	Oct 21, 2014	Updated EVKIT Photo and BOM.
1.00	Aug 19, 2014	Initial release.

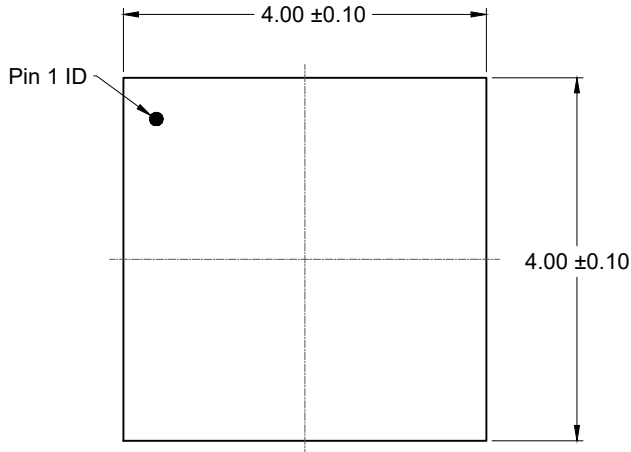

TOP VIEW

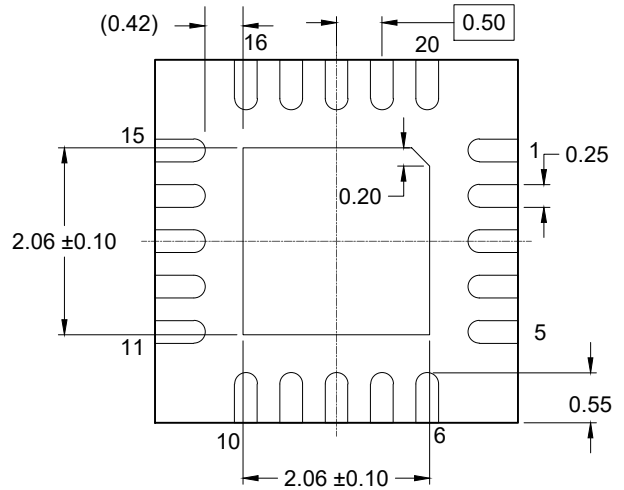

BOTTOM VIEW

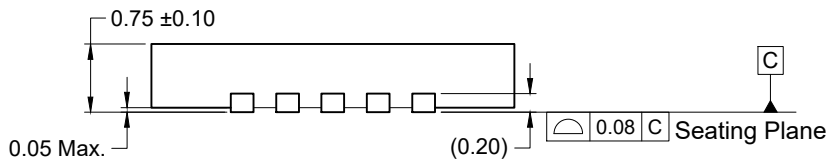

SIDE VIEW

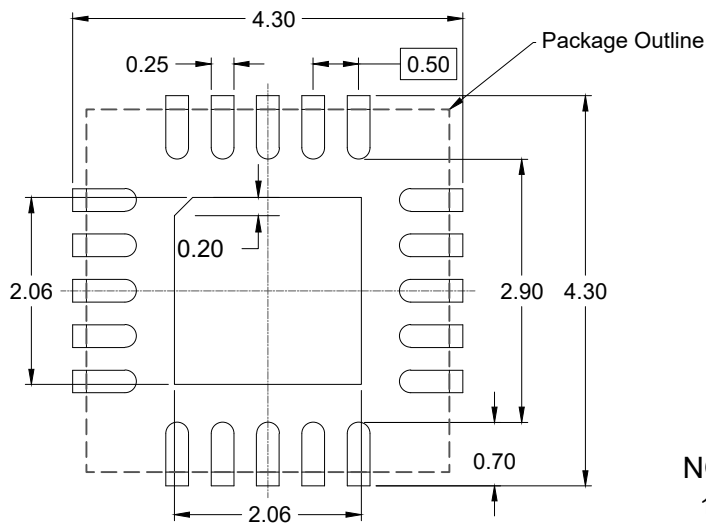

RECOMMENDED LAND PATTERN
 (PCB Top View, NSMD Design)

NOTES:

1. JEDEC compatible
2. All dimensions are in mm and angles are in degrees
3. Use ± 0.05 mm for the non-toleranced dimensions
4. Numbers in () are for reference only

IMPORTANT NOTICE AND DISCLAIMER

RENESAS ELECTRONICS CORPORATION AND ITS SUBSIDIARIES (“RENESAS”) PROVIDES TECHNICAL SPECIFICATIONS AND RELIABILITY DATA (INCLUDING DATASHEETS), DESIGN RESOURCES (INCLUDING REFERENCE DESIGNS), APPLICATION OR OTHER DESIGN ADVICE, WEB TOOLS, SAFETY INFORMATION, AND OTHER RESOURCES “AS IS” AND WITH ALL FAULTS, AND DISCLAIMS ALL WARRANTIES, EXPRESS OR IMPLIED, INCLUDING, WITHOUT LIMITATION, ANY IMPLIED WARRANTIES OF MERCHANTABILITY, FITNESS FOR A PARTICULAR PURPOSE, OR NON-INFRINGEMENT OF THIRD-PARTY INTELLECTUAL PROPERTY RIGHTS.

These resources are intended for developers who are designing with Renesas products. You are solely responsible for (1) selecting the appropriate products for your application, (2) designing, validating, and testing your application, and (3) ensuring your application meets applicable standards, and any other safety, security, or other requirements. These resources are subject to change without notice. Renesas grants you permission to use these resources only to develop an application that uses Renesas products. Other reproduction or use of these resources is strictly prohibited. No license is granted to any other Renesas intellectual property or to any third-party intellectual property. Renesas disclaims responsibility for, and you will fully indemnify Renesas and its representatives against, any claims, damages, costs, losses, or liabilities arising from your use of these resources. Renesas' products are provided only subject to Renesas' Terms and Conditions of Sale or other applicable terms agreed to in writing. No use of any Renesas resources expands or otherwise alters any applicable warranties or warranty disclaimers for these products.

(Disclaimer Rev.1.01 Jan 2024)

Corporate Headquarters

TOYOSU FORESIA, 3-2-24 Toyosu,
Koto-ku, Tokyo 135-0061, Japan
www.renesas.com

Trademarks

Renesas and the Renesas logo are trademarks of Renesas Electronics Corporation. All trademarks and registered trademarks are the property of their respective owners.

Contact Information

For further information on a product, technology, the most up-to-date version of a document, or your nearest sales office, please visit www.renesas.com/contact-us/.