

EL7104

High Speed, Single Channel, Power MOSFET Driver

FN7113
Rev 2.00
July 6, 2006

The EL7104 is a matched driver IC that improves the operation of the industry-standard TC-4420/29 clock drivers. The Elantec version is a very high speed driver capable of delivering peak currents of 1A into highly capacitive loads. The high speed performance is achieved by means of a proprietary "Turbo-Driver" circuit that speeds up input stages by tapping the wider voltage swing at the output. Improved speed and drive capability are enhanced by matched rise and fall delay times. These matched delays maintain the integrity of input-to-output pulse-widths to reduce timing errors and clock skew problems. This improved performance is accompanied by a 10-fold reduction in supply currents over bipolar drivers, yet without the delay time problems commonly associated with CMOS drivers.

The EL7104 is available in 8-pin SO and 8-pin PDIP packages and is specified for operation over the full -40°C to +85°C temperature range.

Ordering Information

PART NUMBER	PART MARKING	PACKAGE	TAPE & REEL	PKG. DWG. #
EL7104CN	EL7104CN	8 Ld PDIP	-	MDP0031
EL7104CNZ	EL7104CN Z	8 Ld PDIP*	-	MDP0031
EL7104CS	7104CS	8 Ld SOIC	-	MDP0027
EL7104CS-T7	7104CS	8 Ld SOIC	7"	MDP0027
EL7104CS-T13	7104CS	8 Ld SOIC	13"	MDP0027
EL7104CSZ (See Note)	7104CSZ	8 Ld SOIC (Pb-free)	-	MDP0027
EL7104CSZ-T7 (See Note)	7104CSZ	8 Ld SOIC (Pb-free)	7"	MDP0027
EL7104CSZ-T13 (See Note)	7104CSZ	8 Ld SOIC (Pb-free)	13"	MDP0027

NOTE: Intersil Pb-free products employ special Pb-free material sets; molding compounds/die attach materials and 100% matte tin plate termination finish, which are RoHS compliant and compatible with both SnPb and Pb-free soldering operations. Intersil Pb-free products are MSL classified at Pb-free peak reflow temperatures that meet or exceed the Pb-free requirements of IPC/JEDEC J STD-020.

*Pb-free PDIPs can be used for through hole wave solder processing only. They are not intended for use in Reflow solder processing applications.

Features

- Industry-standard driver replacement
- Improved response times
- Matched rise and fall times
- Reduced clock skew
- Low output impedance
- Low input capacitance
- High noise immunity
- Improved clocking rate
- Low supply current
- Wide operating range
- Separate drain connections
- Pb-Free available (RoHS compliant)

Applications

- Clock/line drivers
- CCD drivers
- Ultrasound transducer drivers
- Power MOSFET drivers
- Switch mode power supplies
- Resonant charging
- Cascoded drivers

Pinout

EL7104
(8-PIN SO, PDIP)
TOP VIEW

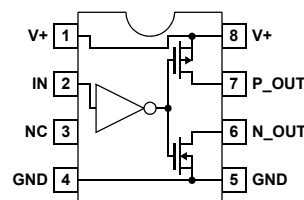

Absolute Maximum Ratings (T_A = 25°C)

Supply (V+ to GND)	16.5V	Storage Temperature Range	-65°C to +150°C
Input Pins	-0.3V to +0.3V above V+	Operating Junction Temperature	+125°C
Peak Output Current4A	Power Dissipation	
Ambient Operating Temperature	-40°C to +85°C	SO570mW
		PDIP1050mW

CAUTION: Stresses above those listed in "Absolute Maximum Ratings" may cause permanent damage to the device. This is a stress only rating and operation of the device at these or any other conditions above those indicated in the operational sections of this specification is not implied.

IMPORTANT NOTE: All parameters having Min/Max specifications are guaranteed. Typ values are for information purposes only. Unless otherwise noted, all tests are at the specified temperature and are pulsed tests, therefore: T_J = T_C = T_A

DC Electrical Specifications V+ = 15V, T_A = 25°C unless otherwise specified.

PARAMETER	DESCRIPTION	CONDITIONS	MIN	TYP	MAX	UNIT
INPUT						
V _{IH}	Logic "1" Input Voltage		2.4			V
I _{IH}	Logic "1" Input Current	@V+		0.1	10	μA
V _{IL}	Logic "0" Input Voltage				0.8	V
I _{IL}	Logic "0" Input Current	@0V		0.1	10	μA
V _{HVS}	Input Hysteresis			0.3		V
OUTPUT						
R _{OH}	Pull-Up Resistance	I _{OUT} = -100mA		1.5	4	Ω
R _{OL}	Pull-Down Resistance	I _{OUT} = +100mA		2	4	Ω
I _{OUT}	Output Leakage Current	V+/GND		0.2	10	μA
I _{PK}	Peak Output Current	Source/Sink		4.0		A
I _{DC}	Continuous Output Current	Source/Sink	200			mA
POWER SUPPLY						
I _S	Power Supply Current	Input = V+		4.5	7.5	mA
V _S	Operating Voltage		4.5		16	V

AC Electrical Specifications V = 15V, T_A = 25°C unless otherwise specified.

PARAMETER	DESCRIPTION	CONDITIONS	MIN	TYP	MAX	UNIT
SWITCHING CHARACTERISTICS (V_{DD} = V_H = 12V; V_L = -3V)						
t _R	Rise Time	C _L = 1000pF		7.5		ns
		C _L = 2000pF		10	20	ns
t _F	Fall Time	C _L = 1000pF		10		ns
		C _L = 2000pF		15	20	ns
t _{D-ON}	Turn-On Delay Time	See Timing Table		18	25	ns
t _{D-OFF}	Turn-Off Delay Time	See Timing Table		18	25	ns

Timing Table

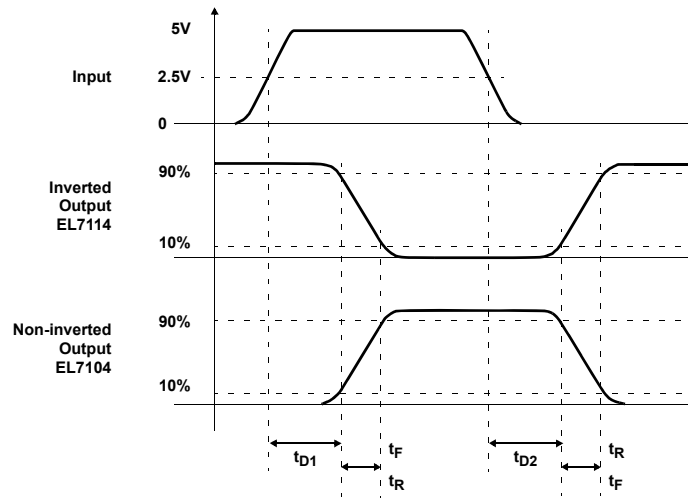

Standard Test Configuration

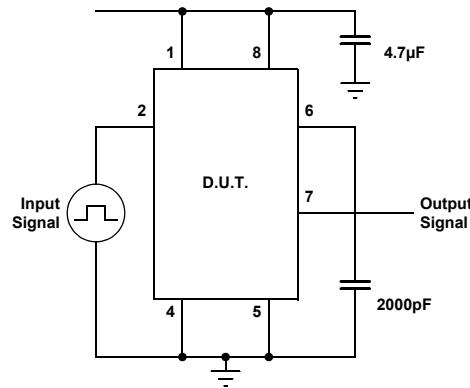

Simplified Schematic

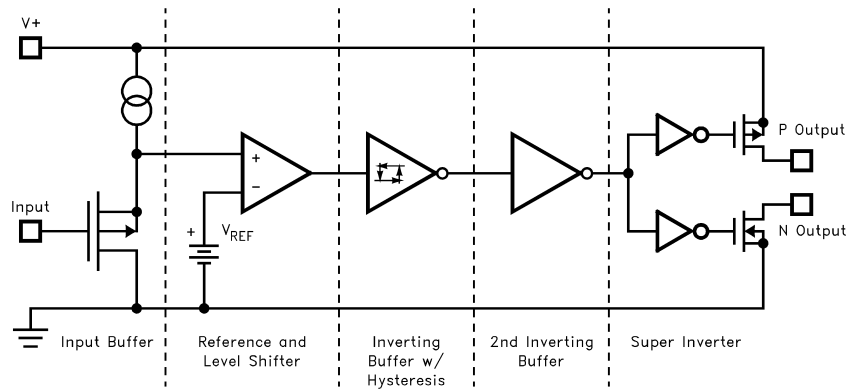

Typical Performance Curves

MAX POWER/DERATING CURVES

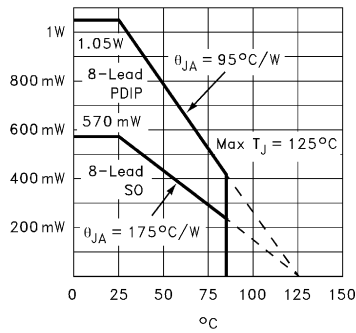

SWITCH THRESHOLD vs SUPPLY VOLTAGE

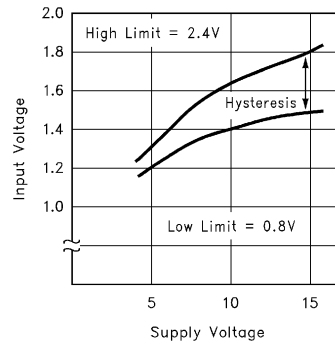

INPUT CURRENT vs VOLTAGE

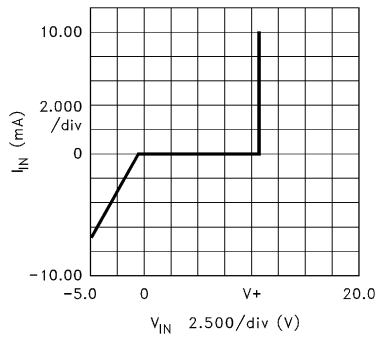

PEAK DRIVE vs SUPPLY VOLTAGE

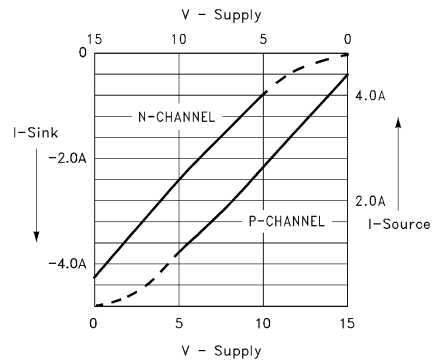

QUIESCENT SUPPLY CURRENT

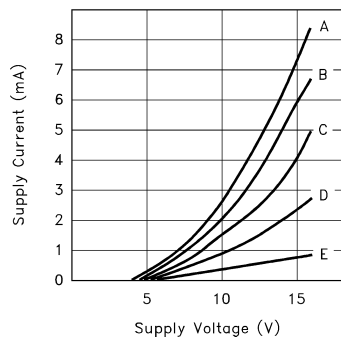

CASE:

Device	Input Level	Curve
EL7104	GND	A
EL7104	V+	C
EL7114	GND	E
EL7114	V+	C

"ON" RESISTANCE vs SUPPLY VOLTAGE

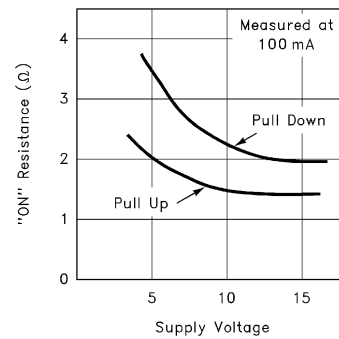

Typical Performance Curves (Continued)

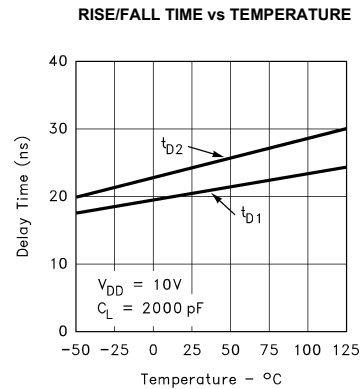
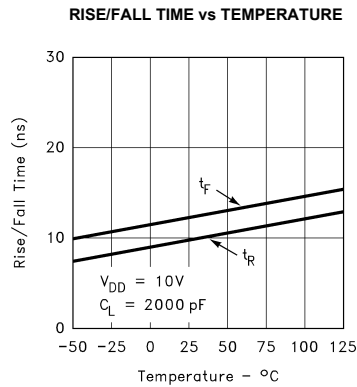
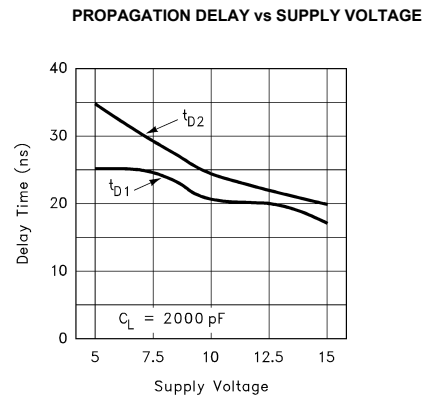
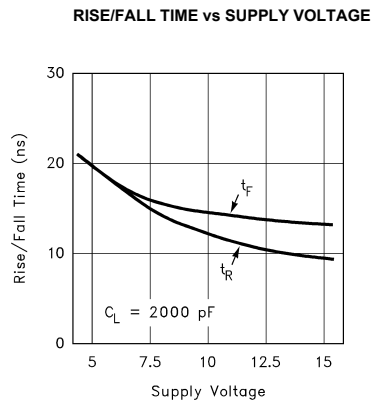
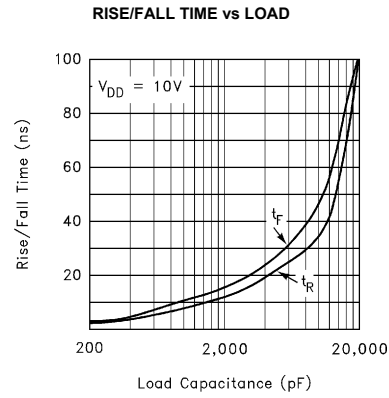
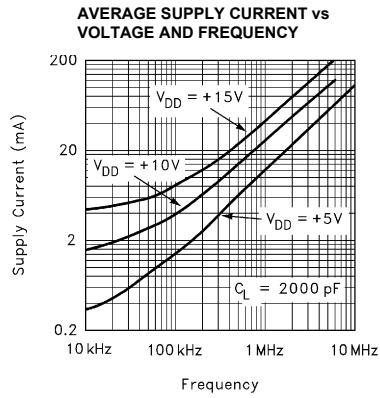

Small Outline Package Family (SO)

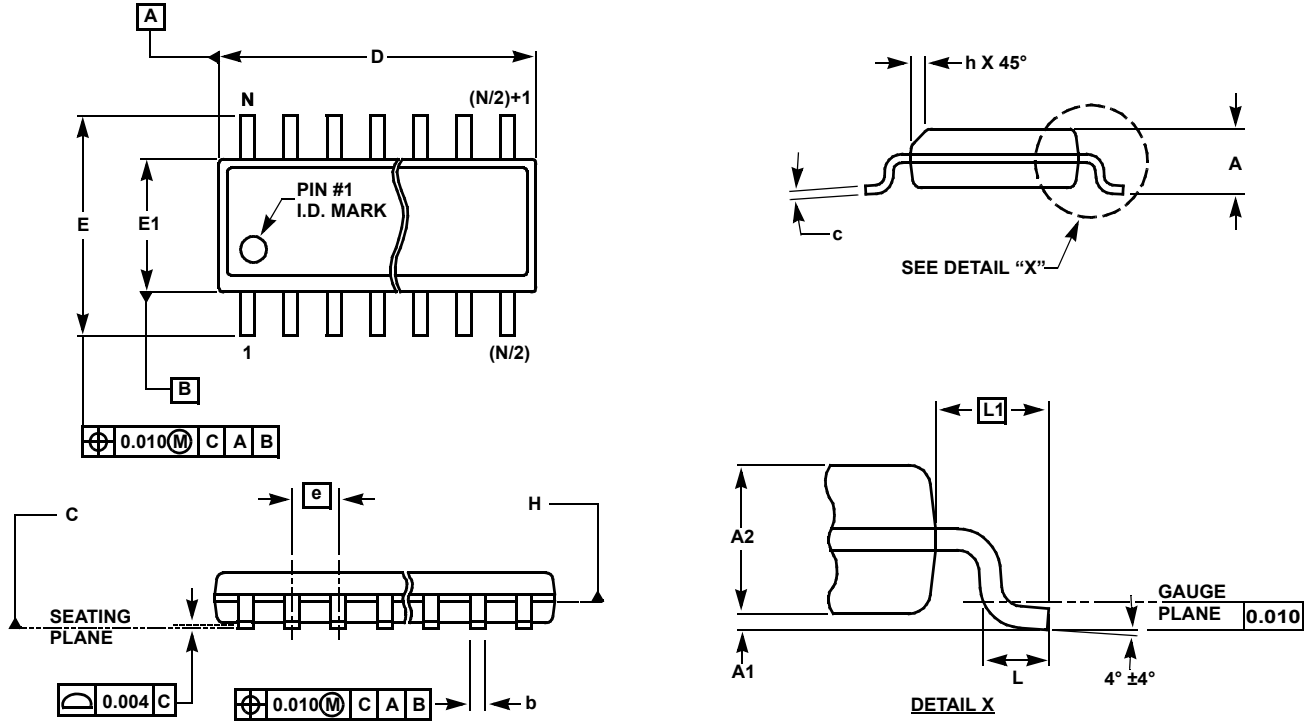

MDP0027

SMALL OUTLINE PACKAGE FAMILY (SO)

SYMBOL	SO-8	SO-14	SO16 (0.150")	SO16 (0.300") (SOL-16)	SO20 (SOL-20)	SO24 (SOL-24)	SO28 (SOL-28)	TOLERANCE	NOTES
A	0.068	0.068	0.068	0.104	0.104	0.104	0.104	MAX	-
A1	0.006	0.006	0.006	0.007	0.007	0.007	0.007	± 0.003	-
A2	0.057	0.057	0.057	0.092	0.092	0.092	0.092	± 0.002	-
b	0.017	0.017	0.017	0.017	0.017	0.017	0.017	± 0.003	-
c	0.009	0.009	0.009	0.011	0.011	0.011	0.011	± 0.001	-
D	0.193	0.341	0.390	0.406	0.504	0.606	0.704	± 0.004	1, 3
E	0.236	0.236	0.236	0.406	0.406	0.406	0.406	± 0.008	-
E1	0.154	0.154	0.154	0.295	0.295	0.295	0.295	± 0.004	2, 3
e	0.050	0.050	0.050	0.050	0.050	0.050	0.050	Basic	-
L	0.025	0.025	0.025	0.030	0.030	0.030	0.030	± 0.009	-
L1	0.041	0.041	0.041	0.056	0.056	0.056	0.056	Basic	-
h	0.013	0.013	0.013	0.020	0.020	0.020	0.020	Reference	-
N	8	14	16	16	20	24	28	Reference	-

Rev. L 2/01

NOTES:

1. Plastic or metal protrusions of 0.006" maximum per side are not included.
2. Plastic interlead protrusions of 0.010" maximum per side are not included.
3. Dimensions "D" and "E1" are measured at Datum Plane "H".
4. Dimensioning and tolerancing per ASME Y14.5M-1994

Plastic Dual-In-Line Packages (PDIP)

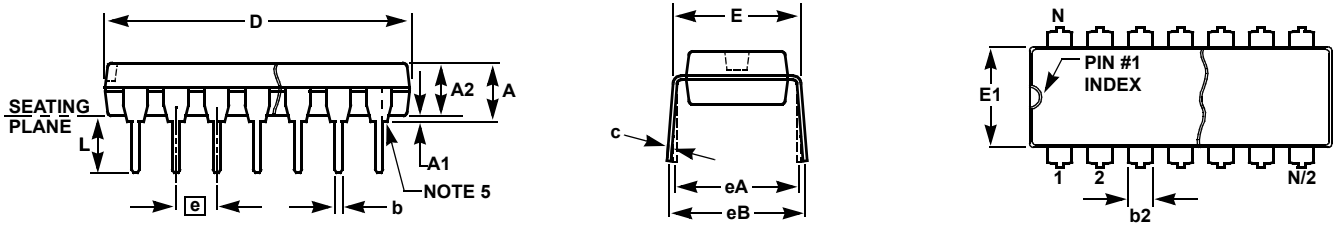

MDP0031

PLASTIC DUAL-IN-LINE PACKAGE

SYMBOL	PDIP8	PDIP14	PDIP16	PDIP18	PDIP20	TOLERANCE	NOTES
A	0.210	0.210	0.210	0.210	0.210	MAX	
A1	0.015	0.015	0.015	0.015	0.015	MIN	
A2	0.130	0.130	0.130	0.130	0.130	±0.005	
b	0.018	0.018	0.018	0.018	0.018	±0.002	
b2	0.060	0.060	0.060	0.060	0.060	+0.010/-0.015	
c	0.010	0.010	0.010	0.010	0.010	+0.004/-0.002	
D	0.375	0.750	0.750	0.890	1.020	±0.010	1
E	0.310	0.310	0.310	0.310	0.310	+0.015/-0.010	
E1	0.250	0.250	0.250	0.250	0.250	±0.005	2
e	0.100	0.100	0.100	0.100	0.100	Basic	
eA	0.300	0.300	0.300	0.300	0.300	Basic	
eB	0.345	0.345	0.345	0.345	0.345	±0.025	
L	0.125	0.125	0.125	0.125	0.125	±0.010	
N	8	14	16	18	20	Reference	

Rev. B 2/99

NOTES:

1. Plastic or metal protrusions of 0.010" maximum per side are not included.
2. Plastic interlead protrusions of 0.010" maximum per side are not included.
3. Dimensions E and eA are measured with the leads constrained perpendicular to the seating plane.
4. Dimension eB is measured with the lead tips unconstrained.
5. 8 and 16 lead packages have half end-leads as shown.

© Copyright Intersil Americas LLC 2003-2006. All Rights Reserved.
 All trademarks and registered trademarks are the property of their respective owners.

For additional products, see www.intersil.com/en/products.html

Intersil products are manufactured, assembled and tested utilizing ISO9001 quality systems as noted in the quality certifications found at www.intersil.com/en/support/qualandreliability.html

Intersil products are sold by description only. Intersil may modify the circuit design and/or specifications of products at any time without notice, provided that such modification does not, in Intersil's sole judgment, affect the form, fit or function of the product. Accordingly, the reader is cautioned to verify that datasheets are current before placing orders. Information furnished by Intersil is believed to be accurate and reliable. However, no responsibility is assumed by Intersil or its subsidiaries for its use; nor for any infringements of patents or other rights of third parties which may result from its use. No license is granted by implication or otherwise under any patent or patent rights of Intersil or its subsidiaries.

For information regarding Intersil Corporation and its products, see www.intersil.com