

# V850ES/Jx3-L Microcontrollers

## V850ES/Jx3-L Microcontrollers Flash Memory Programming (Programmer)

R01AN0580EJ0200  
Rev.2.00  
May 20, 2011

### Introduction

This application note is intended for users who understand the functions of the V850ES/Jx3-L and who will use this product to design application systems.

The purpose of this application note is to help users understand how to develop dedicated flash memory programmers for rewriting the internal flash memory of the V850ES/Jx3-L.

The sample programs and circuit diagrams shown in this document are for reference only and are not intended for use in actual design-ins.

Therefore, these sample programs must be used at the user's own risk. Correct operation is not guaranteed if these sample programs are used.

### Target Devices

V850ES/JC3-L	V850ES/JE3-L	V850ES/JG3-L
<i>μ</i> PD70F3797	<i>μ</i> PD70F3805	<i>μ</i> PD70F3737
<i>μ</i> PD70F3798	<i>μ</i> PD70F3806	<i>μ</i> PD70F3738
<i>μ</i> PD70F3799	<i>μ</i> PD70F3807	<i>μ</i> PD70F3792
<i>μ</i> PD70F3800	<i>μ</i> PD70F3808	<i>μ</i> PD70F3793
<i>μ</i> PD70F3801	<i>μ</i> PD70F3840	<i>μ</i> PD70F3794
<i>μ</i> PD70F3802		<i>μ</i> PD70F3795
<i>μ</i> PD70F3803	V850ES/JF3-L	<i>μ</i> PD70F3796
<i>μ</i> PD70F3804	<i>μ</i> PD70F3735	<i>μ</i> PD70F3841
<i>μ</i> PD70F3838	<i>μ</i> PD70F3736	<i>μ</i> PD70F3842
<i>μ</i> PD70F3839		<i>μ</i> PD70F3843
		<i>μ</i> PD70F3844

The mark <R> shows major revised points.

The revised points can be easily searched by copying an "<R>" in the PDF file and specifying it in the "Find what:" field.

## CONTENTS

<b>CHAPTER 1</b>	<b>FLASH MEMORY PROGRAMMING</b>	<b>9</b>
1.1	Overview	9
1.2	System Configuration	10
1.3	Flash Memory Configuration	11
1.4	Command List and Status List	16
1.4.1	Command list	16
1.4.2	Status list	17
1.5	Power Application and Setting Flash Memory Programming Mode	18
1.5.1	UART communication mode	19
1.5.2	3-wire serial I/O communication mode with handshake supported (CSI + HS)	19
1.5.3	3-wire serial I/O communication mode (CSI)	20
1.5.4	Mode setting flowchart	21
1.5.5	Sample program	22
1.6	Shutting Down Target Power Supply	24
1.7	Command Execution Flow at Flash Memory Rewriting	24
<b>CHAPTER 2</b>	<b>COMMAND/DATA FRAME FORMAT</b>	<b>27</b>
2.1	Command Frame Transmission Processing	29
2.2	Data Frame Transmission Processing	29
2.3	Data Frame Reception Processing	29
<b>CHAPTER 3</b>	<b>DESCRIPTION OF COMMAND PROCESSING</b>	<b>30</b>
3.1	Status Command	30
3.1.1	Description	30
3.1.2	Command frame and status frame	30
3.2	Reset Command	31
3.2.1	Description	31
3.2.2	Command frame and status frame	31
3.3	Baud Rate Set Command	32
3.3.1	Description	32
3.3.2	Command frame and status frame	32
3.4	Oscillating Frequency Set Command	33
3.4.1	Description	33
3.4.2	Command frame and status frame	33
3.5	Chip Erase Command	35
3.5.1	Description	35
3.5.2	Command frame and status frame	35
3.6	Block Erase Command	36
3.6.1	Description	36
3.6.2	Command frame and status frame	36
3.7	Programming Command	37
3.7.1	Description	37
3.7.2	Command frame and status frame	37
3.7.3	Data frame and status frame	37
3.7.4	Completion of transferring all data and status frame	38

<b>3.8</b>	<b>Verify Command</b> .....	<b>39</b>
3.8.1	Description .....	39
3.8.2	Command frame and status frame .....	39
3.8.3	Data frame and status frame .....	39
<b>3.9</b>	<b>Block Blank Check Command</b> .....	<b>41</b>
3.9.1	Description .....	41
3.9.2	Command frame and status frame .....	41
<b>3.10</b>	<b>Silicon Signature Command</b> .....	<b>42</b>
3.10.1	Description .....	42
3.10.2	Command frame and status frame .....	42
3.10.3	Silicon signature data frame .....	42
3.10.4	V850ES/Jx3-L Silicon Signature Data List .....	44
<b>3.11</b>	<b>Version Get Command</b> .....	<b>46</b>
3.11.1	Description .....	46
3.11.2	Command frame and status frame .....	46
3.11.3	Version data frame .....	47
<b>3.12</b>	<b>Checksum Command</b> .....	<b>48</b>
3.12.1	Description .....	48
3.12.2	Command frame and status frame .....	48
3.12.3	Checksum data frame .....	48
<b>3.13</b>	<b>Security Set Command</b> .....	<b>49</b>
3.13.1	Description .....	49
3.13.2	Command frame and status frame .....	49
3.13.3	Data frame and status frame .....	50
3.13.4	Internal verify check and status frame .....	50
<b>3.14</b>	<b>Read Command</b> .....	<b>52</b>
3.14.1	Description .....	52
3.14.2	Command frame and status frame .....	52
3.14.3	Data frame and status frame .....	52
<b>CHAPTER 4</b>	<b>UART COMMUNICATION MODE</b> .....	<b>54</b>
<b>4.1</b>	<b>Command Frame Transmission Processing Flowchart</b> .....	<b>54</b>
<b>4.2</b>	<b>Data Frame Transmission Processing Flowchart</b> .....	<b>55</b>
<b>4.3</b>	<b>Data Frame Reception Processing Flowchart</b> .....	<b>56</b>
<b>4.4</b>	<b>Reset Command</b> .....	<b>57</b>
4.4.1	Processing sequence chart .....	57
4.4.2	Description of processing sequence .....	58
4.4.3	Status at processing completion .....	58
4.4.4	Flowchart .....	59
4.4.5	Sample program .....	60
<b>4.5</b>	<b>Baud Rate Set Command</b> .....	<b>61</b>
4.5.1	Processing sequence chart .....	61
4.5.2	Description of processing sequence .....	62
4.5.3	Status at processing completion .....	62
4.5.4	Flowchart .....	63
4.5.5	Sample program .....	64
<b>4.6</b>	<b>Oscillating Frequency Set Command</b> .....	<b>66</b>
4.6.1	Processing sequence chart .....	66
4.6.2	Description of processing sequence .....	67
4.6.3	Status at processing completion .....	67

4.6.4	Flowchart .....	68
4.6.5	Sample program .....	69
<b>4.7</b>	<b>Chip Erase Command .....</b>	<b>70</b>
4.7.1	Processing sequence chart .....	70
4.7.2	Description of processing sequence .....	71
4.7.3	Status at processing completion .....	71
4.7.4	Flowchart .....	72
4.7.5	Sample program .....	73
<b>4.8</b>	<b>Block Erase Command .....</b>	<b>74</b>
4.8.1	Processing sequence chart .....	74
4.8.2	Description of processing sequence .....	75
4.8.3	Status at processing completion .....	75
4.8.4	Flowchart .....	76
4.8.5	Sample program .....	77
<b>4.9</b>	<b>Programming Command.....</b>	<b>78</b>
4.9.1	Processing sequence chart .....	78
4.9.2	Description of processing sequence .....	79
4.9.3	Status at processing completion .....	80
4.9.4	Flowchart .....	81
4.9.5	Sample program .....	82
<b>4.10</b>	<b>Verify Command .....</b>	<b>84</b>
4.10.1	Processing sequence chart .....	84
4.10.2	Description of processing sequence .....	85
4.10.3	Status at processing completion .....	85
4.10.4	Flowchart .....	86
4.10.5	Sample program .....	87
<b>4.11</b>	<b>Block Blank Check Command .....</b>	<b>89</b>
4.11.1	Processing sequence chart .....	89
4.11.2	Description of processing sequence .....	90
4.11.3	Status at processing completion .....	90
4.11.4	Flowchart .....	91
4.11.5	Sample program .....	92
<b>4.12</b>	<b>Silicon Signature Command .....</b>	<b>93</b>
4.12.1	Processing sequence chart .....	93
4.12.2	Description of processing sequence .....	94
4.12.3	Status at processing completion .....	94
4.12.4	Flowchart .....	95
4.12.5	Sample program .....	96
<b>4.13</b>	<b>Version Get Command.....</b>	<b>97</b>
4.13.1	Processing sequence chart .....	97
4.13.2	Description of processing sequence .....	98
4.13.3	Status at processing completion .....	98
4.13.4	Flowchart .....	99
4.13.5	Sample program .....	100
<b>4.14</b>	<b>Checksum Command.....</b>	<b>101</b>
4.14.1	Processing sequence chart .....	101
4.14.2	Description of processing sequence .....	102
4.14.3	Status at processing completion .....	102
4.14.4	Flowchart .....	103
4.14.5	Sample program .....	104

<b>4.15</b>	<b>Security Set Command</b> .....	<b>105</b>
4.15.1	Processing sequence chart .....	105
4.15.2	Description of processing sequence .....	106
4.15.3	Status at processing completion .....	107
4.15.4	Flowchart .....	108
4.15.5	Sample program .....	109
<b>4.16</b>	<b>Read Command</b> .....	<b>111</b>
4.16.1	Processing sequence chart .....	111
4.16.2	Description of processing sequence .....	112
4.16.3	Status at processing completion .....	112
4.16.4	Flowchart .....	113
4.16.5	Sample program .....	114
<b>CHAPTER 5</b>	<b>3-WIRE SERIAL I/O COMMUNICATION MODE WITH HANDSHAKE SUPPORTED (CSI + HS)</b> .....	<b>116</b>
<b>5.1</b>	<b>Command Frame Transmission Processing Flowchart</b> .....	<b>116</b>
<b>5.2</b>	<b>Data Frame Transmission Processing Flowchart</b> .....	<b>117</b>
<b>5.3</b>	<b>Data Frame Reception Processing Flowchart</b> .....	<b>118</b>
<b>5.4</b>	<b>Status Command</b> .....	<b>119</b>
5.4.1	Processing sequence chart .....	119
5.4.2	Description of processing sequence .....	120
5.4.3	Status at processing completion .....	120
5.4.4	Flowchart .....	121
5.4.5	Sample program .....	122
<b>5.5</b>	<b>Reset Command</b> .....	<b>123</b>
5.5.1	Processing sequence chart .....	123
5.5.2	Description of processing sequence .....	124
5.5.3	Status at processing completion .....	124
5.5.4	Flowchart .....	125
5.5.5	Sample program .....	126
<b>5.6</b>	<b>Oscillating Frequency Set Command</b> .....	<b>127</b>
5.6.1	Processing sequence chart .....	127
5.6.2	Description of processing sequence .....	128
5.6.3	Status at processing completion .....	128
5.6.4	Flowchart .....	129
5.6.5	Sample program .....	130
<b>5.7</b>	<b>Chip Erase Command</b> .....	<b>131</b>
5.7.1	Processing sequence chart .....	131
5.7.2	Description of processing sequence .....	132
5.7.3	Status at processing completion .....	132
5.7.4	Flowchart .....	133
5.7.5	Sample program .....	134
<b>5.8</b>	<b>Block Erase Command</b> .....	<b>135</b>
5.8.1	Processing sequence chart .....	135
5.8.2	Description of processing sequence .....	136
5.8.3	Status at processing completion .....	136
5.8.4	Flowchart .....	137
5.8.5	Sample program .....	138

<b>5.9</b>	<b>Programming Command</b> .....	<b>139</b>
5.9.1	Processing sequence chart .....	139
5.9.2	Description of processing sequence .....	140
5.9.3	Status at processing completion .....	141
5.9.4	Flowchart .....	142
5.9.5	Sample program .....	143
<b>5.10</b>	<b>Verify Command</b> .....	<b>145</b>
5.10.1	Processing sequence chart .....	145
5.10.2	Description of processing sequence .....	146
5.10.3	Status at processing completion .....	147
5.10.4	Flowchart .....	148
5.10.5	Sample program .....	149
<b>5.11</b>	<b>Block Blank Check Command</b> .....	<b>151</b>
5.11.1	Processing sequence chart .....	151
5.11.2	Description of processing sequence .....	152
5.11.3	Status at processing completion .....	152
5.11.4	Flowchart .....	153
5.11.5	Sample program .....	154
<b>5.12</b>	<b>Silicon Signature Command</b> .....	<b>155</b>
5.12.1	Processing sequence chart .....	155
5.12.2	Description of processing sequence .....	156
5.12.3	Status at processing completion .....	156
5.12.4	Flowchart .....	157
5.12.5	Sample program .....	158
<b>5.13</b>	<b>Version Get Command</b> .....	<b>159</b>
5.13.1	Processing sequence chart .....	159
5.13.2	Description of processing sequence .....	160
5.13.3	Status at processing completion .....	160
5.13.4	Flowchart .....	161
5.13.5	Sample program .....	162
<b>5.14</b>	<b>Checksum Command</b> .....	<b>163</b>
5.14.1	Processing sequence chart .....	163
5.14.2	Description of processing sequence .....	164
5.14.3	Status at processing completion .....	164
5.14.4	Flowchart .....	165
5.14.5	Sample program .....	166
<b>5.15</b>	<b>Security Set Command</b> .....	<b>168</b>
5.15.1	Processing sequence chart .....	168
5.15.2	Description of processing sequence .....	169
5.15.3	Status at processing completion .....	170
5.15.4	Flowchart .....	171
5.15.5	Sample program .....	172
<b>5.16</b>	<b>Read Command</b> .....	<b>174</b>
5.16.1	Processing sequence chart .....	174
5.16.2	Description of processing sequence .....	175
5.16.3	Status at processing completion .....	176
5.16.4	Flowchart .....	177
5.16.5	Sample program .....	178

<b>CHAPTER 6</b>	<b>3-WIRE SERIAL I/O COMMUNICATION MODE (CSI)</b>	<b>180</b>
<b>6.1</b>	<b>Command Frame Transmission Processing Flowchart</b>	<b>180</b>
<b>6.2</b>	<b>Data Frame Transmission Processing Flowchart</b>	<b>181</b>
<b>6.3</b>	<b>Data Frame Reception Processing Flowchart</b>	<b>182</b>
<b>6.4</b>	<b>Status Command</b>	<b>183</b>
6.4.1	Processing sequence chart	183
6.4.2	Description of processing sequence	184
6.4.3	Status at processing completion	184
6.4.4	Flowchart	185
6.4.5	Sample program	186
<b>6.5</b>	<b>Reset Command</b>	<b>188</b>
6.5.1	Processing sequence chart	188
6.5.2	Description of processing sequence	189
6.5.3	Status at processing completion	189
6.5.4	Flowchart	190
6.5.5	Sample program	191
<b>6.6</b>	<b>Oscillating Frequency Set Command</b>	<b>192</b>
6.6.1	Processing sequence chart	192
6.6.2	Description of processing sequence	193
6.6.3	Status at processing completion	193
6.6.4	Flowchart	194
6.6.5	Sample program	195
<b>6.7</b>	<b>Chip Erase Command</b>	<b>196</b>
6.7.1	Processing sequence chart	196
6.7.2	Description of processing sequence	197
6.7.3	Status at processing completion	197
6.7.4	Flowchart	198
6.7.5	Sample program	199
<b>6.8</b>	<b>Block Erase Command</b>	<b>200</b>
6.8.1	Processing sequence chart	200
6.8.2	Description of processing sequence	201
6.8.3	Status at processing completion	201
6.8.4	Flowchart	202
6.8.5	Sample program	203
<b>6.9</b>	<b>Programming Command</b>	<b>204</b>
6.9.1	Processing sequence chart	204
6.9.2	Description of processing sequence	205
6.9.3	Status at processing completion	206
6.9.4	Flowchart	207
6.9.5	Sample program	208
<b>6.10</b>	<b>Verify Command</b>	<b>210</b>
6.10.1	Processing sequence chart	210
6.10.2	Description of processing sequence	211
6.10.3	Status at processing completion	211
6.10.4	Flowchart	212
6.10.5	Sample program	213
<b>6.11</b>	<b>Block Blank Check Command</b>	<b>215</b>
6.11.1	Processing sequence chart	215
6.11.2	Description of processing sequence	216

6.11.3	Status at processing completion .....	216
6.11.4	Flowchart .....	217
6.11.5	Sample program .....	218
<b>6.12</b>	<b>Silicon Signature Command .....</b>	<b>219</b>
6.12.1	Processing sequence chart .....	219
6.12.2	Description of processing sequence .....	220
6.12.3	Status at processing completion .....	220
6.12.4	Flowchart .....	221
6.12.5	Sample program .....	222
<b>6.13</b>	<b>Version Get Command.....</b>	<b>223</b>
6.13.1	Processing sequence chart .....	223
6.13.2	Description of processing sequence .....	224
6.13.3	Status at processing completion .....	224
6.13.4	Flowchart .....	225
6.13.5	Sample program .....	226
<b>6.14</b>	<b>Checksum Command.....</b>	<b>227</b>
6.14.1	Processing sequence chart .....	227
6.14.2	Description of processing sequence .....	228
6.14.3	Status at processing completion .....	228
6.14.4	Flowchart .....	229
6.14.5	Sample program .....	230
<b>6.15</b>	<b>Security Set Command .....</b>	<b>231</b>
6.15.1	Processing sequence chart .....	231
6.15.2	Description of processing sequence .....	232
6.15.3	Status at processing completion .....	233
6.15.4	Flowchart .....	234
6.15.5	Sample program .....	235
<b>6.16</b>	<b>Read Command .....</b>	<b>237</b>
6.16.1	Processing sequence chart .....	237
6.16.2	Description of processing sequence .....	238
6.16.3	Status at processing completion .....	238
6.16.4	Flowchart .....	239
6.16.5	Sample program .....	240
<b>CHAPTER 7</b>	<b>FLASH MEMORY PROGRAMMING PARAMETER CHARACTERISTICS...242</b>	
<b>APPENDIX A</b>	<b>CIRCUIT DIAGRAM (REFERENCE).....265</b>	



**CHAPTER 1 FLASH MEMORY PROGRAMMING**

To rewrite the contents of the internal flash memory of the V850ES/Jx3-L, a dedicated flash memory programmer (hereafter referred to as the “programmer”) is usually used.

This Application Note explains how to develop a dedicated programmer.

**1.1 Overview**

The V850ES/Jx3-L incorporates firmware that controls flash memory programming. The programming to the internal flash memory is performed by transmitting/receiving commands between the programmer and the V850ES/Jx3-L via serial communication.

**Figure 1-1. System Outline of Flash Memory Programming in V850ES/Jx3-L**

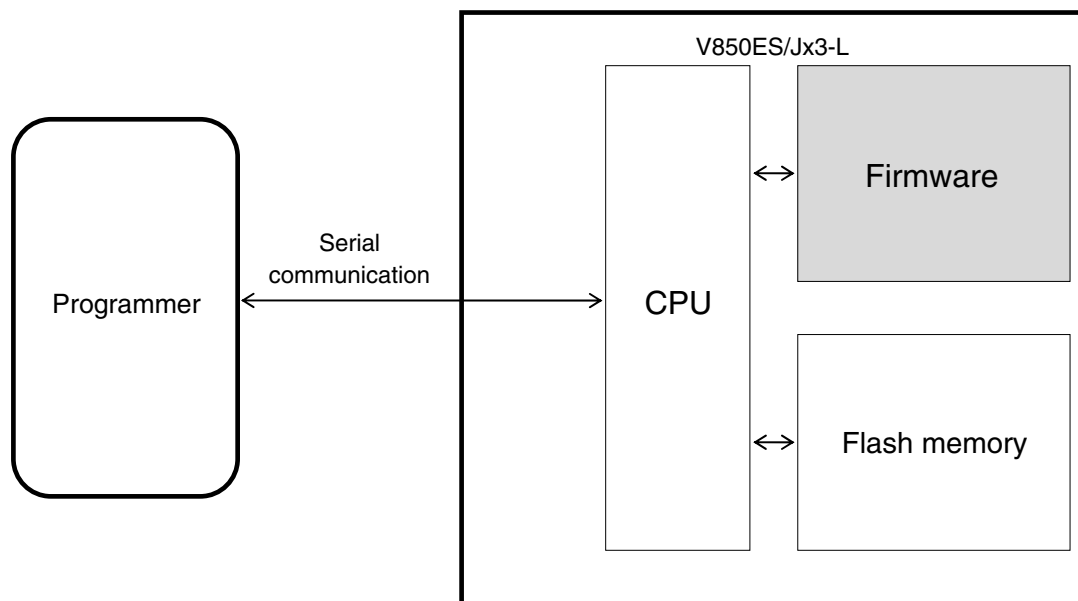

## 1.2 System Configuration

Examples of the system configuration for programming the flash memory are illustrated in Figure 1-2.

These figures illustrate how to program the flash memory with the programmer, under control of a host machine.

Depending on how the programmer is connected, the programmer can be used in a standalone mode without using the host machine, if a user program has been downloaded to the programmer in advance.

For example, Renesas Electronics' flash memory programmer PG-FP5 can execute programming either by using the GUI software with a host machine connected or by itself (standalone).

Figure 1-2. System Configuration Example

### (1) UART communication mode (LSB-first transfer)

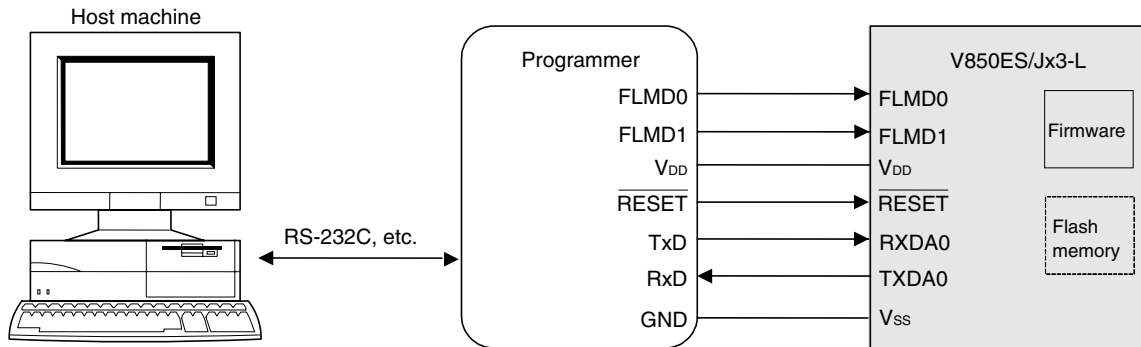

### (2) 3-wire serial I/O communication mode with handshake supported (CSI + HS) (MSB-first transfer)

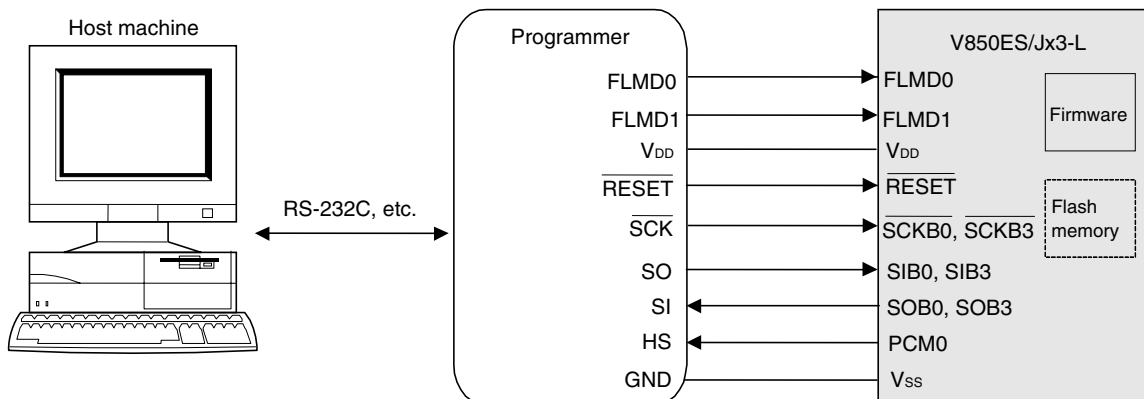

### (3) 3-wire serial I/O communication mode (CSI) (MSB-first transfer)

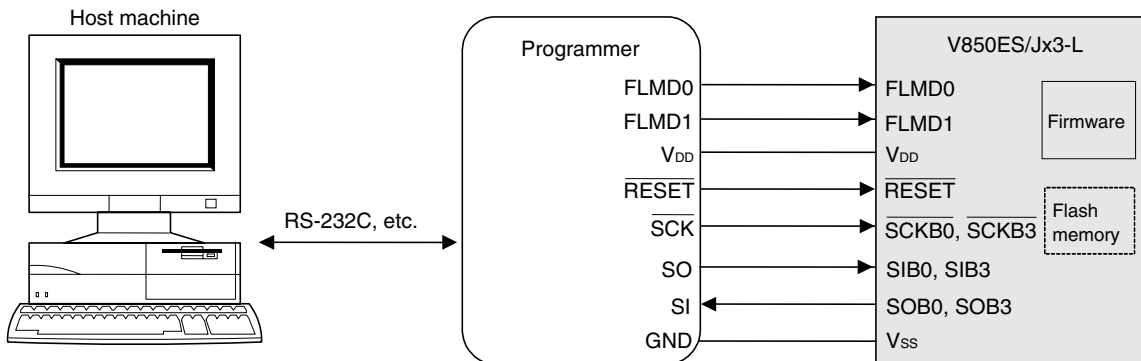

**Remark** For the pins used by flash memory programming and the recommended connections of unused pins, see the user's manual of each product.

### 1.3 Flash Memory Configuration

The V850ES/Jx3-L must manage product-specific information (such as device name and memory information) via programmer.

Table 1-1 shows the flash memory size of the V850ES/Jx3-L and Figure 1-3 shows the configuration of the flash memory.

**Table 1-1. Flash Memory Size of V850ES/Jx3-L**

Device Name	Flash Memory Size
$\mu$ PD70F3797, 70F3801, 70F3805	16 KB
$\mu$ PD70F3798, 70F3802, 70F3806	32 KB
$\mu$ PD70F3799, 70F3803, 70F3807	64 KB
$\mu$ PD70F3800, 70F3804, 70F3808, 70F3735, 70F3737	128 KB
$\mu$ PD70F3736, 70F3738, 70F3794, 70F3838, 70F3839, 70F3840	256 KB
$\mu$ PD70F3792, 70F3795	384 KB
$\mu$ PD70F3793, 70F3796	512 KB
$\mu$ PD70F3841, 70F3843	768 KB
$\mu$ PD70F3842, 70F3844	1 MB

**Figure 1-3. Flash Memory Configuration (1/4)**

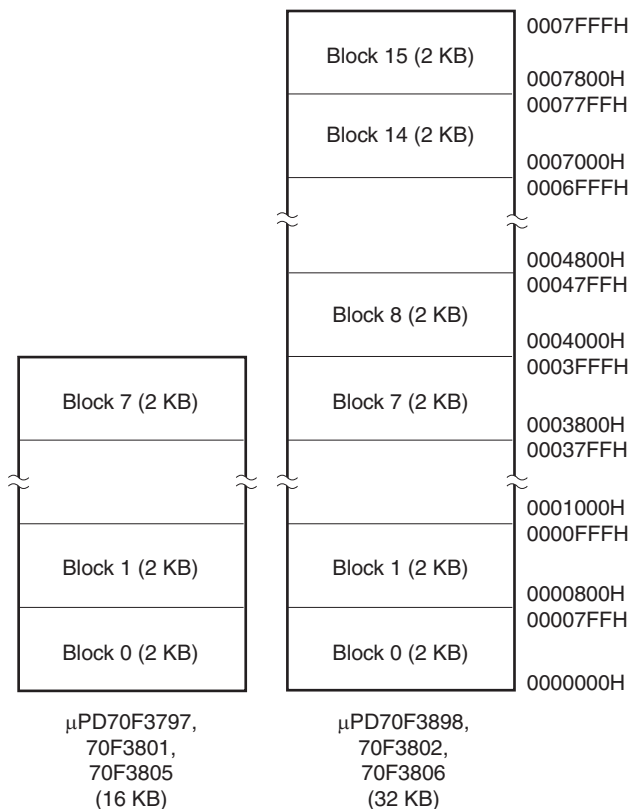

- Remarks 1.** The boot swap function is not available on products whose flash memory capacity is 16 KB or 32 KB.
- 2.** Each block consists of 2 KB (this figure only illustrates some parts of entire blocks in the flash memory).

Figure 1-3. Flash Memory Configuration (2/4)

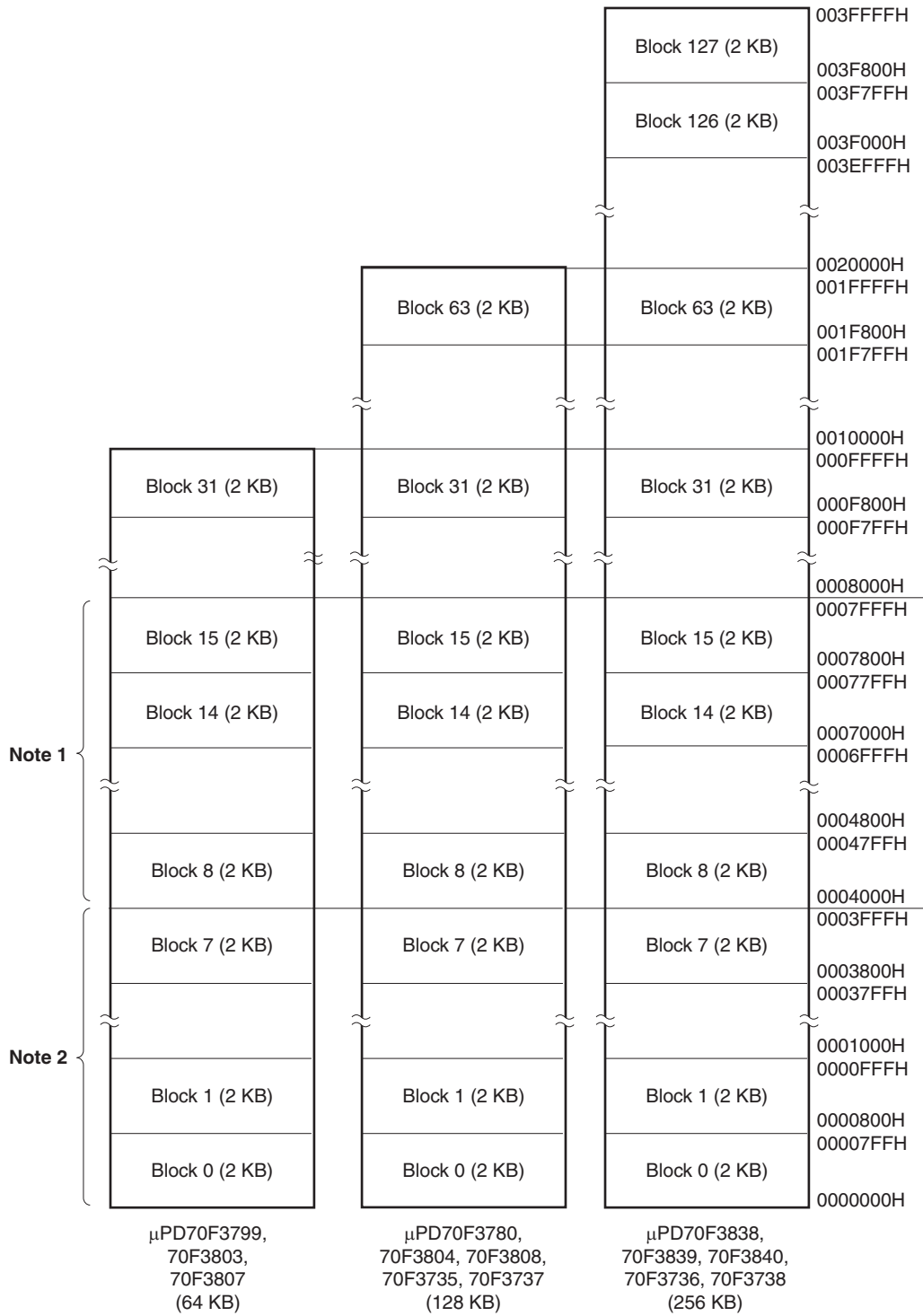

**Notes** 1. Area to be replaced with the boot area by the boot swap function  
2. Boot area

Figure 1-3. Flash Memory Configuration (3/4)

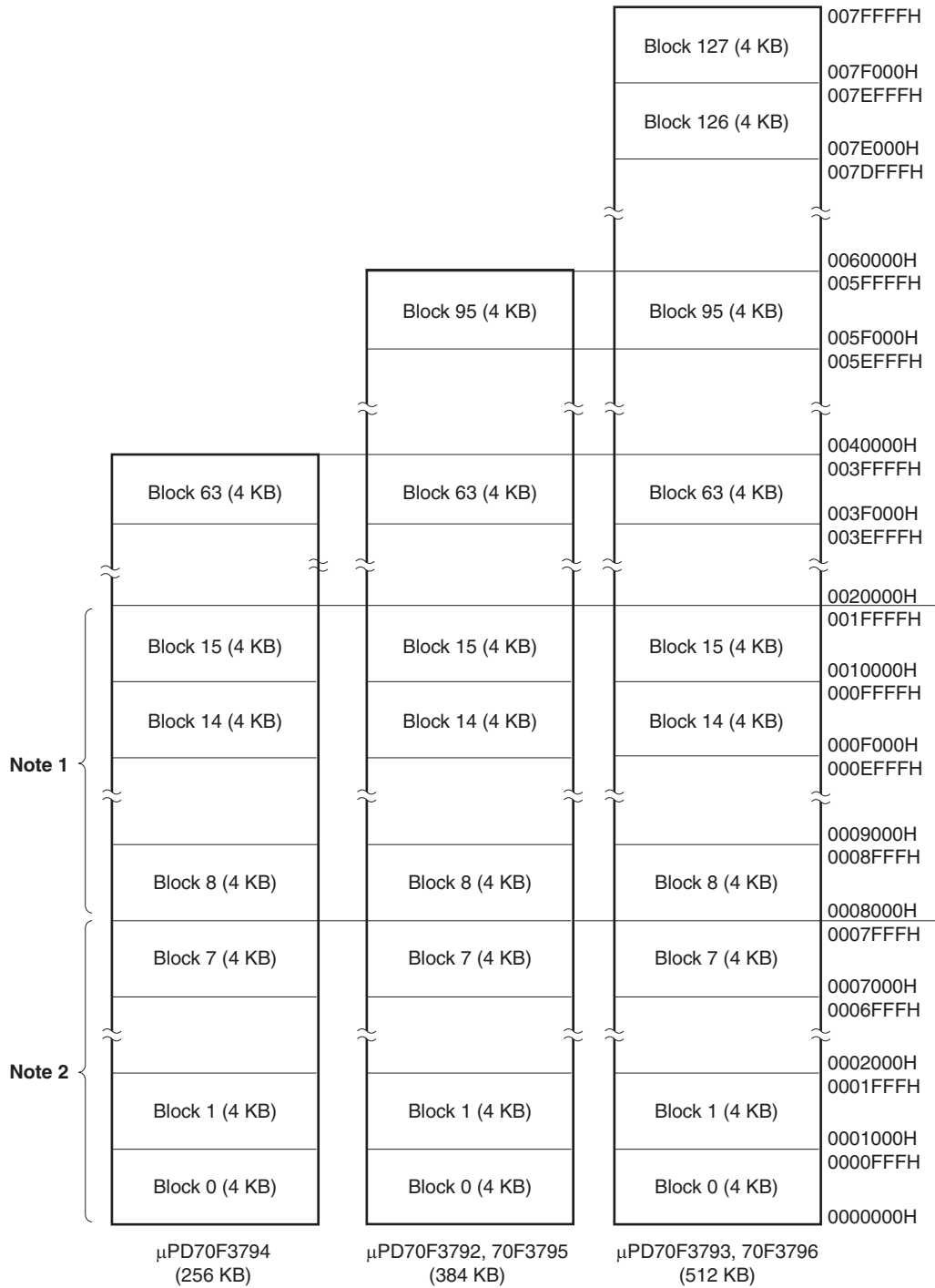

- Notes**
1. Area to be replaced with the boot area by the boot swap function
  2. Boot area

**Remark** Each block consists of 4 KB (this figure only illustrates some parts of entire blocks in the flash memory).

Figure 1-3. Flash Memory Configuration (4/4)

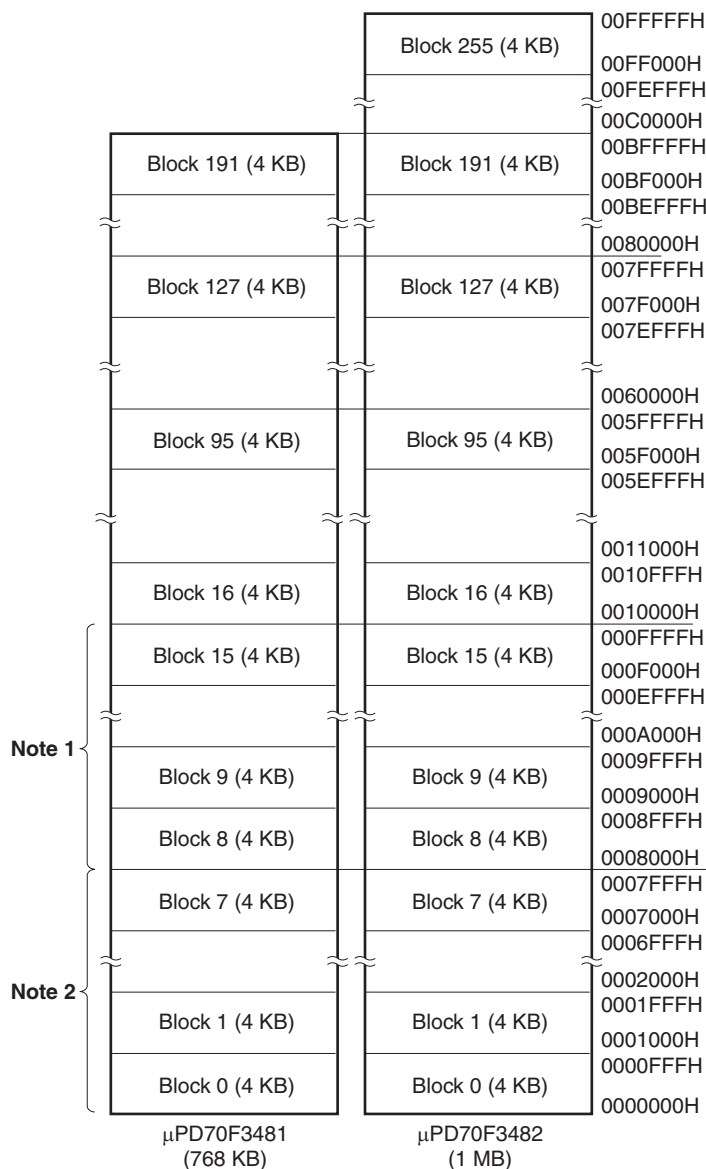

- Notes**
1. Area to be replaced with the boot area by the boot swap function
  2. Boot area

**Remark** Each block consists of 4 KB (this figure only illustrates some parts of entire blocks in the flash memory).

## 1.4 Command List and Status List

The flash memory incorporated in the V850ES/Jx3-L has functions to manipulate the flash memory, as listed in Table 1-2. The programmer transmits commands to control these functions to the V850ES/Jx3-L, and checks the response status sent from the V850ES/Jx3-L, to manipulate the flash memory.

### 1.4.1 Command list

The commands used by the programmer and their functions are listed below.

**Table 1-2. List of Commands Transmitted from Programmer to V850ES/Jx3-L**

Command Number	Command Name	Function Name	Function
20H	Chip Erase	Erase	Erases the entire flash memory area.
22H	Block Erase		Erases a specified area in the flash memory.
40H	Programming	Write	Writes data to a specified area in the flash memory.
13H	Verify	Verify	Compares the contents in a specified area in the flash memory with data transmitted from the programmer.
32H	Block Blank Check	Blank check	Checks the erase status of a specified block in the flash memory.
50H	Read	Read	Reads data in the specified flash memory area.
70H	Status	Information acquisition	Acquires the current operating status (status data).
C0H	Silicon Signature		Acquires V850ES/Jx3-L information (write protocol information).
C5H	Version Get		Acquires version information of the V850ES/Jx3-L and firmware.
B0H	Checksum		Acquires checksum data of a specified area.
A0H	Security Set	Security	Sets security information.
00H	Reset	Others	Detects synchronization in communication.
90H	Oscillating Frequency Set		Specifies the oscillation frequency of the V850ES/Jx3-L.
9AH	Baud Rate Set		Sets baud rate when UART communication mode is selected.



**1.4.2 Status list**

The following table lists the status codes the programmer receives from the V850ES/Jx3-L.

**Table 1-3. Status Code List**

Status Code	Status	Description
04H	Command number error	Error returned if a command not supported is received
05H	Parameter error	Error returned if command information (parameter) is invalid
06H	Normal acknowledgment (ACK)	Normal acknowledgment
07H	Checksum error	Error returned if data in a frame transmitted from the programmer is abnormal
0FH	Verify error	Error returned if a verify error has occurred upon verifying data transmitted from the programmer
10H	Protect error	Error returned if an attempt is made to execute processing that is prohibited by the Security Set command
15H	Negative acknowledgment (NACK)	Negative acknowledgment
1AH	MRG10 error	Erase verify error
1BH	MRG11 error	Internal verify error or blank check error during data write
1CH	Write error	Write error
20H	Read error	Error returned when reading of security information failed
FFH	Processing in progress (BUSY)	Busy response <sup>Note</sup>

**Note** During CSI communication, 1-byte FFH might be transmitted, as well as FFH as the data frame format.

Reception of a checksum error or NACK is treated as an immediate abnormal end in this manual. When a dedicated programmer is developed, however, the processing might be retried without problem from the wait immediately before transmission of the command that results a checksum error or NACK. In this event, limiting the retry count is recommended for preventing infinite repetition of the retry operation.

Although not listed in the above table, if a time-out error (BUSY time-out or time-out in data frame reception during UART communication) occurs, it is recommended to shutdown the power supply to the V850ES/Jx3-L (see *1.6 Shutting Down Target Power Supply*) and then connect the power supply again.

### 1.5 Power Application and Setting Flash Memory Programming Mode

To rewrite the contents of the flash memory with the programmer, the V850ES/Jx3-L must first be set to the flash memory programming mode by supplying a specific voltage to the flash memory programming mode setting pin (FLMD0, FLMD1) in the V850ES/Jx3-L, then releasing a reset.

To select a communication mode for flash memory programming, input pulses to FLMD0 pin in the flash memory programming mode.

The following illustrates a timing chart for setting the flash memory programming mode and selecting the communication mode.

**Figure 1-4. Setting Flash Memory Programming Mode and Selecting Communication Mode**

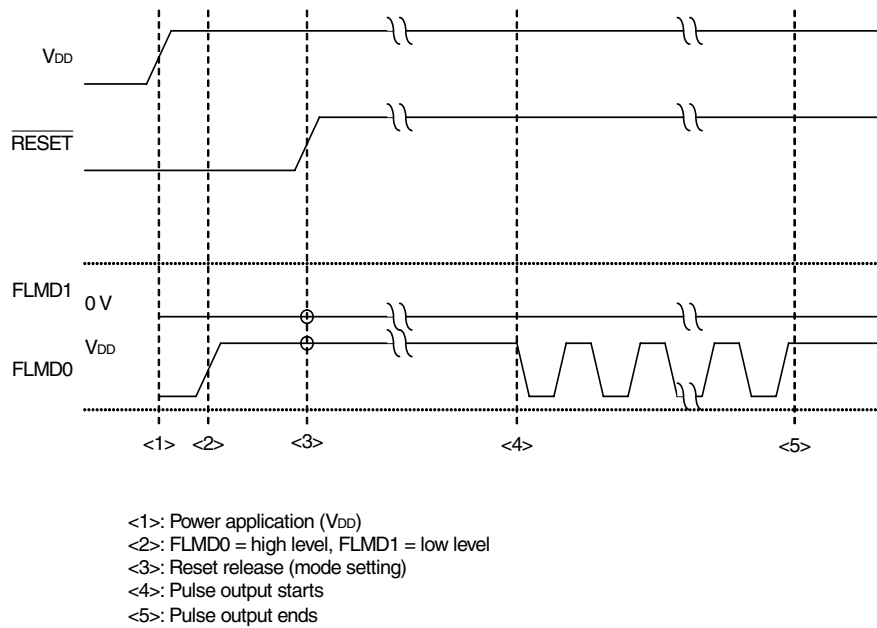

The relationship between the setting of the FLMD0 and FLMD1 pins after reset release and the operating mode is shown below.

**Table 1-4. Relationship Between FLMD0 Pin Setting After Reset Release and Operating Mode**

FLMD0	FLMD1	Operating Mode
Low (GND)	Any	Normal operating mode
High ( $V_{DD}$ )	Low (GND)	Flash memory programming mode
High ( $V_{DD}$ )	High ( $V_{DD}$ )	Setting prohibited

The following table shows the relationship between the number of FLMD0 pulses (pulse counts) and communication modes that can be selected with the V850ES/Jx3-L.

**Table 1-5. Relationship Between FLMD0 Pulse Counts and Communication Modes**

Communication Mode	FLMD0 Pulse Counts	Port Used for Communication
UART (UARTA0)	0	TXDA0 (P30), RXDA0 (P31)
3-wire serial I/O (CSIB0)	8	SOB0 (P41), SIB0 (P40), $\overline{\text{SCKB0}}$ (P42)
3-wire serial I/O (CSIB3)	9	SOB3 (P911), SIB3 (P910), $\overline{\text{SCKB3}}$ (P912)
3-wire serial I/O with handshake supported (CSIB0 + HS)	11	SOB0 (P41), SIB0 (P40), $\overline{\text{SCKB0}}$ (P42), HS (PCM0)
3-wire serial I/O with handshake supported (CSIB3 + HS)	12	SOB3 (P911), SIB3 (P910), $\overline{\text{SCKB3}}$ (P912), HS (PCM0)

### 1.5.1 UART communication mode

The RxD and TxD pins are used for UART communication. The communication conditions are as shown below.

**Table 1-6. UART Communication Conditions**

Item	Description
Baud rate	Selectable from 9,600, 19,200, 31,250, 38,400, 57,600, 76,800, 115,200, 128,000, and 153,600 bps (default: 9,600 bps)
Parity bit	None
Data length	8 bits (LSB first)
Stop bit	1 bit

The programmer always operates as the master device during CSI communication, so the programmer must check whether the processing by the V850ES/Jx3-L, such as writing or erasing, is normally completed. On the other hand, the status of the master and slave is occasionally exchanged during UART communication, so communication at the optimum timing is possible.

**Caution Set the same baud rate to the master and slave devices when performing UART communication.**

### 1.5.2 3-wire serial I/O communication mode with handshake supported (CSI + HS)

In the CSI + HS communication mode, the timing for communication of commands or data is optimized. In addition to the SI, SO and  $\overline{\text{SCK}}$  pins, the HS (handshake) pin is used for implementing effective communication.

The level of the HS pin signal falls (low level) when the V850ES/Jx3-L is ready for transmitting or receiving data. The programmer must check the falling edge of the HS pin signal (low level) before starting transmission/reception of commands or data to the V850ES/Jx3-L.

The communication data format is MSB-first, in 8-bit units. Keep the clock frequency 2.5 MHz or lower.

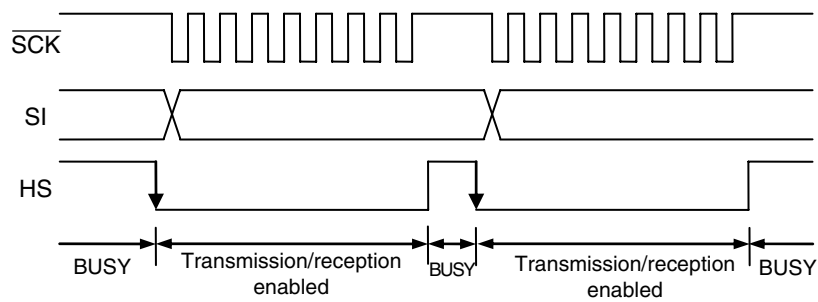
**Figure 1-5. Timing Chart of CSI + HS Communication**

### 1.5.3 3-wire serial I/O communication mode (CSI)

The  $\overline{\text{SCK}}$ , SO and SI pins are used for CSI communication. The programmer always operates as the master device, so communication might not be performed normally if data is transmitted via the  $\overline{\text{SCK}}$  pin while the V850ES/Jx3-L is not ready for transmission/reception.

The communication data format is MSB-first, in 8-bit units. Keep the clock frequency 2.5 MHz or lower.

1.5.4 Mode setting flowchart

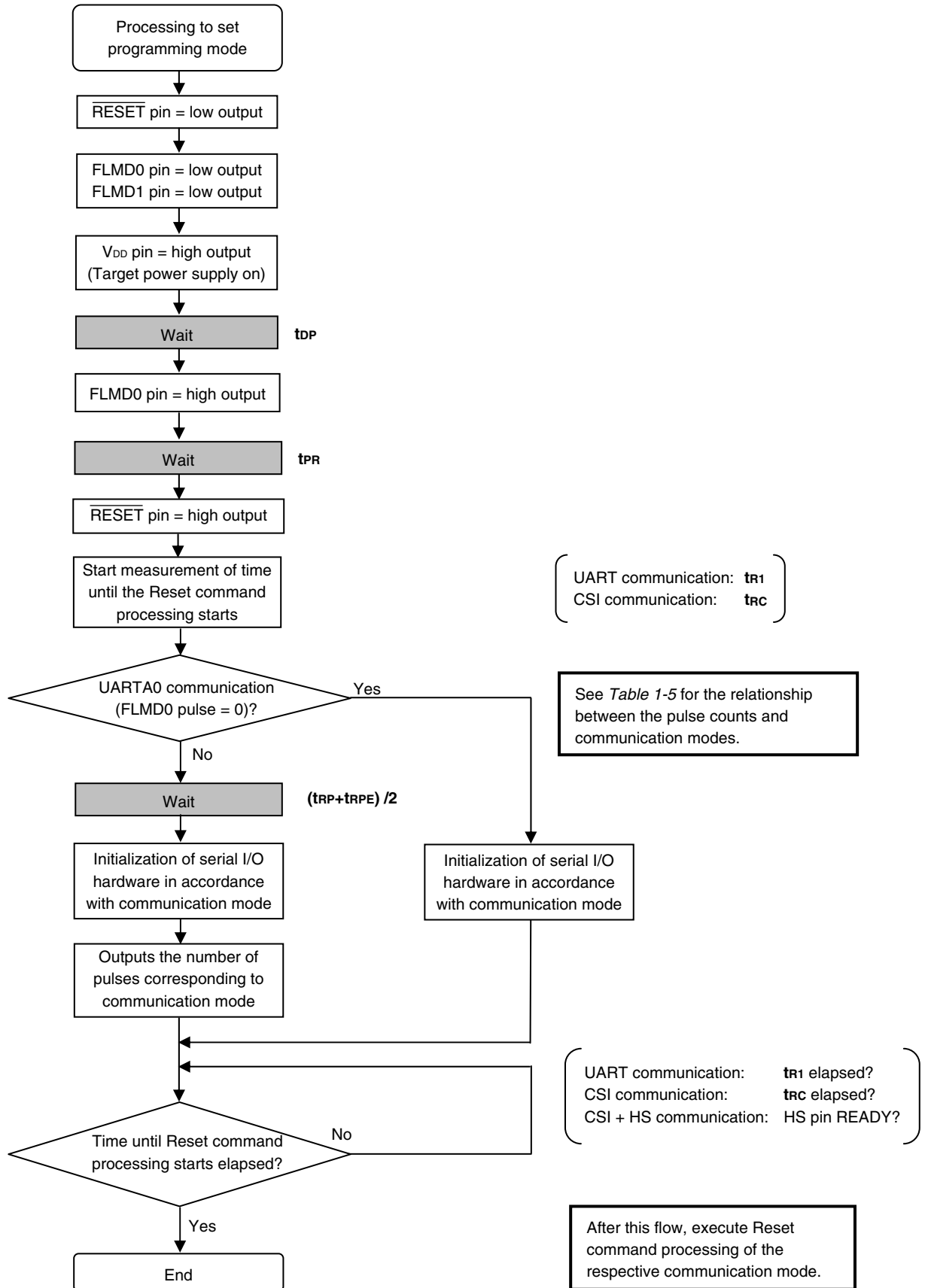

### 1.5.5 Sample program

The following shows a sample program for mode setting processing.

```

/*****
/*
/* connect to Flash device
/*
/*****

void
fl_con_dev(void)
{
extern void init_fl_uart(void);

extern void init_fl_csi(void);

int n;
int pulse;

SRMK0 = true;
UARTE0 = false;

switch (fl_if){
default:
case FLIF_UART:pulse = PULSE_UART; break;
case FLIF_CSI: pulse = UseCSIB3? PULSE_CSIB3: PULSE_CSI; break;
case FLIF_CSI_HS: pulse = UseCSIB3? PULSE_CSIB3HS: PULSE_CSIHS; break;
}

pFL_RES = low; // RESET/FLMD0 = low
pmFL_FLMD0 = PM_OUT; // FLMD0 = Low output
pFL_FLMD0 = low;
pmFL_FLMD1 = PM_OUT; // FLMD1 = Low output
pFL_FLMD1 = low;
FL_VDD_HI(); // VDD = high

fl_wait(tDP); // wait
pFL_FLMD0 = hi; // FLMD0 = high
fl_wait(tPR); // wait

pFL_RES = hi; // RESET = high
start_flto(tRC); // start "tRC" wait timer

fl_wait((tRP+tRPE)/2); // wait
if (fl_if == FLIF_UART){
init_fl_uart(); // Initialize UART h.w.(for Flash device control)

UARTE0 = true;
SRIF0 = false;
SRMK0 = false;
}
else{
init_fl_csi(); // Initialize CSI h.w.
}
for (n = 0; n < pulse; n++){ // pulse output

pFL_FLMD0 = low;
fl_wait(tPW);
}

```

```
        pFL_FLMD0 = hi;
        fl_wait(tpw);
    }
    while(!check_flto())           // timeout tRC ?
        ;                         // no

                                   // start RESET command proc.

}
```

## 1.6 Shutting Down Target Power Supply

After each command execution is completed, shut down the power supply to the target after setting the  $\overline{\text{RESET}}$  pin to low level, as shown below.

Set other pins to Hi-Z when shutting down the power supply to the target.

**Caution** Shutting down the power supply and inputting a reset during command processing are prohibited.

**Figure 1-6. Timing for Terminating Flash Memory Programming Mode**

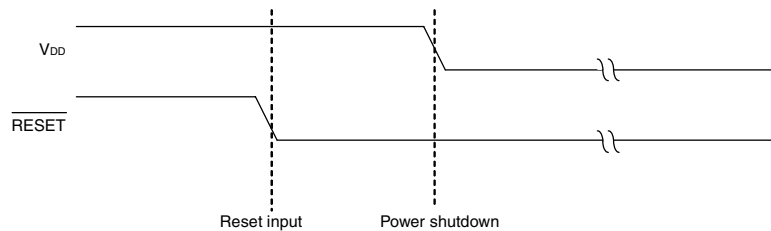

## 1.7 Command Execution Flow at Flash Memory Rewriting

Figure 1-7 illustrates the basic flowchart when flash memory rewriting is performed with the programmer.

Other than commands shown in the Figure 1-7, the Verify command and Checksum command are also supported.

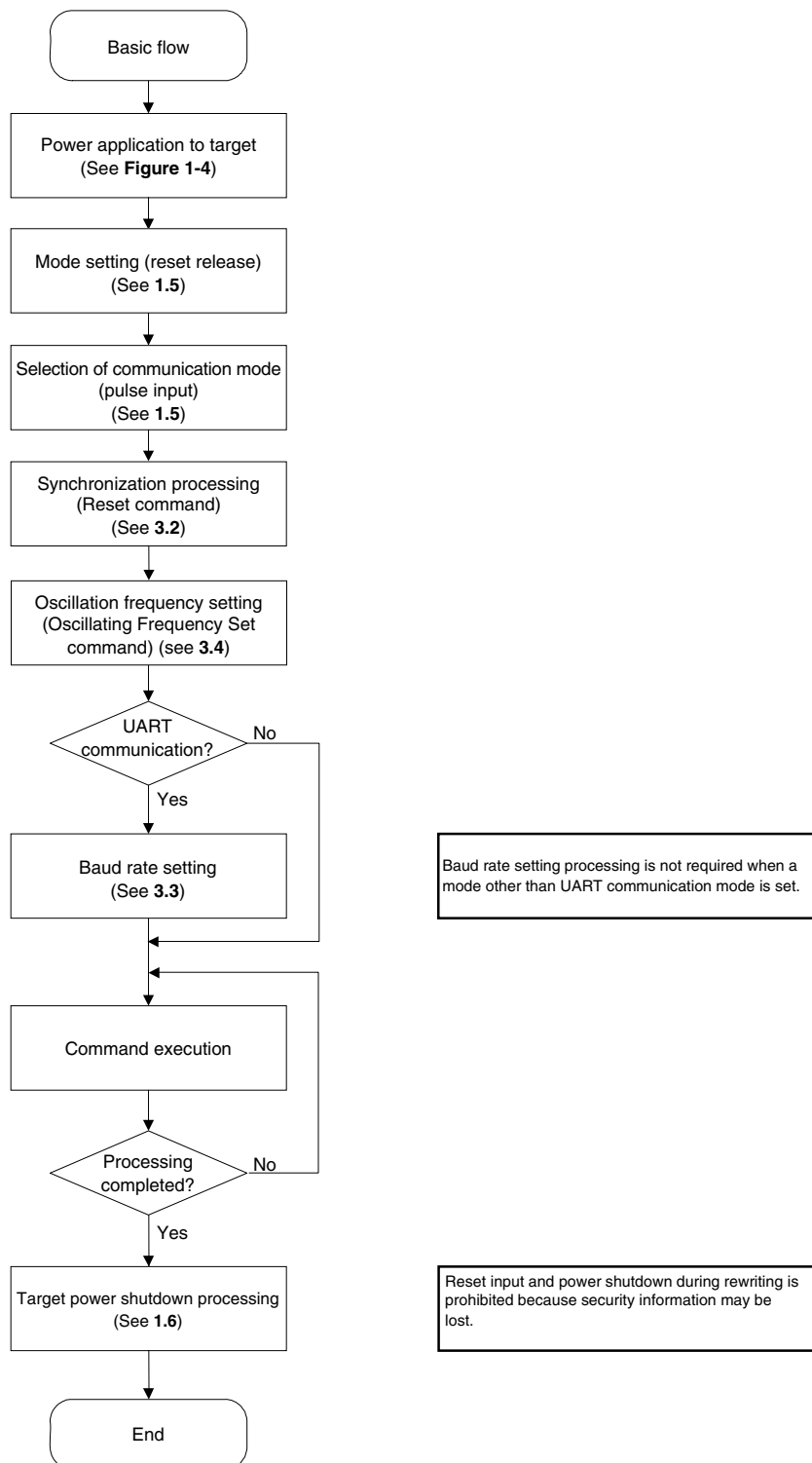

**Figure 1-7. Basic Flowchart for Flash Memory Rewrite Processing**

**Remark** The example of each command execution is shown in the Figure 1-8.

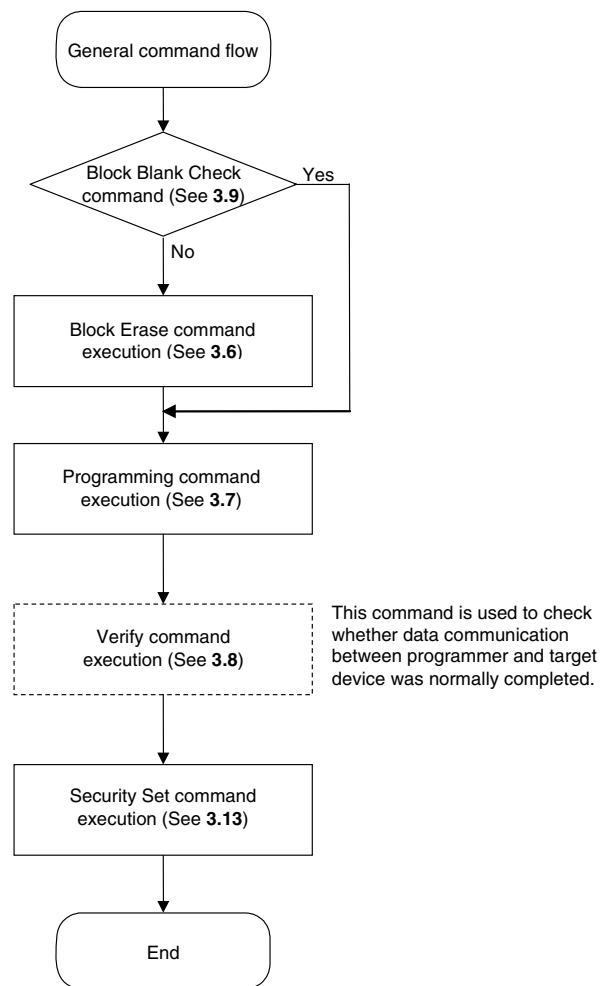
**Figure 1-8. General Command Execution Flow at Flash Memory Rewriting**

## CHAPTER 2 COMMAND/DATA FRAME FORMAT

The programmer uses the command frame to transmit commands to the V850ES/Jx3-L. The V850ES/Jx3-L uses the data frame to transmit write data or verify data from the programmer to the V850ES/Jx3-L. A header, footer, data length information, and checksum are appended to each frame to enhance the reliability of the transferred data.

The following shows the format of a command frame and data frame.

**Figure 2-1. Command Frame Format**

SOH (1 byte)	LEN (1 byte)	COM (1 byte)	Command information (variable length) (Max. 255 bytes)	SUM (1 byte)	ETX (1 byte)
-----------------	-----------------	-----------------	---	-----------------	-----------------

**Figure 2-2. Data Frame Format**

STX (1 byte)	LEN (1 byte)	Data (variable length) (Max. 256 bytes)	SUM (1 byte)	ETX or ETB (1 byte)
-----------------	-----------------	--	-----------------	------------------------

**Table 2-1. Description of Symbols in Each Frame**

Symbol	Value	Description
SOH	01H	Command frame header
STX	02H	Data frame header
LEN	–	Data length information (00H indicates 256). Command frame: COM + command information length Data frame: Data field length
COM	–	Command number
SUM	–	Checksum data for a frame Obtained by sequentially subtracting all of calculation target data from the initial value (00H) in 1-byte units (borrow is ignored). The calculation targets are as follows. Command frame: LEN + COM + all of command information Data frame: LEN + all of data
ETB	17H	Footer of data frame other than the last frame
ETX	03H	Command frame footer, or footer of last data frame

The following shows examples of calculating the checksum (SUM) for a frame.

**[Command frame]**

No command information is included in the following example of a Status command frame, so LEN and COM are targets of checksum calculation.

SOH	LEN	COM	SUM	ETX
01H	01H	70H	Checksum	03H
Checksum calculation targets				

For this command frame, checksum data is obtained as follows.

$$00\text{H (initial value)} - 01\text{H (LEN)} - 70\text{H (COM)} = 8\text{FH (Borrow ignored. Lower 8 bits only.)}$$

The command frame finally transmitted is as follows.

SOH	LEN	COM	SUM	ETX
01H	01H	70H	8FH	03H

**[Data frame]**

To transmit a data frame as shown below, LEN and D1 to D4 are targets of checksum calculation.

STX	LEN	D1	D2	D3	D4	SUM	ETX
02H	04H	FFH	80H	40H	22H	Checksum	03H
checksum calculation targets							

For this data frame, checksum data is obtained as follows.

$$00\text{H (initial value)} - 04\text{H (LEN)} - \text{FFH (D1)} - 80\text{H (D2)} - 40\text{H (D3)} - 22\text{H (D4)} \\ = 1\text{BH (Borrow ignored. Lower 8 bits only.)}$$

The data frame finally transmitted is as follows.

STX	LEN	D1	D2	D3	D4	SUM	ETX
02H	04H	FFH	80H	40H	22H	1BH	03H

When a data frame is received, the checksum data is calculated in the same manner, and the obtained value is used to detect a checksum error by judging whether the value is the same as that stored in the SUM field of the receive data. When a data frame as shown below is received, for example, a checksum error is detected.

STX	LEN	D1	D2	D3	D4	SUM	ETX
02H	04H	FFH	80H	40H	22H	1AH	03H

↑ Should be 1BH, if normal

## 2.1 Command Frame Transmission Processing

See *CHAPTER 4* to *CHAPTER 6* for details about flowcharts of command processing to transmit command frames, for each communication mode.

- For the UART communication mode, see *4.1 Flowchart of Command Frame Transmission Processing*.
- For the 3-wire serial I/O communication mode with handshake supported (CSI + HS), see *5.1 Flowchart of Command Frame Transmission Processing*.
- For the 3-wire serial I/O communication mode (CSI), see *6.1 Flowchart of Command Frame Transmission Processing*.

## 2.2 Data Frame Transmission Processing

The write data frame (user program), verify data frame (user program), and security data frame (security flag) are transmitted as a data frame.

See *CHAPTER 4* to *CHAPTER 6* for details about flowcharts of command processing to transmit data frames, for each communication mode.

- For the UART communication mode, see *4.2 Flowchart of Data Frame Transmission Processing*.
- For the 3-wire serial I/O communication mode with handshake supported (CSI + HS), see *5.2 Flowchart of Data Frame Transmission Processing*.
- For the 3-wire serial I/O communication mode (CSI), see *6.2 Flowchart of Data Frame Transmission Processing*.

## 2.3 Data Frame Reception Processing

The status frame, silicon signature data frame, version data frame, checksum data frame, and read data frame are received as a data frame.

See *CHAPTER 4* to *CHAPTER 6* for details about flowcharts of command processing to receive data frames, for each communication mode.

- For the UART communication mode, see *4.3 Flowchart of Data Frame Reception Processing*.
- For the 3-wire serial I/O communication mode with handshake supported (CSI + HS), see *5.3 Flowchart of Data Frame Reception Processing*.
- For the 3-wire serial I/O communication mode (CSI), see *6.3 Flowchart of Data Frame Reception Processing*.

## CHAPTER 3 DESCRIPTION OF COMMAND PROCESSING

### 3.1 Status Command

#### 3.1.1 Description

This command is used to check the operation status of the V850ES/Jx3-L after issuance of each command such as write or erase.

After the Status command is issued, if the Status command frame cannot be received normally in the V850ES/Jx3-L due to problems based on communication or the like, the status setting will not be performed in the V850ES/Jx3-L. As a result, a busy response (FFH), not the status frame, might be received. In such a case, retry the Status command.

#### 3.1.2 Command frame and status frame

Figure 3-1 shows the format of a command frame for the Status command, and Figure 3-2 shows the status frame for the command.

**Figure 3-1. Status Command Frame (from Programmer to V850ES/Jx3-L)**

SOH	LEN	COM	SUM	ETX
01H	01H	70H (Status)	Checksum	03H

**Figure 3-2. Status Frame for Status Command (from V850ES/Jx3-L to Programmer)**

STX	LEN	Data			SUM	ETX
02H	n	ST1	...	STn	Checksum	03H

- Remarks**
1. ST1 to STn: Status #1 to Status #n
  2. The length of a status frame varies according to each command (such as write or erase) to be transmitted to the V850ES/Jx3-L.

See *CHAPTER 4* to *CHAPTER 6* for details about flowcharts of processing sequences between the programmer and the V850ES/Jx3-L, flowcharts of command processing, and sample programs for each communication mode.

- The Status command is not used in the UART communication mode.
- For the 3-wire serial I/O communication mode with handshake supported (CSI + HS), see *5.4 Status Command*.
- For the 3-wire serial I/O communication mode (CSI), see *6.4 Status Command*.

**Caution** After each command such as write or erase is transmitted in UART communication, the V850ES/Jx3-L automatically returns the status frame within a specified time. The Status command is therefore not used.

If the Status command is transmitted in UART communication, the Command Number Error is returned.

## 3.2 Reset Command

### 3.2.1 Description

This command is used to check the establishment of communication between the programmer and the V850ES/Jx3-L after the communication mode is set.

When UART is selected as the mode for communication with the V850ES/Jx3-L, the same baud rate must be set in the programmer and V850ES/Jx3-L. However, the V850ES/Jx3-L cannot detect its own operating frequency so the baud rate cannot be set. It makes detection of the operating frequency in the V850ES/Jx3-L possible by sending "00H" twice at 9,600 bps from the programmer, measuring the low-level width of "00H", and then calculating the average of two sent signals. The baud rate can consequently be set, which enables synchronous detection in communication.

### 3.2.2 Command frame and status frame

Figure 3-3 shows the format of a command frame for the Reset command, and Figure 3-4 shows the status frame for the command.

**Figure 3-3. Reset Command Frame (from Programmer to V850ES/Jx3-L)**

SOH	LEN	COM	SUM	ETX
01H	01H	00H (Reset)	Checksum	03H

**Figure 3-4. Status Frame for Reset Command (from V850ES/Jx3-L to Programmer)**

STX	LEN	Data	SUM	ETX
02H	1	ST1	Checksum	03H

**Remark** ST1: Synchronization detection result

See *CHAPTER 4* to *CHAPTER 6* for details about flowcharts of processing sequences between the programmer and the V850ES/Jx3-L, flowcharts of command processing, and sample programs for each communication mode.

- For the UART communication mode, see *4.4 Reset Command*.
- For the 3-wire serial I/O communication mode with handshake supported (CSI + HS), see *5.5 Reset Command*.
- For the 3-wire serial I/O communication mode (CSI), see *6.5 Reset Command*.

### 3.3 Baud Rate Set Command

#### 3.3.1 Description

This command is used to change the baud rate for UART (default value: 9,600 bps).

After the Baud Rate Set command is executed, the Reset command must be executed to confirm synchronization at the new baud rate.

The Baud Rate Set command is valid only in the UART communication mode. Data for setting the baud rate is represented as a 1-byte numeric value.

The V850ES/Jx3-L ignores the Baud Rate Set command if it is transmitted in modes other than the UART communication mode.

#### 3.3.2 Command frame and status frame

Figure 3-5 shows the format of a command frame for the Baud Rate Set command, and Figure 3-6 shows the status frame for the command.

**Figure 3-5. Baud Rate Set Command Frame (from Programmer to V850ES/Jx3-L)**

SOH	LEN	COM	Command Information	SUM	ETX
01H	02H	9AH (Baud Rate Set)	D01	Checksum	03H

**Remark** D01: Baud rate selection value

D01 Value	03H	04H	05H	06H	07H	08H	09H	0AH	0BH
Baud rate (bps)	9,600	19,200	31,250	38,400	76,800	153,600	57,600	115,200	128,000

**Figure 3-6. Status Frame for Baud Rate Set Command (from V850ES/Jx3-L to Programmer)**

STX	LEN	Data	SUM	ETX
02H	01H	ST1	Checksum	03H

**Remark** ST1: Synchronization detection result

See *CHAPTER 4* to *CHAPTER 6* for details about flowcharts of processing sequences between the programmer and the V850ES/Jx3-L, flowcharts of command processing, and sample programs for each communication mode.

- For the UART communication mode, see 4.5 *Baud Rate Set Command*.
- The Baud Rate Set command is not used in the 3-wire serial I/O communication mode with handshake supported (CSI + HS).
- The Baud Rate Set command is not used in 3-wire serial I/O communication mode (CSI).



### 3.4 Oscillating Frequency Set Command

#### 3.4.1 Description

This command is used to set oscillation frequency data in the V850ES/Jx3-L.

Specify the frequency of the clock that is actually input to the X1 pin of the V850ES/Jx3-L.

The V850ES/Jx3-L automatically sets the multiply rate of the CPU operation clock, based on the clock frequency specified with this command. Therefore, note that the reference clock for wait calculation varies before and after execution of this command.

#### 3.4.2 Command frame and status frame

Figure 3-7 shows the format of a command frame for the Oscillating Frequency Set command, and Figure 3-8 shows the status frame for the command.

**Figure 3-7. Oscillating Frequency Set Command Frame (from Programmer to V850ES/Jx3-L)**

SOH	LEN	COM	Command Information				SUM	ETX
01H	05H	90H (Oscillating Frequency Set)	D01	D02	D03	D04	Checksum	03H

**Remark** D01 to D04: Oscillation frequency =  $(D01 \times 0.1 + D02 \times 0.01 + D03 \times 0.001) \times 10^{D04}$  (Unit: kHz)

Settings can be made from 10 kHz to 100 MHz, but set the value according to the specifications of each device when actually transmitting the command.

D01 to D03 hold unpacked BCDs, and D04 holds a signed integer.

Setting example: To set 6 MHz

D01 = 06H

D02 = 00H

D03 = 00H

D04 = 04H

Oscillation frequency =  $6 \times 0.1 \times 10^4 = 6,000 \text{ kHz} = 6 \text{ MHz}$

Setting example: To set 10 MHz

D01 = 01H

D02 = 00H

D03 = 00H

D04 = 05H

Oscillation frequency =  $1 \times 0.1 \times 10^5 = 10,000 \text{ kHz} = 10 \text{ MHz}$

**Figure 3-8. Status Frame for Oscillating Frequency Set Command (from V850ES/Jx3-L to Programmer)**

STX	LEN	Data	SUM	ETX
02H	01H	ST1	Checksum	03H

**Remark** ST1: Oscillation frequency setting result

---

See *CHAPTER 4* to *CHAPTER 6* for details about flowcharts of processing sequences between the programmer and the V850ES/Jx3-L, flowcharts of command processing, and sample programs for each communication mode.

- For the UART communication mode, see *4.6 Oscillating Frequency Set Command*.
- For the 3-wire serial I/O communication mode with handshake supported (CSI + HS), see *5.6 Oscillating Frequency Set Command*.
- For the 3-wire serial I/O communication mode (CSI), see *6.6 Oscillating Frequency Set Command*.

### 3.5 Chip Erase Command

#### 3.5.1 Description

This command is used to erase the entire contents of the flash memory. In addition, all of the information that is set by security setting processing can be initialized by Chip Erase processing, as long as execution of the Chip Erase command is not prohibited by the security setting (see 3.13 *Security Set Command*).

#### 3.5.2 Command frame and status frame

Figure 3-9 shows the format of a command frame for the Chip Erase command, and Figure 3-10 shows the status frame for the command.

**Figure 3-9. Chip Erase Command Frame (from Programmer to V850ES/Jx3-L)**

SOH	LEN	COM	SUM	ETX
01H	01H	20H (Chip Erase)	Checksum	03H

**Figure 3-10. Status Frame for Chip Erase Command (from V850ES/Jx3-L to Programmer)**

STX	LEN	Data	SUM	ETX
02H	01H	ST1	Checksum	03H

**Remark** ST1: Chip erase result

See *CHAPTER 4* to *CHAPTER 6* for details about flowcharts of processing sequences between the programmer and the V850ES/Jx3-L, flowcharts of command processing, and sample programs for each communication mode.

- For the UART communication mode, see 4.7 *Chip Erase Command*.
- For the 3-wire serial I/O communication mode with handshake supported (CSI + HS), see 5.7 *Chip Erase Command*.
- For the 3-wire serial I/O communication mode (CSI), see 6.7 *Chip Erase Command*.

## 3.6 Block Erase Command

### 3.6.1 Description

This command is used to erase the contents of blocks with the specified number in the flash memory, as long as erasure is not prohibited by the security setting (see 3.13 *Security Set Command*).

### 3.6.2 Command frame and status frame

Figure 3-11 shows the format of a command frame for the Block Erase command, and Figure 3-12 shows the status frame for the command.

**Figure 3-11. Block Erase Command Frame (from Programmer to V850ES/Jx3-L)**

SOH	LEN	COM	Command Information						SUM	ETX
01H	02H	22H (Block Erase)	SAH	SAM	SAL	EAH	EAM	EAL	Checksum	03H

**Remark** SAH to SAL: Block erase start address (start address of arbitrary block)

SAH: Start address, high (bits 23 to 16)

SAM: Start address, middle (bits 15 to 8)

SAL: Start address, low (bits 7 to 0)

EAH to EAL: Block erase end addresses (start address of arbitrary block)

EAH: End address, high (bits 23 to 16)

EAM: End address, middle (bits 15 to 8)

EAL: End address, low (bits 7 to 0)

**Figure 3-12. Status Frame for Block Erase Command (from V850ES/Jx3-L to Programmer)**

STX	LEN	Data	SUM	ETX
02H	01H	ST1	Checksum	03H

**Remark** ST1: Block erase result

See *CHAPTER 4* to *CHAPTER 6* for details about flowcharts of processing sequences between the programmer and the V850ES/Jx3-L, flowcharts of command processing, and sample programs for each communication mode.

- For the UART communication mode, see 4.8 *Block Erase Command*.
- For the 3-wire serial I/O communication mode with handshake supported (CSI + HS), see 5.8 *Block Erase Command*.
- For the 3-wire serial I/O communication mode (CSI), see 6.8 *Block Erase Command*.

### 3.7 Programming Command

#### 3.7.1 Description

This command is used to transmit data by the number of written bytes after the write start address and the write end address are transmitted. This command then writes the user program to the flash memory and verifies it internally.

The write start/end address can be set only in the block start/end address units.

If both of the status frames (ST1 and ST2) after the last data transmission indicate ACK, the V850ES/Jx3-L firmware automatically executes internal verify. Therefore, the Status command for this internal verify must be transmitted.

#### 3.7.2 Command frame and status frame

Figure 3-13 shows the format of a command frame for the Programming command, and Figure 3-14 shows the status frame for the command.

**Figure 3-13. Programming Command Frame (from Programmer to V850ES/Jx3-L)**

SOH	LEN	COM	Command Information						SUM	ETX
01H	07H	40H (Programming)	SAH	SAM	SAL	EAH	EAM	EAL	Checksum	03H

**Remark** SAH, SAM, SAL: Write start addresses  
EAH, EAM, EAL: Write end addresses

**Figure 3-14. Status Frame for Programming Command (from V850ES/Jx3-L to Programmer)**

STX	LEN	Data	SUM	ETX
02H	01H	ST1 (a)	Checksum	03H

**Remark** ST1 (a): Command reception result

#### 3.7.3 Data frame and status frame

Figure 3-15 shows the format of a frame that includes data to be written, and Figure 3-16 shows the status frame for the data.

**Figure 3-15. Data Frame to Be Written (from Programmer to V850ES/Jx3-L)**

STX	LEN	Data	SUM	ETX/ETB
02H	00H to FFH (00H = 256)	Write Data	Checksum	03H/17H

**Remark** Write Data: User program to be written

**Figure 3-16. Status Frame for Data Frame (from V850ES/Jx3-L to Programmer)**

STX	LEN	Data		SUM	ETX
02H	02H	ST1 (b)	ST2 (b)	Checksum	03H

**Remark** ST1 (b): Data reception check result  
ST2 (b): Write result

### 3.7.4 Completion of transferring all data and status frame

Figure 3-17 shows the status frame after transfer of all data is completed.

**Figure 3-17. Status Frame After Completion of Transferring All Data (from V850ES/Jx3-L to Programmer)**

STX	LEN	Data	SUM	ETX
02H	01H	ST1 (c)	Checksum	03H

**Remark** ST1 (c): Internal verify result

See *CHAPTER 4* to *CHAPTER 6* for details about flowcharts of processing sequences between the programmer and the V850ES/Jx3-L, flowcharts of command processing, and sample programs for each communication mode.

- For the UART communication mode, see *4.9 Programming Command*.
- For the 3-wire serial I/O communication mode with handshake supported (CSI + HS), see *5.9 Programming Command*.
- For the 3-wire serial I/O communication mode (CSI), see *6.9 Programming Command*.

### 3.8 Verify Command

#### 3.8.1 Description

This command is used to compare the data transmitted from the programmer with the data read from the V850ES/Jx3-L (read level) in the specified address range, and check whether they match.

The verify start/end address can be set only in the block start/end address units.

#### 3.8.2 Command frame and status frame

Figure 3-18 shows the format of a command frame for the Verify command, and Figure 3-19 shows the status frame for the command.

**Figure 3-18. Verify Command Frame (from Programmer to V850ES/Jx3-L)**

SOH	LEN	COM	Command Information						SUM	ETX
01H	07H	13H (Verify)	SAH	SAM	SAL	EAH	EAM	EAL	Checksum	03H

**Remark** SAH, SAM, SAL: Verify start addresses  
EAH, EAM, EAL: Verify end addresses

**Figure 3-19. Status Frame for Verify Command (from V850ES/Jx3-L to Programmer)**

STX	LEN	Data	SUM	ETX
02H	01H	ST1 (a)	Checksum	03H

**Remark** ST1 (a): Command reception result

#### 3.8.3 Data frame and status frame

Figure 3-20 shows the format of a frame that includes data to be verified, and Figure 3-21 shows the status frame for the data.

**Figure 3-20. Data Frame of Data to Be Verified (from Programmer to V850ES/Jx3-L)**

STX	LEN	Data	SUM	ETX/ETB
02H	00H to FFH (00H = 256)	Verify data	Checksum	03H/17H

**Remark** Verify Data: User program to be verified

**Figure 3-21. Status Frame for Data Frame (from V850ES/Jx3-L to Programmer)**

STX	LEN	Data		SUM	ETX
02H	02H	ST1 (b)	ST2 (b)	Checksum	03H

**Remark** ST1 (b): Data reception check result  
ST2 (b): Verify result<sup>Note</sup>

**Note** Even if a verify error occurs in the specified address range, ACK is always returned as the verify result. The status of all verify errors are reflected in the verify result for the last data. Therefore, the occurrence of verify errors can be checked only when all the verify processing for the specified address range is completed.

See *CHAPTER 4* to *CHAPTER 6* for details about flowcharts of processing sequences between the programmer and the V850ES/Jx3-L, flowcharts of command processing, and sample programs for each communication mode.

- For the UART communication mode, see *4.10 Verify Command*.
- For the 3-wire serial I/O communication mode with handshake supported (CSI + HS), see *5.10 Verify Command*.
- For the 3-wire serial I/O communication mode (CSI), see *6.10 Verify Command*.



### 3.9 Block Blank Check Command

#### 3.9.1 Description

This command is used to check if data in the flash memory of the specified block is blank (erased state).

#### 3.9.2 Command frame and status frame

Figure 3-22 shows the format of a command frame for the Block Blank Check command, and Figure 3-23 shows the status frame for the command.

**Figure 3-22. Block Blank Check Command Frame (from Programmer to V850ES/Jx3-L)**

SOH	LEN	COM	Command Information						SUM	ETX
01H	07H	32H (Block Blank Check)	SAH	SAM	SAL	EAH	EAM	EAL	Checksum	03H

**Remark** SAH to SAL: Block blank check start address (start address of arbitrary block)  
 SAH: Start address, high (bits 23 to 16)  
 SAM: Start address, middle (bits 15 to 8)  
 SAL: Start address, low (bits 7 to 0)  
 EAH to EAL: Block blank check end address (end address of arbitrary block)  
 EAH: End address, high (bits 23 to 16)  
 EAM: End address, middle (bits 15 to 8)  
 EAL: End address, low (bits 7 to 0)

**Figure 3-23. Status Frame for Block Blank Check Command (from V850ES/Jx3-L to Programmer)**

STX	LEN	Data	SUM	ETX
02H	01H	ST1	Checksum	03H

**Remark** ST1: Block blank check result

See *CHAPTER 4* to *CHAPTER 6* for details about flowcharts of processing sequences between the programmer and the V850ES/Jx3-L, flowcharts of command processing, and sample programs for each communication mode.

- For the UART communication mode, see 4.11 *Block Blank Check Command*.
- For the 3-wire serial I/O communication mode with handshake supported (CSI + HS), see 5.11 *Block Blank Check Command*.
- For the 3-wire serial I/O communication mode (CSI), see 6.11 *Block Blank Check Command*.

### 3.10 Silicon Signature Command

#### 3.10.1 Description

This command is used to read the write protocol information (silicon signature) of the device.

If the programmer supports a programming protocol that is not supported in the V850ES/Jx3-L, for example, execute this command to select an appropriate protocol in accordance with the values of the second and third bytes.

#### 3.10.2 Command frame and status frame

Figure 3-24 shows the format of a command frame for the Silicon Signature command, and Figure 3-25 shows the status frame for the command.

**Figure 3-24. Silicon Signature Command Frame (from Programmer to V850ES/Jx3-L)**

SOH	LEN	COM	SUM	ETX
01H	01H	COH (Silicon Signature)	Checksum	03H

**Figure 3-25. Status Frame for Silicon Signature Command (from V850ES/Jx3-L to Programmer)**

STX	LEN	Data	SUM	ETX
02H	01H	ST1	Checksum	03H

**Remark** ST1: Command reception result

#### 3.10.3 Silicon signature data frame

Figure 3-26 shows the format of a frame that includes silicon signature data.

**Figure 3-26. Silicon Signature Data Frame (from V850ES/Jx3-L to Programmer)**

STX	LEN	Data														SUM	ETX
02H	20H	VEN	MET	MSC	DEC1	DEC2	UMF	DFS	DFE	DEV	SCF	BOT	RVAL	RVAM	RVAH	Checksum	03H

<b>Remarks 1.</b>	VEN:	Vendor code
	MET:	Macro extension code
	MSC:	Macro function code
	DEC1:	Device extension code 1
	DEC2:	Device extension code 2
<R>	UMF:	Code flash memory end address for the V850ES/JF3-L and V850ES/JG3-L 4-byte length invalid data for the V850ES/JC3-L and V850ES/JE3-L
	DFS:	Data flash start address
	DFE:	Data flash end address
<R>	DEV:	Device name ( $\mu$ PD No.) for the V850ES/JF3-L and V850ES/JG3-L 10-byte length invalid data for the V850ES/JC3-L and V850ES/JE3-L
	SCF:	Security flag information
	BOT:	Boot block number
	RVAL:	Reset vector address L (bits 7 to 0) (fixed to 00H)
	RVAM:	Reset vector address M (bits 15 to 8) (fixed to 00H)
	RVAH:	Reset vector address H (bits 23 to 16) (fixed to 00H)

2. Of the fields other than BOT (boot block number) and RVAL, RVAM and RVAH (reset vector addresses), the lower 7 bits are used as a data entity, and the highest 1 bit is used as the odd parity.

**Table 3-1. Example of Silicon Signature Data**

Field	Contents	Length (Byte)	Example of Silicon Signature Data <sup>Note 1</sup>	Actual Value	Parity
VEN	Vendor code	1	10H (00010000B)	10H	Added
MET	Macro extension code (fixed value)	1	7FH (01111111B)	7FH	Added
MSC	Macro function (fixed value)	1	04H (00000100B)	04H	Added
DEC1	Device extension code 1 (fixed value)	1	ECH (11101100B)	07H	Added
DEC2	Device extension code 2 (fixed value)	1	7FH (01111111B)	7FH	Added
UFM	Code flash memory end address	4	7F7F0780H	7F7F0780H	Added
DFS	Data flash memory start address	4	Fixed to 80808080H <sup>Note 2</sup>	80808080H	Added
DFE	Data flash memory end address	4	Fixed to 80808080H <sup>Note 2</sup>	80808080H	Added
DEV	Device name	10	C4H (11000100B = 'D')	'D'	Added
			37H (00110111B = '7')	'7'	
			B0H (10110000B = '0')	'0'	
			46H (01000110B = 'F')	'F'	
			B3H (10110011B = '3')	'3'	
			37H (10110111B = '7')	'7'	
			B3H (00110011B = '3')	'3'	
			B5H (00110101B = '5')	'5'	
			20H (00100000B = ' ')	' '	
20H (00100000B = ' ')	' '				
SCF	Security flag information	1	Any	Any	Added
BOT	The last block number of the boot block cluster	1	Any	Any	Not added
RVAL	Reset vector address L (bits 7 to 0)	1	Fixed to 00H.	00H	Not added
RVAM	Reset vector address M (bits 15 to 8)	1	Fixed to 00H.	00H	Not added
RVAH	Reset vector address H (bits 23 to 16)	1	Fixed to 00H.	00H	Not added

**Notes 1.** 0 and 1 are odd parities (the value to adjust the number of 1s in a byte to an odd number).

2. Fixed to 80808080H because of no data flash support

See the following chapters for details about flowcharts of processing sequences between the programmer and the V850ES/Jx3-L, flowcharts of command processing, and sample programs for each communication mode.

- For the UART communication mode, see 4.12 *Silicon Signature Command*.
- For the 3-wire serial I/O communication mode with handshake support (CSI + HS), see 5.12 *Silicon Signature Command*.
- For the 3-wire serial I/O communication mode (CSI), see 6.12 *Silicon Signature Command*.

## 3.10.4 V850ES/Jx3-L silicon signature data list

Table 3-2. V850ES/Jx3-L Silicon Signature Data List

Item	Description	Length (Bytes)	Data (Hex)
Vendor code	–	1	10
Macro extension code	Macro extension code	1	Fixed to 7F
Macro function	Macro function information	1	Fixed to 04
Device extension code 1	Device extension code	1	Fixed to EC
Device extension code 2		1	Fixed to 7F
Code flash memory end address	(7-bit data + odd parity bit) × 3	4	<b>Note 1</b>
Data flash memory start address		4	Fixed to 80808080 <sup>Note 2</sup>
Data flash memory end address		4	Fixed to 80808080 <sup>Note 2</sup>
<R> Device name (μPD)	D70F3735, D70F3736 (V850ES/JF3-L) D70F3737, D70F3738, D70F3792, D70F3793, D70F3794, D70F3795, D70F3796, D70F3841, D70F3842, D70F3843, D70F3844 (V850ES/JG3-L)	10	<b>Note 3</b>
Security information	Security information	1	Any
The last block number of the boot block cluster	The last block number of the boot cluster that is currently selected	1	Any
Reset vector address L (bits 7 to 0)	Reset vector address L (bits 7 to 0)	1	Fixed to 00
Reset vector address M (bits 15 to 8)	Reset vector address M (bits 15 to 8)	1	Fixed to 00
Reset vector address H (bits 23 to 16)	Reset vector address H (bits 23 to 16)	1	Fixed to 00

<R> **Notes 1.** Invalid data for the V850ES/JC3-L and V850ES/JE3-L.

A list of code flash memory end addresses for the V850ES/JF3-L and V850ES/JG3-L is shown below.

Item	Description	Length (Bytes)	Data (Hex)
Code flash memory end address	128 KB	4	7F7F0780
	256 KB		7F7F8F80
	384 KB		7F7F9780
	512 KB		7F7F1F80
	768 KB		7F7F2F80
	1024 KB		7F7FBF80

2. Fixed to 80808080H because the data flash memory is not supported.

<R> **3.** Invalid data for the V850ES/JC3-L and V850ES/JE3-L.

A list of device names for the V850ES/JF3-L and V850ES/JG3-L is shown on the following page.

## Device name list

Nickname	Device Name	Length (bytes)	Actual Value									
			Upper row: Signature data					Lower row: Character code				
V850ES/JF3-L	D70F3735	10	C4	37	B0	46	B3	37	B3	B5	20	20
	D		7	0	F	3	7	3	5	-	-	
	D70F3736		C4	37	B0	46	B3	37	B3	B6	20	20
	D		7	0	F	3	7	3	6	-	-	
V850ES/JG3-L	D70F3737		C4	37	B0	46	B3	37	B3	37	20	20
	D		7	0	F	3	7	3	7	-	-	
<R>	D70F3738		C4	37	B0	46	B3	37	B3	38	20	20
	D		7	0	F	3	7	3	8	-	-	
<R>	D70F3792		C4	37	B0	46	B3	37	B9	32	20	20
	D		7	0	F	3	7	9	2	-	-	
<R>	D70F3793		C4	37	B0	46	B3	37	B9	B3	20	20
	D		7	0	F	3	7	9	3	-	-	
<R>	D70F3794		C4	37	B0	46	B3	37	B9	34	20	20
	D		7	0	F	3	7	9	4	-	-	
<R>	D70F3795		C4	37	B0	46	B3	37	B9	B5	20	20
	D		7	0	F	3	7	9	5	-	-	
<R>	D70F3796		C4	37	B0	46	B3	37	B9	B6	20	20
	D		7	0	F	3	7	9	6	-	-	
<R>	D70F3841		C4	37	B0	46	B3	38	34	31	20	20
	D		7	0	F	3	8	4	1	-	-	
<R>	D70F3842		C4	37	B0	46	B3	38	34	32	20	20
	D		7	0	F	3	8	4	2	-	-	
<R>	D70F3843		C4	37	B0	46	B3	38	34	B3	20	20
	D		7	0	F	3	8	4	3	-	-	
<R>	D70F3844		C4	37	B0	46	B3	38	34	34	20	20
	D		7	0	F	3	8	4	4	-	-	

### 3.11 Version Get Command

#### 3.11.1 Description

This command is used to acquire information on the V850ES/Jx3-L device version and firmware version.

Use this command when the programming parameters must be changed in accordance with the V850ES/Jx3-L firmware version.

**Caution** The firmware version might be updated during firmware update that does not affect the change of flash programming parameters (at this time, update of the firmware version is not reported).

**Example** Firmware version and reprogramming parameters

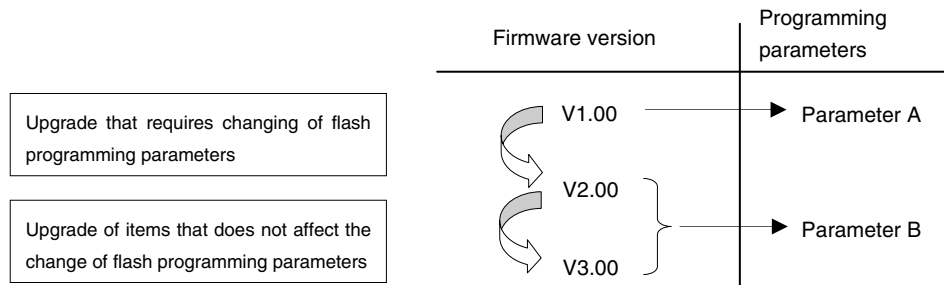

#### 3.11.2 Command frame and status frame

Figure 3-28 shows the format of a command frame for the Version Get command, and Figure 3-29 shows the status frame for the command.

**Figure 3-28. Version Get Command Frame (from Programmer to V850ES/Jx3-L)**

SOH	LEN	COM	SUM	ETX
01H	01H	C5H (Version Get)	Checksum	03H

**Figure 3-29. Status Frame for Version Get Command (from V850ES/Jx3-L to Programmer)**

STX	LEN	Data	SUM	ETX
02H	01H	ST1	Checksum	03H

**Remark** ST1: Command reception result

**3.11.3 Version data frame**

Figure 3-30 shows the data frame of version data.

**Figure 3-30. Version Data Frame (from V850ES/Jx3-L to Programmer)**

STX	LEN	Data						SUM	ETX
02H	06H	DV1	DV2	DV3	FV1	FV2	FV3	Checksum	03H

**Remark** DV1: Integer of device version  
 DV2: First decimal place of device version  
 DV3: Second decimal place of device version  
 FV1: Integer of firmware version  
 FV2: First decimal place of firmware version  
 FV3: Second decimal place of firmware version

See *CHAPTER 4* to *CHAPTER 6* for details about flowcharts of processing sequences between the programmer and the V850ES/Jx3-L, flowcharts of command processing, and sample programs for each communication mode.

- For the UART communication mode, see *4.13 Version Get Command*.
- For the 3-wire serial I/O communication mode with handshake supported (CSI + HS), see *5.13 Version Get Command*.
- For the 3-wire serial I/O communication mode (CSI), see *6.13 Version Get Command*.

## 3.12 Checksum Command

### 3.12.1 Description

This command is used to acquire the checksum data in the specified area.

For the checksum calculation start/end address, specify a fixed address in block units starting from the top of the flash memory.

Checksum data is obtained by sequentially subtracting data in the specified address range from the initial value (00H) in 1-byte units.

### 3.12.2 Command frame and status frame

Figure 3-31 shows the format of a command frame for the Checksum command, and Figure 3-32 shows the status frame for the command.

**Figure 3-31. Checksum Command Frame (from Programmer to V850ES/Jx3-L)**

SOH	LEN	COM	Command Information						SUM	ETX
01H	07H	B0H (Checksum)	SAH	SAM	SAL	EAH	EAM	EAL	Checksum	03H

**Remark** SAH, SAM, SAL: Checksum calculation start addresses  
EAH, EAM, EAL: Checksum calculation end addresses

**Figure 3-32. Status Frame for Checksum Command (from V850ES/Jx3-L to Programmer)**

STX	LEN	Data	SUM	ETX
02H	01H	ST1	Checksum	03H

**Remark** ST1: Command reception result

### 3.12.3 Checksum data frame

Figure 3-33 shows the format of a frame that includes checksum data.

**Figure 3-33. Checksum Data Frame (from V850ES/Jx3-L to Programmer)**

STX	LEN	Data		SUM	ETX
02H	02H	CK1	CK2	Checksum	03H

**Remark** CK1: Higher 8 bits of checksum data  
CK2: Lower 8 bits of checksum data

See CHAPTER 4 to CHAPTER 6 for details about flowcharts of processing sequences between the programmer and the V850ES/Jx3-L, flowcharts of command processing, and sample programs for each communication mode.

- For the UART communication mode, see 4.14 *Checksum Command*.
- For the 3-wire serial I/O communication mode with handshake supported (CSI + HS), see 5.14 *Checksum Command*.
- For the 3-wire serial I/O communication mode (CSI), see 6.14 *Checksum Command*.



### 3.13 Security Set Command

#### 3.13.1 Description

This command is used to perform security settings (enable or disable of write, block erase, and chip erase). By performing these settings with this command, rewriting of the flash memory by an unauthorized party can be restricted.

**Caution** Once the security setting is performed, changing of the setting from disable to enable will no longer be possible. To re-set the security flag, all the security flags must be initialized by executing the Chip Erase command (the Block Erase command cannot be used to initialize the security flags). If the Chip Erase command is disabled, however, chip erase itself will be impossible and so the settings cannot be erased from the programmer. Re-confirmation of security setting execution is therefore recommended before disabling chip erase, due to this programmer specification.

<R>

#### 3.13.2 Command frame and status frame

Figure 3-34 shows the format of a command frame for the Security Set command, and Figure 3-35 shows the status frame for the command.

The Security Set command frame includes the block number field and page number field but these fields do not have any particular usage, so set these fields to 00H.

**Figure 3-34. Security Set Command Frame (from Programmer to V850ES/Jx3-L)**

SOH	LEN	COM	Command Information		SUM	ETX
01H	03H	A0H (Security Set)	00H (fixed)	00H (fixed)	Checksum	03H

**Figure 3-35. Status Frame for Security Set Command (from V850ES/Jx3-L to Programmer)**

STX	LEN	Data	SUM	ETX
02H	01H	ST1 (a)	Checksum	03H

**Remark** ST1 (a): Command reception result

### 3.13.3 Data frame and status frame

Figure 3-36 shows the format of a security data frame, and Figure 3-37 shows the status frame for the data.

**Figure 3-36 Security Data Frame (from Programmer to V850ES/Jx3-L)**

STX	LEN	Data					SUM	ETX
02H	05H	FLG	BOT	ADH	ADM	ADL	Checksum	03H

**Remark** FLG: Security flag  
 BOT: Boot block cluster last block number (00H to 7FH)<sup>Note1</sup>  
 ADH: Reset vector handler address (bits 23 to 16)<sup>Note2</sup>  
 ADM: Reset vector handler address (bits 15 to 8)<sup>Note2</sup>  
 ADL: Reset vector handler address (bits 7 to 0)<sup>Note2</sup>

- Notes** 1. Set it within the ROM size of V850ES/Jx3-L.  
 2. Set to 00H.

**Figure 3-37. Status Frame for Security Data Writing (from V850ES/Jx3-L to Programmer)**

STX	LEN	Data	SUM	ETX
02H	01H	ST1 (b)	Checksum	03H

**Remark** ST1 (b): Security data write result

### 3.13.4 Internal verify check and status frame

Figure 3-38 shows the status frame for internal verify check.

**Figure 3-38. Status Frame for Internal Verify Check (from V850ES/Jx3-L to Programmer)**

STX	LEN	Data	SUM	ETX
02H	01H	ST1 (c)	Checksum	03H

**Remark** ST1 (c): Internal verify result

The following table shows the contents in the security flag field.

**Table 3-3. Contents of Security Flag Field**

Item	Contents
Bit 7	Fixed to 1
Bit 6	
Bit 5	
Bit 4	Boot block cluster rewrite disable flag (1: enable, 0: disable)
Bit 3	Read disable flag (1: enable, 0: disable)
Bit 2	Write disable flag (1: enable, 0: disable)
Bit 1	Block erase disable flag (1: enable, 0: disable)
Bit 0	Chip erase disable flag (1: enable, 0: disable)

The following table shows the relationship between the security flag field settings and the enable/disable status of each operation.

**Table 3-4. Security Flag Field and Enable/Disable Status of Each Operation**

Operating Mode	Flash Memory Programming Mode				Self-Programming Mode
Security Setting Item	Command Operation After Security Setting √: Execution possible, ×: Execution impossible △: Writing other than for boot specification or block erase is possible				<ul style="list-style-type: none"> <li>All commands can be executed regardless of the security setting values</li> <li>Only retention of security setting values is possible</li> </ul>
	Programming	Chip Erase	Block Erase	Read	
Disable writing	×	√	×	√	
Disable chip erase	√	×	×	√	
Disable block erase	√	√	×	√	
Disable read	√	√	√	×	
Disable boot block rewriting	△	×	△	√	

See *CHAPTER 4* to *CHAPTER 6* for details about flowcharts of processing sequences between the programmer and the V850ES/Jx3-L, flowcharts of command processing, and sample programs for each communication mode.

- For the UART communication mode, see *4.15 Security Set Command*.
- For the 3-wire serial I/O communication mode with handshake supported (CSI + HS), see *5.15 Security Set Command*.
- For the 3-wire serial I/O communication mode (CSI), see *6.15 Security Set Command*.

### 3.14 Read Command

#### 3.14.1 Description

This command is used to read data from the flash memory of the V850ES/Jx3-L.  
The write start/end address can be set only in the block start/end address units.

#### 3.14.2 Command frame and status frame

Figure 3-39 shows the format of a command frame for the Read command, and Figure 3-40 shows the status frame for the command.

**Figure 3-39. Read Command Frame (from Programmer to V850ES/Jx3-L)**

SOH	LEN	COM	Command Information						SUM	ETX
01H	07H	50H (Read)	SAH	SAM	SAL	EAH	EAM	EAL	Checksum	03H

**Remark** SAH, SAM, SAL: Read start address (start address of the block)  
EAH, EAM, EAL: Read end address (end address of the block)

**Figure 3-40. Status Frame for Read Command (from V850ES/Jx3-L to Programmer)**

STX	LEN	Data	SUM	ETX
02H	01H	ST1 (a)	Checksum	03H

**Remark** ST1 (a): Command reception result

#### 3.14.3 Data frame and status frame

Figure 3-41 shows the format of a frame that includes data to be read, and Figure 3-42 shows the status frame for the data.

**Figure 3-41. Data Frame of Data to Be Read (from V850ES/Jx3-L to Programmer)**

STX	LEN	Data	SUM	ETX/ETB
02H	00H to FFH (00H = 256)	Read Data	Checksum	03H/17H

**Remark** Read Data: Data read from V850ES/Jx3-L

**Figure 3-42. Status Frame for Read Data (from Programmer to V850ES/Jx3-L)**

STX	LEN	Data	SUM	ETX
02H	01H	ST1 (b)	Checksum	03H/17H

**Remark** ST1 (b): ACK (06H) or NACK (15H) sent from the programmer for read data

---

See the following chapters for details about flowcharts of processing sequences between the programmer and the V850ES/Jx3-L, flowcharts of command processing, and sample programs for each communication mode.

- For the UART communication mode, see 4.16 *Read Command*.
- For the 3-wire serial I/O communication mode with handshake supported (CSI + HS), see 5.16 *Read Command*.
- For the 3-wire serial I/O communication mode (CSI), see 6.16 *Read Command*.

## CHAPTER 4 UART COMMUNICATION MODE

## 4.1 Command Frame Transmission Processing Flowchart

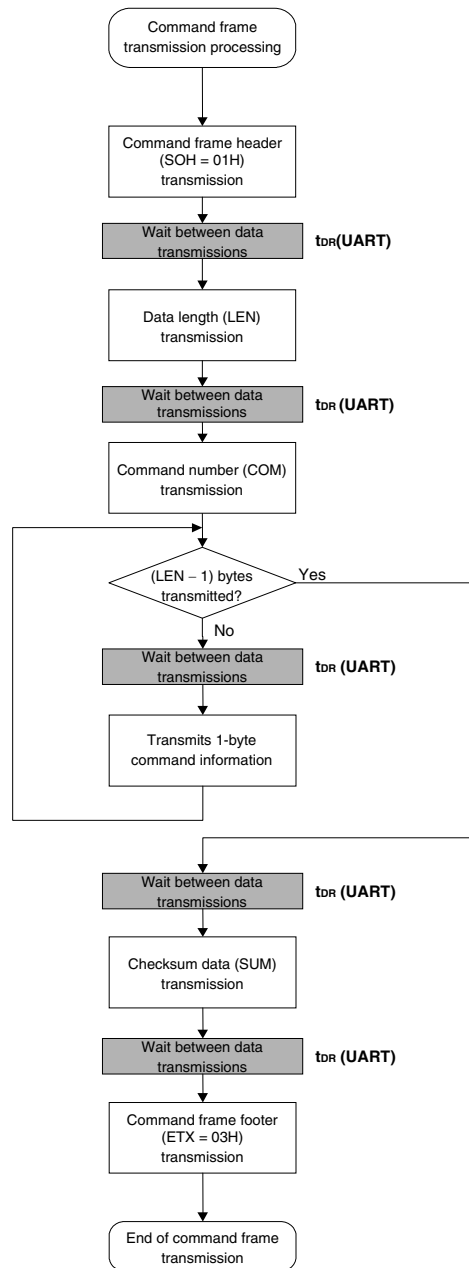

4.2 Data Frame Transmission Processing Flowchart

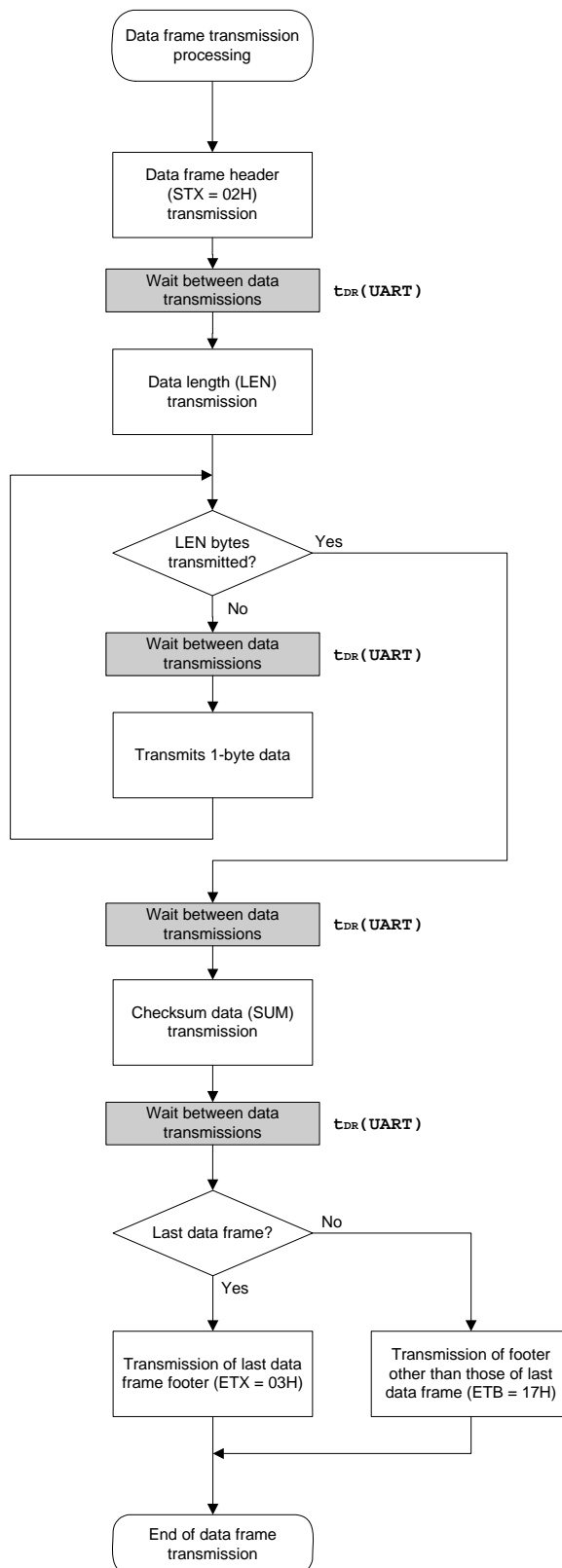

4.3 Data Frame Reception Processing Flowchart

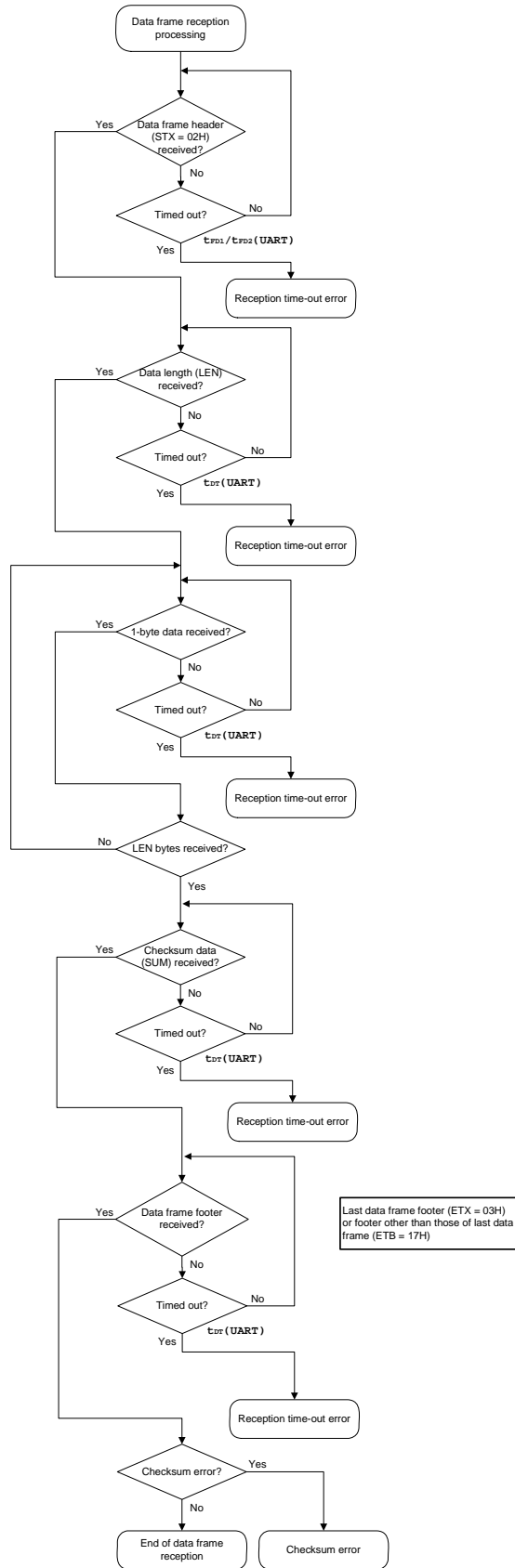



4.4 Reset Command

4.4.1 Processing sequence chart

Reset command processing sequence

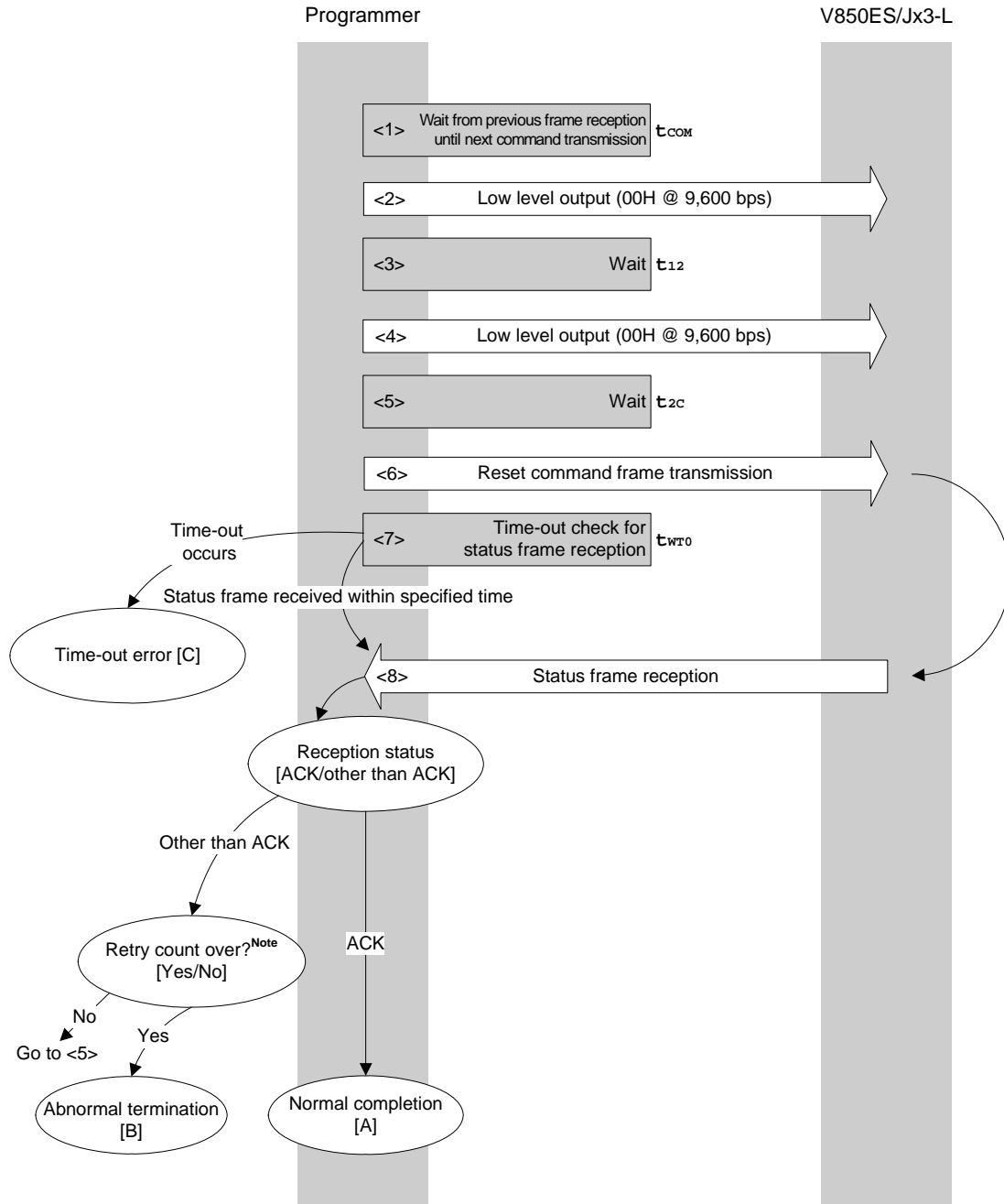

**Note** Do not exceed the retry count for the reset command transmission (up to 16 times).

#### 4.4.2 Description of processing sequence

- <1> Waits from the previous frame reception until the next command processing starts (wait time  $t_{COM}$ ).
- <2> The low level is output (data 00H is transmitted at 9,600 bps).
- <3> Wait state (wait time  $t_{12}$ ).
- <4> The low level is output (data 00H is transmitted at 9,600 bps).
- <5> Wait state (wait time  $t_{2c}$ ).
- <6> The Reset command is transmitted by command frame transmission processing.
- <7> A time-out check is performed from command transmission until status frame reception.  
If a time-out occurs, a time-out error [C] is returned (time-out time  $t_{WTO}$ ).
- <8> The status code is checked.

When ST1 = ACK: Normal completion [A]

When ST1  $\neq$  ACK: The retry count ( $t_{RS}$ ) is checked.

The sequence is re-executed from <5> if the retry count is not over.

If the retry count is over, the processing ends abnormally [B].

#### 4.4.3 Status at processing completion

Status at Processing Completion		Status Code	Description
Normal completion [A]	Normal acknowledgment (ACK)	06H	The command was executed normally and synchronization between the programmer and the V850ES/Jx3-L has been established.
Abnormal termination [B]	Checksum error	07H	The checksum of the transmitted command frame does not match.
	Negative acknowledgment (NACK)	15H	<ul style="list-style-type: none"> <li>• A command other than the Status command was received during processing.</li> <li>• Command frame data is abnormal (such as invalid data length (LEN) or no ETX).</li> </ul>
Time-out error [C]		–	The status frame was not received within the specified time.

4.4.4 Flowchart

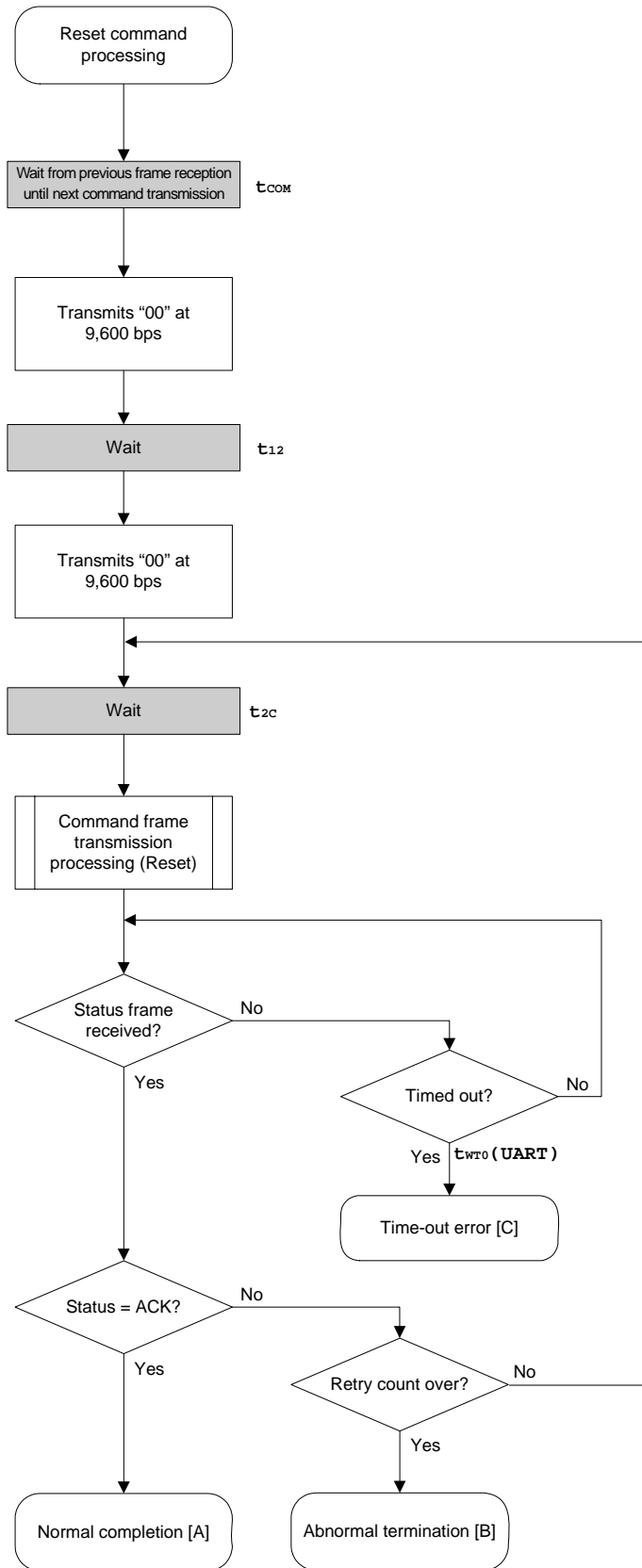

#### 4.4.5 Sample program

The following shows a sample program for Reset command processing.

```

/*****
/*
/* Reset command
/*
/*****
/* [r] u16      ... error code
/*****
u16  fl_ua_reset(void)
{
    u16    rc;
    u32    retry;

    set_uart0_br(BR_9600); // change to 9600bps

    fl_wait(tCOM);        // wait
    putc_ua(0x00);        // send 0x00 @ 9600bps

    fl_wait(t12);         // wait
    putc_ua(0x00);        // send 0x00 @ 9600bps

    for (retry = 0; retry < tRS; retry++){

        fl_wait(t2C);     // wait

        put_cmd_ua(FL_COM_RESET, 1, fl_cmd_prm);        // send RESET command

        rc = get_sfrm_ua(fl_ua_sfrm, tWT0_MAX);
        if (rc == FLC_DFTO_ERR) // t.o. ?
            break;                // yes // case [C]

        if (rc == FLC_ACK){
            break;                // ACK ?
            // yes // case [A]
        }
        else{
            NOP();
        }
        //continue;                // case [B] (if exit from loop)
    }
    // switch(rc) {
    //
    //     case    FLC_NO_ERR:    return rc;    break; // case [A]
    //     case    FLC_DFTO_ERR:  return rc;    break; // case [C]
    //     default:                return rc;    break; // case [B]
    // }
    return rc;
}

```

## 4.5 Baud Rate Set Command

### 4.5.1 Processing sequence chart

Baud Rate Set command processing sequence

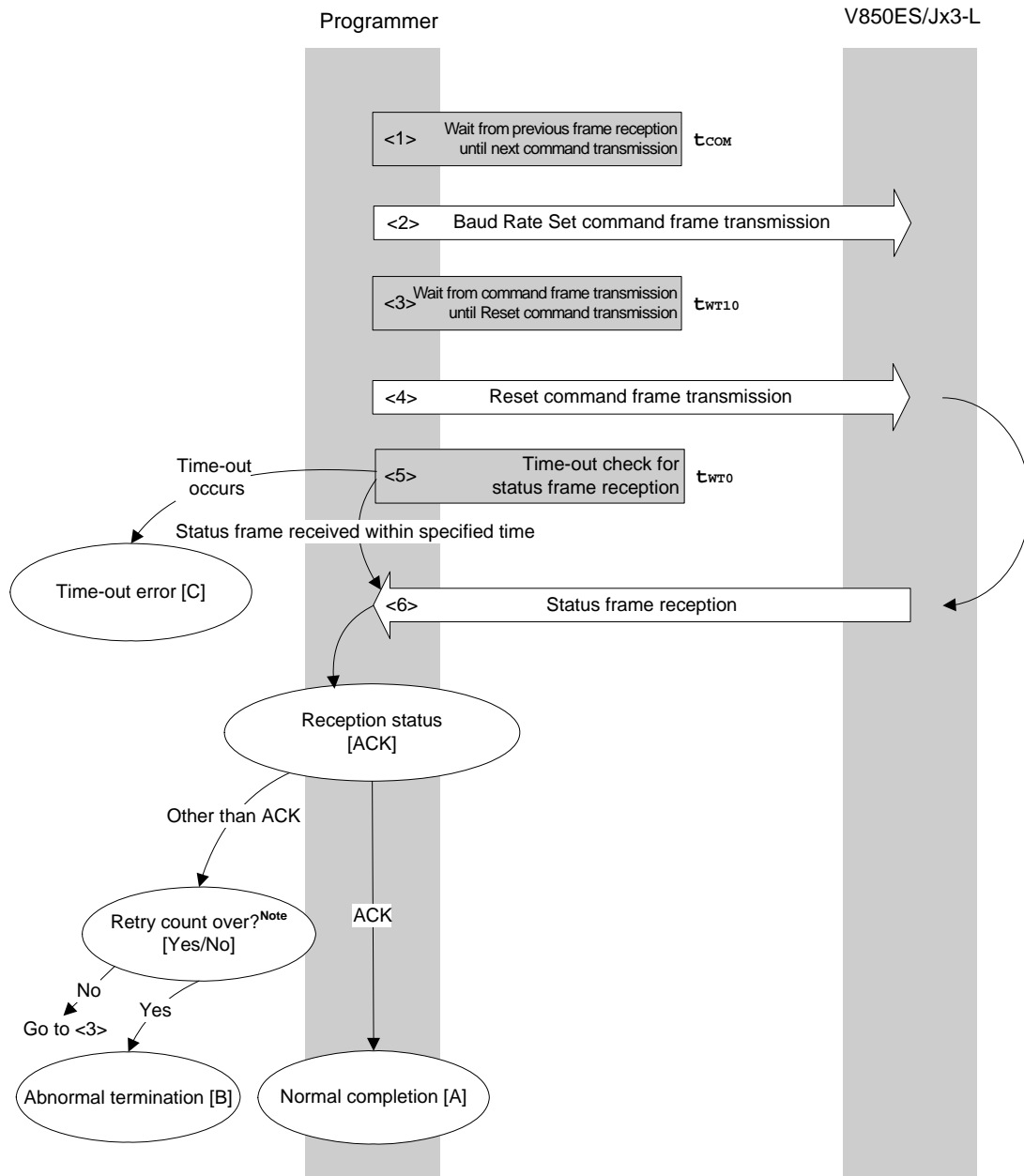

**Note** Do not exceed the retry count for the reset command transmission (up to 16 times).

#### 4.5.2 Description of processing sequence

- <1> Waits from the previous frame reception until the next command transmission (wait time  $t_{COM}$ ).
- <2> The Baud Rate Set command is transmitted by command frame transmission processing.
- <3> Waits from command transmission until Reset command transmission (wait time  $t_{WT10}$ ).
- <4> The Reset command is transmitted by command frame transmission processing.
- <5> A time-out check is performed from command transmission until status frame reception.  
If a time-out occurs, a time-out error [C] is returned (time-out time  $t_{WT0}$ ).
- <6> Because the status code should be ACK, the processing ends normally [A].

#### 4.5.3 Status at processing completion

Status at Processing Completion		Status Code	Description
Normal completion [A]	Normal acknowledgment (ACK)	06H	The command was executed normally and the synchronization of the UART communication speed has been established between the programmer and the V850ES/Jx3-L.
Abnormal termination [B]	Checksum error	07H	The checksum of the transmitted command frame does not match.
	Negative acknowledgment (NACK)	15H	Command frame data is abnormal (such as invalid data length (LEN) or no ETX).
Time-out error [C]		–	Data frame reception was timed out. With the V850ES/Jx3-L, this command also results in errors in the following cases. <ul style="list-style-type: none"> <li>• Command information (parameter) is invalid</li> <li>• The command frame includes the checksum error</li> <li>• The data length of the command frame (LEN) is invalid</li> <li>• The footer of the command frame (ETX) is missing</li> <li>• The Reset command was not detected after setting the baud rate and receiving command frame data for 16 times.</li> </ul>

## 4.5.4 Flowchart

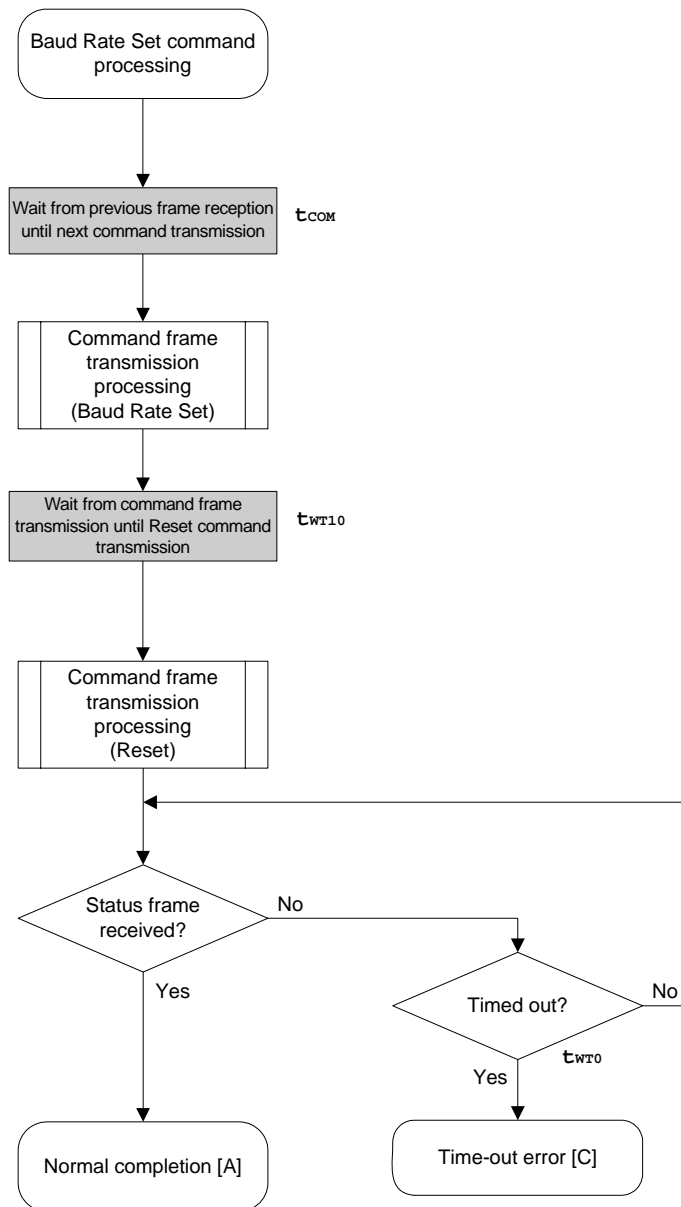

#### 4.5.5 Sample program

The following shows a sample program for Baud Rate Set command processing.

```

/*****
/*
/* Set baudrate command
/*
/*****
/* [i] u8 brid      ... baudrate ID
/* [r] u16          ... error code
/*****
u16      fl_ua_setbaud(u8 brid)
{
    u16    rc;
    u8     br;
    u32    retry;

    switch(brid){
        default:
            case BR_9600:      br = 0x03;    break;
            case BR_19200:    br = 0x04;    break;
            case BR_31250:    br = 0x05;    break;
            case BR_38400:    br = 0x06;    break;
            case BR_76800:    br = 0x07;    break;
            case BR_153600:   br = 0x08;    break;

            case BR_57600:    br = 0x09;    break;
            case BR_115200:   br = 0x0a;    break;
            case BR_128000:   br = 0x0b;    break;

    }

    fl_cmd_prm[0] = br;          // "D01"

    fl_wait(tCOM);              // wait before sending command
    put_cmd_ua(FL_COM_SET_BAUDRATE, 2, fl_cmd_prm);
                                // send "Baudrate Set" command

    set_flbaud(brid);           // change baud-rate
    set_uart0_br(brid);         // change baud-rate (h.w.)

    retry = tRS;
    while(1){
        fl_wait(tWT10);

        put_cmd_ua(FL_COM_RESET, 1, fl_cmd_prm);    // send RESET command

        rc = get_sfrm_ua(fl_ua_sfrm, tWT0_MAX);     // get status frame
        if (rc){
            if (retry--){
                continue;
            }
            else{
                return rc;
            }
        }
        break;          // got ACK !!
    }
}

```



```
    }  
    // switch(rc) {  
    //     case   FLC_NO_ERR:    return rc;    break; // case [A]  
    //     case   FLC_DFTO_ERR:  return rc;    break; // case [C]  
    //     default:              return rc;    break; // case [B]  
    // }  
  
    return rc;  
}
```

## 4.6 Oscillating Frequency Set Command

### 4.6.1 Processing sequence chart

Oscillating Frequency Set command processing sequence

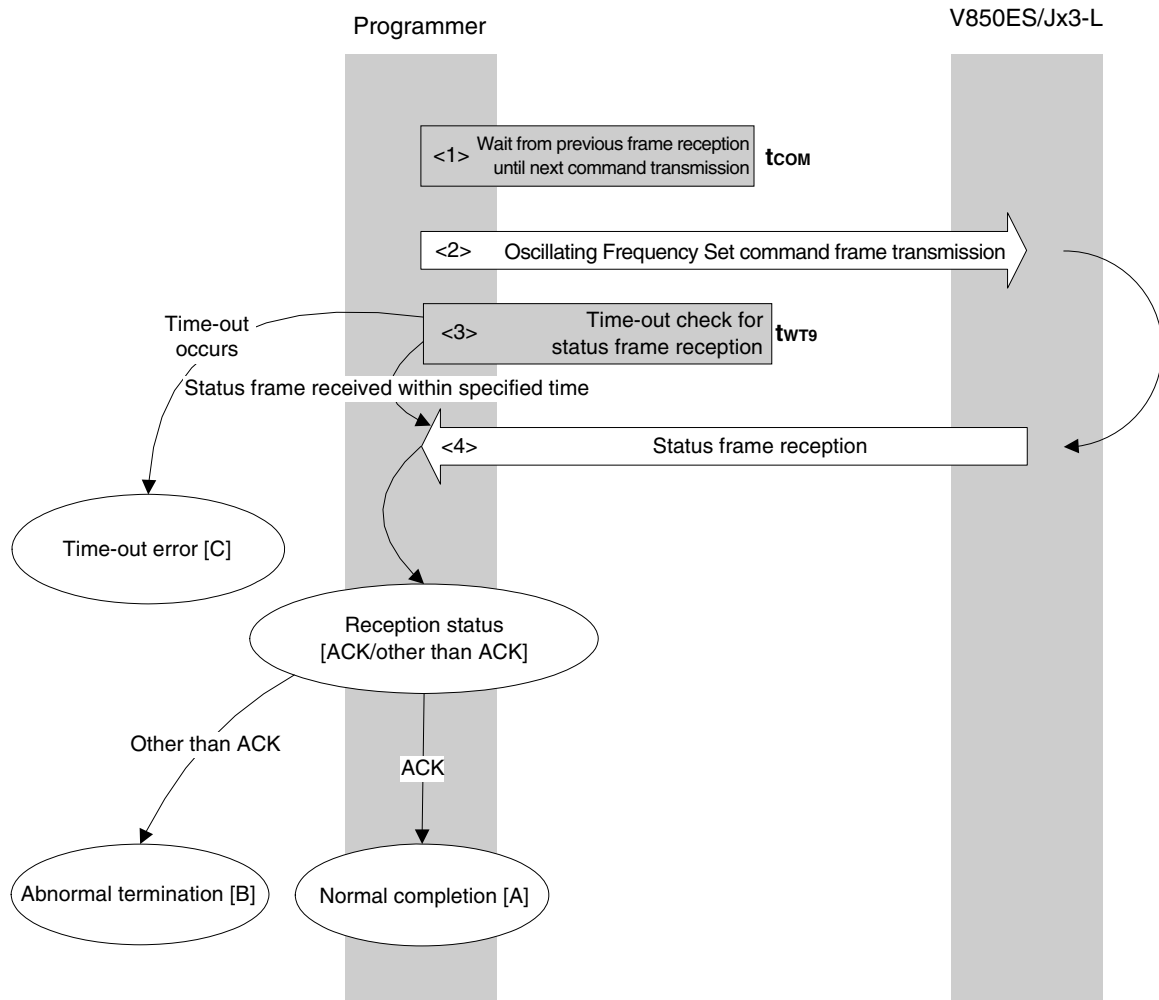

**4.6.2 Description of processing sequence**

- <1> Waits from the previous frame reception until the next command transmission (wait time  $t_{COM}$ ).
- <2> The Oscillating Frequency Set command is transmitted by command frame transmission processing.
- <3> A time-out check is performed from command transmission until status frame reception.  
If a time-out occurs, a time-out error [C] is returned (time-out time  $t_{WT9}$ ).
- <4> The status code is checked.

When ST1 = ACK: Normal completion [A]

When ST1  $\neq$  ACK: Abnormal termination [B]

**4.6.3 Status at processing completion**

Status at Processing Completion		Status Code	Description
Normal completion [A]	Normal acknowledgment (ACK)	06H	The command was executed normally and the operating frequency was correctly set to the V850ES/Jx3-L.
Abnormal termination [B]	Parameter error	05H	The oscillation frequency value is out of range.
	Checksum error	07H	The checksum of the transmitted command frame does not match.
	Negative acknowledgment (NACK)	15H	<ul style="list-style-type: none"> <li>A command other than the Status command was received during processing.</li> <li>Command frame data is abnormal (such as invalid data length (LEN) or no ETX).</li> </ul>
Time-out error [C]		–	The status frame was not received within the specified time.

## 4.6.4 Flowchart

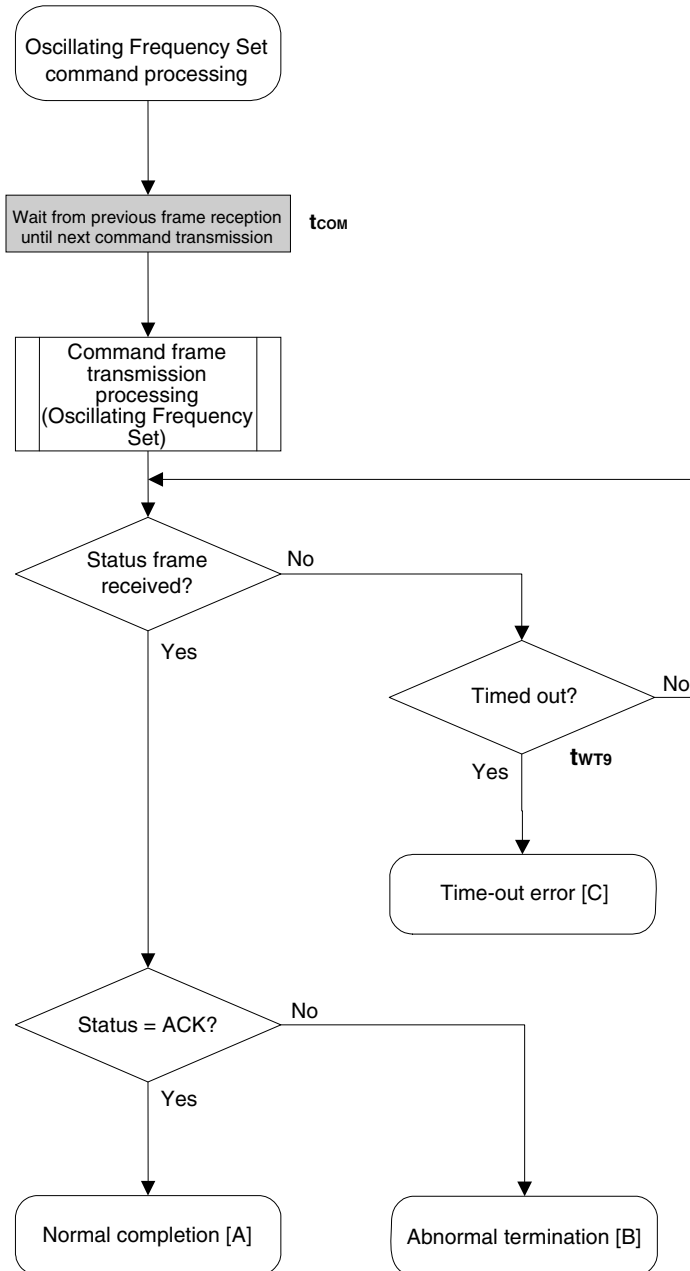

#### 4.6.5 Sample program

The following shows a sample program for Oscillating Frequency Set command processing.

```

/*****
/*
/* Set Flash device clock value command
/*
/*****
/* [i] u8 clk[4] ... frequency data(D1-D4)
/* [r] u16 ... error code
/*****
u16      fl_ua_setclk(u8 clk[])
{
    u16    rc;

    fl_cmd_prm[0] = clk[0]; // "D01"
    fl_cmd_prm[1] = clk[1]; // "D02"
    fl_cmd_prm[2] = clk[2]; // "D03"
    fl_cmd_prm[3] = clk[3]; // "D04"

    fl_wait(tCOM);          // wait before sending command
    put_cmd_ua(FL_COM_SET_OSC_FREQ, 5, fl_cmd_prm);

    rc = get_sfrm_ua(fl_ua_sfrm, tWT9_MAX);          // get status frame
    // switch(rc) {
    //
    //     case    FLC_NO_ERR:      return rc;      break; // case [A]
    //     case    FLC_DFTO_ERR:    return rc;      break; // case [C]
    //     default:                 return rc;      break; // case [B]
    // }

    return rc;
}

```

## 4.7 Chip Erase Command

### 4.7.1 Processing sequence chart

Chip Erase command processing sequence

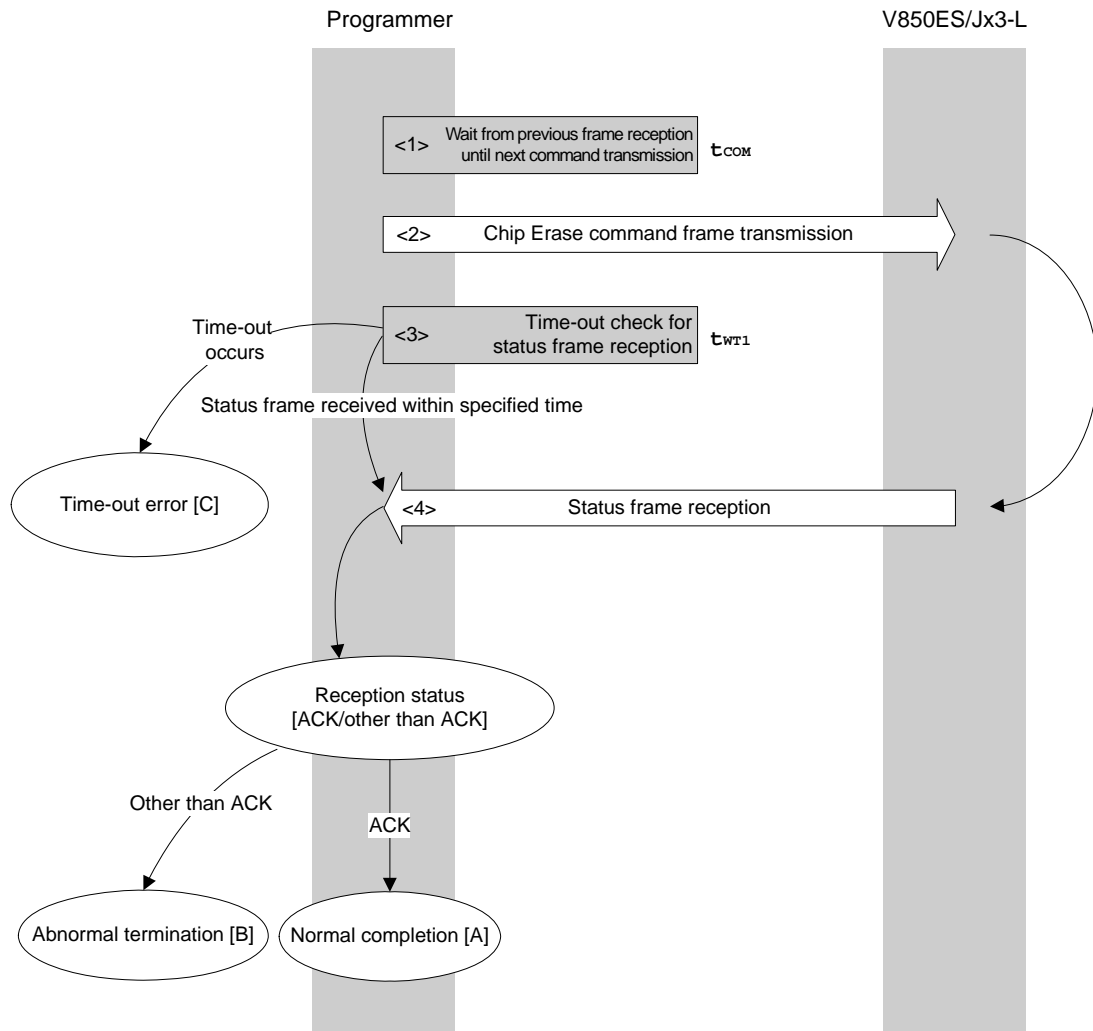

**4.7.2 Description of processing sequence**

- <1> Waits from the previous frame reception until the next command transmission (wait time  $t_{COM}$ ).
- <2> The Chip Erase command is transmitted by command frame transmission processing.
- <3> A time-out check is performed from command transmission until status frame reception.  
If a time-out occurs, a time-out error [C] is returned (time-out time  $t_{WT1}$ ).
- <4> The status code is checked.

When ST1 = ACK: Normal completion [A]

When ST1  $\neq$  ACK: Abnormal termination [B]

**4.7.3 Status at processing completion**

Status at Processing Completion		Status Code	Description
Normal completion [A]	Normal acknowledgment (ACK)	06H	The command was executed normally and chip erase was performed normally.
Abnormal termination [B]	Checksum error	07H	The checksum of the transmitted command frame does not match.
	Protect error	10H	Chip erase and boot block rewrite are prohibited by the security setting.
	Negative acknowledgment (NACK)	15H	<ul style="list-style-type: none"> <li>A command other than the Status command was received during processing.</li> <li>Command frame data is abnormal (such as invalid data length (LEN) or no ETX).</li> </ul>
	WRITE error	1CH	An erase error has occurred.
	MRG10 error	1AH	
	MRG11 error	1BH	
Time-out error [C]		–	The status frame was not received within the specified time.

## 4.7.4 Flowchart

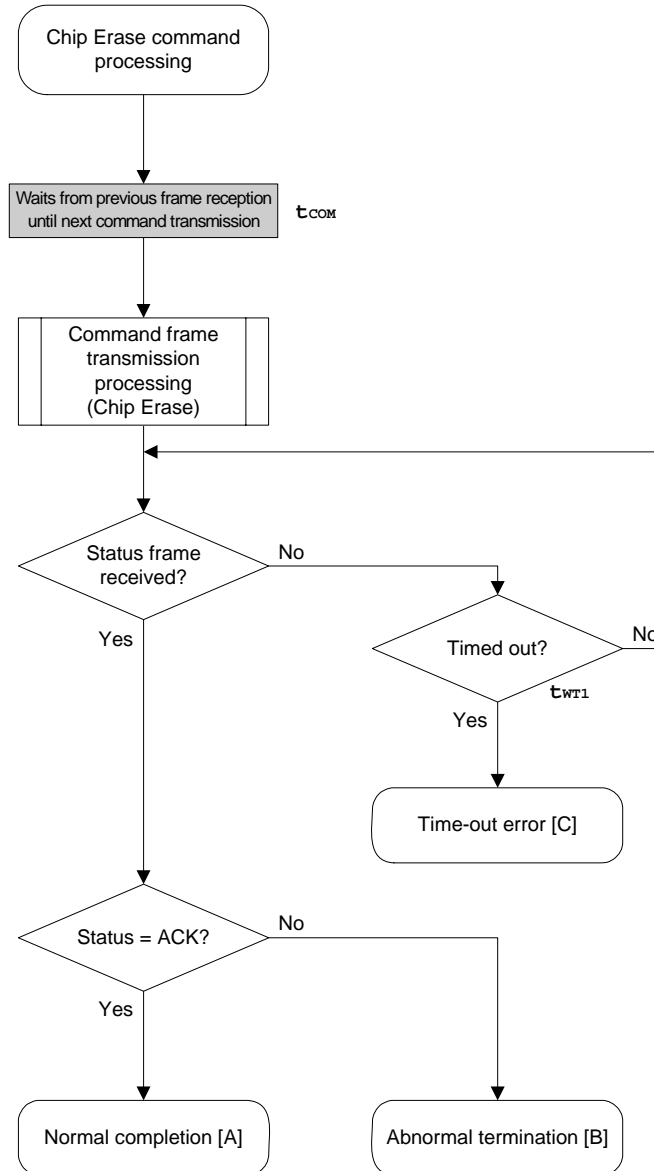



#### 4.7.5 Sample program

The following shows a sample program for Chip Erase command processing.

```

/*****
/*
/* Erase all(chip) command
/*
/*****
/* [r] u16 ... error code
/*****
u16      fl_ua_erase_all(void)
{
    u16    rc;

    fl_wait(tCOM);          // wait before sending command

    put_cmd_ua(FL_COM_ERASE_CHIP, 1, fl_cmd_prm); // send ERASE CHIP command

    rc = get_sfrm_ua(fl_ua_sfrm, tWT1_MAX);        // get status frame
    // switch(rc) {
    //
    //     case    FLC_NO_ERR:    return rc;    break; // case [A]
    //     case    FLC_DFTO_ERR:  return rc;    break; // case [C]
    //     default:                return rc;    break; // case [B]
    // }
    return rc;
}

```

## 4.8 Block Erase Command

### 4.8.1 Processing sequence chart

Block Erase command processing sequence

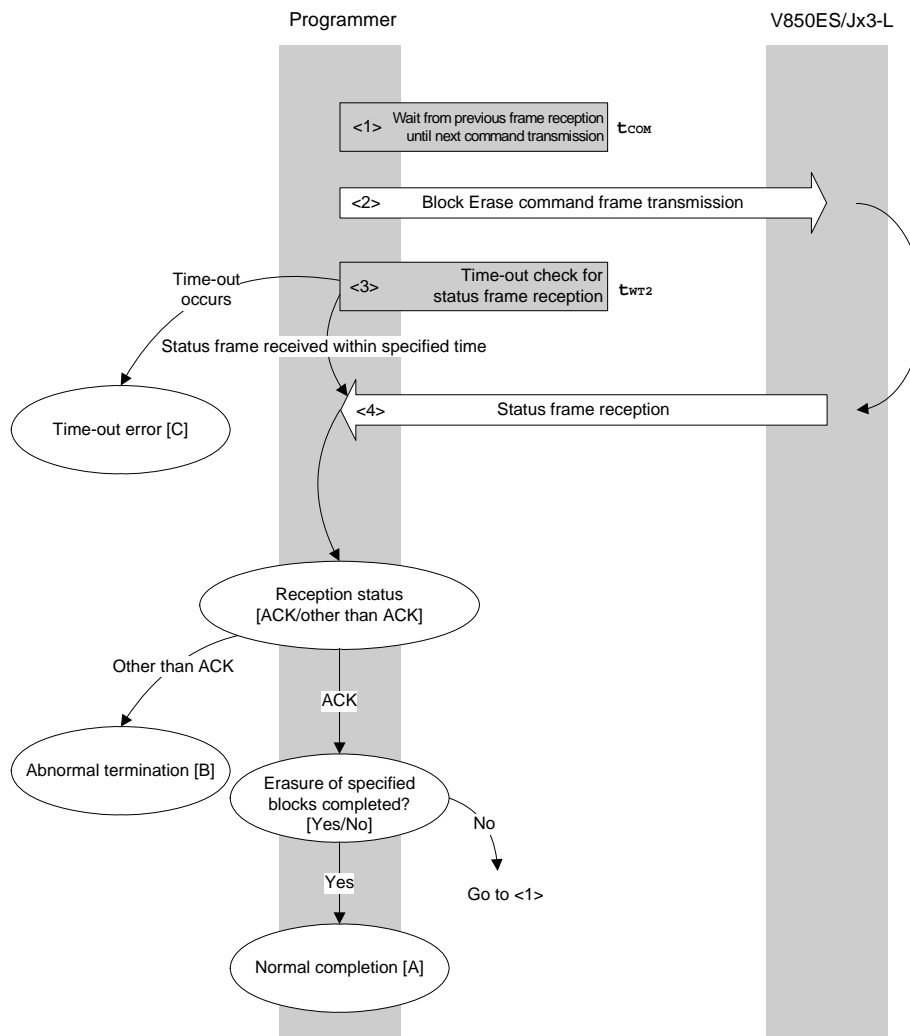

#### 4.8.2 Description of processing sequence

- <1> Waits from the previous frame reception until the next command transmission (wait time  $t_{COM}$ ).
- <2> The Block Erase command is transmitted by command frame transmission processing.
- <3> A time-out check is performed from command transmission until status frame reception.  
If a time-out occurs, a time-out error [C] is returned (time-out time  $t_{WT2}$ ).
- <4> The status code is checked.

When ST1 = ACK: When the block erase for all of the specified blocks is not yet completed, processing changes the block number and re-executes the sequence from <1>.

When the block erase for all of the specified blocks is completed, the processing ends normally [A].

When ST1  $\neq$  ACK: Abnormal termination [B]

#### 4.8.3 Status at processing completion

Status at Processing Completion		Status Code	Description
Normal completion [A]	Normal acknowledgment (ACK)	06H	The command was executed normally and block erase was performed normally.
Abnormal termination [B]	Parameter error	05H	The specified start/end address is not the start/end address of the block.
	Checksum error	07H	The checksum of the transmitted command frame does not match.
	Protect error	10H	Any one of write, block erase, or chip erase is prohibited by the security setting. Or, boot block rewrite is prohibited by the security setting because specified range includes the boot area.
	Negative acknowledgment (NACK)	15H	<ul style="list-style-type: none"> <li>• A command other than the Status command was received during processing.</li> <li>• Command frame data is abnormal (such as invalid data length (LEN) or no ETX).</li> </ul>
	MRG10 error	1AH	An erase error has occurred.
Time-out error [C]		–	The status frame was not received within the specified time.

4.8.4 Flowchart

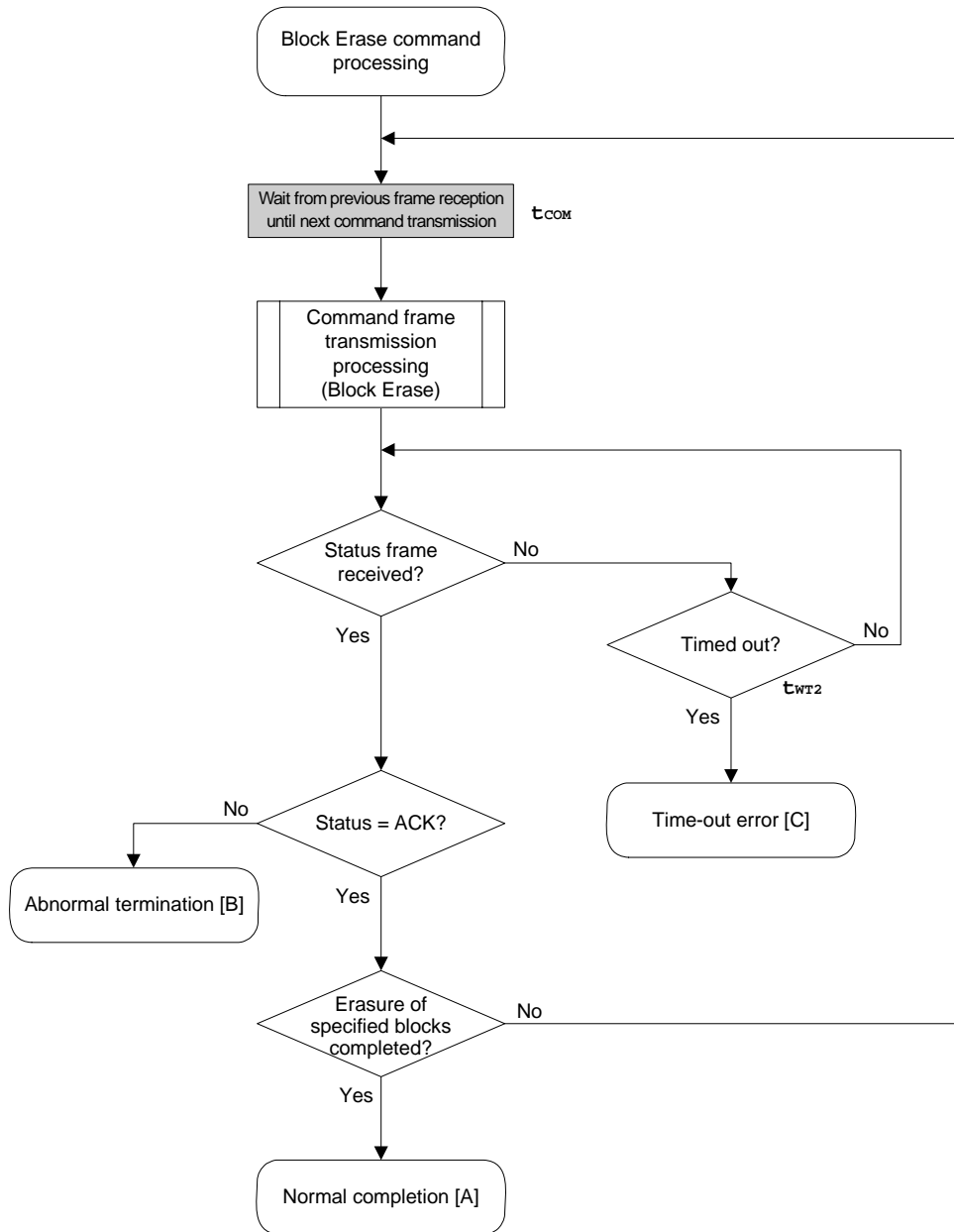

#### 4.8.5 Sample program

The following shows a sample program for Block Erase command processing for one block.

```

/*****/
/*
/* Erase block command
/*
/*****/
/* [i] u16 sblk      ... start block number
/* [i] u16 eblk      ... end block number
/* [r] u16           ... error code
/*****/
u16      fl_ua_erase_blk(u16 sblk, u16 eblk)
{

    u16    rc;
    u32    wt2_max;
    u32    top, bottom;

    top = get_top_addr(sblk);          // get start address of start block
    bottom = get_bottom_addr(eblk);    // get end address of end block

    set_range_prm(fl_cmd_prm, top, bottom);    // set SAH/SAM/SAL, EAH/EAM/EAL

    wt2_max = make_wt2_max(sblk, eblk);    // get tWT2(Max)

    fl_wait(tCOM);                      // wait before sending command

    put_cmd_ua(FL_COM_ERASE_BLOCK, 7, fl_cmd_prm); // send ERASE CHIP command

    rc = get_sfrm_ua(fl_ua_sfrm, wt2_max); // get status frame

    // switch(rc) {
    //
    //     case    FLC_NO_ERR:    return rc;    break; // case [A]
    //     case    FLC_DFTO_ERR: return rc;    break; // case [C]
    //     default:              return rc;    break; // case [B]
    // }

    return rc;

}

```

### 4.9 Programming Command

#### 4.9.1 Processing sequence chart

Programming command processing sequence

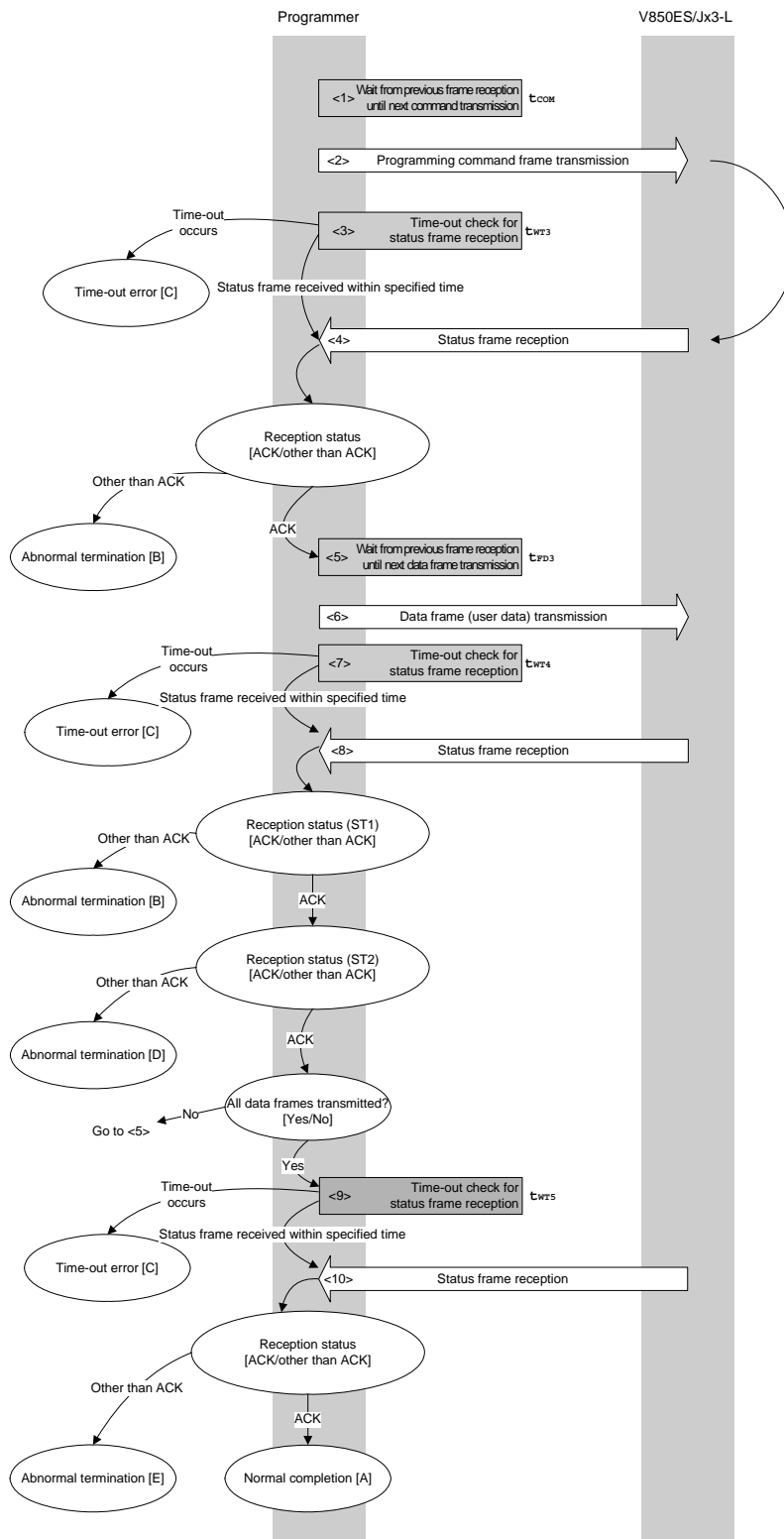

**4.9.2 Description of processing sequence**

- <1> Waits from the previous frame reception until the next command transmission (wait time  $t_{COM}$ ).
- <2> The Programming command is transmitted by command frame transmission processing.
- <3> A time-out check is performed from command transmission until status frame reception.  
If a time-out occurs, a time-out error [C] is returned (time-out time  $t_{WT3}$ ).
- <4> The status code is checked.

When ST1 = ACK: Proceeds to <5>.

When ST1  $\neq$  ACK: Abnormal termination [B]

- <5> Waits from the previous frame reception until the next data frame transmission (wait time  $t_{FD3}$ ).
- <6> User data is transmitted by data frame transmission processing.
- <7> A time-out check is performed from user data transmission until data frame reception.  
If a time-out occurs, a time-out error [C] is returned (time-out time  $t_{WT4}$ ).
- <8> The status code (ST1/ST2) is checked (also refer to the processing sequence chart and flowchart).

When ST1  $\neq$  ACK: Abnormal termination [B]

When ST1 = ACK: The following processing is performed according to the ST2 value.

- When ST2 = ACK: Proceeds to <9> when transmission of all data frames is completed.  
If there still remain data frames to be transmitted, the processing re-executes the sequence from <5>.
- When ST2  $\neq$  ACK: Abnormal termination [D]

- <9> A time-out check is performed until status frame reception.  
If a time-out occurs, a time-out error [C] is returned (time-out time  $t_{WT5}$ ).
- <10> The status code is checked.

When ST1 = ACK: Normal completion [A]

When ST1  $\neq$  ACK: Abnormal termination [E]

**4.9.3 Status at processing completion**

Status at Processing Completion		Status Code	Description
Normal completion [A]	Normal acknowledgment (ACK)	06H	The command was executed normally and the user data was written normally.
Abnormal termination [B]	Parameter error	05H	The specified start/end address is not the start/end address of the block.
	Checksum error	07H	The checksum of the transmitted command frame does not match.
	Protect error	10H	Write is prohibited by the security setting. Or, boot block rewrite is prohibited by the security setting because specified range includes the boot area.
	Negative acknowledgment (NACK)	15H	<ul style="list-style-type: none"> <li>• A command other than the Status command was received during processing.</li> <li>• Command frame data is abnormal (such as invalid data length (LEN) or no ETX).</li> </ul>
Time-out error [C]		–	The status frame was not received within the specified time.
Abnormal termination [D]	WRITE error	1CH	A write error has occurred.
Abnormal termination [E]	MRG11 error	1BH	An internal verify error has occurred.



4.9.4 Flowchart

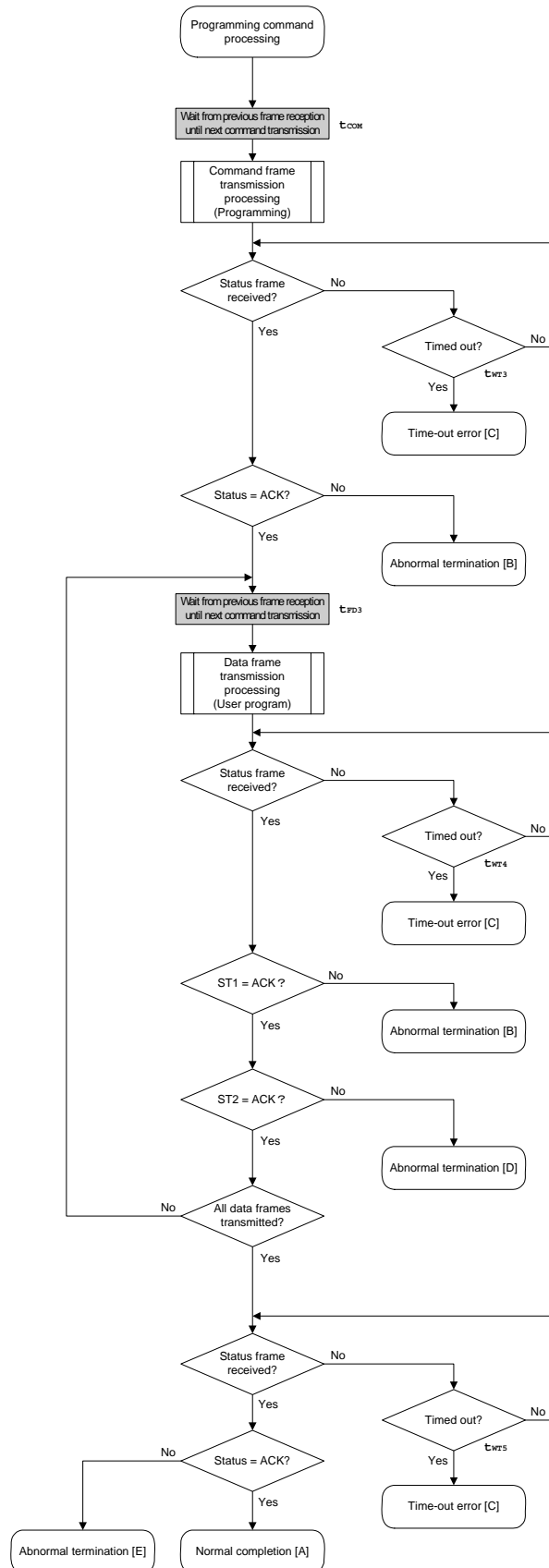

#### 4.9.5 Sample program

The following shows a sample program for Programming command processing.

```

/*****/
/*
/* Write command
/*
/*****/
/* [i] u32 top      ... start address
/* [i] u32 bottom  ... end address
/* [r] u16         ... error code
/*****/

#define          fl_st2_ua      (fl_ua_sfrm[OFS_STA_PLD+1])

u16            fl_ua_write(u32 top, u32 bottom)
{
    u16        rc;
    u32        send_head, send_size;
    bool       is_end;
    u32        wt5_max;

    /*****/
    /*      set params
    /*****/
    set_range_prm(fl_cmd_prm, top, bottom);          // set SAH/SAM/SAL, EAH/EAM/EAL
    wt5_max = make_wt5_max(get_block_num(top, bottom));

    /*****/
    /*      send command & check status
    /*****/
    fl_wait(tCOM);          // wait before sending command

    put_cmd_ua(FL_COM_WRITE, 7, fl_cmd_prm); // send "Programming" command

    rc = get_sfrm_ua(fl_ua_sfrm, tWT3_MAX);          // get status frame
    switch(rc) {
        case    FLC_NO_ERR:                break; // continue
        // case    FLC_DFTO_ERR:    return rc;    break; // case [C]
        default:                return rc;    break; // case [B]
    }

    /*****/
    /*      send user data
    /*****/
    send_head = top;

    while(1){
        // make send data frame
        if ((bottom - send_head) > 256){          // rest size > 256 ?
            is_end = false;                        // yes, not is_end frame
            send_size = 256;                        // transmit size = 256 byte
        }
        else{
            is_end = true;

```

```

        send_size = bottom - send_head + 1;
                                // transmit size = (bottom - send_head)+1
byte

    }
    memcpy(fl_txdata_frm, rom_buf+send_head, send_size);
                                // set data frame payload
    send_head += send_size;

    fl_wait(tFD3);                // wait before sending data frame

    put_dfrm_ua(send_size, fl_txdata_frm, is_end); // send user data

    rc = get_sfrm_ua(fl_ua_sfrm, tWT4_MAX);    // get status frame
    switch(rc) {
        case FLC_NO_ERR:                break; // continue
        case FLC_DFTO_ERR:    return rc;    break; // case [C]
        default:                return rc;    break; // case [B]
    }
    if (fl_st2_ua != FLST_ACK){          // ST2 = ACK ?
        rc = decode_status(fl_st2_ua); // No
        return rc;                      // case [D]
    }
    if (is_end)
        break;

}
/*****
/*      Check internally verify          */
*****/
rc = get_sfrm_ua(fl_ua_sfrm, wt5_max); // get status frame again
// switch(rc) {
//     case FLC_NO_ERR:    return rc;    break; // case [A]
//     case FLC_DFTO_ERR:    return rc;    break; // case [C]
//     default:                return rc;    break; // case [E]
// }
return rc;
}

```

### 4.10 Verify Command

#### 4.10.1 Processing sequence chart

Verify command processing sequence

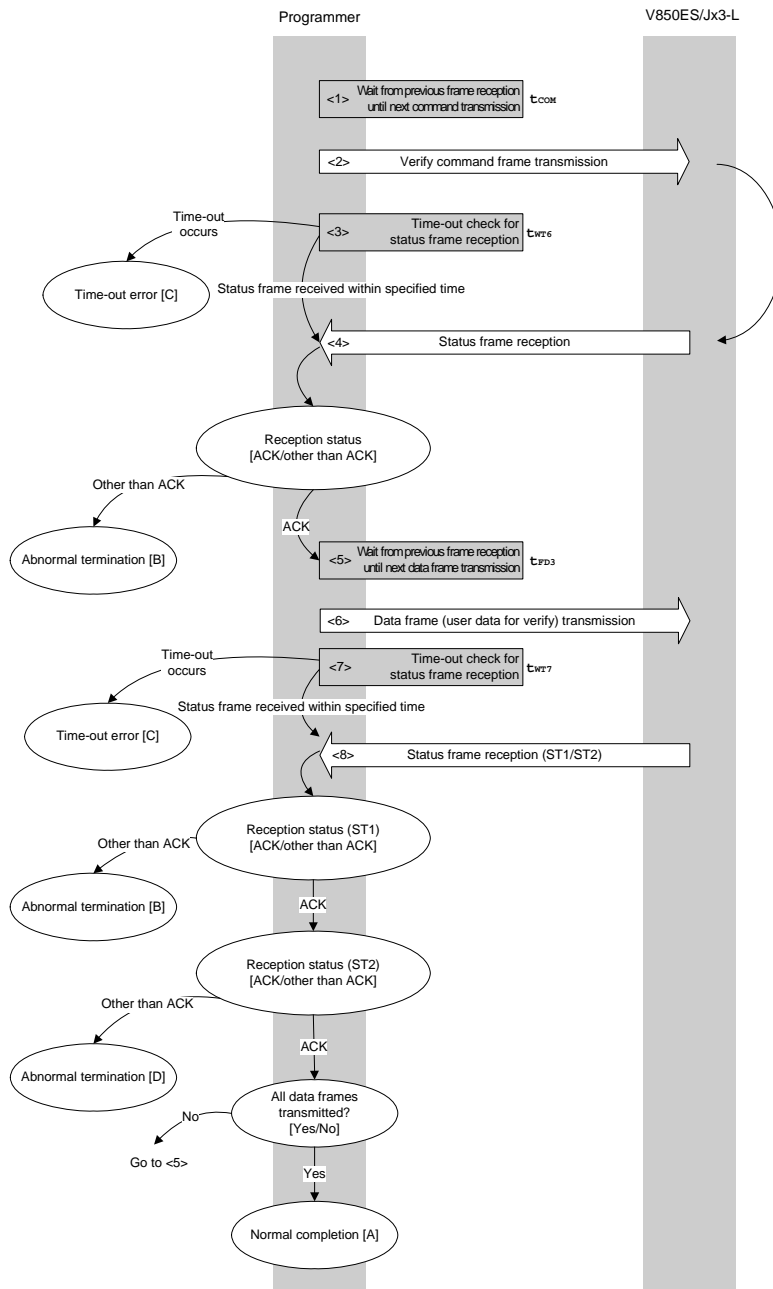

#### 4.10.2 Description of processing sequence

- <1> Waits from the previous frame reception until the next command transmission (wait time  $t_{COM}$ ).
- <2> The Verify command is transmitted by command frame transmission processing.
- <3> A time-out check is performed from command transmission until status frame reception.  
If a time-out occurs, a time-out error [C] is returned (time-out time  $t_{WT6}$ ).
- <4> The status code is checked.

When ST1 = ACK: Proceeds to <5>.

When ST1  $\neq$  ACK: Abnormal termination [B]

- <5> Waits from the previous frame reception until the next data frame transmission (wait time  $t_{FD3}$ ).
- <6> User data for verifying is transmitted by data frame transmission processing.
- <7> A time-out check is performed from user data transmission until status frame reception.  
If a time-out occurs, a time-out error [C] is returned (time-out time  $t_{WT7}$ ).
- <8> The status code (ST1/ST2) is checked (also refer to the processing sequence chart and flowchart).

When ST1  $\neq$  ACK: Abnormal termination [B]

When ST1 = ACK: The following processing is performed according to the ST2 value.

- When ST2 = ACK: If transmission of all data frames is completed, the processing ends normally [A].  
If there still remain data frames to be transmitted, the processing re-executes the sequence from <5>.
- When ST2  $\neq$  ACK: Abnormal termination [D]

#### 4.10.3 Status at processing completion

Status at Processing Completion		Status Code	Description
Normal completion [A]	Normal acknowledgment (ACK)	06H	The command was executed normally and the verify was completed normally.
Abnormal termination [B]	Parameter error	05H	The specified start/end address is not the start/end address of the block.
	Checksum error	07H	The checksum of the transmitted command frame or data frame does not match.
	Negative acknowledgment (NACK)	15H	<ul style="list-style-type: none"> <li>• A command other than the Status command was received during processing.</li> <li>• Command frame data is abnormal (such as invalid data length (LEN) or no ETX).</li> </ul>
Time-out error [C]		–	The status frame was not received within the specified time.
Abnormal termination [D]	Verify error	0FH	The verify has failed, or another error has occurred.

4.10.4 Flowchart

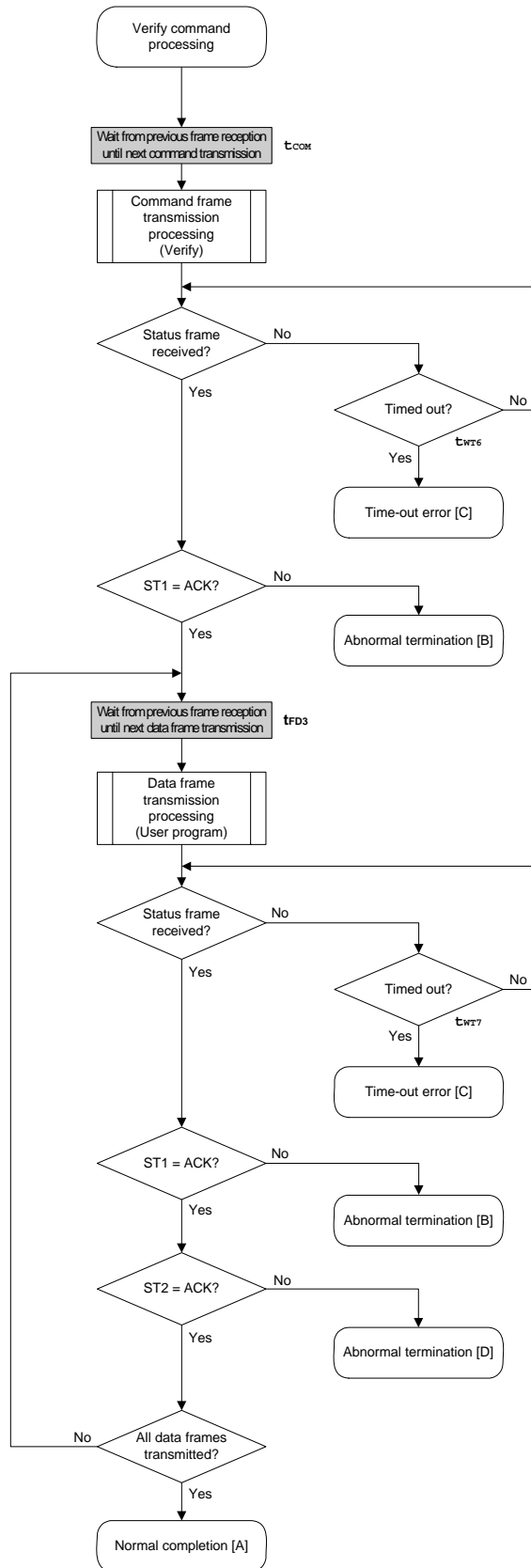

#### 4.10.5 Sample program

The following shows a sample program for Verify command processing.

```

/*****/
/*
/* Verify command
/*
/*****/
/* [i] u32 top      ... start address
/* [i] u32 bottom  ... end address
/* [r] u16         ... error code
/*****/
u16      fl_ua_verify(u32 top, u32 bottom, u8 *buf)
{
    u16    rc;
    u32    send_head, send_size;
    bool   is_end;

    /*****/
    /*      set params
    /*****/
    set_range_prm(fl_cmd_prm, top, bottom);      // set SAH/SAM/SAL, EAH/EAM/EAL

    /*****/
    /*      send command & check status
    /*****/

    fl_wait(tCOM);      // wait before sending command

    put_cmd_ua(FL_COM_VERIFY, 7, fl_cmd_prm);      // send VERIFY command

    rc = get_sfrm_ua(fl_ua_sfrm, tWT6_MAX);      // get status frame
    switch(rc) {
        case    FLC_NO_ERR:      break; // continue
        // case    FLC_DFTO_ERR:  return rc; break; // case [C]
        default:      return rc; break; // case [B]
    }

    /*****/
    /*      send user data
    /*****/
    send_head = top;

    while(1){

        // make send data frame
        if ((bottom - send_head) > 256){      // rest size > 256 ?
            is_end = false;      // yes, not is_end frame
            send_size = 256;      // transmit size = 256 byte
        }
        else{
            is_end = true;
            send_size = bottom - send_head + 1;      // transmit size =
(bottom - send_head)+1 byte

```

```
    }
    memcpy(fl_txdata_frm, buf+send_head, send_size); // set data frame payload
    send_head += send_size;

    fl_wait(tFD3);
    put_dfrm_ua(send_size, fl_txdata_frm, is_end); // send user data

    rc = get_sfrm_ua(fl_ua_sfrm, tWT7_MAX); // get status frame
    switch(rc) {
        case FLC_NO_ERR: break; // continue
        // case FLC_DFTO_ERR: return rc; break; // case [C]
        default: return rc; break; // case [B]
    }
    if (fl_st2_ua != FLST_ACK){ // ST2 = ACK ?
        rc = decode_status(fl_st2_ua); // No
        return rc; // case [D]
    }
    if (is_end) // send all user data ?
        break; // yes
    //continue;
}
return FLC_NO_ERR; // case [A]
}
```



### 4.11 Block Blank Check Command

#### 4.11.1 Processing sequence chart

Block Blank Check command processing sequence

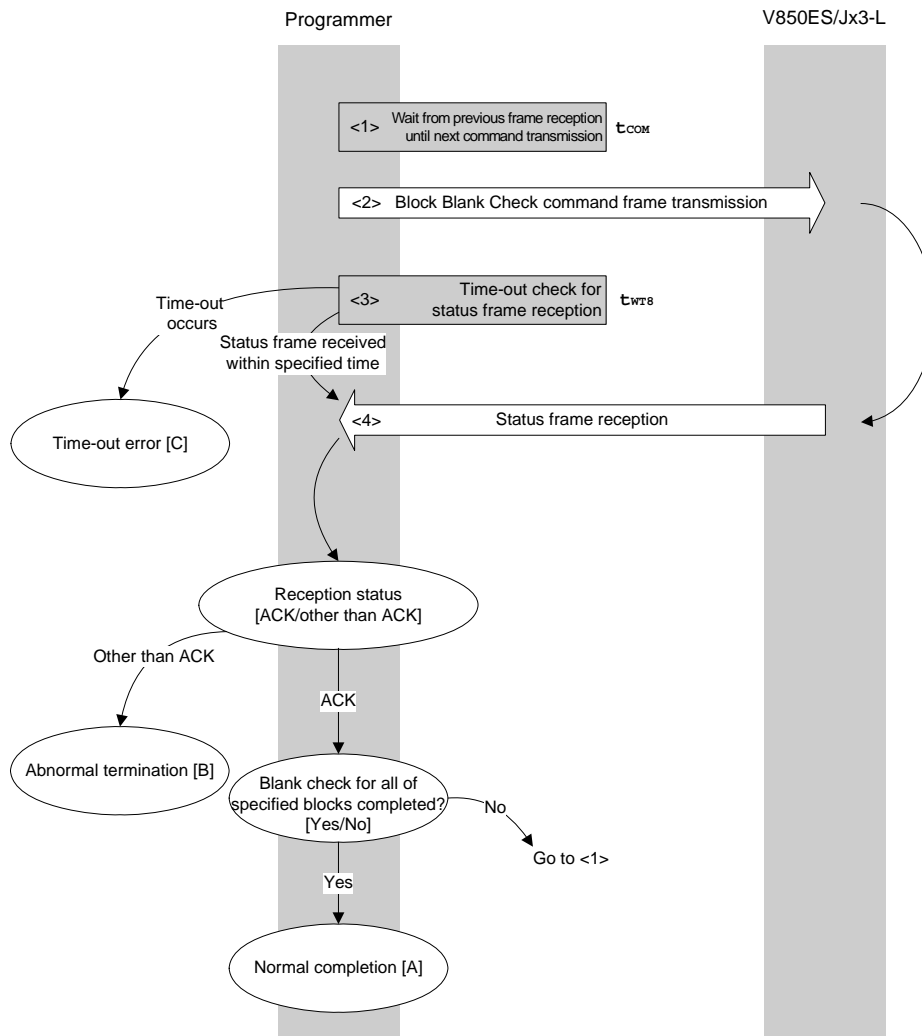

#### 4.11.2 Description of processing sequence

- <1> Waits from the previous frame reception until the next command transmission (wait time  $t_{COM}$ ).
- <2> The Block Blank Check command is transmitted by command frame transmission processing.
- <3> A time-out check is performed from command transmission until status frame reception.  
If a time-out occurs, a time-out error [C] is returned (time-out time  $t_{WTB}$ ).
- <4> The status code is checked.

When ST1 = ACK: If the blank check for all of the specified blocks is not yet completed, processing changes the block number and re-executes the sequence from <1>.  
If the blank check for all of the specified blocks is completed, the processing ends normally [A].

When ST1  $\neq$  ACK: Abnormal termination [B]

#### 4.11.3 Status at processing completion

Status at Processing Completion		Status Code	Description
Normal completion [A]	Normal acknowledgment (ACK)	06H	The command was executed normally and all of the specified blocks are blank.
Abnormal termination [B]	Parameter error	05H	The specified start/end address is not the start/end address of the block.
	Checksum error	07H	The checksum of the transmitted command frame does not match.
	Negative acknowledgment (NACK)	15H	<ul style="list-style-type: none"> <li>• A command other than the Status command was received during processing.</li> <li>• Command frame data is abnormal (such as invalid data length (LEN) or no ETX).</li> </ul>
	MRG11 error	1BH	The specified block in the flash memory is not blank.
Time-out error [C]		–	The status frame was not received within the specified time.

4.11.4 Flowchart

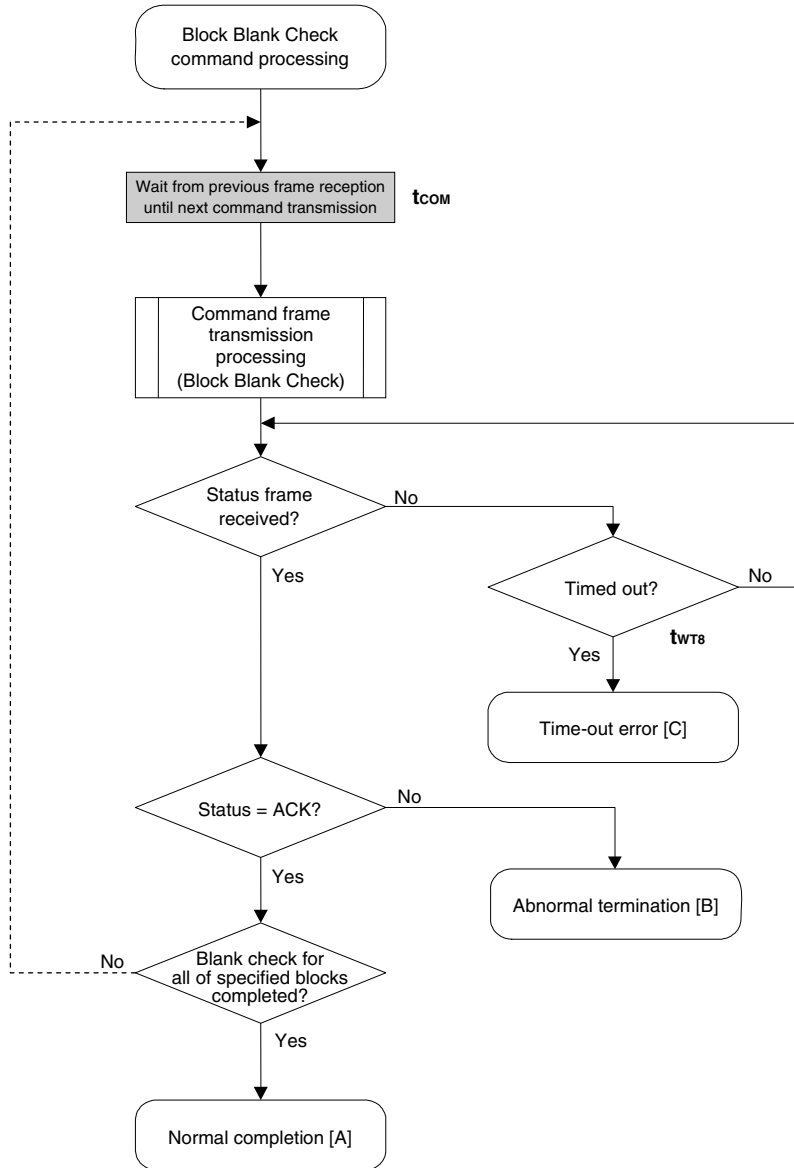

#### 4.11.5 Sample program

The following shows a sample program for Block Blank Check command processing for one block.

```

/*****
/*
/* Block blank check command
/*
/*****
/* [i] u16 sblk      ... start block number
/* [i] u16 eblk      ... end block number
/* [r] u16           ... error code
/*****
u16      fl_ua_blk_blank_chk(u16 sblk, u16 eblk)
{
    u16    rc;
    u32    wt8_max;

    u32    top, bottom;

    top = get_top_addr(sblk);          // get start address of start block
    bottom = get_bottom_addr(eblk);    // get end address of end block
    set_range_prm(fl_cmd_prm, top, bottom); // set SAH/SAM/SAL, EAH/EAM/EAL

    wt8_max = make_wt8_max(sblk, eblk); // get tWT8(Max)

    fl_wait(tCOM);                    // wait before sending command

    put_cmd_ua(FL_COM_BLOCK_BLANK_CHK, 7, fl_cmd_prm);
    rc = get_sfrm_ua(fl_ua_sfrm, wt8_max+6*1000); // get status frame
    // switch(rc) {
    //
    //     case    FLC_NO_ERR:    return rc;    break; // case [A]
    //     case    FLC_DFTO_ERR:  return rc;    break; // case [C]
    //     default:                return rc;    break; // case [B]
    // }
    return rc;
}

```

## 4.12 Silicon Signature Command

### 4.12.1 Processing sequence chart

Silicon Signature command processing sequence

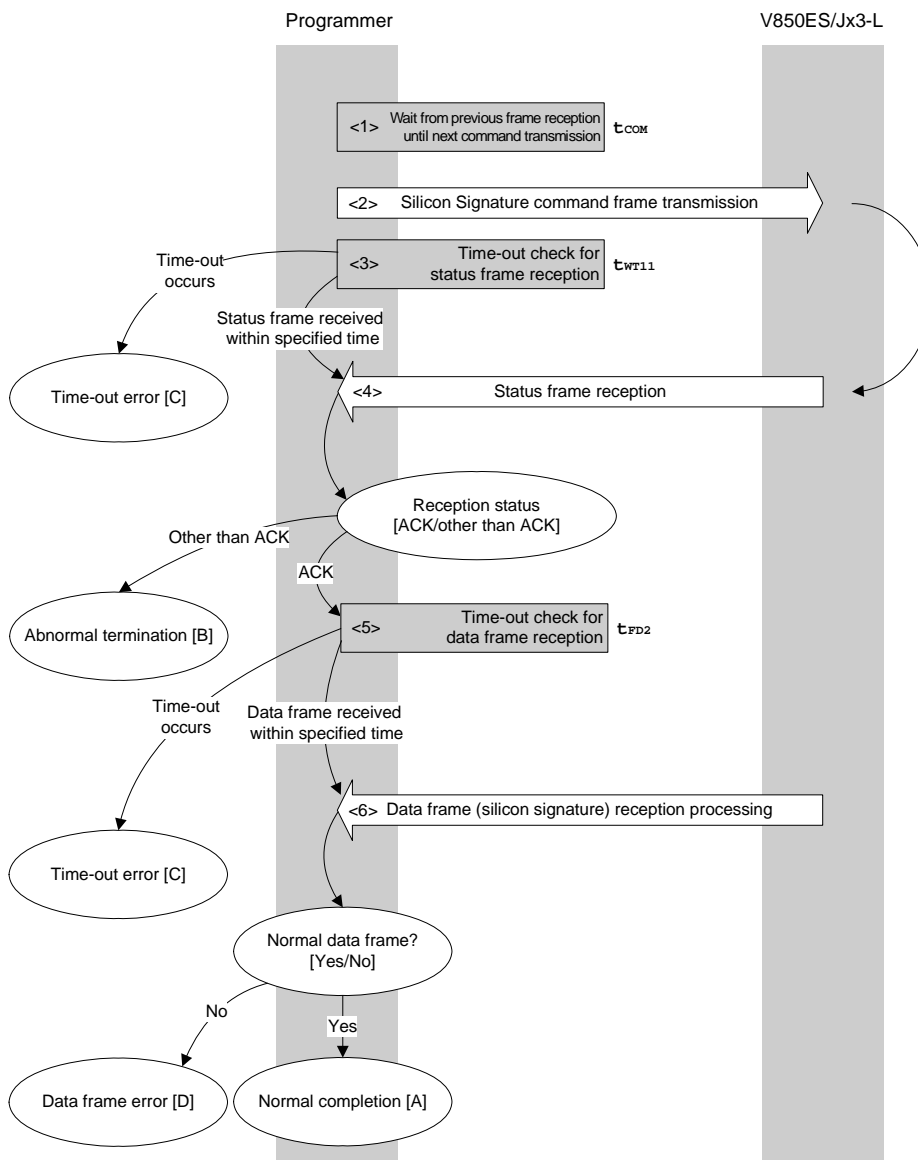

**4.12.2 Description of processing sequence**

- <1> Waits from the previous frame reception until the next command transmission (wait time  $t_{COM}$ ).
- <2> The Silicon Signature command is transmitted by command frame transmission processing.
- <3> A time-out check is performed from command transmission until status frame reception.  
If a time-out occurs, a time-out error [C] is returned (time-out time  $t_{WT1}$ ).
- <4> The status code is checked.

When ST1 = ACK: Proceeds to <5>.

When ST1  $\neq$  ACK: Abnormal termination [B]

- <5> A time-out check is performed until data frame (silicon signature data) reception.  
If a time-out occurs, a time-out error [C] is returned (time-out time  $t_{FD2}$ ).
- <6> The received data frame (silicon signature data) is checked.

If data frame is normal: Normal completion [A]

If data frame is abnormal: Data frame error [D]

**4.12.3 Status at processing completion**

Status at Processing Completion		Status Code	Description
Normal completion [A]	Normal acknowledgment (ACK)	06H	The command was executed normally and the silicon signature was acquired normally.
Abnormal termination [B]	Checksum error	07H	The checksum of the transmitted command frame does not match.
	Negative acknowledgment (NACK)	15H	<ul style="list-style-type: none"> <li>A command other than the Status command was received during processing.</li> <li>Command frame data is abnormal (such as invalid data length (LEN) or no ETX).</li> </ul>
Time-out error [C]		–	The status frame or data frame was not received within the specified time.
Data frame error [D]		–	The checksum of the data frame received as silicon signature data does not match.

4.12.4 Flowchart

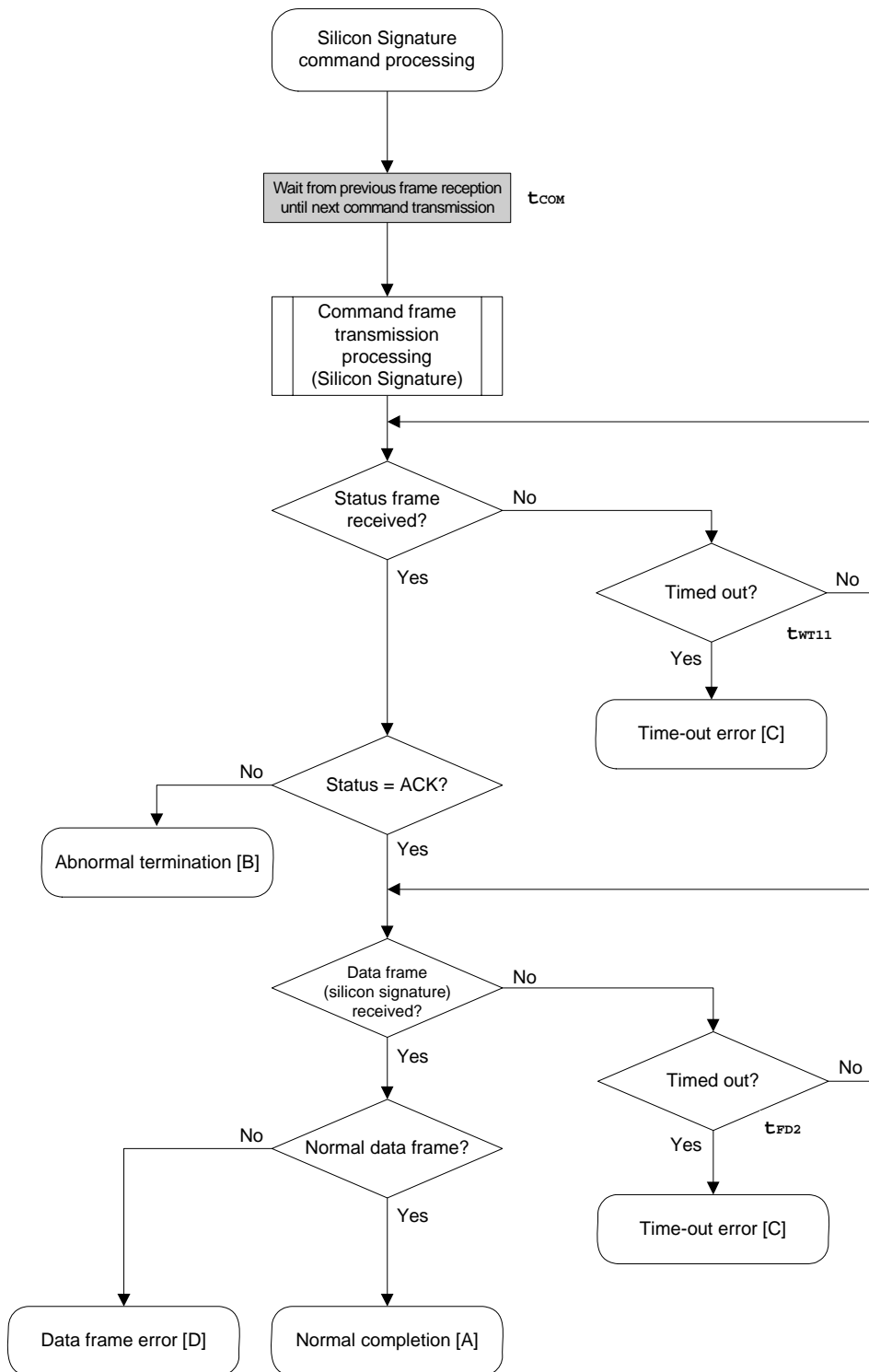

#### 4.12.5 Sample program

The following shows a sample program for Silicon Signature command processing.

```

/*****
/*
/* Get silicon signature command
/*
/*****
/* [i] u8 *sig ... pointer to signature save area
/* [r] u16 ... error code
/*****
u16      fl_ua_getsig(u8 *sig)
{
    u16    rc;

    fl_wait(tCOM);          // wait before sending command

    put_cmd_ua(FL_COM_GET_SIGNATURE, 1, fl_cmd_prm); // send GET SIGNATURE command

    rc = get_sfrm_ua(fl_ua_sfrm, tWT11_MAX);          // get status frame
    switch(rc) {
        case FLC_NO_ERR:                break; // continue
        // case FLC_DFTO_ERR: return rc; break; // case [C]
        default:                        return rc; break; // case [B]
    }

    rc = get_dfrm_ua(fl_rxdata_frm, tFD2_MAX);        // get status frame
    if (rc){
        return rc;                                // if error
        // case [D]
    }
    memcpy(sig, fl_rxdata_frm+OFS_STA_PLD, fl_rxdata_frm[OFS_LEN]);
                                                // copy Signature data
    return rc;                                    // case [A]
}

```



4.13 Version Get Command

4.13.1 Processing sequence chart

Version Get command processing sequence

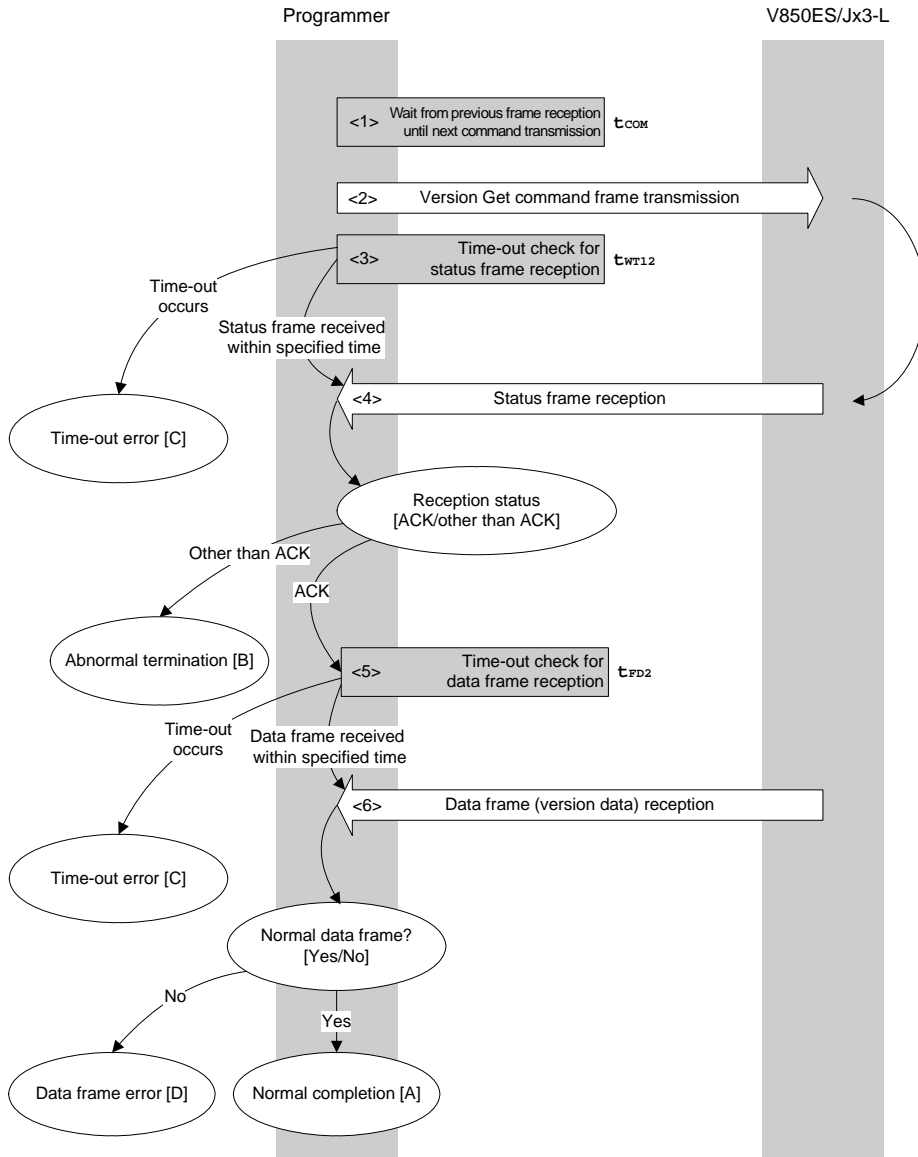

**4.13.2 Description of processing sequence**

- <1> Waits from the previous frame reception until the next command transmission (wait time  $t_{COM}$ ).
- <2> The Version Get command is transmitted by command frame transmission processing.
- <3> A time-out check is performed from command transmission until status frame reception.  
If a time-out occurs, a time-out error [C] is returned (time-out time  $t_{WT12}$ ).
- <4> The status code is checked.

When ST1 = ACK: Proceeds to <5>.

When ST1  $\neq$  ACK: Abnormal termination [B]

- <5> A time-out check is performed until data frame (version data) reception.  
If a time-out occurs, a time-out error [C] is returned (time-out time  $t_{FD2}$ ).
- <6> The received data frame (version data) is checked.

If data frame is normal: Normal completion [A]

If data frame is abnormal: Data frame error [D]

**4.13.3 Status at processing completion**

Status at Processing Completion		Status Code	Description
Normal completion [A]	Normal acknowledgment (ACK)	06H	The command was executed normally and version data was acquired normally.
Abnormal termination [B]	Checksum error	07H	The checksum of the transmitted command frame does not match.
	Negative acknowledgment (NACK)	15H	<ul style="list-style-type: none"> <li>A command other than the Status command was received during processing.</li> <li>Command frame data is abnormal (such as invalid data length (LEN) or no ETX).</li> </ul>
Time-out error [C]		–	The status frame or data frame was not received within the specified time.
Data frame error [D]		–	The checksum of the data frame received as version data does not match.

4.13.4 Flowchart

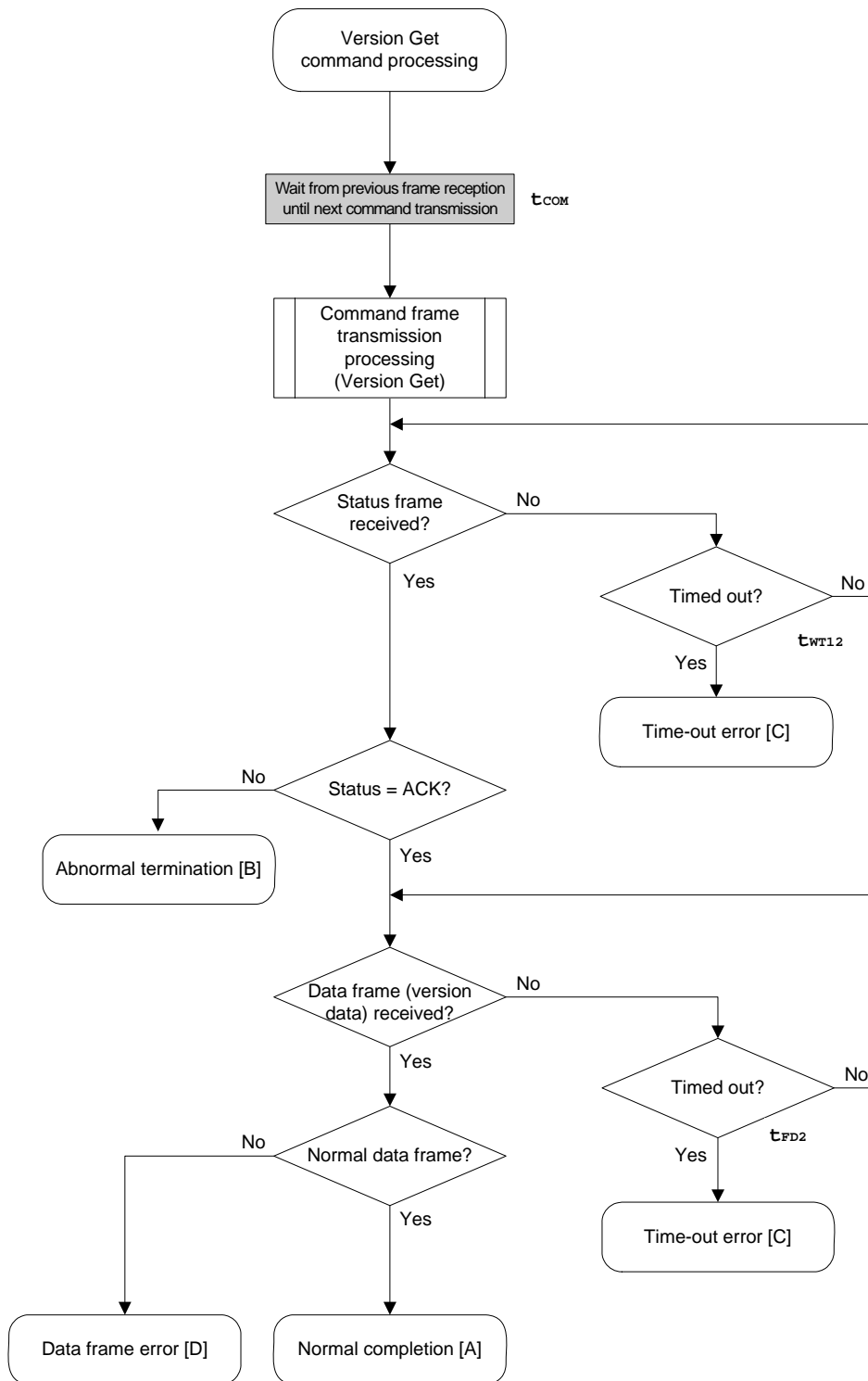

#### 4.13.5 Sample program

The following shows a sample program for Version Get command processing.

```

/*****
/*
/* Get device/firmware version command
/*
/*****
/* [i] u8 *buf ... pointer to version data save area
/* [r] u16 ... error code
/*****
u16      fl_ua_getver(u8 *buf)
{
    u16    rc;

    fl_wait(tCOM);          // wait before sending command

    put_cmd_ua(FL_COM_GET_VERSION, 1, fl_cmd_prm); // send GET VERSION command

    rc = get_sfrm_ua(fl_ua_sfrm, tWT12_MAX);      // get status frame
    switch(rc) {
        case FLC_NO_ERR:                          break; // continue
        // case FLC_DFTO_ERR:          return rc;    break; // case [C]
        default:                          return rc;    break; // case [B]
    }

    rc = get_dfrm_ua(fl_rxddata_frm, tFD2_MAX);    // get data frame
    if (rc){
        return rc;                                // case [D]
    }

    memcpy(buf, fl_rxddata_frm+OFS_STA_PLD, DFV_LEN); // copy version data
    return rc;                                    // case [A]
}

```

### 4.14 Checksum Command

#### 4.14.1 Processing sequence chart

Checksum command processing sequence

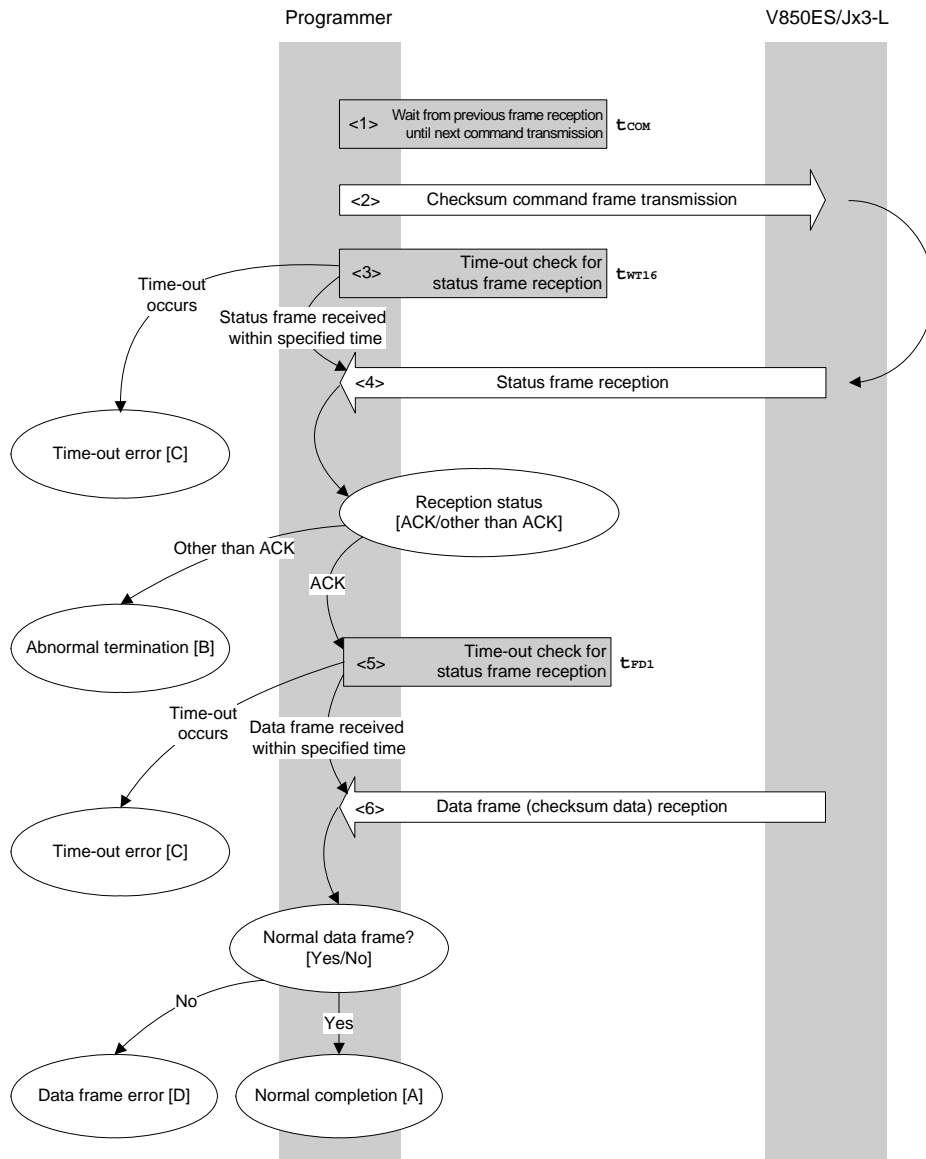

**4.14.2 Description of processing sequence**

- <1> Waits from the previous frame reception until the next command transmission (wait time  $t_{COM}$ ).
- <2> The Checksum command is transmitted by command frame transmission processing.
- <3> A time-out check is performed from command transmission until status frame reception.  
If a time-out occurs, a time-out error [C] is returned (time-out time  $t_{WT16}$ ).
- <4> The status code is checked.

When ST1 = ACK: Proceeds to <5>.

When ST1  $\neq$  ACK: Abnormal termination [B]

- <5> A time-out check is performed until data frame (checksum data) reception.  
If a time-out occurs, a time-out error [C] is returned (time-out time  $t_{FD1}$ ).
- <6> The received data frame (checksum data) is checked.

If data frame is normal: Normal completion [A]

If data frame is abnormal: Data frame error [D]

**4.14.3 Status at processing completion**

Status at Processing Completion		Status Code	Description
Normal completion [A]	Normal acknowledgment (ACK)	06H	The command was executed normally and checksum data was acquired normally.
Abnormal termination [B]	Parameter error	05H	The specified start/end address is not the start/end address of the block.
	Checksum error	07H	The checksum of the transmitted command frame does not match.
	Negative acknowledgment (NACK)	15H	<ul style="list-style-type: none"> <li>A command other than the Status command was received during processing.</li> <li>Command frame data is abnormal (such as invalid data length (LEN) or no ETX).</li> </ul>
Time-out error [C]		–	The status frame or data frame was not received within the specified time.
Data frame error [D]		–	The checksum of the data frame received as version data does not match.

4.14.4 Flowchart

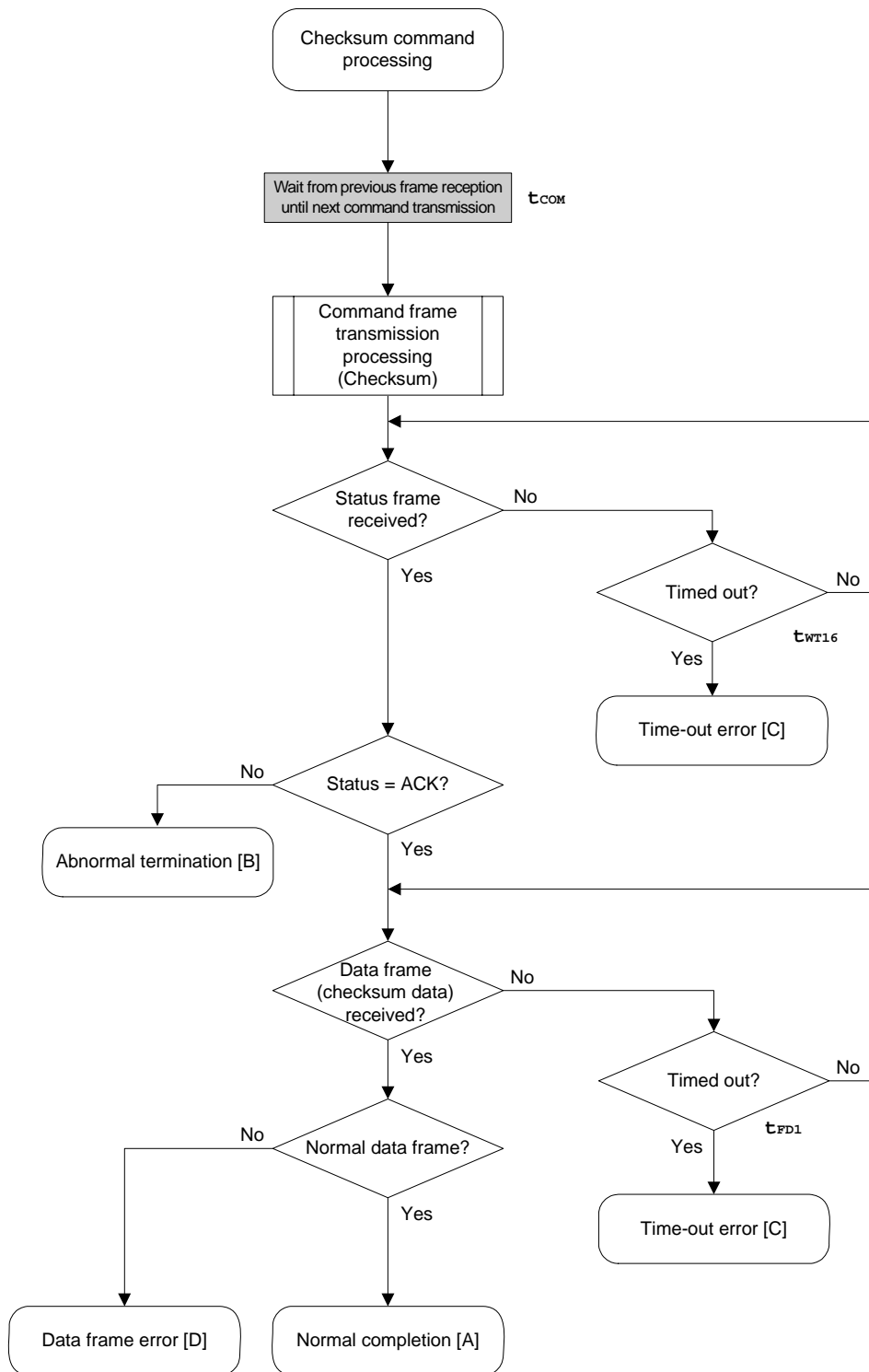

#### 4.14.5 Sample program

The following shows a sample program for Checksum command processing.

```

/*****
/*
/* Get checksum command
/*
/*****
/* [i] u16 *sum      ... pointer to checksum save area
/* [i] u32 top      ... start address
/* [i] u32 bottom   ... end address
/* [r] u16          ... error code
/*****
u16      fl_ua_getsum(u16 *sum, u32 top, u32 bottom)
{
    u16    rc;
    u32    fdl_max;

    /*****
    /*      set params
    /*****
    // set params
    set_range_prm(fl_cmd_prm, top, bottom);          // set SAH/SAM/SAL, EAH/EAM/EAL
    fdl_max = get_fdl_max(get_block_num(top, bottom)); // get tFD1(MAX)

    /*****
    /*      send command
    /*****

    fl_wait(tCOM);          // wait before sending command

    put_cmd_ua(FL_COM_GET_CHECK_SUM, 7, fl_cmd_prm); // send GET VERSION command

    rc = get_sfrm_ua(fl_ua_sfrm, tWT16_MAX);          // get status frame
    switch(rc) {
        case    FLC_NO_ERR:          break; // continue
        // case    FLC_DFTO_ERR:    return rc;    break; // case [C]
        default:          return rc;    break; // case [B]
    }

    /*****
    /*      get data frame (Checksum data)
    /*****
    rc = get_dfrm_ua(fl_rxddata_frm, fdl_max);          // get status frame
    if (rc){
        return rc;          // case [D]
    }

    *sum = (fl_rxddata_frm[OFS_STA_PLD] << 8) + fl_rxddata_frm[OFS_STA_PLD+1]; // set
SUM data
    return rc;          // case [A]
}

```



### 4.15 Security Set Command

#### 4.15.1 Processing sequence chart

Security Set command processing sequence

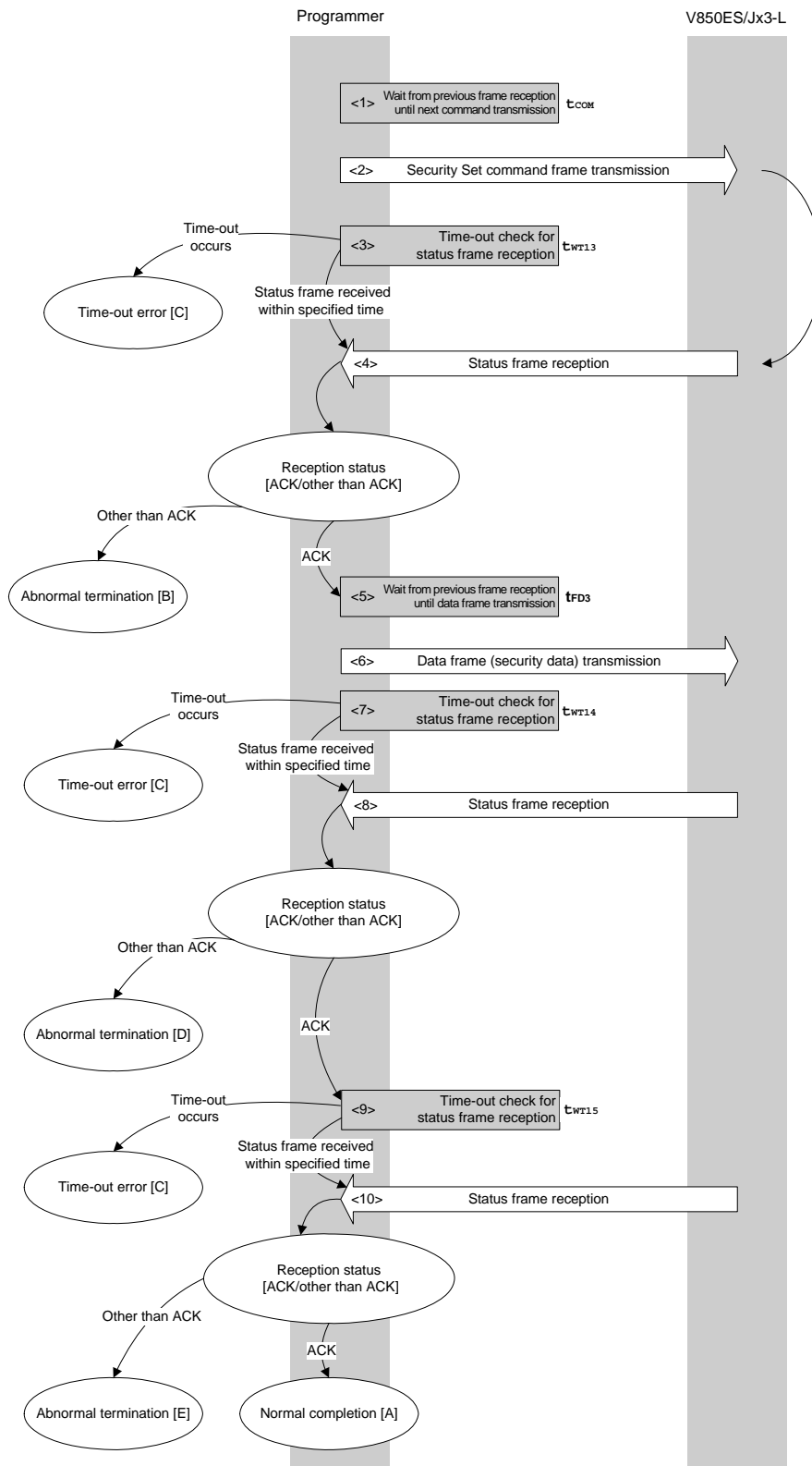

#### 4.15.2 Description of processing sequence

- <1> Waits from the previous frame reception until the next command transmission (wait time  $t_{COM}$ ).
- <2> The Security Set command is transmitted by command frame transmission processing.
- <3> A time-out check is performed from command transmission until status frame reception.  
If a time-out occurs, a time-out error [C] is returned (time-out time  $t_{WT13}$ ).
- <4> The status code is checked.

When ST1 = ACK: Proceeds to <5>.

When ST1  $\neq$  ACK: Abnormal termination [B]

- <5> Waits from the previous frame reception until the next data frame transmission (wait time  $t_{FD3}$ ).
- <6> The data frame (security setting data) is transmitted by data frame transmission processing.
- <7> A time-out check is performed until status frame reception.  
If a time-out occurs, a time-out error [C] is returned (time-out time  $t_{WT14}$ ).
- <8> The status code is checked.

When ST1 = ACK: Proceeds to <9>.

When ST1  $\neq$  ACK: Abnormal termination [D]

- <9> A time-out check is performed until status frame reception.  
If a time-out occurs, a time-out error [C] is returned (time-out time  $t_{WT15}$ ).
- <10> The status code is checked.

When ST1 = ACK: Normal completion [A]

When ST1  $\neq$  ACK: Abnormal termination [E]

## 4.15.3 Status at processing completion

Status at Processing Completion		Status Code	Description
Normal completion [A]	Normal acknowledgment (ACK)	06H	The command was executed normally and security setting data was performed normally.
Abnormal termination [B]	Checksum error	07H	The checksum of the transmitted command frame does not match.
	Negative acknowledgment (NACK)	15H	<ul style="list-style-type: none"> <li>A command other than the Status command was received during processing.</li> <li>Command frame data is abnormal (such as invalid data length (LEN) or no ETX).</li> </ul>
Time-out error [C]		–	The status frame was not received within the specified time.
Abnormal termination [D]	Negative acknowledgment (NACK)	15H	The security data frame is abnormal.
	Checksum error	07H	The checksum of the transmitted security data frame does not match.
	Protect error	10H	When security data is in the following statuses <ul style="list-style-type: none"> <li>The security is changed from disabled to enabled.</li> <li>The value of the last block number in the boot block cluster is changed when boot block cluster rewriting is disabled.</li> </ul>
	Parameter error	05H	When security data is in the following statuses <ul style="list-style-type: none"> <li>The last block number of the boot block cluster is larger than the last block number of the device.</li> <li>The value of the reset vector handler address is not 0000000H.</li> </ul>
Abnormal termination [E]	MRG10 error	1AH	A write error has occurred.
	MRG11 error	1BH	
	WRITE error	1CH	

4.15.4 Flowchart

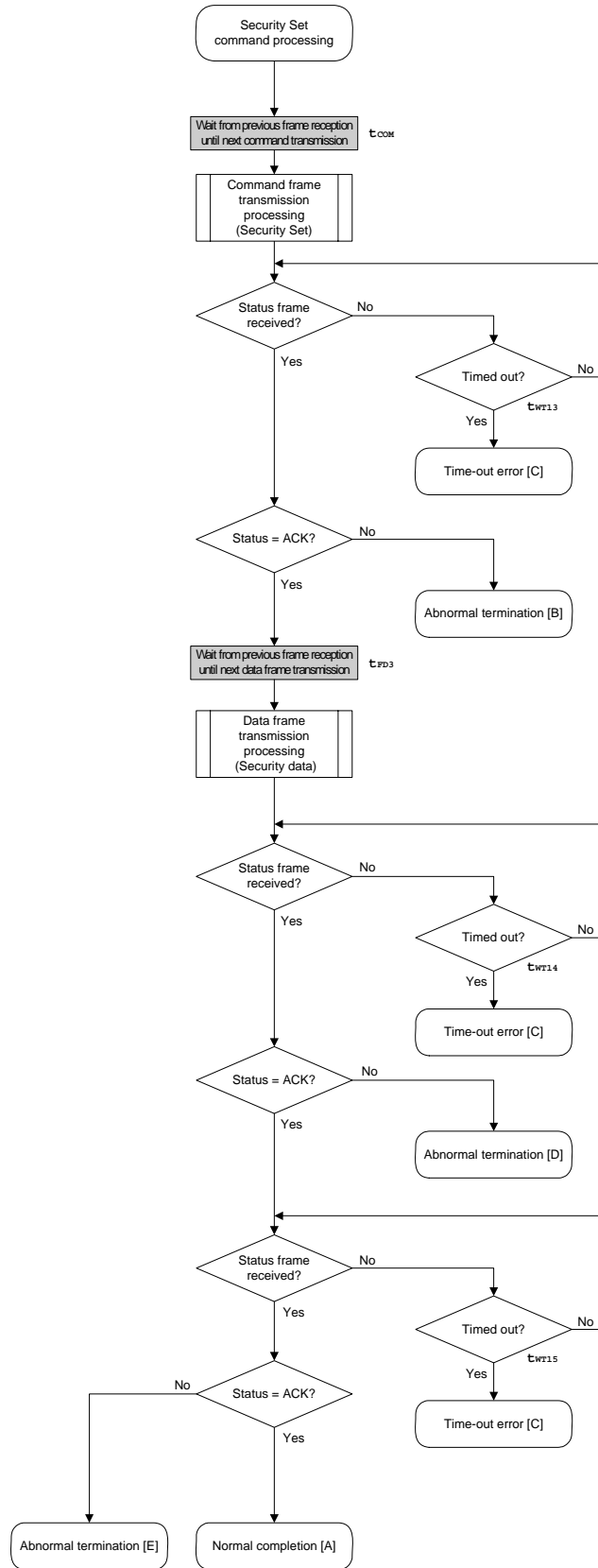

#### 4.15.5 Sample program

The following shows a sample program for Security Set command processing.

```

/*****/
/*                                     */
/* Set security flag command          */
/*                                     */
/*****/
/* [i] u8 scf... Security flag data   */
/* [r] ul6 ... error code             */
/*****/
ul6      fl_ua_setscf(u8 scf, u8 bot, u32 vect)
{
    ul6      rc;

/*****/
/*      set params                    */
/*****/
fl_cmd_prm[0] = 0x00;                // "BLK" (must be 0x00)
fl_cmd_prm[1] = 0x00;                // "PAG" (must be 0x00)

fl_txdata_frm[0] = scf | 0b11100000; // "FLG" (bit 7,6,5 must be '1')
fl_txdata_frm[1] = bot;              // "BOT"

fl_txdata_frm[2] = (u8)(vect >> 16); // "ADH"
fl_txdata_frm[3] = (u8)(vect >> 8);  // "ADM"
fl_txdata_frm[4] = (u8) vect;        // "ADL"

/*****/
/*      send command                  */
/*****/
fl_wait(tCOM);                       // wait before sending command

put_cmd_ua(FL_COM_SET_SECURITY, 3, fl_cmd_prm);

rc = get_sfrm_ua(fl_ua_sfrm, tWT13_MAX); // get status frame
switch(rc) {
    case FLC_NO_ERR:                  break; // continue
//   case FLC_DFTO_ERR: return rc;    break; // case [C]
    default:                          return rc; break; // case [B]
}

/*****/
/*      send data frame (security setting data) */
/*****/

fl_wait(tFD3);
put_dfrm_ua(5, fl_txdata_frm, true); // send security setting data

rc = get_sfrm_ua(fl_ua_sfrm, tWT14_MAX); // get status frame
switch(rc) {
    case FLC_NO_ERR:                  break; // continue
//   case FLC_DFTO_ERR: return rc;    break; // case [C]
    default:                          return rc; break; // case [B]
}

```

```

/*****
/*      Check internally verify      */
/*****
rc = get_sfrm_ua(fl_ua_sfrm, tWT15_MAX);      // get status frame
//  switch(rc) {
//
//      case   FLC_NO_ERR:      return rc;      break; // case [A]
//      case   FLC_DFTO_ERR:   return rc;      break; // case [C]
//      default:                return rc;      break; // case [B]
//  }

return rc;
}

```

### 4.16 Read Command

#### 4.16.1 Processing sequence chart

Read command processing sequence

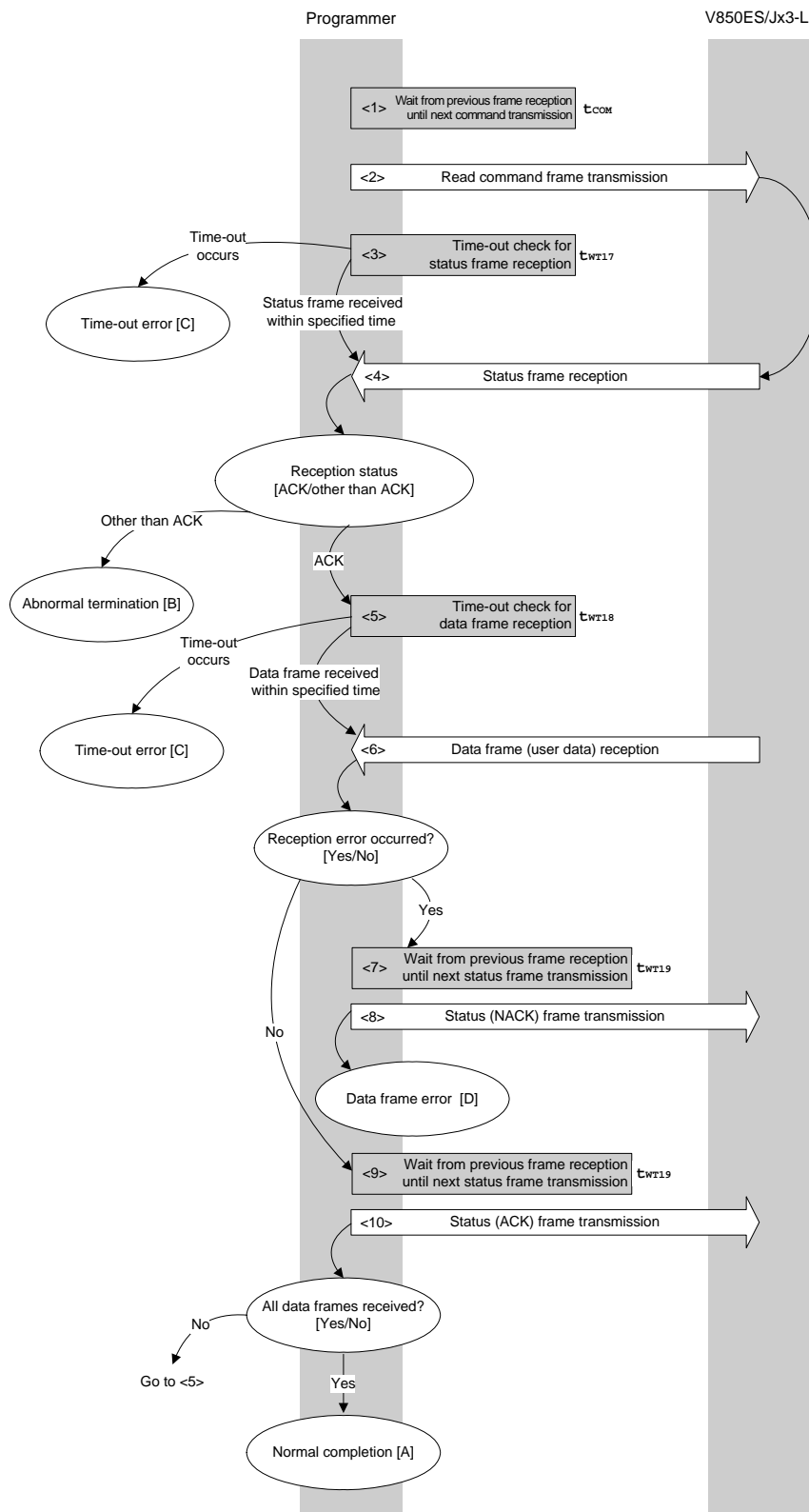

**4.16.2 Description of processing sequence**

- <1> Waits from the previous frame reception until the next command transmission (wait time  $t_{COM}$ ).
- <2> The Read command is transmitted by command frame transmission processing.
- <3> A time-out check is performed from command transmission until status frame reception.  
If a time-out occurs, a time-out error [C] is returned (time-out time  $t_{WT17}$ ).
- <4> The status code is checked.

When ST1 = ACK: Proceeds to <5>.

When ST1  $\neq$  ACK: Abnormal termination [B]

- <5> A time-out check is performed until reception of the data frame reception result (user data).  
If a time-out occurs, a time-out error [C] is returned (time-out time  $t_{WT18}$ ).
- <6> The received data frame (user data) is checked.

If data frame is normal: Proceeds to <9>.

If data frame is abnormal: Proceeds to <7>.

- <7> Waits from the previous frame reception until the next status (NACK) frame transmission (wait time  $t_{WT19}$ ).
- <8> The NACK frame is transmitted by data frame transmission processing.  
→ A data frame error [D] is returned.
- <9> Waits from the previous frame reception until the next status (ACK) frame transmission (wait time  $t_{WT19}$ ).
- <10> The ACK frame is transmitted by data frame transmission processing.  
When reception of all data frames is completed, normal completion [A] is returned.  
If there still remain data frames to be received, the processing re-executes the sequence from <5>.

**4.16.3 Status at processing completion**

Status at Processing Completion		Status Code	Description
Normal completion [A]	Normal acknowledgment (ACK)	06H	The command was executed normally and read data was set normally.
Abnormal termination [B]	Parameter error	05H	The specified start/end address is not the start/end address of the block.
	Checksum error	07H	The checksum of the transmitted command frame does not match.
	Protect error	10H	Read is prohibited by the security setting.
	Negative acknowledgment (NACK)	15H	Command frame data is abnormal (such as invalid data length (LEN) or no ETX).
Time-out error [C]		–	The status frame or data frame was not received within the specified time.
Data frame error [D]		–	The checksum of the data frame received as read data does not match.



4.16.4 Flowchart

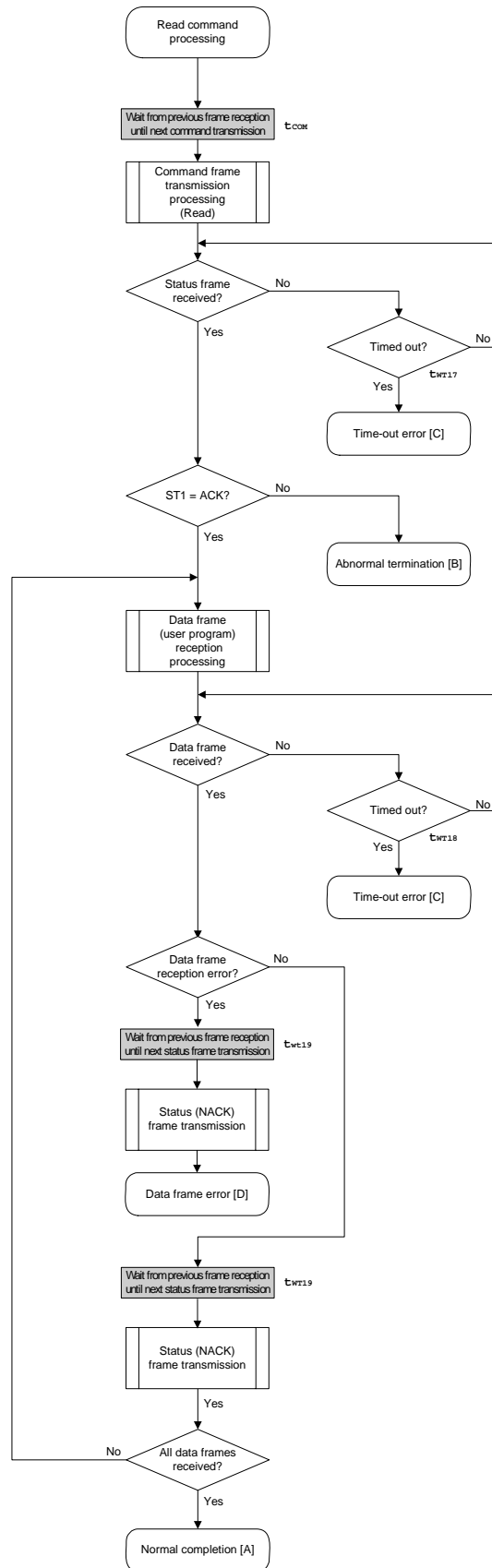

#### 4.16.5 Sample program

The following shows a sample program for Read command processing.

```

/*****
/*
/* Read command
/*
/*****
u16      fl_ua_read(u32 top, u32 bottom)
{
    u16    rc;
    u32    read_head;
    u16    len;
    u8     hooter;

    /*****
    /*      set params
    /*****
    set_range_prm(fl_cmd_prm, top, bottom);      // set SAH/SAM/SAL, EAH/EAM/EAL

    /*****
    /*      send command & check status
    /*****
    fl_wait(tCOM);      // wait before sending command

    put_cmd_ua(FL_COM_READ, 7, fl_cmd_prm);

    rc = get_sfrm_ua(fl_ua_sfrm, tWT17_MAX);      // get status frame
    switch(rc) {
        case    FLC_NO_ERR:      break;
        //      case    FLC_DFTO_ERR:  return rc;  break; // case [C]
        default:      return rc;  break; // case [B]
    }

    /*****
    /*      receive user data
    /*****
    read_head = top;

    while(1){

        rc = get_dfrm_ua(fl_rxddata_frm, tWT18_MAX);      // get ROM data from FLASH

        switch(rc) {
            case    FLC_NO_ERR:      break; // continue
            case    FLC_DFTO_ERR:  return rc;  break; // case [C]
            //      case    FLC_RX_DFSUM_ERR:
            default:      // case [B]

                fl_wait(tWT19);
                put_sfrm_ua(FLST_NACK); // send status(NACK) frame
                return rc;
                break;

        }
    }

```

```
fl_wait(tWT19);
put_sfrm_ua(FLST_ACK);

/*****
/*      save ROM data
*****/
if ((len = fl_rxdata_frm[OFS_LEN]) == 0)      // get length
    len = 256;

memcpy(read_buf+read_head, fl_rxdata_frm+2, len); // save to external RAM

read_head += len;

/*****
/*      end check
*****/
hooter = fl_rxdata_frm[len + 3];
if (hooter == FL_ETB)      // end frame ?
    continue;              // no
break;                      // yes
}

return FLC_NO_ERR;
}
```

**CHAPTER 5 3-WIRE SERIAL I/O COMMUNICATION MODE WITH HANDSHAKE SUPPORTED (CSI + HS)**

**5.1 Command Frame Transmission Processing Flowchart**

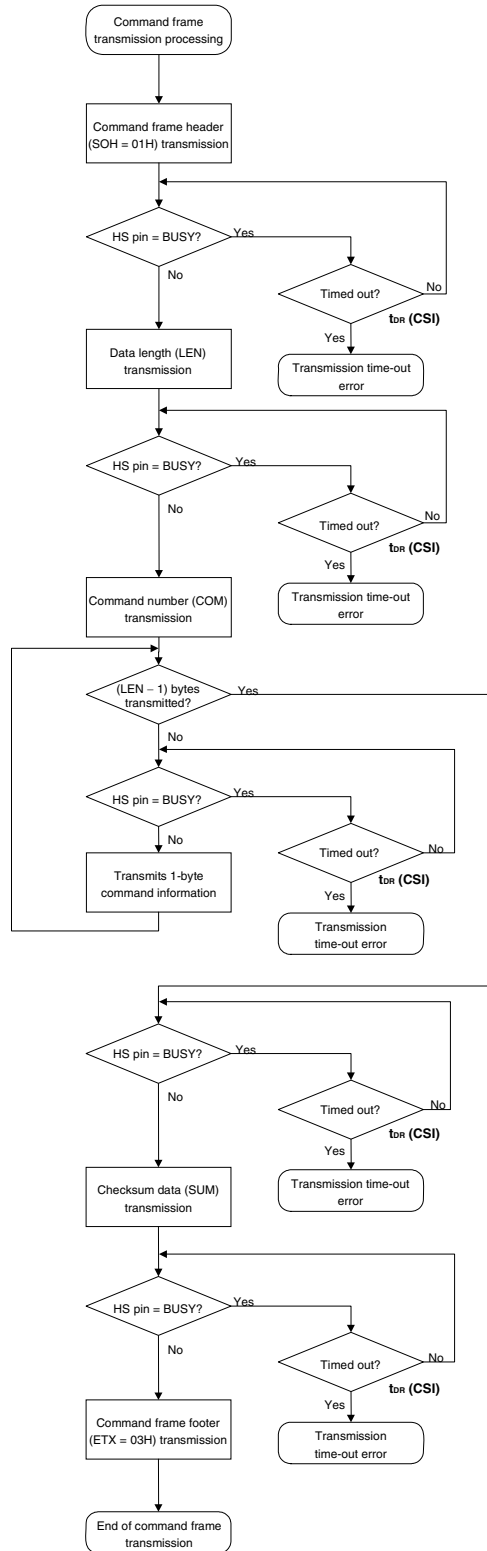

5.2 Data Frame Transmission Processing Flowchart

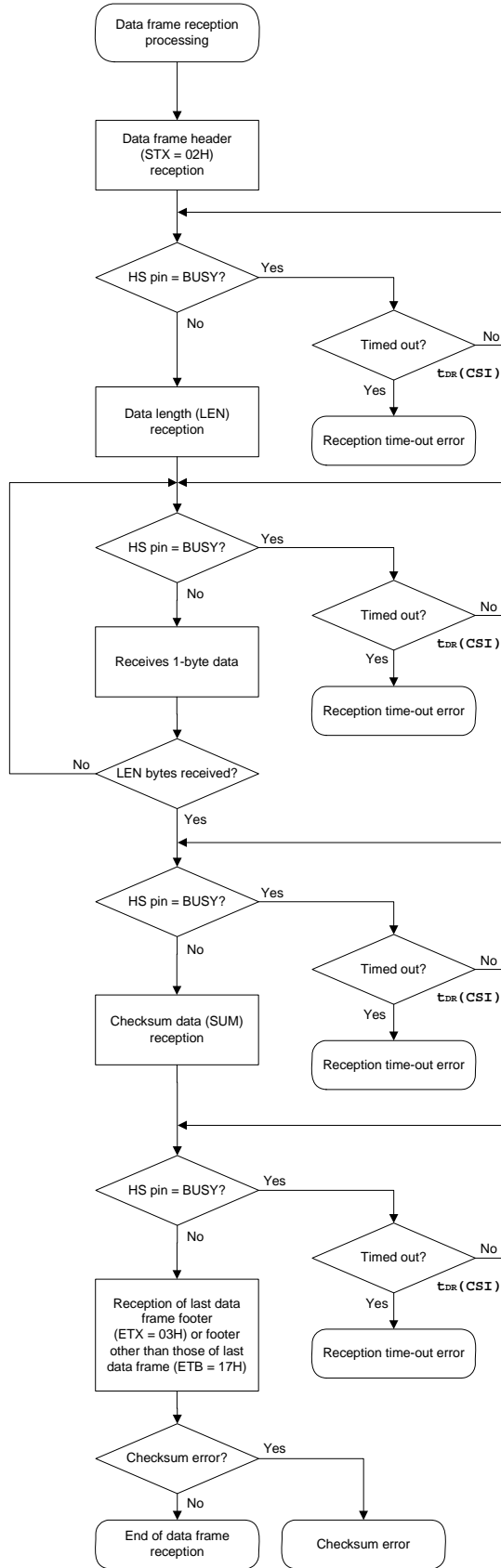

5.3 Data Frame Reception Processing Flowchart

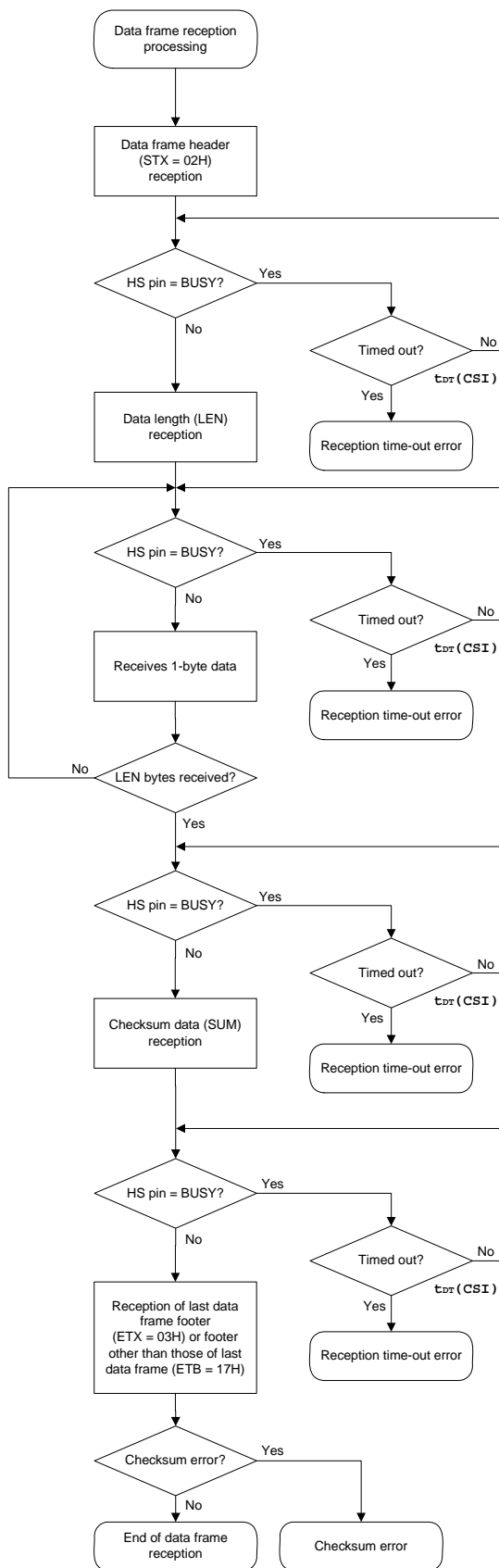

## 5.4 Status Command

### 5.4.1 Processing sequence chart

Status command processing sequence

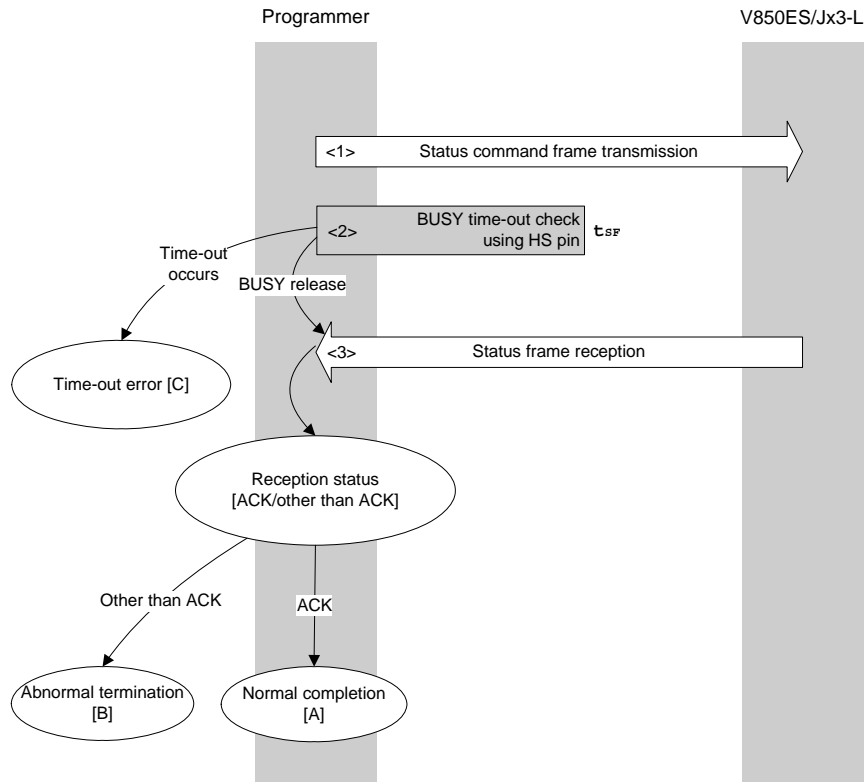

**5.4.2 Description of processing sequence**

- <1> The Status command is transmitted by command frame transmission processing.
- <2> A V850ES/Jx3-L BUSY status is checked using the HS pin.  
If a BUSY time-out occurs, a time-out error [C] is returned (time-out time  $t_{SP}$ ).
- <3> The status code is checked.

When ST1 = ACK: Normal completion [A]

When ST1  $\neq$  ACK: Abnormal termination [B]

**5.4.3 Status at processing completion**

Status at Processing Completion		Status Code	Description
Normal completion [A]	Normal acknowledgment (ACK)	06H	The status frame transmitted from the V850ES/Jx3-L has been received normally.
Abnormal termination [B]	Command error	04H	An unsupported command or abnormal frame has been received.
	Parameter error	05H	Command information (parameter) is invalid.
	Checksum error	07H	The data of the frame transmitted from the programmer is abnormal.
	Write error	1CH	Write error
	MRG10 error	1AH	Erase error
	MRG11 error	1BH	Internal verify error or blank error in writing data
	Verify error	0FH	A verify error has occurred for the data of the frame transmitted from the programmer.
	Protect error	10H	An attempt was made to execute processing prohibited by the Security Set command.
	Negative acknowledgment (NACK)	15H	Negative acknowledgment
Time-out error [C]		–	Processing timed out due to the busy status at the HS pin.



5.4.4 Flowchart

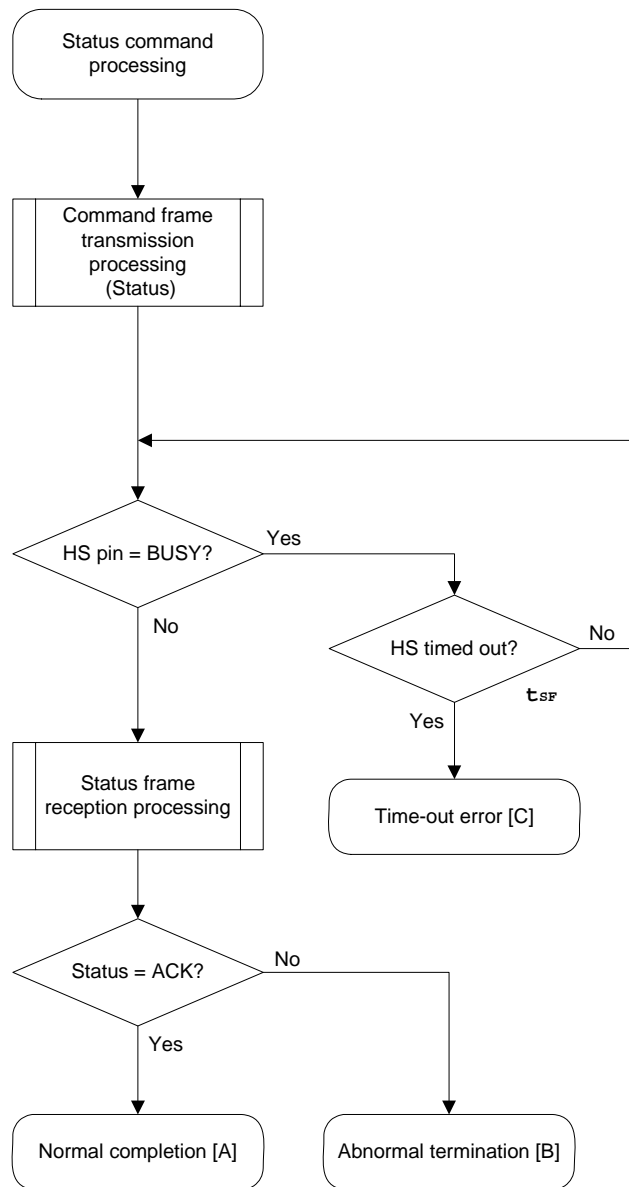

### 5.4.5 Sample program

The following shows a sample program for Status command processing.

```

/*****
/*
/* Get status command (CSI-HS)
/*
/*****
/* [r] ul6      ... decoded status or error code
/*
/* (see fl.h/fl-proto.h &
/*      definition of decode_status() in fl.c)
/*****
static ul6  fl_hs_getstatus(void)
{
    ul6      rc;
    u32      retry = 0;

    rc = put_cmd_hs(FL_COM_GET_STA, 1, fl_cmd_prm);    // send "Status" command
    if (rc)
        return rc;    // case [C]

    if (hs_busy_to(tSF_MAX))    // HS-Busy t.o. ?
        return FLC_HSTO_ERR;    // t.o. detected : case [C]

    if (rc = get_sfrm_hs(fl_rxdata_frm))
        return rc;    // case [C] or [B(checksum error)]

    rc = decode_status(fl_st1);    // decode return code

    return rc;    // case [A] or [B]
}

```

5.5 Reset Command

5.5.1 Processing sequence chart

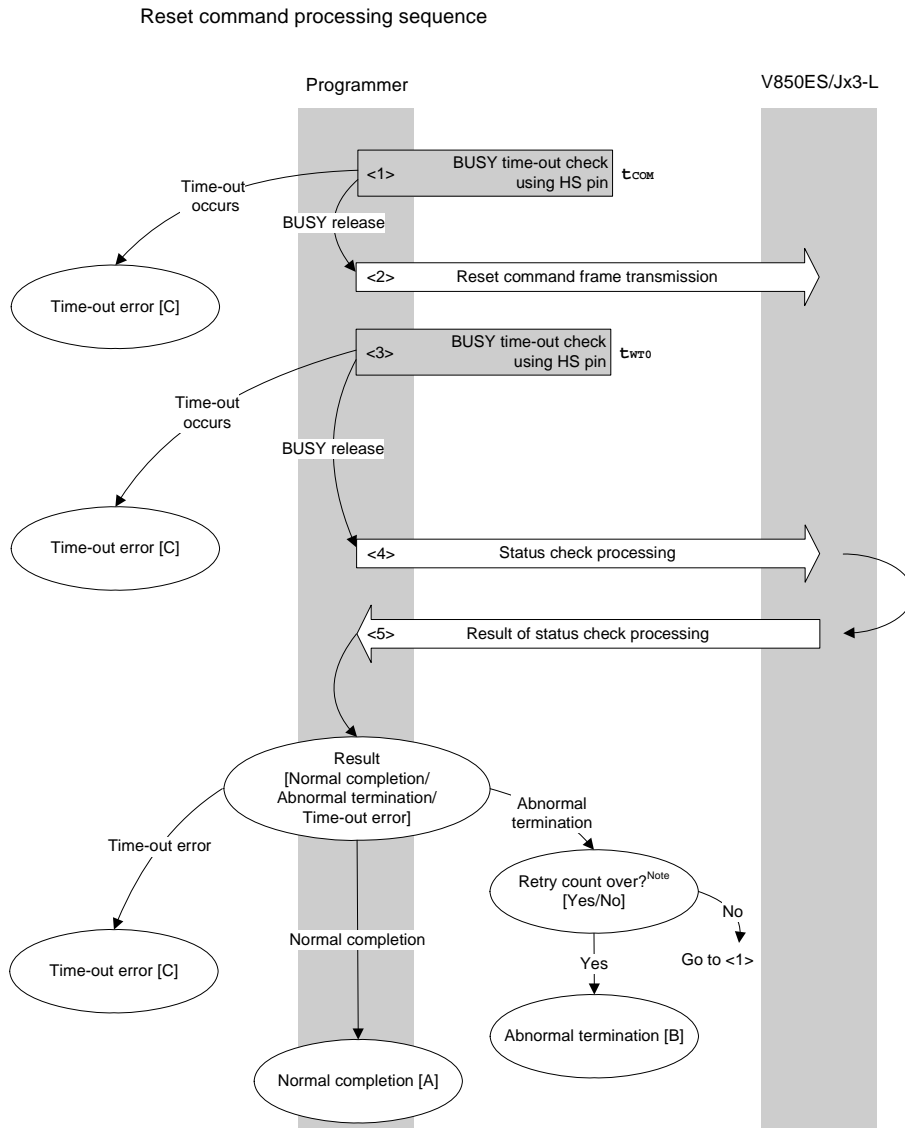

**Note** Do not exceed the retry count for the reset command transmission (up to 16 times).

### 5.5.2 Description of processing sequence

- <1> A V850ES/Jx3-L BUSY status is checked using the HS pin.  
If a BUSY time-out occurs, a time-out error [C] is returned (time-out time  $t_{COM}$ ).
- <2> The Reset command is transmitted by command frame transmission processing.
- <3> A V850ES/Jx3-L BUSY status is checked using the HS pin.  
If a BUSY time-out occurs, a time-out error [C] is returned (time-out time  $t_{WTO}$ ).
- <4> The status frame is acquired by status check processing.
- <5> The following processing is performed according to the result of status check processing.

When the processing ends normally: Normal completion [A]

When the processing ends abnormally: The sequence is re-executed from <1> if the retry count is not over.

If the retry count is over, the processing ends abnormally [B].

When a time-out error occurs: A time-out error [C] is returned.

### 5.5.3 Status at processing completion

Status at Processing Completion		Status Code	Description
Normal completion [A]	Normal acknowledgment (ACK)	06H	The command was executed normally and synchronization between the programmer and the V850ES/Jx3-L has been established.
Abnormal termination [B]	Checksum error	07H	The checksum of the transmitted command frame does not match.
	Negative acknowledgment (NACK)	15H	<ul style="list-style-type: none"> <li>A command other than the Status command was received during processing.</li> <li>Command frame data is abnormal (such as invalid data length (LEN) or no ETX).</li> </ul>
Time-out error [C]		–	Status check processing timed out. Processing timed out due to the busy status at the HS pin.

5.5.4 Flowchart

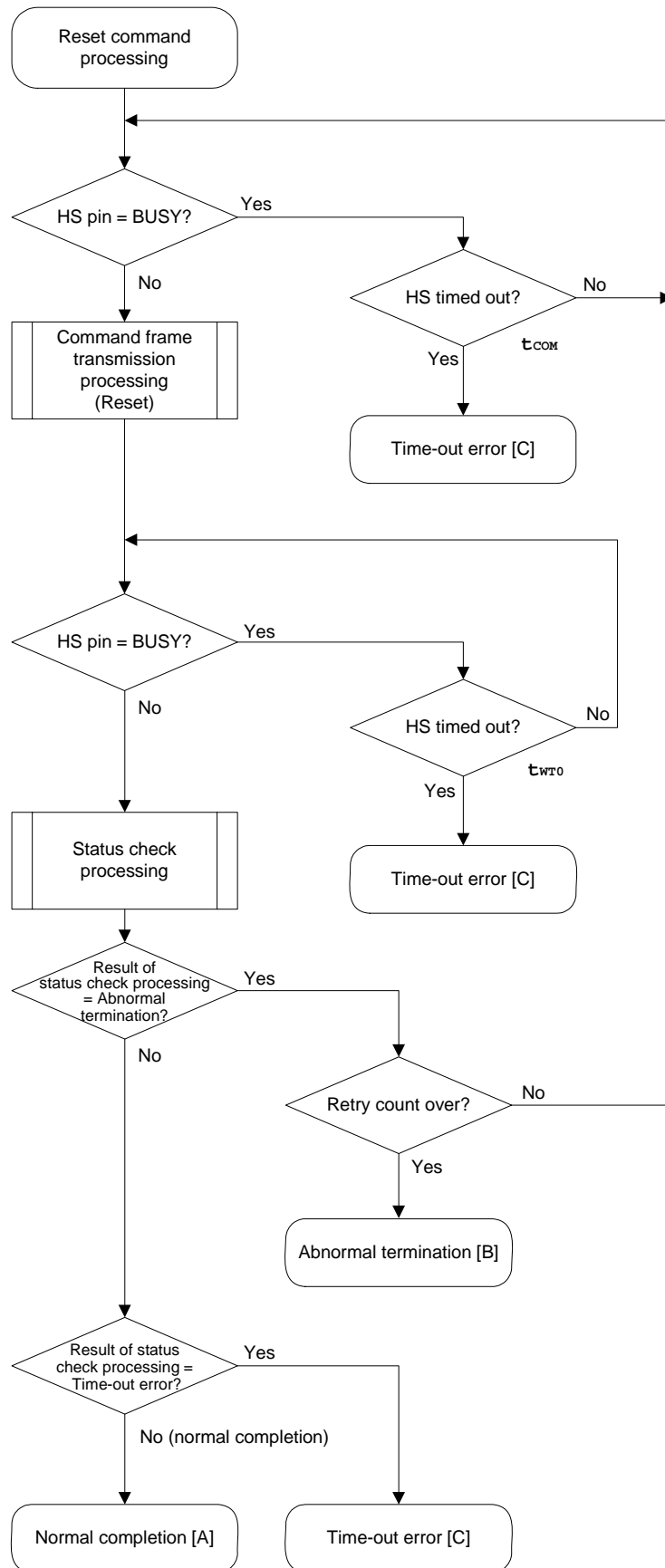

### 5.5.5 Sample program

The following shows a sample program for Reset command processing.

```

/*****
/*
/* Reset command (CSI-HS)
/*
/*****
/* [r] u16          ... error code
/*****
u16          fl_hs_reset(void)
{
    u16      rc;
    u32      retry;

    for (retry = 0; retry < tRS; retry++){

        if (hs_busy_to(tCOM_MAX))
            return FLC_HSTO_ERR;          // t.o. detected :case [C]

        rc = put_cmd_hs(FL_COM_RESET, 1, fl_cmd_prm); // send "Reset" command
        if (rc)
            return rc;                    // case [C]

        if (hs_busy_to(tWT0_MAX))
            return FLC_HSTO_ERR;          // t.o. detected :case [C]

        rc = fl_hs_getstatus(); // get status frame
        if (rc == FLC_ACK)          // ST1 = ACK ?
            break;                  // case [A]
        //continue;                  // case [B] (if exit from loop)
    }

    // switch(rc) {
    //     case   FLC_NO_ERR:    return rc;    break; // case [A]
    //     case   FLC_HSTO_ERR: return rc;    break; // case [C]
    //     default:            return rc;    break; // case [B]
    // }
    return rc;
}

```

## 5.6 Oscillating Frequency Set Command

### 5.6.1 Processing sequence chart

Oscillating Frequency Set command processing sequence

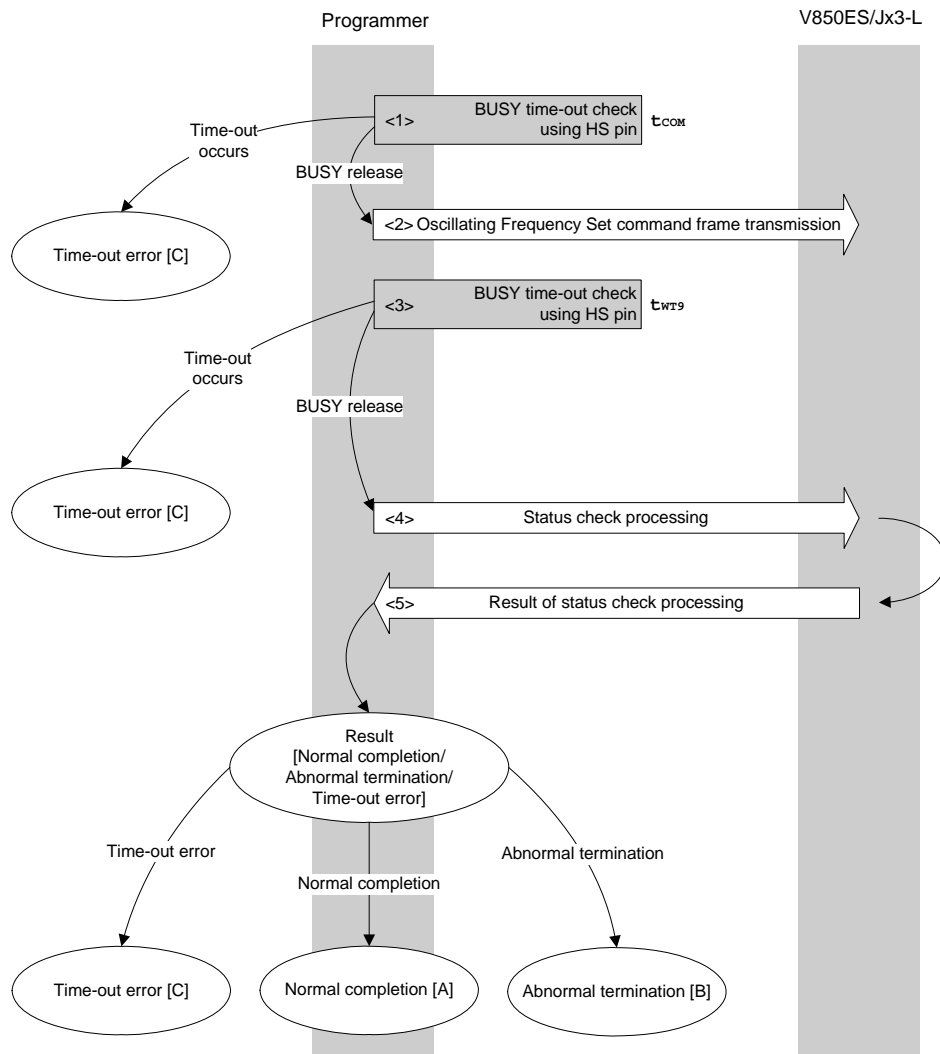

### 5.6.2 Description of processing sequence

- <1> A V850ES/Jx3-L BUSY status is checked using the HS pin.  
If a BUSY time-out occurs, a time-out error [C] is returned (time-out time  $t_{COM}$ ).
- <2> The Oscillating Frequency Set command is transmitted by command frame transmission processing.
- <3> A V850ES/Jx3-L BUSY status is checked using the HS pin.  
If a BUSY time-out occurs, a time-out error [C] is returned (time-out time  $t_{WT9}$ ).
- <4> The status frame is acquired by status check processing.
- <5> The following processing is performed according to the result of status check processing.

When the processing ends normally: Normal completion [A]  
 When the processing ends abnormally: Abnormal termination [B]  
 When a time-out error occurs: A time-out error [C] is returned.

### 5.6.3 Status at processing completion

Status at Processing Completion		Status Code	Description
Normal completion [A]	Normal acknowledgment (ACK)	06H	The command was executed normally and the operating frequency was correctly set to the V850ES/Jx3-L.
Abnormal termination [B]	Parameter error	05H	The oscillation frequency value is out of range.
	Checksum error	07H	The checksum of the transmitted command frame does not match.
	Negative acknowledgment (NACK)	15H	<ul style="list-style-type: none"> <li>A command other than the Status command was received during processing.</li> <li>Command frame data is abnormal (such as invalid data length (LEN) or no ETX).</li> </ul>
Time-out error [C]		–	Processing timed out due to the busy status at the HS pin.



5.6.4 Flowchart

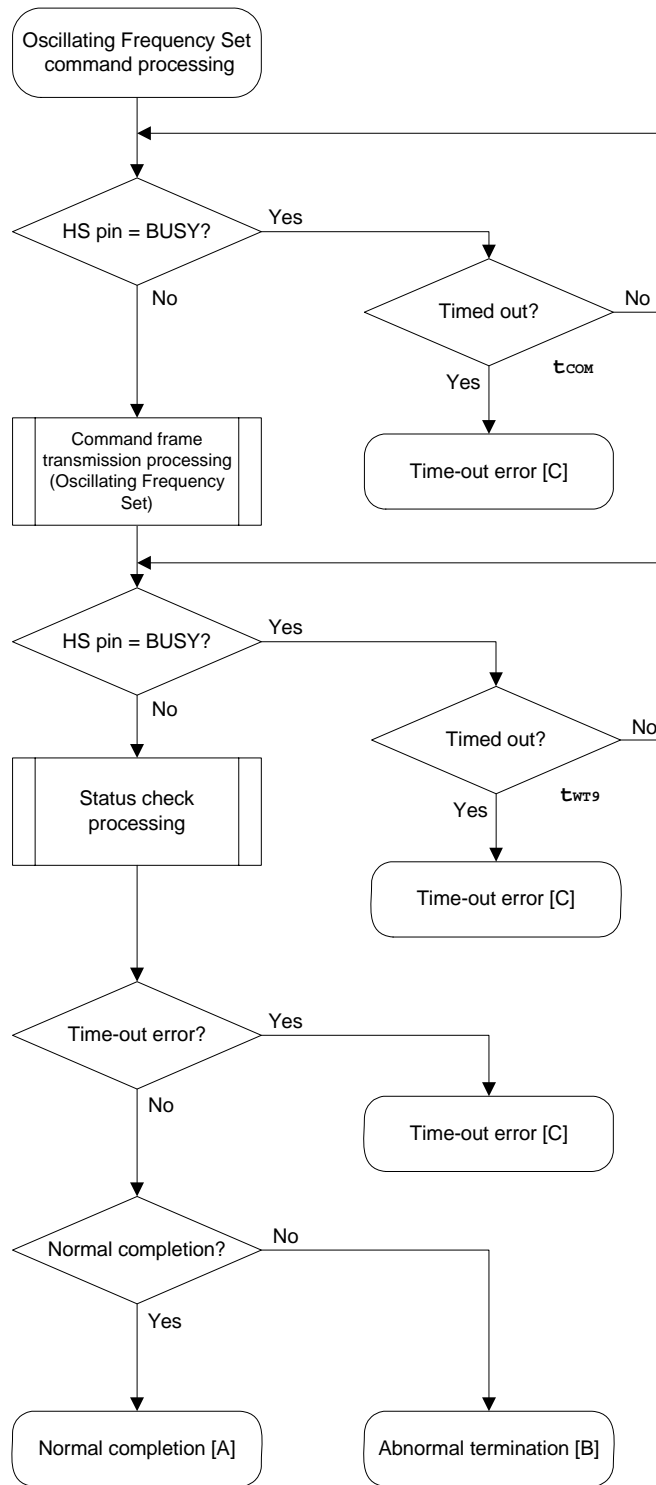

### 5.6.5 Sample program

The following shows a sample program for Oscillating Frequency Set command processing.

```

/*****
/*
/* Set Flash device clock value command (CSI-HS)
/*
/*
/*****
/* [i] u8 clk[4] ... frequency data(D1-D4)
/* [r] u16 ... error code
/*****
/*****
u16 fl_hs_setclk(u8 clk[])
{
    u16 rc;

    fl_cmd_prm[0] = clk[0]; // "D01"
    fl_cmd_prm[1] = clk[1]; // "D02"
    fl_cmd_prm[2] = clk[2]; // "D03"
    fl_cmd_prm[3] = clk[3]; // "D04"

    if (hs_busy_to(tCOM_MAX))
        return FLC_HSTO_ERR; // t.o. detected :case [C]

    if (rc = put_cmd_hs(FL_COM_SET_OSC_FREQ, 5, fl_cmd_prm))
        // send "Oscillating Frequency Set" command
        return rc; // case [C]

    if (hs_busy_to(tWT9_MAX))
        return FLC_HSTO_ERR; // t.o. detected :case [C]

    rc = fl_hs_getstatus(); // get status frame
    // switch(rc) {
    //     case FLC_NO_ERR: return rc; break; // case [A]
    //     case FLC_HSTO_ERR: return rc; break; // case [C]
    //     default: return rc; break; // case [B]
    // }
    return rc;
}

```

## 5.7 Chip Erase Command

### 5.7.1 Processing sequence chart

Chip Erase command processing sequence

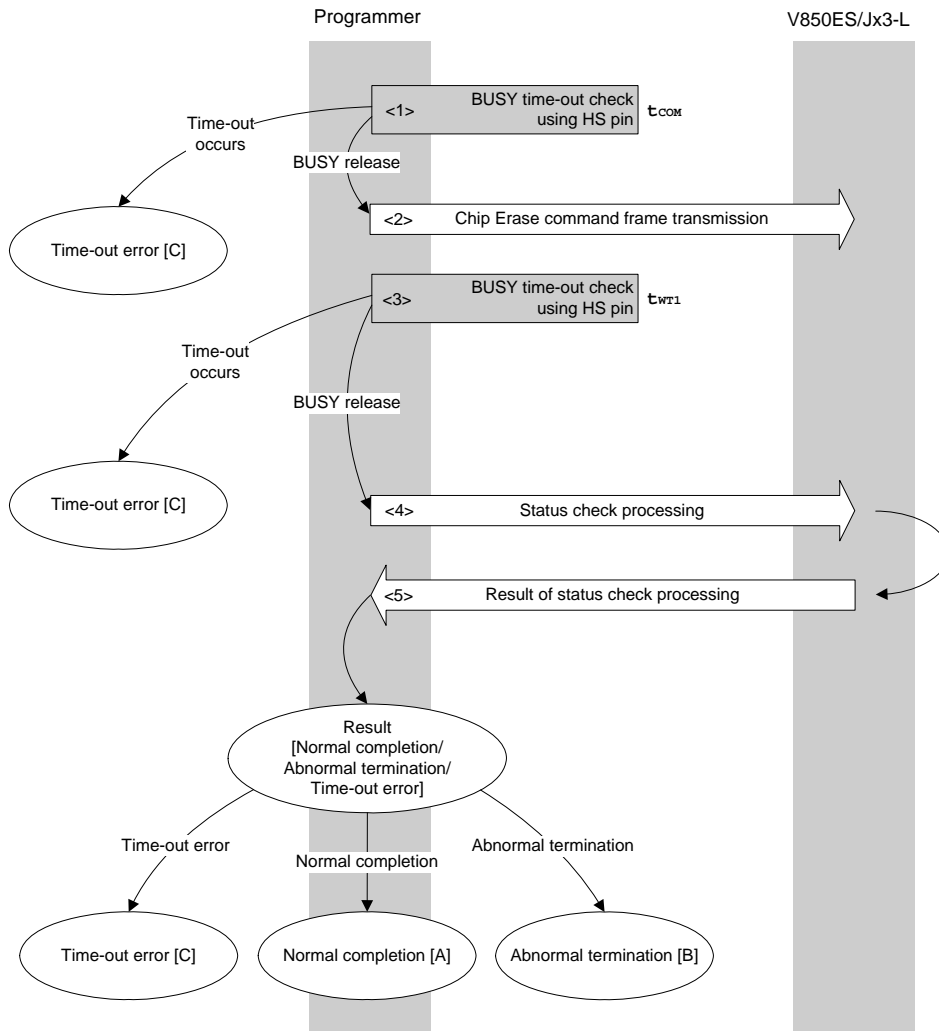

### 5.7.2 Description of processing sequence

- <1> A V850ES/Jx3-L BUSY status is checked using the HS pin.  
If a BUSY time-out occurs, a time-out error [C] is returned (time-out time  $t_{COM}$ ).
- <2> The Chip Erase command is transmitted by command frame transmission processing.
- <3> A V850ES/Jx3-L BUSY status is checked using the HS pin.  
If a BUSY time-out occurs, a time-out error [C] is returned (time-out time  $t_{WT1}$ ).
- <4> The status frame is acquired by status check processing.
- <5> The following processing is performed according to the result of status check processing.

When the processing ends normally: Normal completion [A]  
 When the processing ends abnormally: Abnormal termination [B]  
 When a time-out error occurs: A time-out error [C] is returned.

### 5.7.3 Status at processing completion

Status at Processing Completion		Status Code	Description
Normal completion [A]	Normal acknowledgment (ACK)	06H	The command was executed normally and chip erase was performed normally.
Abnormal termination [B]	Checksum error	07H	The checksum of the transmitted command frame does not match.
	Protect error	10H	Boot block rewrite and chip erase are prohibited by the security setting.
	Negative acknowledgment (NACK)	15H	<ul style="list-style-type: none"> <li>A command other than the Status command was received during processing.</li> <li>Command frame data is abnormal (such as invalid data length (LEN) or no ETX).</li> </ul>
	WRITE error	1CH	An erase error has occurred.
	MRG10 error	1AH	
MRG11 error	1BH		
Time-out error [C]		–	Processing timed out due to the busy status at the HS pin.

5.7.4 Flowchart

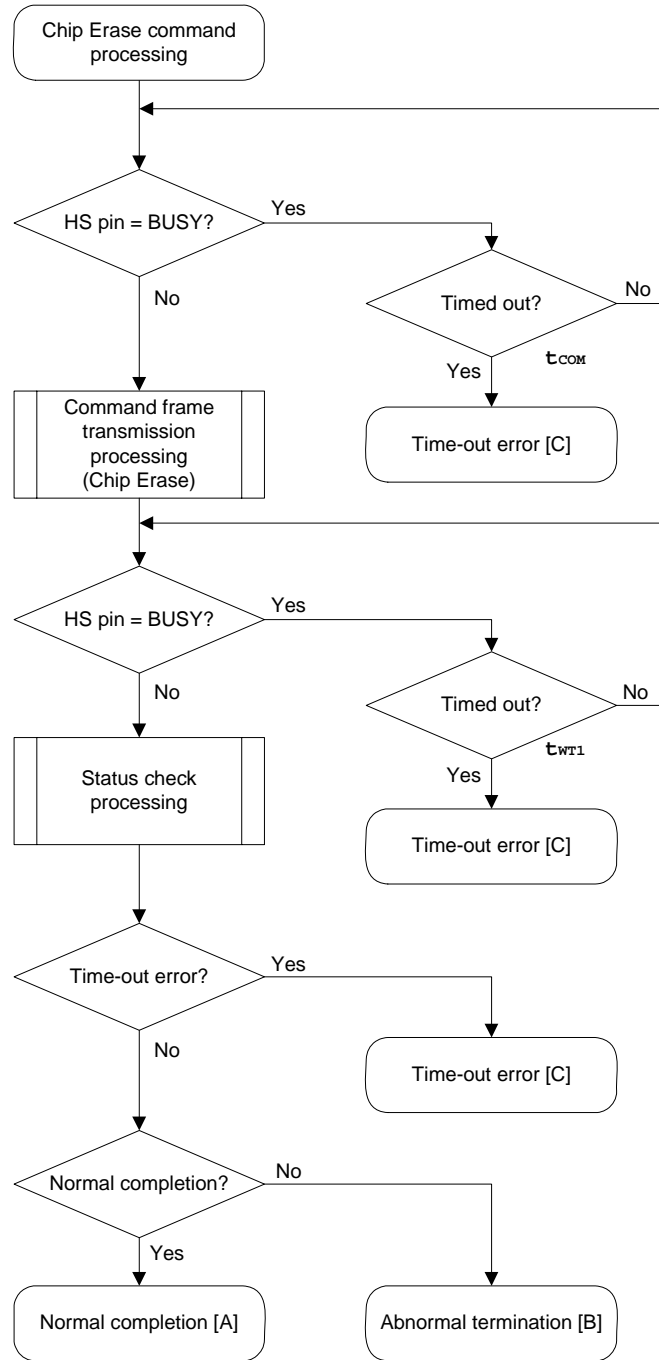

### 5.7.5 Sample program

The following shows a sample program for Chip Erase command processing.

```

/*****
/*
/* Erase all(chip) command (CSI-HS)
/*
/*****
/* [r] u16      ... error code
/*****
u16      fl_hs_erase_all(void)
{
    u16      rc;

    if (hs_busy_to(tCOM_MAX))
        return FLC_HSTO_ERR;          // t.o. detected

    if (rc = put_cmd_hs(FL_COM_ERASE_CHIP, 1, fl_cmd_prm))
        return rc;                    // send "Chip Erase" command
        // case [C]

    if (hs_busy_to(tWT1_MAX))
        return FLC_HSTO_ERR;          // case [C]

    rc = fl_hs_getstatus();            // get status frame
    // switch(rc) {
    //     case FLC_NO_ERR:    return rc;    break; // case [A]
    //     case FLC_HSTO_ERR: return rc;    break; // case [C]
    //     default:           return rc;    break; // case [B]
    // }
    return rc;
}

```

5.8 Block Erase Command

5.8.1 Processing sequence chart

Block Erase command processing sequence

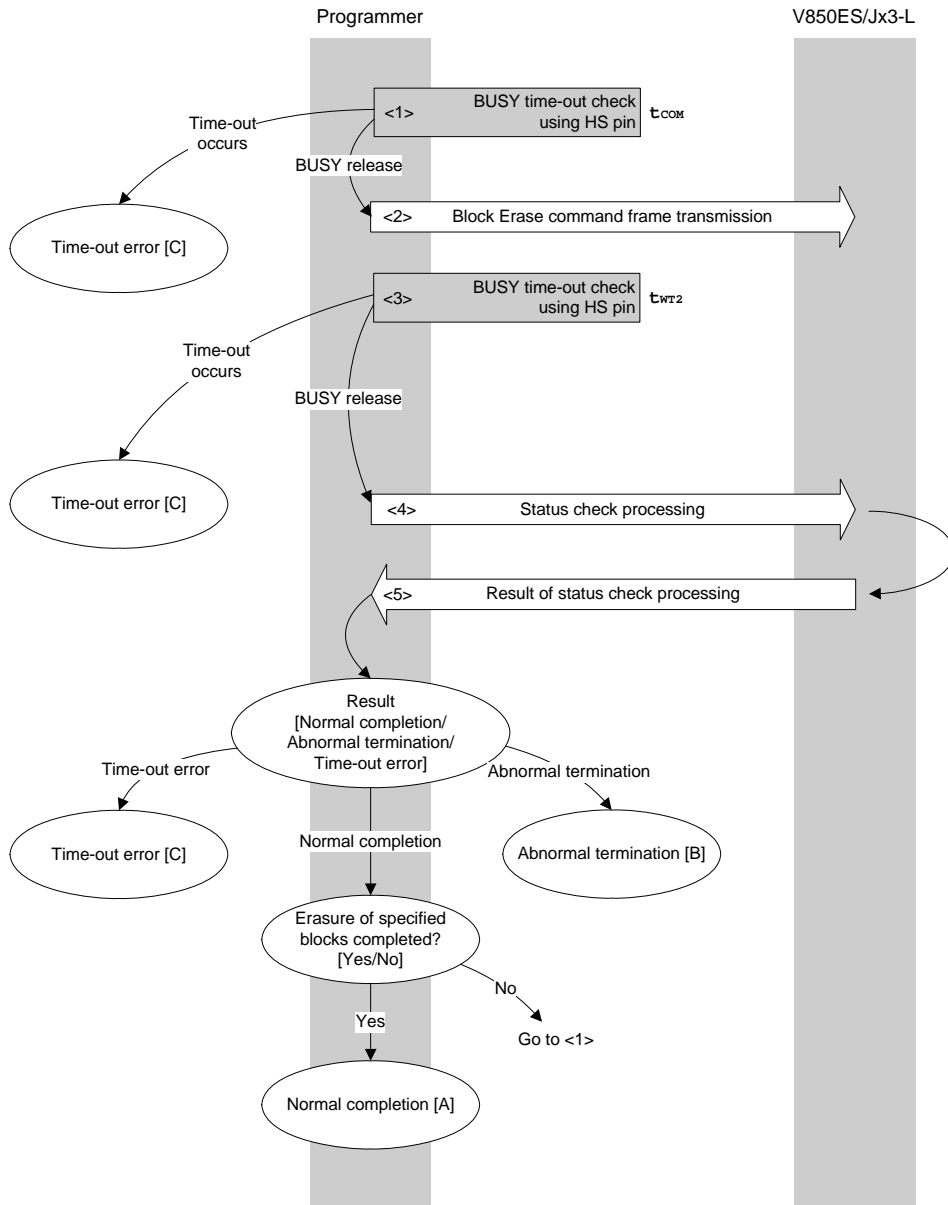

### 5.8.2 Description of processing sequence

- <1> A V850ES/Jx3-L BUSY status is checked using the HS pin.  
If a BUSY time-out occurs, a time-out error [C] is returned (time-out time  $t_{COM}$ ).
- <2> The Block Erase command is transmitted by command frame transmission processing.
- <3> A V850ES/Jx3-L BUSY status is checked using the HS pin.  
If a BUSY time-out occurs, a time-out error [C] is returned (time-out time  $t_{WT2}$ ).
- <4> The status frame is acquired by status check processing.
- <5> The following processing is performed according to the result of status check processing.

When the processing ends normally: When the block erase for all of the specified blocks is not yet completed, processing changes the block number and re-executes the sequence from <1>.

When the block erase for all of the specified blocks is completed, the processing ends normally [A].

When the processing ends abnormally: Abnormal termination [B]

When a time-out error occurs: A time-out error [C] is returned.

### 5.8.3 Status at processing completion

Status at Processing Completion		Status Code	Description
Normal completion [A]	Normal acknowledgment (ACK)	06H	The command was executed normally and block erase was performed normally.
Abnormal termination [B]	Parameter error	05H	The specified start/end address is not the start/end address of the block.
	Checksum error	07H	The checksum of the transmitted command frame does not match.
	Protect error	10H	Any one of write, block erase, or chip erase is prohibited by the security setting. Or, boot block rewrite is prohibited by the security setting because specified range includes the boot area.
	Negative acknowledgment (NACK)	15H	<ul style="list-style-type: none"> <li>A command other than the Status command was received during processing.</li> <li>Command frame data is abnormal (such as invalid data length (LEN) or no ETX).</li> </ul>
	MRG10 error	1AH	An erase error has occurred.
Time-out error [C]		–	Processing timed out due to the busy status at the HS pin.



5.8.4 Flowchart

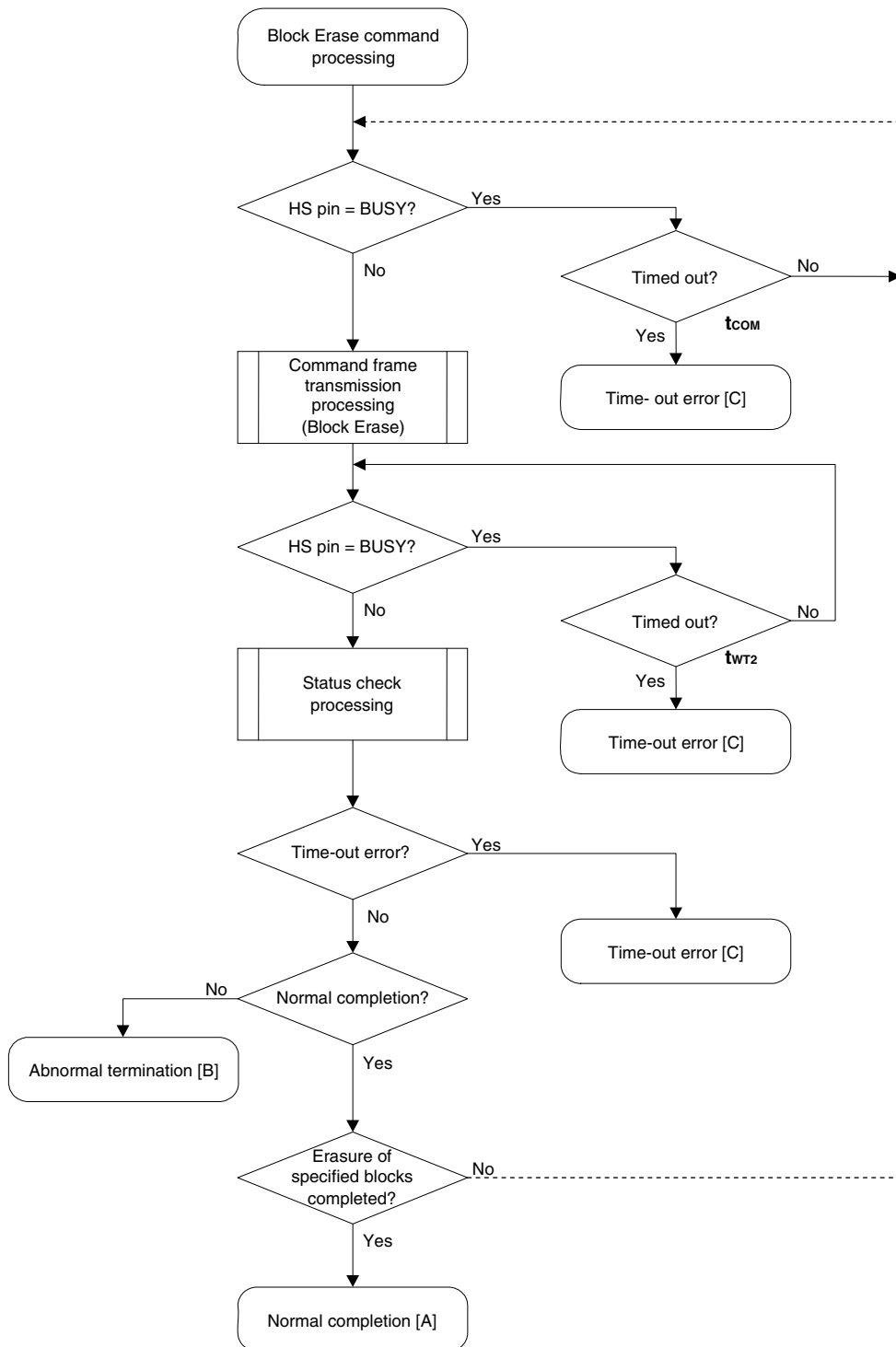

### 5.8.5 Sample program

The following shows a sample program for Block Erase command processing for one block.

```

/*****/
/*
/* Erase block command (CSI-HS)
/*
/*****/
/* [i] u16 sblk      ... start block number
/* [i] u16 eblk      ... end block number
/* [r] u16           ... error code
/*****/
u16      fl_hs_erase_blk(u16 sblk, u16 eblk)
{
    u16    rc;
    u32    wt2_max;

    u32    top, bottom;
    top = get_top_addr(sblk);           // get start address of start block
    bottom = get_bottom_addr(eblk);    // get end address of end block

    set_range_prm(fl_cmd_prm, top, bottom); // set SAH/SAM/SAL, EAH/EAM/EAL
    wt2_max = make_wt2_max(sblk, eblk);    // get tWT2(Max)

    if (hs_busy_to(tCOM_MAX))
        return FLC_HSTO_ERR;           // t.o. detected :case [C]

    if (rc = put_cmd_hs(FL_COM_ERASE_BLOCK, 7, fl_cmd_prm))
        // send "Block Erase" command
        return rc;                     // case [C]

    if (hs_busy_to(wt2_max))
        return FLC_HSTO_ERR;           // t.o. detected :case [C]

    rc = fl_hs_getstatus();             // get status frame
    // switch(rc) {
    //     case    FLC_NO_ERR:    return rc;    break; // case [A]
    //     case    FLC_HSTO_ERR: return rc;    break; // case [C]
    //     default:              return rc;    break; // case [B]
    // }
    return rc;
}

```

### 5.9 Programming Command

#### 5.9.1 Processing sequence chart

Programming command processing sequence

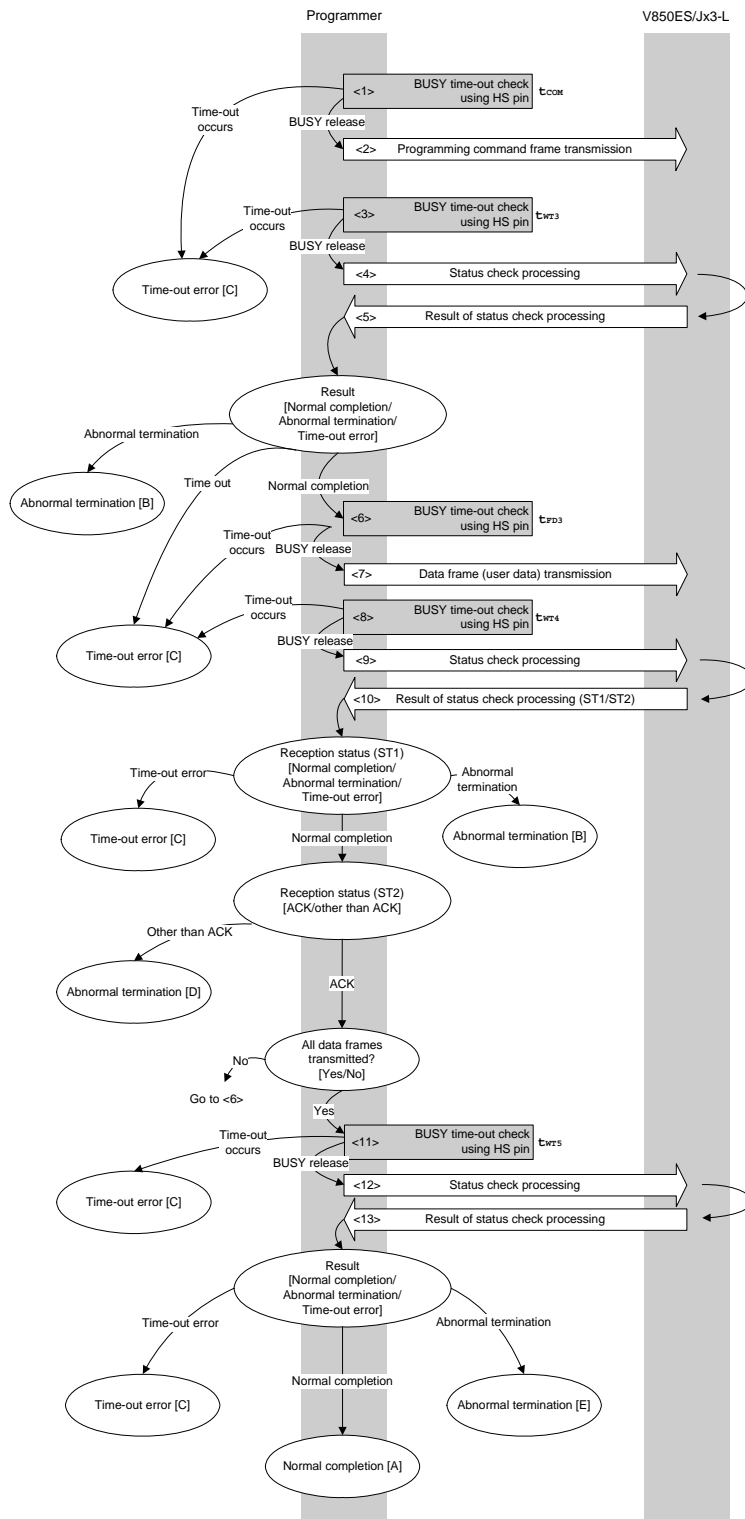

### 5.9.2 Description of processing sequence

- <1> A V850ES/Jx3-L BUSY status is checked using the HS pin.  
If a BUSY time-out occurs, a time-out error [C] is returned (time-out time  $t_{COM}$ ).
- <2> The Programming command is transmitted by command frame transmission processing.
- <3> A V850ES/Jx3-L BUSY status is checked using the HS pin.  
If a BUSY time-out occurs, a time-out error [C] is returned (time-out time  $t_{WT3}$ ).
- <4> The status frame is acquired by status check processing.
- <5> The following processing is performed according to the result of status check processing.

When the processing ends normally: Proceeds to <6>.  
When the processing ends abnormally: Abnormal termination [B]  
When a time-out error occurs: A time-out error [C] is returned.

- <6> A V850ES/Jx3-L BUSY status is checked using the HS pin.  
If a BUSY time-out occurs, a time-out error [C] is returned (time-out time  $t_{FD3}$ ).
- <7> User data is transmitted by data frame transmission processing.
- <8> A V850ES/Jx3-L BUSY status is checked using the HS pin.  
If a BUSY time-out occurs, a time-out error [C] is returned (time-out time  $t_{WT4}$ ).
- <9> The status frame is acquired by status check processing.
- <10> The following processing is performed according to the result of status check processing (status code (ST1/ST2)) (also refer to the processing sequence chart and flowchart).

When ST1 = abnormal termination: Abnormal termination [B]  
When ST1 = time-out error: A time-out error [C] is returned.  
When ST1 = normal completion: The following processing is performed according to the ST2 value.

- When ST2  $\neq$  ACK: Abnormal termination [D]
- When ST2 = ACK: Proceeds to <11> when transmission of all of the user data is completed.  
If there still remain user data to be transmitted, the processing re-executes the sequence from <6>.

- <11> A V850ES/Jx3-L BUSY status is checked using the HS pin.  
If a BUSY time-out occurs, a time-out error [C] is returned (time-out time  $t_{WT5}$ ).
- <12> The status frame is acquired by status check processing.
- <13> The following processing is performed according to the result of status check processing.

When the processing ends normally: Normal completion [A]  
(Indicating that the internal verify check has performed normally after completion of write)

When the processing ends abnormally: Abnormal termination [E]  
(Indicating that the internal verify check has not performed normally after completion of write)

When a time-out error occurs: A time-out error [C] is returned.

## 5.9.3 Status at processing completion

Status at Processing Completion		Status Code	Description
Normal completion [A]	Normal acknowledgment (ACK)	06H	The command was executed normally and the user data was written normally.
Abnormal termination [B]	Parameter error	05H	The specified start/end address is not the start/end address of the block.
	Checksum error	07H	The checksum of the transmitted command frame does not match.
	Protect error	10H	Write is prohibited by the security setting. Or, boot block rewrite is prohibited by the security setting because specified range includes the boot area.
	Negative acknowledgment (NACK)	15H	<ul style="list-style-type: none"> <li>A command other than the Status command was received during processing.</li> <li>Command frame data is abnormal (such as invalid data length (LEN) or no ETX).</li> </ul>
Time-out error [C]		–	Processing timed out due to the busy status at the HS pin.
Abnormal termination [D]	WRITE error	1CH	A write error has occurred.
Abnormal termination [E]	MRG11error	1BH	An internal verify error has occurred.

5.9.4 Flowchart

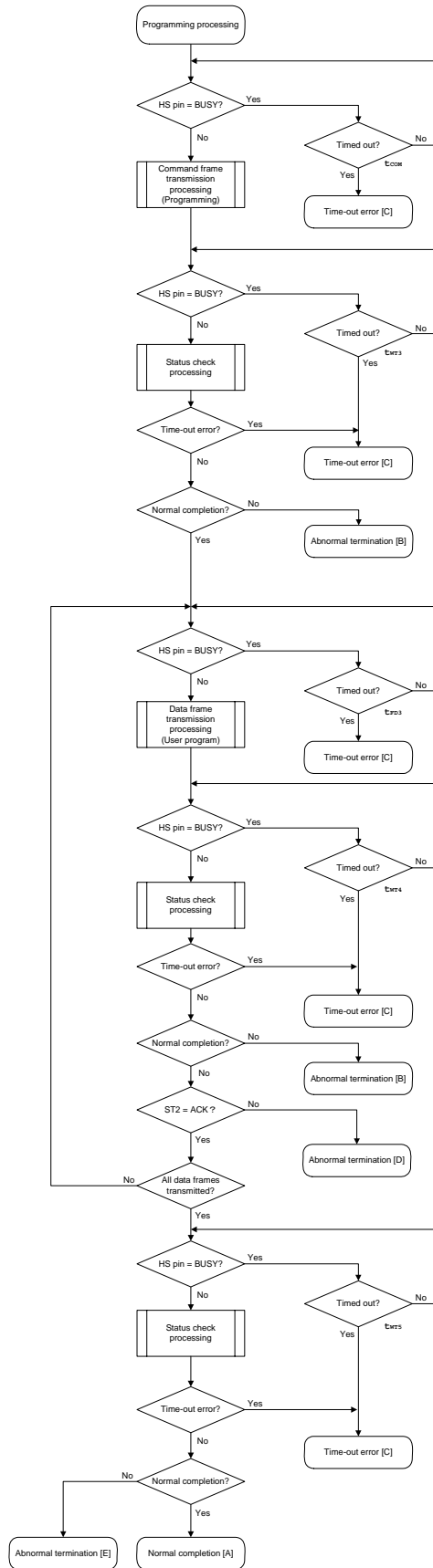

### 5.9.5 Sample program

The following shows a sample program for Programming command processing.

```

/*****/
/*
/* Write command (CSI-HS)
/*
/*****/
/* [i] u32 top      ... start address
/* [i] u32 bottom  ... end address
/* [r] u16         ... error code
/*****/
u16  fl_hs_write(u32 top, u32 bottom)
{
    u16    rc;
    u32    send_head, send_size;
    bool   is_end;
    u32    wt5_max;

    /*****/
    /*      set params
    /*****/
    set_range_prm(fl_cmd_prm, top, bottom);          // set SAH/SAM/SAL, EAH/EAM/EAL
    wt5_max = make_wt5_max(get_block_num(top, bottom));

    /*****/
    /*      send command & check status
    /*****/
    if (hs_busy_to(tCOM_MAX))
        return  FLC_HSTO_ERR;                      // t.o. detected

    if (rc = put_cmd_hs(FL_COM_WRITE, 7, fl_cmd_prm))// send "Programming" command
        return rc;                                // t.o. detected

    if (hs_busy_to(tWT3_MAX))
        return  FLC_HSTO_ERR;                      // t.o. detected

    rc = fl_hs_getstatus();                        // get status frame
    switch(rc) {
        case  FLC_NO_ERR:                          break; // continue
    // case  FLC_HSTO_ERR:  return rc;  break; // case [C]
        default:          return rc;  break; // case [B]
    }

    /*****/
    /*      send user data
    /*****/
    send_head = top;

    while(1){
        // make send data frame
        if ((bottom - send_head) > 256){          // rest size > 256 ?
            is_end = false;                        // yes, not end frame
            send_size = 256;                       // transmit size = 256 byte
        }
        else{
            is_end = true;
            send_size = bottom - send_head + 1;
                // transmit size = (bottom - send_head)+1 byte

```

```

    }
    memcpy(fl_txdata_frm, rom_buf+send_head, send_size);
                                                // set data frame payload
    send_head += send_size;

    if (hs_busy_to(tFD3_MAX))                // t.o. check before sending data
frame
        return FLC_HSTO_ERR;                // t.o. detected

    if (rc = put_dfrm_hs(send_size, fl_txdata_frm, is_end))
                                                // send user data
        return rc;                          // error detected

    if (hs_busy_to(tWT4_MAX))
        return FLC_HSTO_ERR;                // t.o. detected

    rc = fl_hs_getstatus();                  // get status frame
    switch(rc) {
        case FLC_NO_ERR:                    break; // continue
        // case FLC_HSTO_ERR: return rc;     break; // case [C]
        default:                            return rc; break; // case [B]
    }
    if (fl_st2 != FLST_ACK){                // ST2 = ACK ?
        rc = decode_status(fl_st2);         // No
        return rc;                          // case [D]
    }
    if (is_end)                             // send all user data ?
        break;                              // yes

}
/*****
/*      Check internally verify          */
*****/
if (hs_busy_to(wt5_max))
    return FLC_HSTO_ERR;                    // t.o. detected

rc = fl_hs_getstatus();                    // get status frame
// switch(rc) {
//     case FLC_NO_ERR:    return rc;    break; // case [A]
//     case FLC_HSTO_ERR: return rc;    break; // case [C]
//     default:           return rc;    break; // case [B]
// }
return rc;

}

```



### 5.10 Verify Command

#### 5.10.1 Processing sequence chart

Verify command processing sequence

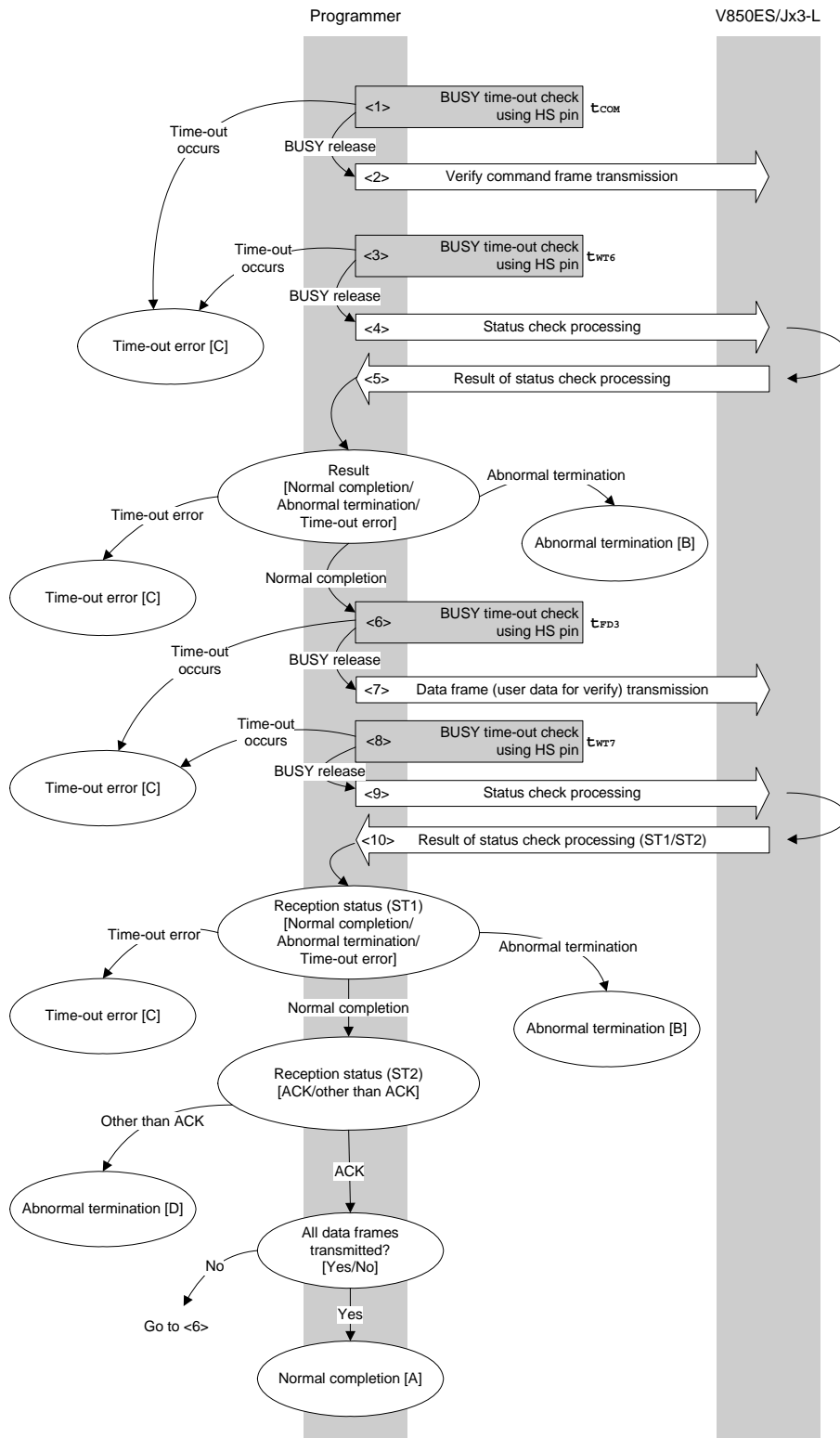

**5.10.2 Description of processing sequence**

- <1> A V850ES/Jx3-L BUSY status is checked using the HS pin.  
If a BUSY time-out occurs, a time-out error [C] is returned (time-out time  $t_{COM}$ ).
- <2> The Verify command is transmitted by command frame transmission processing.
- <3> A V850ES/Jx3-L BUSY status is checked using the HS pin.  
If a BUSY time-out occurs, a time-out error [C] is returned (time-out time  $t_{WT6}$ ).
- <4> The status frame is acquired by status check processing.
- <5> The following processing is performed according to the result of status check processing.

When the processing ends normally: Proceeds to <6>.  
 When the processing ends abnormally: Abnormal termination [B]  
 When a time-out error occurs: A time-out error [C] is returned.

- <6> A V850ES/Jx3-L BUSY status is checked using the HS pin.  
If a BUSY time-out occurs, a time-out error [C] is returned (time-out time  $t_{FD3}$ ).
- <7> User data for verifying is transmitted by data frame transmission processing.
- <8> A V850ES/Jx3-L BUSY status is checked using the HS pin.  
If a BUSY time-out occurs, a time-out error [C] is returned (time-out time  $t_{WT7}$ ).
- <9> The status frame is acquired by status check processing.
- <10> The following processing is performed according to the result of status check processing (status code (ST1/ST2)) (also refer to the processing sequence chart and flowchart).

When ST1 = abnormal termination: Abnormal termination [B]  
 When ST1 = time-out error: A time-out error [C] is returned.  
 When ST1 = normal completion: The following processing is performed according to the ST2 value.

- When ST2 = ACK: If transmission of all data frames is completed, the processing ends normally [A].  
If there still remain data frames to be transmitted, the processing re-executes the sequence from <6>.
- When ST2  $\neq$  ACK: Abnormal termination [D]

**5.10.3 Status at processing completion**

Status at Processing Completion		Status Code	Description
Normal completion [A]	Normal acknowledgment (ACK)	06H	The command was executed normally and the verify was completed normally.
Abnormal termination [B]	Parameter error	05H	The specified start/end address is not the start/end address of the block.
	Checksum error	07H	The checksum of the transmitted command frame or data frame does not match.
	Negative acknowledgment (NACK)	15H	<ul style="list-style-type: none"> <li>• A command other than the Status command was received during processing.</li> <li>• Command frame data is abnormal (such as invalid data length (LEN) or no ETX).</li> </ul>
Time-out error [C]		–	Processing timed out due to the busy status at the HS pin.
Abnormal termination [D]	Verify error	0FH	The verify has failed, or another error has occurred.

5.10.4 Flowchart

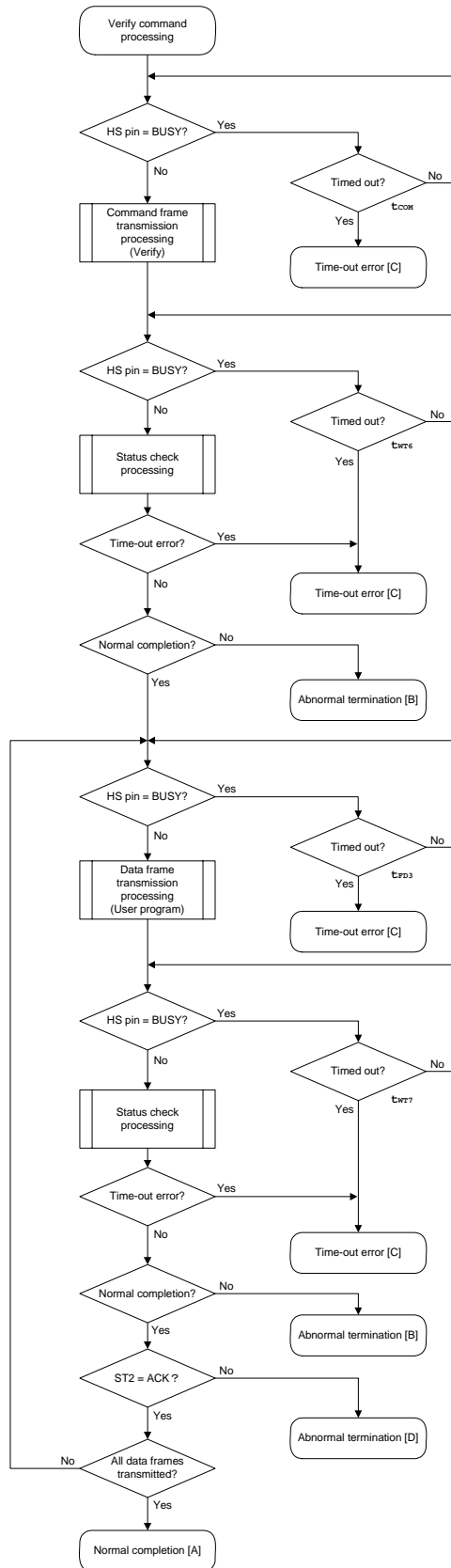

### 5.10.5 Sample program

The following shows a sample program for Verify command processing.

```

/*****
/*
/* Verify command (CSI-HS)
/*
/*****
/* [i] u32 top      ... start address
/* [i] u32 bottom  ... end address
/* [r] u16         ... error code
/*****
u16      fl_hs_verify(u32 top, u32 bottom, u8 *buf)
{
    u16    rc;
    u32    send_head, send_size;
    bool   is_end;

    /*****
    /*      set params
    /*****
    set_range_prm(fl_cmd_prm, top, bottom);          // set SAH/SAM/SAL, EAH/EAM/EAL

    /*****
    /*      send command & check status
    /*****

    if (hs_busy_to(tCOM_MAX))
        return FLC_HSTO_ERR;          // t.o. detected

    if (rc = put_cmd_hs(FL_COM_VERIFY, 7, fl_cmd_prm)) // send "Verify" command
        return rc;                    // error detected

    if (hs_busy_to(tWT6_MAX))
        return FLC_HSTO_ERR;          // t.o. detected

    rc = fl_hs_getstatus();           // get status frame
    switch(rc) {
        case    FLC_NO_ERR:            break; // continue
    // case    FLC_HSTO_ERR: return rc;  break; // case [C]
        default: return rc;           break; // case [B]
    }

    /*****
    /*      send user data
    /*****
    send_head = top;

    while(1){

        // make send data frame
        if ((bottom - send_head) > 256){ // rest size > 256 ?
            is_end = false;             // yes, not is_end frame
            send_size = 256;           // transmit size = 256 byte

```

```

    }
    else{
        is_end = true;
        send_size = bottom - send_head + 1;
                // transmit size = (bottom - send_head)+1 byte
    }
    memcpy(fl_txdata_frm, buf+send_head, send_size); // set data frame payload
    send_head += send_size;

    if (hs_busy_to(tFD3_MAX))
        return FLC_HSTO_ERR; // t.o. detected

    if (rc = put_dfrm_hs(send_size, fl_txdata_frm, is_end))
        // send user data
        return rc; // error detected

    if (hs_busy_to(tWT7_MAX))
        return FLC_HSTO_ERR; // t.o. detected

    rc = fl_hs_getstatus(); // get status frame
    switch(rc) {
        case FLC_NO_ERR: break; // continue
        // case FLC_HSTO_ERR: return rc; break; // case [C]
        default: return rc; break; // case [B]
    }
    if (fl_st2 != FLST_ACK){ // ST2 = ACK ?
        rc = decode_status(fl_st2); // No
        return rc; // case [D]
    }
    if (is_end) // send all user data ?
        break; // yes
}
return FLC_NO_ERR; // case [A]
}

```

### 5.11 Block Blank Check Command

#### 5.11.1 Processing sequence chart

Block Blank Check command processing sequence

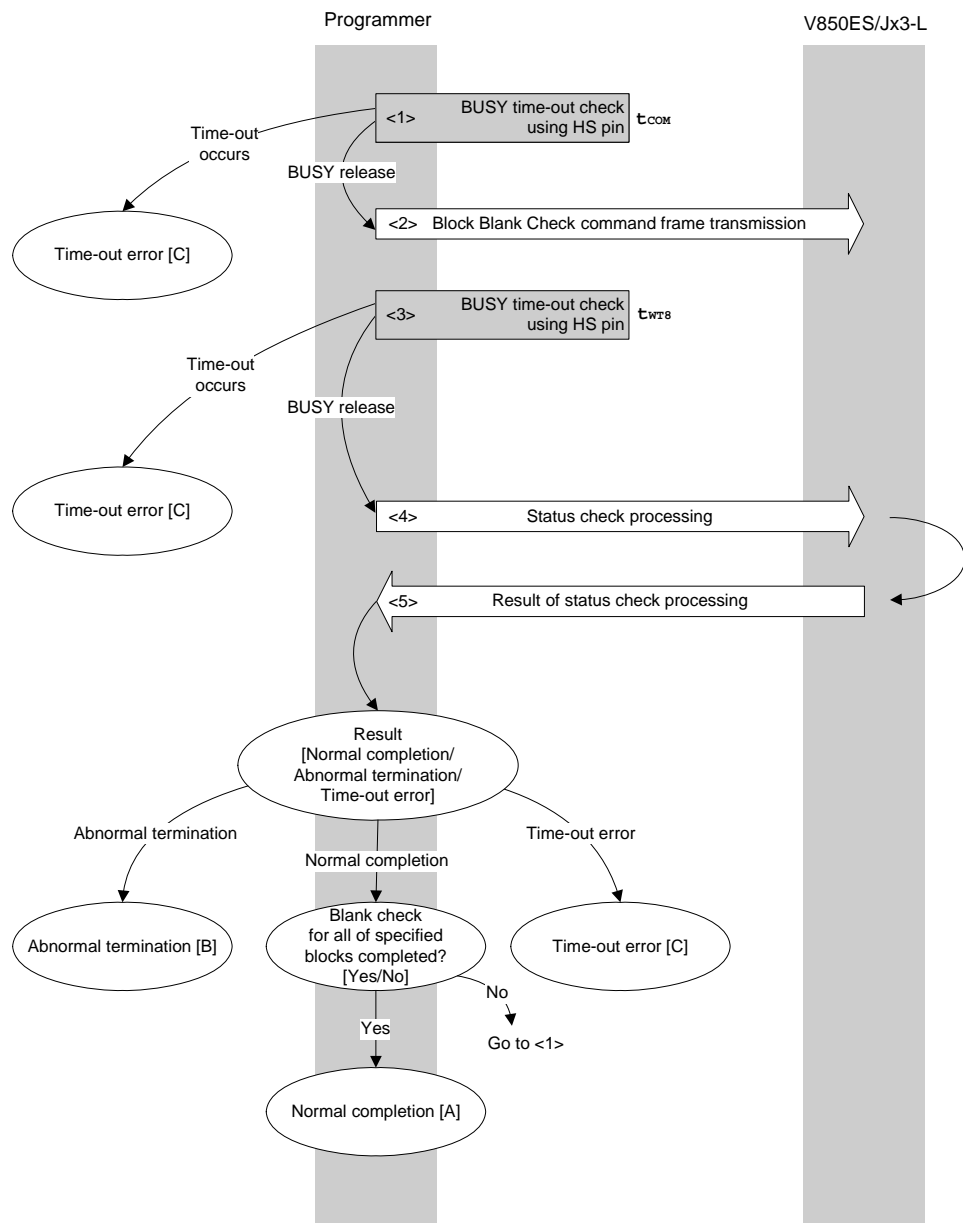

### 5.11.2 Description of processing sequence

- <1> A V850ES/Jx3-L BUSY status is checked using the HS pin.  
If a BUSY time-out occurs, a time-out error [C] is returned (time-out time  $t_{COM}$ ).
- <2> The Block Blank Check command is transmitted by command frame transmission processing.
- <3> A V850ES/Jx3-L BUSY status is checked using the HS pin.  
If a BUSY time-out occurs, a time-out error [C] is returned (time-out time  $t_{WTB}$ ).
- <4> The status frame is acquired by status check processing.
- <5> The following processing is performed according to the result of status check processing.

When the processing ends abnormally: Abnormal termination [B]

When the processing ends normally: If the blank check for all of the specified blocks is completed, the processing ends normally [A].

If the blank check for all of the specified blocks is not yet completed, processing changes the block number and re-executes the sequence from <1>.

When a time-out error occurs: A time-out error [C] is returned.

### 5.11.3 Status at processing completion

Status at Processing Completion		Status Code	Description
Normal completion [A]	Normal acknowledgment (ACK)	06H	The command was executed normally and all of the specified blocks are blank.
Abnormal termination [B]	Parameter error	05H	The specified start/end address is not the start/end address of the block.
	Checksum error	07H	The checksum of the transmitted command frame does not match.
	Negative acknowledgment (NACK)	15H	<ul style="list-style-type: none"> <li>A command other than the Status command was received during processing.</li> <li>Command frame data is abnormal (such as invalid data length (LEN) or no ETX).</li> </ul>
	MRG11 error	1BH	The specified block in the flash memory is not blank.
Time-out error [C]		–	Processing timed out due to the busy status at the HS pin.



5.11.4 Flowchart

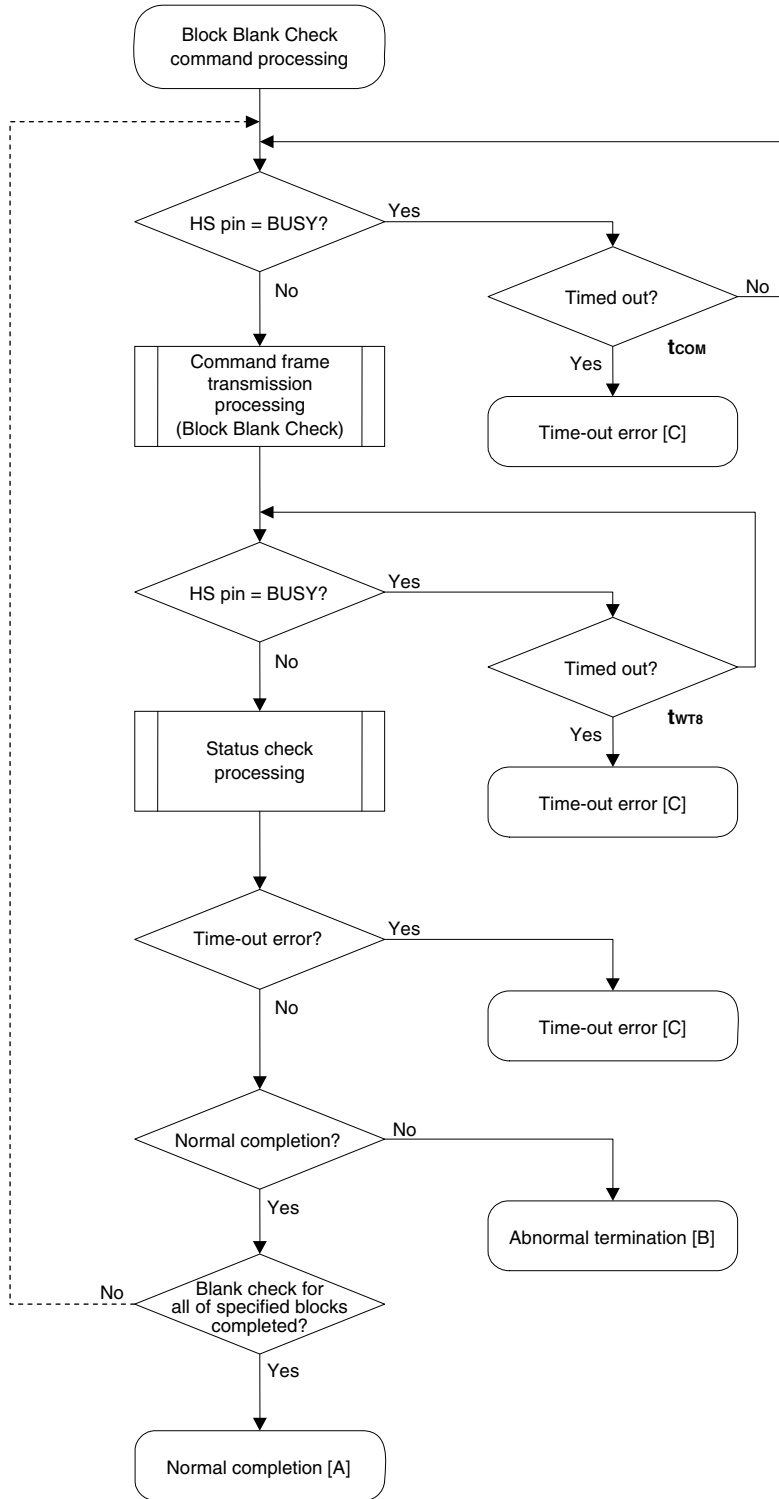

### 5.11.5 Sample program

The following shows a sample program for Block Blank Check command processing for one block.

```

/*****
/*
/*   Block blank check command (CSI-HS)
/*
/*
/*****
/* [i] u16 sblk      ... start block number
/* [i] u16 eblk      ... end block number
/* [r] u16           ... error code
/*****
u16      fl_hs_blk_blank_chk(u16 sblk, u16 eblk)
{
    u16    rc;
    u32    wt8_max;

    u32    top, bottom;

    top = get_top_addr(sblk);           // get start address of start block
    bottom = get_bottom_addr(eblk);    // get end address of end block
    set_range_prm(fl_cmd_prm, top, bottom); // set SAH/SAM/SAL, EAH/EAM/EAL

    wt8_max = make_wt8_max(sblk, eblk); // get tWT8(Max)

    if (hs_busy_to(tCOM_MAX))
        return FLC_HSTO_ERR;           // t.o. detected :case [C]

    if (rc = put_cmd_hs(FL_COM_BLOCK_BLANK_CHK, 7, fl_cmd_prm))
        // send "Block Blank Check" command
        return rc;                     // case [C]

    if (hs_busy_to(wt8_max))
        return FLC_HSTO_ERR;           // t.o. detected :case [C]

    rc = fl_hs_getstatus();             // get status frame
    // switch(rc) {
    //     case   FLC_NO_ERR:    return rc;    break; // case [A]
    //     case   FLC_HSTO_ERR: return rc;    break; // case [C]
    //     default:            return rc;    break; // case [B]
    // }
    return rc;
}

```

### 5.12 Silicon Signature Command

#### 5.12.1 Processing sequence chart

Silicon Signature command processing sequence

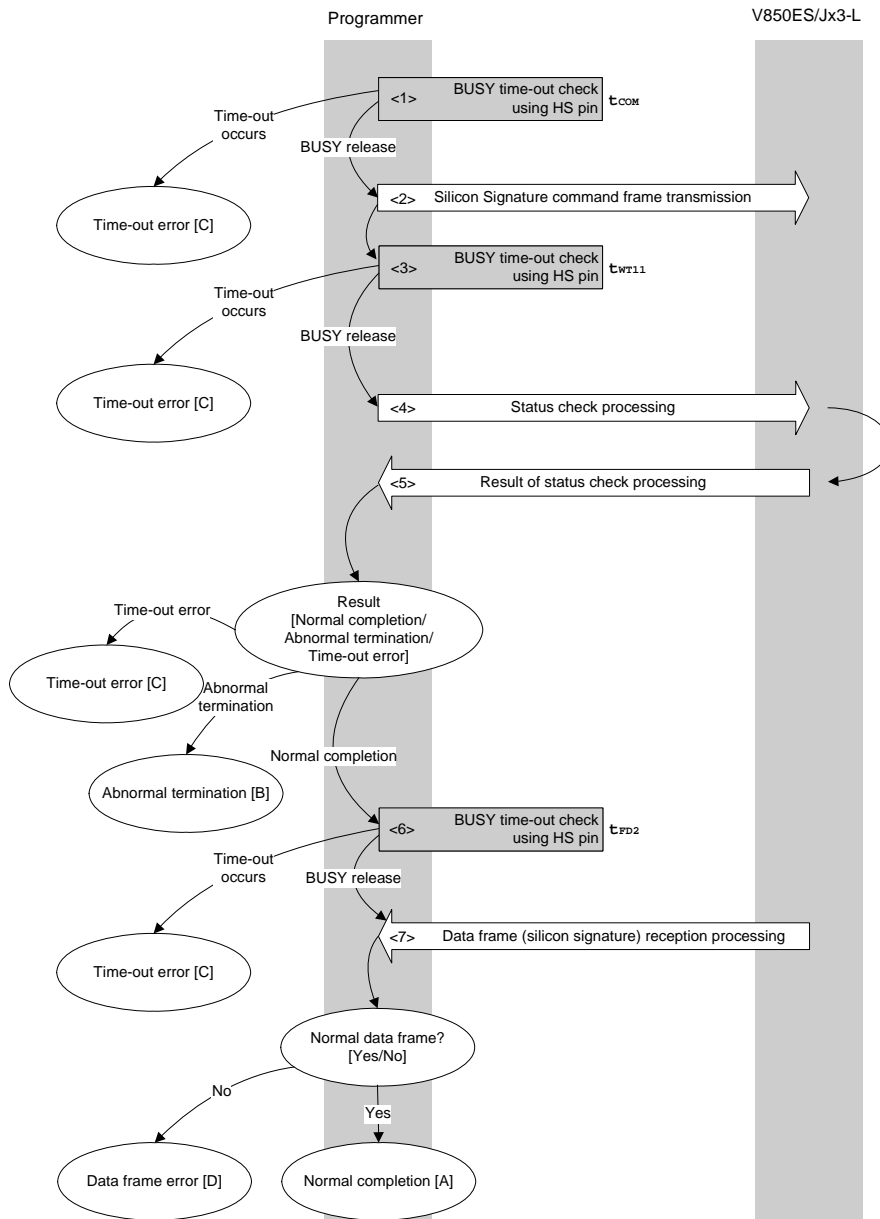

### 5.12.2 Description of processing sequence

- <1> A V850ES/Jx3-L BUSY status is checked using the HS pin.  
If a BUSY time-out occurs, a time-out error [C] is returned (time-out time  $t_{COM}$ ).
- <2> The Silicon Signature command is transmitted by command frame transmission processing.
- <3> A V850ES/Jx3-L BUSY status is checked using the HS pin.  
If a BUSY time-out occurs, a time-out error [C] is returned (time-out time  $t_{WT11}$ ).
- <4> The status frame is acquired by status check processing.
- <5> The following processing is performed according to the result of status check processing.

When the processing ends normally: Proceeds to <6>.  
 When the processing ends abnormally: Abnormal termination [B]  
 When a time-out error occurs: A time-out error [C] is returned.

- <6> A V850ES/Jx3-L BUSY status is checked using the HS pin.  
If a BUSY time-out occurs, a time-out error [C] is returned (time-out time  $t_{FD2}$ ).
- <7> The received data frame (silicon signature data) is checked.

If data frame is normal: Normal completion [A]  
 If data frame is abnormal: Data frame error [D]

### 5.12.3 Status at processing completion

Status at Processing Completion		Status Code	Description
Normal completion [A]	Normal acknowledgment (ACK)	06H	The command was executed normally and the silicon signature was acquired normally.
Abnormal termination [B]	Checksum error	07H	The checksum of the transmitted command frame does not match.
	Negative acknowledgment (NACK)	15H	<ul style="list-style-type: none"> <li>A command other than the Status command was received during processing.</li> <li>Command frame data is abnormal (such as invalid data length (LEN) or no ETX).</li> </ul>
Time-out error [C]		–	Processing timed out due to the busy status at the HS pin.
Data frame error [D]		–	The checksum of the data frame received as silicon signature data does not match.

5.12.4 Flowchart

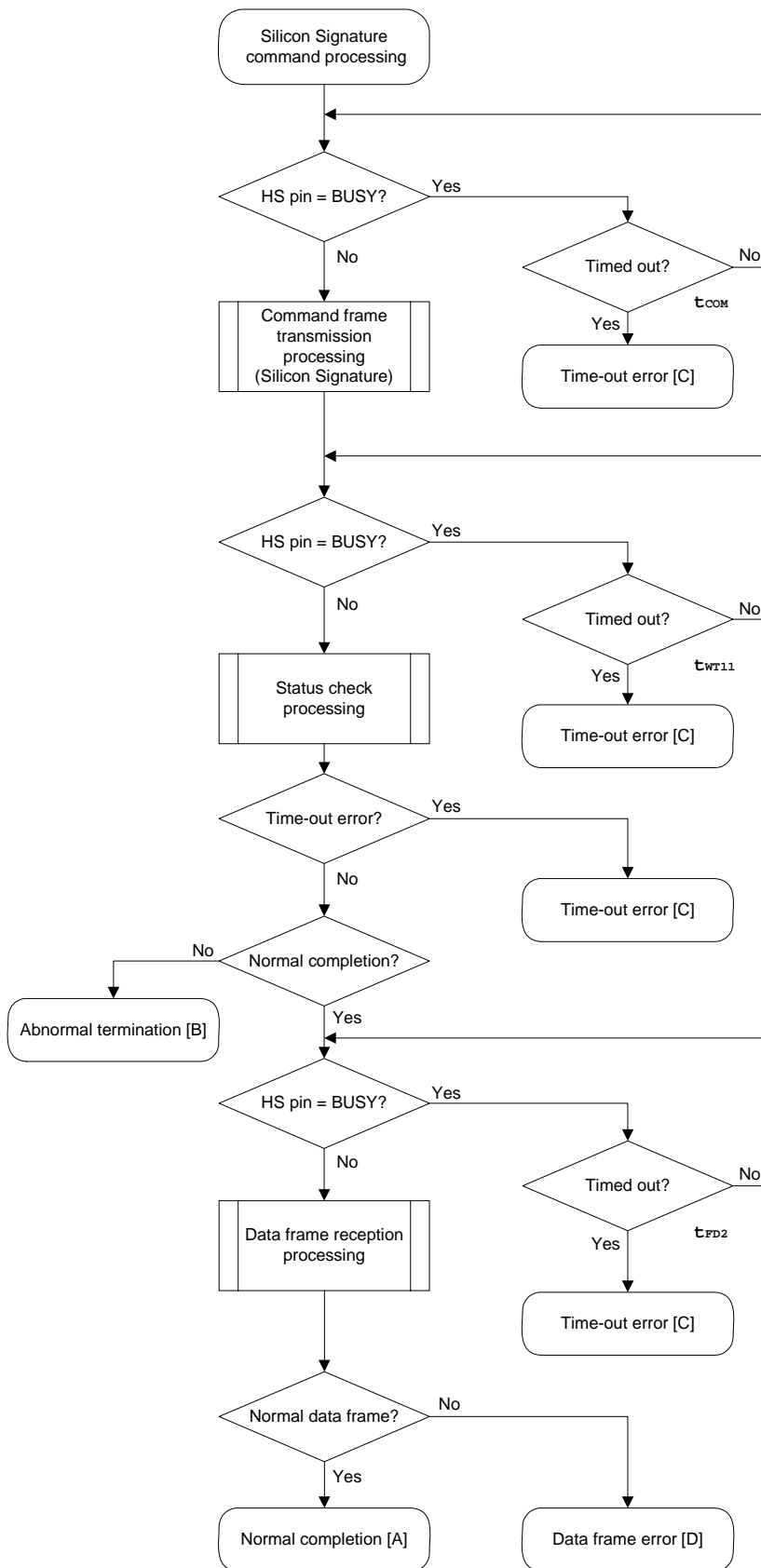

### 5.12.5 Sample program

The following shows a sample program for Silicon Signature command processing.

```

/*****/
/*
/* Get silicon signature command (CSI-HS)
/*
/*****/
/* [i] u8 *sig... pointer to signature save area
/* [r] u16 ... error code
/*****/
u16      fl_hs_getsig(u8 *sig)
{
    u16      rc;

    if (hs_busy_to(tCOM_MAX))
        return FLC_HSTO_ERR;          // t.o. detected :case [C]

    if (rc = put_cmd_hs(FL_COM_GET_SIGNATURE, 1, fl_cmd_prm))
        return rc;                    // send "Silicon Signature" command
        // error detected :case [C]

    if (hs_busy_to(tWT11_MAX))
        return FLC_HSTO_ERR;          // t.o. detected :case [C]

    rc = fl_hs_getstatus();            // get status frame
    switch(rc) {
        case FLC_NO_ERR:                break; // continue
        // case FLC_HSTO_ERR: return rc; break; // case [C]
        default:                        return rc; break; // case [B]
    }

    if (hs_busy_to(tFD2_MAX))
        return FLC_HSTO_ERR;          // t.o. detected :case [C]

    rc = get_dfrm_hs(fl_rxdata_frm);   // get signature data

    switch(rc) {
        case FLC_NO_ERR:                break; // continue
        // case FLC_HSTO_ERR: return rc; break; // case [C]
        default:                        return rc; break; // case [D]
    }

    memcpy(sig, fl_rxdata_frm+OFS_STA_PLD, fl_rxdata_frm[OFS_LEN]);
        // copy Signature data

    return rc;                          // case [A]
}

```

5.13 Version Get Command

5.13.1 Processing sequence chart

Version Get command processing sequence

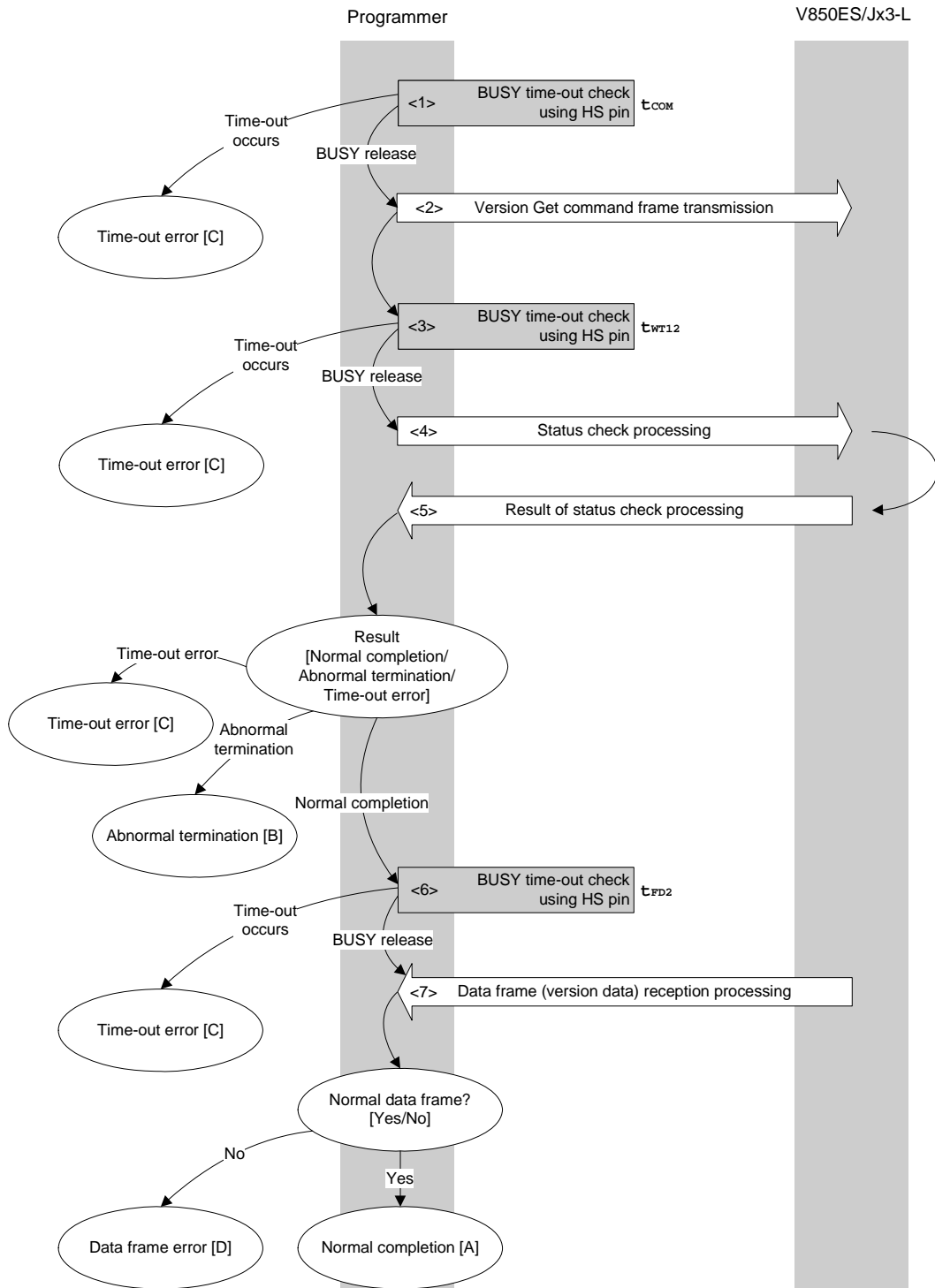

### 5.13.2 Description of processing sequence

- <1> A V850ES/Jx3-L BUSY status is checked using the HS pin.  
If a BUSY time-out occurs, a time-out error [C] is returned (time-out time  $t_{COM}$ ).
- <2> The Version Get command is transmitted by command frame transmission processing.
- <3> A V850ES/Jx3-L BUSY status is checked using the HS pin.  
If a BUSY time-out occurs, a time-out error [C] is returned (time-out time  $t_{WT12}$ ).
- <4> The status frame is acquired by status check processing.
- <5> The following processing is performed according to the result of status check processing.

When the processing ends normally: Proceeds to <6>.  
When the processing ends abnormally: Abnormal termination [B]  
When a time-out error occurs: A time-out error [C] is returned.

- <6> A V850ES/Jx3-L BUSY status is checked using the HS pin.  
If a BUSY time-out occurs, a time-out error [C] is returned (time-out time  $t_{FD2}$ ).
- <7> The received data frame (version data) is checked.

If data frame is normal: Normal completion [A]  
If data frame is abnormal: Data frame error [D]

### 5.13.3 Status at processing completion

Status at Processing Completion		Status Code	Description
Normal completion [A]	Normal acknowledgment (ACK)	06H	The command was executed normally and version data was acquired normally.
Abnormal termination [B]	Checksum error	07H	The checksum of the transmitted command frame does not match.
	Negative acknowledgment (NACK)	15H	<ul style="list-style-type: none"> <li>A command other than the Status command was received during processing.</li> <li>Command frame data is abnormal (such as invalid data length (LEN) or no ETX).</li> </ul>
Time-out error [C]		–	Processing timed out due to the busy status at the HS pin.
Data frame error [D]		–	The checksum of the data frame received as version data does not match.



5.13.4 Flowchart

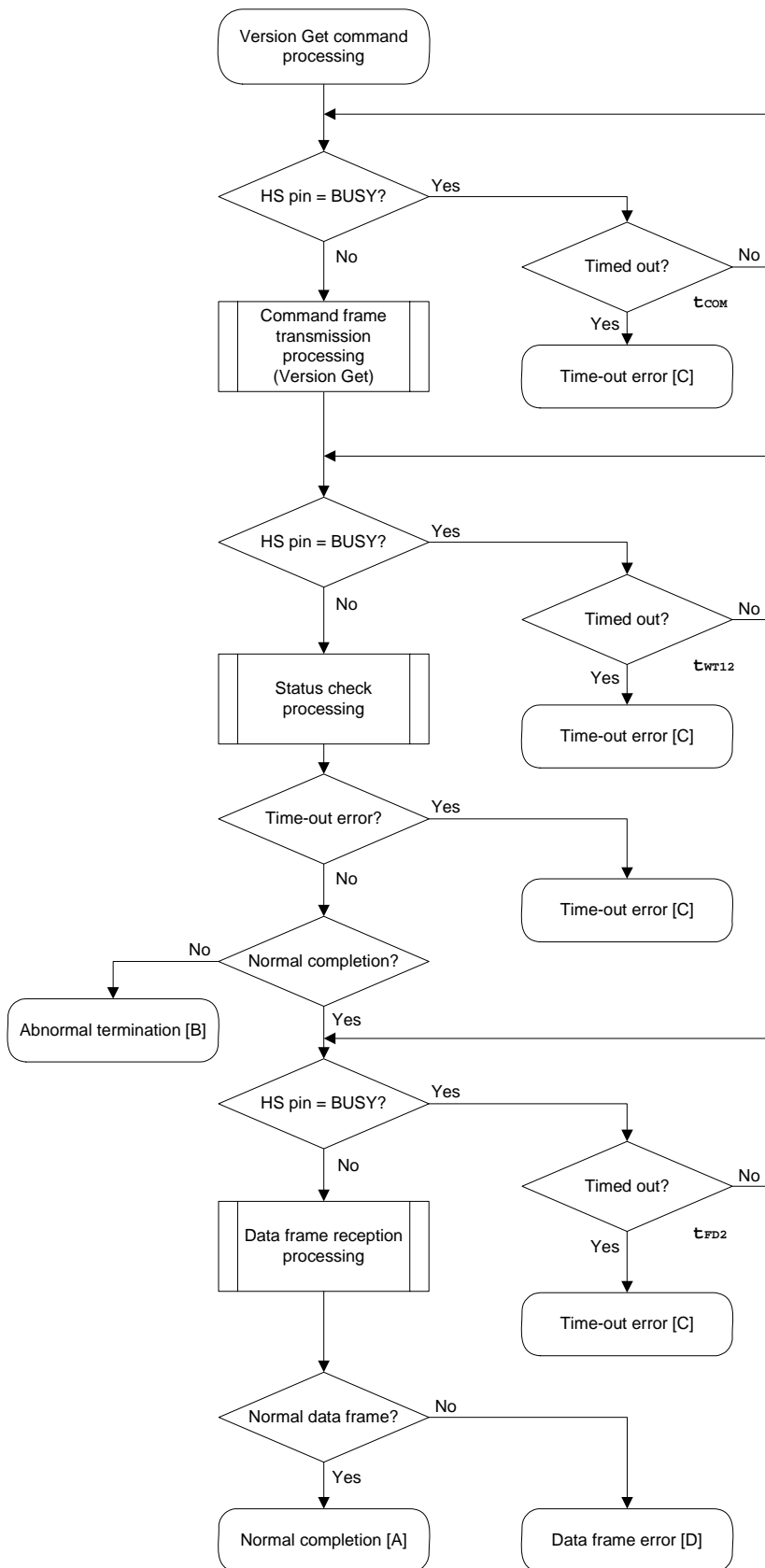

### 5.13.5 Sample program

The following shows a sample program for Version Get command processing.

```

/*****
/*
/* Get device/firmware version command (CSI-HS)
/*
/*****
/* [i] u8 *buf    ... pointer to version date save area
/* [r] u16        ... error code
/*****
u16      fl_hs_getver(u8 *buf)
{
    u16    rc;

    if (hs_busy_to(tCOM_MAX))
        return FLC_HSTO_ERR;          // t.o. detected :case [C]

    if (rc = put_cmd_hs(FL_COM_GET_VERSION, 1, fl_cmd_prm))
        return rc;                    // send "Version Get" command
        // error detected :case [C]

    if (hs_busy_to(tWT12_MAX))
        return FLC_HSTO_ERR;          // t.o. detected :case [C]

    rc = fl_hs_getstatus();            // get status frame
    switch(rc) {
        case    FLC_NO_ERR:            break; // continue
        // case    FLC_HSTO_ERR:    return rc;    break; // case [C]
        default:                        return rc;    break; // case [B]
    }

    if (hs_busy_to(tFD2_MAX))
        return FLC_HSTO_ERR;          // t.o. detected :case [C]

    rc = get_dfrm_hs(fl_rxdata_frm);    // get signature data
    switch(rc) {
        case    FLC_NO_ERR:            break; // continue
        // case    FLC_HSTO_ERR:    return rc;    break; // case [C]
        default:                        return rc;    break; // case [D]
    }

    memcpy(buf, fl_rxdata_frm+OFS_STA_PLD, DFV_LEN); // copy version data
    return rc;                          // case [A]
}

```

5.14 Checksum Command

5.14.1 Processing sequence chart

Checksum command processing sequence

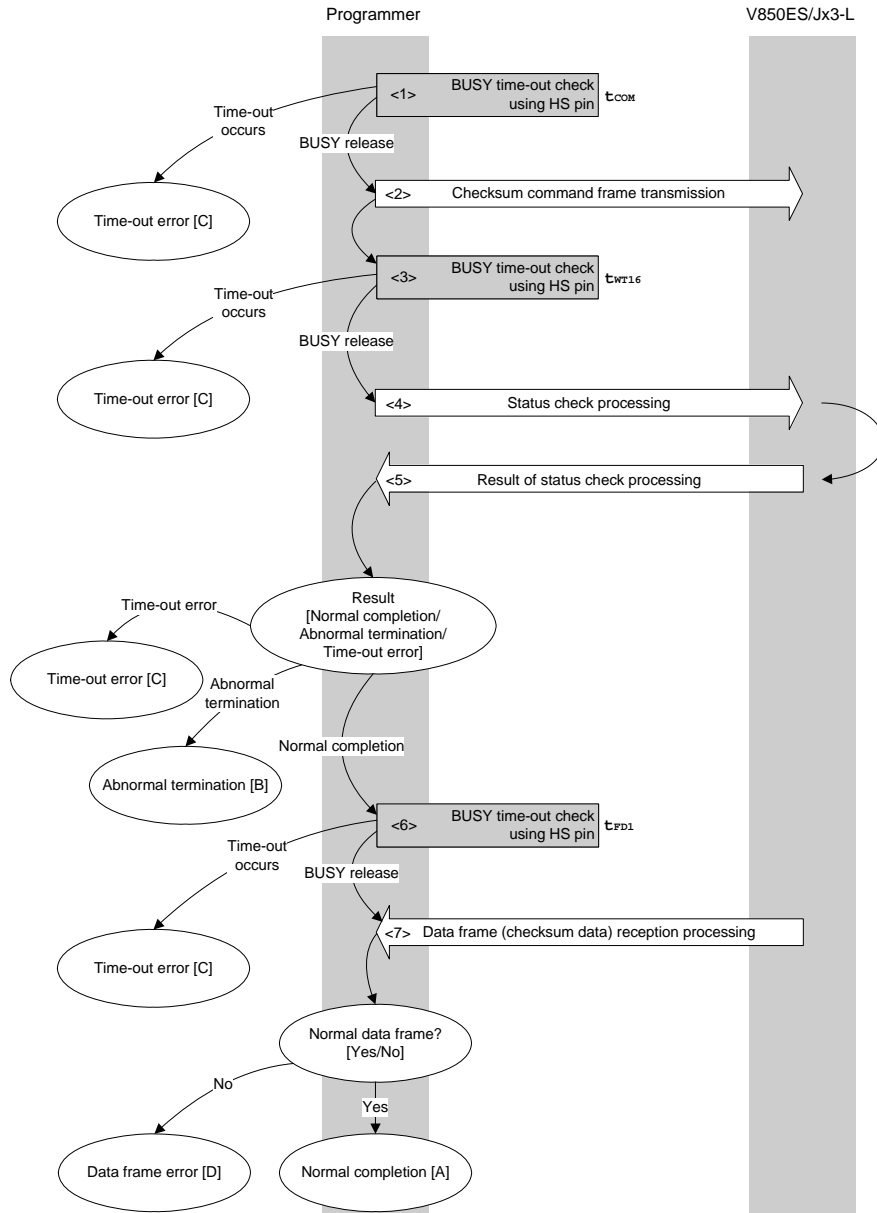

### 5.14.2 Description of processing sequence

- <1> A V850ES/Jx3-L BUSY status is checked using the HS pin.  
If a BUSY time-out occurs, a time-out error [C] is returned (time-out time  $t_{COM}$ ).
- <2> The Checksum command is transmitted by command frame transmission processing.
- <3> A V850ES/Jx3-L BUSY status is checked using the HS pin.  
If a BUSY time-out occurs, a time-out error [C] is returned (time-out time  $t_{WT16}$ ).
- <4> The status frame is acquired by status check processing.
- <5> The following processing is performed according to the result of status check processing.

When the processing ends normally: Proceeds to <6>.  
When the processing ends abnormally: Abnormal termination [B]  
When a time-out error occurs: A time-out error [C] is returned.

- <6> A V850ES/Jx3-L BUSY status is checked using the HS pin.  
If a BUSY time-out occurs, a time-out error [C] is returned (time-out time  $t_{FD1}$ ).
- <7> The received data frame (checksum data) is checked.

If data frame is normal: Normal completion [A]  
If data frame is abnormal: Data frame error [D]

### 5.14.3 Status at processing completion

Status at Processing Completion		Status Code	Description
Normal completion [A]	Normal acknowledgment (ACK)	06H	The command was executed normally and checksum data was acquired normally.
Abnormal termination [B]	Parameter error	05H	The specified start/end address is not the start/end address of the block.
	Checksum error	07H	The checksum of the transmitted command frame does not match.
	Negative acknowledgment (NACK)	15H	<ul style="list-style-type: none"> <li>A command other than the Status command was received during processing.</li> <li>Command frame data is abnormal (such as invalid data length (LEN) or no ETX).</li> </ul>
Time-out error [C]		–	Processing timed out due to the busy status at the HS pin.
Data frame error [D]		–	The checksum of the data frame received as version data does not match.

5.14.4 Flowchart

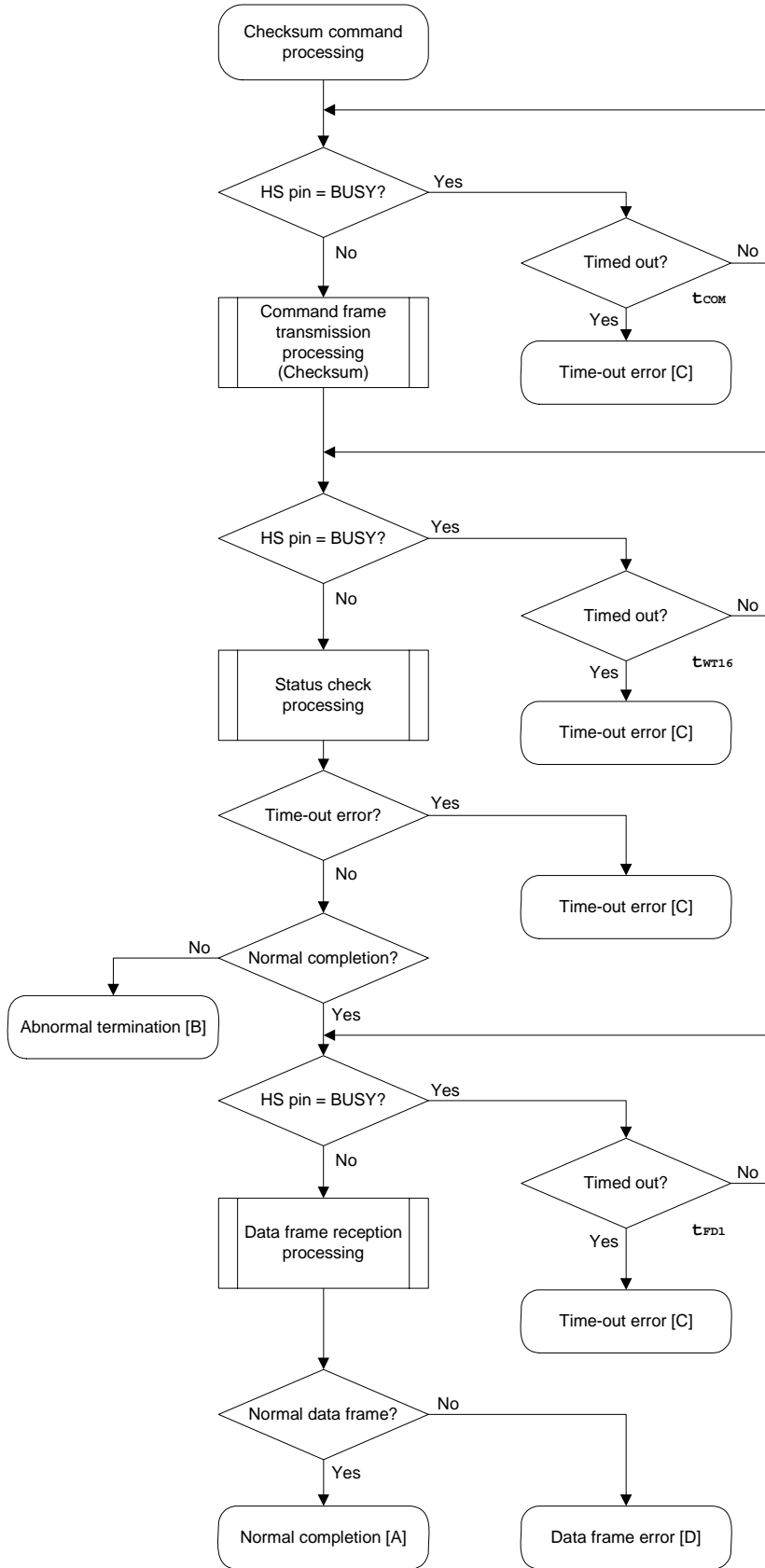

### 5.14.5 Sample program

The following shows a sample program for Checksum command processing.

```

/*****
/*
/* Get checksum command (CSI-HS)
/*
/*****
/* [i] u16 *sum      ... pointer to checksum save area
/* [i] u32 top       ... start address
/* [i] u32 bottom    ... end address
/* [r] u16           ... error code
/*****
u16      fl_hs_getsum(u16 *sum, u32 top, u32 bottom)
{
    u16    rc;
    u32    fd1_max;

    /*****
    /*      set params
    /*****
    set_range_prm(fl_cmd_prm, top, bottom);          // set SAH/SAM/SAL, EAH/EAM/EAL
    fd1_max = get_fd1_max(get_block_num(top, bottom)); // get tFD1(Max)

    /*****
    /*      send command
    /*****
    if (hs_busy_to(tCOM_MAX))
        return FLC_HSTO_ERR;          // t.o. detected :case [C]

    if (rc = put_cmd_hs(FL_COM_GET_CHECK_SUM, 7, fl_cmd_prm)) // send "Checksum" command
        return rc;          // error detected :case [C]

    if (hs_busy_to(tWT16_MAX))
        return FLC_HSTO_ERR;          // t.o. detected :case [C]

    rc = fl_hs_getstatus();          // get status frame
    switch(rc) {
        case    FLC_NO_ERR:          break; // continue
    //    case    FLC_HSTO_ERR: return rc; break; // case [C]
        default:          return rc; break; // case [B]
    }

    /*****
    /*      get data frame (Checksum data)
    /*****
    if (hs_busy_to(fd1_max))
        return FLC_HSTO_ERR;          // t.o. detected :case [C]

    rc = get_dfrm_hs(fl_rxddata_frm);          // get sum data

    switch(rc) {
        case    FLC_NO_ERR:          break; // continue
    //    case    FLC_HSTO_ERR: return rc; break; // case [C]
        default:          return rc; break; // case [D]
    }

```

```
    }  
  
    *sum = (fl_rxdata_frm[OFS_STA_PLD] << 8) + fl_rxdata_frm[OFS_STA_PLD+1];  
                                                // set SUM data  
    return rc;                                // case [A]  
}
```

### 5.15 Security Set Command

#### 5.15.1 Processing sequence chart

Security Set command processing sequence

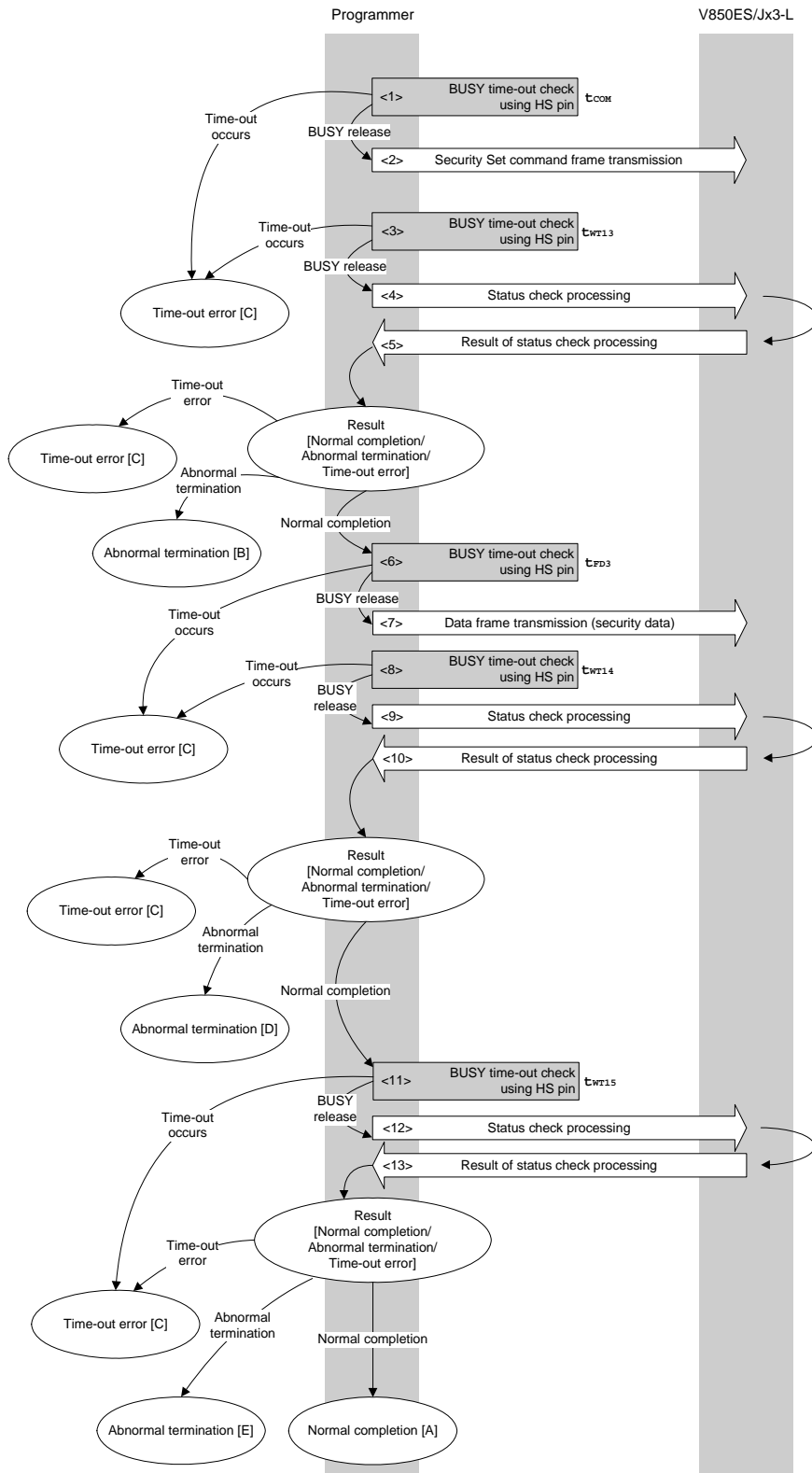



**5.15.2 Description of processing sequence**

- <1> A V850ES/Jx3-L BUSY status is checked using the HS pin.  
If a BUSY time-out occurs, a time-out error [C] is returned (time-out time  $t_{COM}$ ).
- <2> The Security Set command is transmitted by command frame transmission processing.
- <3> A V850ES/Jx3-L BUSY status is checked using the HS pin.  
If a BUSY time-out occurs, a time-out error [C] is returned (time-out time  $t_{WT13}$ ).
- <4> The status frame is acquired by status check processing.
- <5> The following processing is performed according to the result of status check processing.

When the processing ends normally: Proceeds to <6>.  
 When the processing ends abnormally: Abnormal termination [B]  
 When a time-out error occurs: A time-out error [C] is returned.

- <6> A V850ES/Jx3-L BUSY status is checked using the HS pin.  
If a BUSY time-out occurs, a time-out error [C] is returned (time-out time  $t_{FD3}$ ).
- <7> The data frame (security setting data) is transmitted by data frame transmission processing.
- <8> A V850ES/Jx3-L BUSY status is checked using the HS pin.  
If a BUSY time-out occurs, a time-out error [C] is returned (time-out time  $t_{WT14}$ ).
- <9> The status frame is acquired by status check processing.
- <10> The following processing is performed according to the result of status check processing.

When the processing ends normally: Proceeds to <11>.  
 When the processing ends abnormally: Abnormal termination [D]  
 When a time-out error occurs: A time-out error [C] is returned.

- <11> A V850ES/Jx3-L BUSY status is checked using the HS pin.  
If a BUSY time-out occurs, a time-out error [C] is returned (time-out time  $t_{WT15}$ ).
- <12> The status frame is acquired by status check processing.
- <13> The following processing is performed according to the result of status check processing.

When the processing ends normally: Normal completion [A]  
 When the processing ends abnormally: Abnormal termination [E]  
 When a time-out error occurs: A time-out error [C] is returned.

## 5.15.3 Status at processing completion

Status at Processing Completion		Status Code	Description
Normal completion [A]	Normal acknowledgment (ACK)	06H	The command was executed normally and security setting data was performed normally.
Abnormal termination [B]	Checksum error	07H	The checksum of the transmitted command frame does not match.
	Negative acknowledgment (NACK)	15H	<ul style="list-style-type: none"> <li>A command other than the Status command was received during processing.</li> <li>Command frame data is abnormal (such as invalid data length (LEN) or no ETX).</li> </ul>
Time-out error [C]		–	The status frame was not received within the specified time.
Abnormal termination [D]	Negative acknowledgment (NACK)	15H	The security data frame is abnormal.
	Checksum error	07H	The checksum of the transmitted security data frame does not match.
	Protect error	10H	When security data is in the following statuses <ul style="list-style-type: none"> <li>The security is changed from disabled to enabled.</li> <li>The value of the last block number in the boot block cluster is changed when boot block cluster rewriting is disabled.</li> </ul>
	Parameter error	05H	When security data is in the following statuses <ul style="list-style-type: none"> <li>The last block number of the boot block cluster is larger than the last block number of the device.</li> <li>The value of the reset vector handler address is not 0000000H.</li> </ul>
Abnormal termination [E]	MRG10 error	1AH	A write error has occurred.
	MRG11 error	1BH	
	WRITE error	1CH	

5.15.4 Flowchart

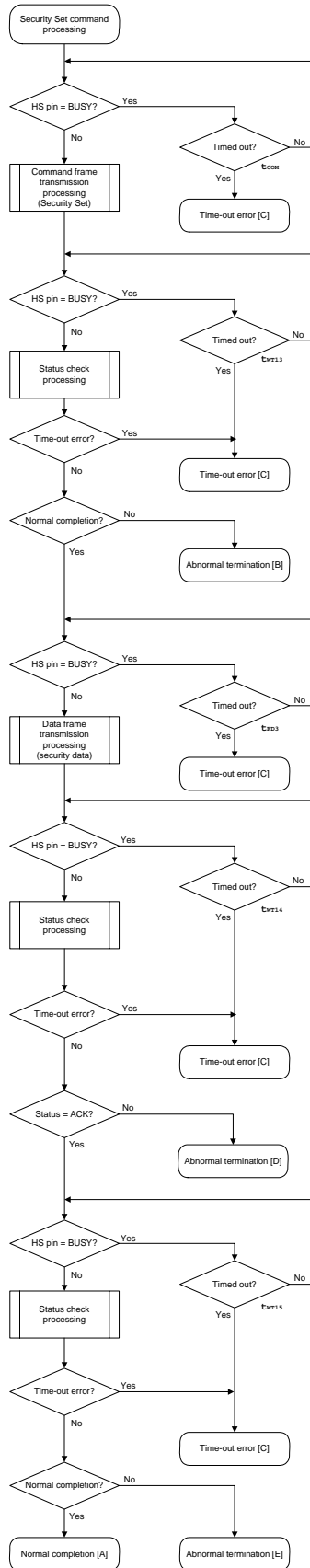

**5.15.5 Sample program**

The following shows a sample program for Security Set command processing.

```

/*****
/*
/*   Set security flag command (CSI-HS)
/*
/*
/*****
/* [i] u8 scf... Security flag data
/* [r] u16      ... error code
/*****
u16      fl_hs_setscf(u8 scf, u8 bot, u32 vect)
{
    u16    rc;

/*****
/*      set params
/*
/*****
fl_cmd_prm[0] = 0x00;          // "BLK" (must be 0x00)
fl_cmd_prm[1] = 0x00;          // "PAG" (must be 0x00)

fl_txdata_frm[0] = scf|0b11100000; // "FLG" (bit 7,6,5 must be '1')
fl_txdata_frm[1] = bot;          // "BOT"

fl_txdata_frm[2] = (u8)(vect >> 16); // "ADH"
fl_txdata_frm[3] = (u8)(vect >> 8); // "ADM"
fl_txdata_frm[4] = (u8) vect;      // "ADL"

/*****
/*      send command
/*
/*****
if (hs_busy_to(tCOM_MAX))
    return FLC_HSTO_ERR;          // t.o. detected :case [C]

if (rc = put_cmd_hs(FL_COM_SET_SECURITY, 3, fl_cmd_prm))
    // send "Security Set" command
    return rc;                    // error detected :case [C]

if (hs_busy_to(tWT13_MAX))
    return FLC_HSTO_ERR;          // t.o. detected :case [C]

rc = fl_hs_getstatus();          // get status frame
switch(rc) {
    case FLC_NO_ERR:              break; // continue
    // case FLC_HSTO_ERR: return rc; break; // case [C]
    default:                      return rc; break; // case [B]
}

/*****
/*      send data frame (security setting data)
/*
/*****
if (hs_busy_to(tFD3_MAX))

```

```
        return FLC_HSTO_ERR;           // t.o. detected :case [C]

if (rc = put_dfrm_hs(5, fl_txdata_frm, true)) // send security setting data
    return rc;                          // error detected :case [C]

if (hs_busy_to(tWT14_MAX))
    return FLC_HSTO_ERR;               // t.o. detected :case [C]

rc = fl_hs_getstatus();                // get status frame
switch(rc) {
    case FLC_NO_ERR:                   break; // continue
//   case FLC_HSTO_ERR: return rc;     break; // case [C]
    default:                          return rc; break; // case [B]
}

/*****
/*   Check internally verify           */
*****/
if (hs_busy_to(tWT15_MAX))
    return FLC_HSTO_ERR;               // t.o. detected

rc = fl_hs_getstatus();                // get status frame again
// switch(rc) {
//     case FLC_NO_ERR:   return rc;   break; // case [A]
//     case FLC_HSTO_ERR: return rc;   break; // case [C]
//     default:         return rc;   break; // case [B]
// }
return rc;
}
```

5.16 Read Command

5.16.1 Processing sequence chart

Read command processing sequence

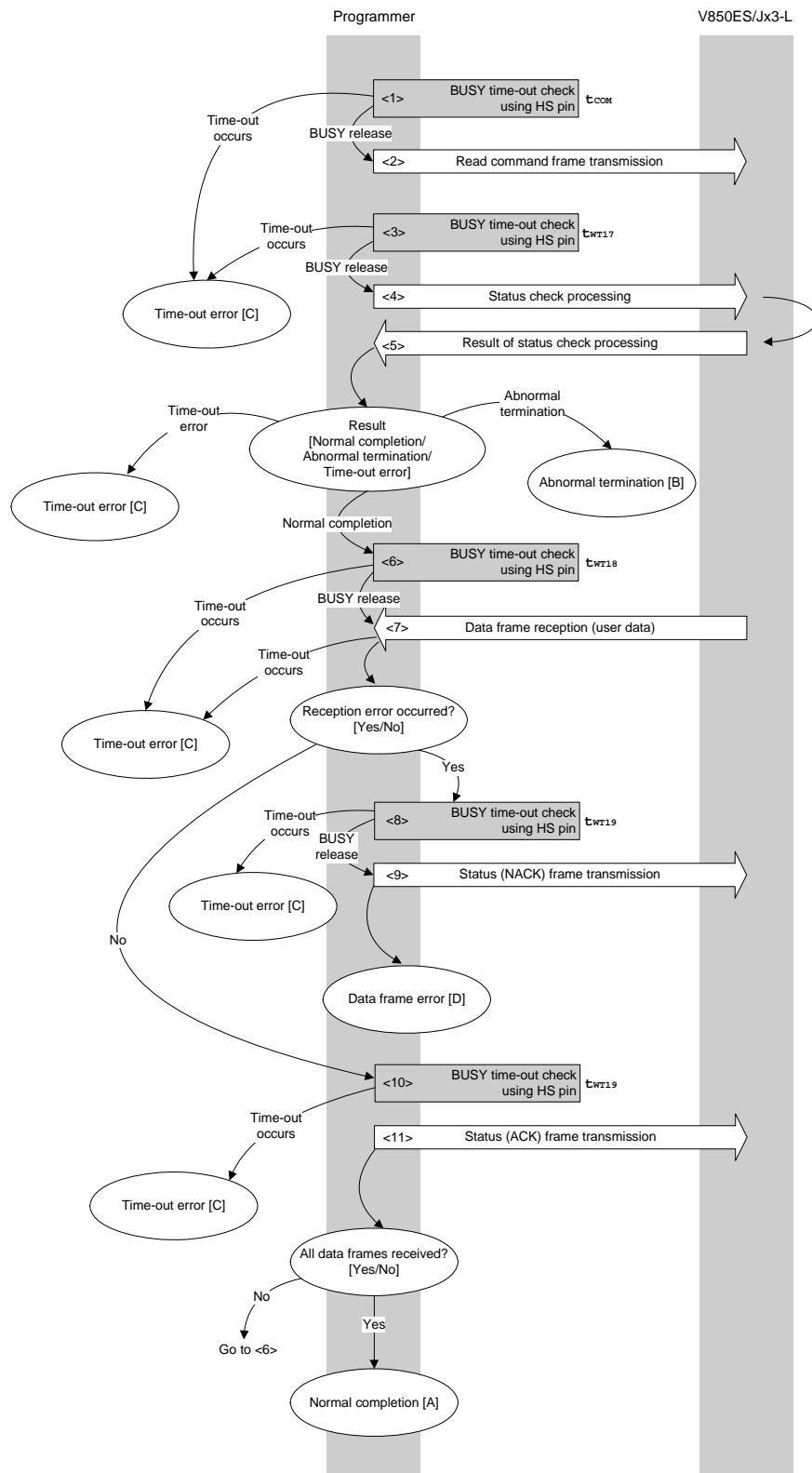

**5.16.2 Description of processing sequence**

- <1> A V850ES/Jx3-L BUSY status is checked using the HS pin.  
If a BUSY time-out occurs, a time-out error [C] is returned (time-out time  $t_{COM}$ ).
- <2> The Read command is transmitted by command frame transmission processing.
- <3> A V850ES/Jx3-L BUSY status is checked using the HS pin.  
If a BUSY time-out occurs, a time-out error [C] is returned (time-out time  $t_{WT17}$ ).
- <4> The status frame is acquired by status check processing.
- <5> The following processing is performed according to the result of status check processing.

When the processing ends normally: Proceeds to <6>.  
 When the processing ends abnormally: Abnormal termination [B]  
 When a time-out error occurs: A time-out error [C] is returned.

- <6> A V850ES/Jx3-L BUSY status is checked using the HS pin.  
If a BUSY time-out occurs, a time-out error [C] is returned (time-out time  $t_{WT18}$ ).
- <7> The data frame (user data) in the flash memory is received by data frame reception processing.

When the processing ends normally: Proceeds to <10>.  
 When an error such as checksum error occurs: Proceeds to <8>.  
 When a time-out error occurs: A time-out error [C] is returned.

- <8> A V850ES/Jx3-L BUSY status is checked using the HS pin.  
If a BUSY time-out occurs, a time-out error [C] is returned (time-out time  $t_{WT19}$ ).
- <9> The NACK frame is transmitted by data frame transmission processing.  
A data frame error [D] is returned.
- <10> A V850ES/Jx3-L BUSY status is checked using the HS pin.  
If a BUSY time-out occurs, a time-out error [C] is returned (time-out time  $t_{WT19}$ ).
- <11> The ACK frame is transmitted by data frame transmission processing.  
When reception of all data frames is completed, the normal completion status [A] is returned.  
If there still remain data frames to be received, the sequence is re-executed from <6>.

**5.16.3 Status at processing completion**

Status at Processing Completion		Status Code	Description
Normal completion [A]	Normal acknowledgment (ACK)	06H	The command was executed normally and the read data was set normally.
Abnormal termination [B]	Parameter error	05H	The specified start/end address is not the start/end address of the block.
	Checksum error	07H	The checksum of the transmitted command frame does not match.
	Protect error	10H	Read is prohibited by the security setting.
	Negative acknowledgment (NACK)	15H	Command frame data is abnormal (such as invalid data length (LEN) or no ETX).
Time-out error [C]		–	Processing timed out due to the busy status at the HS pin.
Data frame error [D]		–	The checksum of the data frame received as read data does not match.



5.16.4 Flowchart

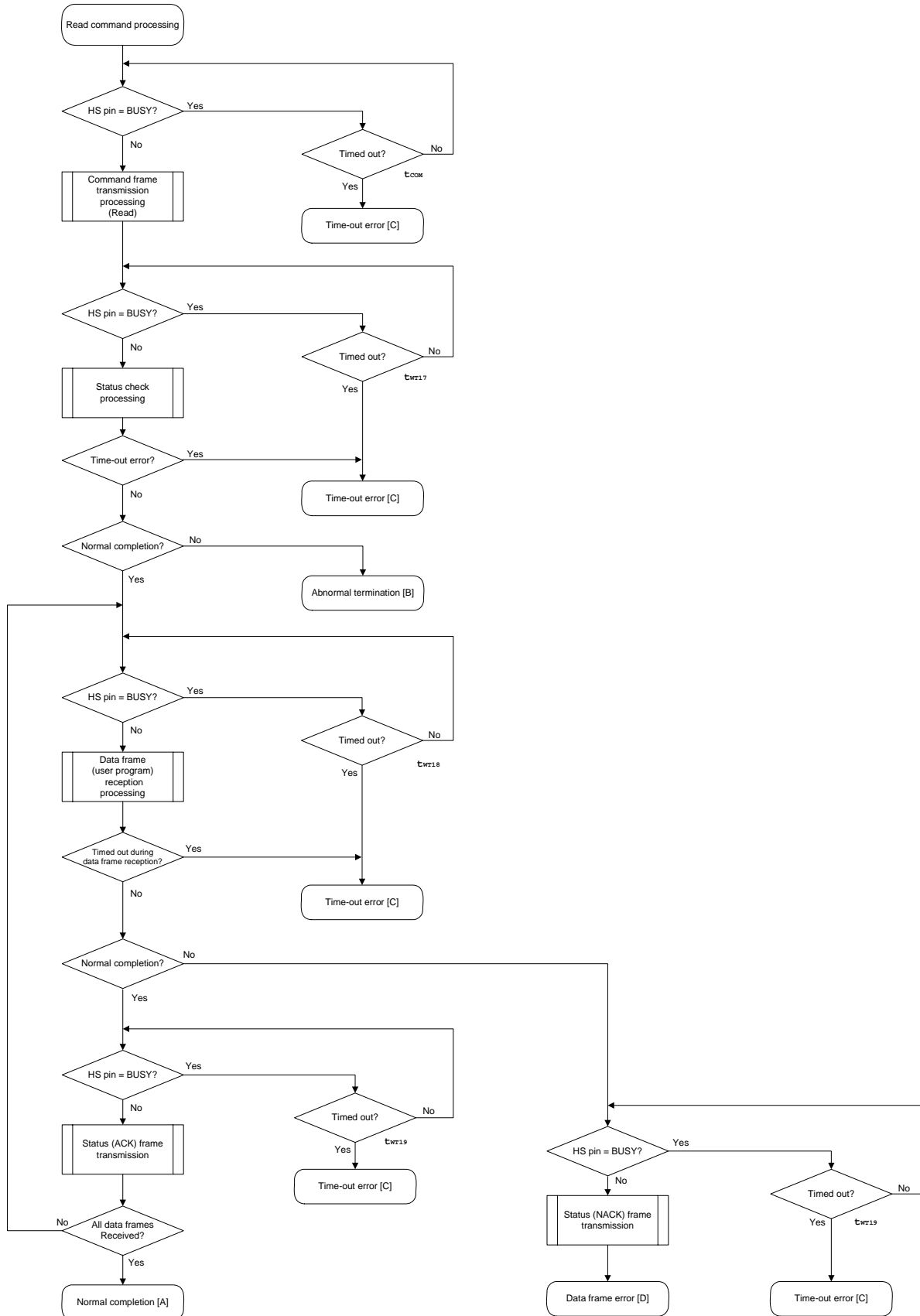

### 5.16.5 Sample program

The following shows a sample program for Read command processing.

```

/*****
/*
/* Read command
/*
/*****
u16      fl_hs_read(u32 top, u32 bottom)
{
    u16    rc;
    u32    read_head;
    u16    len;
    u8     hooter;

/*****
/*      set params
/*****
set_range_prm(fl_cmd_prm, top, bottom);          // set SAH/SAM/SAL, EAH/EAM/EAL

/*****
/*      send command & check status
/*****
if (hs_busy_to(tCOM_MAX))
    return FLC_HSTO_ERR;          // t.o. detected :case [C]

if (rc = put_cmd_hs(FL_COM_READ, 7, fl_cmd_prm))
    return rc;

if (hs_busy_to(tWT17_MAX))
    return FLC_HSTO_ERR;          // t.o. detected :case [C]

rc = fl_hs_getstatus();          // get status frame
switch(rc) {
    case    FLC_NO_ERR:          break; // continue
//    case    FLC_HSTO_ERR:    return rc;    break; // case [C]
    default:          return rc;    break; // case [B]
}

/*****
/*      receive user data
/*****
read_head = top;

while(1){

    if (hs_busy_to(tWT18_MAX))
        return FLC_HSTO_ERR;    // t.o. detected :case [C]

    rc = get_dfrm_hs(fl_rxdata_frm); // get ROM data from FLASH
    switch(rc) {
        case    FLC_NO_ERR:    break;          // continue
        case    FLC_HSTO_ERR:    return rc; break; // case [C]

        //    case    FLC_RX_DFSUM_ERR:

```

```

        default:                                // case [D]

            if (hs_busy_to(tWT19_MAX))
                return FLC_HSTO_ERR; // t.o. detected

            put_sfrm_hs(FLST_NACK);
                // send status(NACK) frame

            return rc;
            break;

    }
    if (hs_busy_to(tWT19_MAX))
        return FLC_HSTO_ERR; // t.o. detected

    put_sfrm_hs(FLST_ACK); // send status(ACK) frame

    /******
    /*      save ROM data
    /******
    if ((len = fl_rxdata_frm[OFS_LEN]) == 0) // get length
        len = 256;

    memcpy(read_buf+read_head, fl_rxdata_frm+2, len);
                // save to external RAM

    read_head += len;

    /******
    /*      end check
    /******
    hooter = fl_rxdata_frm[len + 3];
    if (hooter == FL_ETB) // end frame ?
        continue; // no
    break; // yes
}

return FLC_NO_ERR;
}

```

**CHAPTER 6 3-WIRE SERIAL I/O COMMUNICATION MODE (CSI)**

**6.1 Command Frame Transmission Processing Flowchart**

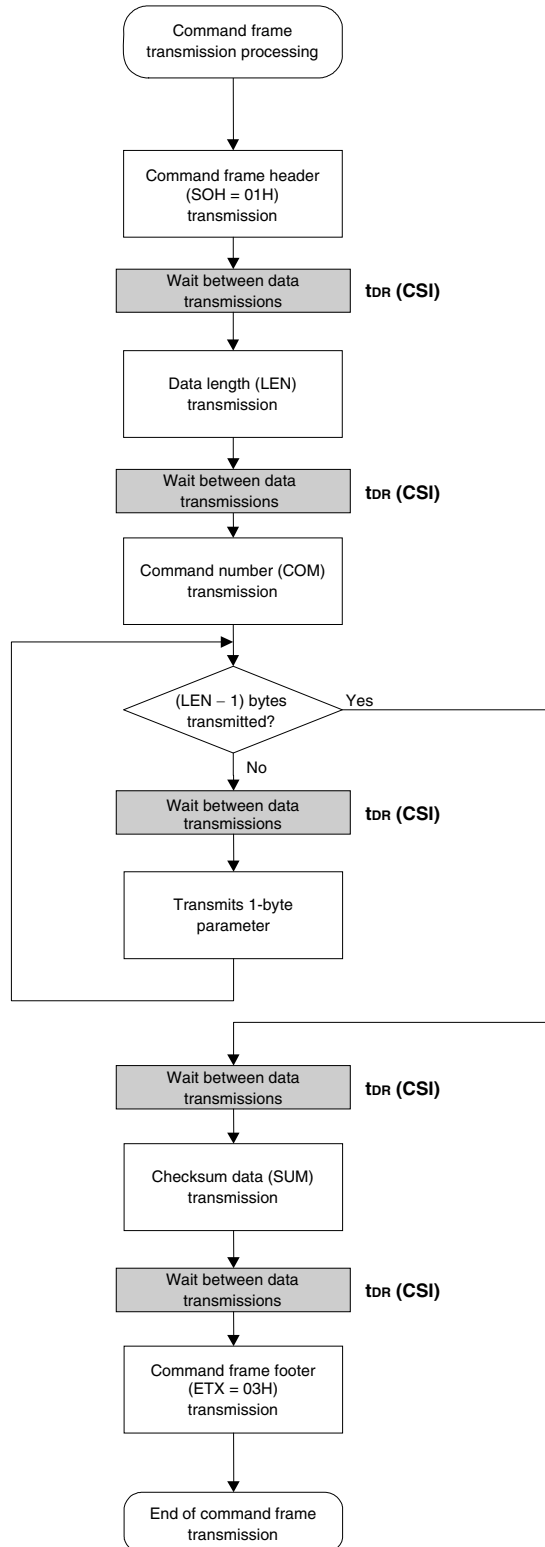

## 6.2 Data Frame Transmission Processing Flowchart

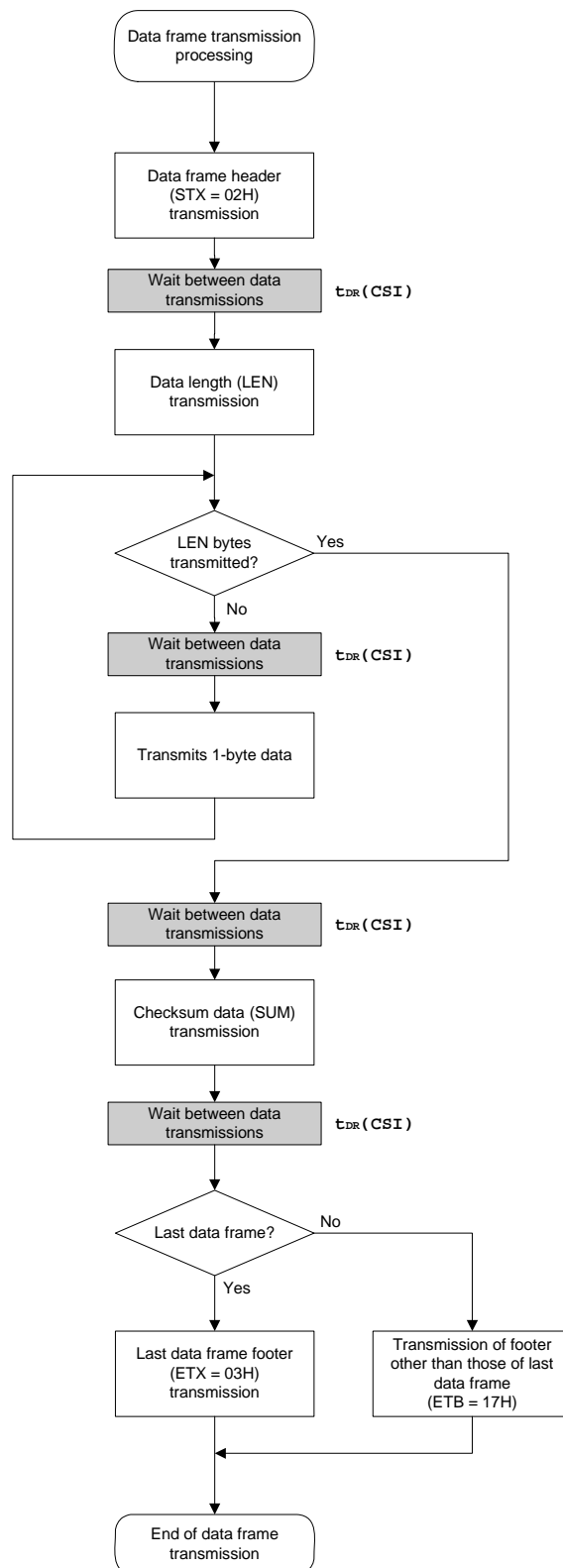

## 6.3 Data Frame Reception Processing Flowchart

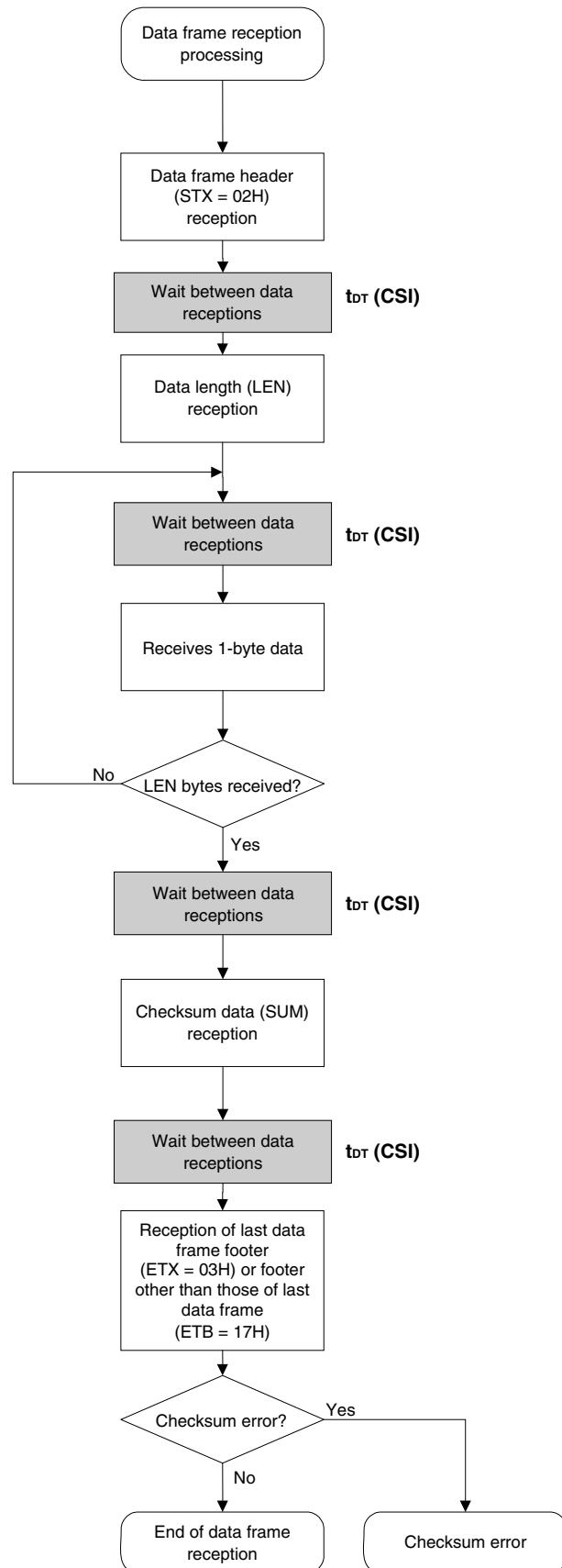

## 6.4 Status Command

### 6.4.1 Processing sequence chart

Status command processing sequence

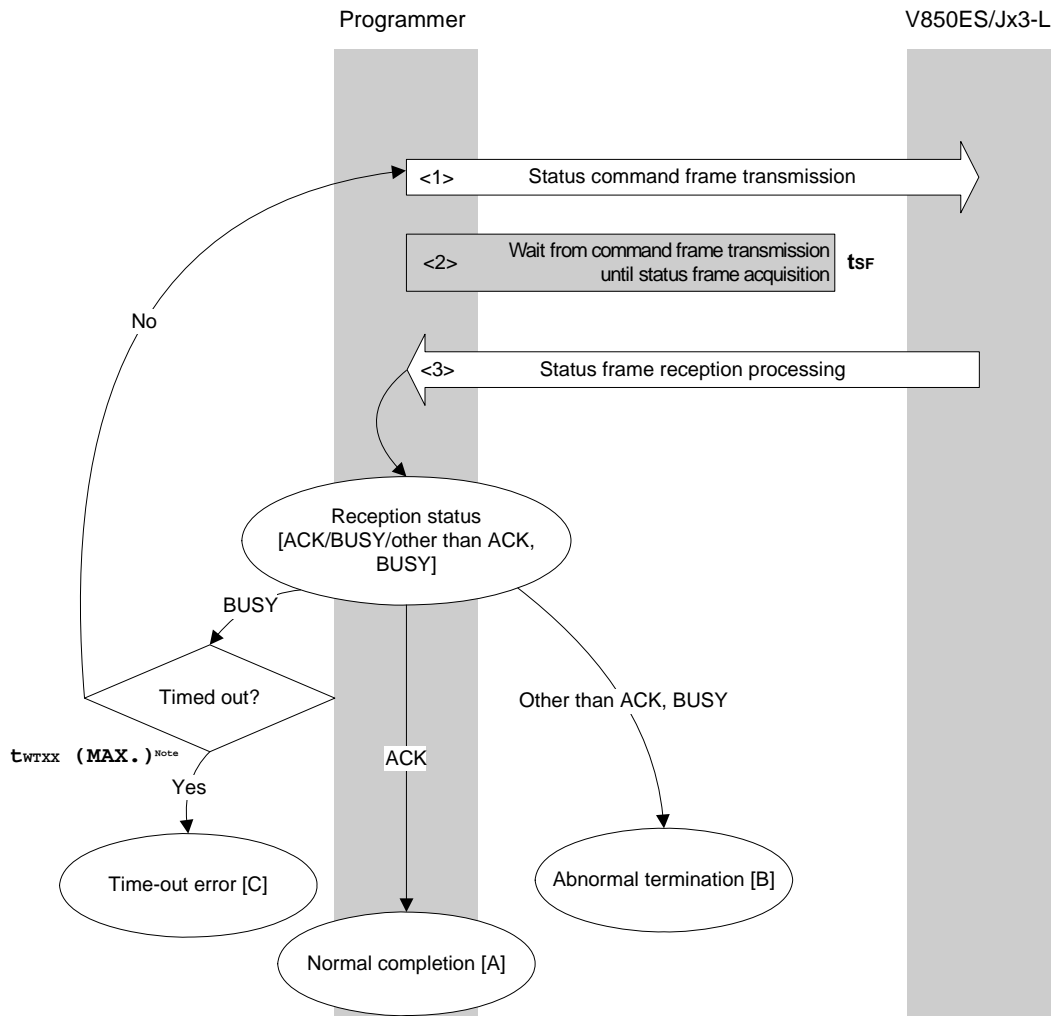

**Note** Applied specifications differ depending on the command executed.

### 6.4.2 Description of processing sequence

- <1> The Status command is transmitted by command frame transmission processing.
- <2> Waits from command transmission until status frame reception (wait time  $t_{SF}$ ).
- <3> The status code is checked.

When ST1 = ACK: Normal completion [A]

When ST1 = BUSY: A time-out check is performed. The time-out time ( $t_{WTR}$ ) is given as a parameter for this processing.  
If the processing is not timed out, the sequence is re-executed from <1>.  
If a time-out occurs, a time-out error [C] is returned.

When ST1  $\neq$  ACK, BUSY: Abnormal termination [B]

### 6.4.3 Status at processing completion

Status at Processing Completion		Status Code	Description
Normal completion [A]	Normal acknowledgment (ACK)	06H	The status frame transmitted from the V850ES/Jx3-L has been received normally.
Abnormal termination [B]	Command error	04H	An unsupported command or abnormal frame has been received.
	Parameter error	05H	Command information (parameter) is invalid.
	Checksum error	07H	The data of the frame transmitted from the programmer is abnormal.
	Write error	1CH	Write error
	MRG10 error	1AH	Erase error
	MRG11 error	1BH	Internal verify error or blank error in writing data
	Verify error	0FH	A verify error has occurred for the data of the frame transmitted from the programmer.
	Protect error	10H	An attempt was made to execute processing prohibited by the Security Set command.
	Negative acknowledgment (NACK)	15H	Negative acknowledgment
Time-out error [C]		–	Processing timed out due to the busy status at the HS pin.



## 6.4.4 Flowchart

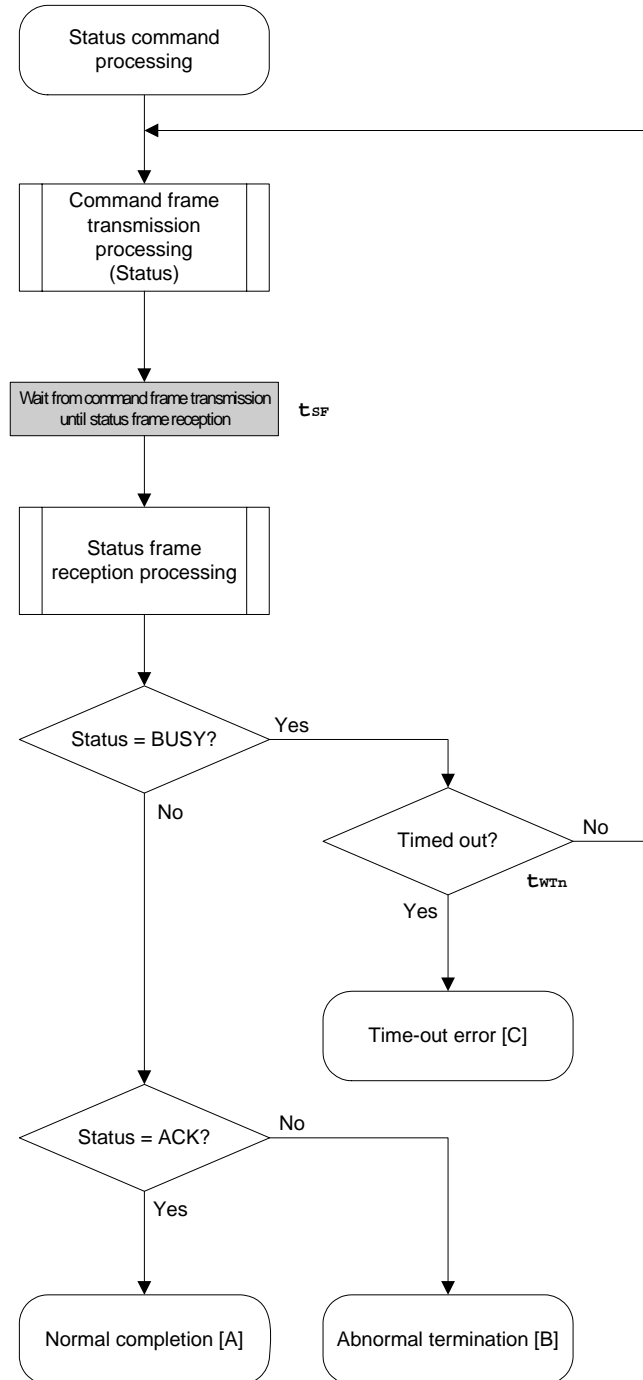

### 6.4.5 Sample program

The following shows a sample program for Status command processing.

```

/*****
/*
/* Get status command (CSI)
/*
/*****
/* [r] u16      ... decoded status or error code
/*
/* (see fl.h/fl-proto.h &
/*      definition of decode_status() in fl.c)
/*****
static u16  fl_csi_getstatus(u32 limit)
{
    u16      rc;

    start_flto(limit);

    while(1){

        put_cmd_csi(FL_COM_GET_STA, 1, fl_cmd_prm); // send "Status" command frame
        fl_wait(tSF);                               // wait

        rc = get_sfrm_csi(fl_rxddata_frm);          // get status frame

        switch(rc){
            case  FLC_BUSY:
                if (check_flto())                   // time out ?
                    return FLC_DFTO_ERR;           // Yes, time-out // case [C]
                continue;                           // No, retry

            default:
                return rc;                          // checksum error

            case  FLC_NO_ERR:
                break;                               // no error

        }

        if (fl_st1 == FLST_BUSY){                   // ST1 = BUSY
            if (check_flto())                       // time out ?
                return FLC_DFTO_ERR;               // Yes, time-out // case [C]
            continue;                               // No, retry
        }

        if (fl_rxddata_frm[OFS_LEN]==2&&fl_st1==FLST_ACK&&fl_st2==FLST_BUSY){
            if (check_flto())                       // time out ?
                return FLC_DFTO_ERR;               // Yes, time-out // case [C]
            continue;
        }

        break;                                     // ACK or other error (but BUSY)
    }

    rc = decode_status(fl_st1);                    // decode status to return code
    // switch(rc) {
    //
    //      case  FLC_NO_ERR:      return rc;      break; // case [A]
    //      default:              return rc;      break; // case [B]
    //  }

```

---

```
    return rc;  
  
}
```

## 6.5 Reset Command

### 6.5.1 Processing sequence chart

Reset command processing sequence

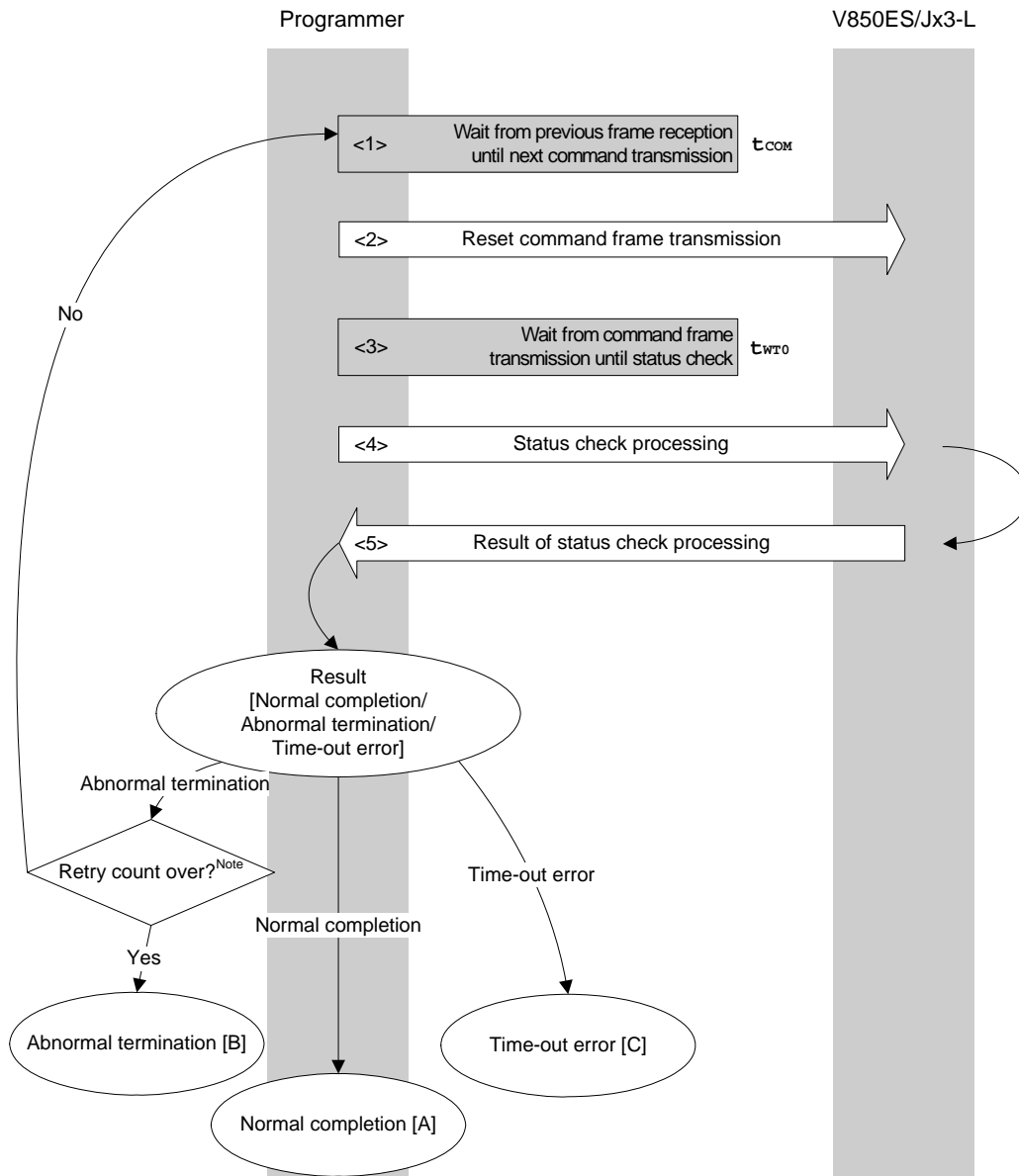

**Note** Do not exceed the retry count for the reset command transmission (up to 16 times).

### 6.5.2 Description of processing sequence

- <1> Waits from the previous frame reception until the next command transmission (wait time  $t_{COM}$ ).
- <2> The Reset command is transmitted by command frame transmission processing.
- <3> Waits from command transmission until status check processing (wait time  $t_{WTO}$ ).
- <4> The status frame is acquired by status check processing.
- <5> The following processing is performed according to the result of status check processing.

When the processing ends normally: Normal completion [A]

When the processing ends abnormally: The sequence is re-executed from <1> if the retry count is not over.

If the retry count is over, the processing ends abnormally [B].

When a time-out error occurs: A time-out error [C] is returned.

### 6.5.3 Status at processing completion

Status at Processing Completion		Status Code	Description
Normal completion [A]	Normal acknowledgment (ACK)	06H	The command was executed normally and synchronization between the programmer and the V850ES/Jx3-L has been established.
Abnormal termination [B]	Checksum error	07H	The checksum of the transmitted command frame does not match.
	Negative acknowledgment (NACK)	15H	<ul style="list-style-type: none"> <li>• A command other than the Status command was received during processing.</li> <li>• Command frame data is abnormal (such as invalid data length (LEN) or no ETX).</li> </ul>
Time-out error [C]		–	Status check processing timed out.

## 6.5.4 Flowchart

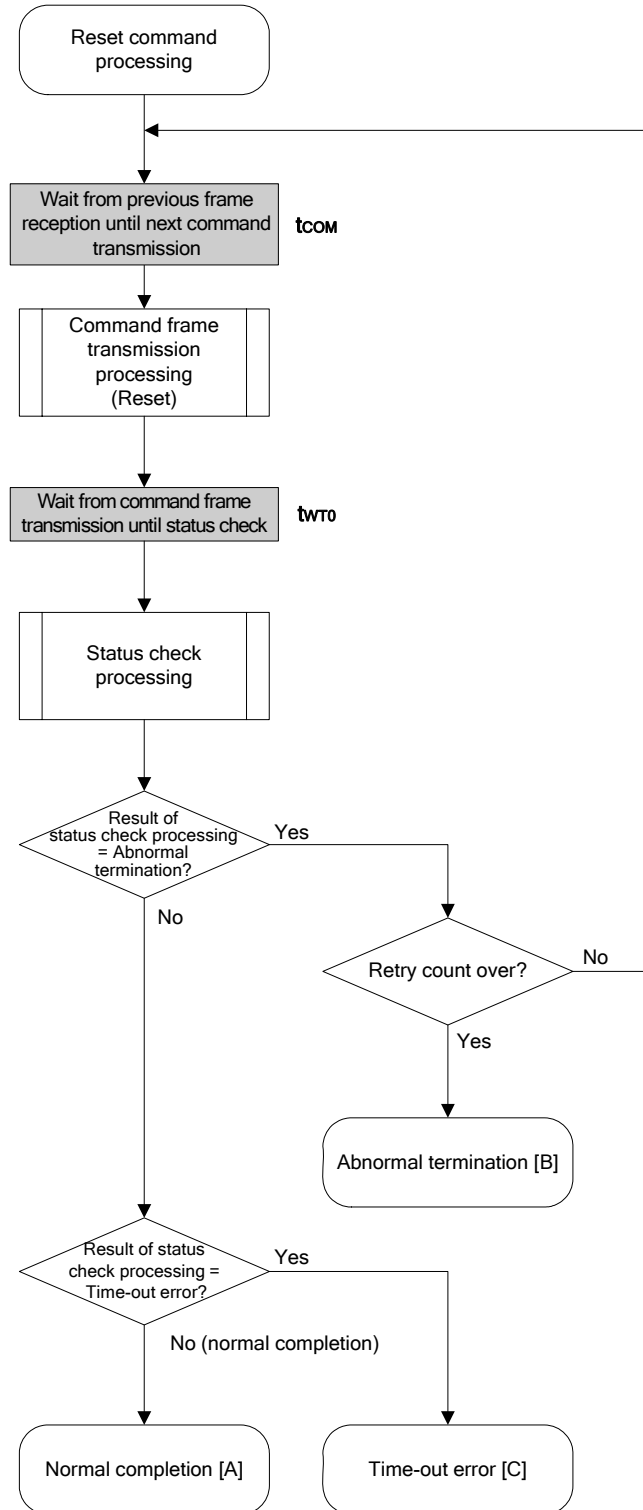

### 6.5.5 Sample program

The following shows a sample program for Reset command processing.

```

/*****
/*
/* Reset command (CSI)
/*
/*****
/* [r] u16      ... error code
/*****
u16      fl_csi_reset(void)
{
    u16    rc;
    u32    retry;

    for (retry = 0; retry < tRS; retry++){

        fl_wait(tCOM);          // wait before sending command frame

        put_cmd_csi(FL_COM_RESET, 1, fl_cmd_prm); // send "Reset" command frame

        fl_wait(tWT0);

        rc = fl_csi_getstatus(tWT0_MAX); // get status

        if (rc == FLC_DFTO_ERR) // timeout error ?
            break; // yes // case [C]
        if (rc == FLC_ACK) // Ack ?
            break; // yes // case [A]
        //continue; // case [B] (if exit from loop)
    }
    // switch(rc) {
    //
    //     case FLC_NO_ERR: return rc; break; // case [A]
    //     case FLC_DFTO_ERR: return rc; break; // case [C]
    //     default: return rc; break; // case [B]
    // }
    return rc;
}

```

## 6.6 Oscillating Frequency Set Command

### 6.6.1 Processing sequence chart

Oscillating Frequency Set command processing sequence

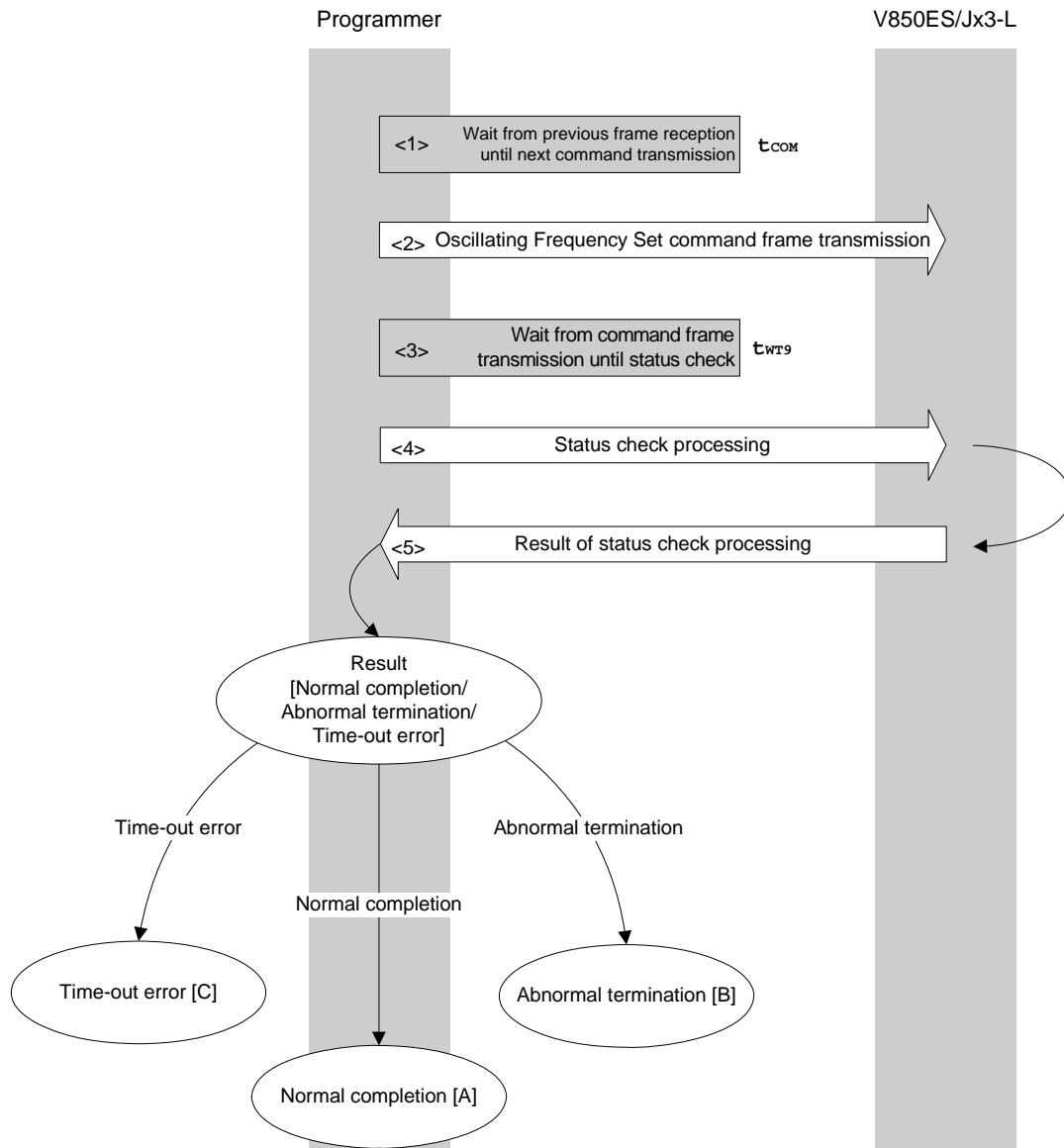



**6.6.2 Description of processing sequence**

- <1> Waits from the previous frame reception until the next command transmission (wait time  $t_{COM}$ ).
- <2> The Oscillating Frequency Set command is transmitted by command frame transmission processing.
- <3> Waits from command transmission until status check processing (wait time  $t_{WT9}$ ).
- <4> The status frame is acquired by status check processing.
- <5> The following processing is performed according to the result of status check processing.

When the processing ends normally: Normal completion [A]

When the processing ends abnormally: Abnormal termination [B]

When a time-out error occurs: A time-out error [C] is returned.

**6.6.3 Status at processing completion**

Status at Processing Completion		Status Code	Description
Normal completion [A]	Normal acknowledgment (ACK)	06H	The command was executed normally and the operating frequency was correctly set to the V850ES/Jx3-L.
Abnormal termination [B]	Parameter error	05H	The oscillation frequency value is out of range.
	Checksum error	07H	The checksum of the transmitted command frame does not match.
	Negative acknowledgment (NACK)	15H	<ul style="list-style-type: none"> <li>• A command other than the Status command was received during processing.</li> <li>• Command frame data is abnormal (such as invalid data length (LEN) or no ETX).</li> </ul>
Time-out error [C]		–	The status frame was not received within the specified time.

## 6.6.4 Flowchart

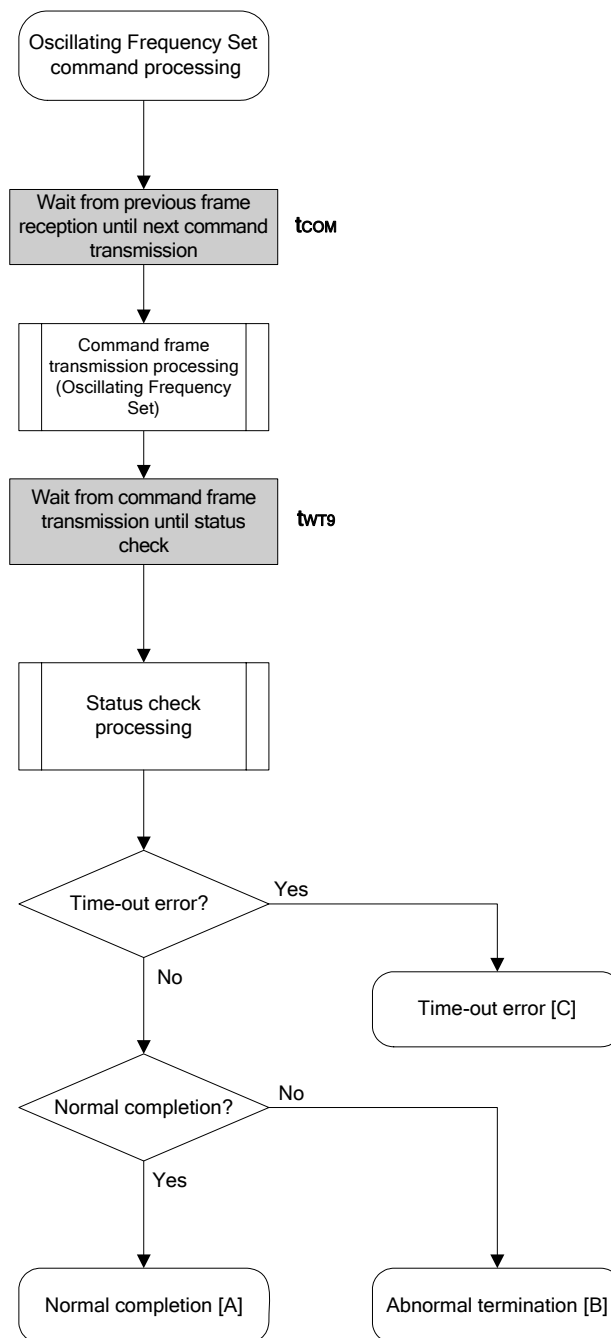

### 6.6.5 Sample program

The following shows a sample program for Oscillating Frequency Set command processing.

```

/*****
/*
/* Set Flash device clock value command (CSI)
/*
/*
/*****
/* [i] u8 clk[4] ... frequency data(D1-D4)
/* [r] u16 ... error code
/*****
u16 fl_csi_setclk(u8 clk[])
{
    u16 rc;

    fl_cmd_prm[0] = clk[0]; // "D01"
    fl_cmd_prm[1] = clk[1]; // "D02"
    fl_cmd_prm[2] = clk[2]; // "D03"
    fl_cmd_prm[3] = clk[3]; // "D04"

    fl_wait(tCOM); // wait before sending command frame

    put_cmd_csi(FL_COM_SET_OSC_FREQ, 5, fl_cmd_prm);
    // send "Oscillation Frequency Set" command

    fl_wait(tWT9);

    rc = fl_csi_getstatus(tWT9_MAX); // get status frame
    // switch(rc) {
    //
    //     case FLC_NO_ERR: return rc; break; // case [A]
    //     case FLC_DFTO_ERR: return rc; break; // case [C]
    //     default: return rc; break; // case [B]
    // }
    return rc;
}

```

## 6.7 Chip Erase Command

### 6.7.1 Processing sequence chart

Chip Erase command processing sequence

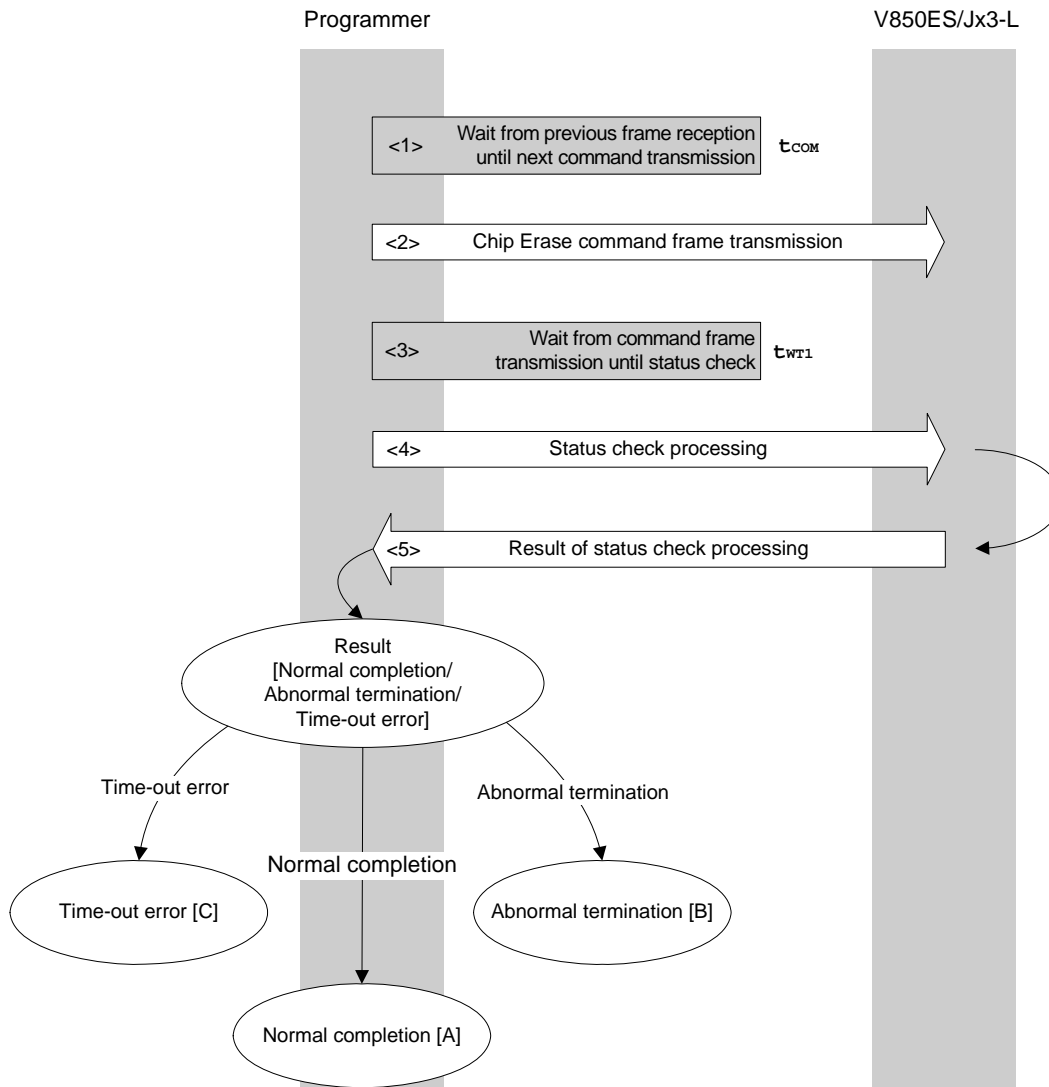

### 6.7.2 Description of processing sequence

- <1> Waits from the previous frame reception until the next command transmission (wait time  $t_{COM}$ ).
- <2> The Chip Erase command is transmitted by command frame transmission processing.
- <3> Waits from command transmission until status check processing (wait time  $t_{WT1}$ ).
- <4> The status frame is acquired by status check processing.
- <5> The following processing is performed according to the result of status check processing.

When the processing ends normally: Normal completion [A]

When the processing ends abnormally: Abnormal termination [B]

When a time-out error occurs: A time-out error [C] is returned.

### 6.7.3 Status at processing completion

Status at Processing Completion		Status Code	Description
Normal completion [A]	Normal acknowledgment (ACK)	06H	The command was executed normally and chip erase was performed normally.
Abnormal termination [B]	Checksum error	07H	The checksum of the transmitted command frame does not match.
	Protect error	10H	Chip erase and boot block rewrite are prohibited by the security setting.
	Negative acknowledgment (NACK)	15H	<ul style="list-style-type: none"> <li>• A command other than the Status command was received during processing.</li> <li>• Command frame data is abnormal (such as invalid data length (LEN) or no ETX).</li> </ul>
	WRITE error	1CH	An erase error has occurred.
	MRG10 error	1AH	
	MRG11 error	1BH	
Time-out error [C]		–	The status frame was not received within the specified time.

## 6.7.4 Flowchart

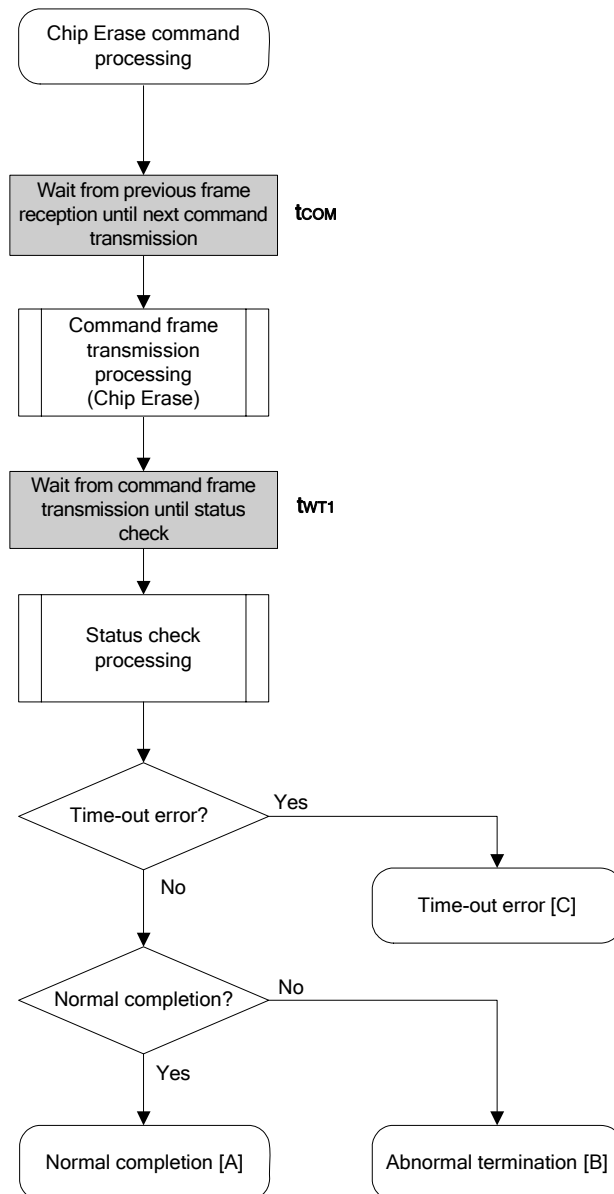

### 6.7.5 Sample program

The following shows a sample program for Chip Erase command processing.

```

/*****
/*
/* Erase all(chip) command (CSI)
/*
/*****
/* [r] u16      ... error code
/*****
u16      fl_csi_erase_all(void)
{
    u16      rc;

    fl_wait(tCOM);                // wait before sending command frame

    put_cmd_csi(FL_COM_ERASE_CHIP, 1, fl_cmd_prm); // send "Chip Erase" command

    fl_wait(tWT1);

    rc = fl_csi_getstatus(tWT1_MAX);        // get status frame
//    switch(rc) {
//
//        case    FLC_NO_ERR:                return rc;    break; // case [A]
//        case    FLC_DFTO_ERR:              return rc;    break; // case [C]
//        default:                            return rc;    break; // case [B]
//    }
    return rc;
}

```

## 6.8 Block Erase Command

### 6.8.1 Processing sequence chart

Block Erase command processing sequence

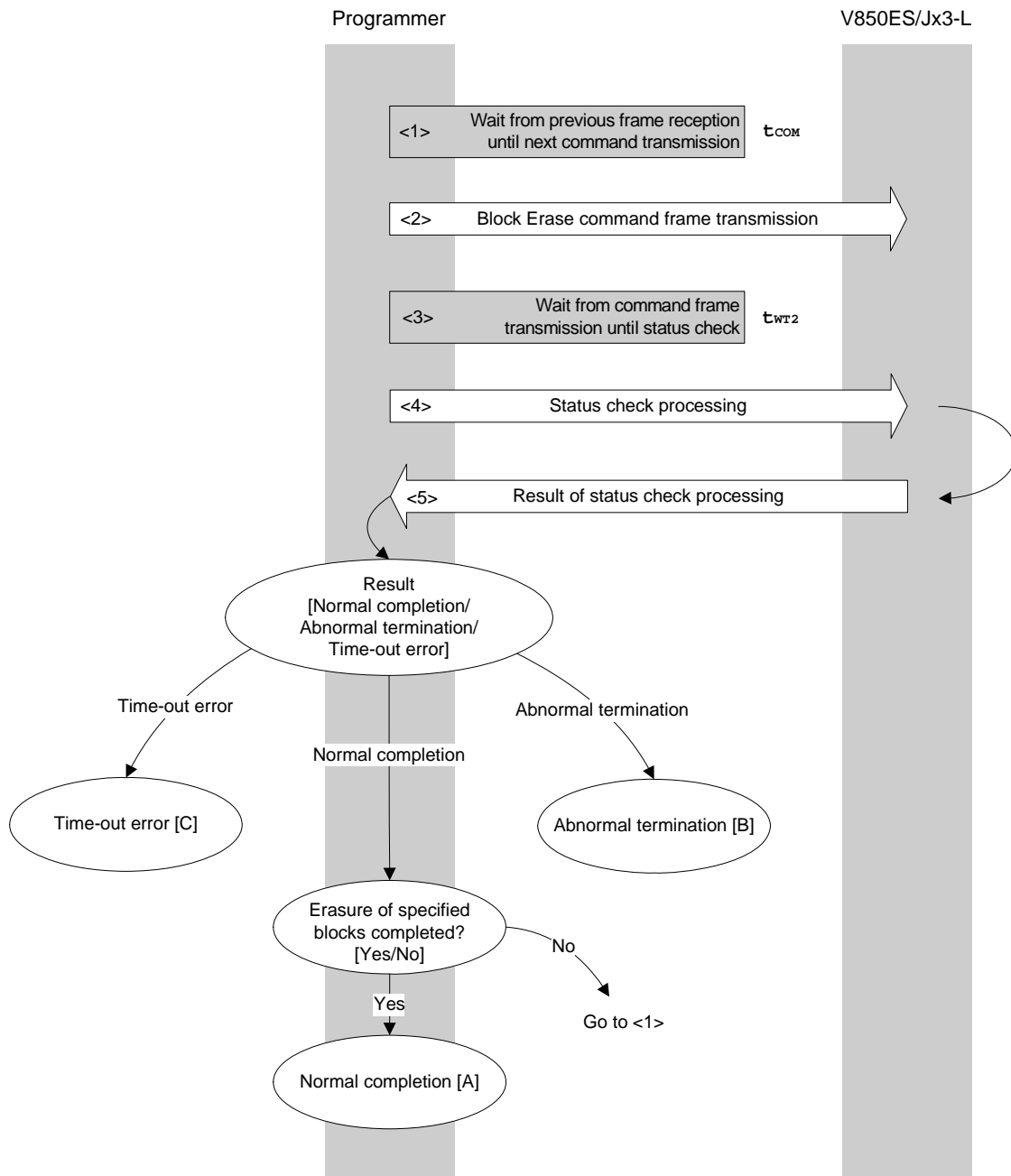



### 6.8.2 Description of processing sequence

- <1> Waits from the previous frame reception until the next command transmission (wait time  $t_{COM}$ ).
- <2> The Block Erase command is transmitted by command frame transmission processing.
- <3> Waits until status frame acquisition (wait time  $t_{WT2}$ ).
- <4> The status frame is acquired by status check processing.
- <5> The following processing is performed according to the result of status check processing.

When the processing ends normally: When the block erase for all of the specified blocks is not yet completed, processing changes the block number and re-executes the sequence from <1>.

When the block erase for all of the specified blocks is completed, the processing ends normally [A].

When the processing ends abnormally: Abnormal termination [B]

When a time-out error occurs: A time-out error [C] is returned.

### 6.8.3 Status at processing completion

Status at Processing Completion		Status Code	Description
Normal completion [A]	Normal acknowledgment (ACK)	06H	The command was executed normally and block erase was performed normally.
Abnormal termination [B]	Parameter error	05H	The specified start/end address is not the start/end address of the block.
	Checksum error	07H	The checksum of the transmitted command frame does not match.
	Protect error	10H	Any one of write, block erase, or chip erase is prohibited by the security setting. Or, boot block rewrite is prohibited by the security setting because specified range includes the boot area.
	Negative acknowledgment (NACK)	15H	<ul style="list-style-type: none"> <li>• A command other than the Status command was received during processing.</li> <li>• Command frame data is abnormal (such as invalid data length (LEN) or no ETX).</li> </ul>
	MRG10 error	1AH	An erase error has occurred.
Time-out error [C]		–	The status frame was not received within the specified time.

## 6.8.4 Flowchart

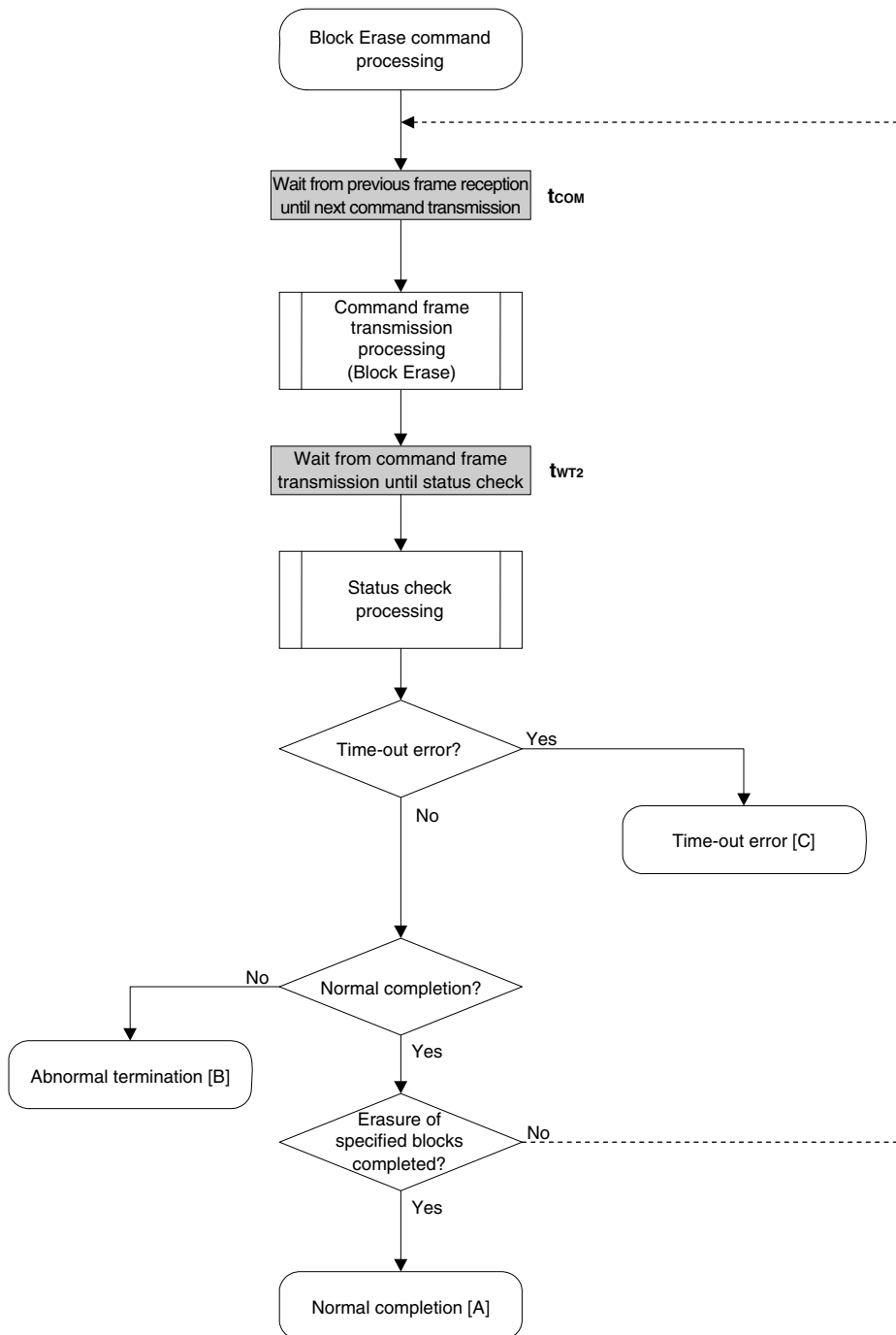

### 6.8.5 Sample program

The following shows a sample program for Block Erase command processing for one block.

```

/*****
/*
/* Erase block command (CSI)
/*
/*****
/* [i] u16 sblk ... start block number
/* [i] u16 eblk ... end block number
/* [r] u16 ... error code
/*****
u16          fl_csi_erase_blk(u16 sblk, u16 eblk)
{
    u16      rc;
    u32      wt2, wt2_max;
    u32      top, bottom;

    top = get_top_addr(sblk);          // get start address of start block
    bottom = get_bottom_addr(eblk);    // get end address of end block

    set_range_prm(fl_cmd_prm, top, bottom); // set SAH/SAM/SAL, EAH/EAM/EAL

    wt2      = make_wt2(sblk, eblk);    // get tWT2(Min)
    wt2_max = make_wt2_max(sblk, eblk); // get tWT2(Max)

    fl_wait(tCOM);                    // wait before sending command frame

    put_cmd_csi(FL_COM_ERASE_BLOCK, 7, fl_cmd_prm); // send "Block Erase" command

    fl_wait(wt2);

    rc = fl_csi_getstatus(wt2_max); // get status frame
    // switch(rc) {
    //
    //     case   FLC_NO_ERR:      return rc;    break; // case [A]
    //     case   FLC_DFTO_ERR:   return rc;    break; // case [C]
    //     default:                return rc;    break; // case [B]
    // }
    return rc;
}

```

## 6.9 Programming Command

### 6.9.1 Processing sequence chart

Programming command processing sequence

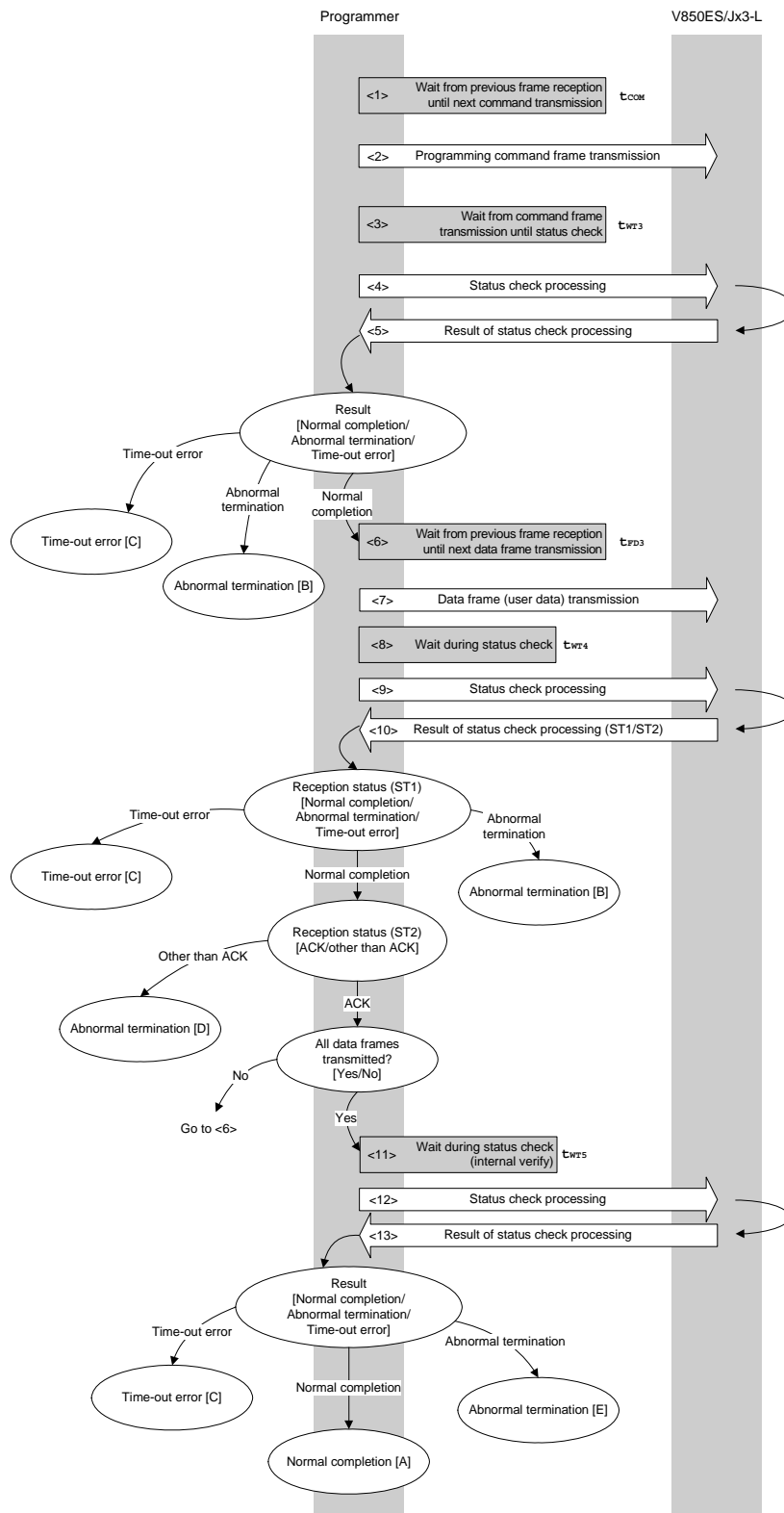

**6.9.2 Description of processing sequence**

- <1> Waits from the previous frame reception until the next command transmission (wait time  $t_{COM}$ ).
- <2> The Programming command is transmitted by command frame transmission processing.
- <3> Waits from command transmission until status check processing (wait time  $t_{WT3}$ ).
- <4> The status frame is acquired by status check processing.
- <5> The following processing is performed according to the result of status check processing.

When the processing ends normally: Proceeds to <6>.  
 When the processing ends abnormally: Abnormal termination [B]  
 When a time-out error occurs: A time-out error [C] is returned.

- <6> Waits until the next data frame transmission (wait time  $t_{FD3}$ ).
- <7> User data to be written to the V850ES/Jx3-L flash memory is transmitted by data frame transmission processing.
- <8> Waits from data frame (user data) transmission until status check processing (wait time  $t_{WT4}$ ).
- <9> The status frame is acquired by status check processing.
- <10> The following processing is performed according to the result of status check processing (status code (ST1/ST2)) (also refer to the processing sequence chart and flowchart).

When ST1 = abnormal termination: Abnormal termination [B]  
 When ST1 = time-out error: A time-out error [C] is returned.  
 When ST1 = normal completion: The following processing is performed according to the ST2 value.

- When ST2  $\neq$  ACK: Abnormal termination [D]
- When ST2 = ACK: Proceeds to <11> when transmission of all of the user data is completed.  
 If there still remain user data to be transmitted, the processing re-executes the sequence from <6>.

- <11> Waits until status check processing (time-out time  $t_{WT5}$ ).
- <12> The status frame is acquired by status check processing.
- <13> The following processing is performed according to the result of status check processing.

When the processing ends normally: Normal completion [A]  
 (Indicating that the internal verify check has performed normally after completion of write)  
 When the processing ends abnormally: Abnormal termination [E]  
 (Indicating that the internal verify check has not performed normally after completion of write)  
 When a time-out error occurs: A time-out error [C] is returned.

**6.9.3 Status at processing completion**

Status at Processing Completion		Status Code	Description
Normal completion [A]	Normal acknowledgment (ACK)	06H	The command was executed normally and the user data was written normally.
Abnormal termination [B]	Parameter error	05H	The specified start/end address is not the start/end address of the block.
	Checksum error	07H	The checksum of the transmitted command frame or data frame does not match.
	Protect error	10H	Write is prohibited by the security setting. Or, boot block rewrite is prohibited by the security setting because specified range includes the boot area.
	Negative acknowledgment (NACK)	15H	<ul style="list-style-type: none"> <li>• A command other than the Status command was received during processing.</li> <li>• Command frame data is abnormal (such as invalid data length (LEN) or no ETX).</li> </ul>
Time-out error [C]		–	The status frame was not received within the specified time.
Abnormal termination [D]	WRITE error	1CH	A write error has occurred.
Abnormal termination [E]	MRG11 error	1BH	An internal verify error has occurred.

6.9.4 Flowchart

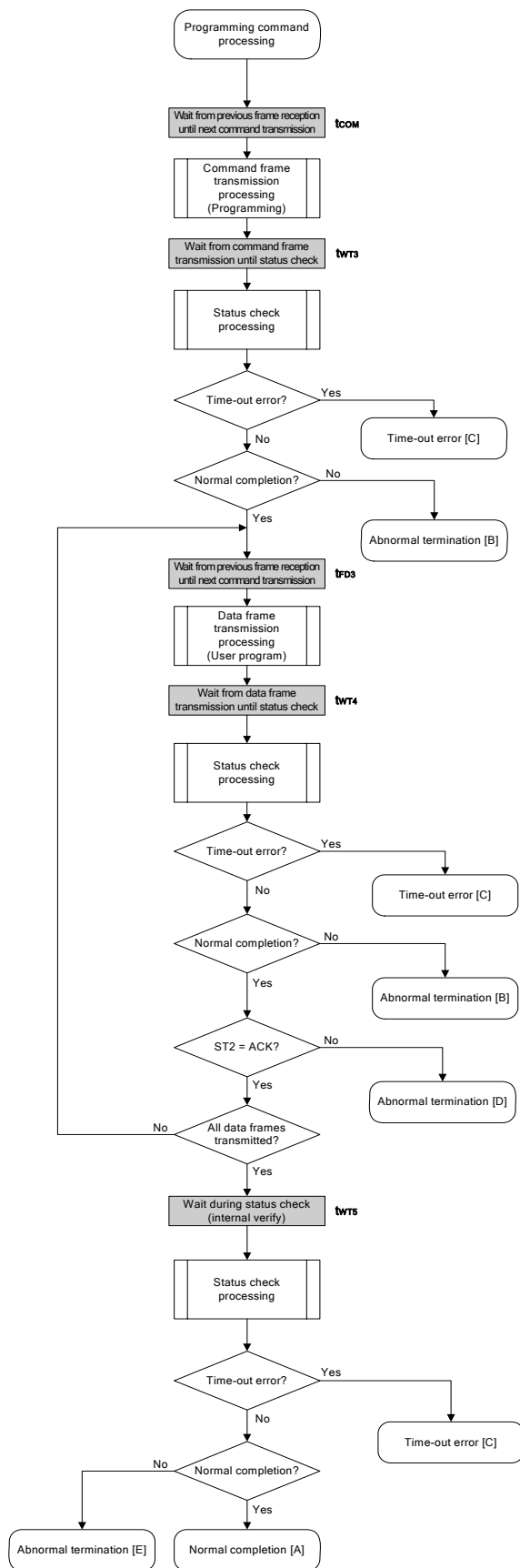

### 6.9.5 Sample program

The following shows a sample program for Programming command processing.

```

/*****
/*
/* Write command (CSI)
/*
/*
/*****
/* [i] u32 top ... start address
/* [i] u32 bottom ... end address
/* [r] ul6 ... error code
/*****
ul6          fl_csi_write(u32 top, u32 bottom)
{
    ul6      rc;
    u32      send_head, send_size;
    bool     is_end;
    u32      wt5, wt5_max;

    // set params
    set_range_prm(fl_cmd_prm, top, bottom);          // set SAH/SAM/SAL, EAH/EAM/EAL
    wt5      = make_wt5(get_block_num(top, bottom));
    wt5_max = make_wt5_max(get_block_num(top, bottom));

    /*****
    /*      send command & check status
    /*****

    fl_wait(tCOM);
    put_cmd_csi(FL_COM_WRITE, 7, fl_cmd_prm);        // send "Programming" command
    fl_wait(tWT3);

    rc = fl_csi_getstatus(tWT3_MAX);                 // get status frame
    switch(rc) {
        case FLC_NO_ERR:                            break; // continue
        // case FLC_DFTO_ERR: return rc; break; // case [C]
        default: return rc; break; // case [B]
    }

    /*****
    /*      send user data
    /*****
    send_head = top;

    while(1){
        if ((bottom - send_head) > 256){            // rest size > 256 ?
            is_end = false;                          // yes, not end frame
            send_size = 256;                          // transmit size = 256 byte
        }
        else{
            is_end = true;
            send_size = bottom - send_head + 1;
            // transmit size = (bottom - send_head)+1
byte
        }

        memcpy(fl_txdata_frm, rom_buf+send_head, send_size);
            // set data frame payload

```



```

        send_head += send_size;

        fl_wait(tFD3);                // wait before sending data frame
        put_dfrm_csi(send_size, fl_txdata_frm, is_end);
                                        // send data frame (user data)
        fl_wait(tWT4);                // wait

        rc = fl_csi_getstatus(tWT4_MAX); // get status frame
        switch(rc) {
            case FLC_NO_ERR:            break; // continue
            // case FLC_DFTO_ERR: return rc; break; // case [C]
            default:                    return rc; break; // case [B]
        }
        if (fl_st2 != FLST_ACK){        // ST2 = ACK ?
            rc = decode_status(fl_st2); // No
            return rc;                  // case [D]
        }

        if (is_end)                    // send all user data ?
            break;                       // yes
        //continue;

    }
    /*****
    /*      Check internally verify      */
    /*****/

    fl_wait(wt5);                       // wait

    rc = fl_csi_getstatus(wt5_max); // get status frame
    // switch(rc) {
    //     case FLC_NO_ERR: return rc; break; // case [A]
    //     case FLC_DFTO_ERR: return rc; break; // case [C]
    //     default: return rc; break; // case [E]
    // }
    return rc;
}

```

## 6.10 Verify Command

### 6.10.1 Processing sequence chart

Verify command processing sequence

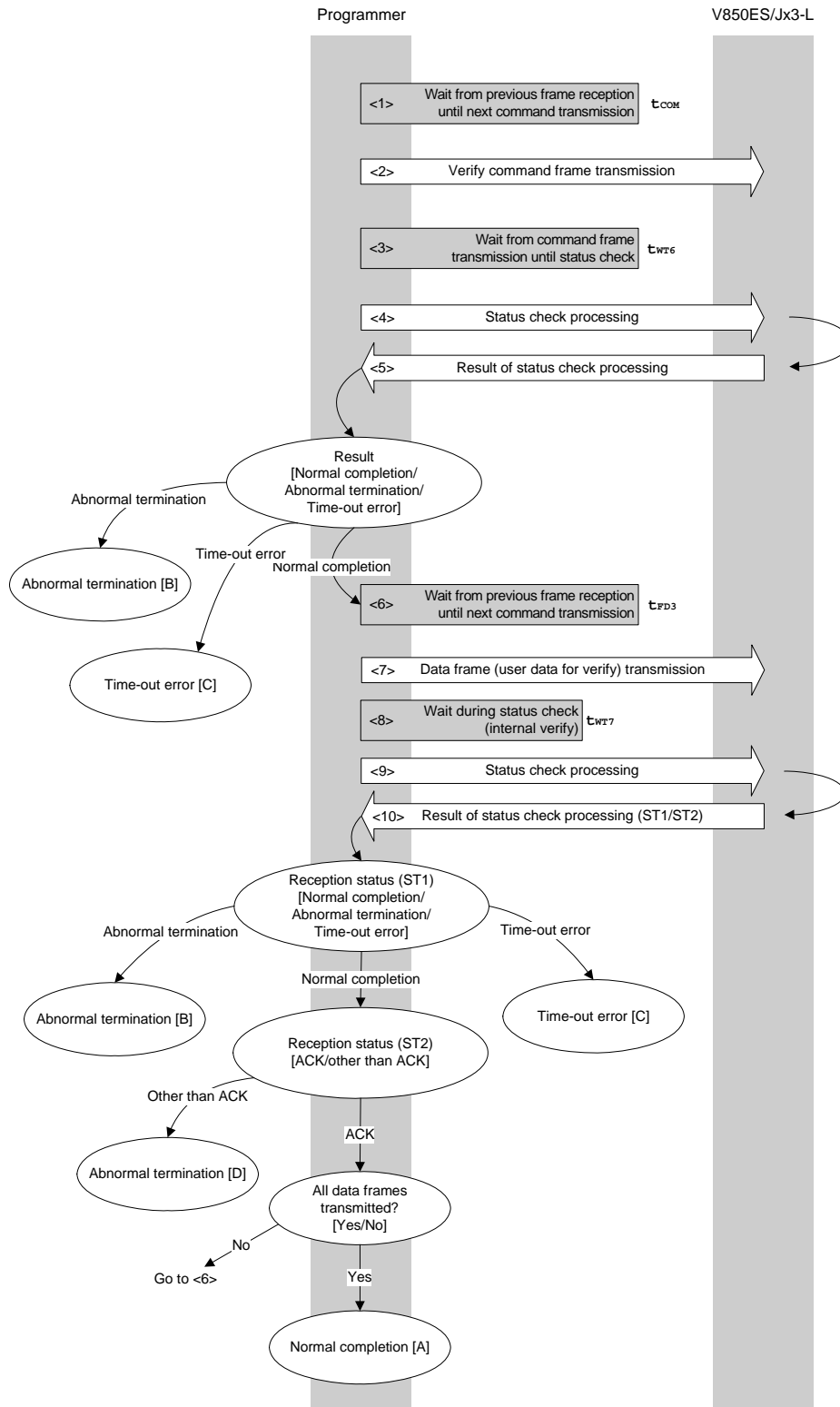

### 6.10.2 Description of processing sequence

- <1> Waits from the previous frame reception until the next command transmission (wait time  $t_{COM}$ ).
- <2> The Verify command is transmitted by command frame transmission processing.
- <3> Waits from command transmission until status check processing (wait time  $t_{WT6}$ ).
- <4> The status frame is acquired by status check processing.
- <5> The following processing is performed according to the result of status check processing.

When the processing ends normally: Proceeds to <6>.  
 When the processing ends abnormally: Abnormal termination [B]  
 When a time-out error occurs: A time-out error [C] is returned.

- <6> Waits from the previous frame reception until the next data frame transmission (wait time  $t_{FD3}$ ).
- <7> User data for verifying is transmitted by data frame transmission processing.
- <8> Waits from data frame transmission until status check processing (wait time  $t_{WT7}$ ).
- <9> The status frame is acquired by status check processing.
- <10> The following processing is performed according to the result of status check processing (status code (ST1/ST2)) (also refer to the processing sequence chart and flowchart).

When ST1 = abnormal termination: Abnormal termination [B]  
 When ST1 = time-out error: A time-out error [C] is returned.  
 When ST1 = normal completion: The following processing is performed according to the ST2 value.

- When ST2  $\neq$  ACK: Abnormal termination [D]
- When ST2 = ACK: If transmission of all data frames is completed, the processing ends normally [A].  
 If there still remain data frames to be transmitted, the processing re-executes the sequence from <6>.

### 6.10.3 Status at processing completion

Status at Processing Completion		Status Code	Description
Normal completion [A]	Normal acknowledgment (ACK)	06H	The command was executed normally and the verify was completed normally.
Abnormal termination [B]	Parameter error	05H	The specified start/end address is not the start/end address of the block.
	Checksum error	07H	The checksum of the transmitted command frame or data frame does not match.
	Negative acknowledgment (NACK)	15H	<ul style="list-style-type: none"> <li>• A command other than the Status command was received during processing.</li> <li>• Command frame data is abnormal (such as invalid data length (LEN) or no ETX).</li> </ul>
Time-out error [C]		–	The status frame was not received within the specified time.
Abnormal termination [D]	Verify error	0FH	The verify has failed, or another error has occurred.

6.10.4 Flowchart

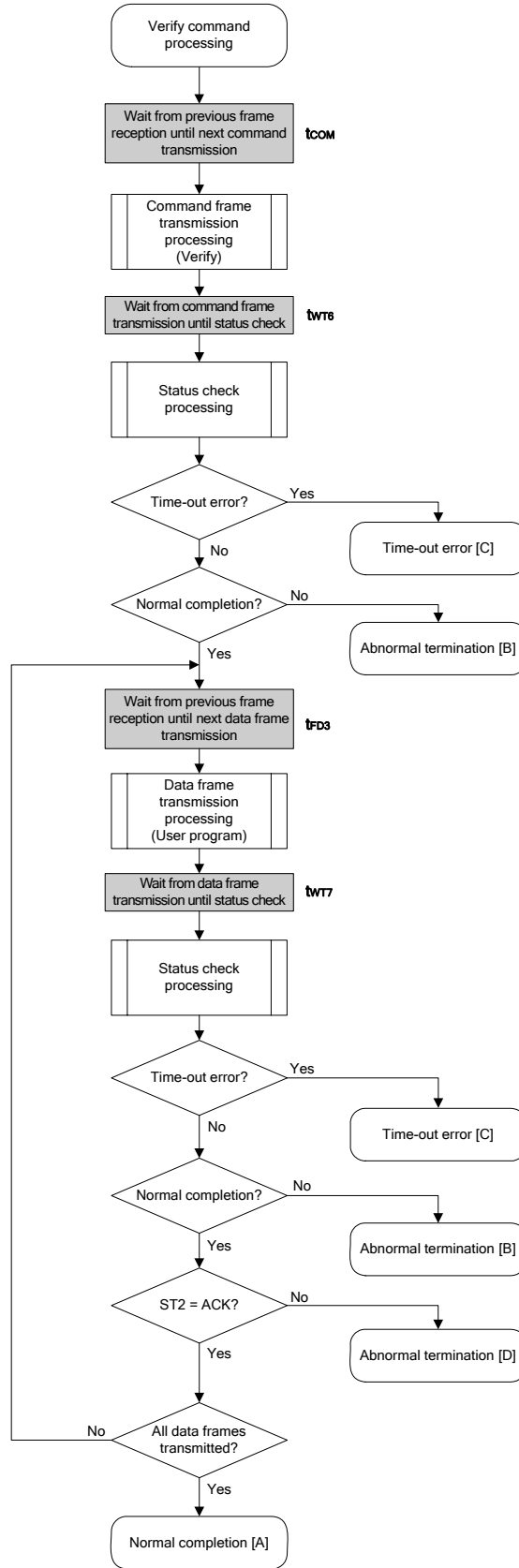

### 6.10.5 Sample program

The following shows a sample program for Verify command processing.

```

/*****/
/*                                                                    */
/* Verify command (CSI)                                              */
/*                                                                    */
/*****/
/* [i] u32 top          ... start address                            */
/* [i] u32 bottom       ... end address                             */
/* [r] u16              ... error code                             */
/*****/
u16          fl_csi_verify(u32 top, u32 bottom, u8 *buf)
{
    u16      rc;
    u32      send_head, send_size;
    bool     is_end;

    // set params
    set_range_prm(fl_cmd_prm, top, bottom);          // set SAH/SAM/SAL, EAH/EAM/EAL

    /*****/
    /*      send command & check status                            */
    /*****/
    fl_wait(tCOM);
    put_cmd_csi(FL_COM_VERIFY, 7, fl_cmd_prm);      // send "Verify" command
    fl_wait(tWT6);

    rc = fl_csi_getstatus(tWT6_MAX);                // get status frame
    switch(rc) {
        case   FLC_NO_ERR:                                break; // continue
        // case   FLC_DFTO_ERR:    return rc;    break; // case [C]
        default:                                return rc;    break; // case [B]
    }

    /*****/
    /*      send user data                                        */
    /*****/
    send_head = top;

    while(1){

        if ((bottom - send_head) > 256){              // rest size > 256 ?
            is_end = false;                            // yes, not end frame
            send_size = 256;                            // transmit size = 256 byte
        }
        else{
            is_end = true;
            send_size = bottom - send_head + 1;
            // transmit size = (bottom - send_head)+1
byte

        }

        memcpy(fl_txdata_frm, buf+send_head, send_size);
            // set data frame payload
        send_head += send_size;
    }
}

```

```
fl_wait(tFD3); // wait before sending data frame
put_dfrm_csi(send_size, fl_txdata_frm, is_end); // send data frame
fl_wait(tWT7); // wait

rc = fl_csi_getstatus(tWT7_MAX); // get status frame
switch(rc) {
    case FLC_NO_ERR: break; // continue
    // case FLC_DFTO_ERR: return rc; break; // case [C]
    default: return rc; break; // case [B]
}
if (fl_st2 != FLST_ACK){ // ST2 = ACK ?
    rc = decode_status(fl_st2); // No
    return rc; // case [D]
}

if (is_end) // send all user data ?
    break; // yes
//continue;

}
return FLC_NO_ERR; // case [A]
}
```

### 6.11 Block Blank Check Command

#### 6.11.1 Processing sequence chart

Block Blank Check command processing sequence

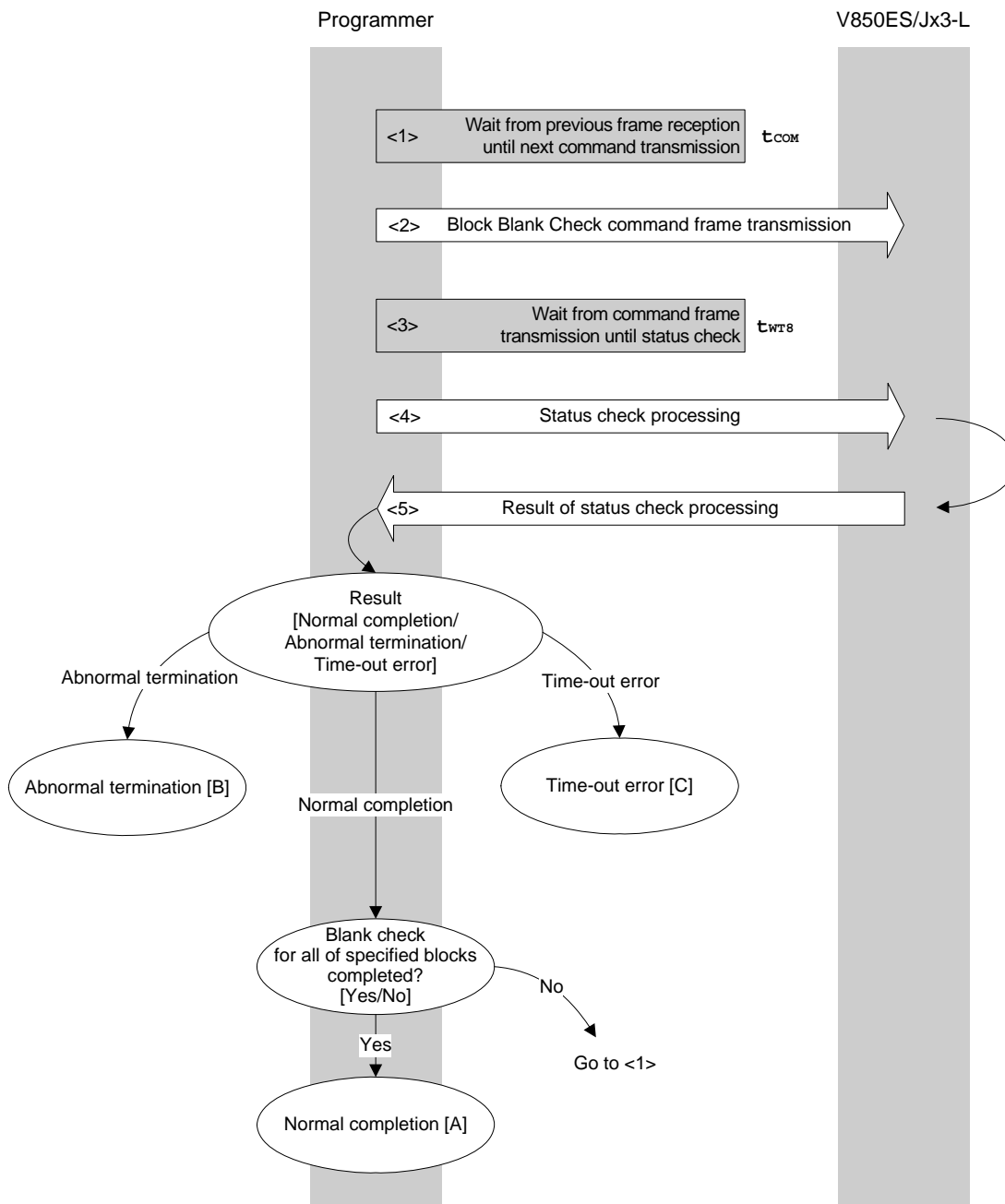

### 6.11.2 Description of processing sequence

- <1> Waits from the previous frame reception until the next command transmission (wait time  $t_{COM}$ ).
- <2> The Block Blank Check command is transmitted by command frame transmission processing.
- <3> Waits from command transmission until status check processing (wait time  $t_{WT8}$ ).
- <4> The status frame is acquired by status check processing.
- <5> The following processing is performed according to the result of status check processing.

When a time-out error occurs: A time-out error [C] is returned.

When the processing ends abnormally: Abnormal termination [B]

When the processing ends normally: If the blank check for all of the specified blocks is not yet completed, processing changes the block number and re-executes the sequence from <1>.

If the blank check for all of the specified blocks is completed, the processing ends normally [A].

### 6.11.3 Status at processing completion

Status at Processing Completion		Status Code	Description
Normal completion [A]	Normal acknowledgment (ACK)	06H	The command was executed normally and all of the specified blocks are blank.
Abnormal termination [B]	Parameter error	05H	The specified start/end address is not the start/end address of the block.
	Checksum error	07H	The checksum of the transmitted command frame does not match.
	Negative acknowledgment (NACK)	15H	<ul style="list-style-type: none"> <li>• A command other than the Status command was received during processing.</li> <li>• Command frame data is abnormal (such as invalid data length (LEN) or no ETX).</li> </ul>
	MRG11 error	1BH	The specified block in the flash memory is not blank.
Time-out error [C]		–	The status frame was not received within the specified time.



## 6.11.4 Flowchart

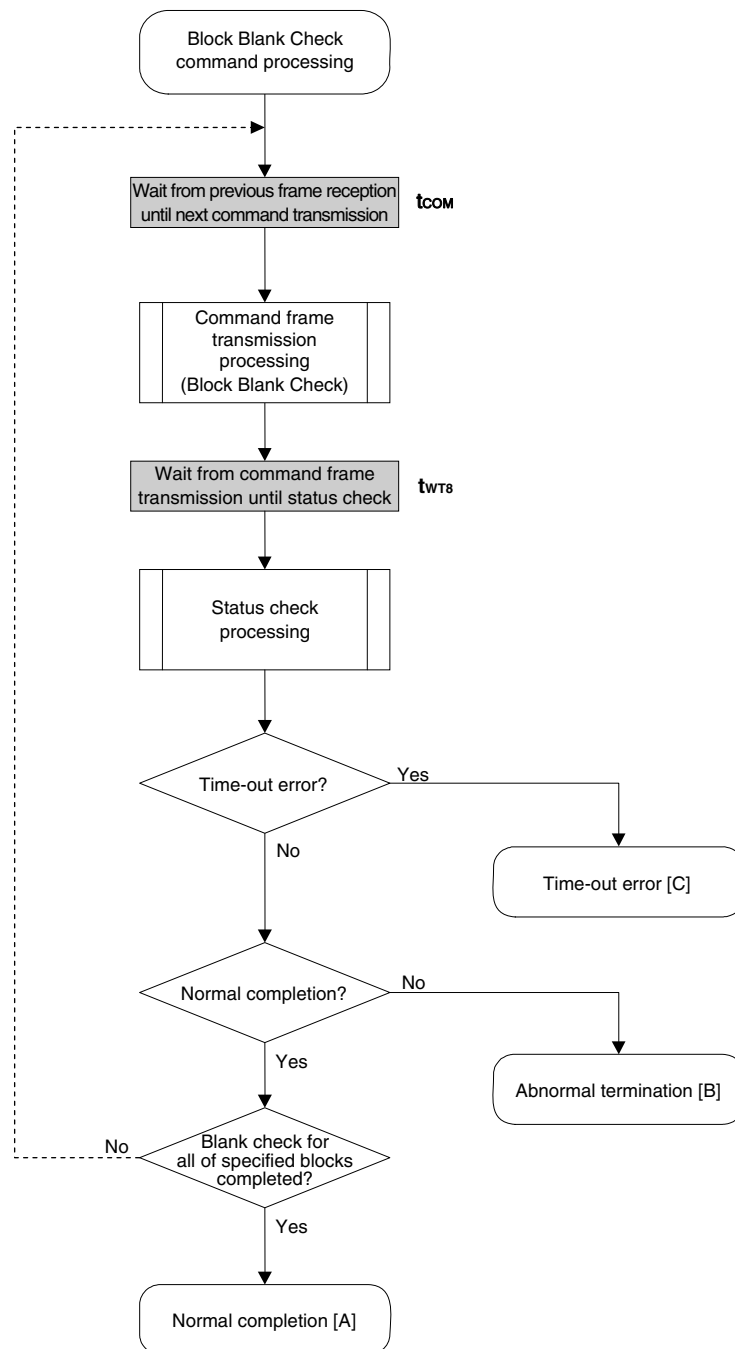

### 6.11.5 Sample program

The following shows a sample program for Block Blank Check command processing for one block.

```

/*****
/*
/* Block blank check command (CSI)
/*
/*****
/* [i] u16 sblk    ... start block number
/* [i] u16 eblk    ... end block number
/* [r] u16         ... error code
/*****
u16          fl_csi_blk_blank_chk(u16 sblk, u16 eblk)
{
    u16      rc;
    u32      wt8, wt8_max;
    u32      top, bottom;

    top = get_top_addr(sblk);          // get start address of start block
    bottom = get_bottom_addr(eblk);    // get end address of end block

    set_range_prm(fl_cmd_prm, top, bottom); // set SAH/SAM/SAL, EAH/EAM/EAL

    wt8      = make_wt8(sblk, eblk);    // get tWT8(Min)
    wt8_max = make_wt8_max(sblk, eblk); // get tWT8(Max)

    fl_wait(tCOM);                    // wait before sending command frame

    put_cmd_csi(FL_COM_BLOCK_BLANK_CHK, 7, fl_cmd_prm);
                                        // send "Block Blank Check" command

    fl_wait(wt8);

    rc = fl_csi_getstatus(wt8_max);    // get status frame
    // switch(rc) {
    //
    //     case   FLC_NO_ERR:    return rc;    break; // case [A]
    //     case   FLC_DFTO_ERR: return rc;    break; // case [C]
    //     default:              return rc;    break; // case [B]
    // }
    return rc;
}

```

6.12 Silicon Signature Command

6.12.1 Processing sequence chart

Silicon Signature command processing sequence

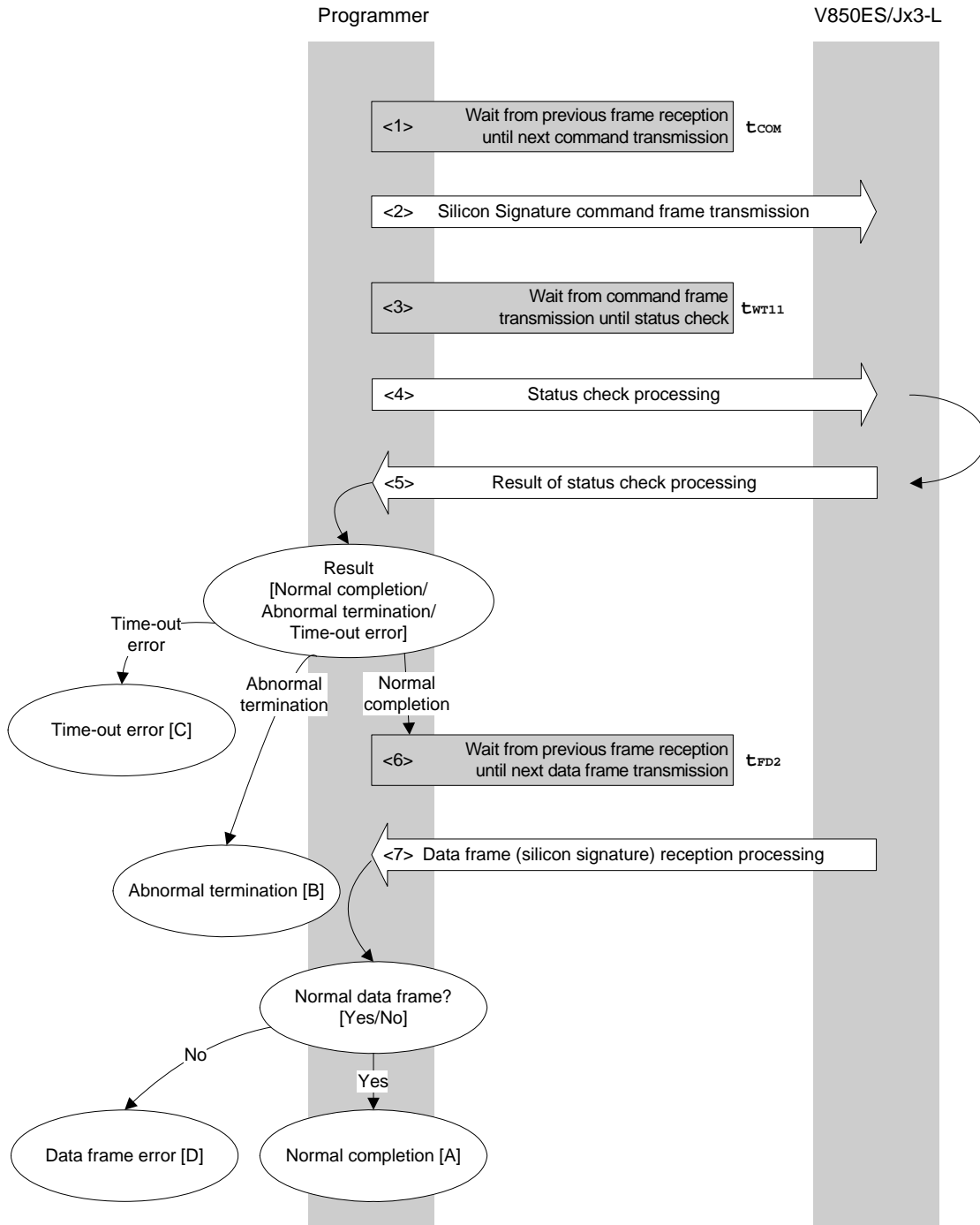

**6.12.2 Description of processing sequence**

- <1> Waits from the previous frame reception until the next command transmission (wait time  $t_{COM}$ ).
- <2> The Silicon Signature command is transmitted by command frame transmission processing.
- <3> Waits from command transmission until status check processing (wait time  $t_{WT1}$ ).
- <4> The status frame is acquired by status check processing.
- <5> The following processing is performed according to the result of status check processing.

When the processing ends normally: Proceeds to <6>.

When the processing ends abnormally: Abnormal termination [B]

When a time-out error occurs: A time-out error [C] is returned.

- <6> Waits from the previous frame reception until the next command transmission (wait time  $t_{FD2}$ ).
- <7> The received data frame (silicon signature data) is checked.

If data frame is normal: Normal completion [A]

If data frame is abnormal: Data frame error [D]

**6.12.3 Status at processing completion**

Status at Processing Completion		Status Code	Description
Normal completion [A]	Normal acknowledgment (ACK)	06H	The command was executed normally and the silicon signature was acquired normally.
Abnormal termination [B]	Checksum error	07H	The checksum of the transmitted command frame does not match.
	Negative acknowledgment (NACK)	15H	<ul style="list-style-type: none"> <li>• A command other than the Status command was received during processing.</li> <li>• Command frame data is abnormal (such as invalid data length (LEN) or no ETX).</li> </ul>
Time-out error [C]		–	The status frame was not received within the specified time.
Data frame error [D]		–	The checksum of the data frame received as silicon signature data does not match.

## 6.12.4 Flowchart

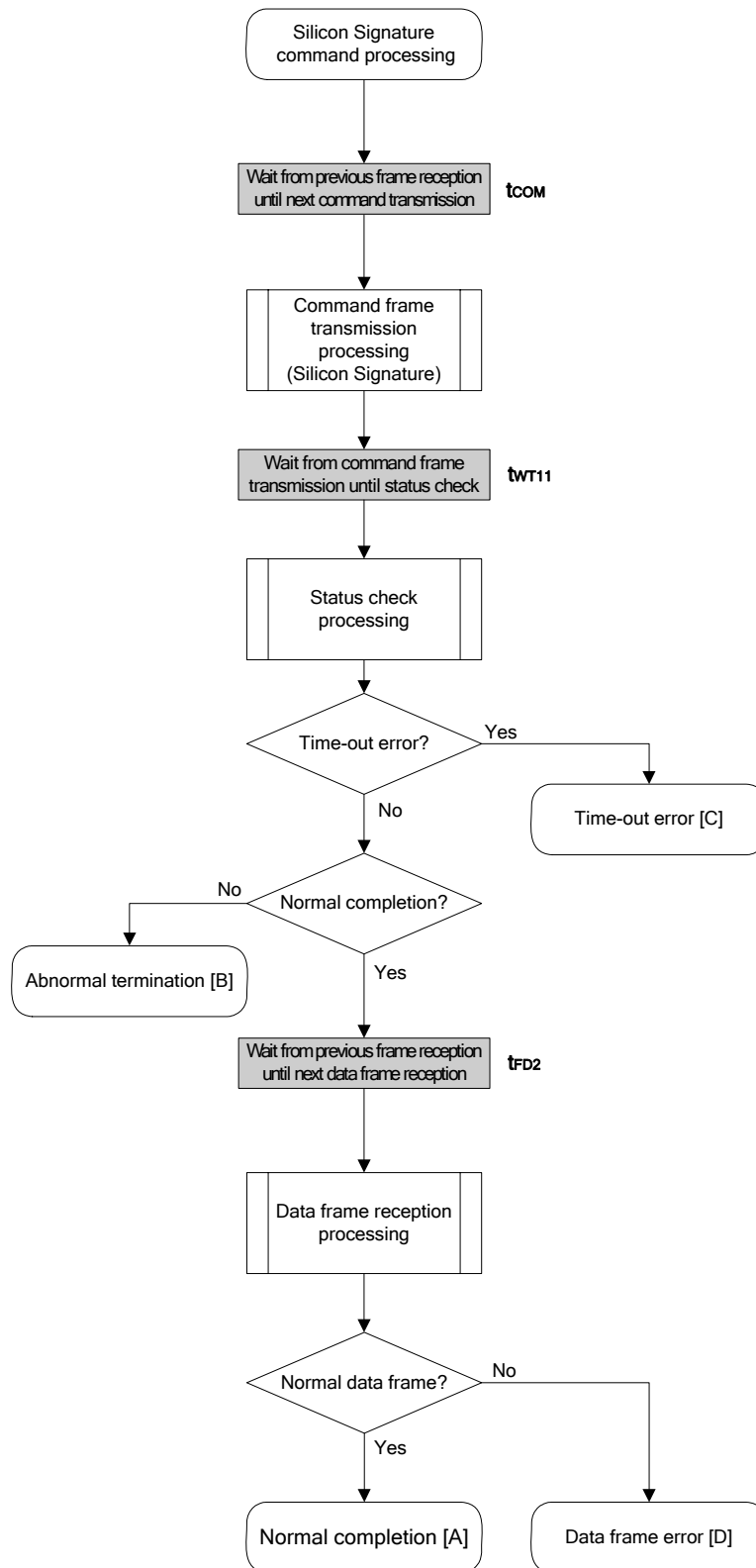

### 6.12.5 Sample program

The following shows a sample program for Silicon Signature command processing.

```

/*****
/*
/* Get silicon signature command (CSI)
/*
/*****
/* [i] u8 *sig    ... pointer to signature save area
/* [r] u16        ... error code
/*****
u16      fl_csi_getsig(u8 *sig)
{
    u16    rc;

    fl_wait(tCOM);                // wait before sending command frame

    put_cmd_csi(FL_COM_GET_SIGNATURE, 1, fl_cmd_prm);
                                   // send "Silicon Signature" command

    fl_wait(tWT11);

    rc = fl_csi_getstatus(tWT11_MAX);    // get status frame
    switch(rc) {
        case    FLC_NO_ERR:                break; // continue
        // case    FLC_DFTO_ERR:            return rc;    break; // case [C]
        default:                            return rc;    break; // case [B]
    }

    fl_wait(tFD2_SIG);                // wait before getting data frame

    rc = get_dfrm_csi(fl_rxdata_frm);    // get data frame (signature data)

    if (rc){                            // if no error,
        return rc;                        // case [D]
    }
    memcpy(sig, fl_rxdata_frm+OFS_STA_PLD, fl_rxdata_frm[OFS_LEN]);
                                   // copy Signature data
    return rc;                            // case [A]
}

```

### 6.13 Version Get Command

#### 6.13.1 Processing sequence chart

Version Get command processing sequence

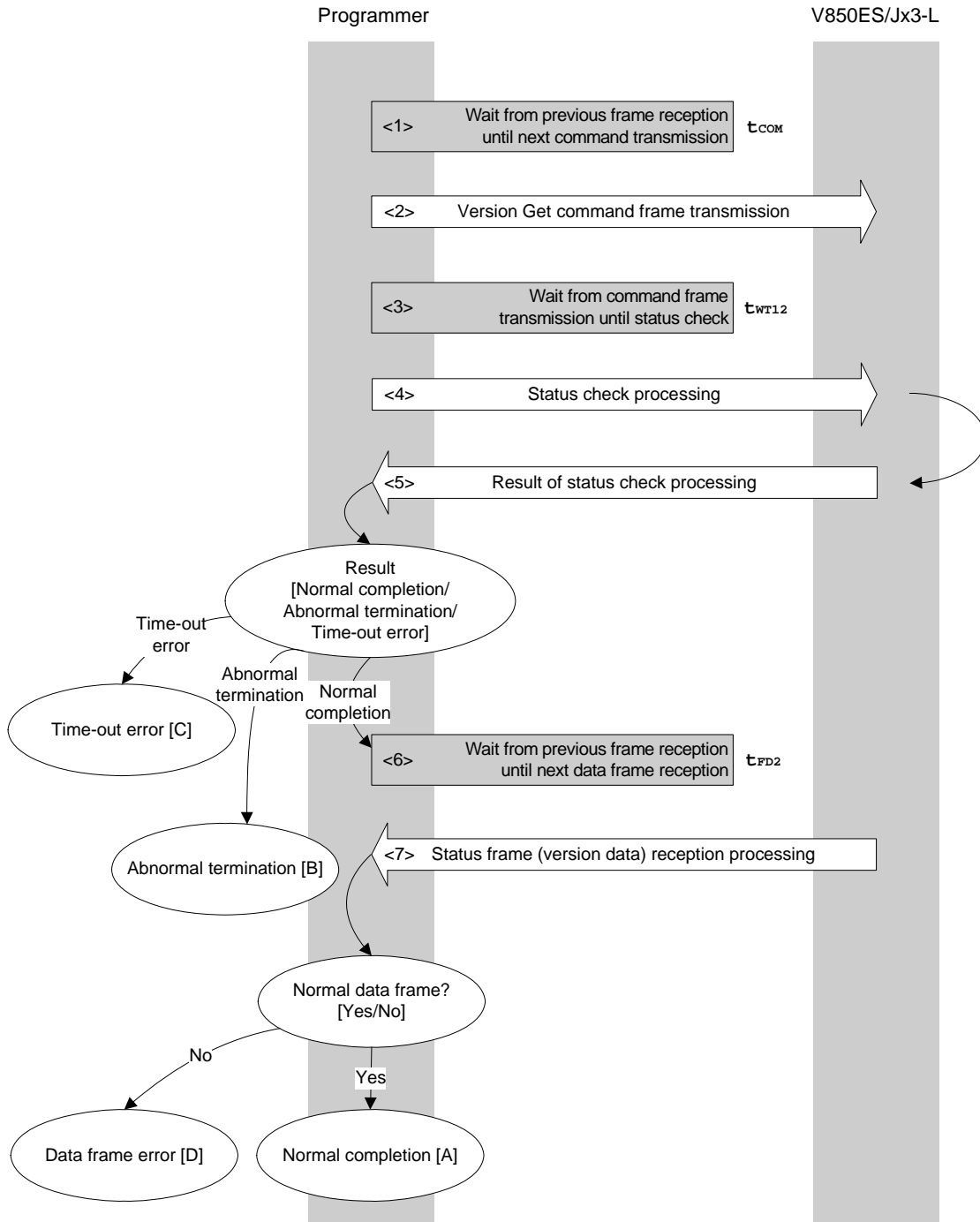

**6.13.2 Description of processing sequence**

- <1> Waits from the previous frame reception until the next command transmission (wait time  $t_{COM}$ ).
- <2> The Version Get command is transmitted by command frame transmission processing.
- <3> Waits from command transmission until status check processing (wait time  $t_{WT12}$ ).
- <4> The status frame is acquired by status check processing.
- <5> The following processing is performed according to the result of status check processing.

When the processing ends normally: Proceeds to <6>.

When the processing ends abnormally: Abnormal termination [B]

When a time-out error occurs: A time-out error [C] is returned.

- <6> Waits from the previous frame reception until the next command transmission (wait time  $t_{FD2}$ ).
- <7> The received data frame (version data) is checked.

If data frame is normal: Normal completion [A]

If data frame is abnormal: Data frame error [D]

**6.13.3 Status at processing completion**

Status at Processing Completion		Status Code	Description
Normal completion [A]	Normal acknowledgment (ACK)	06H	The command was executed normally and version data was acquired normally.
Abnormal termination [B]	Checksum error	07H	The checksum of the transmitted command frame does not match.
	Negative acknowledgment (NACK)	15H	<ul style="list-style-type: none"> <li>A command other than the Status command was received during processing.</li> <li>Command frame data is abnormal (such as invalid data length (LEN) or no ETX).</li> </ul>
Time-out error [C]		–	The status frame was not received within the specified time.
Data frame error [D]		–	The checksum of the data frame received as version data does not match.



6.13.4 Flowchart

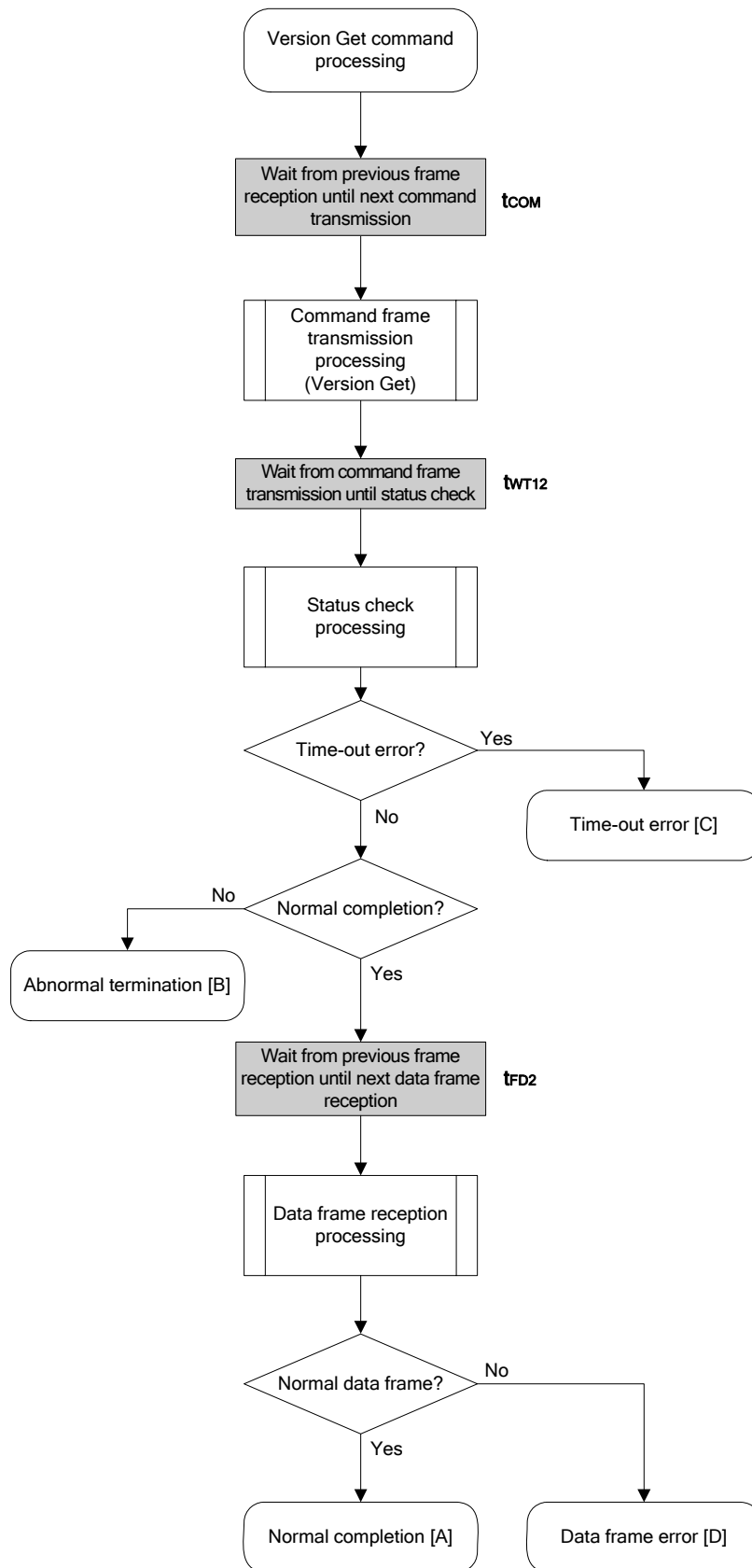

### 6.13.5 Sample program

The following shows a sample program for Version Get command processing.

```

/*****
/*
/* Get device/firmware version command (CSI)
/*
/*****
/* [i] u8 *buf    ... pointer to version data save area
/* [r] u16        ... error code
/*****
u16      fl_csi_getver(u8 *buf)
{
    u16    rc;

    fl_wait(tCOM);                // wait before sending command frame

    put_cmd_csi(FL_COM_GET_VERSION, 1, fl_cmd_prm);    // send "Version Get" command

    fl_wait(tWT12);

    rc = fl_csi_getstatus(tWT12_MAX);                // get status frame
    switch(rc) {
        case    FLC_NO_ERR:                            break; // continue
        // case    FLC_DFTO_ERR:                return rc;    break; // case [C]
        default:                return rc;    break; // case [B]
    }

    fl_wait(tFD2_VG);                // wait before getting data frame

    rc = get_dfrm_csi(fl_rxdata_frm);                // get version data

    if (rc){                // if no error,
        return rc;                // case [D]
    }

    memcpy(buf, fl_rxdata_frm+OFS_STA_PLD, DFV_LEN); // copy version data
    return rc;                // case [A]
}

```

6.14 Checksum Command

6.14.1 Processing sequence chart

Checksum command processing sequence

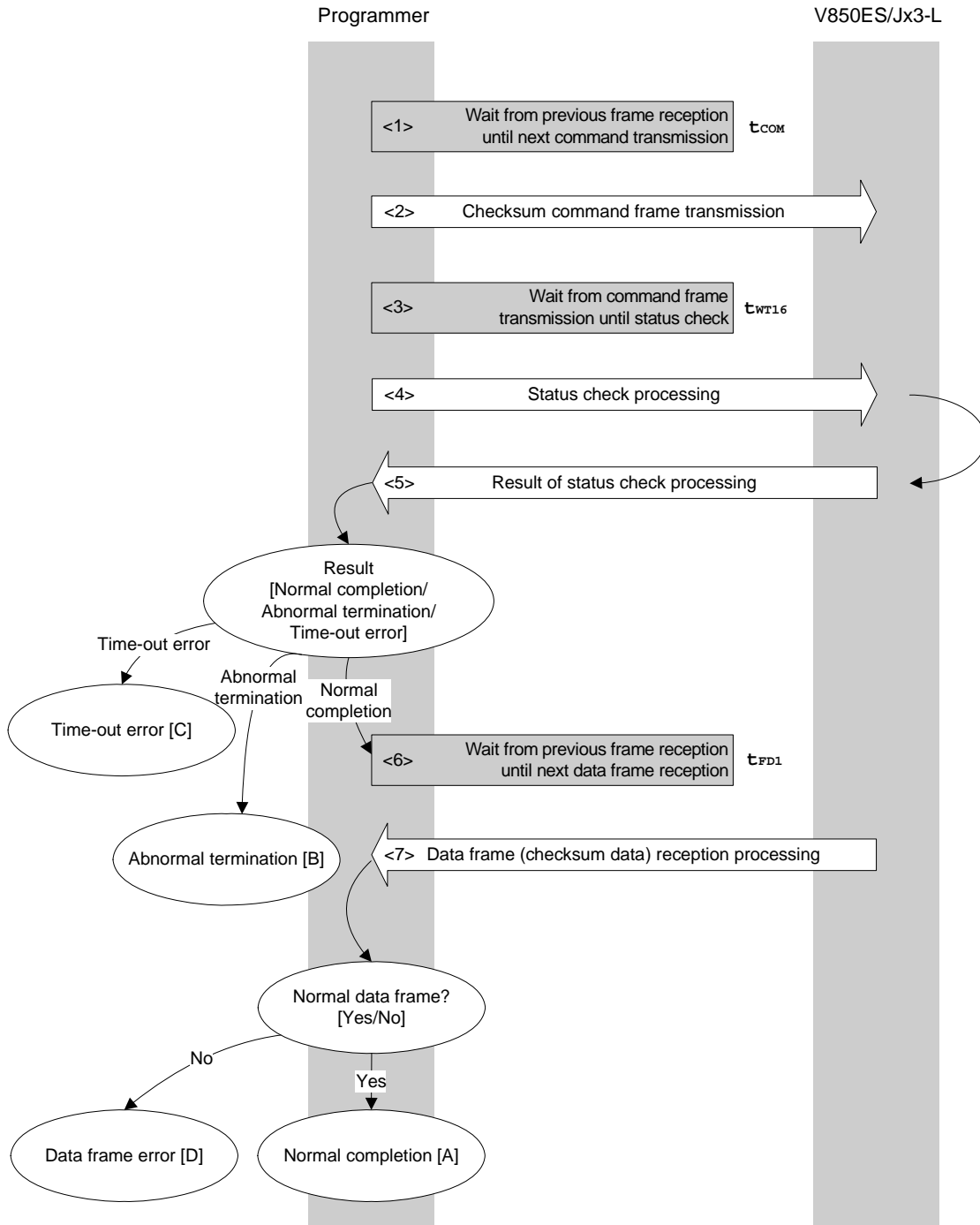

**6.14.2 Description of processing sequence**

- <1> Waits from the previous frame reception until the next command transmission (wait time  $t_{COM}$ ).
- <2> The Checksum command is transmitted by command frame transmission processing.
- <3> Waits from command transmission until status check processing (wait time  $t_{WT16}$ ).
- <4> The status frame is acquired by status check processing.
- <5> The following processing is performed according to the result of status check processing.

When the processing ends normally: Proceeds to <6>.

When the processing ends abnormally: Abnormal termination [B]

When a time-out error occurs: A time-out error [C] is returned.

- <6> Waits from the previous frame reception until the next command transmission (wait time  $t_{FD1}$ ).
- <7> The received data frame (checksum data) is checked.

If data frame is normal: Normal completion [A]

If data frame is abnormal: Data frame error [D]

**6.14.3 Status at processing completion**

Status at Processing Completion		Status Code	Description
Normal completion [A]	Normal acknowledgment (ACK)	06H	The command was executed normally and checksum data was acquired normally.
Abnormal termination [B]	Parameter error	05H	The specified start/end address is not the start/end address of the block.
	Checksum error	07H	The checksum of the transmitted command frame does not match.
	Negative acknowledgment (NACK)	15H	<ul style="list-style-type: none"> <li>• A command other than the Status command was received during processing.</li> <li>• Command frame data is abnormal (such as invalid data length (LEN) or no ETX).</li> </ul>
Time-out error [C]		–	The status frame was not received within the specified time.
Data frame error [D]		–	The checksum of the data frame received as version data does not match.

## 6.14.4 Flowchart

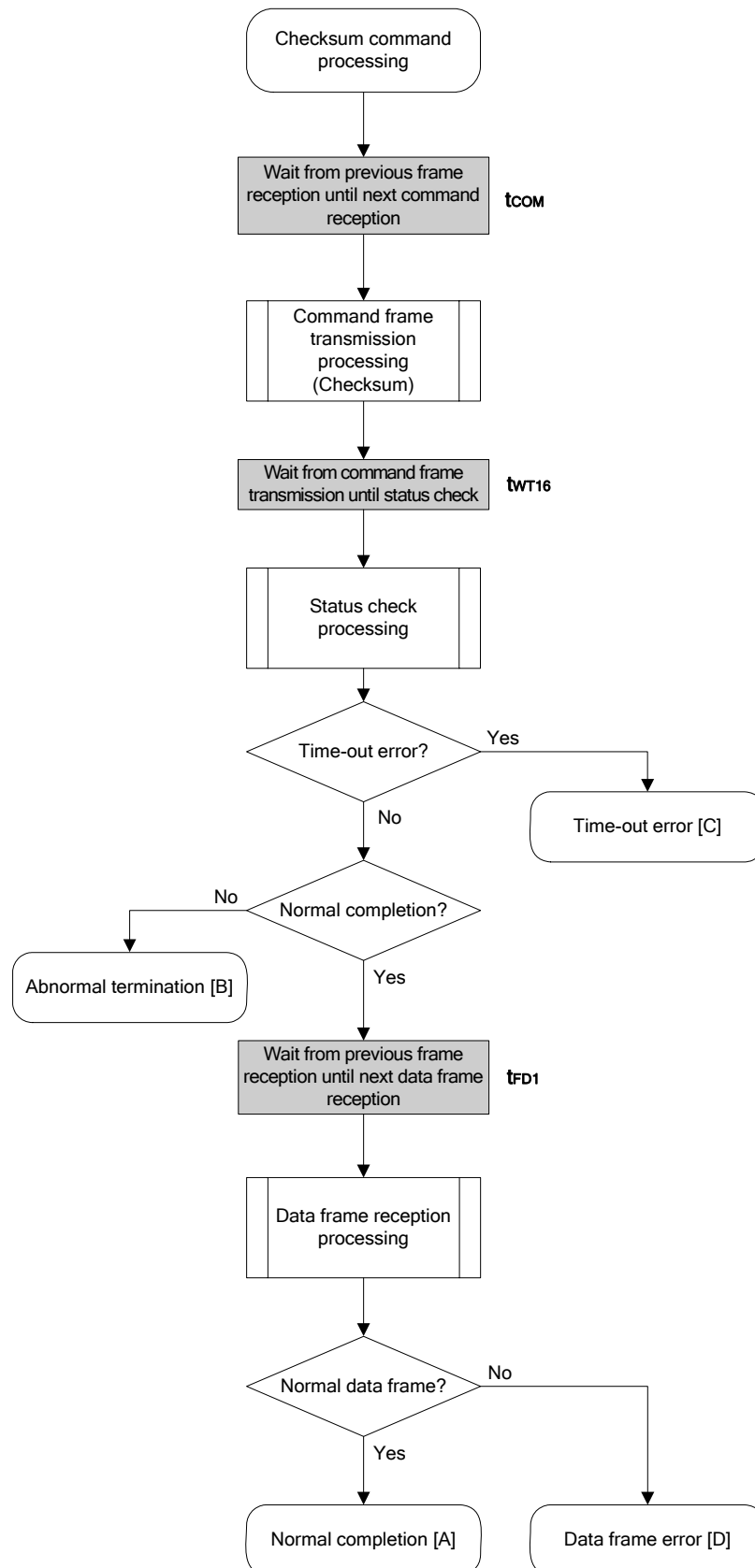

### 6.14.5 Sample program

The following shows a sample program for Checksum command processing.

```

/*****
/*
/* Get checksum command (CSI)
/*
/*****
/* [i] u16 *sum ... pointer to checksum save area
/* [i] u32 top ... start address
/* [i] u32 bottom ... end address
/* [r] u16 ... error code
/*****
u16          fl_csi_getsum(u16 *sum, u32 top, u32 bottom)
{
    u16      rc;
    u32      fd1;

    /*****
    /*      set params
    /*****
    // set params
    set_range_prm(fl_cmd_prm, top, bottom);          // set SAH/SAM/SAL, EAH/EAM/EAL
    fd1 = get_fd1(get_block_num(top, bottom));      // get tFD1(Min)

    /*****
    /*      send command
    /*****
    fl_wait(tCOM);                                // wait before sending command frame

    put_cmd_csi(FL_COM_GET_CHECK_SUM, 7, fl_cmd_prm); // send "Checksum" command

    fl_wait(tWT16);

    rc = fl_csi_getstatus(tWT16_MAX);              // get status frame
    switch(rc) {
        case FLC_NO_ERR:                          break; // continue
        // case FLC_DFTO_ERR: return rc;          break; // case [C]
        default: return rc;                        break; // case [B]
    }

    /*****
    /*      get data frame (Checksum data)
    /*****
    fl_wait(fd1);

    rc = get_dfrm_csi(fl_rxddata_frm);              // get data frame(version data)

    if (rc){                                       // if error,
        return rc;                                 // case [D]
    }

    *sum = (fl_rxddata_frm[OFS_STA_PLD] << 8) + fl_rxddata_frm[OFS_STA_PLD+1];
                                                // set SUM data
    return rc;                                     // case [A]
}

```

### 6.15 Security Set Command

#### 6.15.1 Processing sequence chart

Security Set command processing sequence

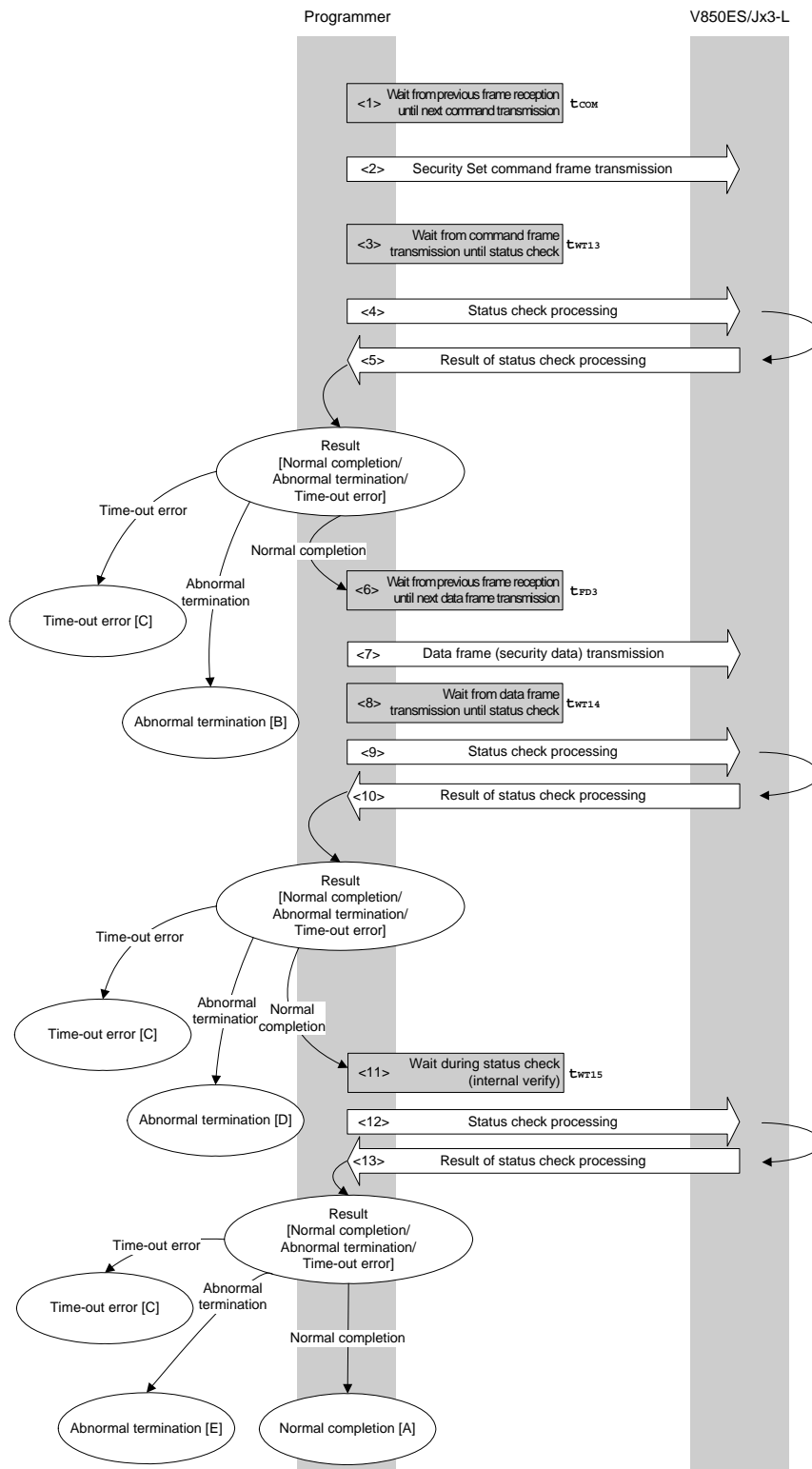

### 6.15.2 Description of processing sequence

- <1> Waits from the previous frame reception until the next command transmission (wait time  $t_{COM}$ ).
- <2> The Security Set command is transmitted by command frame transmission processing.
- <3> Waits from command transmission until status check processing (wait time  $t_{WT13}$ ).
- <4> The status frame is acquired by status check processing.
- <5> The following processing is performed according to the result of status check processing.

When the processing ends normally: Proceeds to <6>.  
When the processing ends abnormally: Abnormal termination [B]  
When a time-out error occurs: A time-out error [C] is returned.

- <6> Waits from the previous frame reception until the data frame transmission (wait time  $t_{FD3}$ ).
- <7> The data frame (security setting data) is transmitted by data frame transmission processing.
- <8> Waits from data frame transmission until status check processing (wait time  $t_{WT14}$ ).
- <9> The status frame is acquired by status check processing.
- <10> The following processing is performed according to the result of status check processing.

When the processing ends normally: Proceeds to <11>.  
When the processing ends abnormally: Abnormal termination [D]  
When a time-out error occurs: A time-out error [C] is returned.

- <11> Waits until status acquisition (completion of internal verify) (wait time  $t_{WT15}$ ).
- <12> The status frame is acquired by status check processing.
- <13> The following processing is performed according to the result of status check processing.

When the processing ends normally: Normal completion [A]  
When the processing ends abnormally: Abnormal termination [E]  
When a time-out error occurs: A time-out error [C] is returned.



## 6.15.3 Status at processing completion

Status at Processing Completion		Status Code	Description
Normal completion [A]	Normal acknowledgment (ACK)	06H	The command was executed normally and security setting data was performed normally.
Abnormal termination [B]	Checksum error	07H	The checksum of the transmitted command frame does not match.
	Negative acknowledgment (NACK)	15H	<ul style="list-style-type: none"> <li>A command other than the Status command was received during processing.</li> <li>Command frame data is abnormal (such as invalid data length (LEN) or no ETX).</li> </ul>
Time-out error [C]		–	The status frame was not received within the specified time.
Abnormal termination [D]	Negative acknowledgment (NACK)	15H	The security data frame is abnormal.
	Checksum error	07H	The checksum of the transmitted security data frame does not match.
	Protect error	10H	When security data is in the following statuses <ul style="list-style-type: none"> <li>The security is changed from disabled to enabled.</li> <li>The value of the last block number in the boot block cluster is changed when boot block cluster rewriting is disabled.</li> </ul>
	Parameter error	05H	When security data is in the following statuses <ul style="list-style-type: none"> <li>The last block number of the boot block cluster is larger than the last block number of the device.</li> <li>The value of the reset vector handler address is not 0000000H.</li> </ul>
Abnormal termination [E]	MRG10 error	1AH	A write error has occurred.
	MRG11 error	1BH	
	WRITE error	1CH	

6.15.4 Flowchart

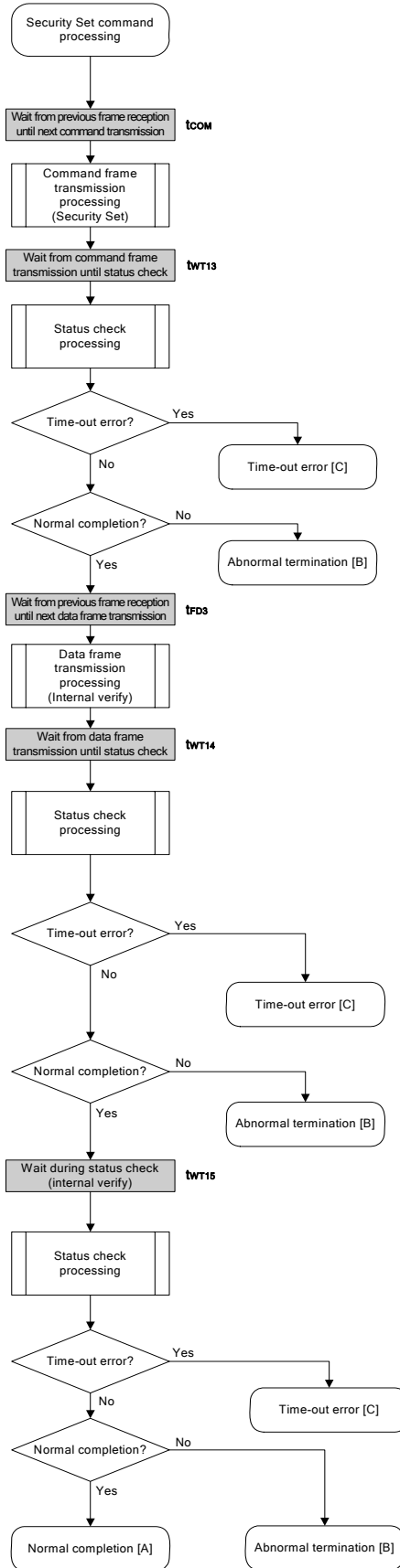

### 6.15.5 Sample program

The following shows a sample program for Security Set command processing.

```

/*****
/*
/* Set security flag command (CSI)
/*
/*
/*****
/* [i] u8 scf ... Security flag data
/* [r] ul6 ... error code
/*****
ul6          fl_csi_setscf(u8 scf, u8 bot, u32 vect)
{
    ul6      rc;

    /*****
    /*      set params
    /*
    /*****
    fl_cmd_prm[0] = 0x00;          // "BLK" (must be 0x00)
    fl_cmd_prm[1] = 0x00;          // "PAG" (must be 0x00)

    fl_txdata_frm[0] = scf|= 0b11100000; // "FLG" (bit 7,6,5 must be '1')
    fl_txdata_frm[1] = bot;          // "BOT"

    fl_txdata_frm[2] = (u8)(vect >> 16); // "ADH"
    fl_txdata_frm[3] = (u8)(vect >> 8); // "ADM"
    fl_txdata_frm[4] = (u8) vect;      // "ADL"

    /*****
    /*      send command
    /*
    /*****
    fl_wait(tCOM);          // wait before sending command frame

    put_cmd_csi(FL_COM_SET_SECURITY, 3, fl_cmd_prm); // send "Security Set" command

    fl_wait(tWT13);          // wait

    rc = fl_csi_getstatus(tWT13_MAX); // get status frame
    switch(rc) {
        case FLC_NO_ERR:          break; // continue
    // case FLC_DFTO_ERR: return rc; break; // case [C]
        default: return rc; break; // case [B]
    }

    /*****
    /*      send data frame (security setting data)
    /*
    /*****
    fl_wait(tFD3);          // wait before getting data frame

    put_dfrm_csi(5, fl_txdata_frm, true); // send data frame(Security data)

    fl_wait(tWT14);

    rc = fl_csi_getstatus(tWT14_MAX); // get status frame
    switch(rc) {
        case FLC_NO_ERR:          break; // continue
    // case FLC_DFTO_ERR: return rc; break; // case [C]
        default: return rc; break; // case [B]
    }
}

```

```

/*****
/*      Check internally verify      */
/*****
fl_wait(tWT15);

rc = fl_csi_getstatus(tWT15_MAX);    // get status frame
// switch(rc) {
//
//      case   FLC_NO_ERR:      return rc;      break; // case [A]
//      case   FLC_DFTO_ERR:   return rc;      break; // case [C]
//      default:                return rc;      break; // case [B]
// }
return rc;
}
```

## 6.16 Read Command

### 6.16.1 Processing sequence chart

Read command processing sequence

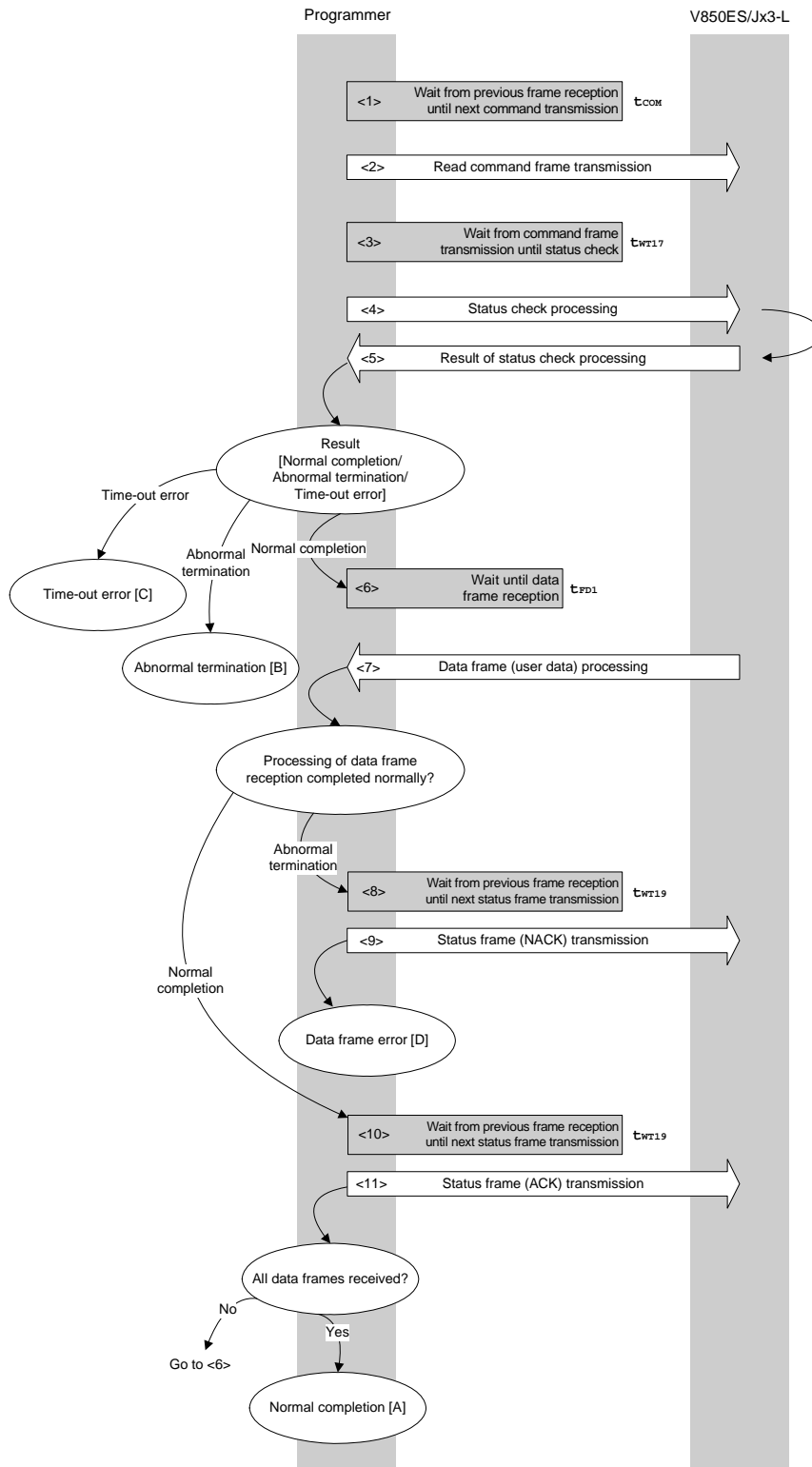

**6.16.2 Description of processing sequence**

- <1> Waits from the previous frame reception until the next command transmission (wait time  $t_{COM}$ ).
- <2> The Read command is transmitted by command frame transmission processing.
- <3> Waits from command transmission until status check processing (wait time  $t_{WT17}$ ).
- <4> The status frame is acquired by status check processing.
- <5> The following processing is performed according to the result of status check processing.

When the processing ends normally: Proceeds to <6>.  
 When the processing ends abnormally: Abnormal termination [B]  
 When a time-out error occurs: A time-out error [C] is returned.

- <6> Waits from the previous frame reception until the data frame reception (wait time  $t_{WT18}$ ).
- <7> The data frame (user data) is received by data frame reception processing.  
 The following processing is performed according to the result of reception processing.

When the processing ends normally: Proceeds to <10>.  
 When the processing ends abnormally: Proceeds to <8>.

- <8> Waits from the previous frame reception until the next status (NACK) frame transmission (wait time  $t_{WT19}$ ).
- <9> The NACK frame is transmitted by data frame transmission processing.  
 A data frame error [D] is returned.
- <10> Waits from the previous frame reception until the next status (ACK) frame transmission (wait time  $t_{WT19}$ ).
- <11> The ACK frame is transmitted by data frame transmission processing.  
 When reception of all data frames is completed, the normal completion status [A] is returned.  
 If there still remain data frames to be received, the sequence is re-executed from <5>.

**6.16.3 Status at processing completion**

Status at Processing Completion		Status Code	Description
Normal completion [A]	Normal acknowledgment (ACK)	06H	The command was executed normally and read data was set normally.
Abnormal termination [B]	Parameter error	05H	The specified start/end address is not the start/end address of the block.
	Checksum error	07H	The checksum of the transmitted command frame does not match.
	Protect error	10H	Read is prohibited by the security setting.
	Negative acknowledgment (NACK)	15H	Command frame data is abnormal (such as invalid data length (LEN) or no ETX).
Time-out error [C]		–	The status frame was not received within the specified time.
Data frame error [D]		–	The checksum of the data frame received as read data does not match.

6.16.4 Flowchart

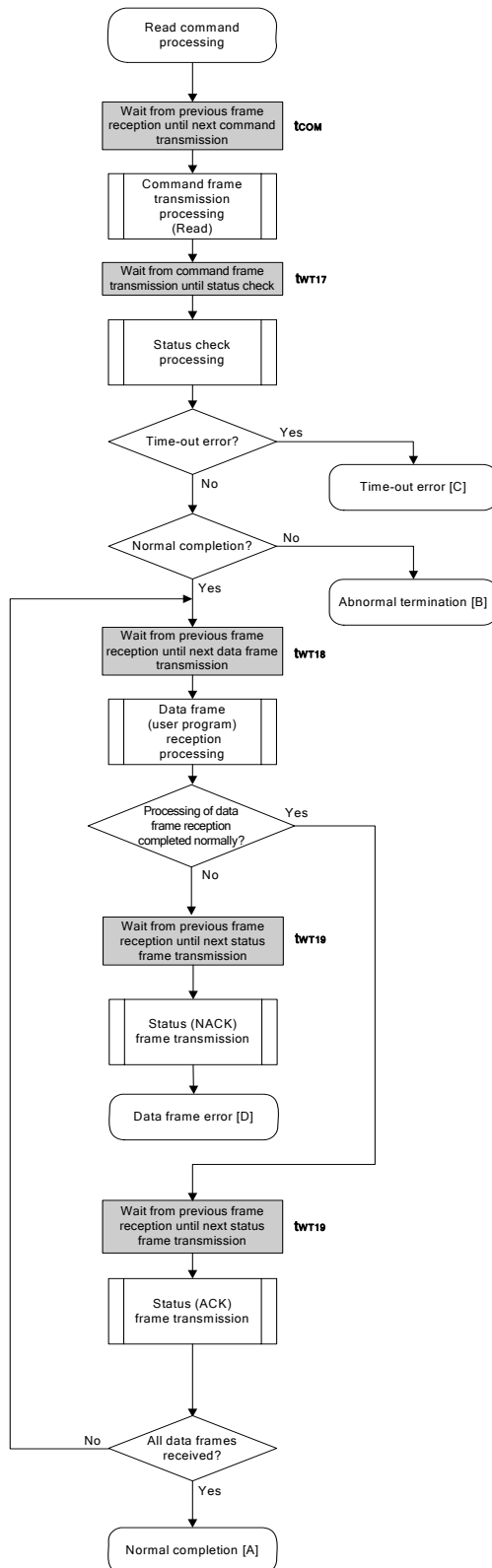

### 6.16.5 Sample program

The following shows a sample program for Read command processing.

```

/*****
/*
/* Read command (CSI)
/*
/*
/*****
/* [i] u32 top      ... start address
/* [i] u32 bottom  ... end address
/* [r] u16         ... error code
/*****
u16          fl_csi_read(u32 top, u32 bottom)
{
    u16      rc;
    u32      read_head;
    u16      len;
    u8       hooter;

    /*****
    /*      set params
    /*****

    set_range_prm(fl_cmd_prm, top, bottom);          // set SAH/SAM/SAL, EAH/EAM/EAL

    /*****
    /*      send command & check status
    /*****
    fl_wait(tCOM);          // wait before sending command

    put_cmd_csi(FL_COM_READ, 7, fl_cmd_prm); // send "Read" command

    fl_wait(tWT17);        // wait

    rc = fl_csi_getstatus(tWT17_MAX);          // get status frame
    switch(rc) {
        case   FLC_NO_ERR:                break; // continue
//          case   FLC_DFTO_ERR:    return rc;    break; // case [C]
        default:                return rc;    break; // case [B]
    }

    /*****
    /*      receive user data
    /*****
    read_head = top;

    while(1){
        fl_wait(tWT18);

        rc = get_dfrm_csi(fl_rxd_data_frm);          // get ROM data from FLASH
        switch(rc) {
            case   FLC_NO_ERR:    break;          // continue
//          case   FLC_RX_DFSUM_ERR:
            default:                // case [D]

                fl_wait(tWT19);
                put_sfrm_csi(FLST_NACK); // send status(NACK) frame
                return rc;
                break;
        }
    }

```



```
fl_wait(tWT19);
put_sfrm_csi(FLST_ACK);          // send status(ACK) frame

/*****
/*      save ROM data              */
*****/
if ((len = fl_rxddata_frm[OFS_LEN]) == 0)    // get length
    len = 256;

memcpy(read_buf+read_head, fl_rxddata_frm+2, len);
                                           // save to external RAM

read_head += len;

/*****
/*      end check                  */
*****/
hooter = fl_rxddata_frm[len + 3];
if (hooter == FL_ETB)                // end frame ?
    continue;                        // no
break;                                // yes
}

return FLC_NO_ERR;
}
```

**CHAPTER 7 FLASH MEMORY PROGRAMMING PARAMETER CHARACTERISTICS**

This chapter describes the parameter characteristics between the programmer and the V850ES/Jx3-L in the flash memory programming mode. Be sure to read the user's manual of the V850ES/Jx3-L for the electrical specifications when designing with a programmer.

**(1) Flash memory parameter characteristics (1)**

<R> **Target devices:**  
 V850ES/JC3-L:  $\mu$ PD70F3797, 70F3798, 70F3799, 70F3800, 70F3838, 70F3801, 70F3802, 70F3803, 70F3804, 70F3839  
 V850ES/JE3-L:  $\mu$ PD70F3805, 70F3806, 70F3807, 70F3808, 70F3840  
 V850ES/JF3-L:  $\mu$ PD70F3735, 70F3736  
 V850ES/JG3-L:  $\mu$ PD70F3737, 70F3738

**(a) Operating clock**

The main clock frequency ( $f_{xx}$ ) of the V850ES/Jx3-L is changed according to the value of the main clock oscillation frequency ( $f_x$ ) specified with the Oscillation Frequency Set command by the programmer.

- <R>
- $2.5 \text{ MHz} \leq f_x \leq 5.0 \text{ MHz}$ :  $f_{xx} = f_x \times 4$  (PLL mode)
  - $5.0 \text{ MHz} < f_x \leq 10 \text{ MHz}$ :  $f_{xx} = f_x \times 1$

Therefore, it is obtained by assigning  $f_x$  ( $f_x = f_{xx}$ ) before the Oscillation Frequency Set command (until a wait ( $t_{WT9}$ ) after issuance of the Oscillation Frequency Set command from the programmer) and after that, by assigning a frequency value to  $f_{xx}$  in accordance with the  $f_x$  as shown above.

**Remark** The main clock frequency ( $f_{xx}$ ) is automatically set in the V850ES/Jx3-L in accordance with  $f_x$  in the flash memory programming mode.

**(b) Flash memory programming mode setting time**

Parameter	Symbol	Condition	MIN.	TYP.	MAX.
$V_{DD}\uparrow$ to FLMD0 $\uparrow$	$t_{DP}$		1 ms		
FLMD0 $\uparrow$ to $\overline{RESET}\uparrow$	$t_{PR}$		2 ms		
Count start time from $\overline{RESET}\uparrow$ to FLMD0 <sup>Note 1</sup>	$t_{RP}$		800 $\mu$ s		
Count finish time from $\overline{RESET}\uparrow$ to FLMD0 <sup>Note 1</sup>	$t_{RPE}$				10 ms
FLMD0 counter high-level width/ low-level width	$t_{PW}$		10 $\mu$ s		100 $\mu$ s
Wait for Reset command	$t_{RC}$	CSI, CSI + HS	0.3 s		
Wait for low level (data 1)	$t_{R1}$	UART	0.3 s		
Wait for low level (data 2)	$t_{12}$	UART	30,000/ $f_{xx}$		
Wait for Reset command	$t_{2C}$	UART	30,000/ $f_{xx}$		
Low level width (data 1)	$t_{L1}$	UART		<b>Note 2</b>	
Low level width (data 2)	$t_{L2}$	UART		<b>Note 2</b>	
FLMD0 counter rise time	$t_R$				1 $\mu$ s
FLMD0 counter fall time	$t_F$				1 $\mu$ s

- Notes**
1.  $(t_{RP} + t_{RPE})/2$  is recommended as the standard value for the FLMD0 pin signal input timing.
  2. The low-level width is the same as the 00H data width at 9,600 bps.

**(c) Programming characteristics**

Parameter	Symbol	Condition	MIN.	MAX.	
Data to Data	t <sub>DR</sub>	Receive data frame	CSI, CSI + HS	188/f <sub>xx</sub>	
			UART	188/f <sub>xx</sub>	
	t <sub>DT</sub>	Send data frame	CSI, CSI + HS	165/f <sub>xx</sub>	
			UART	<b>Note</b>	
Status command frame reception to status frame transmission	t <sub>SF</sub>	CSI, CSI + HS	3179/f <sub>xx</sub>		
Status frame reception to data frame transmission (1)	t <sub>FD1</sub>	CSI, CSI + HS	$1,026/f_{xx} + 92,159/f_{xx} \times M + 29 \mu s$	$1,232/f_{xx} + 110,591/f_{xx} \times M + 35 \mu s$	
		UART	<b>Note</b>	$1,232/f_{xx} + 110,591/f_{xx} \times M + 35 \mu s$	
Status frame transmission to data frame transmission (2)	t <sub>FD2</sub>	CSI, CSI + HS	$4,744/f_{xx} + 86 \mu s$		
		UART	<b>Note</b>		
Status frame transmission to data frame reception (3)	t <sub>FD3</sub>	CSI, CSI + HS	$2,845/f_{xx} + 43 \mu s$		
		UART	$2,845/f_{xx} + 43 \mu s$		
Status frame transmission to command frame reception	t <sub>COM</sub>	–	$620/f_{xx} + 15 \mu s$		

**Note** Successive reception must be enabled for the programmer. Set the programmer time-out time to 3 seconds or more.

**Remark** M: Number of blocks  
f<sub>xx</sub>: Main clock frequency

<t<sub>DR</sub>, t<sub>FD3</sub>, t<sub>COM</sub>>

The V850ES/Jx3-L is readied for the next communication after the MIN. time has elapsed after completion of the previous communication.

The programmer must transmit the next data after the MIN. time has elapsed after completion of the previous communication.

<t<sub>DT</sub>, t<sub>SF</sub>, t<sub>FD2</sub>>

The V850ES/Jx3-L is readied for the next communication after the MIN. time has elapsed after completion of the previous communication.

The programmer must receive the next data after the MIN. time has elapsed after completion of the previous communication.

In CSI communication, the programmer must issue the Status command after the MIN. time has elapsed. If ACK is not returned, do not repeat the status check and execute the error processing (time-out processing, etc.).

<t<sub>FD1</sub>>

The V850ES/Jx3-L completes each command processing between the MIN. and MAX. times. If the V850ES/Jx3-L does not complete each command processing after the MAX. time has elapsed, execute the error processing (time-out processing, etc.).

In CSI communication, the programmer must repeat the status check from the MIN. time to MAX. time.

In UART communication, the V850ES/Jx3-L transmits the status frame between the MIN. and MAX. times.

## (d) Command characteristics

(1/2)

Command	Symbol	Condition	MIN.	MAX.
Reset	t <sub>WT0</sub>	CSI, CSI + HS	255/f <sub>xx</sub>	
		UART	<b>Note 1</b>	
Chip Erase	t <sub>WT1</sub>	–	38,825/f <sub>xx</sub> + 70,305 μs	41,937/f <sub>xx</sub> + 908,730 μs
Block Erase	t <sub>WT2</sub>	–	6,329/f <sub>xx</sub> + (596/f <sub>xx</sub> + 20 μs + 307 μs × BM) + (... <sup>Note 2</sup> ) + 58 μs	7,630/f <sub>xx</sub> + (596/f <sub>xx</sub> + 284,551 μs + 307 μs × BM) + (... <sup>Note 2</sup> ) + 76 μs
Program	t <sub>WT3</sub>	CSI, CSI + HS	2,995/f <sub>xx</sub> + 58 μs	
		UART	<b>Note 1</b>	
	t <sub>WT4</sub> <sup>Note 3</sup>	–	28,073/f <sub>xx</sub> + 1,140 μs	1,071,055/f <sub>xx</sub> + 27,759 μs
	t <sub>WT5</sub>	CSI, CSI + HS	3,234/f <sub>xx</sub> + (216,690/f <sub>xx</sub> + 1,842 μs) × M + 31 μs	3,881/f <sub>xx</sub> + (260,028/f <sub>xx</sub> + 2,211 μs) × M + 38 μs
UART		<b>Note 4</b>	3,881/f <sub>xx</sub> + (260,028/f <sub>xx</sub> + 2,211 μs) × M + 38 μs	
Verify	t <sub>WT6</sub>	CSI, CSI + HS	508/f <sub>xx</sub>	
		UART	<b>Note 1</b>	
	t <sub>WT7</sub> <sup>Note 3</sup>	CSI, CSI + HS	14,565/f <sub>xx</sub> + 116 μs	
		UART	<b>Note 5</b>	
Block Blank Check	t <sub>WT8</sub>	–	3,102/f <sub>xx</sub> + (915/f <sub>xx</sub> + 20 μs + 307 μs × BM) + (... <sup>Note 2</sup> ) + 29 μs	3,723/f <sub>xx</sub> + (1,098/f <sub>xx</sub> + 24 μs + 369 μs × BM) + (... <sup>Note 2</sup> ) + 35 μs
Oscillating Frequency Set	t <sub>WT9</sub>	CSI, CSI + HS	10,727/f <sub>xx</sub>	
		UART	<b>Note 1</b>	
Baud Rate Set	t <sub>WT10</sub>	UART	2,384/f <sub>xx</sub>	
Silicon Signature	t <sub>WT11</sub>	CSI, CSI + HS	548/f <sub>xx</sub>	
		UART	<b>Note 1</b>	
Version Get	t <sub>WT12</sub>	CSI, CSI + HS	565/f <sub>xx</sub>	
		UART	<b>Note 1</b>	

**Notes 1.** Reception must be enabled for the programmer before command frame transmission. Set the programmer time-out time to 3 seconds or more.

- 2.** When how many times the simultaneous selection processing is repeated is indicated by BN, perform the calculation in the parentheses, as shown in the Example below.

**Example** When executing simultaneous processing with changing block size from 2 → 4 → 8

(Block Erase command's MIN. value) (BN = 3)

$$6,329/f_{xx} + (596/f_{xx} + 20 \mu s + 307 \mu s \times 2) + (596/f_{xx} + 20 \mu s + 307 \mu s \times 4) + (596/f_{xx} + 20 \mu s + 307 \mu s \times 8) + 58 \mu s$$

- 3.** 64-word units
- 4.** Successive reception must be enabled for the programmer. Set the programmer time-out time to 3 seconds or more.
- 5.** Reception must be enabled for the programmer before data frame transmission. Set the programmer time-out time to 3 seconds or more.

**Remark** M: Number of blocks

BM: Number of blocks to be selected and processed simultaneously (blocks)

BN: Number of executions of simultaneous selection and processing (number of repetitions of addition in the parentheses in Table above)

f<sub>xx</sub>: Main clock frequency

**(d) Command characteristics**

(2/2)

Command	Symbol	Condition	MIN.	MAX.
Security Setting	t <sub>WT13</sub>	CSI, CSI + HS	514/f <sub>xx</sub>	
		UART	<b>Note 1</b>	
	t <sub>WT14</sub>	–	22,991/f <sub>xx</sub> + 2,031 μs	25,367/f <sub>xx</sub> + 299,845 μs
	t <sub>WT15</sub>	CSI, CSI + HS	11,686/f <sub>xx</sub> + 14,705 μs	11,686/f <sub>xx</sub> + 285,011 μs
UART		<b>Note 2</b>	11,686/f <sub>xx</sub> + 285,011 μs	
Checksum	t <sub>WT16</sub>	CSI, CSI+HS	743/f <sub>xx</sub>	
		UART	<b>Note 1</b>	
Read	t <sub>WT17</sub>	CSI, CSI + HS	1,782/f <sub>xx</sub> + 29 μs	
		UART	<b>Note 1</b>	
	t <sub>WT18</sub> <sup>Note 3</sup>	CSI, CSI + HS	14,359/f <sub>xx</sub> + 15 μs	
		UART	<b>Note 4</b>	
	t <sub>WT19</sub>	–	160/f <sub>xx</sub>	<b>Note 5</b>

- Notes**
1. Reception must be enabled for the programmer before command frame transmission. Set the programmer time-out time to 3 seconds or more.
  2. Successive reception must be enabled for the programmer. Set the programmer time-out time to 3 seconds or more.
  3. 64-word units
  4. Reception must be enabled for the programmer before status frame transmission. Set the programmer time-out time to 3 seconds or more.
  5. Wait for ACK code of the status frame from the programmer

**Remark** f<sub>xx</sub>: Main clock frequency

<t<sub>WT0</sub> to t<sub>WT9</sub>, t<sub>WT11</sub> to t<sub>WT19</sub>>

- For parameters with both MIN. and MAX. values specified

The V850ES/Jx3-L completes each command processing between the MIN. and the MAX. times. If the V850ES/Jx3-L does not complete each command processing after the MAX. time has elapsed, execute the error processing (time-out processing, etc.).

In CSI communication, the programmer must repeat the status check from the MIN. time to the MAX. time.

In UART communication, the V850ES/Jx3-L transmits the status frame between the MIN. and the MAX. times.

- For parameters with only MIN. value specified

In CSI communication, the programmer must issue the Status command after the MIN. time has elapsed. If ACK is not returned, do not repeat the status check and execute the error processing (time-out processing, etc.).

<t<sub>WT10</sub>>

The V850ES/Jx3-L is readied for the next communication after the MIN. time has elapsed after completion of the previous communication.

The programmer must transmit the next data after the MIN. time has elapsed after completion of the previous communication.

## &lt;R&gt; (2) Flash memory parameter characteristics (2)

**Target devices:**

V850ES/JG3-L:  $\mu$ PD70F3792, 70F3793, 70F3794, 70F3795, 70F3796, 70F3841, 70F3842, 70F3843, 70F3844

**(a) Operating clock**

The main clock frequency ( $f_{xx}$ ) of the V850ES/Jx3-L is changed according to the value of the main clock oscillation frequency ( $f_x$ ) specified with the Oscillation Frequency Set command by the programmer.

- $2.5 \text{ MHz} \leq f_x \leq 5.0 \text{ MHz}$ :  $f_{xx} = f_x \times 4$  (PLL mode)
- $5.0 \text{ MHz} < f_x \leq 10 \text{ MHz}$ :  $f_{xx} = f_x \times 1$

Therefore, it is obtained by assigning  $f_x$  ( $f_x = f_{xx}$ ) before the Oscillation Frequency Set command (until a wait ( $t_{WT9}$ ) after issuance of the Oscillation Frequency Set command from the programmer) and after that, by assigning a frequency value to  $f_{xx}$  in accordance with the  $f_x$  as shown above.

**Remark** The main clock frequency ( $f_{xx}$ ) is automatically set in the V850ES/Jx3-L in accordance with  $f_x$  in the flash memory programming mode.

**(b) Flash memory programming mode setting time**

Parameter	Symbol	Condition	MIN.	TYP.	MAX.
$V_{DD}\uparrow$ to FLMD0 $\uparrow$	$t_{DP}$		1 ms		
FLMD0 $\uparrow$ to $\overline{\text{RESET}}\uparrow$	$t_{PR}$		2 ms		
Count start time from $\overline{\text{RESET}}\uparrow$ to FLMD0 <sup>Note 1</sup>	$t_{RP}$		800 $\mu\text{s}$		
Count finish time from $\overline{\text{RESET}}\uparrow$ to FLMD0 <sup>Note 1</sup>	$t_{RPE}$				10 ms
FLMD0 counter high-level width/ low-level width	$t_{PW}$		10 $\mu\text{s}$		100 $\mu\text{s}$
Wait for Reset command	$t_{RC}$	CSI, CSI + HS	0.3 s		
Wait for low level (data 1)	$t_{R1}$	UART	0.3 s		
Wait for low level (data 2)	$t_{12}$	UART	30,000/ $f_{XX}$		
Wait for Reset command	$t_{2C}$	UART	30,000/ $f_{XX}$		
Low level width (data 1)	$t_{L1}$	UART		<b>Note 2</b>	
Low level width (data 2)	$t_{L2}$	UART		<b>Note 2</b>	
FLMD0 counter rise time	$t_R$				1 $\mu\text{s}$
FLMD0 counter fall time	$t_F$				1 $\mu\text{s}$

- Notes**
1.  $(t_{RP} + t_{RPE})/2$  is recommended as the standard value for the FLMD0 pin signal input timing.
  2. The low-level width is the same as the 00H data width at 9,600 bps.



**(c) Programming characteristics**

Parameter	Symbol	Condition	MIN.	MAX.	
Data to Data	t <sub>DR</sub>	Receive data frame	CSI, CSI + HS	220/f <sub>xx</sub>	
			UART	220/f <sub>xx</sub>	
	t <sub>DT</sub>	Send data frame	CSI, CSI + HS	203/f <sub>xx</sub>	
			UART	<b>Note</b>	
Status command frame reception to status frame transmission	t <sub>SF</sub>	CSI, CSI + HS	3433/f <sub>xx</sub>		
Status frame reception to data frame transmission (1)	t <sub>FD1</sub>	CSI, CSI + HS	$1,391/f_{xx} + 212,585/f_{xx} \times M + 29 \mu s$	$1,670/f_{xx} + 255,102/f_{xx} \times M + 35 \mu s$	
		UART	<b>Note</b>	$1,670/f_{xx} + 255,102/f_{xx} \times M + 35 \mu s$	
Status frame transmission to data frame transmission (2)	t <sub>FD2</sub>	CSI, CSI + HS	$6,606/f_{xx} + 86 \mu s$		
		UART	<b>Note</b>		
Status frame transmission to data frame reception (3)	t <sub>FD3</sub>	CSI, CSI + HS	$3,950/f_{xx} + 43 \mu s$		
		UART	$3,950/f_{xx} + 43 \mu s$		
Status frame transmission to command frame reception	t <sub>COM</sub>	–	$886/f_{xx} + 15 \mu s$		

**Note** Successive reception must be enabled for the programmer. Set the programmer time-out time to 3 seconds or more.

**Remark** M: Number of blocks  
f<sub>xx</sub>: Main clock frequency

<t<sub>DR</sub>, t<sub>FD3</sub>, t<sub>COM</sub>>

The V850ES/Jx3-L is readied for the next communication after the MIN. time has elapsed after completion of the previous communication.

The programmer must transmit the next data after the MIN. time has elapsed after completion of the previous communication.

<t<sub>DT</sub>, t<sub>SF</sub>, t<sub>FD2</sub>>

The V850ES/Jx3-L is readied for the next communication after the MIN. time has elapsed after completion of the previous communication.

The programmer must receive the next data after the MIN. time has elapsed after completion of the previous communication.

In CSI communication, the programmer must issue the Status command after the MIN. time has elapsed. If ACK is not returned, do not repeat the status check and execute the error processing (time-out processing, etc.).

<t<sub>FD1</sub>>

The V850ES/Jx3-L completes each command processing between the MIN. and MAX. times. If the V850ES/Jx3-L does not complete each command processing after the MAX. time has elapsed, execute the error processing (time-out processing, etc.).

In CSI communication, the programmer must repeat the status check from the MIN. time to MAX. time.

In UART communication, the V850ES/Jx3-L transmits the status frame between the MIN. and MAX. times.

## (d) Command characteristics

(1/2)

Command	Symbol	Condition	MIN.	MAX.
Reset	t <sub>WT0</sub>	CSI, CSI + HS	295/f <sub>xx</sub>	
		UART	<b>Note 1</b>	
Chip Erase	t <sub>WT1</sub>	–	48,514/f <sub>xx</sub> + 70,227 μs	51,147/f <sub>xx</sub> + 1,655,137 μs
Block Erase	t <sub>WT2</sub>	–	5,986/f <sub>xx</sub> + (716/f <sub>xx</sub> + 14,227 μs + 308 μs × BM) + (... <sup>Note 2</sup> ) + 58 μs	7,551/f <sub>xx</sub> + (716/f <sub>xx</sub> + 284,521 μs + 6,144 μs × BM) + (... <sup>Note 2</sup> ) + 86 μs
Program	t <sub>WT3</sub>	CSI, CSI + HS	3,968/f <sub>xx</sub> + 58 μs	
		UART	<b>Note 1</b>	
	t <sub>WT4</sub> <sup>Note 3</sup>	–	21,638/f <sub>xx</sub> + 593 μs	574,637/f <sub>xx</sub> + 18,226 μs
	t <sub>WT5</sub>	CSI, CSI + HS	4,097/f <sub>xx</sub> + (388,519/f <sub>xx</sub> + 2,071 μs) × M + 31 μs	4,917/f <sub>xx</sub> + (466,223/f <sub>xx</sub> + 2,486 μs) × M + 38 μs
UART		<b>Note 4</b>	4,917/f <sub>xx</sub> + (466,223/f <sub>xx</sub> + 2,486 μs) × M + 38 μs	
Verify	t <sub>WT6</sub>	CSI, CSI + HS	606/f <sub>xx</sub>	
		UART	<b>Note 1</b>	
	t <sub>WT7</sub> <sup>Note 3</sup>	CSI, CSI + HS	11,681/f <sub>xx</sub> + 66 μs	
		UART	<b>Note 5</b>	
Block Blank Check	t <sub>WT8</sub>	–	4,295/f <sub>xx</sub> + (690/f <sub>xx</sub> + 20 μs + 308 μs × BM) + (... <sup>Note 2</sup> ) + 29 μs	5,154/f <sub>xx</sub> + (828/f <sub>xx</sub> + 24 μs + 369 μs × BM) + (... <sup>Note 2</sup> ) + 35 μs
Oscillating Frequency Set	t <sub>WT9</sub>	CSI, CSI + HS	10,727/f <sub>xx</sub>	
		UART	<b>Note 1</b>	
Baud Rate Set	t <sub>WT10</sub>	UART	4,436/f <sub>xx</sub>	
Silicon Signature	t <sub>WT11</sub>	CSI, CSI + HS	703/f <sub>xx</sub>	
		UART	<b>Note 1</b>	
Version Get	t <sub>WT12</sub>	CSI, CSI + HS	724/f <sub>xx</sub>	
		UART	<b>Note 1</b>	

**Notes 1.** Reception must be enabled for the programmer before command frame transmission. Set the programmer time-out time to 3 seconds or more.

- 2.** When how many times the simultaneous selection processing is repeated is indicated by BN, perform the calculation in the parentheses, as shown in the Example below.

**Example** When executing simultaneous processing with changing block size from 2 → 4 → 8

(Block Erase command's MIN. value) (BN = 3)

$$5,986/f_{xx} + (716/f_{xx} + 14,227 \mu s + 308 \mu s \times 2) + (716/f_{xx} + 14,227 \mu s + 308 \mu s \times 4) + (716/f_{xx} + 14,227 \mu s + 308 \mu s \times 8) + 58 \mu s$$

- 3.** 64-word units
- 4.** Successive reception must be enabled for the programmer. Set the programmer time-out time to 3 seconds or more.
- 5.** Reception must be enabled for the programmer before data frame transmission. Set the programmer time-out time to 3 seconds or more.

**Remark** M: Number of blocks

BM: Number of blocks to be selected and processed simultaneously (blocks)

BN: Number of executions of simultaneous selection and processing (number of repetitions of addition in the parentheses in Table above)

f<sub>xx</sub>: Main clock frequency

**(d) Command characteristics**

(2/2)

Command	Symbol	Condition	MIN.	MAX.
Security Setting	t <sub>WT13</sub>	CSI, CSI + HS	624/f <sub>xx</sub>	
		UART	<b>Note 1</b>	
	t <sub>WT14</sub>	–	27,223/f <sub>xx</sub> + 1,976 μs	31,069/f <sub>xx</sub> + 299,176 μs
	t <sub>WT15</sub>	CSI, CSI + HS	14,435/f <sub>xx</sub> + 14,703 μs	14,435/f <sub>xx</sub> + 285,008 μs
UART		<b>Note 2</b>	14,435/f <sub>xx</sub> + 285,008 μs	
Checksum	t <sub>WT16</sub>	CSI, CSI+HS	784/f <sub>xx</sub>	
		UART	<b>Note 1</b>	
Read	t <sub>WT17</sub>	CSI, CSI + HS	2,343/f <sub>xx</sub> + 29 μs	
		UART	<b>Note 1</b>	
	t <sub>WT18</sub> <sup>Note 3</sup>	CSI, CSI + HS	13,817/f <sub>xx</sub> + 15 μs	
		UART	<b>Note 4</b>	
	t <sub>WT19</sub>	–	213/f <sub>xx</sub>	<b>Note 5</b>

- Notes**
1. Reception must be enabled for the programmer before command frame transmission. Set the programmer time-out time to 3 seconds or more.
  2. Successive reception must be enabled for the programmer. Set the programmer time-out time to 3 seconds or more.
  3. 64-word units
  4. Reception must be enabled for the programmer before status frame transmission. Set the programmer time-out time to 3 seconds or more.
  5. Wait for ACK code of the status frame from the programmer

**Remark** f<sub>xx</sub>: Main clock frequency

<t<sub>WT0</sub> to t<sub>WT9</sub>, t<sub>WT11</sub> to t<sub>WT19</sub>>

- For parameters with both MIN. and MAX. values specified

The V850ES/Jx3-L completes each command processing between the MIN. and the MAX. times. If the V850ES/Jx3-L does not complete each command processing after the MAX. time has elapsed, execute the error processing (time-out processing, etc.).

In CSI communication, the programmer must repeat the status check from the MIN. time to the MAX. time.

In UART communication, the V850ES/Jx3-L transmits the status frame between the MIN. and the MAX. times.

- For parameters with only MIN. value specified

In CSI communication, the programmer must issue the Status command after the MIN. time has elapsed. If ACK is not returned, do not repeat the status check and execute the error processing (time-out processing, etc.).

<t<sub>WT10</sub>>

The V850ES/Jx3-L is readied for the next communication after the MIN. time has elapsed after completion of the previous communication.

The programmer must transmit the next data after the MIN. time has elapsed after completion of the previous communication.

CSI Communication Timing

(1/3)

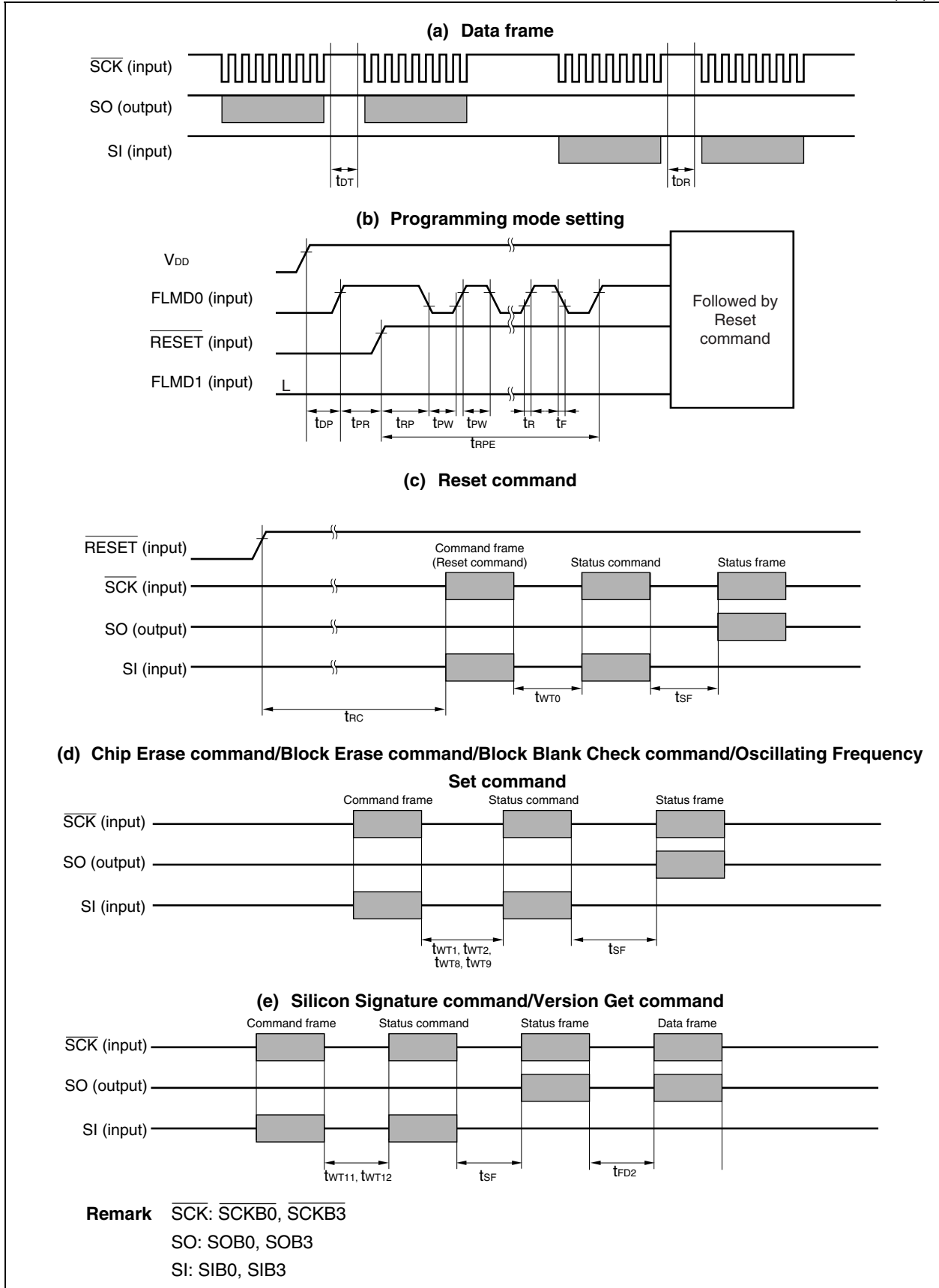

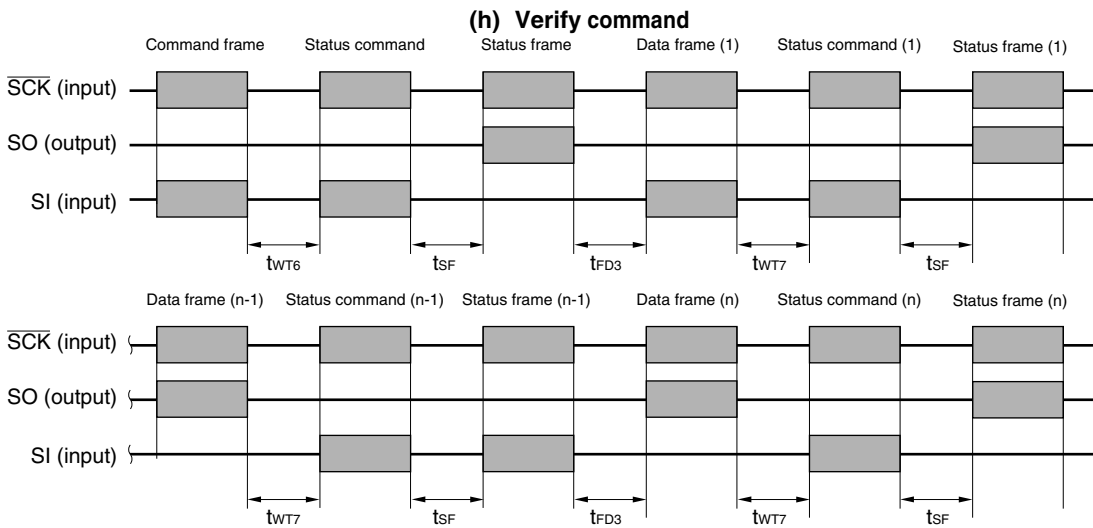
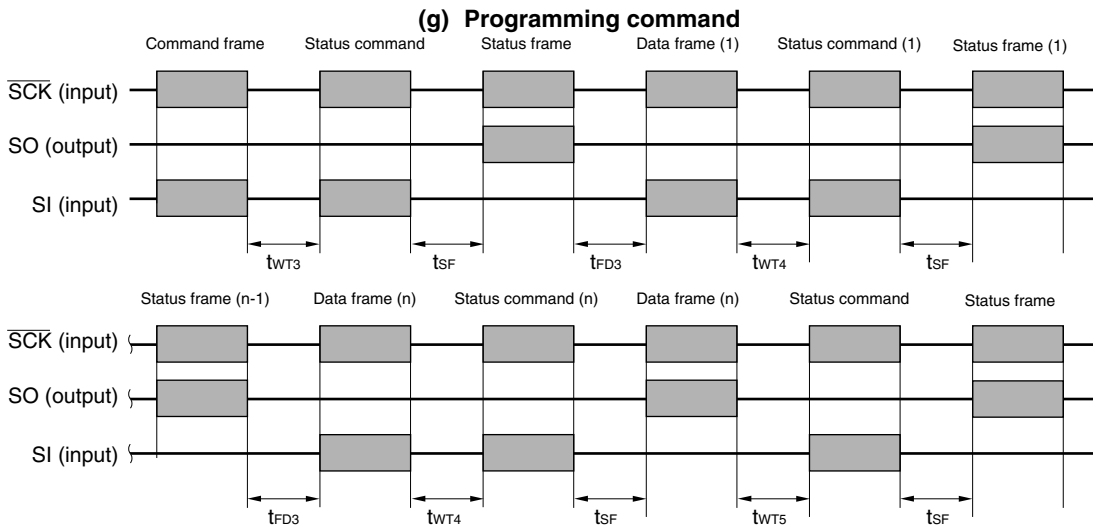
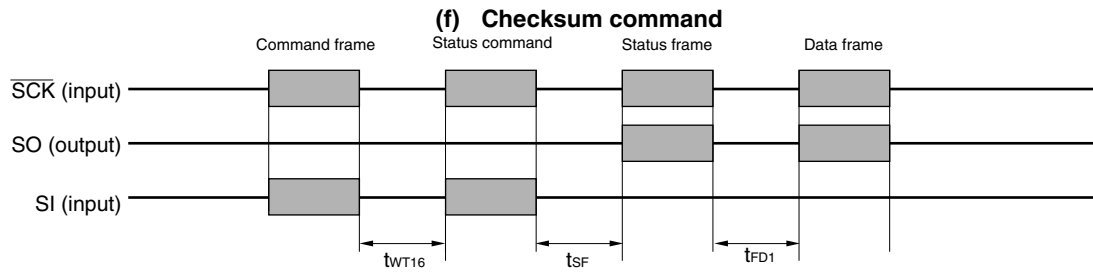

**Remark**  $\overline{SCK}$ : SCKB0, SCKB3  
 $\overline{SO}$ : SOB0, SOB3  
 $\overline{SI}$ : SIB0, SIB3

**(i) Security Setting command**

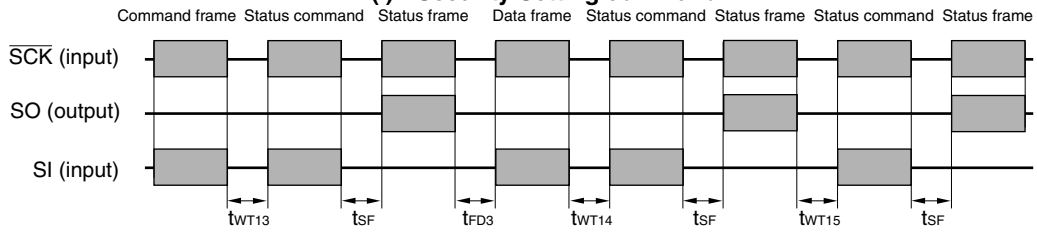

**(j) Read command**

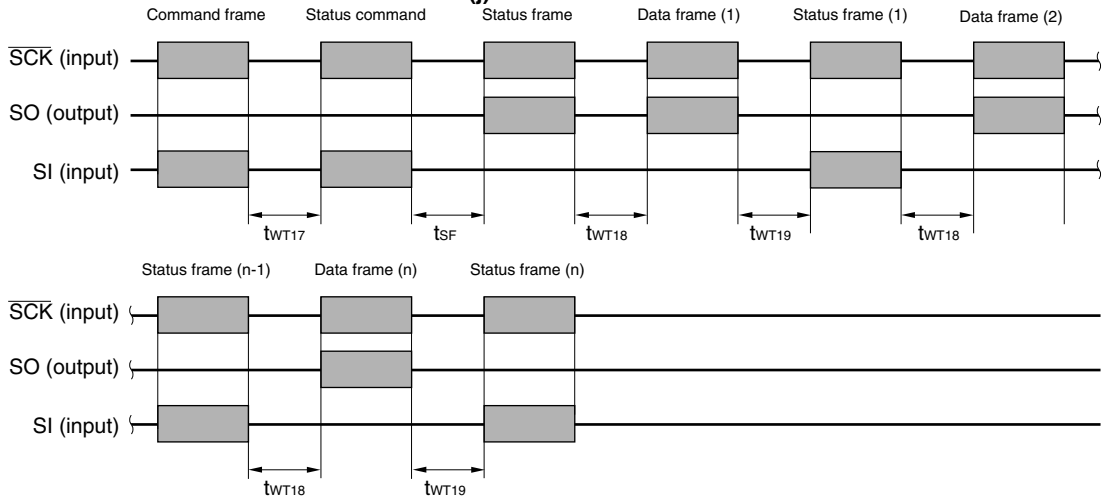

**(k) Wait before command frame transmission**

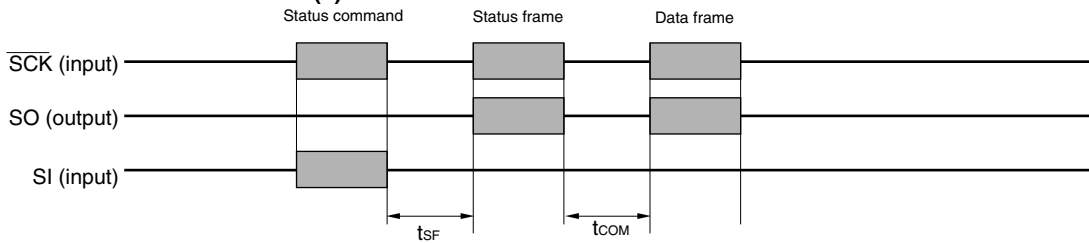

**Remark**  $\overline{\text{SCK}}$ : SCKB0, SCKB3  
SO: SOB0, SOB3  
SI: SIB0, SIB3

UART communication timing

(1/3)

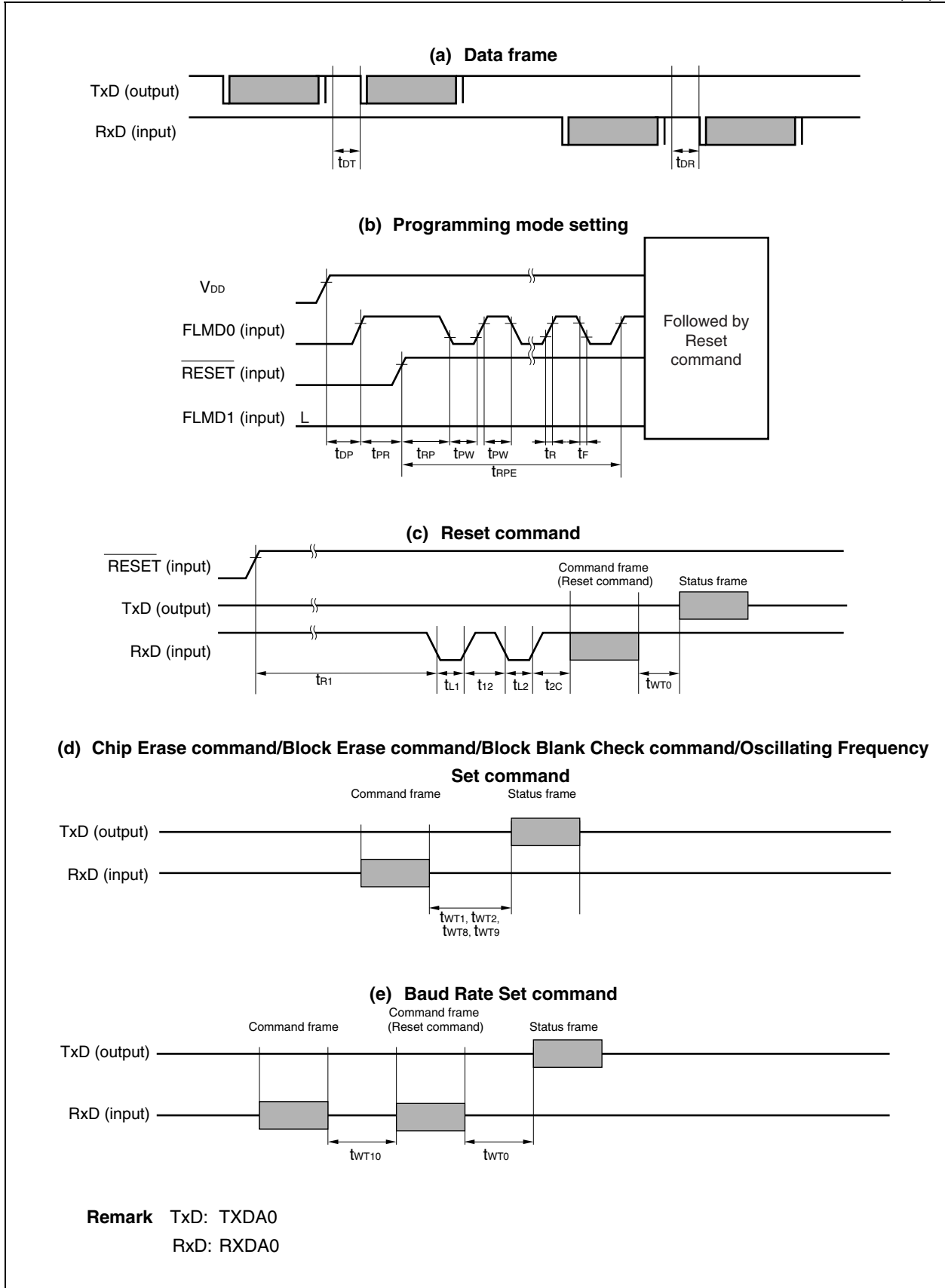

**(f) Silicon Signature command/Version Get command**

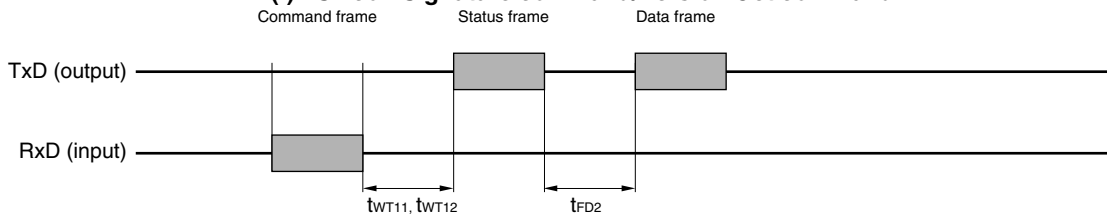

**(g) Checksum command**

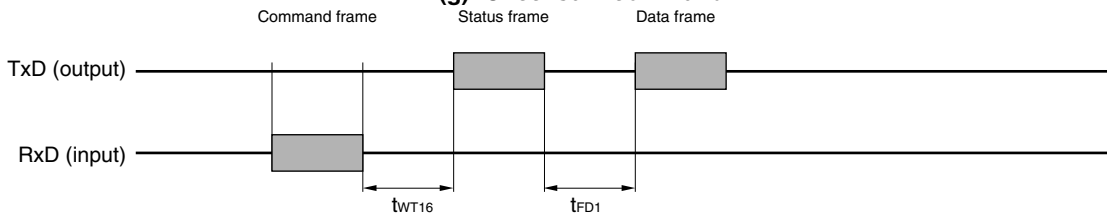

**(h) Programming command**

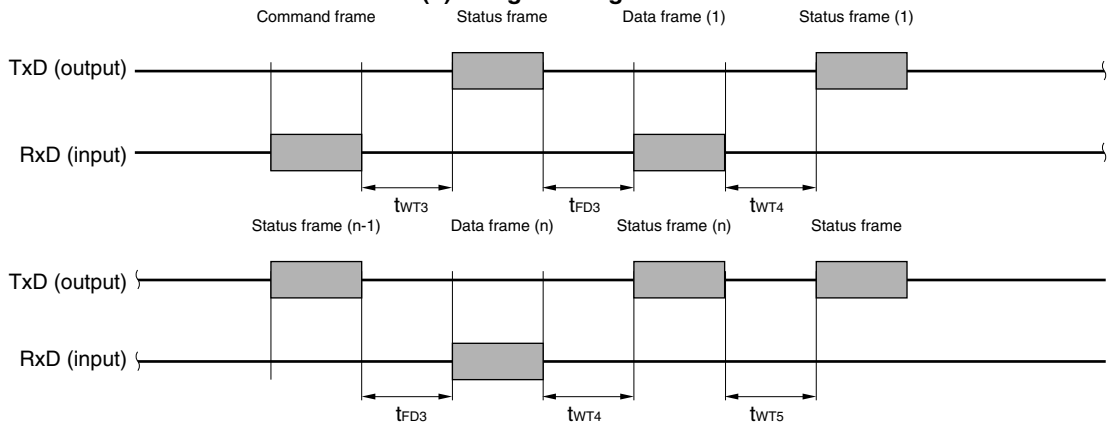

**(i) Verify command**

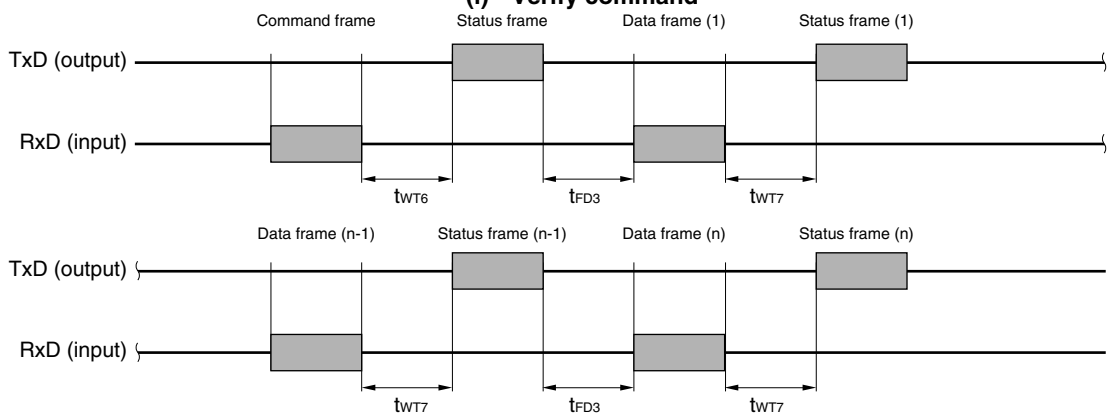

**Remark** TxD: TXDA0  
RxD: RXDA0



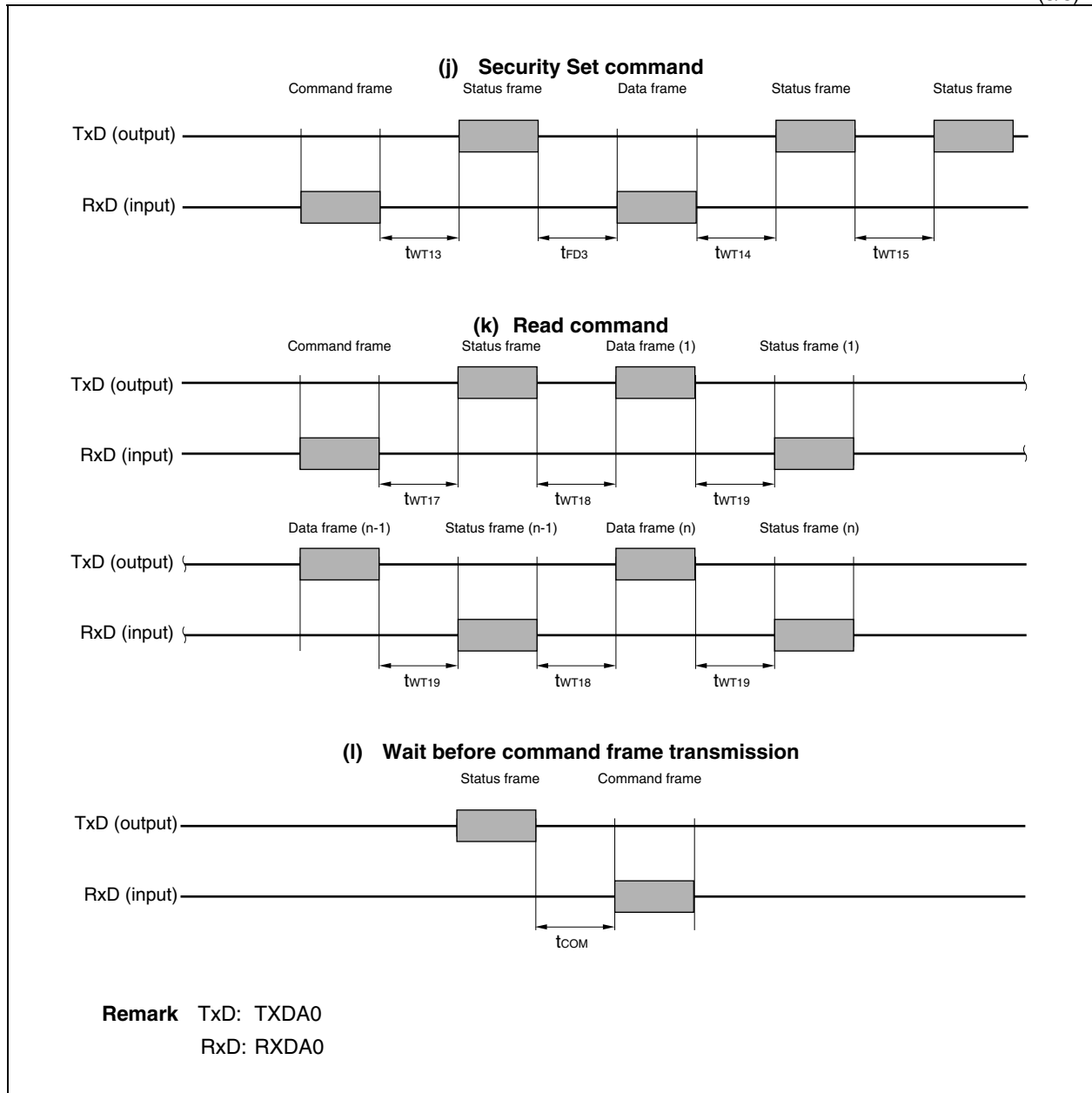

**(2) Simultaneous selection block processing**

The block erasure, blank check, and internal verification functions are executed by repeating “simultaneous selection and processing”, which processes multiple blocks simultaneously.

The wait time is therefore equal to the total execution time of “simultaneous selection and processing”.

To calculate the total execution time of simultaneous selection and processing, the execution count (BN) and the number of blocks (BM) to be selected and processed simultaneously must first be calculated.

**(a) Number of blocks (BM) and execution count (BN) of the simultaneous selection and processing**

BN is calculated by obtaining the number of blocks to be processed simultaneously (BM: number of blocks to be selected and processed simultaneously).

The number of blocks to be selected and processed simultaneously (BM) should be 1, 2, 4, 8, 16, 32, 64, or 128, depending on which satisfies all of the following conditions.

[Condition 1]

Number of blocks (ER\_BKNUM) processed  $\geq$  Potential number of blocks to be selected and processed simultaneously (SSER\_BKNUM)

[Condition 2]

Start block number (ST\_BKNO) / Potential number of blocks to be selected and processed simultaneously (SSER\_BKNUM) = Remainder is 0

[Condition 3]

The maximum value among the values that satisfy both Conditions 1 and 2

Example of simultaneous selection block processing that satisfies Conditions 1, 2, and 3 is shown below.

**Example 1** Processing blocks 1 to 127

<1> The first start block number is 1 and the number of blocks to be processed is 127, so the values that satisfy Condition 1 are as follows.

1, 2, 4, 8, 16, 32, 64

The value that satisfies Condition 2 is as follows.

1

The value that satisfies Condition 3 is therefore 1, so the number of blocks to be selected and processed simultaneously (BM) is 1. Thus only block 1 is processed.

<2> After block 1 is processed, the next start block number is 2 and the number of blocks to be processed is 126, so the values that satisfy Condition 1 are as follows.

1, 2, 4, 8, 16, 32, 64

The values that satisfy Condition 2 are as follows.

1, 2

The value that satisfies Condition 3 is therefore 2, so the number of blocks to be selected and processed simultaneously (BM) is 2. Thus blocks 2 and 3 are processed.

<3> After blocks 2 and 3 are processed, the next start block number is 4 and the number of blocks to be processed is 124, so the values that satisfy Condition 1 are as follows.

1, 2, 4, 8, 16, 32, 64

The values that satisfy Condition 2 are as follows.

1, 2, 4

The value that satisfies Condition 3 is therefore 4, so the number of blocks to be selected and processed simultaneously (BM) is 4. Thus blocks 4 to 7 are processed.

<4> After blocks 4 to 7 are processed, the next start block number is 8 and the number of blocks to be processed is 120, so the values that satisfy Condition 1 are as follows.

1, 2, 4, 8, 16, 32, 64

The values that satisfy Condition 2 are as follows.

1, 2, 4, 8

The value that satisfies Condition 3 is therefore 8, so the number of blocks to be selected and processed simultaneously (BM) is 8. Thus blocks 8 to 15 are processed.

<5> After blocks 8 to 15 are processed, the next start block number is 16 and the number of blocks to be processed is 112, so the values that satisfy Condition 1 are as follows.

1, 2, 4, 8, 16, 32, 64

The values that satisfy Condition 2 are as follows.

1, 2, 4, 8, 16

The value that satisfies Condition 3 is therefore 16, so the number of blocks to be selected and processed simultaneously (BM) is 16. Thus blocks 16 to 31 are processed.

<6> After blocks 16 to 31 are processed, the next start block number is 32 and the number of blocks to be processed is 96, so the values that satisfy Condition 1 are as follows.

1, 2, 4, 8, 16, 32, 64

The values that satisfy Condition 2 are as follows.

1, 2, 4, 8, 16, 32

The value that satisfies Condition 3 is therefore 32, so the number of blocks to be selected and processed simultaneously (BM) is 32. Thus blocks 32 to 63 are processed.

<7> After blocks 32 to 63 are processed, the next start block number is 64 and the number of blocks to be processed is 64, so the values that satisfy Condition 1 are as follows.

1, 2, 4, 8, 16, 32, 64

The values that satisfy Condition 2 are as follows.

1, 2, 4, 8, 16, 32, 64

The value that satisfies Condition 3 is therefore 64, so the number of blocks to be selected and processed simultaneously (BM) is 64. Thus blocks 64 to 127 are processed.

Therefore, simultaneous selection and processing is executed seven times (1, 2 and 3, 4 to 7, 8 to 15, 16 to 31, 32 to 63, and 64 to 127) to erase blocks 1 to 127, so BN = 7 is obtained.

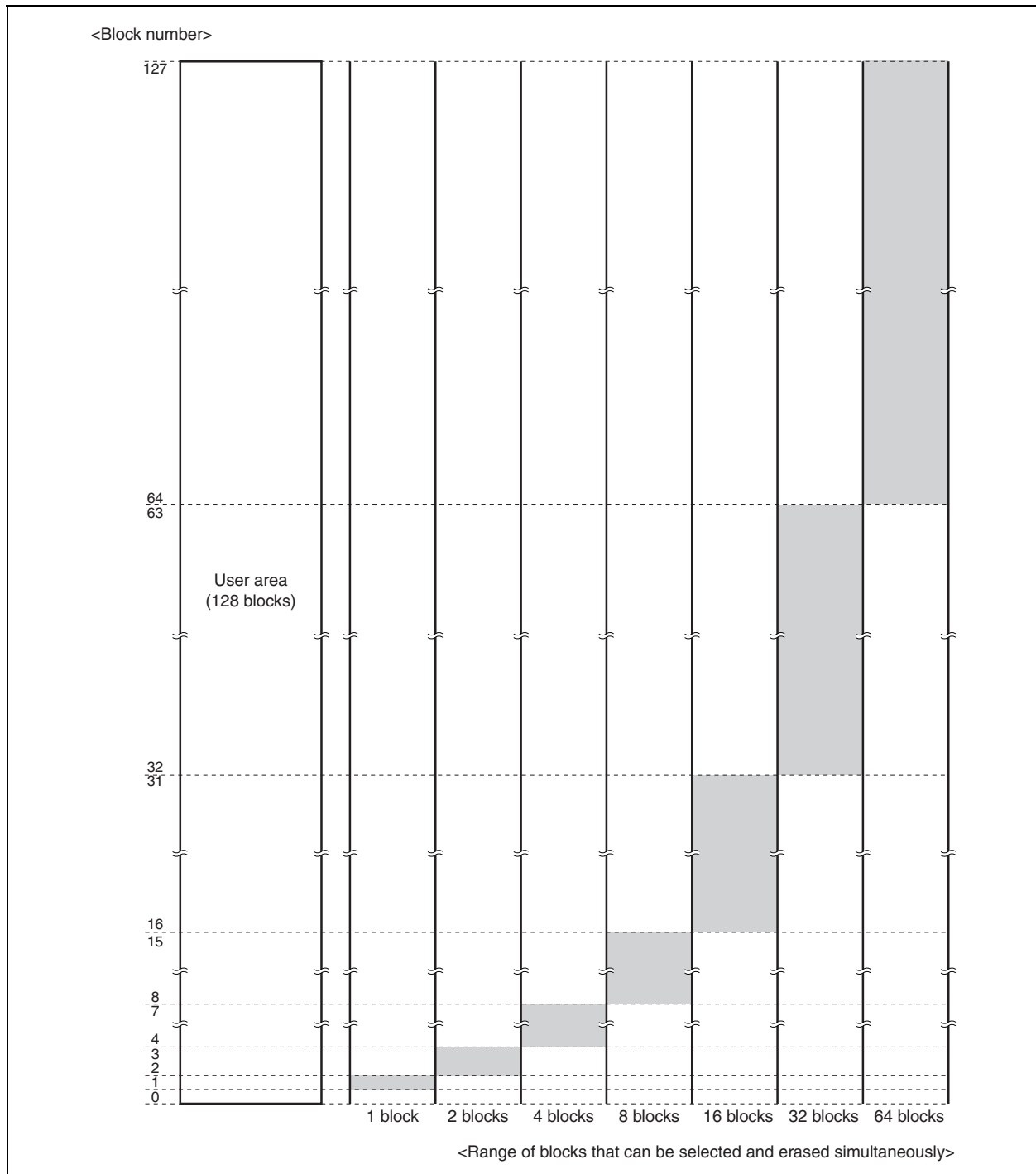

**Example 2** Processing blocks 5 to 10

<1> The first start block number is 5 and the number of blocks to be processed is 6, so the values that satisfy Condition 1 are as follows.

1, 2, 4

The value that satisfies Condition 2 is as follows.

1

The value that satisfies Condition 3 is therefore 1, so the number of blocks to be selected and processed simultaneously (BM) is 1. Thus only block 5 is processed.

<2> After block 5 is processed, the next start block number is 6 and the number of blocks to be processed is 5, so the values that satisfy Condition 1 are as follows.

1, 2, 4

The values that satisfy Condition 2 are as follows.

1, 2

The value that satisfies Condition 3 is therefore 2, so the number of blocks to be selected and processed simultaneously (BM) is 2. Thus blocks 6 and 7 are processed.

<3> After blocks 6 and 7 are processed, the next start block number is 8 and the number of blocks to be processed is 3, so the values that satisfy Condition 1 are as follows.

1, 2

The values that satisfy Condition 2 are as follows.

1, 2

The value that satisfies Condition 3 is therefore 2, so the number of blocks to be selected and processed simultaneously (BM) is 2. Thus blocks 8 and 9 are processed.

<4> After blocks 8 and 9 are processed, the next start block number is 10 and the number of blocks to be processed is 1, so the value that satisfies Condition 1 is as follows.

1

This also satisfies Conditions 2 and 3, so the number of blocks to be selected and processed simultaneously (BM) is 1. Thus block 10 is processed.

Therefore, simultaneous selection and processing is executed four times (5, 6 and 7, 8 and 9, and 10) to erase blocks 5 to 10, so BN = 4 is obtained.

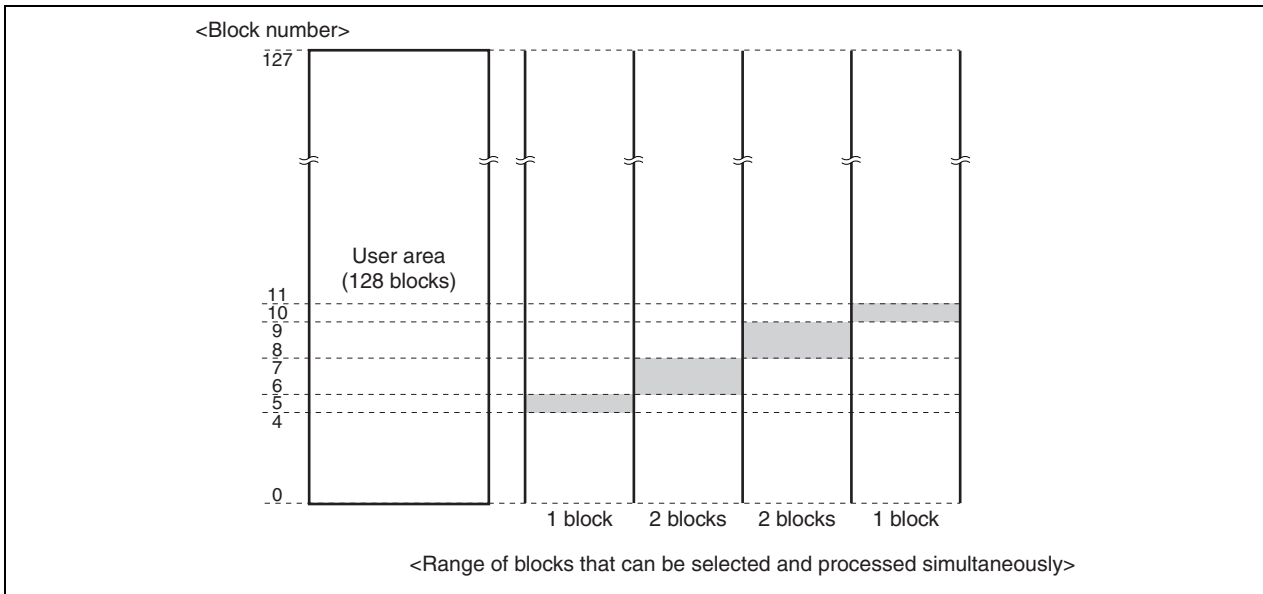

An example of how to obtain BM and BN satisfying Conditions 1, 2, and 3 is illustrated in the following flowchart.

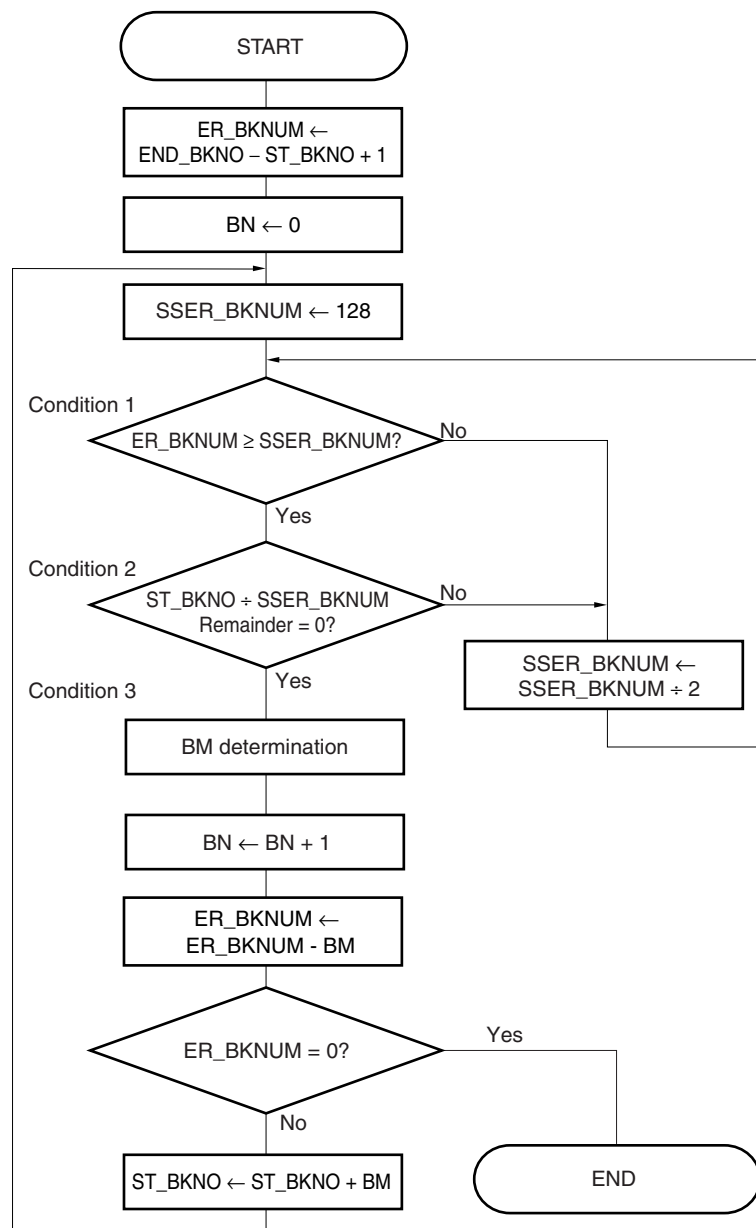

**Remark** ST\_BKNO: Start block number  
 END\_BKNO: End block number  
 ER\_BKNUM: Number of blocks to be erased  
 SSER\_BKNUM: Potential number of blocks to be selected and processed simultaneously  
 BM: Number of blocks to be selected and processed simultaneously  
 BN: Number of executions of simultaneous selection and processing



---

**APPENDIX A CIRCUIT DIAGRAM (REFERENCE)**

Figures A-1 and A-2 show circuit diagrams of the programmer and the V850ES/Jx3-L, for reference.

Figure A-1. Reference Circuit Diagram of Programmer and V850ES/Jx3-L (Main Board)

V850E/Jx3-L Flash Programmer Sample Application Main Board

(VDD = 5.0V)

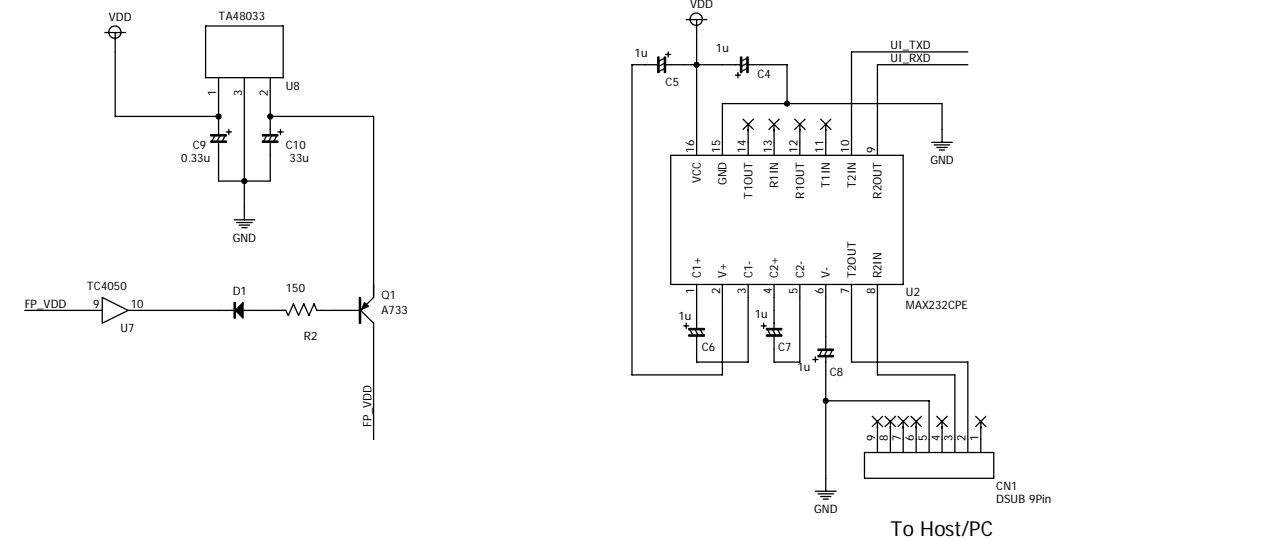
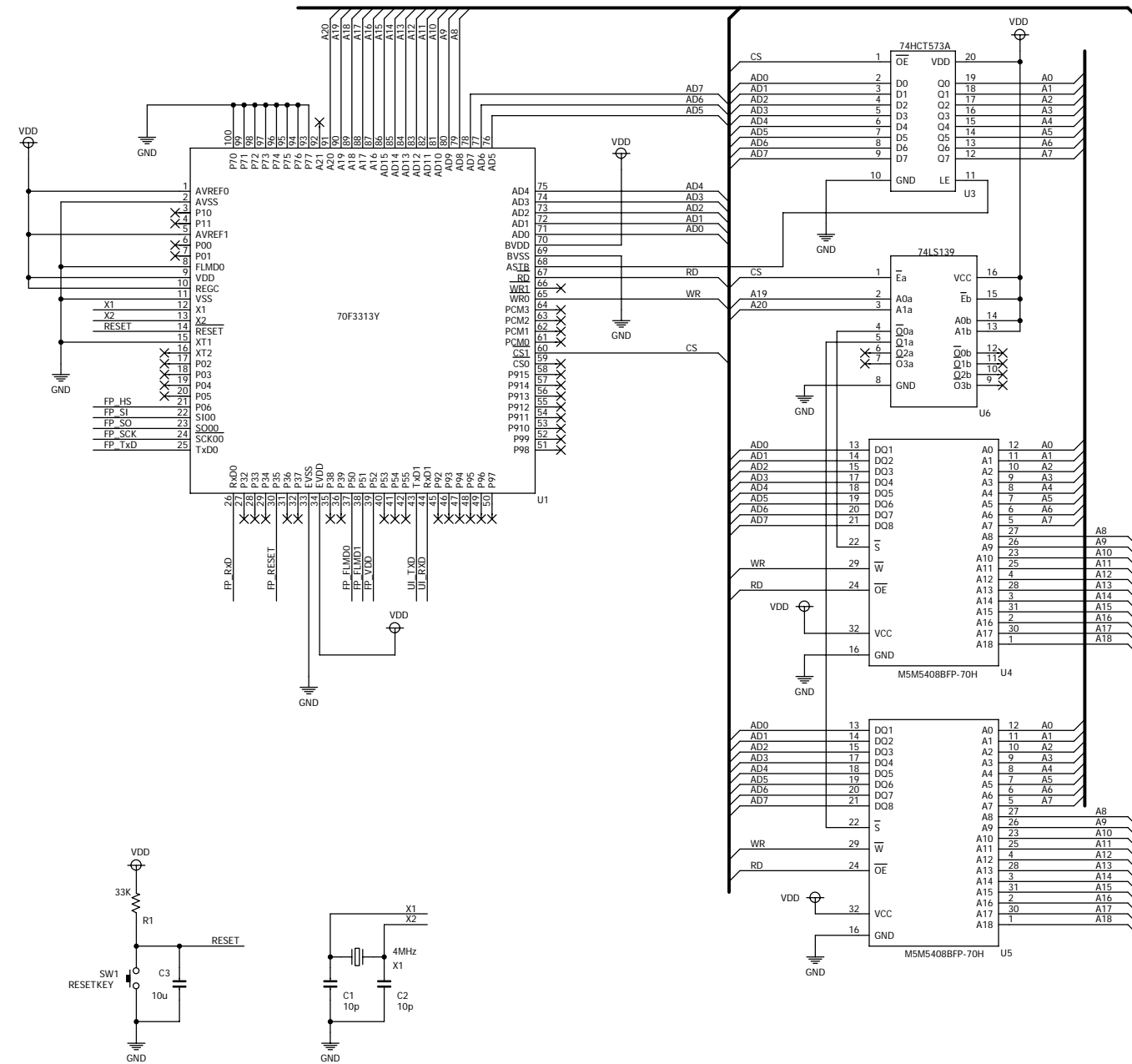

5V - 3V Interactive Level Shifter

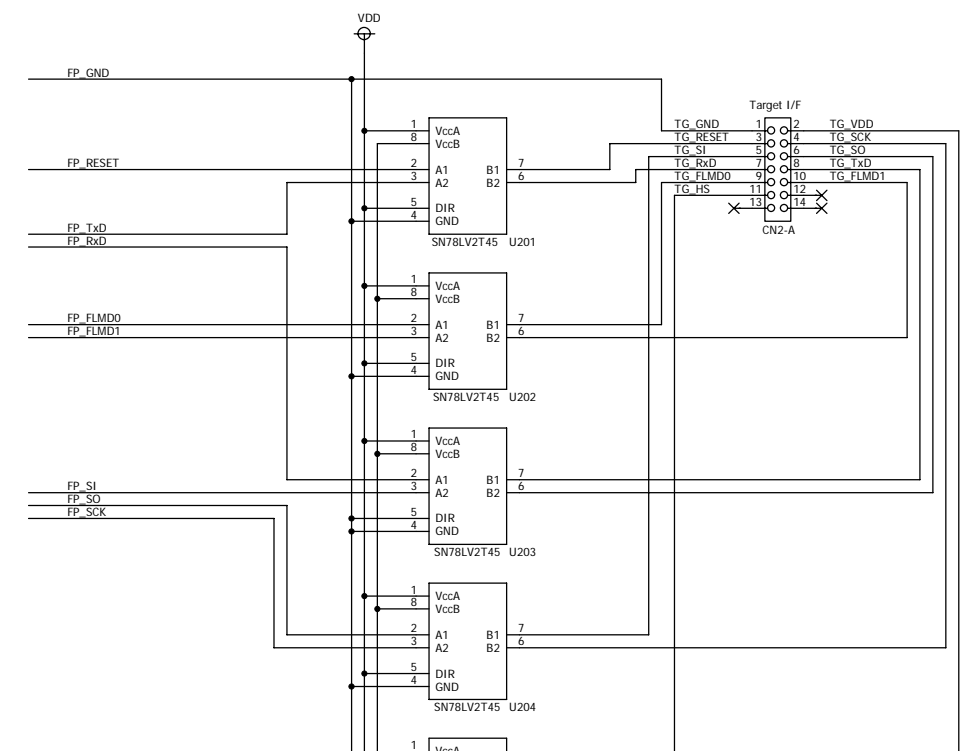

**Remark** For how to handle unused pins shown in this circuit diagram, see the user's manual of each product.

Figure A-2. Reference Circuit Diagram of Programmer and V850ES/Jx3-L (Target Board)

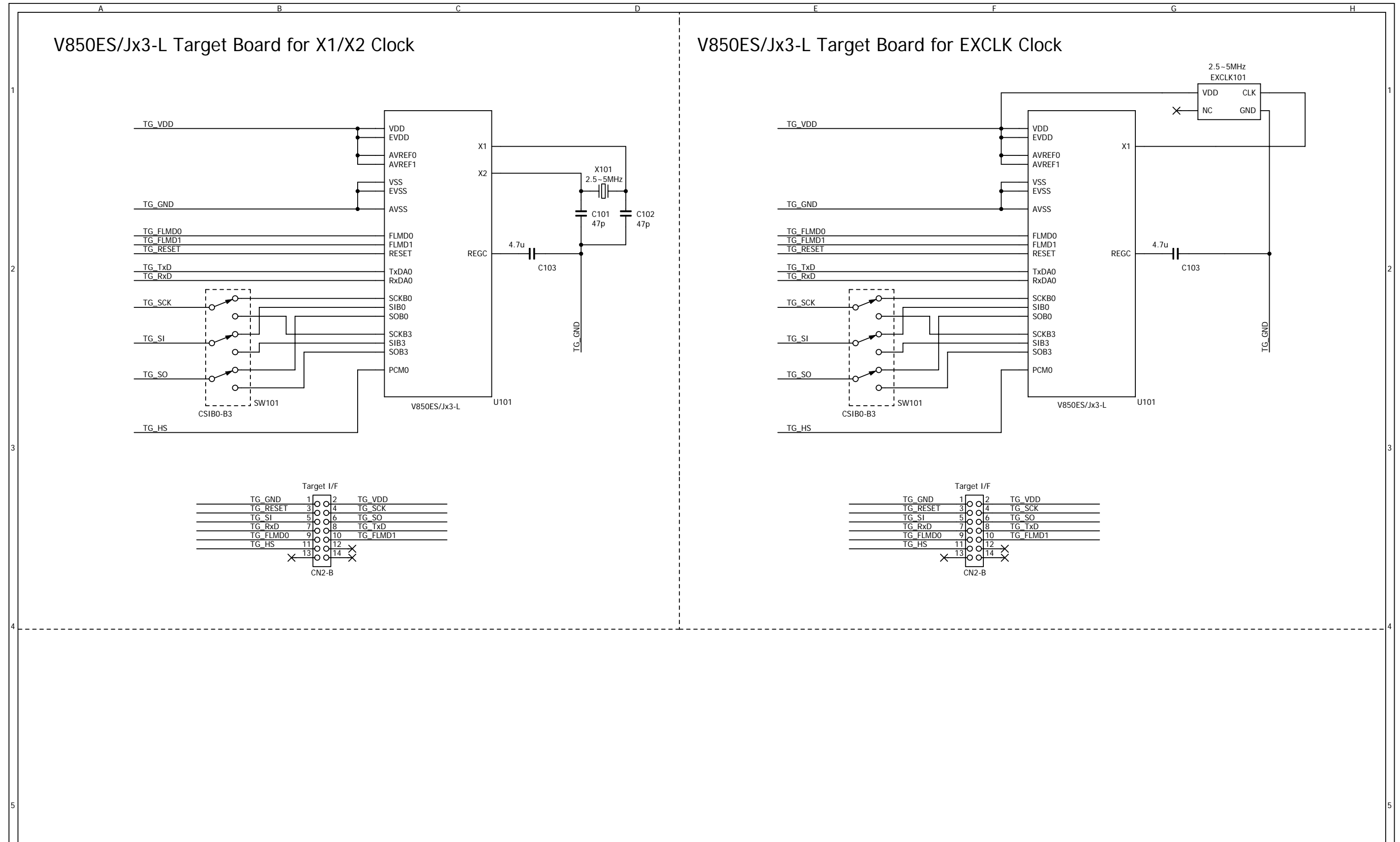

**Remark** For how to handle unused pins shown in this circuit diagram, see the user's manual of each product.

## Website and Support

Renesas Electronics Website

<http://www.renesas.com/>

Inquiries

<http://www.renesas.com/inquiry>

## Revision Record

Rev.	Date	Description	
		Page	Summary
1.00	Dec. 28, 2010	—	First edition issued
2.00	May 20, 2011	Throughout	Addition of the following target devices $\mu$ PD70F3797, 70F3798, 70F3799, 70F3800, 70F3801, 70F3802, 70F3803, 70F3804, 70F3838, 70F3839, 70F3805, 70F3806, 70F3807, 70F3808, 70F3840, 70F3792, 70F3793, 70F3794, 70F3795, 70F3796, 70F3841, 70F3842, 70F3843, 70F3844
		42	Modification of <b>3.10.3 Silicon signature data frame</b>
		44	Modification of <b>3.10.4 V850ES/Jx3-L silicon signature data list</b>
		49	Modification of <b>3.13 Security Set Command</b>
		242, 247 to 251	CHAPTER 7 FLASH MEMORY PROGRAMMING PARAMETER CHARACTERISTICS <ul style="list-style-type: none"> <li>• Modification of <b>(1) Flash memory parameter characteristics (1)</b></li> <li>• Addition of <b>(2) Flash memory parameter characteristics (2)</b></li> </ul>

## NOTES FOR CMOS DEVICES

- (1) **VOLTAGE APPLICATION WAVEFORM AT INPUT PIN:** Waveform distortion due to input noise or a reflected wave may cause malfunction. If the input of the CMOS device stays in the area between  $V_{IL}$  (MAX) and  $V_{IH}$  (MIN) due to noise, etc., the device may malfunction. Take care to prevent chattering noise from entering the device when the input level is fixed, and also in the transition period when the input level passes through the area between  $V_{IL}$  (MAX) and  $V_{IH}$  (MIN).
- (2) **HANDLING OF UNUSED INPUT PINS:** Unconnected CMOS device inputs can be cause of malfunction. If an input pin is unconnected, it is possible that an internal input level may be generated due to noise, etc., causing malfunction. CMOS devices behave differently than Bipolar or NMOS devices. Input levels of CMOS devices must be fixed high or low by using pull-up or pull-down circuitry. Each unused pin should be connected to VDD or GND via a resistor if there is a possibility that it will be an output pin. All handling related to unused pins must be judged separately for each device and according to related specifications governing the device.
- (3) **PRECAUTION AGAINST ESD:** A strong electric field, when exposed to a MOS device, can cause destruction of the gate oxide and ultimately degrade the device operation. Steps must be taken to stop generation of static electricity as much as possible, and quickly dissipate it when it has occurred. Environmental control must be adequate. When it is dry, a humidifier should be used. It is recommended to avoid using insulators that easily build up static electricity. Semiconductor devices must be stored and transported in an anti-static container, static shielding bag or conductive material. All test and measurement tools including work benches and floors should be grounded. The operator should be grounded using a wrist strap. Semiconductor devices must not be touched with bare hands. Similar precautions need to be taken for PW boards with mounted semiconductor devices.
- (4) **STATUS BEFORE INITIALIZATION:** Power-on does not necessarily define the initial status of a MOS device. Immediately after the power source is turned ON, devices with reset functions have not yet been initialized. Hence, power-on does not guarantee output pin levels, I/O settings or contents of registers. A device is not initialized until the reset signal is received. A reset operation must be executed immediately after power-on for devices with reset functions.
- (5) **POWER ON/OFF SEQUENCE:** In the case of a device that uses different power supplies for the internal operation and external interface, as a rule, switch on the external power supply after switching on the internal power supply. When switching the power supply off, as a rule, switch off the external power supply and then the internal power supply. Use of the reverse power on/off sequences may result in the application of an overvoltage to the internal elements of the device, causing malfunction and degradation of internal elements due to the passage of an abnormal current. The correct power on/off sequence must be judged separately for each device and according to related specifications governing the device.
- (6) **INPUT OF SIGNAL DURING POWER OFF STATE :** Do not input signals or an I/O pull-up power supply while the device is not powered. The current injection that results from input of such a signal or I/O pull-up power supply may cause malfunction and the abnormal current that passes in the device at this time may cause degradation of internal elements. Input of signals during the power off state must be judged separately for each device and according to related specifications governing the device.

## Notice

- All information included in this document is current as of the date this document is issued. Such information, however, is subject to change without any prior notice. Before purchasing or using any Renesas Electronics products listed herein, please confirm the latest product information with a Renesas Electronics sales office. Also, please pay regular and careful attention to additional and different information to be disclosed by Renesas Electronics such as that disclosed through our website.
- Renesas Electronics does not assume any liability for infringement of patents, copyrights, or other intellectual property rights of third parties by or arising from the use of Renesas Electronics products or technical information described in this document. No license, express, implied or otherwise, is granted hereby under any patents, copyrights or other intellectual property rights of Renesas Electronics or others.
- You should not alter, modify, copy, or otherwise misappropriate any Renesas Electronics product, whether in whole or in part.
- Descriptions of circuits, software and other related information in this document are provided only to illustrate the operation of semiconductor products and application examples. You are fully responsible for the incorporation of these circuits, software, and information in the design of your equipment. Renesas Electronics assumes no responsibility for any losses incurred by you or third parties arising from the use of these circuits, software, or information.
- When exporting the products or technology described in this document, you should comply with the applicable export control laws and regulations and follow the procedures required by such laws and regulations. You should not use Renesas Electronics products or the technology described in this document for any purpose relating to military applications or use by the military, including but not limited to the development of weapons of mass destruction. Renesas Electronics products and technology may not be used for or incorporated into any products or systems whose manufacture, use, or sale is prohibited under any applicable domestic or foreign laws or regulations.
- Renesas Electronics has used reasonable care in preparing the information included in this document, but Renesas Electronics does not warrant that such information is error free. Renesas Electronics assumes no liability whatsoever for any damages incurred by you resulting from errors in or omissions from the information included herein.
- Renesas Electronics products are classified according to the following three quality grades: "Standard", "High Quality", and "Specific". The recommended applications for each Renesas Electronics product depends on the product's quality grade, as indicated below. You must check the quality grade of each Renesas Electronics product before using it in a particular application. You may not use any Renesas Electronics product for any application categorized as "Specific" without the prior written consent of Renesas Electronics. Further, you may not use any Renesas Electronics product for any application for which it is not intended without the prior written consent of Renesas Electronics. Renesas Electronics shall not be in any way liable for any damages or losses incurred by you or third parties arising from the use of any Renesas Electronics product for an application categorized as "Specific" or for which the product is not intended where you have failed to obtain the prior written consent of Renesas Electronics. The quality grade of each Renesas Electronics product is "Standard" unless otherwise expressly specified in a Renesas Electronics data sheets or data books, etc.  
"Standard": Computers; office equipment; communications equipment; test and measurement equipment; audio and visual equipment; home electronic appliances; machine tools; personal electronic equipment; and industrial robots.  
"High Quality": Transportation equipment (automobiles, trains, ships, etc.); traffic control systems; anti-disaster systems; anti-crime systems; safety equipment; and medical equipment not specifically designed for life support.  
"Specific": Aircraft; aerospace equipment; submersible repeaters; nuclear reactor control systems; medical equipment or systems for life support (e.g. artificial life support devices or systems), surgical implantations, or healthcare intervention (e.g. excision, etc.), and any other applications or purposes that pose a direct threat to human life.
- You should use the Renesas Electronics products described in this document within the range specified by Renesas Electronics, especially with respect to the maximum rating, operating supply voltage range, movement power voltage range, heat radiation characteristics, installation and other product characteristics. Renesas Electronics shall have no liability for malfunctions or damages arising out of the use of Renesas Electronics products beyond such specified ranges.
- Although Renesas Electronics endeavors to improve the quality and reliability of its products, semiconductor products have specific characteristics such as the occurrence of failure at a certain rate and malfunctions under certain use conditions. Further, Renesas Electronics products are not subject to radiation resistance design. Please be sure to implement safety measures to guard them against the possibility of physical injury, and injury or damage caused by fire in the event of the failure of a Renesas Electronics product, such as safety design for hardware and software including but not limited to redundancy, fire control and malfunction prevention, appropriate treatment for aging degradation or any other appropriate measures. Because the evaluation of microcomputer software alone is very difficult, please evaluate the safety of the final products or system manufactured by you.
- Please contact a Renesas Electronics sales office for details as to environmental matters such as the environmental compatibility of each Renesas Electronics product. Please use Renesas Electronics products in compliance with all applicable laws and regulations that regulate the inclusion or use of controlled substances, including without limitation, the EU RoHS Directive. Renesas Electronics assumes no liability for damages or losses occurring as a result of your noncompliance with applicable laws and regulations.
- This document may not be reproduced or duplicated, in any form, in whole or in part, without prior written consent of Renesas Electronics.
- Please contact a Renesas Electronics sales office if you have any questions regarding the information contained in this document or Renesas Electronics products, or if you have any other inquiries.  
(Note 1) "Renesas Electronics" as used in this document means Renesas Electronics Corporation and also includes its majority-owned subsidiaries.  
(Note 2) "Renesas Electronics product(s)" means any product developed or manufactured by or for Renesas Electronics.



### SALES OFFICES

Renesas Electronics Corporation

<http://www.renesas.com>

Refer to "<http://www.renesas.com/>" for the latest and detailed information.

**Renesas Electronics America Inc.**  
2880 Scott Boulevard Santa Clara, CA 95050-2554, U.S.A.  
Tel: +1-408-586-6000, Fax: +1-408-586-6130

**Renesas Electronics Canada Limited**  
1101 Nicholson Road, Newmarket, Ontario L3Y 9C3, Canada  
Tel: +1-905-898-5441, Fax: +1-905-898-3220

**Renesas Electronics Europe Limited**  
Dukes Meadow, Millboard Road, Bourne End, Buckinghamshire, SL8 5FH, U.K  
Tel: +44-1628-585-100, Fax: +44-1628-585-900

**Renesas Electronics Europe GmbH**  
Arcadiastrasse 10, 40472 Düsseldorf, Germany  
Tel: +49-211-65030, Fax: +49-211-6503-1327

**Renesas Electronics (China) Co., Ltd.**  
7th Floor, Quantum Plaza, No.27 ZhiChunLu Haidian District, Beijing 100083, P.R.China  
Tel: +86-10-8235-1155, Fax: +86-10-8235-7679

**Renesas Electronics (Shanghai) Co., Ltd.**  
Unit 204, 205, AZIA Center, No.1233 Lujiazui Ring Rd., Pudong District, Shanghai 200120, China  
Tel: +86-21-5877-1818, Fax: +86-21-6887-7858 / -7898

**Renesas Electronics Hong Kong Limited**  
Unit 1601-1613, 16/F., Tower 2, Grand Century Place, 193 Prince Edward Road West, Mongkok, Kowloon, Hong Kong  
Tel: +852-2886-9318, Fax: +852 2886-9022/9044

**Renesas Electronics Taiwan Co., Ltd.**  
7F, No. 363 Fu Shing North Road Taipei, Taiwan  
Tel: +886-2-8175-9600, Fax: +886 2-8175-9670

**Renesas Electronics Singapore Pte. Ltd.**  
1 HarbourFront Avenue, #06-10, Keppel Bay Tower, Singapore 098632  
Tel: +65-6213-0200, Fax: +65-6276-8001

**Renesas Electronics Malaysia Sdn.Bhd.**  
Unit 906, Block B, Menara Amcorp, Amcorp Trade Centre, No. 18, Jin Persiaran Barat, 46050 Petaling Jaya, Selangor Darul Ehsan, Malaysia  
Tel: +60-3-7955-9390, Fax: +60-3-7955-9510

**Renesas Electronics Korea Co., Ltd.**  
11F., Samik Lavied' or Bldg., 720-2 Yeoksam-Dong, Kangnam-Ku, Seoul 135-080, Korea  
Tel: +82-2-558-3737, Fax: +82-2-558-5141