

RL78/G23 Group

RL78/G23 ZMOD4410 Sensor Device Sample

Introduction

This document describes a Renesas microcontroller RL78/G23 application for a ZMOD4410 sensor device using the RL78/G23 128-pin Fast Prototyping Board.

Target Device

RL78/G23

When applying the sample program covered in this document to another microcomputer, modify the program according to the specifications for the target microcomputer and conduct an extensive evaluation of the modified program.

Contents

1. Description	3
1.1 Abstract.....	3
1.2 Specifications and Main Technical Parameters.....	3
2. RL78/G23 Microcontroller	4
2.1 RL78/G23 Block Diagram	4
2.2 Key Features.....	5
2.3 Pin Assignments	7
3. System Outline	8
3.1 Principle Introduction	8
3.2 Peripheral Functions to be Used	10
3.3 Pins to be Used	10
3.4 Operating Instructions.....	11
4. Hardware	12
4.1 Schematics	13
5. Software	14
5.1 Integrated Development Environment	14
5.2 Operation Outline	14
5.3 Flow Chart.....	15
5.4 File Compositions	16
6. How to Add Sensor Middleware using Smart Configurator in e2studio	17
7. How to Build the Project and How to Program the Output File	21
7.1 Build in e2studio	21
7.2 Writing srec file using Renesas Flash Programmer	21
8. Sample Code	22
9. Reference Documents	22

1. Description

1.1 Abstract

The ZMOD4410 sensors device sample is a precision digital sensor featuring indoor air quality using the RL78/G23-128p Fast Prototyping Board. With an OLED screen, it makes all the information well displayed and shows different levels of indoor environment quality in different colors, with each color corresponding to a different level of health concern. The backlight makes it possible to view the screen and every detail from every angle, even in the dark night.

The RL78/G23-128p Fast Prototyping Board comes equipped with a high-performance RL78/G23 microcontroller and is an evaluation board specialized for prototype development for a variety of applications. It has a built-in USB-to-serial converter, so you can write/debug programs without additional tools. In addition, with Arduino Uno and Pmod™ interfaces included standard and through-hole access to all pins of the microcontroller, and so on, it has high expandability.

The US082-ZMOD4410EVZ Gas Sensor Module is designed for detecting total volatile organic compounds (TVOC) and monitoring indoor air quality (IAQ). It is a 12-pin LGA assembly (3.0 x 3.0 x 0.7 mm) that consists of a gas sense element and a CMOS signal conditioning IC. The module's sense element consists of a heater element on a Si-based MEMS structure and a metal oxide (MOx) chemiresistor. The signal conditioner controls the sensor temperature and measures the MOx conductivity, which is a function of the gas concentration. The measurement results can be read via an I2C interface with the user's microprocessor, which processes the data to determine the TVOC concentration, IAQ rating and estimated carbon dioxide (eCO2) level. This flexibility makes the sensors in the US082-ZMOD4410EVZ platform capable of providing a variety of measurement options by varying the method of operation or changing the firmware used to interpret the resistance measurements. Downloadable firmware libraries and source code provided by IDT enables detection of TVOC and odors and supports smart devices measuring IAQ that require low-power operation. The US082-ZMOD4410EVZ is ideal for applications such as thermostats, air purifiers, building controls, smart fans, HVAC equipment, and smart devices.

1.2 Specifications and Main Technical Parameters

Technical Parameters

• Power Supply	USB power supply (5 V)
• Operating Voltage (MCU)	3.3 V
• Operating Temperature:	Ambient temperature
• OLED Display Pattern	12 character * 4 row

Specifications

- Function: Detect indoor air quality with US082-ZMOD4410EVZ.
Display the air quality information on an OLED screen.
Information in different colors on the OLED screen correspond to different levels of air quality.

2. RL78/G23 Microcontroller

2.1 RL78/G23 Block Diagram

Figure 2.1 shows the block diagram of RL78/G23.

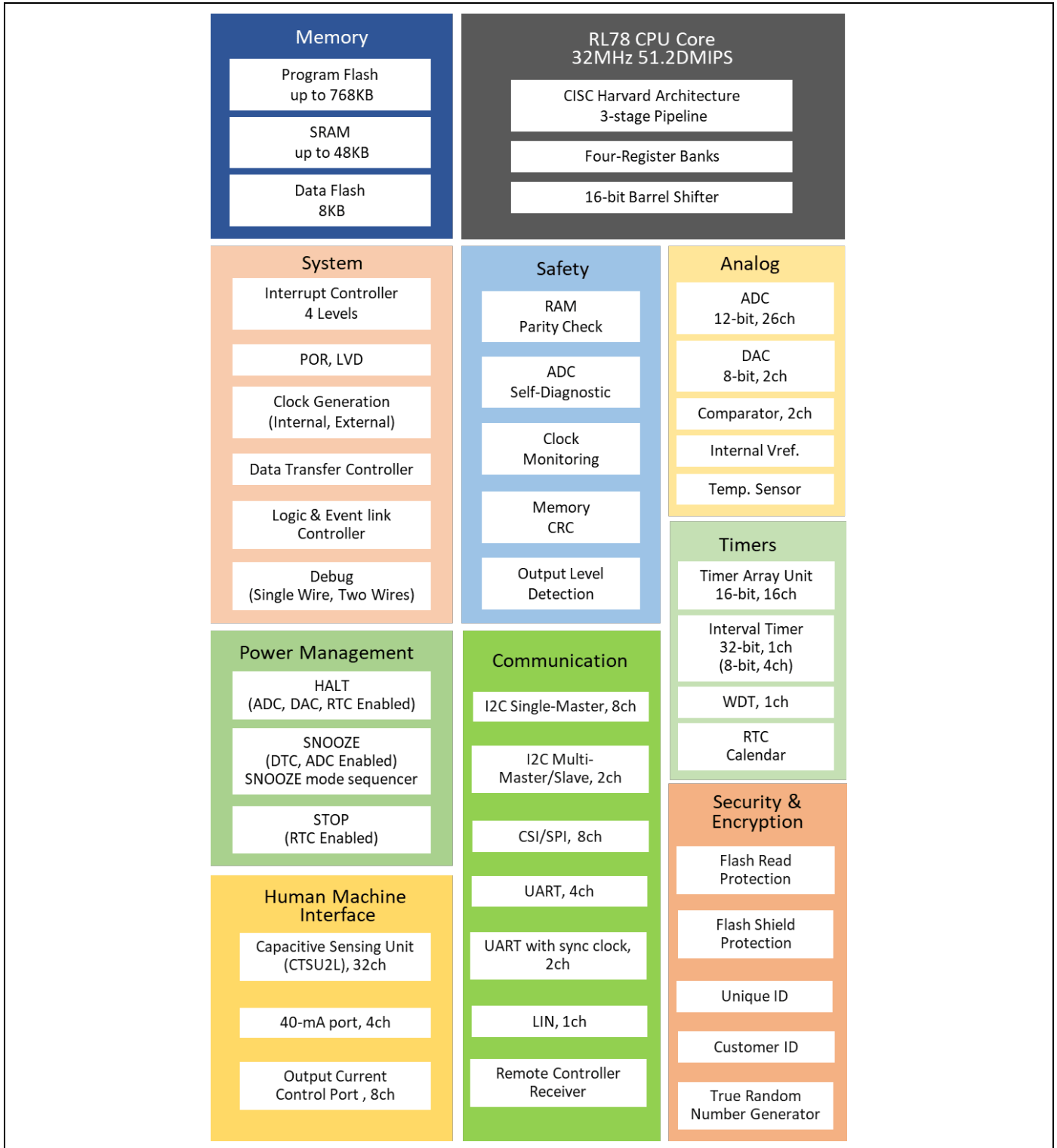

Figure 2.1 RL78/G23 Block Diagram

2.2 Key Features

- CPU: RL78 core, Max. 32MHz
- Up to 768kB Flash Memory and 48kB SRAM
- Memory: SRAM up to 48KB, Program Flash up to 768KB
- 8KB Data Flash to store data as in EEPROM
- Scalable from 30-pin to 128-pin packages
- Wide operating voltage range of 1.6V to 5.5V
- Enhanced Capacitive Sensing Unit (CTS2L)
- Timer: 16-bit Timer (ch) x 16, 8-bit Timer, Watchdog Timer (ch) x 1, 32-bit Interval Timer x 1 ch
- PWM: PWM Output x 14
- Analog function: 12-bit A/D Converter (ch) x 26, 8-bit D/A - Converter (ch) x 2, Comparator x 2
- On-chip Oscillator Freq. (MHz): High-Speed: up to 32MHz
- Middle-Speed: up to 4MHz
- Low-speed: 32.768kHz
- Snooze mode sequencer
- Logic & Event link controller
- Others: RTC, Power-On Reset, Low Voltage Detection
- A large selection of packages (LQFP, QFN, LGA, BGA, WLCSP)

For more detailed information, you may refer to the RL78/G23 User's Manual: Hardware (R01UH0896).

2.3 Pin Assignments

Figure 2.2 shows the pin assignments of RL78/G23 (128-pin products).

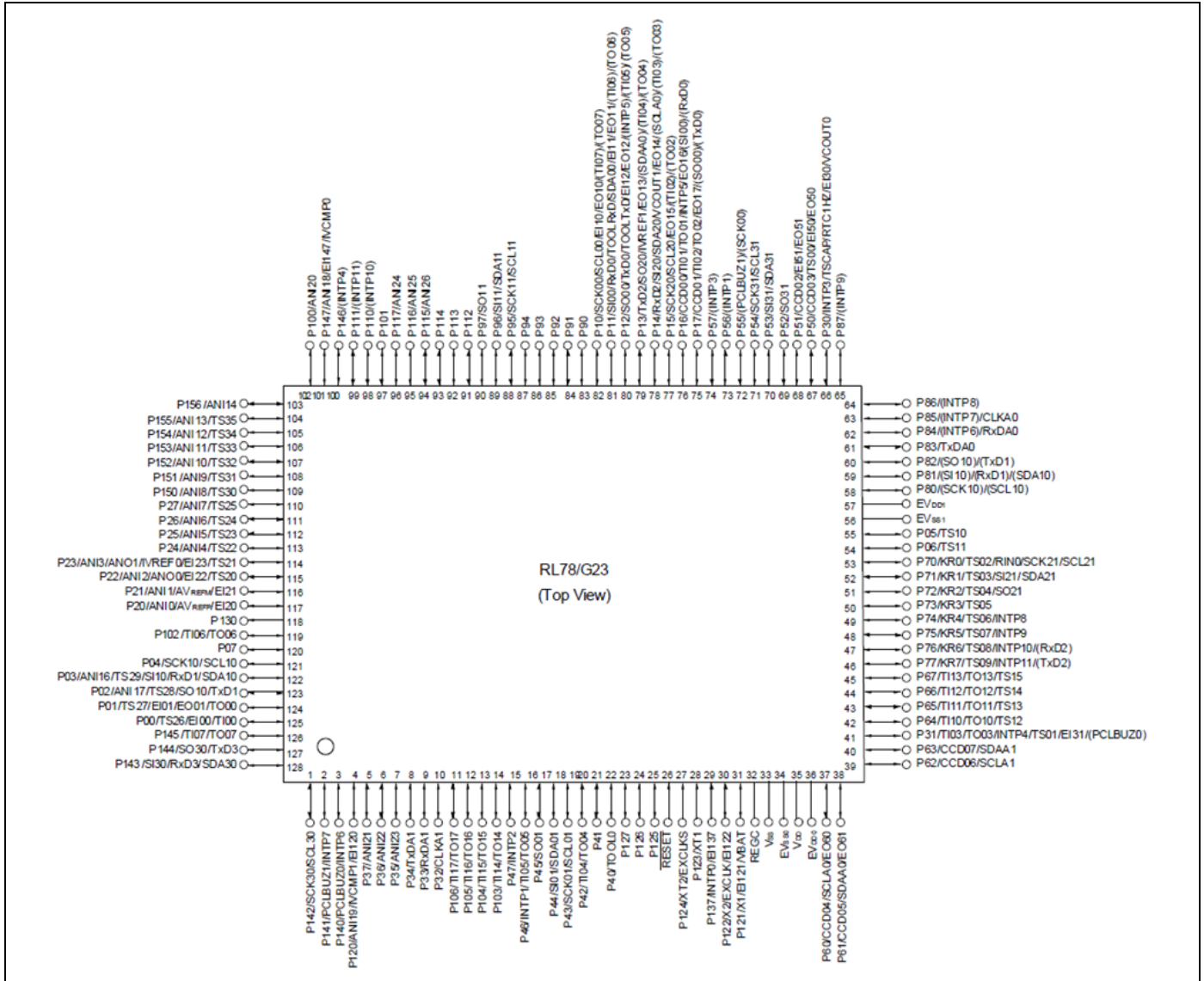

Figure 2.2 RL78/G23 (128-pin products) Pin Assignments

3. System Outline

3.1 Principle Introduction

The ZMOD4410 Sensor Device Sample uses an RL78/G23 microcontroller and a digital gas sensor. After detecting the indoor air quality, the MCU (RL78/G23) sends the sensing data to the Pmod OLEDrgb module and visualizes the corresponding information on the OLED screen.

Figure 3.1 shows the system composition. Figure 3.2 shows the RL78/G23-128p-FPB PMOD Interface. Figure 3.3 shows the connection of RL78/G23-128p-FPB, PMOD OLED RGB and TVOC and Indoor Air Quality Sensor Pmod™ Board (US082-ZMOD4410EVZ).

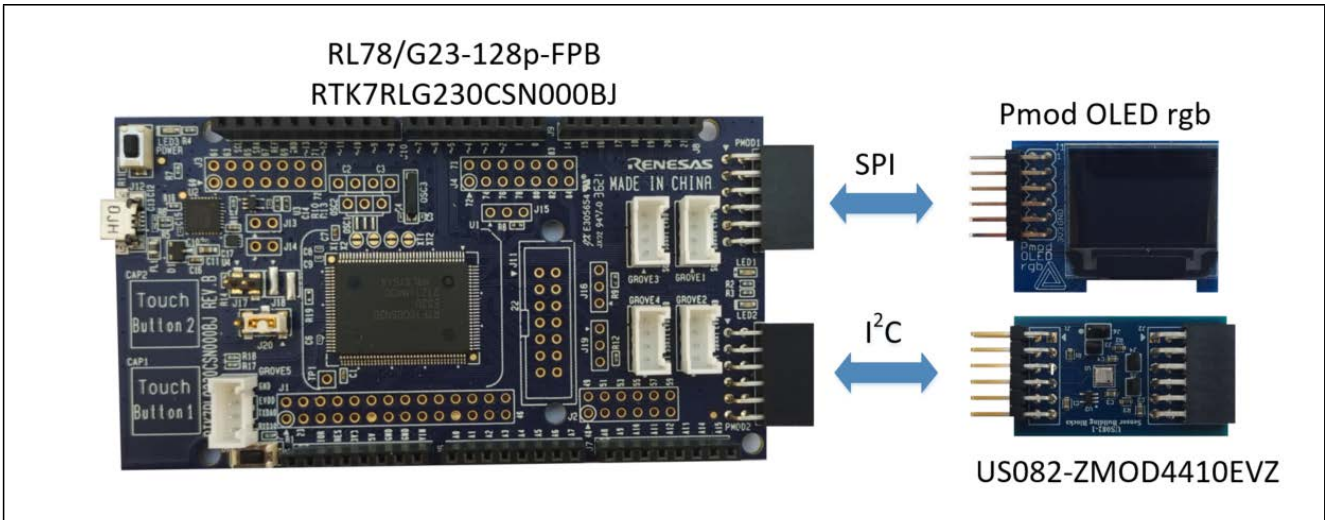

Figure 3.1 System Composition

Note: When using COM port to debug RL78/G23-128p-FPB, be sure that 2-3 of J20 being short-circuit (select a 3.3-V power supply). If you select 5V power supply, ZMOD4410 will be damaged.

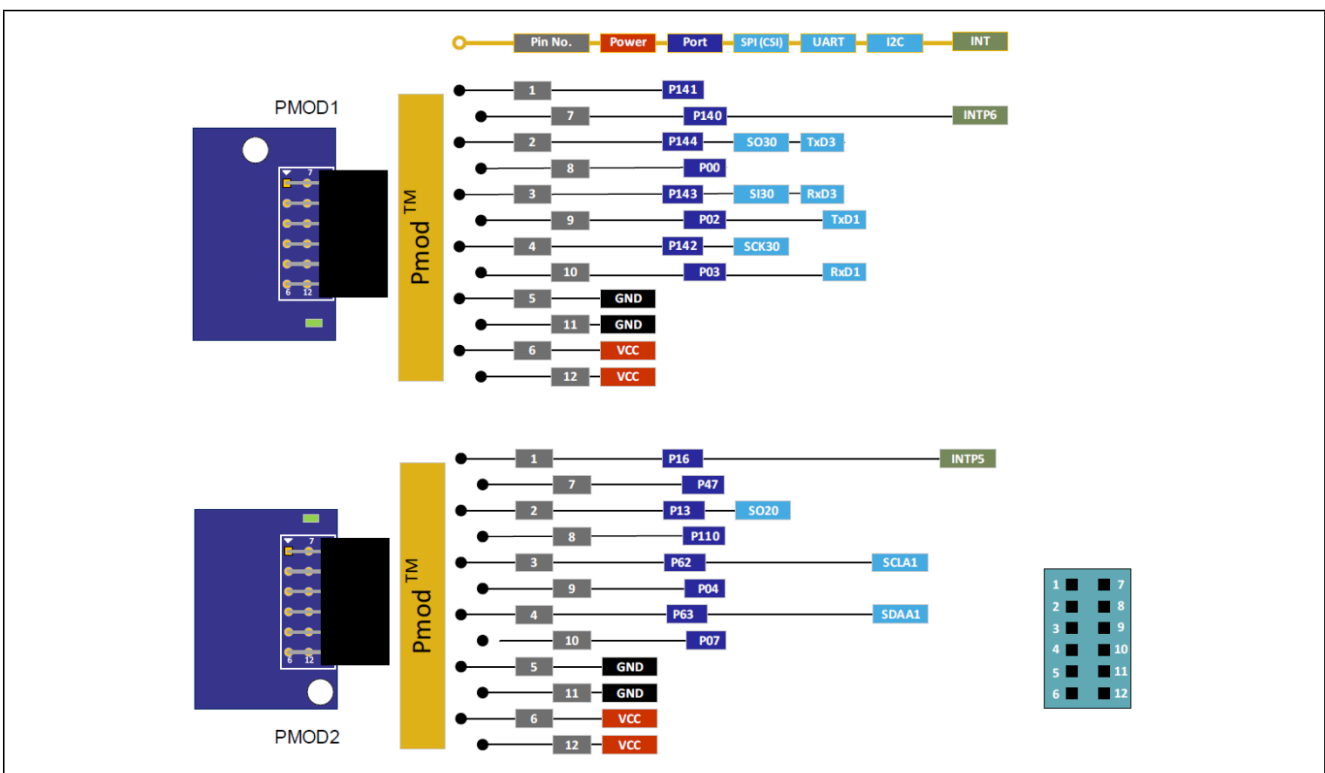

Figure 3.2 RL78/G23 FPB PMOD Interface

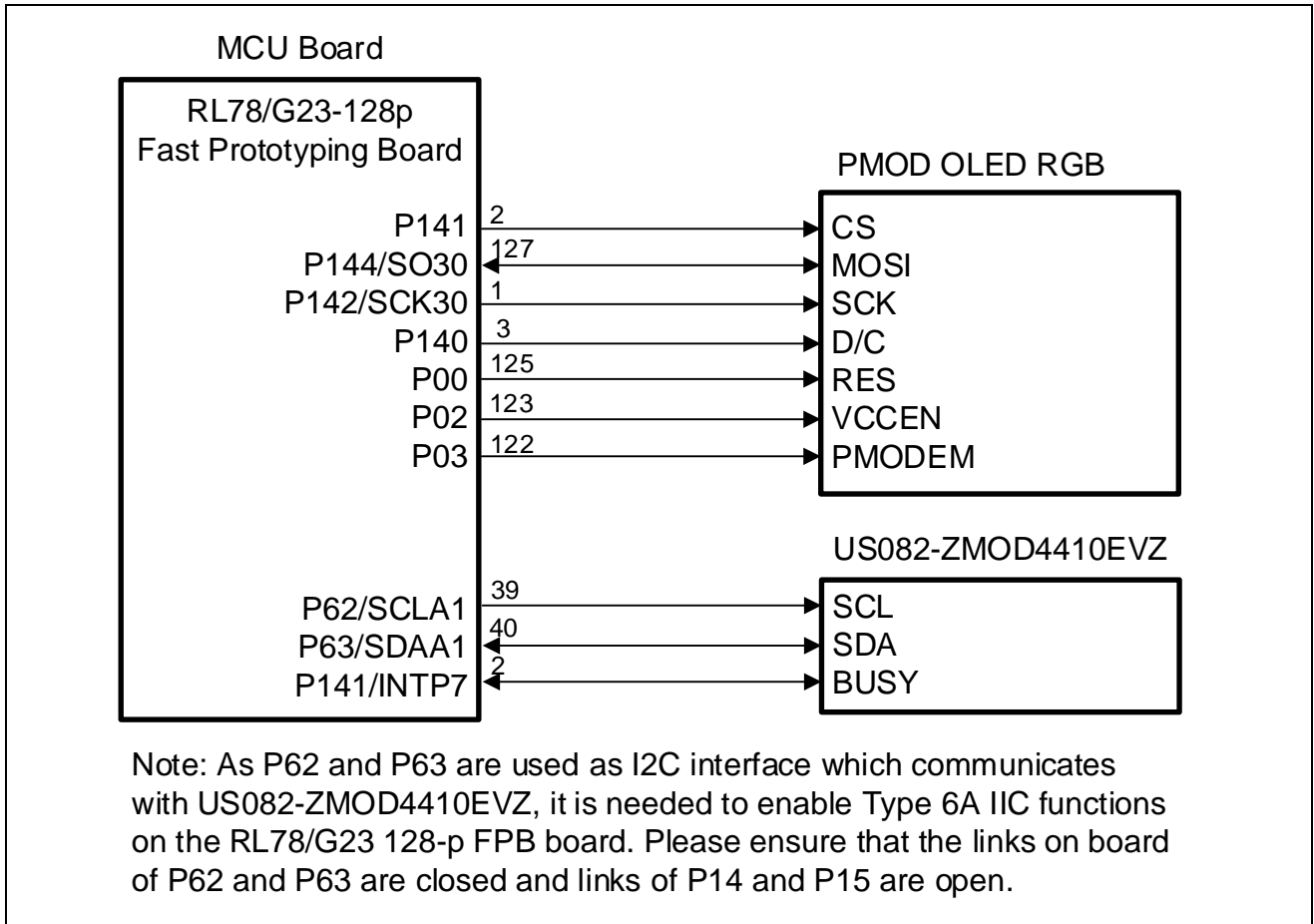

Figure 3.3 Connection of RL78/G23 FPB, PMOD OLED RGB and US082-ZMOD4410EVZ

3.2 Peripheral Functions to be Used

Table 3.1 lists the peripheral functions to be used and their usage.

Table 3.1 Peripheral Functions to be Used

Peripheral Function	Usage
3-wire Serial I/O (CSI30)	Control OLED to display IAQ, ECO2 and TVOC.
I2C (IICA1)	Get data (IAQ, ECO2 and TVOC) from the sensors.
Timer (TAU0_1)	Insert delay in the initialization, writing and reading operation of US082-ZMOD4410EVZ.

3.3 Pins to be Used

Table 3.2 lists the pins to be used and their function.

Table 3.2 Pins to be Used

Pin Name	Description
P141	Control CS (Chip Select) pin of PMOD OLED RGB
P144/SO30	Communicate with PMOD OLED RGB through TXD (Master-Out-Slave-In) pin
P142/SCK30	Communicate with PMOD OLED RGB through SCK (Serial Clock) pin
P140	Control D/C (Data/Command) pin of PMOD OLED RGB
P00	Control RES pin of PMOD OLED RGB
P02	Control VCCEN pin of PMOD OLED RGB
P03	Control PMODEN pin of PMOD OLED RGB
P62/SCLA1	Clock signal: Communicate with sensors (ZMOD4410) through IIC-bus
P63/SDAA1	Data signal: Communicate with sensors (ZMOD4410) through IIC-bus
P141/INTP7	Judge the status of ZMOD4410 through BUSY pin of ZMOD4410
VDD	Power supply voltage
GND	Ground

3.4 Operating Instructions

- (1) Once powered on, the system begins to initialize.
- (2) After the initialization, the MCU (RL78/G23) starts to get the sensor measurement result to visualize on the OLED.
- (3) After the visualization, the MCU (RL78/G23) will start the next measurement.

Display pattern: (12 char * 4 row)

Use different colors to display the sensor data

		R	E	N	E	S	A	S			
I	A	Q	:				x	x	.	x	x
E	C	O	2	:			x	x	x	x	.
T	V	O	C	:			x	.	x	x	x

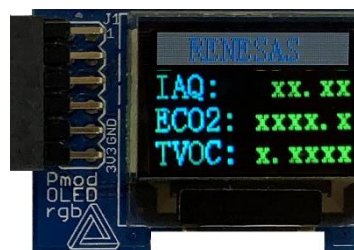

Table 3.3 OLED Display Color

Item	Range	OLED Display Color
IAQ ^{Note}	0.00 – 1.99	Green char
	2.00 – 2.99	Grass char
	3.00 – 3.99	Yellow char
	4.00 – 4.99	Orange char
	5.00 or more	Red char
ECO2	0.0 – 799.0	Green char
	800.0 – 999.0	Yellow char
	1000.0 – 4999.0	Orange char
	5000.0 or more	Red char
TVOC ^{Note}	0.0000 – 0.3000	Green char
	0.3000 – 1.0000	Grass char
	1.0000 – 3.0000	Yellow char
	3.0000 – 10.0000	Orange char
	10.0000 or more	Red char

Note: The US082-ZMOD4410EVZ Gas Sensor Module is designed for detecting total volatile organic compounds (TVOC) and monitoring indoor air quality (IAQ) in different use cases. IDT has adopted the definition of TVOCs and their impact on user health and comfort proposed by the UBA; see Table 3.4.

Table 3.4 Level of Air Quality Based on TVOC Levels Described by the UBA

IDT IAQ Rating	Reference Level	Air Information	TVOC (mg/m3)	Air Quality
≤ 1.99	Level 1	Clean Hygienic Air (target value)	< 0.3	Very Good
2.00 to 2.99	Level 2	Good Air Quality (if no threshold value is exceeded)	0.3 to 1.0	Good
3.00 to 3.99	Level 3	Noticeable Comfort Concerns (not recommended for exposure > 12 months)	1.0 to 3.0	Medium
4.00 to 4.99	Level 4	Significant Comfort Issues (not recommended for exposure > 1 month)	3.0 to 10.0	Poor
≥ 5.00	Level 5	Unacceptable Conditions (not recommended)	> 10.0	Bad

4. Hardware

This section describes how the RL78/G23-128p Fast Prototyping Board measures the indoor air quality via US082-ZMOD4410EVZ. And the sensing data (indoor air quality) are displayed on pmod OLED rgb.

About the details of RL78/G23-128p Fast Prototyping Board, pmod OLED rgb and US082-ZMOD4410EVZ, please refer to the following linkages.

[RTK7RLG230CSN000BJ - RL78/G23-128p Fast Prototyping Board | Renesas](https://reference.digilentinc.com/reference/pmod/pmodoledrgb/start)

<https://reference.digilentinc.com/reference/pmod/pmodoledrgb/start>

<https://www.renesas.com/jp/en/products/sensor-products/environmental-sensors/digital-gas-sensors/us082-zmod4410evz-tvoc-and-indoor-air-quality-sensor-pmod-board-renesas-quick-connect-iot>

Figure 4.1 shows the hardware composition. Figure 4.2 shows the RL78/G23128p-FPB Board Layout (Top Side).

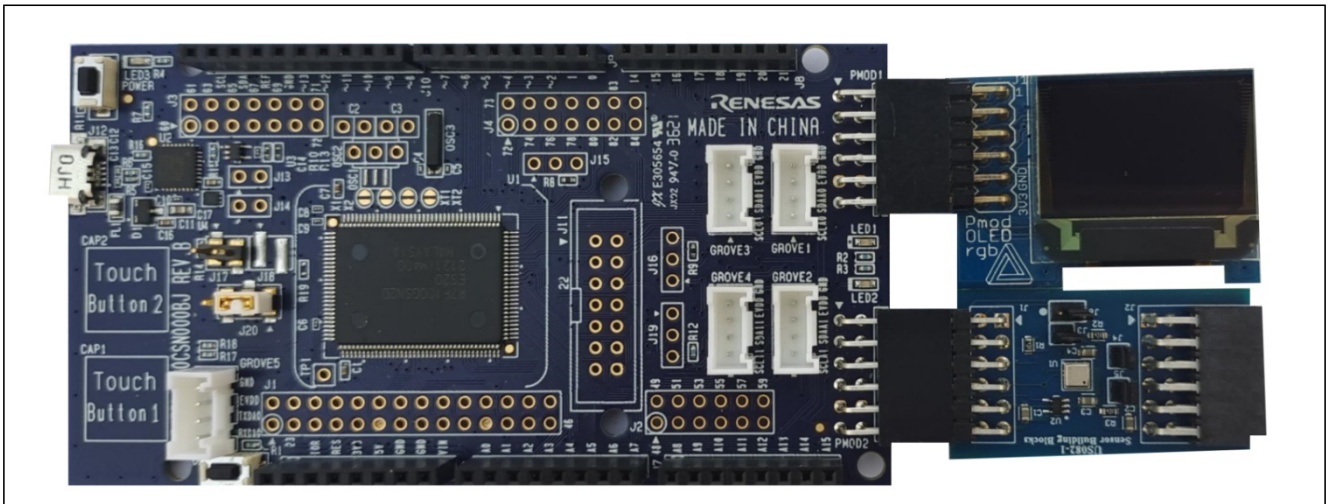

Figure 4.1 Hardware Composition

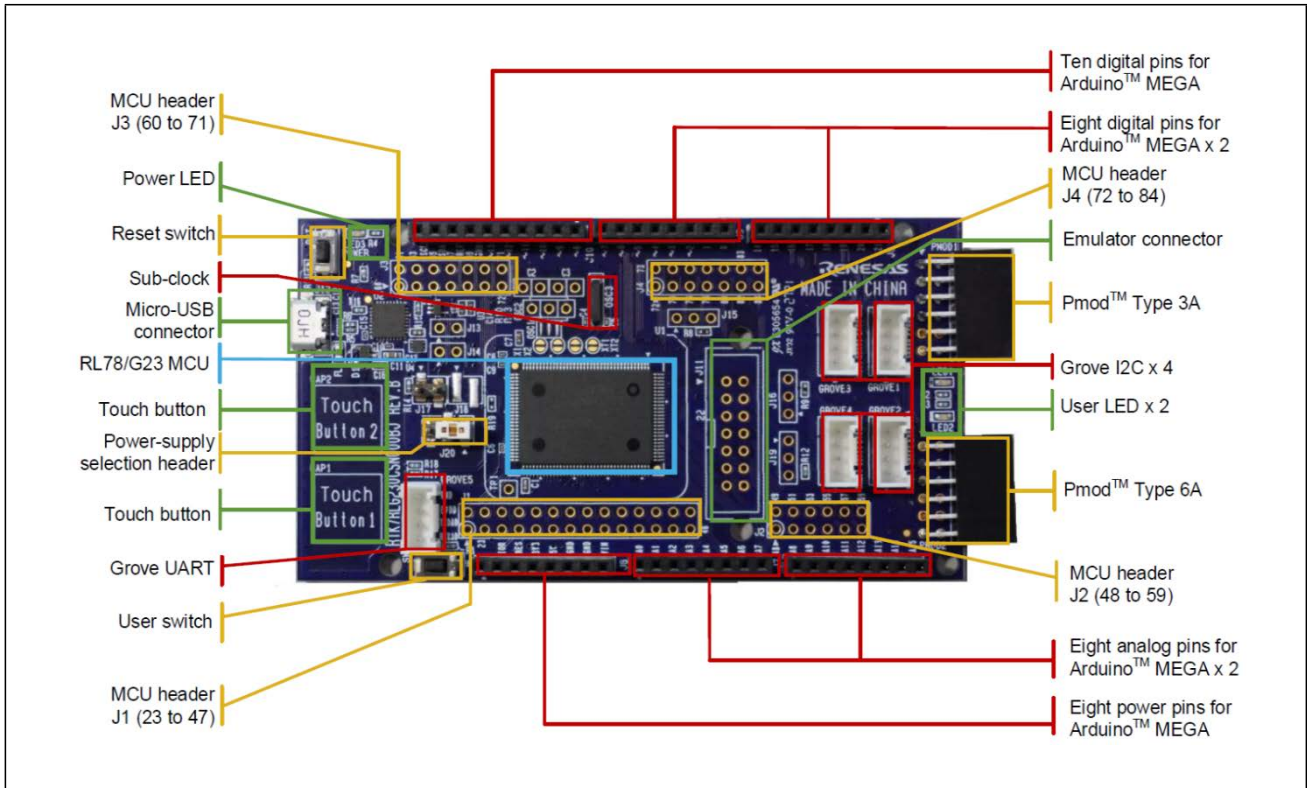

Figure 4.2 RL78/G23-128p-FPB Board Layout (Top Side)

4.1 Schematics

Figure 4.3 shows the schematic of US082-ZMOD4410EVZ via RL78/G23-128p-FPB Pmod2 connector.

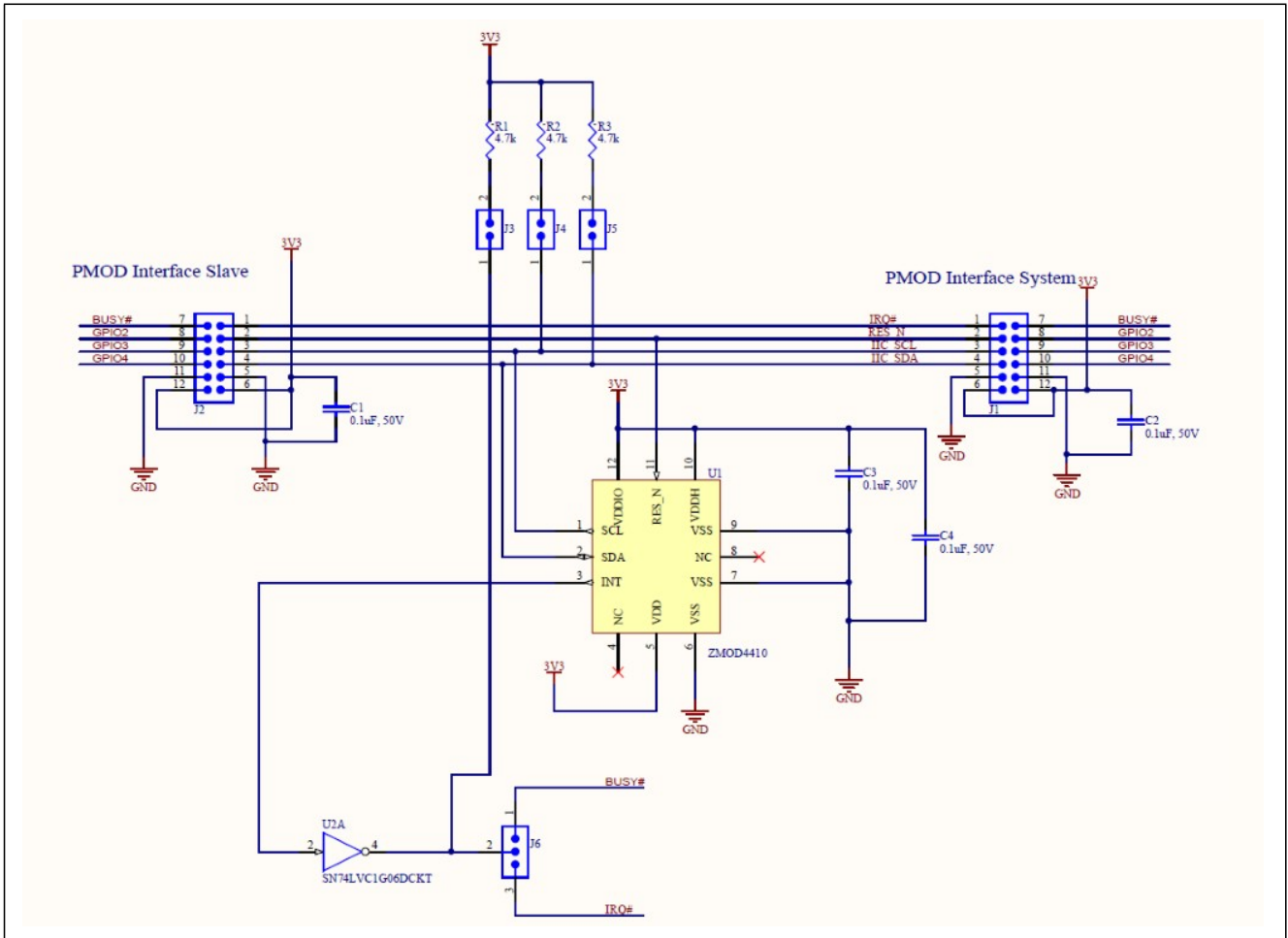

Figure 4.3 US082-ZMOD4410EVZ Circuit

5. Software

5.1 Integrated Development Environment

The sample code described in this chapter has been checked under the conditions listed in the table below.

Table 5.1 Operation Check Conditions

Item	Description
Board	RL78/G23-128p FPB
Device	RL78/G23 (R7F100GSN2DFB)
Operating frequency	High-speed on-chip oscillator (HOCO) clock: 32MHz CPU and each peripheral clock: 32MHz
Operating voltage	3.3 V (can run on a voltage range of 1.6 V to 5.5 V)
Integrated development environment (e ² studio)	e ² studio 2021-10
Compiler (Renesas CC-RL)	v1.10.00
Compiler (LLVM for RL78)	v10.0.0.202104
Board Support Packages (r_bsp)	v1.13
ZMOD4XXX Sensor Middleware (r_zmod4xxx)	v1.00
IIC Communication Driver Interface Middleware (r_comms_i2c)	v1.00
IIC Communication (Master mode)	v1.0.0
SPI (CSI) Communication	v1.0.0
Interval Timer	v1.0.0
Ports	v1.0.0

5.2 Operation Outline

The tasks of the entire system are listed as below: Reset/Initialization, Measurement and Display mode.

Figure 5.1 shows the block diagram for the tasks transition.

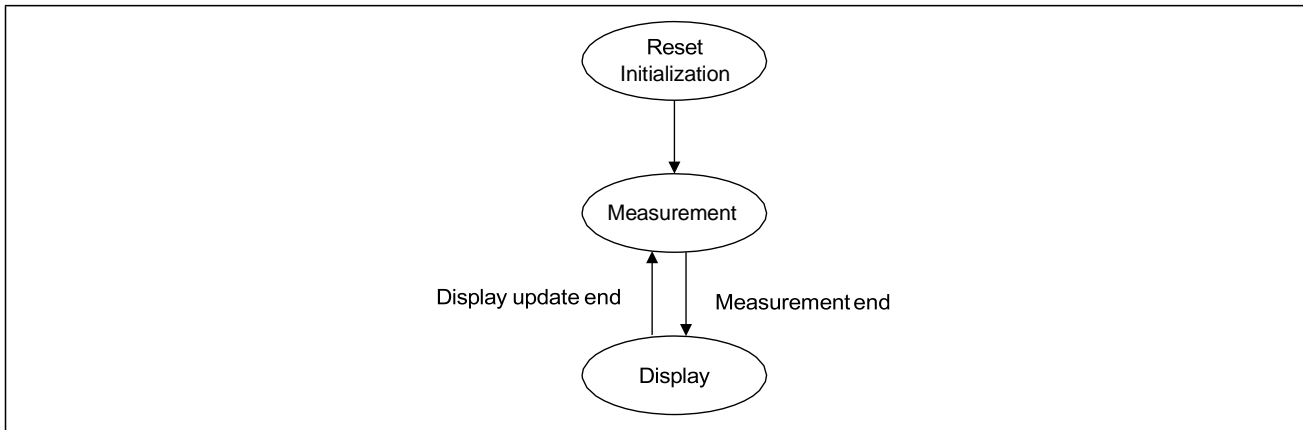

Figure 5.1 Tasks Transition Block Diagram

(1) Reset / Initialization

When the system is powered on, it will enter the initialization operation. The OLED is powered on and cleared. Then it displays Renesas logo and other default characters. ZMOD4410 is reset and initialized. IICA1, CSI30, TAU0_1 and I/O pins will be initialized.

(2) Measurement mode

After initialization, the MCU starts to get the sensor measurement results. Sensor ZMOD4410 needs to wait 1.99 seconds before starting the next measurement.

(3) Display mode

After measurement, the MCU sends the information to the OLED to display.

5.3 Flow Chart

5.3.1 Main Processing

Figure 5.2 shows the flowchart for main processing routine.

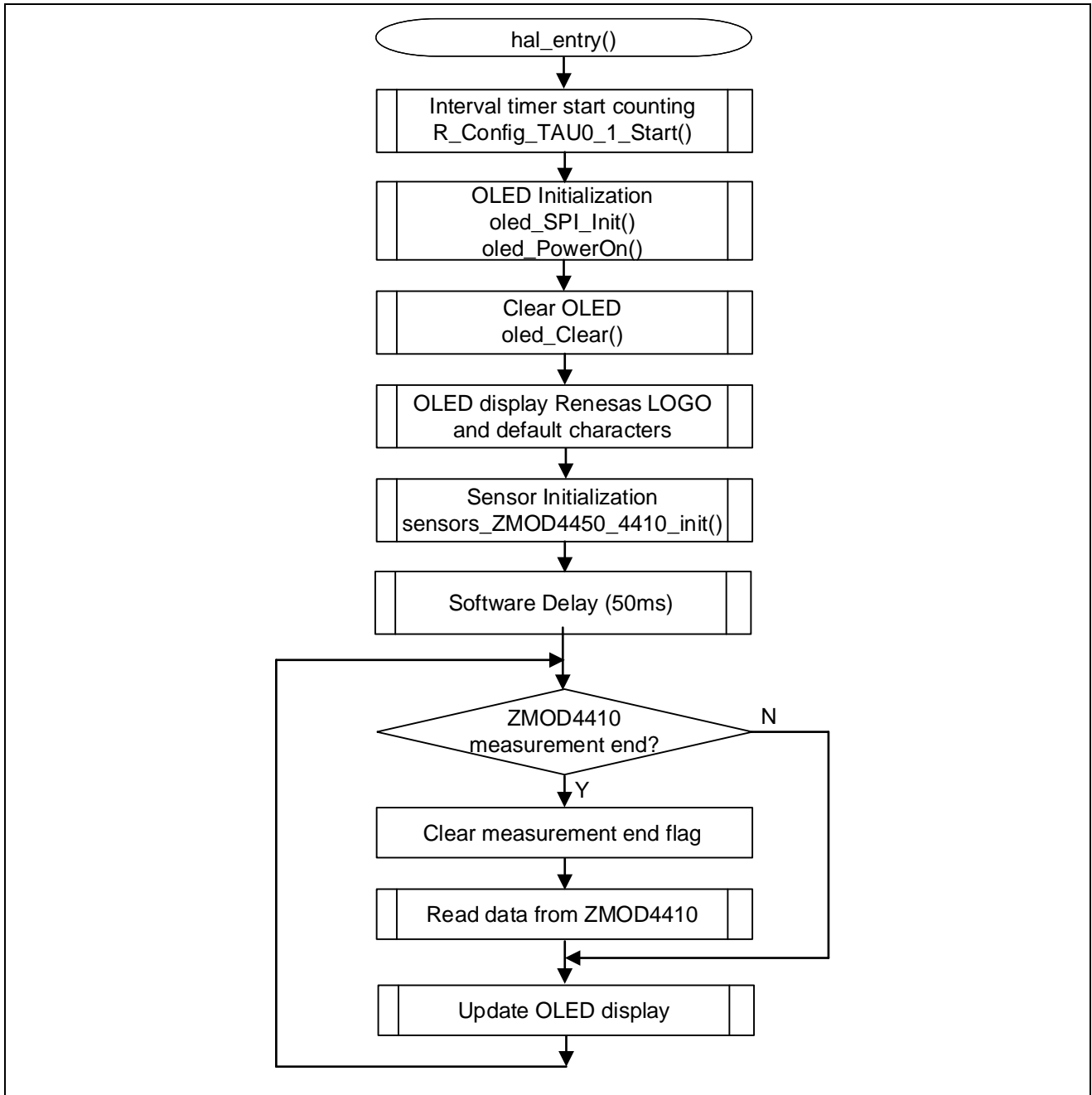
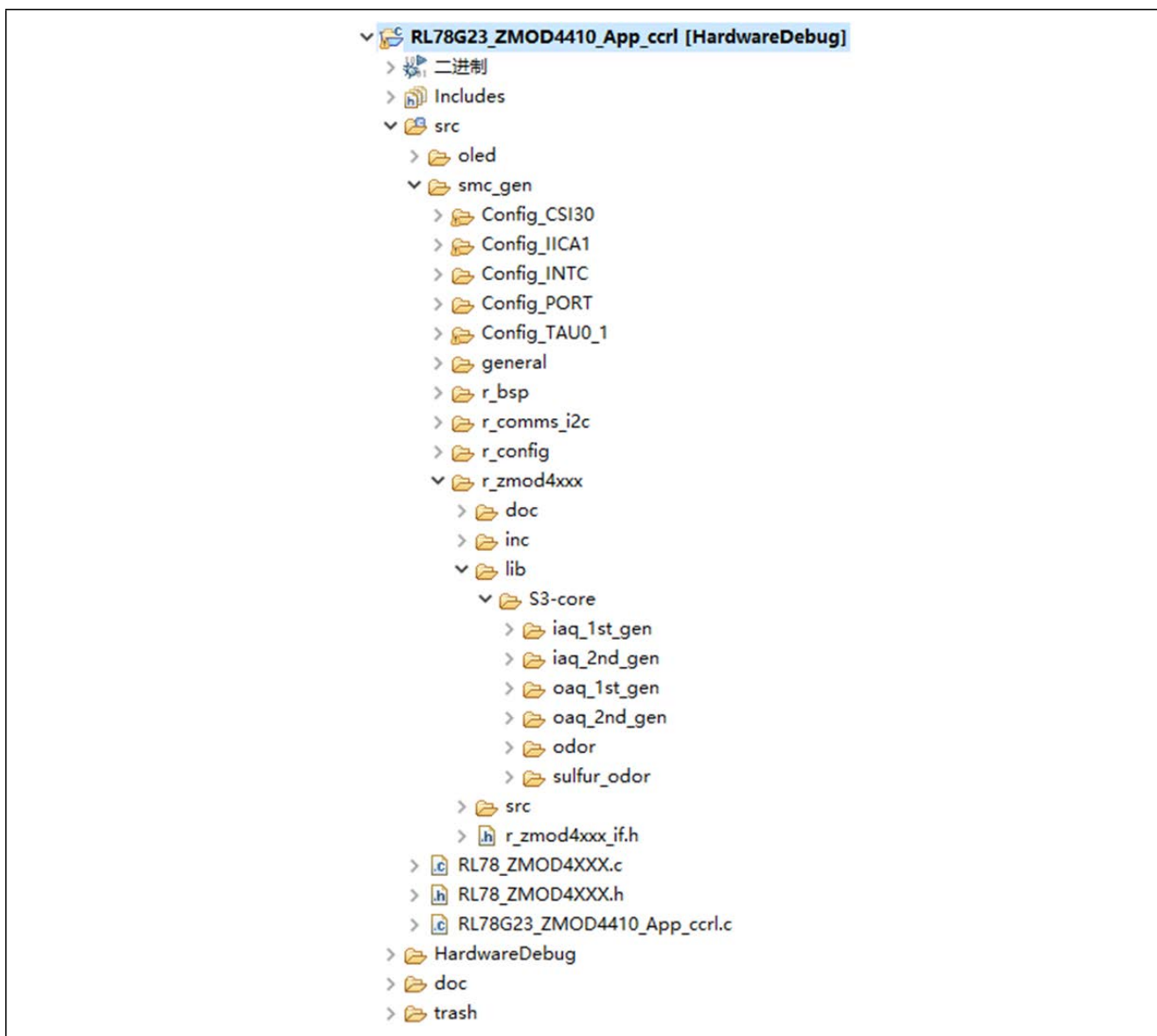

Figure 5.2 Main Processing

5.4 File Compositions

The file composition is shown below.



6. How to Add Sensor Middleware using Smart Configurator in e² studio

I. Launch e² studio.

II. Create a new project.

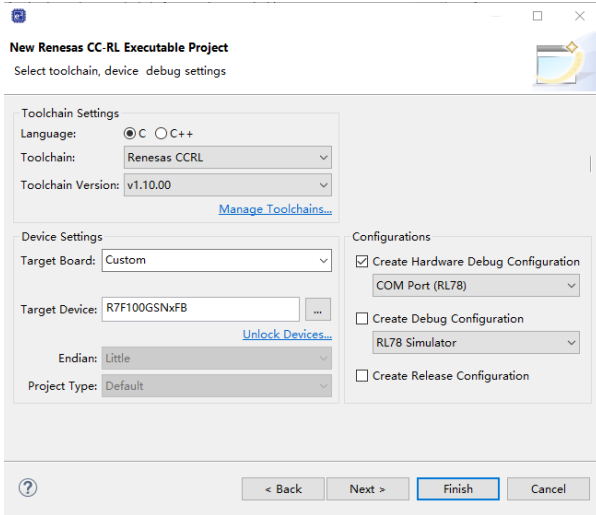

Renesas CC-RL C/C++ Executable Project

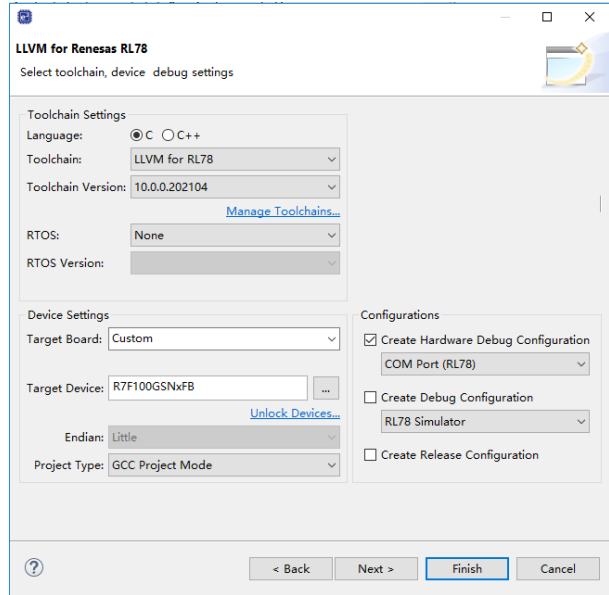

LLVM for Renesas RL78 C/C++ Executable Project

III. Add ZMOD4410 sensor middleware in the "Stacks" tabbed page.

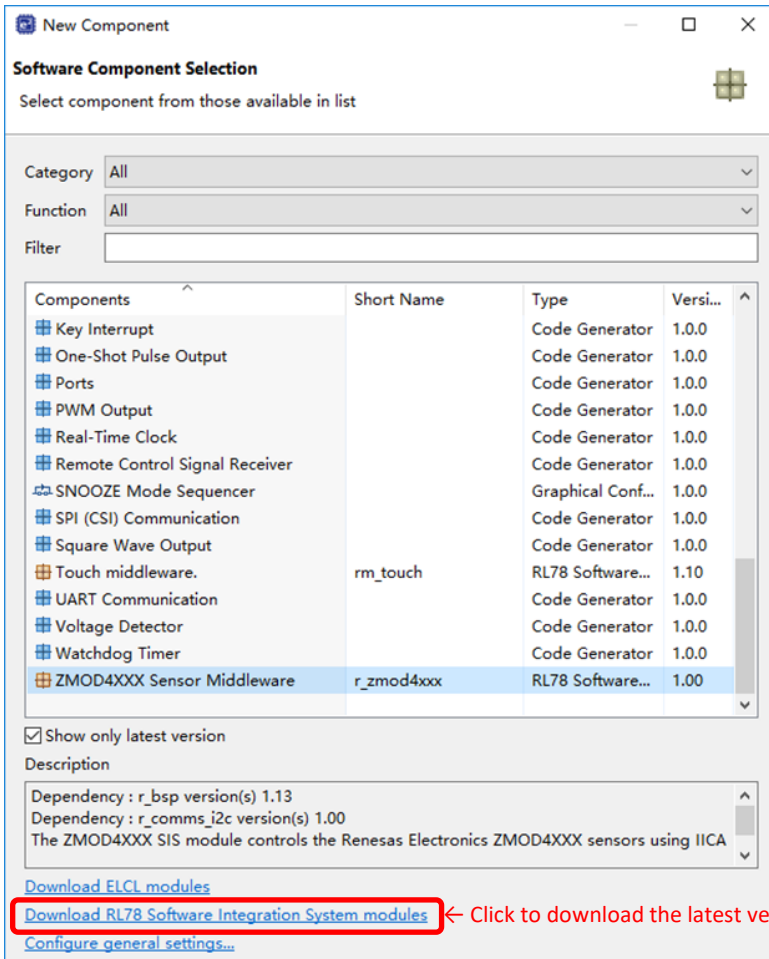

Configure	
Property	Value
Configurations	
# Parameter Checking	System Default
# Number of ZMOD4xxx Sensors	1
# Operation mode of ZMOD4XXX Sensors	IAQ 2nd Gen.
# I2C Communication device No. for ZMOD4XXX sensor device0	I2C Communication Device0
# I2C callback function for ZMOD4XXX sensor device0	zmod4xxx_comms_i2c_callback
# Enable IRQ from ZMOD4XXX sensor device0	Disabled
# IRQ Callback function for ZMOD4XXX sensor device0	zmod4xxx_user_irq_callback0
# IRQ number for ZMOD4XXX sensor device0	IRQ0
# IRQ trigger for ZMOD4XXX sensor device0	Rising
# IRQ interrupt priority for ZMOD4XXX sensor device0	Priority 10
# Operation mode of ZMOD4XXX Sensor1	IAQ 1st Gen. (Continuous)
# I2C Communication device No. for ZMOD4XXX sensor device1	I2C Communication Device1
# I2C callback function for ZMOD4XXX sensor device1	zmod4xxx_user_i2c_callback1
# Enable IRQ from ZMOD4XXX sensor device1	Disabled
# IRQ Callback function for ZMOD4XXX sensor device1	zmod4xxx_user_irq_callback1
# IRQ number for ZMOD4XXX sensor device1	IRQ0
# IRQ trigger for ZMOD4XXX sensor device1	Rising
# IRQ interrupt priority for ZMOD4XXX sensor device1	Priority 10

IV. Add IIC Communication Driver Interface Middleware in the "Components" tabbed page.

The screenshot shows a 'New Component' dialog box with the following details:

- Software Component Selection**: Select component from those available in list.
- Category**: All
- Function**: All
- Filter**: (Empty)
- Components List**:

Components	Short Name	Type	Versi...
ELCL Manchester Decoder Function		Graphical Conf...	1.0.0
ELCL Multiple Parameter Monitoring Function		Graphical Conf...	1.0.0
ELCL Slave Select Pin Function (4-wire SPI)		Graphical Conf...	1.0.0
External Event Counter		Code Generator	1.0.0
FS1015 Sensor Middleware	r_fs1015	RL78 Software...	0.60
FS2012 Sensor Middleware	r_fs2012	RL78 Software...	1.00
FS3000 Sensor Middleware	r_fs3000	RL78 Software...	0.60
HS300x Sensor Middleware	r_hs300x	RL78 Software...	1.00
IIC Communication (Master mode)		Code Generator	1.0.0
IIC Communication (Slave mode)		Code Generator	1.0.0
IIC Communication Driver Interface Middleware	r_comms_i2c	RL78 Software...	1.00
Input Pulse Interval Measurement		Code Generator	1.0.0
Input Signal High-/Low-Level Width Measurement		Code Generator	1.0.0
Interrupt Controller		Code Generator	1.0.0
Interval Timer		Code Generator	1.0.0
- Show only latest version
- Description**:

Dependency : r_bsp version(s) 1.13
 The Multi-device IIC communication driver interface middleware controls the Renesas Electronics Multi-device MCU (RA, RX, RI78).

[Download ELCL modules](#)
[Download RL78 Software Integration System modules](#)
[Configure general settings...](#)

Property	Value
▼ Configurations	
# Parameter Checking	System Default
# Number of communication lines	1
# IIC Driver Type for Communication bus0	IICA
# Component name for the communication bus0	Config_IICA1
# Slave address for Communication bus0	0x32
# IIC Driver Type for Communication bus0	7bit address mode
# Enable callback function for Communication bus0	Enabled
# Callback function for Communication bus0	rm_zmod4xxx_callback0
# IIC Driver Type for Communication bus1	Not selected
# Component name for the communication bus1	Config_IIC00
# Slave address for Communication bus1	0x00
# IIC Driver Type for Communication bus1	7bit address mode
# Enable callback function for Communication bus1	Disabled
# Callback function for Communication bus1	comms_i2c_user_callback1
# IIC Driver Type for Communication bus2	Not selected
# Component name for the communication bus2	Config_IIC00
# Slave address for Communication bus2	0x00
# IIC Driver Type for Communication bus2	7bit address mode

V. Add IIC Communication (Master mode) in the "Components" tabbed page.

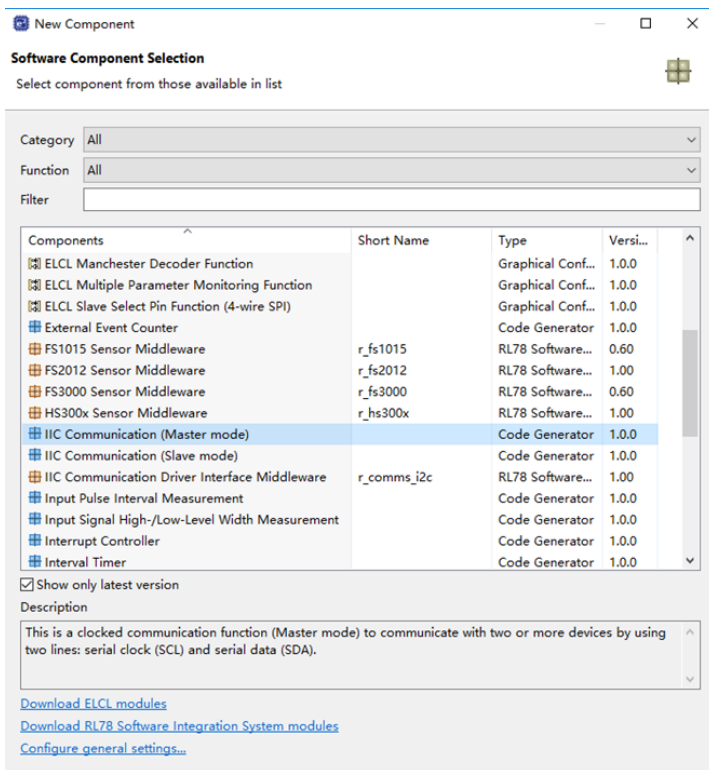

Configure

Clock mode setting
 Clock mode setting: fCLK/2 (Clock frequency: 16000 kHz)

Local address setting
 Address: 16

Operation mode setting
 Standard Fast mode Fast mode plus
 Digital filter on

Transfer clock (fSCL): 100000 (bps) (Actual value: 99378.882)

tR and tF setting
 Set tR and tF manually
 tR: 0 (μs)
 tF: 0 (μs)

Interrupt setting
 Communication end interrupt priority (INTIICA1): Level 3 (low)

Callback function setting
 Master transmission end Master reception end Master error

Callback function enhanced feature setting
 Generated stop condition in master transmission/reception end callback function

VI. Add requires ZMOD library. In this application, add "lib_iaq_2nd_gen.lib".

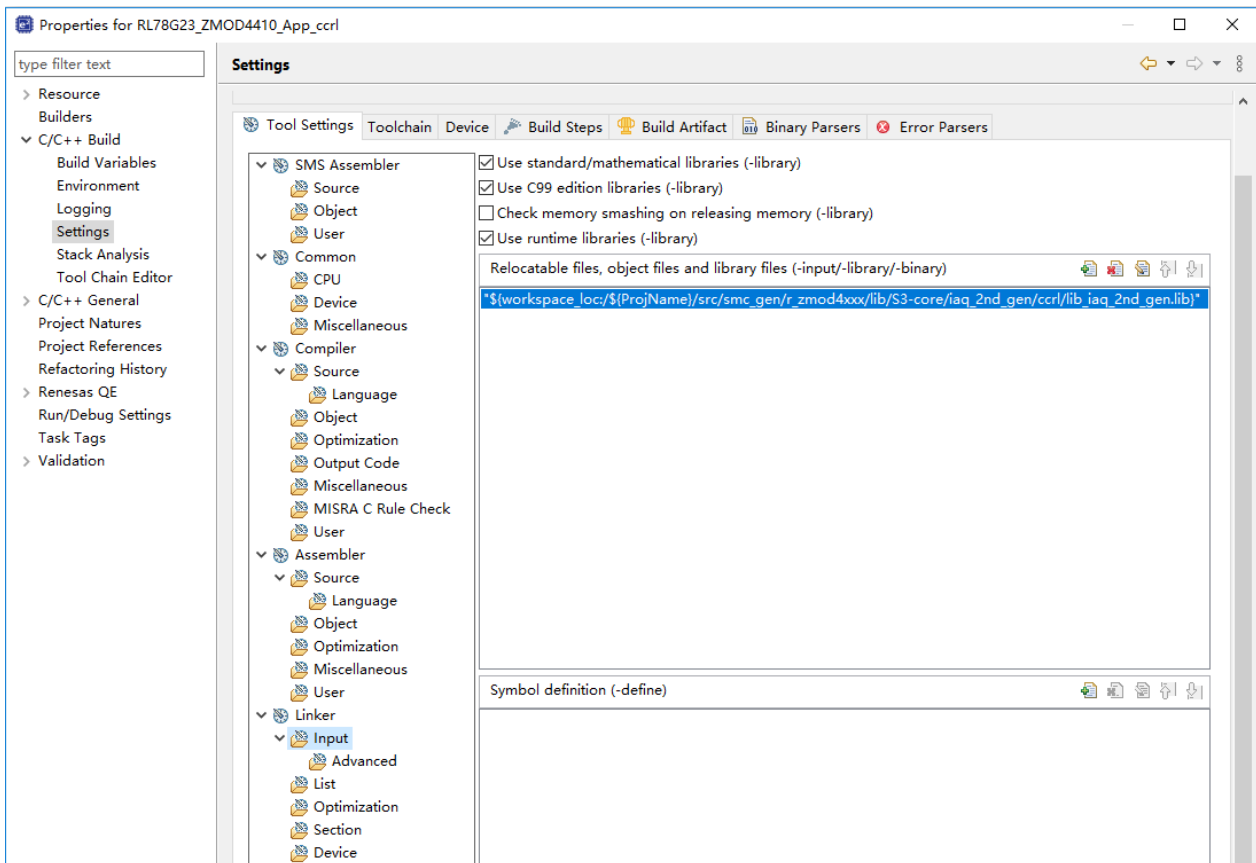

Renesas CC-RL C/C++ Executable Project

Note: If the error shown in the following figure occurs when build this project after added ZMOD library, please add the ZMOD library again according to the above figure.

```
E0562310:Undefined external symbol "_init_iaq_2nd_gen" referenced in ".\src\smc_gen\r_zmod4xxx\src\rm_zmod4xxx\iaq_2nd_gen\rm_zmod4410_iaq_2nd_gen.obj"
E0562310:Undefined external symbol "_calc_iaq_2nd_gen" referenced in ".\src\smc_gen\r_zmod4xxx\src\rm_zmod4xxx\iaq_2nd_gen\rm_zmod4410_iaq_2nd_gen.obj"
```

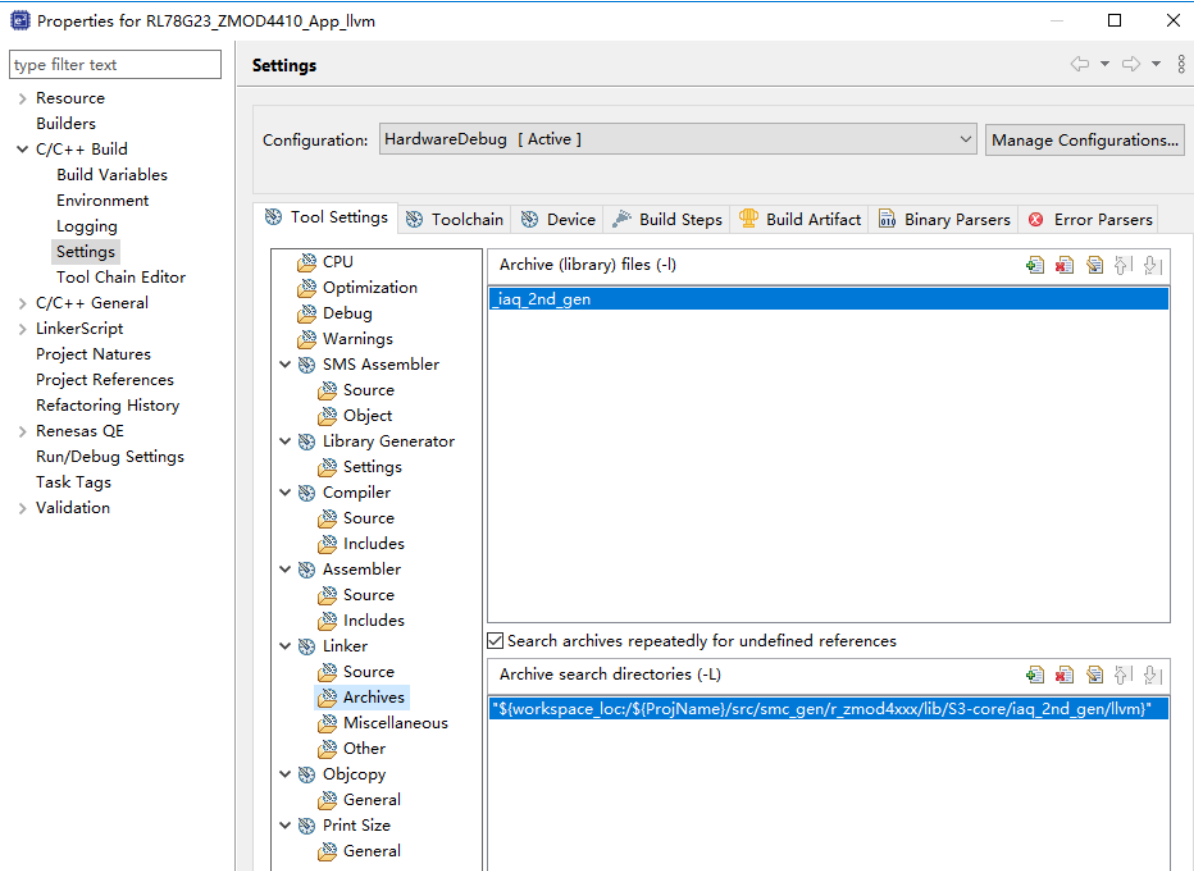

LLVM for Renesas RL78 C/C++ Executable Project

VII. Add SPI (CSI) Communication in the "Components" tabbed page.

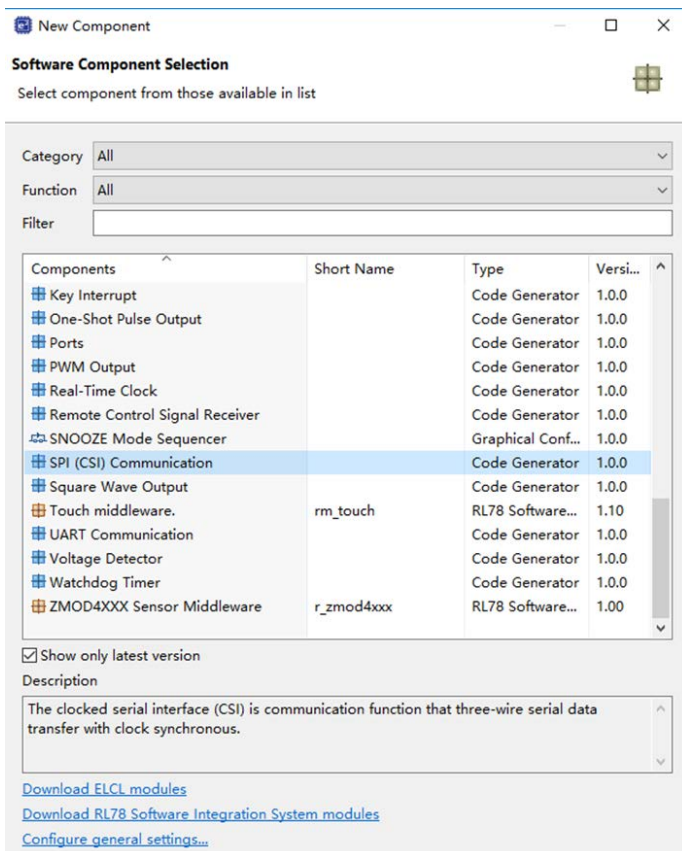

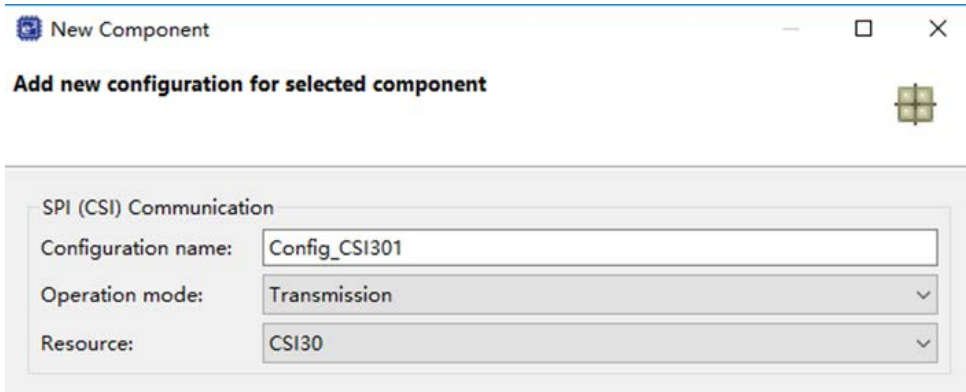

Configure

Transfer clock setting

Transfer clock mode: Internal clock (master) ▾

Operation clock: CK10 ▾

Clock source: fCLK ▾ (Clock frequency: 32000 kHz)

Transfer mode setting

Single transfer mode Continuous transfer mode

Data length setting

8 bits 7 bits

Transfer direction setting

LSB MSB

Specification of data timing
(The below figures are for MSB data transfer direction.)

Type 1 Type 2

Type 3 Type 4

Transfer rate setting

Baudrate: 8000000 ▾ (bps) (Actual value: 8000000)

Interrupt setting

Transfer interrupt priority (INTCSI30): Level 3 (low) ▾

Callback function setting

Transmission end Overrun error

VIII. Add Interval Timer Driver in the "Components" tabbed page.

New Component

Software Component Selection

Select component from those available in list

Category: All

Function: All

Filter:

Components	Short Name	Type	Versi...
FS3000 Sensor Middleware	r_fs3000	RL78 Software...	0.60
HS300x Sensor Middleware	r_hs300x	RL78 Software...	1.00
IIC Communication (Master mode)		Code Generator	1.0.0
IIC Communication (Slave mode)		Code Generator	1.0.0
IIC Communication Driver Interface ...	r_comms_i2c	RL78 Software...	1.00
Input Pulse Interval Measurement		Code Generator	1.0.0
Input Signal High-/Low-Level Width ...		Code Generator	1.0.0
Interrupt Controller		Code Generator	1.0.0
Interval Timer		Code Generator	1.0.0
Key Interrupt		Code Generator	1.0.0
One-Shot Pulse Output		Code Generator	1.0.0
Ports		Code Generator	1.0.0
PWM Output		Code Generator	1.0.0
Real-Time Clock		Code Generator	1.0.0
Remote Control Signal Receiver		Code Generator	1.0.0

Show only latest version

Description

The interval timer function is timer that generating timer interrupt at regular intervals. It also can measure the interval of the input signals.

[Download ELCL modules](#)

[Download RL78 Software Integration System modules](#)

[Configure general settings...](#)

Configure

Clock setting

Operation clock: CK00

Clock source: fCLK (Clock frequency: 32000 kHz)

Interval timer setting

Interval value (16 bits): 1 ms (Actual value: 1)

Generates INTTM01 when counting is started

Interrupt setting

End of timer channel 1 count, generate an interrupt (INTTM01)

Priority: Level 3 (low)

IX. Set the used pins of OLED.

New Component

Software Component Selection

Select component from those available in list

Category: All

Function: All

Filter:

Components	Short Name	Type	Versi...
Key Interrupt		Code Generator	1.0.0
One-Shot Pulse Output		Code Generator	1.0.0
Ports		Code Generator	1.0.0
PWM Output		Code Generator	1.0.0
Real-Time Clock		Code Generator	1.0.0
Remote Control Signal Receiver		Code Generator	1.0.0
SNOOZE Mode Sequencer		Graphical Conf...	1.0.0
SPI (CSI) Communication		Code Generator	1.0.0
Square Wave Output		Code Generator	1.0.0
Touch middleware.	rm_touch	RL78 Software...	1.1.0
UART Communication		Code Generator	1.0.0
Voltage Detector		Code Generator	1.0.0
Watchdog Timer		Code Generator	1.0.0
ZMOD4XXX Sensor Middleware	r_zmod4xxx	RL78 Software...	1.0.0

Show only latest version

Description

The ports is function that config each pin to be used as general input/output pin or input/output function of internal IP.

[Download ELCL modules](#)

[Download RL78 Software Integration System modules](#)

[Configure general settings...](#)

Configure

Port selection **PORT0** **PORT14**

PORT0 PORT1
 PORT2 PORT3
 PORT4 PORT5
 PORT6 PORT7
 PORT8 PORT9
 PORT10 PORT11
 PORT12 PORT13
 PORT14 PORT15

Port mode setting
 Read Pmn register values Read digital output level

Port selection **PORT0** **PORT14**

Apply to all
 Unused In Out Pull-up TTL buffer Input buffer N-ch Output 1

P00
 Unused In Out Pull-up Input buffer N-ch Output 1

P01
 Unused In Out Pull-up TTL buffer Output 1

P02
 Unused In Out Pull-up Input buffer N-ch Output 1

P03
 Unused In Out Pull-up TTL buffer Input buffer N-ch Output 1

P04
 Unused In Out Pull-up TTL buffer Input buffer N-ch Output 1

P05
 Unused In Out Pull-up Output 1

P06
 Unused In Out Pull-up Output 1

P07
 Unused In Out Pull-up Output 1

Port selection **PORT0** **PORT14**

Apply to all
 Unused In Out Pull-up TTL buffer Input buffer N-ch Output 1

P140
 Unused In Out Pull-up Output 1

P141
 Unused In Out Pull-up Output 1

P142
 Unused In Out Pull-up TTL buffer Input buffer N-ch Output 1

P143
 Unused In Out Pull-up TTL buffer Input buffer N-ch Output 1

P144
 Unused In Out Pull-up Input buffer N-ch Output 1

P145
 Unused In Out Pull-up Output 1

P146
 Unused In Out Pull-up Output 1

P147
 Unused In Out Pull-up Output 1

7. How to Build the Project and How to Program the Output File

7.1 Build in e² studio

I. Launch e² studio.

<https://www.renesas.com/jp/zh/software-tool/e-studio#download>

II. Right click on the "Project Explorer" and select "Import" from the displayed menu.

III. The "Import" window will be displayed. Select "Existing project to workspace" and click "Next".

IV. In the "Select root directory" form, select the project folder shown in the Project Folder "RL78G23_ZMOD4410_App_ccrl" or "RL78G23_ZMOD4410_App_llvm" of e² studio. After selection, confirm that the specified project is displayed in "Project" and click "Finish". Then the "Import" window is closed.

V. Right click on the project displayed on the "Project Explorer" and select "Build Project" to start building.

VI. A Motorola S-record file "RL78G23_ZMOD4410_App_ccrl.srec" or "RL78G23_ZMOD4410_App_llvm.srec" is generated in the path shown in the Hardware Debug folder of the sample project.

7.2 Programming srec file using Renesas Flash Programmer

This section describes how to write the pre-built mot file attached to this application note.

To write the pre-built mot file, it is necessary to mount a header component so that the Fast Prototyping Board can operate stand-alone. For details, refer to "5.14 USB-to-Serial Converter Reset Header" in "RL78/G23-128p Fast Prototyping Board User's Manual" (R20UT4870).

I. Launch Renesas Flash Programmer.

<https://www.renesas.com/jp/zh/software-tool/renesas-flash-programmer-programming-gui#download>

II. Select "File"-"New Project..." from the menu to create a new project of RL78/G23 using COM Port. About connection setting, "Interface" select "1 wire UART", "Power" select "3.3V".

III. Press the "Browse ..." button in "Program File" on the "Operation" tab to open the srec File "RL78G23_ZMOD4410_App_ccrl.srec" or "RL78G23_ZMOD4410_App_llvm.srec".

IV. Press the "Start" button to start programming.

Note: If you want to debug the sdample project using COM Port in e2studio, for "Debug Configurations", please refer to "7.1 Using the e2 studio" in "RL78/G23-128p Fast Prototyping Board User's Manual" (R20UT4870).

8. Sample Code

The sample code is available on the Renesas Electronics Website.

9. Reference Documents

RL78/G23-128p Fast Prototyping Board User's Manual (R20UT4870)

RL78/G23 User's Manual: Hardware (R01UH0896)

RA Family, RX Family, RL78 Family, RE01 256KB / 1500KB Group ZMOD4xxx Sample Software Manual (R01AN5899)

(The latest versions of the documents are available on the Renesas Electronics Website.)

Technical Updates/Technical News

(The latest information can be downloaded from the Renesas Electronics Website.)

Website and Support

Renesas Electronics Website

<http://www.renesas.com/>

Forum

<https://japan.renesasrulz.com/>

All trademarks and registered trademarks are the property of their respective owners.

Revision History

Rev.	Date	Description	
		Page	Summary
1.00	Dec.31, 21	-	First edition issued

General Precautions in the Handling of Microprocessing Unit and Microcontroller Unit Products

The following usage notes are applicable to all Microprocessing unit and Microcontroller unit products from Renesas. For detailed usage notes on the products covered by this document, refer to the relevant sections of the document as well as any technical updates that have been issued for the products.

1. Precaution against Electrostatic Discharge (ESD)

A strong electrical field, when exposed to a CMOS device, can cause destruction of the gate oxide and ultimately degrade the device operation. Steps must be taken to stop the generation of static electricity as much as possible, and quickly dissipate it when it occurs. Environmental control must be adequate. When it is dry, a humidifier should be used. This is recommended to avoid using insulators that can easily build up static electricity. Semiconductor devices must be stored and transported in an anti-static container, static shielding bag or conductive material. All test and measurement tools including work benches and floors must be grounded. The operator must also be grounded using a wrist strap. Semiconductor devices must not be touched with bare hands. Similar precautions must be taken for printed circuit boards with mounted semiconductor devices.

2. Processing at power-on

The state of the product is undefined at the time when power is supplied. The states of internal circuits in the LSI are indeterminate and the states of register settings and pins are undefined at the time when power is supplied. In a finished product where the reset signal is applied to the external reset pin, the states of pins are not guaranteed from the time when power is supplied until the reset process is completed. In a similar way, the states of pins in a product that is reset by an on-chip power-on reset function are not guaranteed from the time when power is supplied until the power reaches the level at which resetting is specified.

3. Input of signal during power-off state

Do not input signals or an I/O pull-up power supply while the device is powered off. The current injection that results from input of such a signal or I/O pull-up power supply may cause malfunction and the abnormal current that passes in the device at this time may cause degradation of internal elements. Follow the guideline for input signal during power-off state as described in your product documentation.

4. Handling of unused pins

Handle unused pins in accordance with the directions given under handling of unused pins in the manual. The input pins of CMOS products are generally in the high-impedance state. In operation with an unused pin in the open-circuit state, extra electromagnetic noise is induced in the vicinity of the LSI, an associated shoot-through current flows internally, and malfunctions occur due to the false recognition of the pin state as an input signal become possible.

5. Clock signals

After applying a reset, only release the reset line after the operating clock signal becomes stable. When switching the clock signal during program execution, wait until the target clock signal is stabilized. When the clock signal is generated with an external resonator or from an external oscillator during a reset, ensure that the reset line is only released after full stabilization of the clock signal. Additionally, when switching to a clock signal produced with an external resonator or by an external oscillator while program execution is in progress, wait until the target clock signal is stable.

6. Voltage application waveform at input pin

Waveform distortion due to input noise or a reflected wave may cause malfunction. If the input of the CMOS device stays in the area between V_{IL} (Max.) and V_{IH} (Min.) due to noise, for example, the device may malfunction. Take care to prevent chattering noise from entering the device when the input level is fixed, and also in the transition period when the input level passes through the area between V_{IL} (Max.) and V_{IH} (Min.).

7. Prohibition of access to reserved addresses

Access to reserved addresses is prohibited. The reserved addresses are provided for possible future expansion of functions. Do not access these addresses as the correct operation of the LSI is not guaranteed.

8. Differences between products

Before changing from one product to another, for example to a product with a different part number, confirm that the change will not lead to problems. The characteristics of a microprocessing unit or microcontroller unit products in the same group but having a different part number might differ in terms of internal memory capacity, layout pattern, and other factors, which can affect the ranges of electrical characteristics, such as characteristic values, operating margins, immunity to noise, and amount of radiated noise. When changing to a product with a different part number, implement a system-evaluation test for the given product.

Notice

1. Descriptions of circuits, software and other related information in this document are provided only to illustrate the operation of semiconductor products and application examples. You are fully responsible for the incorporation or any other use of the circuits, software, and information in the design of your product or system. Renesas Electronics disclaims any and all liability for any losses and damages incurred by you or third parties arising from the use of these circuits, software, or information.
2. Renesas Electronics hereby expressly disclaims any warranties against and liability for infringement or any other claims involving patents, copyrights, or other intellectual property rights of third parties, by or arising from the use of Renesas Electronics products or technical information described in this document, including but not limited to, the product data, drawings, charts, programs, algorithms, and application examples.
3. No license, express, implied or otherwise, is granted hereby under any patents, copyrights or other intellectual property rights of Renesas Electronics or others.
4. You shall be responsible for determining what licenses are required from any third parties, and obtaining such licenses for the lawful import, export, manufacture, sales, utilization, distribution or other disposal of any products incorporating Renesas Electronics products, if required.
5. You shall not alter, modify, copy, or reverse engineer any Renesas Electronics product, whether in whole or in part. Renesas Electronics disclaims any and all liability for any losses or damages incurred by you or third parties arising from such alteration, modification, copying or reverse engineering.
6. Renesas Electronics products are classified according to the following two quality grades: "Standard" and "High Quality". The intended applications for each Renesas Electronics product depends on the product's quality grade, as indicated below.

"Standard": Computers; office equipment; communications equipment; test and measurement equipment; audio and visual equipment; home electronic appliances; machine tools; personal electronic equipment; industrial robots; etc.

"High Quality": Transportation equipment (automobiles, trains, ships, etc.); traffic control (traffic lights); large-scale communication equipment; key financial terminal systems; safety control equipment; etc.

Unless expressly designated as a high reliability product or a product for harsh environments in a Renesas Electronics data sheet or other Renesas Electronics document, Renesas Electronics products are not intended or authorized for use in products or systems that may pose a direct threat to human life or bodily injury (artificial life support devices or systems; surgical implantations; etc.), or may cause serious property damage (space system; undersea repeaters; nuclear power control systems; aircraft control systems; key plant systems; military equipment; etc.). Renesas Electronics disclaims any and all liability for any damages or losses incurred by you or any third parties arising from the use of any Renesas Electronics product that is inconsistent with any Renesas Electronics data sheet, user's manual or other Renesas Electronics document.

7. No semiconductor product is absolutely secure. Notwithstanding any security measures or features that may be implemented in Renesas Electronics hardware or software products, Renesas Electronics shall have absolutely no liability arising out of any vulnerability or security breach, including but not limited to any unauthorized access to or use of a Renesas Electronics product or a system that uses a Renesas Electronics product. RENESAS ELECTRONICS DOES NOT WARRANT OR GUARANTEE THAT RENESAS ELECTRONICS PRODUCTS, OR ANY SYSTEMS CREATED USING RENESAS ELECTRONICS PRODUCTS WILL BE INVULNERABLE OR FREE FROM CORRUPTION, ATTACK, VIRUSES, INTERFERENCE, HACKING, DATA LOSS OR THEFT, OR OTHER SECURITY INTRUSION ("Vulnerability Issues"). RENESAS ELECTRONICS DISCLAIMS ANY AND ALL RESPONSIBILITY OR LIABILITY ARISING FROM OR RELATED TO ANY VULNERABILITY ISSUES. FURTHERMORE, TO THE EXTENT PERMITTED BY APPLICABLE LAW, RENESAS ELECTRONICS DISCLAIMS ANY AND ALL WARRANTIES, EXPRESS OR IMPLIED, WITH RESPECT TO THIS DOCUMENT AND ANY RELATED OR ACCOMPANYING SOFTWARE OR HARDWARE, INCLUDING BUT NOT LIMITED TO THE IMPLIED WARRANTIES OF MERCHANTABILITY, OR FITNESS FOR A PARTICULAR PURPOSE.
8. When using Renesas Electronics products, refer to the latest product information (data sheets, user's manuals, application notes, "General Notes for Handling and Using Semiconductor Devices" in the reliability handbook, etc.), and ensure that usage conditions are within the ranges specified by Renesas Electronics with respect to maximum ratings, operating power supply voltage range, heat dissipation characteristics, installation, etc. Renesas Electronics disclaims any and all liability for any malfunctions, failure or accident arising out of the use of Renesas Electronics products outside of such specified ranges.
9. Although Renesas Electronics endeavors to improve the quality and reliability of Renesas Electronics products, semiconductor products have specific characteristics, such as the occurrence of failure at a certain rate and malfunctions under certain use conditions. Unless designated as a high reliability product or a product for harsh environments in a Renesas Electronics data sheet or other Renesas Electronics document, Renesas Electronics products are not subject to radiation resistance design. You are responsible for implementing safety measures to guard against the possibility of bodily injury, injury or damage caused by fire, and/or danger to the public in the event of a failure or malfunction of Renesas Electronics products, such as safety design for hardware and software, including but not limited to redundancy, fire control and malfunction prevention, appropriate treatment for aging degradation or any other appropriate measures. Because the evaluation of microcomputer software alone is very difficult and impractical, you are responsible for evaluating the safety of the final products or systems manufactured by you.
10. Please contact a Renesas Electronics sales office for details as to environmental matters such as the environmental compatibility of each Renesas Electronics product. You are responsible for carefully and sufficiently investigating applicable laws and regulations that regulate the inclusion or use of controlled substances, including without limitation, the EU RoHS Directive, and using Renesas Electronics products in compliance with all these applicable laws and regulations. Renesas Electronics disclaims any and all liability for damages or losses occurring as a result of your noncompliance with applicable laws and regulations.
11. Renesas Electronics products and technologies shall not be used for or incorporated into any products or systems whose manufacture, use, or sale is prohibited under any applicable domestic or foreign laws or regulations. You shall comply with any applicable export control laws and regulations promulgated and administered by the governments of any countries asserting jurisdiction over the parties or transactions.
12. It is the responsibility of the buyer or distributor of Renesas Electronics products, or any other party who distributes, disposes of, or otherwise sells or transfers the product to a third party, to notify such third party in advance of the contents and conditions set forth in this document.
13. This document shall not be reprinted, reproduced or duplicated in any form, in whole or in part, without prior written consent of Renesas Electronics.
14. Please contact a Renesas Electronics sales office if you have any questions regarding the information contained in this document or Renesas Electronics products.

(Note1) "Renesas Electronics" as used in this document means Renesas Electronics Corporation and also includes its directly or indirectly controlled subsidiaries.

(Note2) "Renesas Electronics product(s)" means any product developed or manufactured by or for Renesas Electronics.

(Rev.5.0-1 October 2020)

Corporate Headquarters

TOYOSU FORESIA, 3-2-24 Toyosu,
Koto-ku, Tokyo 135-0061, Japan

www.renesas.com

Trademarks

Renesas and the Renesas logo are trademarks of Renesas Electronics Corporation. All trademarks and registered trademarks are the property of their respective owners.

Contact information

For further information on a product, technology, the most up-to-date version of a document, or your nearest sales office, please visit:

www.renesas.com/contact/.