R8C/M12A Group

A/D Converter in One-Shot Mode

R01AN0373EJ0100

Rev. 1.00

May 23, 2011

Abstract

This document describes the setting method to perform A/D conversion on analog voltage using the R8C/M12A Group A/D converter in one-shot mode.

Product

MCU: R8C/M12A Group

When using this application note with other Renesas MCUs, careful evaluation is recommended after making modifications to comply with the alternate MCU.

Contents

1.	Specifications	2
2.	Operation Confirmation Conditions	3
3.	Hardware	3
3.1	Pin Used	3
4.	Software	4
4.1	Operation Overview	4
4.2	Required Memory Size	5
4.3	Variables	5
4.4	Functions	5
4.5	Function Specifications	6
4.6	Flowcharts	7
4.6.1	Main Processing	7
4.6.2	System Clock Setting	8
4.6.3	Initial Setting of Timer RJ2	9
4.6.4	Initial Setting of A/D Converter	10
4.6.5	A/D Conversion and Determination	11
5.	Sample Code	12
6.	Reference Documents	12

1. Specifications

A/D conversion is performed on analog voltage input from an analog input pin every 5 ms using the A/D converter in one-shot mode. The highest and lowest values of the 10 conversion results are excluded, and the mean value of the remaining eight results is the final A/D converted value.

Table 1.1 lists the Peripheral Functions and Their Applications. Figure 1.1 shows a Block Diagram.

Table 1.1 Peripheral Functions and Their Applications

Peripheral Function	Application
Timer RJ2	Generate the measurement period.
A/D converter	Perform A/D conversion on analog input voltage.

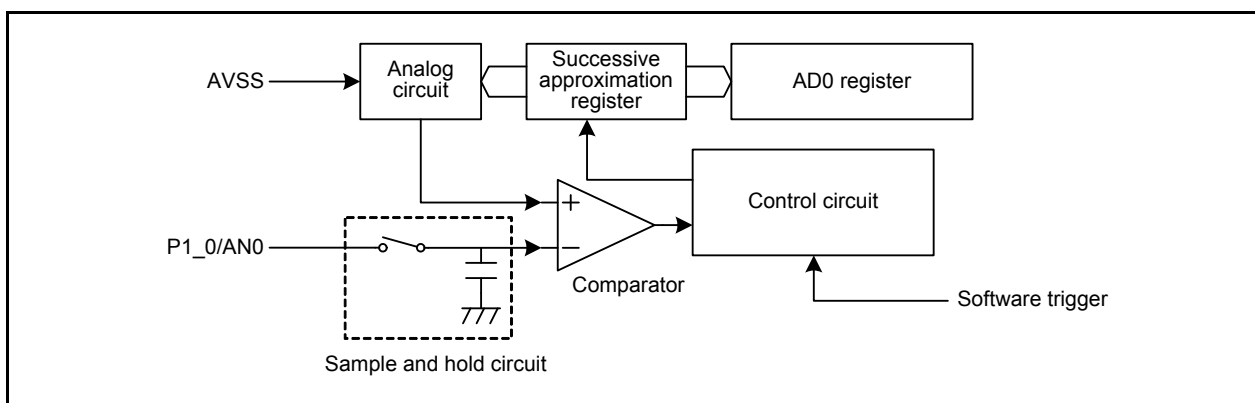

Figure 1.1 Block Diagram

2. Operation Confirmation Conditions

The sample code accompanying this application note has been run and confirmed under the conditions below.

Table 2.1 Operation Confirmation Conditions

Item	Contents
MCU used	R8C/M12A Group
Operating frequencies	High-speed on-chip oscillator clock: 20 MHz (typical) CPU clock (fs): 20 MHz System clock (f): 20 MHz
Operating voltage	5.0 V (2.7 to 5.5 V)
Integrated development environment	Renesas Electronics Corporation High-performance Embedded Workshop Version 4.07
C compiler	Renesas Electronics Corporation M16C Series, R8C Family C Compiler V.5.45 Release 01 Compile options -D__UART0__ -c -finfo -dir "\$(CONFIGDIR)" -R8C (Default setting is used in the integrated development environment)

3. Hardware

3.1 Pin Used

Table 3.1 lists the Pin Used and Its Function.

Table 3.1 Pin Used and Its Function

Pin Name	I/O	Function
P1_0/AN0	Input	A/D converter input (AN0)

4. Software

4.1 Operation Overview

A/D conversion is performed on analog voltage input from AN0 every 5 ms using the A/D converter in one-shot mode. Timer RJ2 timer mode is used to generate a 5 ms period.

Measurement conditions

- Use the P1_0/AN0 pin for analog input.
- Use one-shot mode for the A/D operating mode.
- Use fAD for the A/D conversion clock.
- Use a software trigger for the A/D conversion start condition.
- Use timer RJ2 to generate the measurement period.

(1) Perform the initial setting of the A/D converter.

After the A/D conversion described in steps (2) to (4) is performed 10 times every 5 ms, calculate the final A/D conversion value in step (5).

- (2) Set the ADST bit in the ADCON0 register to 1 (A/D conversion started) to start A/D conversion.
- (3) When A/D conversion is completed, the ADST bit automatically becomes 0 (A/D conversion stopped) and the ADF bit in the ADICSR register becomes 1 (interrupt request). Then, the converted result is transferred to the AD0 register.
- (4) Set the ADF bit to 0 (no interrupt request) to add the A/D converted result to the variable of the sum of the A/D converted values. When the AD0 register value is greater than the highest value of the previous converted results, store the AD0 register value to the variable of the highest A/D converted value. Or when the AD0 register value is smaller than the lowest value, store the AD0 register value to the variable of the lowest A/D converted value.
- (5) The highest and lowest values of the 10 conversion results are excluded, and the mean value of the remaining eight results is the final A/D converted value.

Figure 4.1 shows the Timing Diagram in One-Shot Mode.

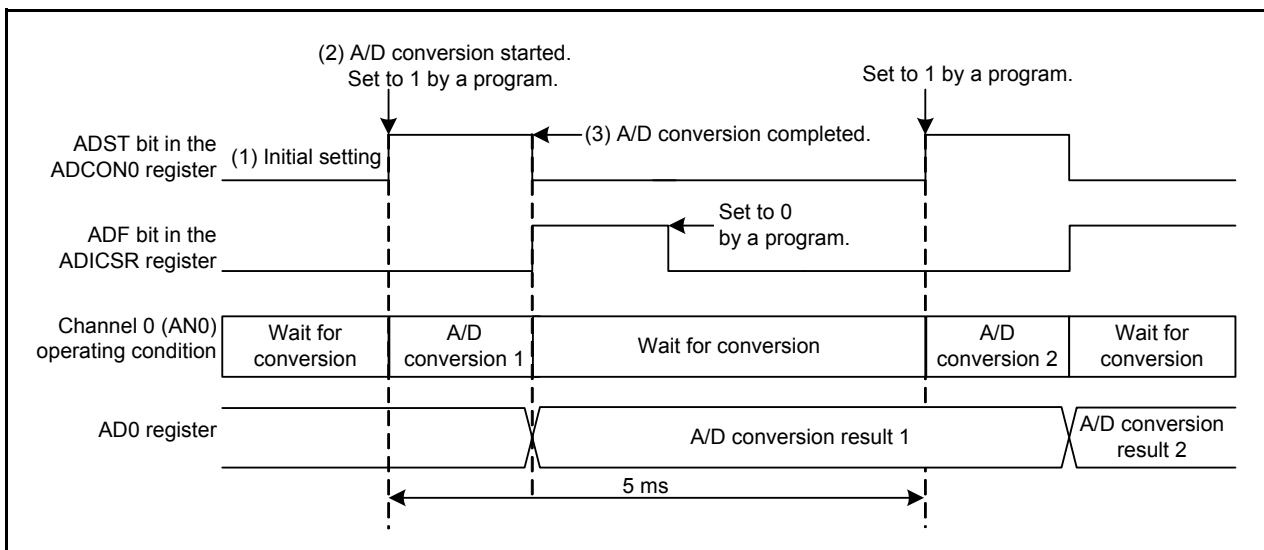

Figure 4.1 Timing Diagram in One-Shot Mode

4.2 Required Memory Size

Table 4.1 lists the Required Memory Size.

Table 4.1 Required Memory Size

Memory Used	Size	Remarks
ROM	335 bytes	In the r01an0373_src.c module
RAM	12 byte	In the r01an0373_src.c module
Maximum user stack usage	10 bytes	
Maximum interrupt stack usage	0 bytes	

The required memory size varies depending on the C compiler version and compile options.

4.3 Variables

Table 4.2 lists the Global Variables and Table 4.3 lists the static Variables.

Table 4.2 Global Variables

Type	Variable Name	Contents	Function Used
unsigned char	f_ad_fix	A/D converted value determination flag	ad_in
unsigned short	ad_fix	A/D converted final value	ad_in

Table 4.3 static Variables

Type	Variable Name	Contents	Function Used
unsigned short	ad_sum	Sum of A/D converted values	ad_in
unsigned char	ad_cnt	Number of A/D converted values	ad_in
unsigned short	ad_max	Highest A/D converted value	ad_in
unsigned short	ad_min	Lowest A/D converted value	ad_in
unsigned short	ad_buf	A/D converted value	ad_in

4.4 Functions

Table 4.4 lists the Functions.

Table 4.4 Functions

Function Name	Outline
mcu_init	System clock setting
timer_rj2_init	Initial setting of timer RJ2
ad_init	Initial setting of A/D converter
ad_in	A/D conversion and determination

4.5 Function Specifications

The following tables list the sample code function specifications.

mcu_init	
Outline	System clock setting
Header	None
Declaration	void mcu_init(void)
Explanation	Set the system clock.
Argument	None
Returned value	None
Remark	—

timer_rj2_init	
Outline	Initial setting of timer RJ2
Header	None
Declaration	void timer_rj2_init(void)
Explanation	Perform initial setting to use timer RJ2 in timer mode.
Argument	None
Returned value	None
Remark	—

ad_init	
Outline	Initial setting of A/D converter
Header	None
Declaration	void ad_init(void)
Explanation	Perform initial setting to use the A/D converter in one-shot mode.
Argument	None
Returned value	None
Remark	—

ad_in	
Outline	A/D conversion and determination
Header	None
Declaration	void ad_in(void)
Explanation	Perform A/D conversion and calculate the A/D conversion final value. The highest and lowest values of the 10 conversion results are excluded, and the mean value of the remaining eight results is the A/D conversion value.
Argument	None
Returned value	None
Remark	—

4.6 Flowcharts

4.6.1 Main Processing

Figure 4.2 shows the Main Processing.

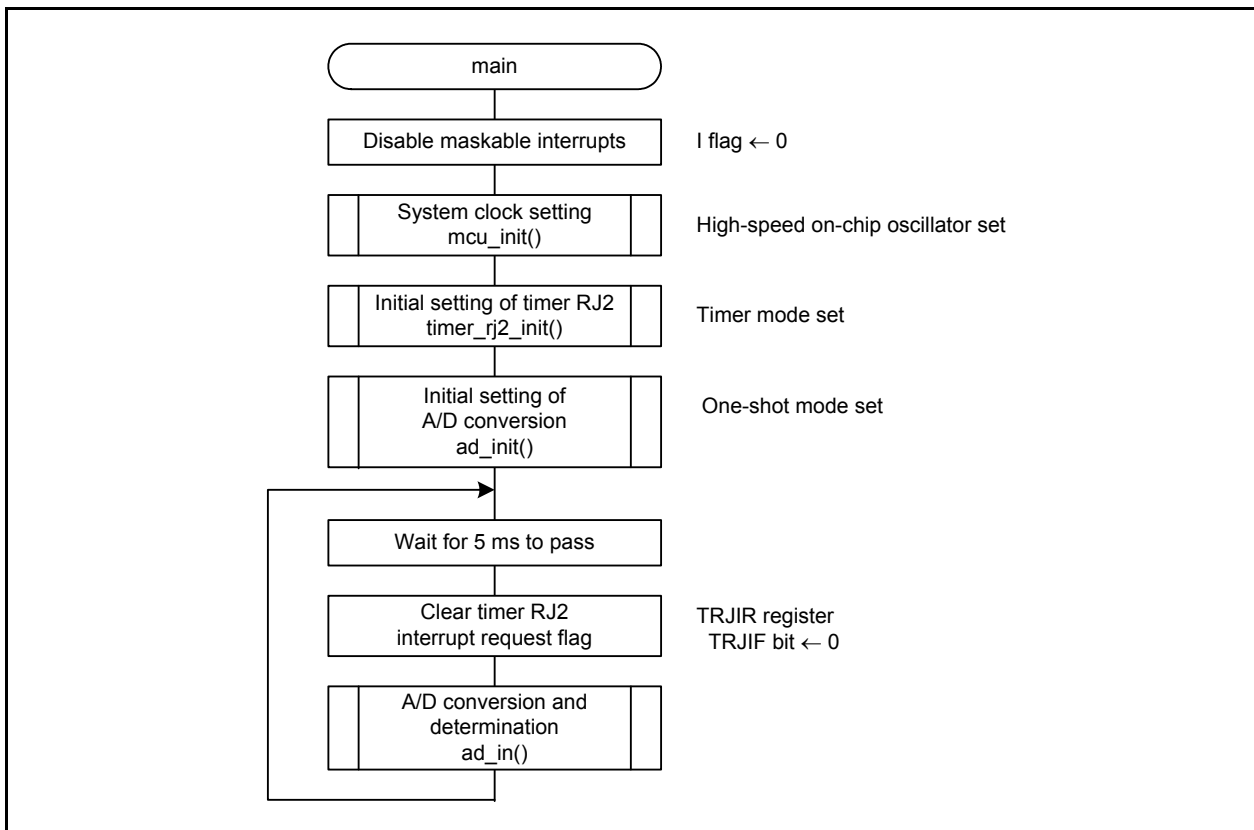

Figure 4.2 Main Processing

4.6.2 System Clock Setting

Figure 4.3 shows the System Clock Setting.

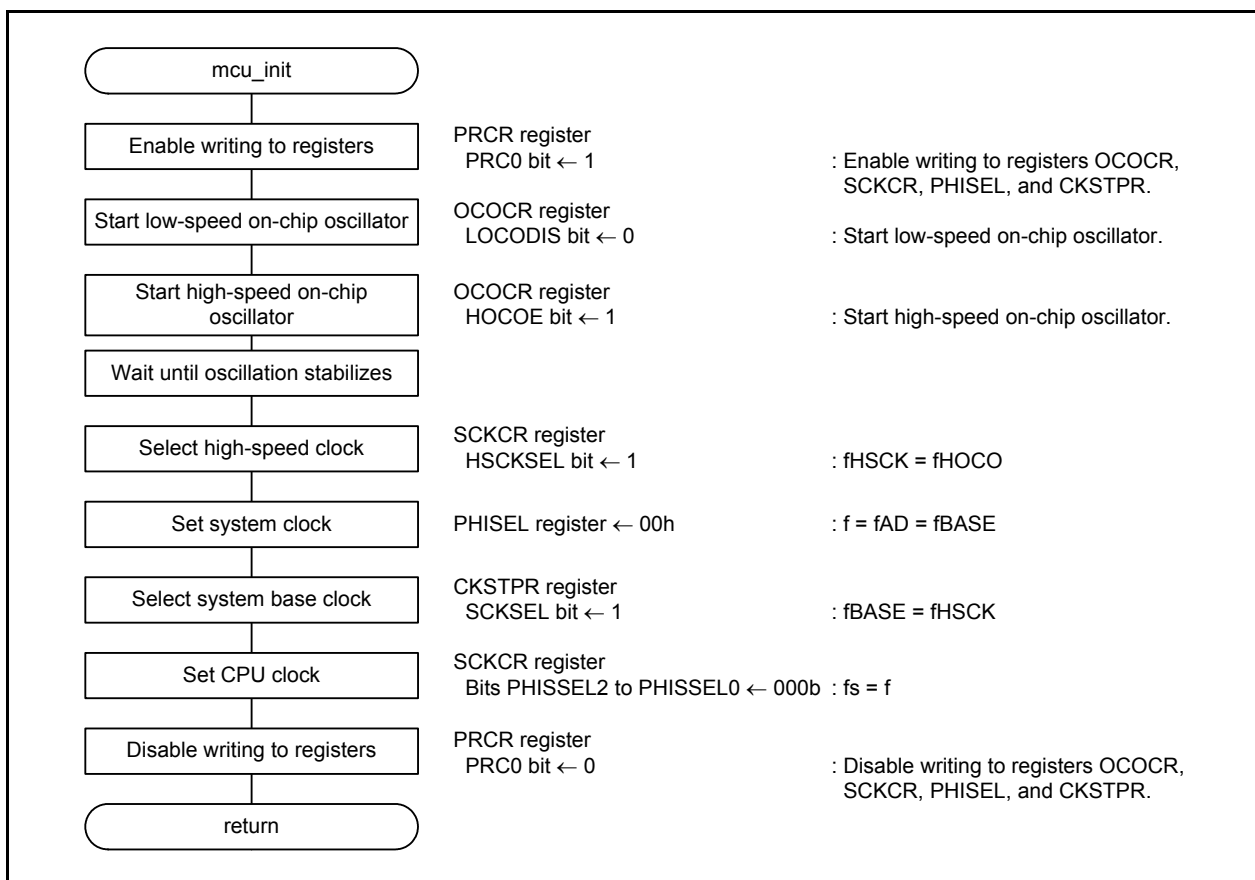

Figure 4.3 System Clock Setting

4.6.3 Initial Setting of Timer RJ2

Figure 4.4 shows the Initial Setting of Timer RJ2.

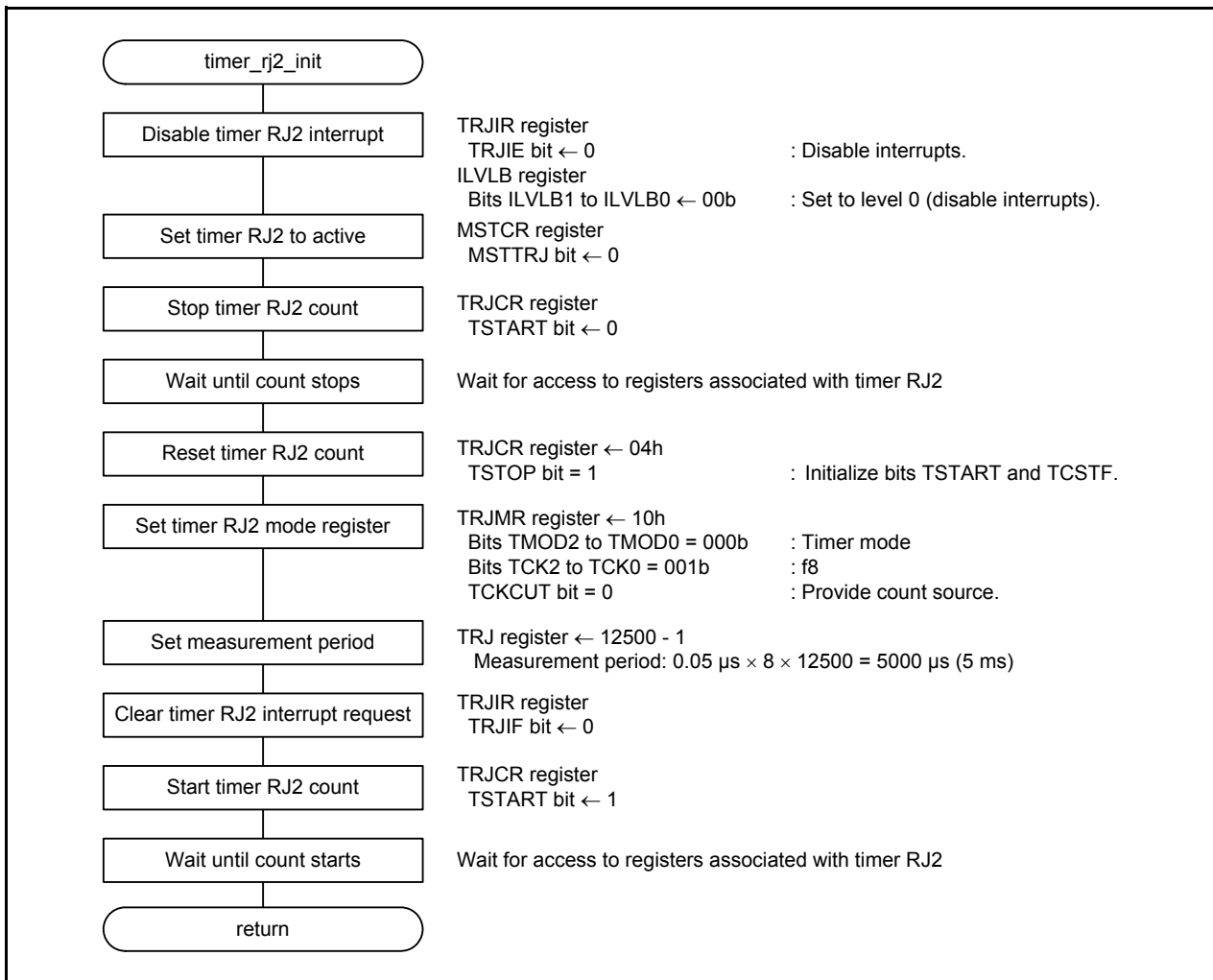

Figure 4.4 Initial Setting of Timer RJ2

4.6.4 Initial Setting of A/D Converter

Figure 4.5 shows the Initial Setting of A/D Converter.

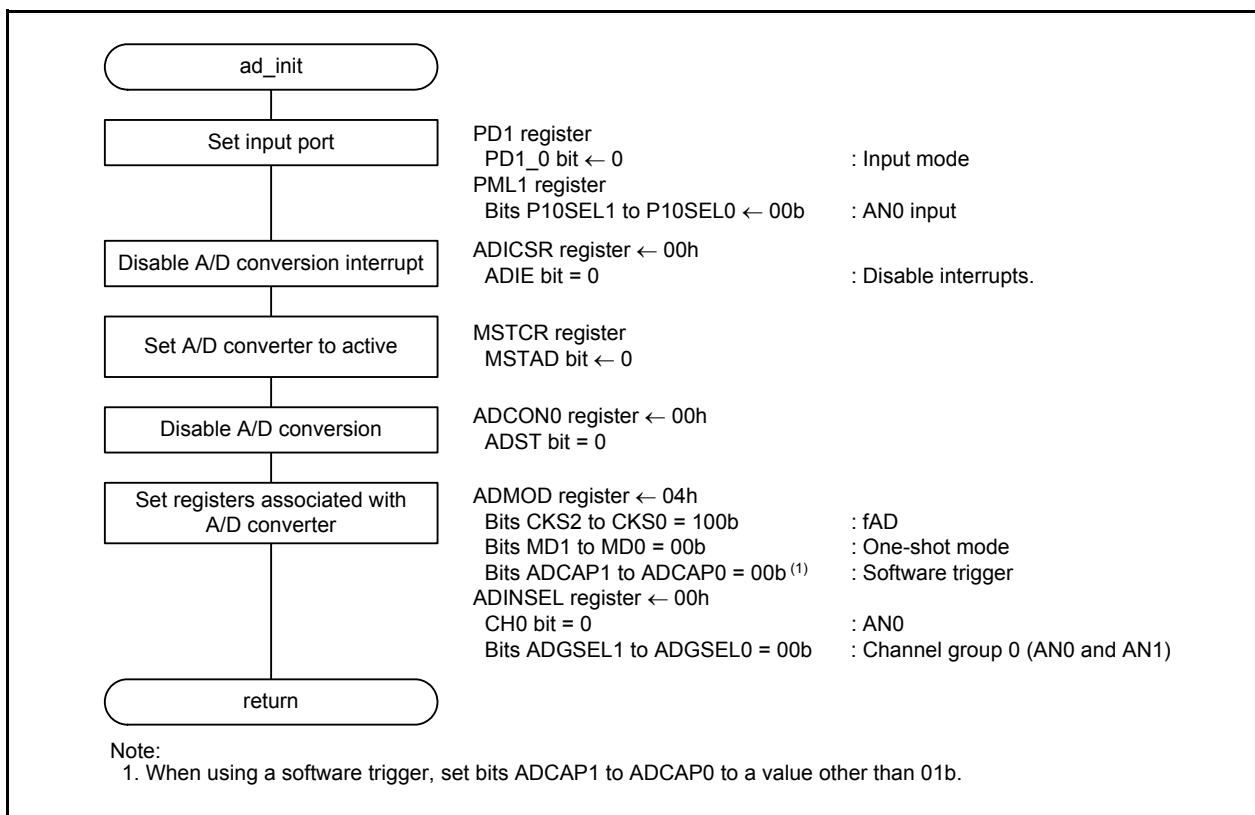

Figure 4.5 Initial Setting of A/D Converter

4.6.5 A/D Conversion and Determination

Figure 4.6 shows the A/D Conversion and Determination.

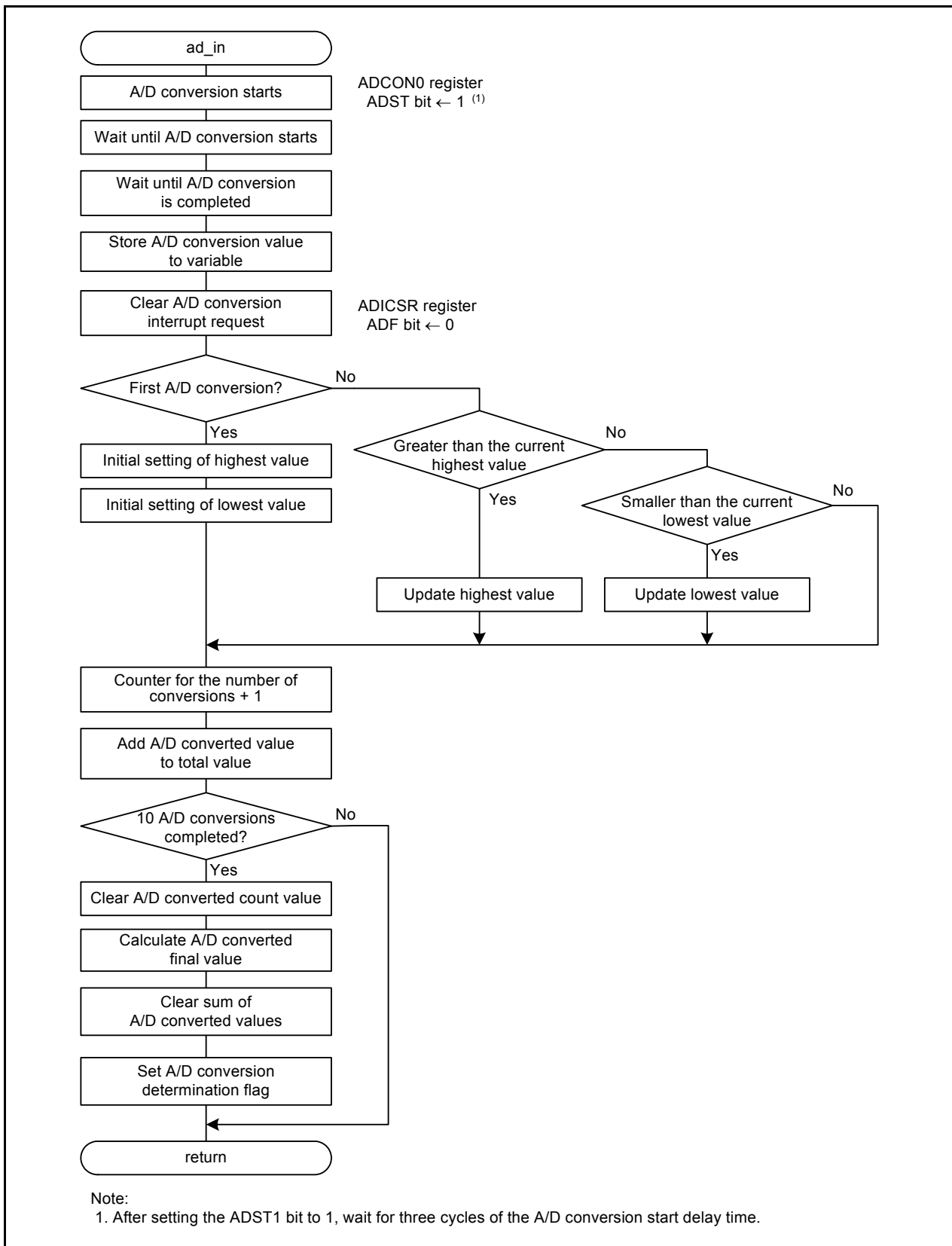

Figure 4.6 A/D Conversion and Determination

5. Sample Code

Sample code can be downloaded from the Renesas Electronics website.

6. Reference Documents

R8C/M12A Group User's Manual: Hardware Rev.1.00

The latest version can be downloaded from the Renesas Electronics website.

Technical Update/Technical News

The latest information can be downloaded from the Renesas Electronics website.

Website and Support

Renesas Electronics website

<http://www.renesas.com/>

Inquiries

<http://www.renesas.com/inquiry>

Revision History	R8C/M12A Group A/D Converter in One-Shot Mode
------------------	--

Rev.	Date	Description	
		Page	Summary
1.00	May 23, 2011	—	First edition issued

All trademarks and registered trademarks are the property of their respective owners.

General Precautions in the Handling of MPU/MCU Products

The following usage notes are applicable to all MPU/MCU products from Renesas. For detailed usage notes on the products covered by this manual, refer to the relevant sections of the manual. If the descriptions under General Precautions in the Handling of MPU/MCU Products and in the body of the manual differ from each other, the description in the body of the manual takes precedence.

1. Handling of Unused Pins

Handle unused pins in accord with the directions given under Handling of Unused Pins in the manual.

- The input pins of CMOS products are generally in the high-impedance state. In operation with an unused pin in the open-circuit state, extra electromagnetic noise is induced in the vicinity of LSI, an associated shoot-through current flows internally, and malfunctions occur due to the false recognition of the pin state as an input signal become possible. Unused pins should be handled as described under Handling of Unused Pins in the manual.

2. Processing at Power-on

The state of the product is undefined at the moment when power is supplied.

- The states of internal circuits in the LSI are indeterminate and the states of register settings and pins are undefined at the moment when power is supplied.

In a finished product where the reset signal is applied to the external reset pin, the states of pins are not guaranteed from the moment when power is supplied until the reset process is completed.

In a similar way, the states of pins in a product that is reset by an on-chip power-on reset function are not guaranteed from the moment when power is supplied until the power reaches the level at which resetting has been specified.

3. Prohibition of Access to Reserved Addresses

Access to reserved addresses is prohibited.

- The reserved addresses are provided for the possible future expansion of functions. Do not access these addresses; the correct operation of LSI is not guaranteed if they are accessed.

4. Clock Signals

After applying a reset, only release the reset line after the operating clock signal has become stable. When switching the clock signal during program execution, wait until the target clock signal has stabilized.

- When the clock signal is generated with an external resonator (or from an external oscillator) during a reset, ensure that the reset line is only released after full stabilization of the clock signal. Moreover, when switching to a clock signal produced with an external resonator (or by an external oscillator) while program execution is in progress, wait until the target clock signal is stable.

5. Differences between Products

Before changing from one product to another, i.e. to one with a different part number, confirm that the change will not lead to problems.

- The characteristics of MPU/MCU in the same group but having different part numbers may differ because of the differences in internal memory capacity and layout pattern. When changing to products of different part numbers, implement a system-evaluation test for each of the products.

Notice

- All information included in this document is current as of the date this document is issued. Such information, however, is subject to change without any prior notice. Before purchasing or using any Renesas Electronics products listed herein, please confirm the latest product information with a Renesas Electronics sales office. Also, please pay regular and careful attention to additional and different information to be disclosed by Renesas Electronics such as that disclosed through our website.
- Renesas Electronics does not assume any liability for infringement of patents, copyrights, or other intellectual property rights of third parties by or arising from the use of Renesas Electronics products or technical information described in this document. No license, express, implied or otherwise, is granted hereby under any patents, copyrights or other intellectual property rights of Renesas Electronics or others.
- You should not alter, modify, copy, or otherwise misappropriate any Renesas Electronics product, whether in whole or in part.
- Descriptions of circuits, software and other related information in this document are provided only to illustrate the operation of semiconductor products and application examples. You are fully responsible for the incorporation of these circuits, software, and information in the design of your equipment. Renesas Electronics assumes no responsibility for any losses incurred by you or third parties arising from the use of these circuits, software, or information.
- When exporting the products or technology described in this document, you should comply with the applicable export control laws and regulations and follow the procedures required by such laws and regulations. You should not use Renesas Electronics products or the technology described in this document for any purpose relating to military applications or use by the military, including but not limited to the development of weapons of mass destruction. Renesas Electronics products and technology may not be used for or incorporated into any products or systems whose manufacture, use, or sale is prohibited under any applicable domestic or foreign laws or regulations.
- Renesas Electronics has used reasonable care in preparing the information included in this document, but Renesas Electronics does not warrant that such information is error free. Renesas Electronics assumes no liability whatsoever for any damages incurred by you resulting from errors in or omissions from the information included herein.
- Renesas Electronics products are classified according to the following three quality grades: "Standard", "High Quality", and "Specific". The recommended applications for each Renesas Electronics product depends on the product's quality grade, as indicated below. You must check the quality grade of each Renesas Electronics product before using it in a particular application. You may not use any Renesas Electronics product for any application categorized as "Specific" without the prior written consent of Renesas Electronics. Further, you may not use any Renesas Electronics product for any application for which it is not intended without the prior written consent of Renesas Electronics. Renesas Electronics shall not be in any way liable for any damages or losses incurred by you or third parties arising from the use of any Renesas Electronics product for an application categorized as "Specific" or for which the product is not intended where you have failed to obtain the prior written consent of Renesas Electronics. The quality grade of each Renesas Electronics product is "Standard" unless otherwise expressly specified in a Renesas Electronics data sheets or data books, etc.
"Standard": Computers; office equipment; communications equipment; test and measurement equipment; audio and visual equipment; home electronic appliances; machine tools; personal electronic equipment; and industrial robots.
"High Quality": Transportation equipment (automobiles, trains, ships, etc.); traffic control systems; anti-disaster systems; anti-crime systems; safety equipment; and medical equipment not specifically designed for life support.
"Specific": Aircraft; aerospace equipment; submersible repeaters; nuclear reactor control systems; medical equipment or systems for life support (e.g. artificial life support devices or systems), surgical implantations, or healthcare intervention (e.g. excision, etc.), and any other applications or purposes that pose a direct threat to human life.
- You should use the Renesas Electronics products described in this document within the range specified by Renesas Electronics, especially with respect to the maximum rating, operating supply voltage range, movement power voltage range, heat radiation characteristics, installation and other product characteristics. Renesas Electronics shall have no liability for malfunctions or damages arising out of the use of Renesas Electronics products beyond such specified ranges.
- Although Renesas Electronics endeavors to improve the quality and reliability of its products, semiconductor products have specific characteristics such as the occurrence of failure at a certain rate and malfunctions under certain use conditions. Further, Renesas Electronics products are not subject to radiation resistance design. Please be sure to implement safety measures to guard them against the possibility of physical injury, and injury or damage caused by fire in the event of the failure of a Renesas Electronics product, such as safety design for hardware and software including but not limited to redundancy, fire control and malfunction prevention, appropriate treatment for aging degradation or any other appropriate measures. Because the evaluation of microcomputer software alone is very difficult, please evaluate the safety of the final products or system manufactured by you.
- Please contact a Renesas Electronics sales office for details as to environmental matters such as the environmental compatibility of each Renesas Electronics product. Please use Renesas Electronics products in compliance with all applicable laws and regulations that regulate the inclusion or use of controlled substances, including without limitation, the EU RoHS Directive. Renesas Electronics assumes no liability for damages or losses occurring as a result of your noncompliance with applicable laws and regulations.
- This document may not be reproduced or duplicated, in any form, in whole or in part, without prior written consent of Renesas Electronics.
- Please contact a Renesas Electronics sales office if you have any questions regarding the information contained in this document or Renesas Electronics products, or if you have any other inquiries.
(Note 1) "Renesas Electronics" as used in this document means Renesas Electronics Corporation and also includes its majority-owned subsidiaries.
(Note 2) "Renesas Electronics product(s)" means any product developed or manufactured by or for Renesas Electronics.



SALES OFFICES

Renesas Electronics Corporation

<http://www.renesas.com>

Refer to "<http://www.renesas.com/>" for the latest and detailed information.

Renesas Electronics America Inc.
2880 Scott Boulevard Santa Clara, CA 95050-2554, U.S.A.
Tel: +1-408-586-6000, Fax: +1-408-586-6130

Renesas Electronics Canada Limited
1101 Nicholson Road, Newmarket, Ontario L3Y 9C3, Canada
Tel: +1-905-898-5441, Fax: +1-905-898-3220

Renesas Electronics Europe Limited
Dukes Meadow, Millboard Road, Bourne End, Buckinghamshire, SL8 5FH, U.K.
Tel: +44-1628-585-100, Fax: +44-1628-585-900

Renesas Electronics Europe GmbH
Arcadiastrasse 10, 40472 Düsseldorf, Germany
Tel: +49-211-65030, Fax: +49-211-6503-1327

Renesas Electronics (China) Co., Ltd.
7th Floor, Quantum Plaza, No.27 ZhiChunLu Haidian District, Beijing 100083, P.R.China
Tel: +86-10-8235-1155, Fax: +86-10-8235-7679

Renesas Electronics (Shanghai) Co., Ltd.
Unit 204, 205, AZIA Center, No.1233 Lujiazui Ring Rd., Pudong District, Shanghai 200120, China
Tel: +86-21-5877-1818, Fax: +86-21-6887-7858 / -7898

Renesas Electronics Hong Kong Limited
Unit 1601-1613, 16/F., Tower 2, Grand Century Place, 193 Prince Edward Road West, Mongkok, Kowloon, Hong Kong
Tel: +852-2886-9318, Fax: +852 2886-9022/9044

Renesas Electronics Taiwan Co., Ltd.
13F, No. 363, Fu Shing North Road, Taipei, Taiwan
Tel: +886-2-8175-9600, Fax: +886 2-8175-9670

Renesas Electronics Singapore Pte. Ltd.
1 HarbourFront Avenue, #06-10, Keppel Bay Tower, Singapore 098632
Tel: +65-6213-0200, Fax: +65-6276-8001

Renesas Electronics Malaysia Sdn.Bhd.
Unit 906, Block B, Menara Amcorp, Amcorp Trade Centre, No. 18, Jin Persiaran Barat, 46050 Petaling Jaya, Selangor Darul Ehsan, Malaysia
Tel: +60-3-7955-9390, Fax: +60-3-7955-9510

Renesas Electronics Korea Co., Ltd.
11F., Samik Lavied' or Bldg., 720-2 Yeoksam-Dong, Kangnam-Ku, Seoul 135-080, Korea
Tel: +82-2-558-3737, Fax: +82-2-558-5141