

# ISL71030M

Radiation Tolerant 5V 16-Channel Analog Multiplexer

## Description

The **ISL71030M** is a radiation tolerant, 16-channel multiplexer that is fabricated using the proprietary P6 SOI process technology to provide excellent latch-up performance. It operates with a single supply range from 3V to 5.5V and has a 4-bit address line plus an enable that can be driven with adjustable logic thresholds to conveniently select one of 16 available channels. An inactive channel is separated from the active channel by a high impedance, which inhibits any interaction between the channels.

The ISL71030M low  $r_{DS(ON)}$  allows for improved signal integrity and reduced power losses. The ISL71030M is also designed for cold sparing and is excellent for redundancy in high reliability applications. It is designed to provide a high impedance to the analog source in a powered-off condition, making it easy to add additional backup devices without incurring extra power dissipation. The ISL71030M also has analog overvoltage protection on the input that disables the switch during an overvoltage event to protect upstream and downstream devices.

The ISL71030M is available in a 32 Ld TQFP and operates across the extended temperature range of  $-55^{\circ}\text{C}$  to  $+125^{\circ}\text{C}$ .

## Applications

- Telemetry signal processing
- Harsh environments
  - Down-hole drilling

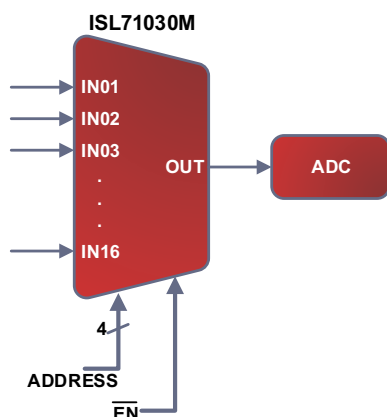

Figure 1. Typical Application

## Features

- Qualified to Renesas Rad Tolerant Screening and QCI Flow ([R34TB0004EU](#))
- Fabricated using P6 SOI process technology
- Rail-to-rail operation
- No latch-up
- Low  $r_{DS(ON)}$ :  $<120\Omega$  (maximum)
- Single supply operation: 3V to 5.5V
- Adjustable logic threshold control
- Cold sparing capable:  $-0.4\text{V}$  to  $7\text{V}$
- Analog overvoltage range:  $-0.4\text{V}$  to  $7\text{V}$
- Switch input off leakage:  $120\text{nA}$
- Transition times ( $t_{AHL}$ ):  $70\text{ns}$
- Break-before-make switching
- ESD protection  $\geq 5\text{kV}$  (HBM)
- Passes NASA low outgassing specifications
- NiPdAu lead finish (Pb-free, Sn-free)
- Operating temperature range:  $-55^{\circ}\text{C}$  to  $+125^{\circ}\text{C}$
- TID Radiation Lot Acceptance Testing (LDR:  $<0.01\text{rad}(\text{Si})/\text{s}$ )
  - ISL71030M30NZ:  $30\text{krad}(\text{Si})$
  - ISL71030M50NZ:  $50\text{krad}(\text{Si})$
- SEE Characterization
  - No DSEE for  $V_+ = 7\text{V}$  at  $43\text{MeV}\cdot\text{cm}^2/\text{mg}$
  - $|V_{\text{OUT SET}}| < 70\text{mV}$  with  $V_+ = 5.5\text{V}$  and  $V_{\text{OUT}} = 2.75\text{V}$  at  $43\text{MeV}\cdot\text{cm}^2/\text{mg}$

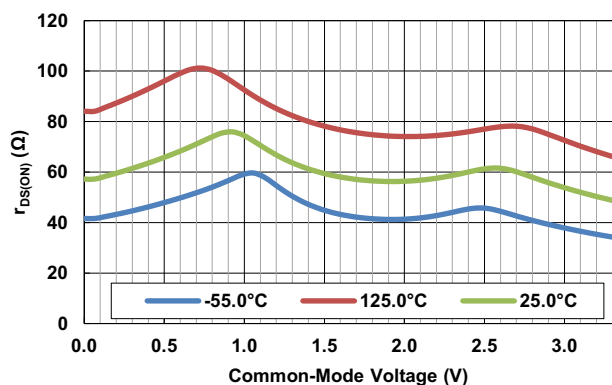

Figure 2.  $r_{DS(ON)}$  vs Common-Mode Voltage ( $V_+ = 4.5\text{V}$ )

## Contents

<b>1. Pin Information</b>	<b>3</b>
1.1 Pin Assignments	3
1.2 Pin Descriptions	3
<b>2. Specifications</b>	<b>4</b>
2.1 Absolute Maximum Ratings	4
2.2 Outgas Testing	4
2.3 Thermal Information	4
2.4 Recommended Operating Conditions	4
2.5 Electrical Specifications, V+ = 5V	5
2.6 Electrical Specifications, V+ = 3.3V	6
2.7 Timing Diagrams	8
<b>3. Typical Performance Graphs</b>	<b>10</b>
<b>4. Application Information</b>	<b>12</b>
4.1 Power-Up Considerations	12
4.2 Overvoltage Protection	12
4.3 VREF and Logic Functionality	12
4.4 Considerations for Redundant Applications	12
<b>5. Radiation Tolerance</b>	<b>13</b>
5.1 Total Ionizing Dose (TID) Testing	13
5.1.1 Introduction	13
5.1.2 Results	13
5.1.3 Typical Radiation Performance Graphs	14
5.1.4 Conclusion	16
5.2 Single-Event Effects Testing	19
5.2.1 SEE Test Facility	19
5.2.2 SEE Test Setups	19
5.2.3 Single Event Burnout and Latch-Up (SEB/L) Results	19
5.2.4 SET Results	19
5.2.5 Conclusion	20
<b>6. Package Outline Drawing</b>	<b>21</b>
<b>7. Ordering Information</b>	<b>22</b>
<b>8. Revision History</b>	<b>22</b>

# 1. Pin Information

## 1.1 Pin Assignments

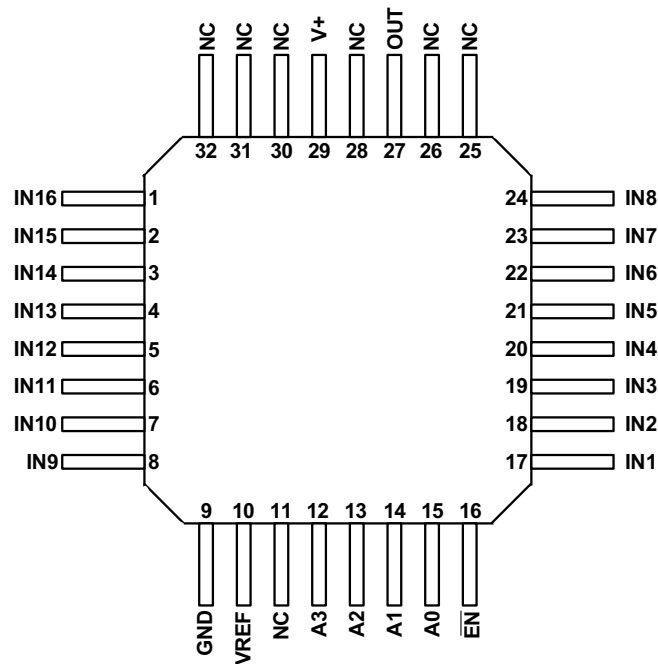
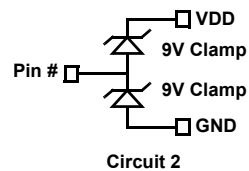
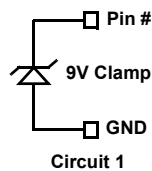

Figure 3. -Pin Assignments - Top View

## 1.2 Pin Descriptions

Pin Number	ESD Circuit	Pin Name	Description
1, 2, 3, 4, 5, 6, 7, 8, 17, 18, 19, 20, 21, 22, 23, 24	1	INx	Multiplexer input
9	-	GND	Ground
10	1	VREF	Reference voltage that sets logic thresholds.
11, 25, 26, 28, 30, 31, 32	-	NC	Not electrically connected
12, 13, 14, 15	1	Ax	Multiplexer address lines
16	1	EN	Multiplexer Enable control (active low).
27	2	OUT	Multiplexer output
29	1	V+	Positive power supply



## 2. Specifications

### 2.1 Absolute Maximum Ratings

**Caution:** Do not operate at or near the maximum ratings listed for extended periods of time. Exposure to such conditions can adversely impact product reliability and result in failures not covered by warranty.

Parameter	Minimum	Maximum	Unit
Maximum Supply Voltage (V+ to GND)	-	7	V
Maximum Supply Voltage (V+ to GND) <sup>[1]</sup>	-	6.5	V
Analog Input Voltage Range (INx)	-0.4	7	V
Digital Input Voltage Range (EN, Ax)	GND - 0.4	VREF	V
VREF to GND	-	7	V
Maximum Operating Junction Temperature	-	+150	°C
Human Body Model (Tested per MIL-STD-883 TM 3015)	-	5	kV
Charged Device Model (Tested per JS-002-2014)	-	500	V

1. Tested in a heavy ion environment at LET = 43MeV•cm<sup>2</sup>/mg.

### 2.2 Outgas Testing

Specification (Tested per ASTM E 595, 1.5)	Value	Unit
Total Mass Lost <sup>[1]</sup>	0.03	%
Collected Volatile Condensable Material <sup>[1]</sup>	<0.01	%
Water Vapor Recovered	0.02	%

1. Results meet NASA low outgassing requirements of Total Mass Lost of <1% and Collected Volatile Condensable Material of <0.1%.

### 2.3 Thermal Information

Parameter	Package	Symbol	Conditions	Typical Value	Unit
Thermal Resistance	32 Ld TQFP	$\theta_{JA}$ <sup>[1]</sup>	Junction to ambient	61	°C/W
		$\theta_{JC}$ <sup>[2]</sup>	Junction to case	26	°C/W

1.  $\theta_{JA}$  is measured with the component mounted on a high-effective thermal conductivity test board in free air. See [TB379](#).
2. For  $\theta_{JC}$ , the case temperature location is taken at the package top center.

### 2.4 Recommended Operating Conditions

Parameter	Minimum	Maximum	Unit
Supply Voltage, V <sub>CC</sub>	3	5.5	V
Ambient Operating Temperature Range	-55	+125	°C
V <sub>REF</sub> to GND	3	5.5	V

## 2.5 Electrical Specifications, V+ = 5V

Recommended operating conditions, GND = 0V, V<sub>REF</sub> = 5V, V<sub>IH</sub> = 5V, V<sub>IL</sub> = 0V, T<sub>A</sub> = +25°C, unless otherwise noted. **Boldface limits apply across the operating temperature range, -55°C to +125°C by characterization with production testing at +25°C; over a total ionizing dose of 30krad(Si) at +25°C with exposure at a low dose rate of <10mrad(Si)/s (ISL71030M30NZ); or over a total ionizing dose of 50krad(Si) at +25°C with exposure at a low dose rate of <10mrad(Si)/s (ISL71030M50NZ).**

Parameter	Symbol	Test Conditions	Min <sup>[1]</sup>	Typ	Max <sup>[1]</sup>	Unit
Analog Input Signal Range	V <sub>IN</sub>	-	0		V+	V
Channel On-Resistance	r <sub>DS(ON)</sub>	V+ = 4.5V, V <sub>IN</sub> = 0V to V+ I <sub>OUT</sub> = 1mA	-	40	<b>120</b>	Ω
r <sub>DS(ON)</sub> Match Between Channels	Δr <sub>DS(ON)</sub>	V+ = 4.5V, V <sub>IN</sub> = 0V, 2.25V, 4.5V I <sub>OUT</sub> = 1mA	-	-	<b>5</b>	Ω
On-Resistance Flatness	r <sub>FLAT(ON)</sub>	V+ = 4.5V, V <sub>IN</sub> = 0V to V+	-	-	<b>40</b>	Ω
Switch Input Off Leakage	I <sub>IN(OFF)</sub>	V+ = 5.5V, V <sub>IN</sub> = 5V, Unused inputs and V <sub>OUT</sub> = 0.5V	<b>-30</b>	-	<b>30</b>	nA
		V+ = 5.5V, V <sub>IN</sub> = 0.5V, Unused inputs and V <sub>OUT</sub> = 5V	<b>-30</b>	-	<b>30</b>	nA
Switch Input Off Overvoltage Leakage	I <sub>IN(OFF-0V)</sub>	V+ = 5.5V, V <sub>IN</sub> = 7V, Unused inputs and V <sub>OUT</sub> = 0V, T <sub>A</sub> = +25°C, -55°C	-30	-	30	nA
		T <sub>A</sub> = +125°C	-30	-	120	nA
		Post radiation, +25°C	-30	-	30	nA
Switch Input Off Leakage with Supply Voltage Grounded	I <sub>IN(POWER-OFF)</sub>	V <sub>IN</sub> = 7V, V <sub>OUT</sub> = 0V, V+ = V <sub>EN</sub> = V <sub>REF</sub> = 0V, T <sub>A</sub> = +25°C, -55°C	-20	-	20	nA
		T <sub>A</sub> = +125°C	-20	-	50	nA
		Post radiation, +25°C	-20	-	20	nA
Switch Input Off Leakage with Supply Voltage Open	I <sub>IN(POWER-OFF)</sub>	V <sub>IN</sub> = 7V, V <sub>OUT</sub> = 0V, V+ = V <sub>EN</sub> = V <sub>REF</sub> = Open, T <sub>A</sub> = +25°C, -55°C	-20	-	20	nA
		T <sub>A</sub> = +125°C	-20	-	50	nA
		Post radiation, +25°C	-20	-	20	nA
Switch On Input Leakage with Over Voltage Applied to Input	I <sub>IN(ON-0V)</sub>	V+ = 5.5V, V <sub>IN</sub> = 7V, V <sub>OUT</sub> = OPEN	<b>2.75</b>	-	<b>5.50</b>	μA
Switch Output Off Leakage	I <sub>OUT(OFF)</sub>	V+ = 5.5V, V <sub>OUT</sub> = 5V, All inputs = 0.5V, T <sub>A</sub> = +25°C, -55°C	-30	-	30	nA
		T <sub>A</sub> = +125°C	0	-	150	nA
		Post radiation, +25°C	-30	-	30	nA
		V+ = 5.5V, V <sub>OUT</sub> = 0.5V, All inputs = 5V, T <sub>A</sub> = +25°C, -55°C	<b>-30</b>	-	<b>30</b>	nA
		Post radiation, +25°C	-30	-	30	nA
Switch Output Leakage with Switch Enabled	I <sub>OUT(ON)</sub>	V+ = 5.5V, V <sub>IN</sub> = V <sub>OUT</sub> = 5V, All unused inputs at 0.5V, T <sub>A</sub> = +25°C, -55°C	-30	-	30	nA
		T <sub>A</sub> = +125°C	0	-	150	nA
		Post radiation, +25°C	-30	-	30	nA
		V+ = 5.5V, V <sub>IN</sub> = V <sub>OUT</sub> = 0.5V, All unused inputs at 5V	<b>-30</b>	-	<b>30</b>	nA
		Post radiation, +25°C	-30	-	30	nA
Logic Input Voltage High/Low	V <sub>IH/L</sub>	V+ = 5.5V, V <sub>REF</sub> = 3.3V	<b>1.3</b>	-	<b>1.6</b>	V
Input Current with V <sub>AH</sub> , V <sub>ENH</sub>	I <sub>AH</sub> , I <sub>ENH</sub>	V+ = 5.5V, V <sub>EN</sub> = V <sub>A</sub> = V <sub>REF</sub>	<b>-0.1</b>	-	<b>0.1</b>	μA
Input Current with V <sub>AL</sub> , V <sub>ENL</sub>	I <sub>AL</sub> , I <sub>ENL</sub>	V+ = 5.5V, V <sub>EN</sub> = V <sub>A</sub> = 0V	<b>-0.1</b>	-	<b>0.1</b>	μA
Quiescent Supply Current	I <sub>SUPPLY</sub>	V+ = V <sub>REF</sub> = V <sub>EN</sub> = 5.5V, V <sub>A</sub> = 0V, T <sub>A</sub> = +25°C, -55°C	-	-	100	nA
		T <sub>A</sub> = +125°C	-	-	300	nA
		Post radiation, +25°C	-	-	300	nA

Recommended operating conditions, GND = 0V, V<sub>REF</sub> = 5V, V<sub>IH</sub> = 5V, V<sub>IL</sub> = 0V, T<sub>A</sub> = +25°C, unless otherwise noted. **Boldface limits apply across the operating temperature range, -55°C to +125°C by characterization with production testing at +25°C; over a total ionizing dose of 30krad(Si) at +25°C with exposure at a low dose rate of <10mrad(Si)/s (ISL71030M30NZ); or over a total ionizing dose of 50krad(Si) at +25°C with exposure at a low dose rate of <10mrad(Si)/s (ISL71030M50NZ).** (Cont.)

Parameter	Symbol	Test Conditions	Min <sup>[1]</sup>	Typ	Max <sup>[1]</sup>	Unit
Reference Quiescent Supply Current	I <sub>REF</sub>	V <sub>+</sub> = V <sub>REF</sub> = V <sub>EN</sub> = 5.5V V <sub>A</sub> = 0V	-	-	<b>200</b>	nA
<b>Dynamic</b>						
Addressing Transition Time	t <sub>AHL</sub>	V <sub>+</sub> = 4.5V; <a href="#">Figure 4</a>	<b>10</b>	-	<b>70</b>	ns
Break-Before-Make-Delay	t <sub>BBM</sub>	V <sub>+</sub> = 4.5V; <a href="#">Figure 8</a>	<b>5</b>	18	<b>40</b>	ns
Enable Turn-On Time	t <sub>EN(ON)</sub>	V <sub>+</sub> = 4.5V; <a href="#">Figure 6</a>	-	-	<b>40</b>	ns
Enable Turn-Off Time	t <sub>EN(OFF)</sub>	V <sub>+</sub> = 4.5V; <a href="#">Figure 6</a>	-	-	<b>40</b>	ns
Charge Injection	V <sub>CTE</sub>	C <sub>L</sub> = 100pF, V <sub>IN</sub> = 0V, <a href="#">Figure 10</a>	-	1.4	5	pC
Off Isolation	V <sub>ISO</sub>	V <sub>EN</sub> = V <sub>REF</sub> , R <sub>L</sub> = OPEN, f = 1kHz	<b>60</b>	-	-	dB
Crosstalk	V <sub>CT</sub>	V <sub>EN</sub> = 0V, f = 1kHz, V <sub>P-P</sub> = 1V, R <sub>L</sub> = OPEN	<b>73</b>	-	-	dB
Input Capacitance	C <sub>IN(OFF)</sub>	f = 1MHz	-	-	<b>5</b>	pF
Output Capacitance	C <sub>OUT(OFF)</sub>	f = 1MHz	-	-	<b>25</b>	pF

1. Compliance to datasheet limits is assured by one or more methods: production test, characterization, and/or design.

## 2.6 Electrical Specifications, V<sub>+</sub> = 3.3V

Recommended operating conditions, GND = 0V, V<sub>REF</sub> = 3.3V, V<sub>IH</sub> = 3.3V, V<sub>IL</sub> = 0V, T<sub>A</sub> = +25°C, unless otherwise noted. **Boldface limits apply across the operating temperature range, -55°C to +125°C by characterization with production testing at +25°C; over a total ionizing dose of 30krad(Si) at +25°C with exposure at a low dose rate of <10mrad(Si)/s (ISL71030M30NZ); or over a total ionizing dose of 50krad(Si) at +25°C with exposure at a low dose rate of <10mrad(Si)/s (ISL71030M50NZ).**

Parameter	Symbol	Test Conditions	Min <sup>[1]</sup>	Typ	Max <sup>[1]</sup>	Unit
Analog Input Signal Range	V <sub>IN</sub>	-	0	-	V <sub>+</sub>	V
Channel On-Resistance	r <sub>DS(ON)</sub>	V <sub>+</sub> = 3V, V <sub>IN</sub> = 0V to V <sub>+</sub> , I <sub>OUT</sub> = 1mA	<b>25</b>	70	<b>200</b>	Ω
r <sub>DS(ON)</sub> Match Between Channels	Δr <sub>DS(ON)</sub>	V <sub>+</sub> = 3V, V <sub>IN</sub> = 0.5V, 2.5V, I <sub>OUT</sub> = 1mA	-	-	5	Ω
On-Resistance Flatness	r <sub>FLAT(ON)</sub>	V <sub>+</sub> = 3V, V <sub>IN</sub> = 0V to V <sub>+</sub>	-	-	<b>50</b>	Ω
Switch Input Off Leakage	I <sub>IN(OFF)</sub>	V <sub>+</sub> = 3.6V, V <sub>IN</sub> = 3.1V, Unused inputs and V <sub>OUT</sub> = 0.5V	<b>-30</b>	-	<b>30</b>	nA
		V <sub>+</sub> = 3.6V, V <sub>IN</sub> = 0.5V, Unused inputs and V <sub>OUT</sub> = 3.1V	<b>-30</b>	-	<b>30</b>	nA
Switch Input Off Overvoltage Leakage	I <sub>IN(OFF-OV)</sub>	V <sub>+</sub> = 3.6V, V <sub>IN</sub> = 7V, Unused inputs and V <sub>OUT</sub> = 0V, T <sub>A</sub> = +25°C, -55°C	-30	-	30	nA
		T <sub>A</sub> = +125°C	-30	-	100	nA
		Post radiation, +25°C	-30	-	30	nA
Switch On Input Leakage with Overvoltage Applied to the Input	I <sub>IN(ON-OV)</sub>	V <sub>+</sub> = 3.6V, V <sub>IN</sub> = 7V, V <sub>OUT</sub> = OPEN	<b>1.8</b>	-	<b>3.6</b>	μA
Switch Output Off Leakage	I <sub>OUT(OFF)</sub>	V <sub>+</sub> = 3.6V, V <sub>OUT</sub> = 3.1V, All inputs = 0.5V, T <sub>A</sub> = +25°C, -55°C	-30	-	30	nA
		T <sub>A</sub> = +125°C	0	-	60	nA
		Post radiation, +25°C	-30	-	30	nA
		V <sub>+</sub> = 3.6V, V <sub>OUT</sub> = 0.5V, All inputs = 3.1V, T <sub>A</sub> = +25°C, -55°C	-30	-	30	nA
		T <sub>A</sub> = +125°C	0	-	30	nA
		Post radiation, +25°C	-30	-	30	nA

Recommended operating conditions, GND = 0V, V<sub>REF</sub> = 3.3V, V<sub>IH</sub> = 3.3V, V<sub>IL</sub> = 0V, T<sub>A</sub> = +25°C, unless otherwise noted. **Boldface limits apply across the operating temperature range, -55°C to +125°C by characterization with production testing at +25°C; over a total ionizing dose of 30krad(Si) at +25°C with exposure at a low dose rate of <10mrad(Si)/s (ISL71030M30NZ); or over a total ionizing dose of 50krad(Si) at +25°C with exposure at a low dose rate of <10mrad(Si)/s (ISL71030M50NZ). (Cont.)**

Parameter	Symbol	Test Conditions	Min <sup>[1]</sup>	Typ	Max <sup>[1]</sup>	Unit
Switch Output Leakage with Switch Enabled	I <sub>OUT(ON)</sub>	V+ = 3.6V, V <sub>IN</sub> = V <sub>OUT</sub> = 3.1V All unused inputs at 0.5V, T <sub>A</sub> = +25°C, -55°C	-30	-	30	nA
		T <sub>A</sub> = +125°C	0	-	30	nA
		Post radiation, +25°C	-30	-	30	nA
		V+ = 3.6V, V <sub>IN</sub> = V <sub>OUT</sub> = 0.5V All unused inputs at 3.1V, T <sub>A</sub> = +25°C, -55°C	-30	-	30	nA
		T <sub>A</sub> = +125°C	0	-	30	nA
		Post radiation, +25°C	-30	-	30	nA
Quiescent Supply Current	I <sub>SUPPLY</sub>	V+ = V <sub>REF</sub> = V <sub>EN</sub> = 3.6V V <sub>A</sub> = 0V, T <sub>A</sub> = +25°C, -55°C	-	-	100	nA
		T <sub>A</sub> = +125°C	-	-	300	nA
		Post radiation, +25°C	-	-	300	nA
Reference Quiescent Supply Current	I <sub>REF</sub>	V+ = V <sub>REF</sub> = V <sub>EN</sub> = 3.6V, V <sub>A</sub> = 0V	-	-	<b>200</b>	nA
<b>Dynamic</b>						
Addressing Transition Time	t <sub>AHL</sub>	V+ = 3V; <a href="#">Figure 4</a>	<b>10</b>	-	<b>100</b>	ns
Break-Before-Make Delay	t <sub>BBM</sub>	V+ = 3V; <a href="#">Figure 8</a>	<b>5</b>	25	<b>50</b>	ns
Enable Turn-On Time	t <sub>EN(ON)</sub>	V+ = 3V; <a href="#">Figure 6</a>	-	-	<b>50</b>	ns
Enable Turn-Off Time	t <sub>EN(OFF)</sub>	V+ = 3V; <a href="#">Figure 6</a>	-	-	<b>50</b>	ns

1. Compliance to datasheet limits is assured by one or more methods: production test, characterization, and/or design.

Table 1. Truth Table<sup>[1]</sup>

A3	A2	A1	A0	EN	ON Channel
X	X	X	X	1	None
0	0	0	0	0	1
0	0	0	1	0	2
0	0	1	0	0	3
0	0	1	1	0	4
0	1	0	0	0	5
0	1	0	1	0	6
0	1	1	0	0	7
0	1	1	1	0	8
1	0	0	0	0	9
1	0	0	1	0	10
1	0	1	0	0	11
1	0	1	1	0	12
1	1	0	0	0	13
1	1	0	1	0	14
1	1	1	0	0	15
1	1	1	1	0	16

1. X = Don't care, 1 = Logic High, 0 = Logic Low.

## 2.7 Timing Diagrams

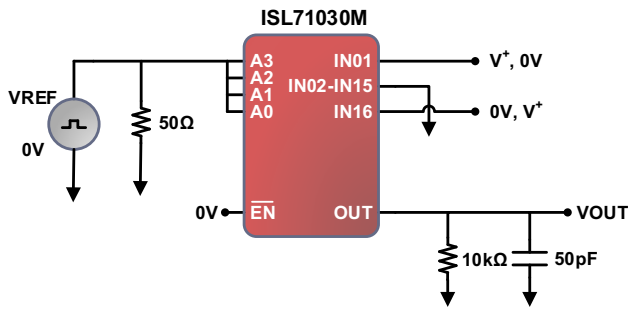

Figure 4. Address Time to Output Test Circuit

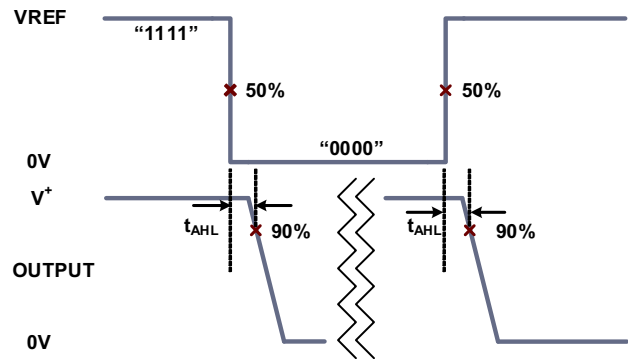

Figure 5. Address Time to Output Diagram



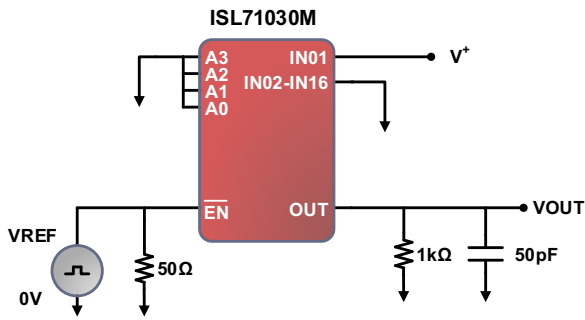

Figure 6. Time to Enable/Disable Output Test Circuit

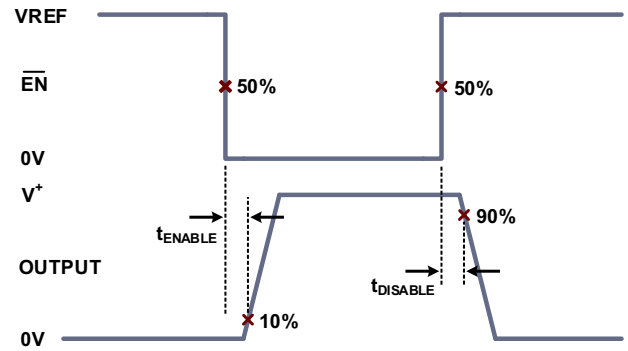

Figure 7. Time to Enable/Disable Output Diagram

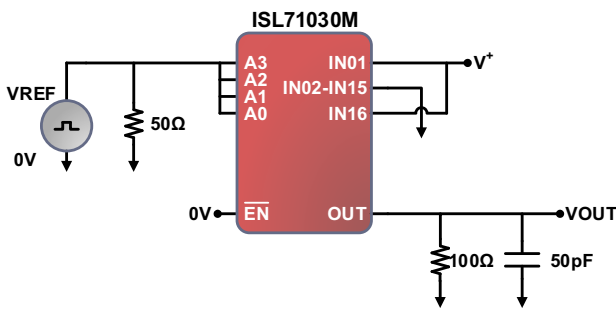

Figure 8. Break-Before-Make Test Circuit

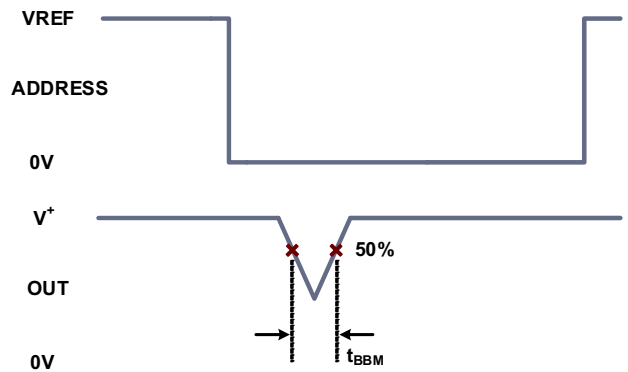

Figure 9. Break-Before-Make Diagram

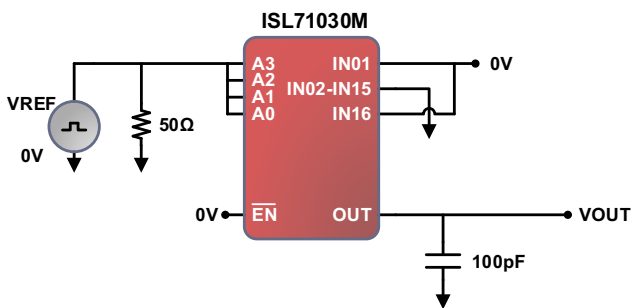

Figure 10. Charge Injection Test Circuit

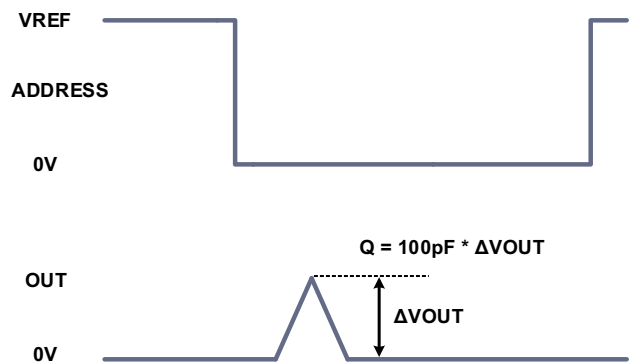

Figure 11. Charge Injection Diagram

### 3. Typical Performance Graphs

V+ = 5V, V<sub>REF</sub> = 3.3V, V<sub>IN</sub> = 0V, R<sub>L</sub> = Open, T<sub>A</sub> = +25°C, unless otherwise specified

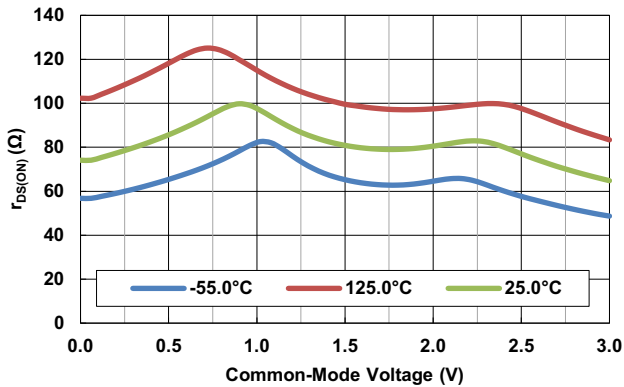

Figure 12. r<sub>DS(ON)</sub> vs Common-Mode Voltage (V+ = 3V)

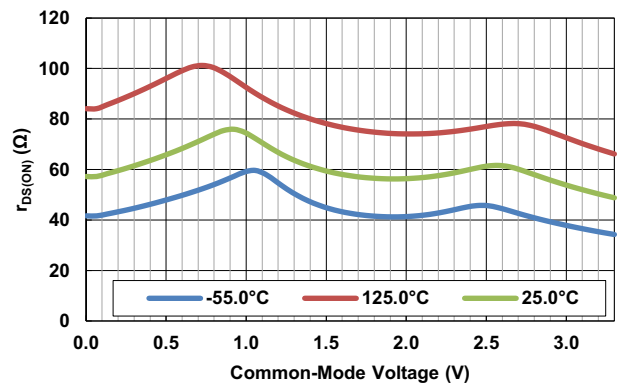

Figure 13. r<sub>DS(ON)</sub> vs Common-Mode Voltage (V+ = 4.5V)

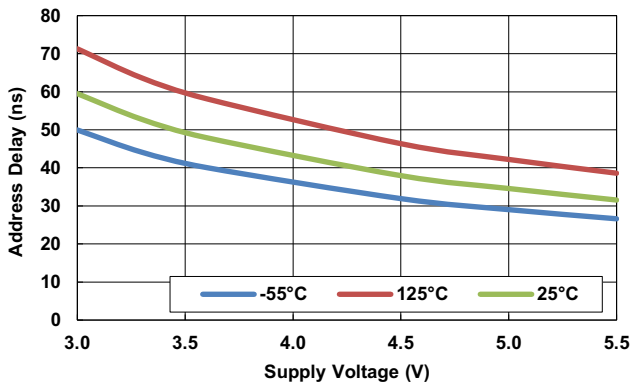

Figure 14. Address Propagation Delay (High to Low)

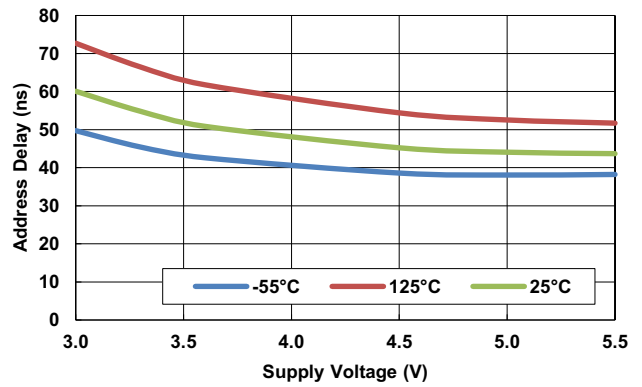

Figure 15. Address Propagation Delay (Low to High)

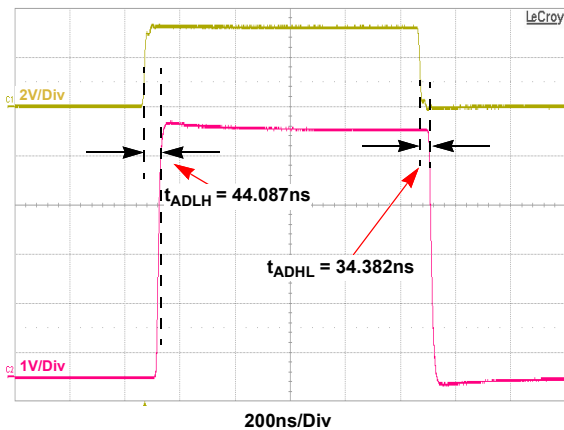

Figure 16. Address Propagation Delay

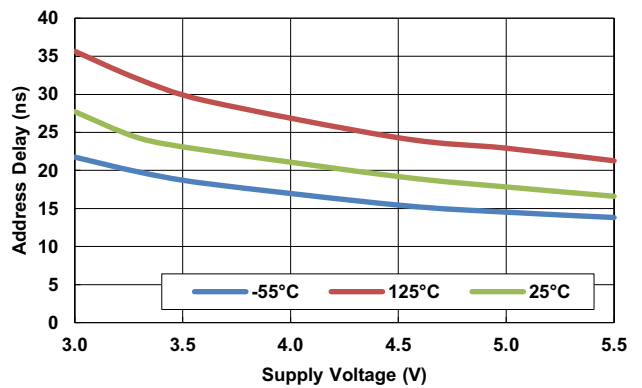

Figure 17. Break-Before-Make Delay

V+ = 5V, V<sub>REF</sub> = 3.3V, V<sub>IN</sub> = 0V, R<sub>L</sub> = Open, T<sub>A</sub> = +25°C, unless otherwise specified (Cont.)

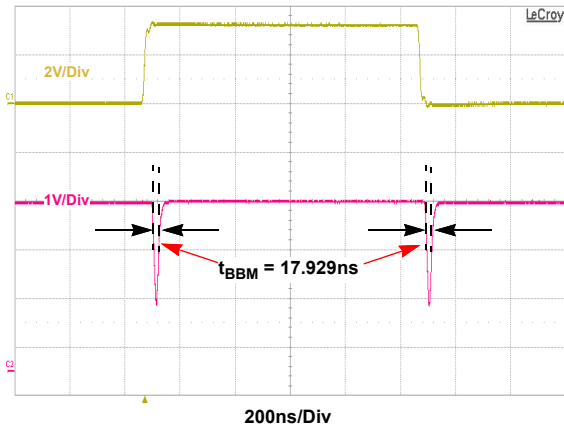

Figure 18. Break-Before-Make Delay

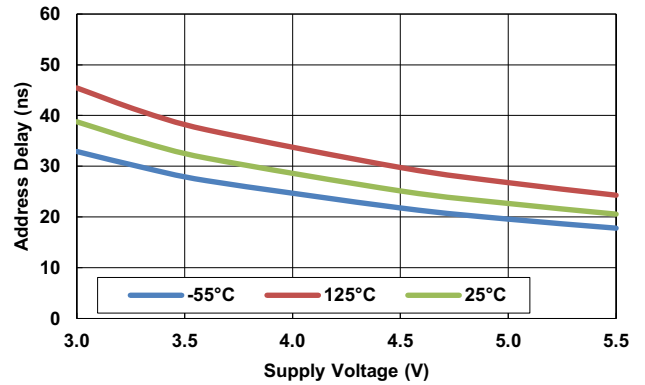

Figure 19. Enable to Output Propagation Delay

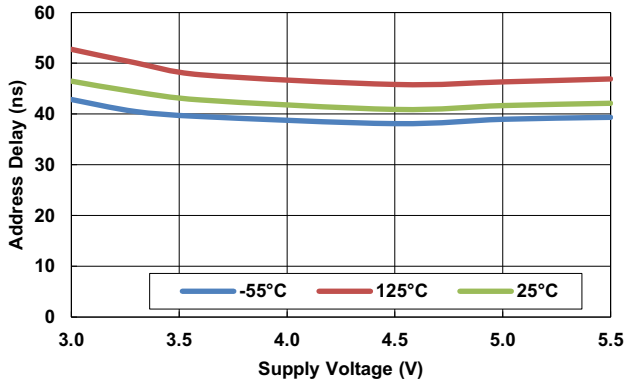

Figure 20. Disable to Output Propagation Delay

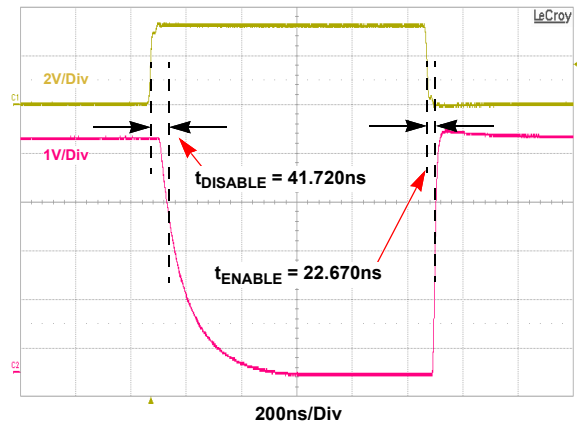

Figure 21. Enable/Disable Propagation Delay

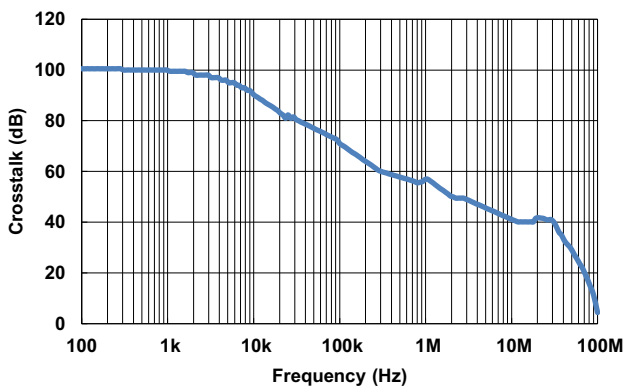

Figure 22. Off Isolation (V+ = 5V, +25°C, R<sub>L</sub> = 511Ω)

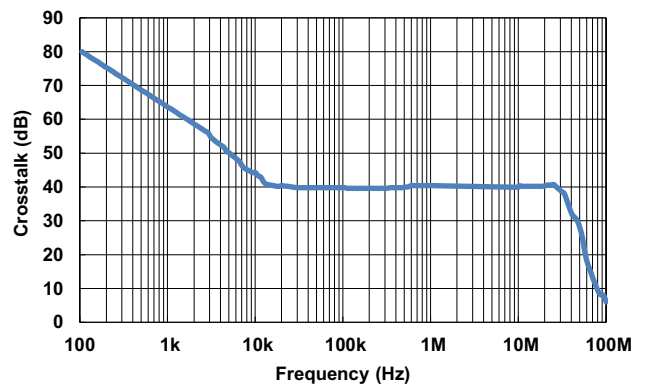

Figure 23. Off Isolation (V+ = 5V, +25°C, R<sub>L</sub> = Open)

V+ = 5V, V<sub>REF</sub> = 3.3V, V<sub>IN</sub> = 0V, R<sub>L</sub> = Open, T<sub>A</sub> = +25°C, unless otherwise specified (Cont.)

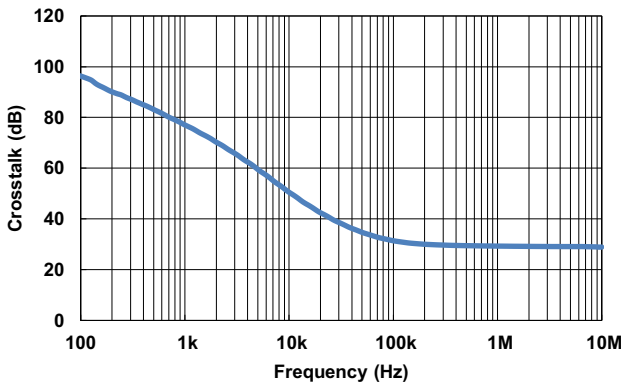

Figure 24. Crosstalk (V+ = 5V, +25°C, R<sub>L</sub> = Open)

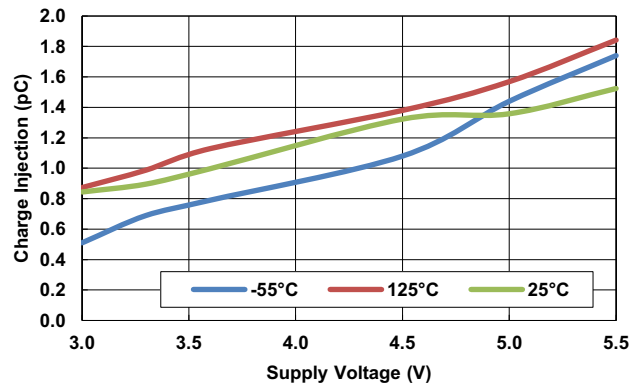

Figure 25. Charge Injection

## 4. Application Information

### 4.1 Power-Up Considerations

The circuit is insensitive to any given power-up sequence between V+ and VREF; however, Renesas recommends that all supplies power up relatively close to each other.

### 4.2 Overvoltage Protection

The ISL71030M has overvoltage protection on both the input and the output. On the output, the voltage is limited to a diode past the rails. Each of the inputs has independent overvoltage protection that works regardless of the switch being selected. If a switch experiences an overvoltage condition, the switch is turned off. As soon as the voltage returns within the rails, the switch returns to normal operation.

### 4.3 VREF and Logic Functionality

The VREF pin sets the logic threshold for the ISL71030M. The range for VREF is between 3V and 5.5V. The switching point is set to around 50% of the voltage presented to VREF. This switching point allows for both 5V and 3.3V logic control.

### 4.4 Considerations for Redundant Applications

When using the ISL71030M in a cold sparing application, Renesas recommends keeping the ground pin connected to system ground at all times. Both supply pins (V+ and VREF) should either be grounded or floating together.

If the supply pins are floating, Renesas recommends placing a high value bleed resistor (~1MΩ) in parallel with the decoupling capacitors on each supply pin to ensure that the supply voltage is discharged in a predictable manner. Figure 26 and Figure 27 illustrate the recommended cold sparing setup for both shorted and floating supplies.

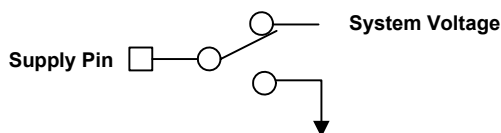

Figure 26. Cold Sparing Setup with Supplies Shorted

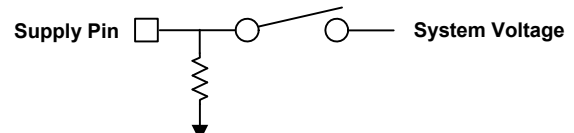

Figure 27. Cold Sparing Setup with Supplies Floating

## 5. Radiation Tolerance

The ISL71030M is a radiation tolerant device for commercial space applications, Low Earth Orbit (LEO) applications, high altitude avionics, launch vehicles, and other harsh environments. This device's response to Total Ionizing Dose (TID) radiation effects and Single-Event Effects (SEE) has been measured, characterized, and reported in the following sections. The TID performance of ISL71030MNZ is not guaranteed through radiation acceptance testing. The ISL71030M30NZ is radiation lot acceptance tested (RLAT) to 30krad(Si), and the ISL71030M50NZ is radiation lot acceptance tested to 50krad(Si). The SEE characterization performance is not guaranteed.

### 5.1 Total Ionizing Dose (TID) Testing

#### 5.1.1 Introduction

This test was conducted to determine the sensitivity of the part to the total dose environment. Testing was performed on two separate sample sets. For the first sample set, test downpoints were 0krad(Si), 10krad(Si), 20krad(Si), and 30krad(Si). The second sample set was irradiated to 50krad(Si). Total dose testing was performed using a Hopewell Designs N40 paronormic 60Co irradiator. The irradiations were performed at 0.00875rad(Si)/s. A PbAl box was used to shield the test fixture and devices under test against low energy secondary gamma radiation. The characterization matrix of the first sample set consisted of 24 samples irradiated under bias and 12 samples irradiated with all pins grounded. The characterization matrix of the second sample set consisted of 5 samples irradiated under bias and 5 samples irradiated with all pins grounded.

Four control units were used to ensure repeatable data. Two different wafers were used.

#### 5.1.2 Results

[Table 2](#) summarizes the attributes data. "Bin 1" indicates a device that passes all datasheet specification limits.

**Table 2. Total Dose Test Attributes Data**

Dose Rate	Bias	Sample Size	Downpoint	Bin 1	Rejects
8.75	Biased	16	Pre-rad	16	0
			10krad(Si)	16	0
			20krad(Si)	16	0
			30krad(Si)	16	0
		5	50krad(Si)	5	0
8.75	Grounded	16	Pre-rad	16	0
			10krad(Si)	16	0
			20krad(Si)	16	0
			30krad(Si)	16	0
		5	50krad(Si)	5	0

[Figure 28](#) through [Figure 39](#) show data for key parameters at all downpoints. The plots show the average as a function of total dose for each of the irradiation conditions; The data from the second sample was appended to the data from the first sample set. All parts showed excellent stability over radiation.

### 5.1.3 Typical Radiation Performance Graphs

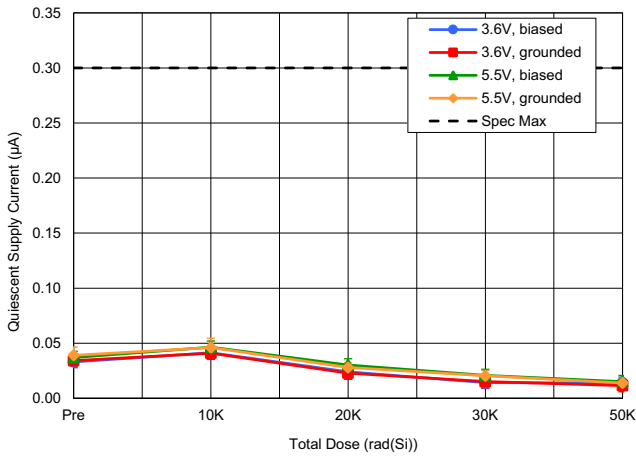

Figure 28. Quiescent Supply Current

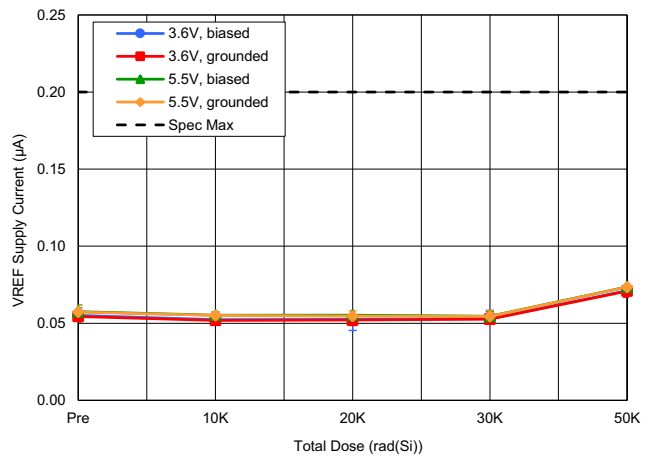

Figure 29. VREF Supply Current vs TID

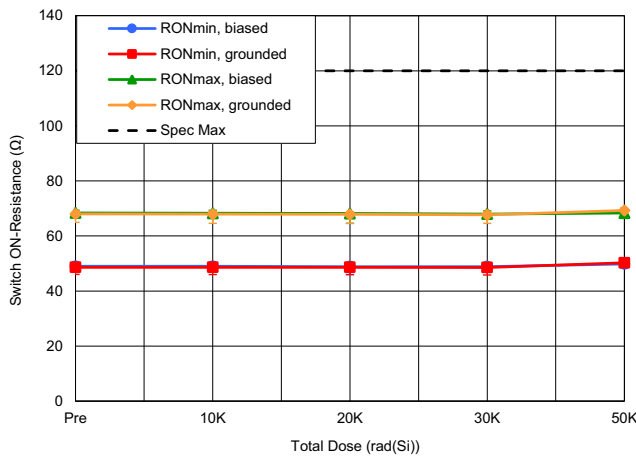

Figure 30. Switch ON Resistance vs TID

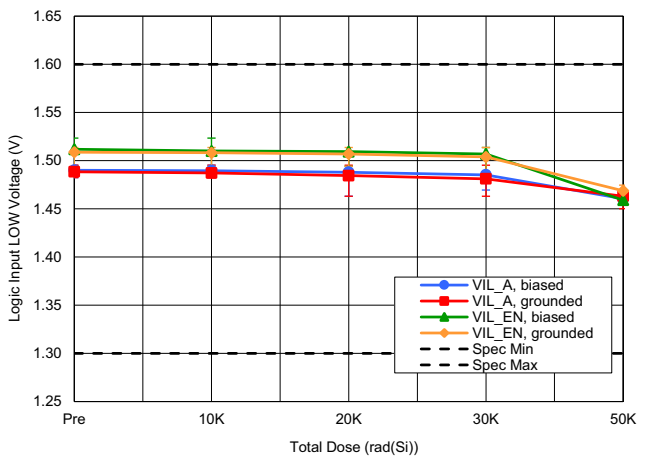

Figure 31. Logic Input LOW Voltage vs TID

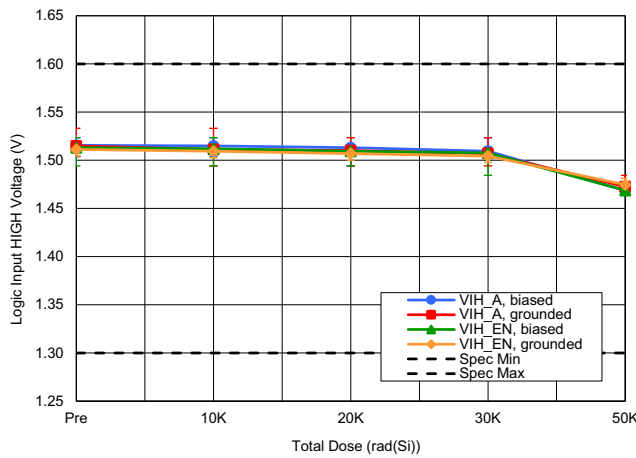

Figure 32. Logic Input HIGH Voltage vs TID

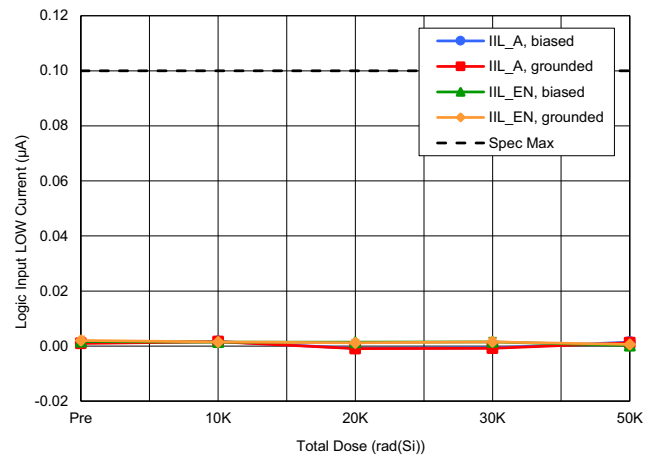

Figure 33. Logic Input LOW Current vs TID

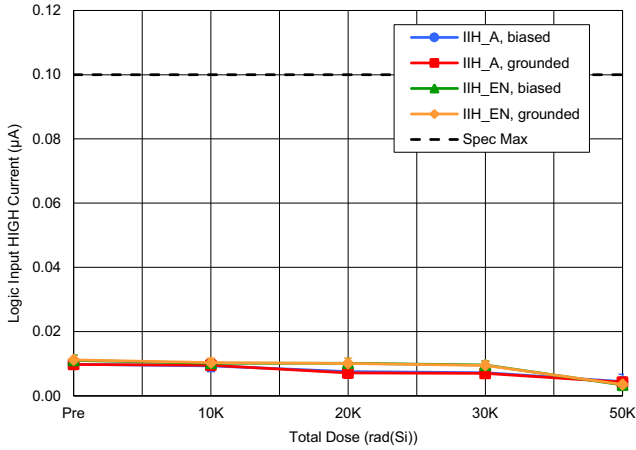

Figure 34. Logic Input HIGH Current vs TID

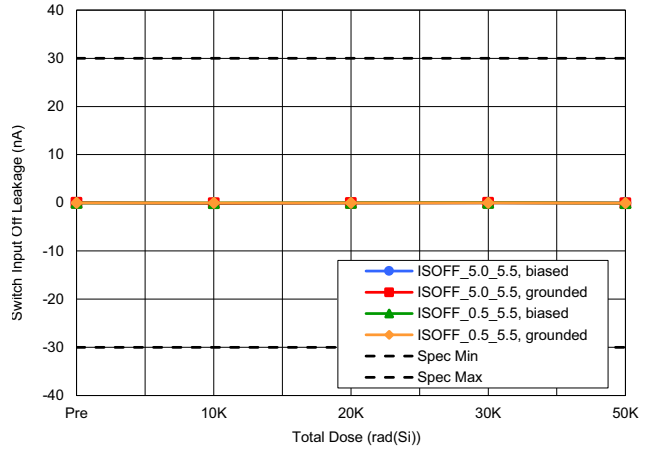

Figure 35. Switch Input Off Leakage vs TID

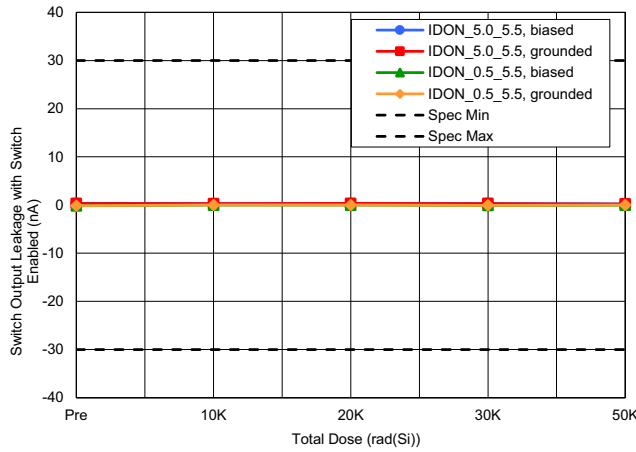

Figure 36. Output Leakage with Switch Enabled vs TID

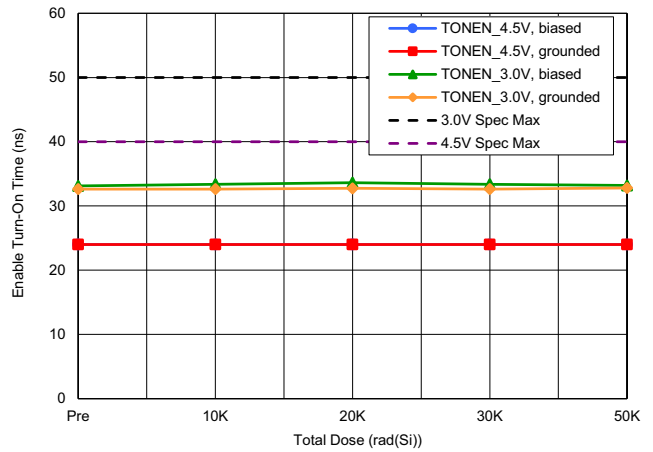

Figure 37. Enable Turn-On Time vs TID

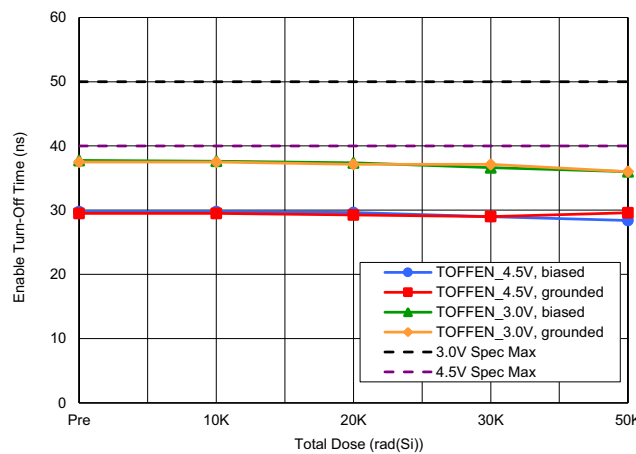

Figure 38. Enable Turn-Off Time vs TID

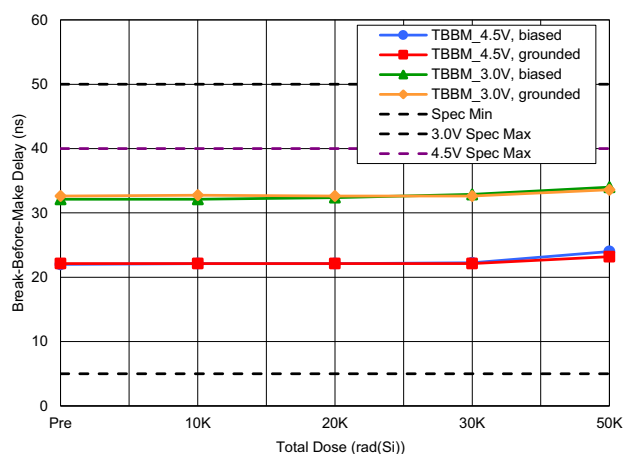

Figure 39. Break-Before-Make Delay vs TID

### 5.1.4 Conclusion

The ISL71030M 16-channel analog multiplexer was tested at low dose rate under biased and unbiased conditions to 50krad(Si) as outlined in MIL-STD-883 Test Method 1019.7. ATE characterization testing at each down-point showed no rejects to the datasheet limits after irradiation. All parameters showed excellent stability.

**Table 3. ISL71030M Response of Key Parameters vs TID**

Parameter	Condition	Bias	Pre-Rad Value	10krad(Si)	20krad(Si)	30krad(Si)	50krad(Si)	Units
Switch ON-Resistance	Min	Avg (Biased)	48.99	48.98	48.87	48.84	49.84	Ω
		Avg (Unbiased)	48.60	48.62	48.61	48.55	50.26	Ω
	Max	Avg (Biased)	68.36	68.26	68.18	67.95	68.30	Ω
		Avg (Unbiased)	68.01	67.91	67.83	67.69	69.26	Ω
	-	Limit -	-	-	-	-	-	Ω
		Limit +	120	120	120	120	120	Ω
Switch ON-Resistance Match Between Channels	-	Avg (Biased)	1.01	1.06	1.14	1.08	1.35	Ω
		Avg (Unbiased)	1.02	1.04	1.04	1.07	1.51	Ω
		Limit -	-	-	-	-	-	Ω
		Limit +	5	5	5	5	5	Ω
Switch ON-Resistance Flatness	-	Avg (Biased)	19.38	19.28	19.31	19.10	18.47	Ω
		Avg (Unbiased)	19.41	19.29	19.22	19.15	19.00	Ω
		Limit -	-	-	-	-	-	Ω
		Limit +	40	40	40	40	40	Ω
Switch Input Off Leakage	-	Avg (Biased)	-0.004	-0.111	-0.039	0.006	-0.004	nA
		Avg (Unbiased)	-0.002	-0.098	-0.044	0.011	-0.084	nA
		Limit -	-30	-30	-30	-30	-30	nA
		Limit +	30	30	30	30	30	nA
Switch Input Off Overvoltage Leakage	-	Avg (Biased)	0.00	-0.11	-0.04	0.01	0.00	nA
		Avg (Unbiased)	0.00	-0.10	-0.04	0.01	-0.08	nA
		Limit -	-30	-30	-30	-30	-30	nA
		Limit +	30	30	30	30	30	nA
Switch Input Off Leakage with Supply Voltage Grounded	-	Avg (Biased)	0.08	0.10	0.10	0.22	0.12	nA
		Avg (Unbiased)	0.07	0.12	0.20	0.27	0.17	nA
		Limit -	-20	-20	-20	-20	-20	nA
		Limit +	20	20	20	20	20	nA
Switch Input Off Leakage with Supply Voltage Open	-	Avg (Biased)	0.27	0.17	0.30	0.25	0.15	nA
		Avg (Unbiased)	0.27	0.35	0.44	0.37	0.16	nA
		Limit -	-20	-20	-20	-20	-20	nA
		Limit +	20	20	20	20	20	nA



Table 3. ISL71030M Response of Key Parameters vs TID (Cont.)

Parameter	Condition	Bias	Pre-Rad Value	10krad(Si)	20krad(Si)	30krad(Si)	50krad(Si)	Units
Switch On Input Leakage with Overvoltage Applied to the Input	-	Avg (Biased)	4.12	4.12	4.11	4.10	3.97	μA
		Avg (Unbiased)	4.11	4.12	4.11	4.10	3.99	μA
		Limit -	2.75	2.75	2.75	2.75	2.75	μA
		Limit +	5.50	5.50	5.50	5.50	5.50	μA
Switch Output OFF Leakage	-	Avg (Biased)	0.08	0.03	0.16	0.07	-0.04	nA
		Avg (Unbiased)	0.07	0.03	0.16	0.06	-0.04	nA
		Limit -	-30	-30	-30	-30	-30	nA
		Limit +	30	30	30	30	30	nA
Switch Output Leakage with Switch Enabled	-	Avg (Biased)	0.32	0.28	0.33	0.31	0.22	nA
		Avg (Unbiased)	0.32	0.29	0.32	0.30	0.22	nA
		Limit -	-30	-30	-30	-30	-30	nA
		Limit +	30	30	30	30	30	nA
Logic Input LOW Voltage	-	Avg (Biased)	1.49	1.49	1.49	1.49	1.46	V
		Avg (Unbiased)	1.49	1.49	1.48	1.48	1.46	V
		Limit -	1.3	1.3	1.3	1.3	1.3	V
		Limit +	1.6	1.6	1.6	1.6	1.6	V
Logic Input HIGH Voltage	-	Avg (Biased)	1.52	1.51	1.51	1.51	1.47	V
		Avg (Unbiased)	1.51	1.51	1.51	1.51	1.47	V
		Limit -	1.3	1.3	1.3	1.3	1.3	V
		Limit +	1.6	1.6	1.6	1.6	1.6	V
Logic Input LOW Current	ADDR	Avg (Biased)	0.0012	0.0017	-0.0008	-0.0006	0.0015	μA
		Avg (Unbiased)	0.0010	0.0016	-0.0009	-0.0008	0.0012	μA
	EN	Avg (Biased)	0.0017	0.0015	0.0014	0.0015	0.0002	μA
		Avg (Unbiased)	0.0020	0.0015	0.0012	0.0015	0.0006	μA
	-	Limit -	-	-	-	-	-	μA
		Limit +	0.10	0.10	0.10	0.10	0.10	μA
Logic Input HIGH Current	ADDR	Avg (Biased)	0.01	0.01	0.01	0.01	0.00	μA
		Avg (Unbiased)	0.01	0.01	0.01	0.01	0.00	μA
	EN	Avg (Biased)	0.01	0.01	0.01	0.01	0.00	μA
		Avg (Unbiased)	0.01	0.01	0.01	0.01	0.00	μA
	-	Limit -	-	-	-	-	-	μA
		Limit +	0.10	0.10	0.10	0.10	0.10	μA

Table 3. ISL71030M Response of Key Parameters vs TID (Cont.)

Parameter	Condition	Bias	Pre-Rad Value	10krad(Si)	20krad(Si)	30krad(Si)	50krad(Si)	Units
Quiescent Supply Current	3.6V	Avg (Biased)	0.033	0.041	0.024	0.014	0.014	μA
		Avg (Unbiased)	0.034	0.041	0.023	0.015	0.011	μA
	5.5V	Avg (Biased)	0.037	0.046	0.030	0.021	0.015	μA
		Avg (Unbiased)	0.039	0.046	0.028	0.020	0.014	μA
	-	Limit -	-	-	-	-	-	μA
		Limit +	0.3	0.3	0.3	0.3	0.3	μA
VREF Supply Current	3.6V	Avg (Biased)	0.055	0.052	0.052	0.053	0.071	μA
		Avg (Unbiased)	0.054	0.052	0.052	0.053	0.071	μA
	5.5V	Avg (Biased)	0.058	0.055	0.055	0.055	0.074	μA
		Avg (Unbiased)	0.057	0.055	0.055	0.055	0.074	μA
	-	Limit -	-	-	-	-	-	μA
		Limit +	0.2	0.2	0.2	0.2	0.2	μA
Addressing Transition Time	3.0V	Avg (Biased)	59.88	59.88	59.88	59.75	60.40	ns
		Avg (Unbiased)	59.63	59.75	59.75	59.75	61.20	ns
	4.5V	Avg (Biased)	38.13	38.13	38.13	38.25	38.00	ns
		Avg (Unbiased)	38.00	38.00	38.00	38.00	38.00	ns
	-	Limit -	10	10	10	10	10	ns
		3.0V Limit +	100	100	100	100	100	ns
4.5V Limit +		70	70	70	70	70	ns	
Break-Before-Make Delay	3.0V	Avg (Biased)	32.13	32.13	32.38	32.88	34.00	ns
		Avg (Unbiased)	32.63	32.75	32.63	32.63	33.60	ns
	4.5V	Avg (Biased)	22.00	22.13	22.13	22.25	24.00	ns
		Avg (Unbiased)	22.13	22.13	22.13	22.13	23.20	ns
	-	Limit -	5	5	5	5	5	ns
		3.0V Limit +	50	50	50	50	50	ns
4.5V Limit +		40	40	40	40	40	ns	
Enable Turn-On Time	3.0V	Avg (Biased)	33.13	33.38	33.63	33.38	33.20	ns
		Avg (Unbiased)	32.63	32.63	32.75	32.63	32.80	ns
	4.5V	Avg (Biased)	24.00	24.00	24.00	24.00	24.00	ns
		Avg (Unbiased)	24.00	24.00	24.00	24.00	24.00	ns
	-	Limit -	-	-	-	-	-	ns
		3.0V Limit +	50	50	50	50	50	ns
4.5V Limit +		40	40	40	40	40	ns	

Table 3. ISL71030M Response of Key Parameters vs TID (Cont.)

Parameter	Condition	Bias	Pre-Rad Value	10krad(Si)	20krad(Si)	30krad(Si)	50krad(Si)	Units
Enable Turn-Off Time	3.0V	Avg (Biased)	37.75	37.63	37.38	36.63	36.00	ns
		Avg (Unbiased)	37.50	37.50	37.13	37.13	36.00	ns
	4.5V	Avg (Biased)	29.75	29.75	29.63	29.00	28.40	ns
		Avg (Unbiased)	29.50	29.50	29.25	29.00	29.60	ns
	-	Limit -	-	-	-	-	-	ns
		3.0V Limit +	50	50	50	50	50	ns
		4.5V Limit +	40	40	40	40	40	ns

## 5.2 Single-Event Effects Testing

The intense heavy ion environment encountered in space applications can cause a variety of Single-Event Effects (SEE). SEE can lead to system-level performance issues including disruption, degradation, and destruction. For predictable and reliable space system operation, individual electronic components should be characterized to determine their SEE response. The following is a summary of the ISL71030M SEE testing.

### 5.2.1 SEE Test Facility

Testing was performed at the Texas A&M University (TAMU) Cyclotron Institute heavy ion facility on April 3, 2019. The overall test setup includes the test jig containing four evaluation boards mounted and wired through a 20ft cable to the data room. The end of the 20ft cable in the data room was connected to a switchboard. The switchboard was wired to the power supplies and monitoring equipment/scopes.

### 5.2.2 SEE Test Setups

Testing the ISL71030M parts for damaging SEE (Single Event Burnout (SEB) and Single Event Latch-Up (SEL)) had the parts configured to select input 13 by applying the test voltage, VTEST, to address lines A2 and A3 and GND to A0, A1, and EN-bar. This connected IN-13 to the output. The output was loaded with a 10kΩ resistor to GND, and the input (IN-13) had a 10kΩ resistor to the test voltage, VTEST. This created a resistor divider that put the output, OUT, at half of VTEST. The test voltage, VTEST, was also applied to the supply, V+, and to the inputs 9 to 16, excluding 13. The inputs 1 to 8 had GND applied to them. The parts tested for damaging SEE were heated with a thin-film heater on the back of the PCB to attain a case temperature of 125°C.

Single Event Transients (SET) were tested with VTEST at 3.00V and 5.50V, the extremes of the suggested operating range. For SET the parts were not heated and therefore were at the ambient of about 25°C. The definition of a SET was a  $\pm 20\text{mV}$  movement of OUT from its nominal value of half VTEST. As with the SEB testing, the part was configured to select input 13. However, unlike the SEB testing, the addressing was done with applied voltages of 70% VREF on A2 and A3, and 30% VREF applied to A0, A1, and EN-bar. This was done to place the addressing at low noise margin states as VREF was set to 3.00V. OUT had a 10kΩ resistor to GND and IN 13 was supplied with VTEST through a 10kΩ resistor to again set OUT to half of VTEST.

### 5.2.3 Single Event Burnout and Latch-Up (SEB/L) Results

The test voltage, VTEST, was sequentially set to 6.50V, 6.75V, and 7.00V for three independent irradiations on four parts. Before and after each irradiation the total current to V+ and VREF was measured along with the output voltage, OUT. No deviations greater than 3% were registered for the currents, and no deviation of even 1% was seen on OUT. The conclusion was that no permanent damage resulted from the irradiations as done.

### 5.2.4 SET Results

No SET were captured with the  $\pm 20\text{mV}$  criterion in the most recent testing. This result is inconsistent with previous testing on a similar part. In the earlier testing, the  $\pm 20\text{mV}$  SET corresponded to cross sections of  $419\mu\text{m}^2$  at VTEST = 3.0V and  $2020\mu\text{m}^2$  at VTEST = 5.5V. However, the nature of the SET captures was that a spike

transient triggered the capture at  $\pm 20\text{mV}$  but the low frequency motion on the OUT node without the spike was less than  $\pm 20\text{mV}$ . Examples are presented below from the previous testing. Thus, the captures previously were dependent on the high-frequency coupling. A slight change in this could have dropped the SET below the trigger point for the newer testing. Because there are no SET to examine for the newer testing, this is all supposition. However, the older testing still represents a worst case estimate of the ISL71030M SET behavior. The previous testing did provide evidence that the  $\pm 20\text{mV}$  SET vanished at an LET of  $20\text{MeV}\cdot\text{cm}^2/\text{mg}$ . This should also apply to the ISL71030M.

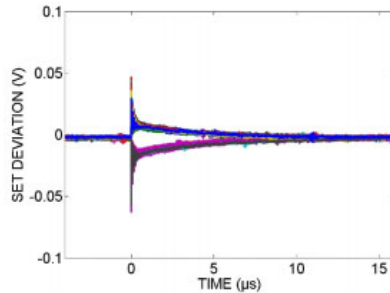

Figure 40. Composite Plot of 20 Largest and Longest SET for Both Positive and Negative Deviations Seen on Previous Testing, DUT 1-4 at LET =  $43\text{MeV}\cdot\text{cm}^2/\text{mg}$  and  $V+ = 5.5\text{V}$ .

### 5.2.5 Conclusion

The ISL71030M 5V MUX is immune to damaging SEE when operated at  $125^\circ\text{C}$  and  $V+$  voltages up to 7V while being irradiated with normal incidence silver for a surface LET of  $43\text{MeV}\cdot\text{cm}^2/\text{mg}$ . The maximum cross section for damaging events under these conditions is  $2.5\mu\text{m}^2$  (zero events on four units to  $1\times 10^7\text{ions}/\text{cm}^2$ ).

SET on the ISL71030M for  $\pm 20\text{mV}$  on OUT fall somewhere between  $2020\mu\text{m}^2$  and zero depending on the testing cited. Those SET that were captured were marginal to the  $\pm 20\text{mV}$  criterion. The  $\pm 20\text{mV}$  SET disappeared completely at  $20\text{MeV}\cdot\text{cm}^2/\text{mg}$ .

## 6. Package Outline Drawing

For the most recent package outline drawing, see [Q32.5X5A](#).

Q32.5X5A

32 Lead Thin Plastic Quad Flatpack Package (TQFP)

Rev 1, 10/11

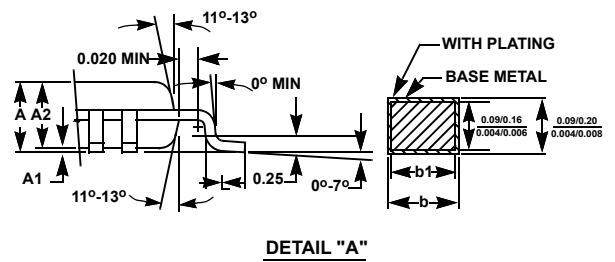
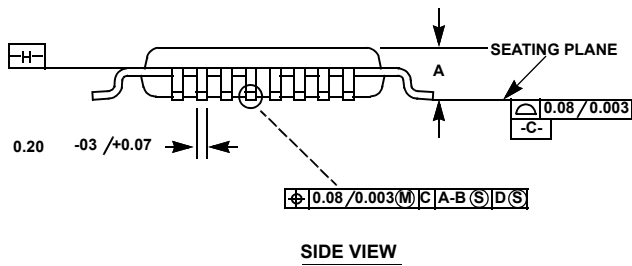
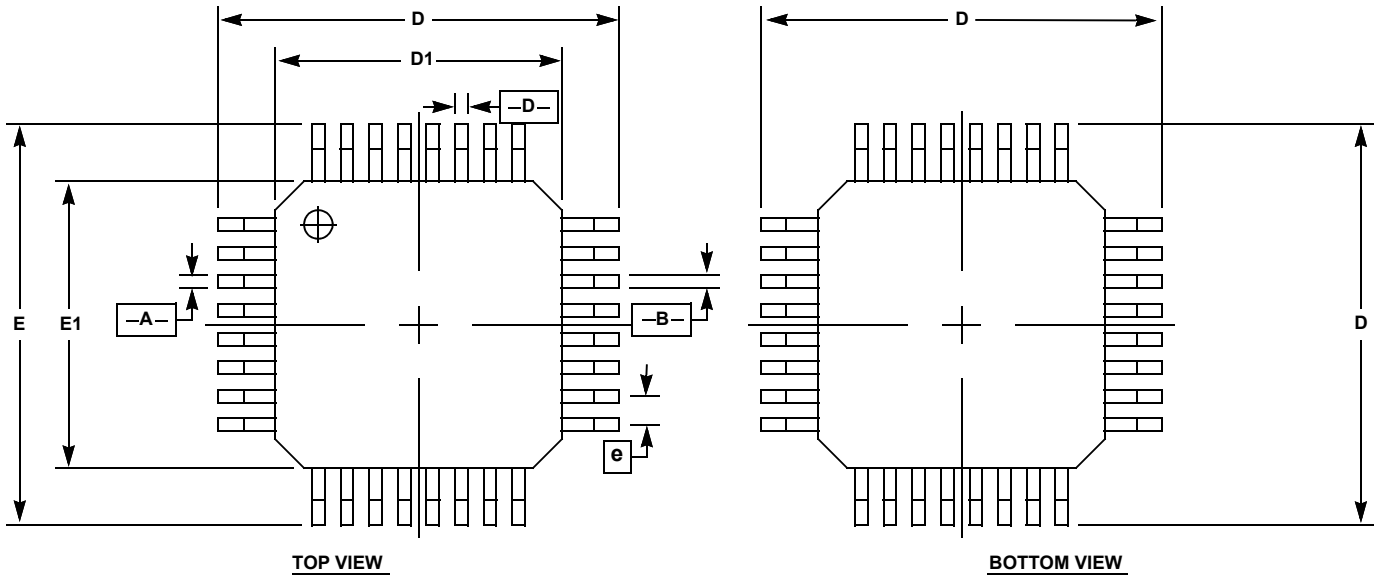

SCALE NONE

SYMBOL	MIN	MAX	NOTES
A	-	1.13	-
A1	0.039	0.089	-
A2	0.95	1.05	-
b	0.17	0.27	6
b1	0.17	-0.23	-
D	7 BSC		-
E	7 BSC		-
D1	5 BSC		-
E1	5 BSC		-
e	0.5 BSC		-
L	0.45	0.75	-
N	32		6

NOTES:

1. Controlling Dimension; Millimeter, converted inch dimensions are not necessarily exact.
2. All dimensioning and tolerancing conform to ANSI Y14.5-1982.
3. Dimensions D and E to be determined at seating plane -C-
4. Dimensions D1 and E1 to be determined at datum plane -H-
5. Dimensions D1 and E1 do not include mold protusion. Allowable protusion is 0.25mm (0.010 inch) per side.
6. Dimension b does not include dambar protusion. Allowable dambar protusion shall not cause the lead width to exceed the maximum b dimensions by more than 0.08mm (0.0003 inch).
7. "N" is the number of terminal position.

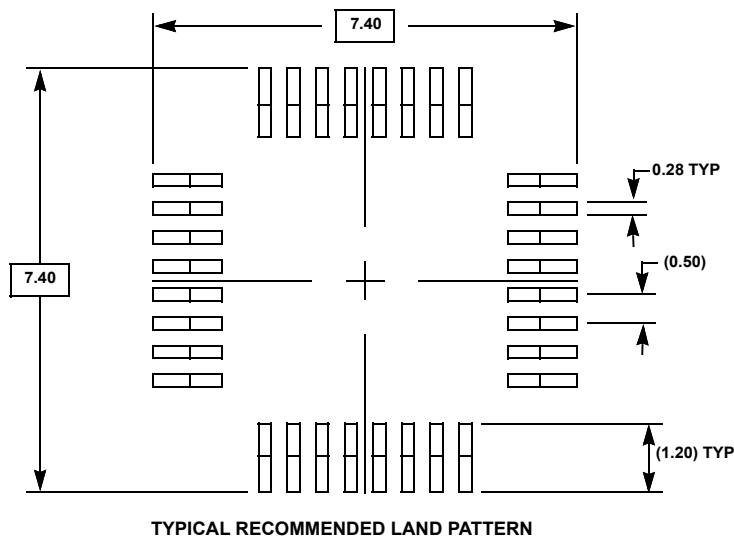

## 7. Ordering Information

Part Number <sup>[1][2]</sup>	Part Marking	Radiation Lot Assurance Testing	Package Description <sup>[3]</sup> (RoHS Compliant)	Pkg. Dwg. #	Carrier Type <sup>[4]</sup>	Temp. Range
ISL71030MNZ	ISL71030MNZ	N/A	32 Ld TQFP	Q32.5X5A	Tube	-55 to +125°C
ISL71030MNZ-T					Reel 1k	
ISL71030MNZ-T7A					Reel, 250	
ISL71030M30NZ		30krad(Si)			Tube	
ISL71030M30NZ-T					Reel 1k	
ISL71030M30NZ-T7A					Reel, 250	
ISL71030M50NZ		50krad(Si)			Tube	
ISL71030M50NZ-T					Reel 1k	
ISL71030M50NZ-T7A					Tube	
					Reel, 250	

1. These Pb-free plastic packaged products employ special Pb-free material sets; molding compounds/die attach materials and NiPdAu plate - e4 termination finish, which is RoHS compliant and compatible with both SnPb and Pb-free soldering operations. Pb-free products are MSL classified at Pb-free peak reflow temperatures that meet or exceed the Pb-free requirements of IPC/JEDEC J-STD-020.
2. For Moisture Sensitivity Level (MSL), see the [ISL71030M](#) device page. For more information about MSL, see [TB363](#).
3. For the Pb-Free Reflow Profile, see [TB493](#).
4. See [TB347](#) for details about reel specifications.

## 8. Revision History

Rev.	Date	Description
1.02	Feb 25, 2025	Updated to the latest template. Updated Features bullets. Added Outgas Testing section. Added ISL71026M30RTZ and ISL71026M50RTZ part information throughout document. Corrected part marking.
1.01	Apr 12, 2021	Added two features bullets: <ul style="list-style-type: none"> <li>• Passes NASA low outgassing specifications</li> <li>• NiPdAu lead finish (Pb-free, Sn-free)</li> </ul>
1.00	Jul 10, 2019	Initial Release

## IMPORTANT NOTICE AND DISCLAIMER

RENESAS ELECTRONICS CORPORATION AND ITS SUBSIDIARIES (“RENESAS”) PROVIDES TECHNICAL SPECIFICATIONS AND RELIABILITY DATA (INCLUDING DATASHEETS), DESIGN RESOURCES (INCLUDING REFERENCE DESIGNS), APPLICATION OR OTHER DESIGN ADVICE, WEB TOOLS, SAFETY INFORMATION, AND OTHER RESOURCES “AS IS” AND WITH ALL FAULTS, AND DISCLAIMS ALL WARRANTIES, EXPRESS OR IMPLIED, INCLUDING, WITHOUT LIMITATION, ANY IMPLIED WARRANTIES OF MERCHANTABILITY, FITNESS FOR A PARTICULAR PURPOSE, OR NON-INFRINGEMENT OF THIRD-PARTY INTELLECTUAL PROPERTY RIGHTS.

These resources are intended for developers who are designing with Renesas products. You are solely responsible for (1) selecting the appropriate products for your application, (2) designing, validating, and testing your application, and (3) ensuring your application meets applicable standards, and any other safety, security, or other requirements. These resources are subject to change without notice. Renesas grants you permission to use these resources only to develop an application that uses Renesas products. Other reproduction or use of these resources is strictly prohibited. No license is granted to any other Renesas intellectual property or to any third-party intellectual property. Renesas disclaims responsibility for, and you will fully indemnify Renesas and its representatives against, any claims, damages, costs, losses, or liabilities arising from your use of these resources. Renesas' products are provided only subject to Renesas' Terms and Conditions of Sale or other applicable terms agreed to in writing. No use of any Renesas resources expands or otherwise alters any applicable warranties or warranty disclaimers for these products.

(Disclaimer Rev.1.01)

### Corporate Headquarters

TOYOSU FORESIA, 3-2-24 Toyosu,  
Koto-ku, Tokyo 135-0061, Japan  
[www.renesas.com](http://www.renesas.com)

### Trademarks

Renesas and the Renesas logo are trademarks of Renesas Electronics Corporation. All trademarks and registered trademarks are the property of their respective owners.

### Contact Information

For further information on a product, technology, the most up-to-date version of a document, or your nearest sales office, please visit [www.renesas.com/contact-us/](http://www.renesas.com/contact-us/).