

To our customers,

Old Company Name in Catalogs and Other Documents

On April 1st, 2010, NEC Electronics Corporation merged with Renesas Technology Corporation, and Renesas Electronics Corporation took over all the business of both companies. Therefore, although the old company name remains in this document, it is a valid Renesas Electronics document. We appreciate your understanding.

Renesas Electronics website: <http://www.renesas.com>

April 1st, 2010
Renesas Electronics Corporation

Issued by: Renesas Electronics Corporation (<http://www.renesas.com>)

Send any inquiries to <http://www.renesas.com/inquiry>.

Notice

1. All information included in this document is current as of the date this document is issued. Such information, however, is subject to change without any prior notice. Before purchasing or using any Renesas Electronics products listed herein, please confirm the latest product information with a Renesas Electronics sales office. Also, please pay regular and careful attention to additional and different information to be disclosed by Renesas Electronics such as that disclosed through our website.
2. Renesas Electronics does not assume any liability for infringement of patents, copyrights, or other intellectual property rights of third parties by or arising from the use of Renesas Electronics products or technical information described in this document. No license, express, implied or otherwise, is granted hereby under any patents, copyrights or other intellectual property rights of Renesas Electronics or others.
3. You should not alter, modify, copy, or otherwise misappropriate any Renesas Electronics product, whether in whole or in part.
4. Descriptions of circuits, software and other related information in this document are provided only to illustrate the operation of semiconductor products and application examples. You are fully responsible for the incorporation of these circuits, software, and information in the design of your equipment. Renesas Electronics assumes no responsibility for any losses incurred by you or third parties arising from the use of these circuits, software, or information.
5. When exporting the products or technology described in this document, you should comply with the applicable export control laws and regulations and follow the procedures required by such laws and regulations. You should not use Renesas Electronics products or the technology described in this document for any purpose relating to military applications or use by the military, including but not limited to the development of weapons of mass destruction. Renesas Electronics products and technology may not be used for or incorporated into any products or systems whose manufacture, use, or sale is prohibited under any applicable domestic or foreign laws or regulations.
6. Renesas Electronics has used reasonable care in preparing the information included in this document, but Renesas Electronics does not warrant that such information is error free. Renesas Electronics assumes no liability whatsoever for any damages incurred by you resulting from errors in or omissions from the information included herein.
7. Renesas Electronics products are classified according to the following three quality grades: “Standard”, “High Quality”, and “Specific”. The recommended applications for each Renesas Electronics product depends on the product’s quality grade, as indicated below. You must check the quality grade of each Renesas Electronics product before using it in a particular application. You may not use any Renesas Electronics product for any application categorized as “Specific” without the prior written consent of Renesas Electronics. Further, you may not use any Renesas Electronics product for any application for which it is not intended without the prior written consent of Renesas Electronics. Renesas Electronics shall not be in any way liable for any damages or losses incurred by you or third parties arising from the use of any Renesas Electronics product for an application categorized as “Specific” or for which the product is not intended where you have failed to obtain the prior written consent of Renesas Electronics. The quality grade of each Renesas Electronics product is “Standard” unless otherwise expressly specified in a Renesas Electronics data sheets or data books, etc.
 - “Standard”: Computers; office equipment; communications equipment; test and measurement equipment; audio and visual equipment; home electronic appliances; machine tools; personal electronic equipment; and industrial robots.
 - “High Quality”: Transportation equipment (automobiles, trains, ships, etc.); traffic control systems; anti-disaster systems; anti-crime systems; safety equipment; and medical equipment not specifically designed for life support.
 - “Specific”: Aircraft; aerospace equipment; submersible repeaters; nuclear reactor control systems; medical equipment or systems for life support (e.g. artificial life support devices or systems), surgical implantations, or healthcare intervention (e.g. excision, etc.), and any other applications or purposes that pose a direct threat to human life.
8. You should use the Renesas Electronics products described in this document within the range specified by Renesas Electronics, especially with respect to the maximum rating, operating supply voltage range, movement power voltage range, heat radiation characteristics, installation and other product characteristics. Renesas Electronics shall have no liability for malfunctions or damages arising out of the use of Renesas Electronics products beyond such specified ranges.
9. Although Renesas Electronics endeavors to improve the quality and reliability of its products, semiconductor products have specific characteristics such as the occurrence of failure at a certain rate and malfunctions under certain use conditions. Further, Renesas Electronics products are not subject to radiation resistance design. Please be sure to implement safety measures to guard them against the possibility of physical injury, and injury or damage caused by fire in the event of the failure of a Renesas Electronics product, such as safety design for hardware and software including but not limited to redundancy, fire control and malfunction prevention, appropriate treatment for aging degradation or any other appropriate measures. Because the evaluation of microcomputer software alone is very difficult, please evaluate the safety of the final products or system manufactured by you.
10. Please contact a Renesas Electronics sales office for details as to environmental matters such as the environmental compatibility of each Renesas Electronics product. Please use Renesas Electronics products in compliance with all applicable laws and regulations that regulate the inclusion or use of controlled substances, including without limitation, the EU RoHS Directive. Renesas Electronics assumes no liability for damages or losses occurring as a result of your noncompliance with applicable laws and regulations.
11. This document may not be reproduced or duplicated, in any form, in whole or in part, without prior written consent of Renesas Electronics.
12. Please contact a Renesas Electronics sales office if you have any questions regarding the information contained in this document or Renesas Electronics products, or if you have any other inquiries.

(Note 1) “Renesas Electronics” as used in this document means Renesas Electronics Corporation and also includes its majority-owned subsidiaries.

(Note 2) “Renesas Electronics product(s)” means any product developed or manufactured by or for Renesas Electronics.



User's Manual

SM850 Ver. 2.50

System Simulator

Operation

Target Device
V850 Series™

Document No. U16218EJ1V0UM00 (1st edition)
Date Published October 2002 CP(K)

© NEC Corporation 2002

Printed in Japan

[MEMO]

V850 Series, V852, V853, V850/SA1, V850/SB1, V850/SB2, V850/SC1, V850/SC2, V850/SC3, V850/SF1, V850/SV1, V850E/MS1, V850E/MS2, V850E/MA1, V850E/MA2, V850E/IA1, and V850E/IA2 are trademarks of NEC Corporation.

Pentium is a trademark of Intel Corporation.

Windows and WindowsNT are either a registered trademark or a trademark of Microsoft Corporation in the United States and/or other countries.

PC/AT is a trademark of International Business Machines Corporation.

The export of these products from Japan is regulated by the Japanese government. The export of some or all of these products may be prohibited without governmental license. To export or re-export some or all of these products from a country other than Japan may also be prohibited without a license from that country. Please call an NEC sales representative.

• The information in this document is current as of October, 2002. The information is subject to change without notice. For actual design-in, refer to the latest publications of NEC's data sheets or data books, etc., for the most up-to-date specifications of NEC semiconductor products. Not all products and/or types are available in every country. Please check with an NEC sales representative for availability and additional information.

- No part of this document may be copied or reproduced in any form or by any means without prior written consent of NEC. NEC assumes no responsibility for any errors that may appear in this document.
- NEC does not assume any liability for infringement of patents, copyrights or other intellectual property rights of third parties by or arising from the use of NEC semiconductor products listed in this document or any other liability arising from the use of such products. No license, express, implied or otherwise, is granted under any patents, copyrights or other intellectual property rights of NEC or others.
- Descriptions of circuits, software and other related information in this document are provided for illustrative purposes in semiconductor product operation and application examples. The incorporation of these circuits, software and information in the design of customer's equipment shall be done under the full responsibility of customer. NEC assumes no responsibility for any losses incurred by customers or third parties arising from the use of these circuits, software and information.
- While NEC endeavours to enhance the quality, reliability and safety of NEC semiconductor products, customers agree and acknowledge that the possibility of defects thereof cannot be eliminated entirely. To minimize risks of damage to property or injury (including death) to persons arising from defects in NEC semiconductor products, customers must incorporate sufficient safety measures in their design, such as redundancy, fire-containment, and anti-failure features.
- NEC semiconductor products are classified into the following three quality grades:
"Standard", "Special" and "Specific". The "Specific" quality grade applies only to semiconductor products developed based on a customer-designated "quality assurance program" for a specific application. The recommended applications of a semiconductor product depend on its quality grade, as indicated below. Customers must check the quality grade of each semiconductor product before using it in a particular application.

"Standard": Computers, office equipment, communications equipment, test and measurement equipment, audio and visual equipment, home electronic appliances, machine tools, personal electronic equipment and industrial robots

"Special": Transportation equipment (automobiles, trains, ships, etc.), traffic control systems, anti-disaster systems, anti-crime systems, safety equipment and medical equipment (not specifically designed for life support)

"Specific": Aircraft, aerospace equipment, submersible repeaters, nuclear reactor control systems, life support systems and medical equipment for life support, etc.

The quality grade of NEC semiconductor products is "Standard" unless otherwise expressly specified in NEC's data sheets or data books, etc. If customers wish to use NEC semiconductor products in applications not intended by NEC, they must contact an NEC sales representative in advance to determine NEC's willingness to support a given application.

(Note)

(1) "NEC" as used in this statement means NEC Corporation and also includes its majority-owned subsidiaries.

(2) "NEC semiconductor products" means any semiconductor product developed or manufactured by or for NEC (as defined above).

M8E 00.4

Regional Information

Some information contained in this document may vary from country to country. Before using any NEC product in your application, please contact the NEC office in your country to obtain a list of authorized representatives and distributors. They will verify:

- Device availability
- Ordering information
- Product release schedule
- Availability of related technical literature
- Development environment specifications (for example, specifications for third-party tools and components, host computers, power plugs, AC supply voltages, and so forth)
- Network requirements

In addition, trademarks, registered trademarks, export restrictions, and other legal issues may also vary from country to country.

NEC Electronics Inc. (U.S.)

Santa Clara, California
Tel: 408-588-6000
800-366-9782
Fax: 408-588-6130
800-729-9288

NEC do Brasil S.A.

Electron Devices Division
Guarulhos-SP, Brasil
Tel: 11-6462-6810
Fax: 11-6462-6829

NEC Electronics (Europe) GmbH

Duesseldorf, Germany
Tel: 0211-65 03 01
Fax: 0211-65 03 327

• Sucursal en España

Madrid, Spain
Tel: 091-504 27 87
Fax: 091-504 28 60

• Succursale Française

Vélizy-Villacoublay, France
Tel: 01-30-67 58 00
Fax: 01-30-67 58 99

• Filiale Italiana

Milano, Italy
Tel: 02-66 75 41
Fax: 02-66 75 42 99

• Branch The Netherlands

Eindhoven, The Netherlands
Tel: 040-244 58 45
Fax: 040-244 45 80

• Branch Sweden

Taeby, Sweden
Tel: 08-63 80 820
Fax: 08-63 80 388

• United Kingdom Branch

Milton Keynes, UK
Tel: 01908-691-133
Fax: 01908-670-290

NEC Electronics Hong Kong Ltd.

Hong Kong
Tel: 2886-9318
Fax: 2886-9022/9044

NEC Electronics Hong Kong Ltd.

Seoul Branch
Seoul, Korea
Tel: 02-528-0303
Fax: 02-528-4411

NEC Electronics Shanghai, Ltd.

Shanghai, P.R. China
Tel: 021-6841-1138
Fax: 021-6841-1137

NEC Electronics Taiwan Ltd.

Taipei, Taiwan
Tel: 02-2719-2377
Fax: 02-2719-5951

NEC Electronics Singapore Pte. Ltd.

Novena Square, Singapore
Tel: 253-8311
Fax: 250-3583

[MEMO]

PREFACE

Target Readers	This manual is intended for user engineers who design and develop application systems of the V850 Series.												
Purpose	This manual is intended for users to understand the functions of the SM850 in the organization below.												
Organization	<p>This manual consists of the following chapters:</p> <ul style="list-style-type: none">• OVERVIEW• INSTALLATION• STARTING AND TERMINATING• ASSOCIATION WITH PM plus• FUNCTIONS OF ID850• OPERATION• WINDOW REFERENCE• COMMAND REFERENCE												
How to Use This Manual	<p>It is assumed that the readers of this manual have general knowledge of electrical engineering, logic circuits, microcontrollers, C language, and assemblers.</p> <p>To understand the functions of the V850 Series → Refer to Hardware User's Manual for each product..</p> <p>To understand the instruction functions of the V850 Series → Refer to V850 Series Architecture User's Manual or V850E/MS1™ Architecture User's Manual.</p>												
Conventions	<table><tr><td>Data significance:</td><td>Higher digits on the left and lower digits on the right</td></tr><tr><td>Note:</td><td>Footnote for item marked with Note in the text</td></tr><tr><td>Caution:</td><td>Information requiring particular attention</td></tr><tr><td>Remark:</td><td>Supplementary information</td></tr><tr><td>Numerical representation:</td><td>Binary ... XXXX or XXXXB Decimal ... XXXX Hexadecimal ... 0XXXXX</td></tr><tr><td>Prefix indicating the power of 2 (address space, memory capacity):</td><td>K (Kilo): $2^{10} = 1024$ M (Mega): $2^{20} = 1024^2$</td></tr></table>	Data significance:	Higher digits on the left and lower digits on the right	Note:	Footnote for item marked with Note in the text	Caution:	Information requiring particular attention	Remark:	Supplementary information	Numerical representation:	Binary ... XXXX or XXXXB Decimal ... XXXX Hexadecimal ... 0XXXXX	Prefix indicating the power of 2 (address space, memory capacity):	K (Kilo): $2^{10} = 1024$ M (Mega): $2^{20} = 1024^2$
Data significance:	Higher digits on the left and lower digits on the right												
Note:	Footnote for item marked with Note in the text												
Caution:	Information requiring particular attention												
Remark:	Supplementary information												
Numerical representation:	Binary ... XXXX or XXXXB Decimal ... XXXX Hexadecimal ... 0XXXXX												
Prefix indicating the power of 2 (address space, memory capacity):	K (Kilo): $2^{10} = 1024$ M (Mega): $2^{20} = 1024^2$												

Related Documents

Refer to the documents listed below when using this manual.

The related documents indicated in this publication may include preliminary versions. However, preliminary versions are not marked as such.

Documents related to development tools (User's Manuals)

Document Name		Document No.
IE-703002-MC (In-circuit emulator for V853™, V850/SA1™, V850/SB1™, V850/SB2™, V850/SC1™, V850/SC2™, V850/SC3™, V850/SF1™, V850/SV1™)		U11595E
IE-V850E-MC (In-circuit emulator for V850E/IA1™, V850E/IA2™), IE-V850E-MC-A (In-circuit emulator for V850E/MA1™, V850E/MA2™)		U14487E
IE-703003-MC-EM1 (In-circuit emulator option board for V853)		U11596E
IE-703017-MC-EM1 (In-circuit emulator option board for V850/SA1)		U12898E
IE-703037-MC-EM1 (In-circuit emulator option board for V850/SB1, V850/SB2)		U14151E
IE-703040-MC-EM1 (In-circuit emulator option board for V850/SV1)		U14337E
IE-703079-MC-EM1 (In-circuit emulator option board for V850/SF1)		U15447E
IE-703102-MC (In-circuit emulator for V850E/MS1, V850E/MS2™)		U13875E
IE-703102-MC-EM1, IE-703102-MC-EM1-A (In-circuit emulator option board for V850E/MS1, V850E/MS2)		U13876E
IE-703107-MC-EM1 (In-circuit emulator option board for V850E/MA1)		U14481E
IE-703116-MC-EM1 (In-circuit emulator option board for V850E/IA1)		U14700E
CA850 Ver. 2.50 C Compiler Package	Operation	U16053E
	C Language	U16054E
	PM plus	U16055E
	Assembly Language	U16042E
ID850 Ver. 2.50 Integrated Debugger	Operation	U16217E
SM850 Ver. 2.50 System Simulator	Operation	This manual
SM850 Ver. 2.00 or Later System Simulator	External Part User Open Interface Specifications	U14873E
RX850 Ver. 3.13 or Later Real-Time OS	Basics	U13430E
	Installation	U13410E
	Technical	U13431E
RX850 Pro Ver. 3.13 Real-Time OS	Fundamental	U13773E
	Installation	U13774E
	Technical	U13772E
RD850 Ver. 3.01 Task Debugger		U13737E
RD850 Pro Ver. 3.01 Task Debugger		U13916E
AZ850 Ver. 3.10 System Performance Analyzer		U14410E
PG-FP3 Flash Memory Programmer		U13502E
PG-FP4 Flash Memory Programmer		U15260E
TW Ver. 1.00 Performance Analysis Tuning Tool		U16104E

CONTENTS

CHAPTER 1 OVERVIEW ... 18

- 1.1 Overview ... 18
- 1.2 Features ... 18
- 1.3 System Configuration ... 20
 - 1.3.1 Example of system configuration ... 20
 - 1.3.2 Internal configuration of SM850 ... 20
- 1.4 Operating Environment ... 20
 - 1.4.1 Hardware environment ... 20
 - 1.4.2 Software environment ... 21
- 1.5 Notes on Source-Level Debugging ... 21

CHAPTER 2 INSTALLATION ... 22

- 2.1 Installing SM850 ... 22
 - 2.1.1 Installing procedure ... 22
- 2.2 Uninstalling SM850 ... 27
 - 2.2.1 Uninstalling procedure ... 27

CHAPTER 3 STARTING AND TERMINATING ... 28

- 3.1 Starting ... 28
- 3.2 Terminating ... 29

CHAPTER 4 ASSOCIATION WITH PM plus ... 31

- 4.1 Setting Build Mode ... 31
- 4.2 Registering Debugger to PM plus Project ... 31
 - 4.2.1 Selecting debugger ... 31
 - 4.2.2 Downloading multiple load module files ... 32
- 4.3 To Start SM850 from PM plus ... 33
 - 4.3.1 Restoring debugging environment ... 33
- 4.4 Auto Load ... 33
 - 4.4.1 Auto load by correcting source code ... 34
 - 4.4.2 Auto load by starting debugger ... 34

CHAPTER 5 FUNCTIONS OF SM850 ... 35

- 5.1 External Parts ... 35
 - 5.1.1 Creating external parts ... 37
 - 5.1.2 I/O operation of external parts and displaying I/O result ... 38
 - 5.1.3 Operation of external parts at CPU reset ... 38
 - 5.1.4 Editing in Parts window ... 39
- 5.2 Data Input Function ... 39
 - 5.2.1 Creating/editing input data ... 39
 - 5.2.2 Downloading input data file ... 41
 - 5.2.3 Processing when input data is not set ... 41
 - 5.2.4 Outputting data to file and displaying data ... 42
- 5.3 Peripheral I/O Event & Action Setting Function ... 43
 - 5.3.1 Setting event and action ... 43
 - 5.3.2 Downloading event condition file ... 44
- 5.4 Debugging functions of SM850 ... 44
- 5.5 Setting Debugging Environment ... 46
- 5.6 Program Execution Function ... 46
 - 5.6.1 Real-time execution function ... 47
 - 5.6.2 Non-real-time execution function ... 47
- 5.7 Event function ... 48
 - 5.7.1 Using event function ... 48
 - 5.7.2 Event condition ... 49

- 5. 7. 3 Event link condition ... 49
- 5. 7. 4 Setting of various event conditions ... 50
- 5. 8 Break function ... 50
- 5. 9 Trace function ... 51
 - 5. 9. 1 Operation of trace ... 51
 - 5. 9. 2 Trace condition setting function ... 52
- 5. 10 Coverage Measurement Function ... 53
- 5. 11 Snapshot Function ... 53
- 5. 12 Stub Function ... 54
- 5. 13 Register Manipulation Function ... 54
- 5. 14 Memory Manipulation Function ... 55
- 5. 15 Watch Function ... 55
- 5. 16 Time Measurement Function ... 55
- 5. 17 Load/Save Function ... 55
 - 5. 17. 1 View files ... 56
 - 5. 17. 2 Information files ... 56
 - 5. 17. 3 Setting files ... 57
- 5. 18 Real-Time RAM Sampling Function ... 57

CHAPTER 6 OPERATION ... 58

- 6. 1 Flow of Debugging Operations ... 58
- 6. 2 Active Status and Static Status ... 61
- 6. 3 Jump Function ... 61
- 6. 4 Trace Result with Linking Window ... 62

CHAPTER 7 WINDOW REFERENCE ... 64

- 7. 1 Window List ... 64
- 7. 2 Explanation of Windows ... 67
 - Window/dialog name ... 68
 - Main window ... 69
 - Configuration dialog box ... 89
 - Extended Option dialog box ... 95
 - Debugger Option dialog box ... 99
 - Font dialog box ... 107
 - Project File Save dialog box ... 109
 - Project File Load dialog box ... 113
 - View File Save dialog box ... 115
 - View File Load dialog box ... 119
 - Download dialog box ... 122
 - Upload dialog box ... 126
 - Load Module List dialog box ... 129
 - Browse dialog box ... 131
 - Address Move dialog box ... 133
 - Source Text Move dialog box ... 135
 - Trace Move dialog box ... 138
 - Symbol To Address dialog box ... 141
 - Source window ... 144
 - Source Search dialog box ... 157
 - Assemble window ... 160
 - Assemble Search dialog box ... 166
 - Memory window ... 169
 - Memory Search dialog box ... 174
 - Memory Fill dialog box ... 177
 - Memory Copy dialog box ... 179
 - Memory Compare dialog box ... 181
 - Memory Compare Result dialog box ... 183
 - DMM dialog box ... 185
 - Watch window ... 187
 - Quick Watch dialog box ... 194

- Add Watch dialog box ... 198
- Change Watch dialog box ... 202
- Local Variable window ... 205
- Stack Trace window ... 208
- Register window ... 212
- Register Select dialog box ... 215
- IOR window ... 217
- IOR Select dialog box ... 222
- Add I/O Port dialog box ... 225
- Trace window ... 228
- Trace Search dialog box ... 237
- Trace Data Select dialog box ... 243
- Coverage window ... 246
- Coverage Search dialog box ... 251
- Coverage-Clear dialog box ... 254
- Coverage-Address dialog box ... 256
- Coverage-Condition Setting dialog box ... 258
- Coverage-Efficiency View dialog box ... 261
- Event Manager ... 263
- Event dialog box ... 271
- Event Link dialog box ... 280
- Break dialog box ... 286
- Trace dialog box ... 290
- Snap Shot dialog box ... 296
- Stub dialog box ... 303
- Timer dialog box ... 307
- Timer Result dialog box ... 313
- Delay Count dialog box ... 315
- Reset Debugger dialog box ... 317
- About dialog box ... 319
- Exit Debugger dialog box ... 321
- Console window ... 323
- V850 Simulator GUI window ... 324
- IOR Event & Action dialog box ... 327
- Input 0/1 Editor window ... 331
- Input timing Chart Editor window ... 337
- Pin Setting dialog box ... 342
- Down Load dialog box ... 345
- Output Setting dialog box ... 347
- Output Timing Chart window ... 350
- Search window ... 354
- Parts window ... 357
- Buttons dialog box ... 368
- Key Matrixes dialog box ... 372
- LEDs dialog box ... 376
- 7seg LEDs dialog box ... 379
- 14seg LEDs dialog box ... 383
- Level Gauges dialog box ... 387
- DC Motors dialog box ... 390
- Buzzers dialog box ... 393
- Internal Interrupt Button dialog box ... 396
- Pull-Up / Pull-Down dialog box ... 399
- Serial GUI window ... 402
- Bitmap Entry dialog box ... 405
- Open dialog box ... 410
- Save As dialog box ... 412
- Speed Option dialog box ... 414

CHAPTER 8 COMMAND REFERENCE ... 416

- 8.1 Command Line Rules ... 416
- 8.2 Command List ... 416
- 8.3 List of Variables ... 419

8. 4	List of Packages ...	419
8. 5	Key Bind ...	419
8. 6	Expansion window ...	419
8. 7	Callback Procedure ...	419
8. 8	Hook Procedure ...	420
8. 9	Related Files ...	422
8. 10	Cautions ...	422
8. 11	Commands ...	423
	Command name ...	423
	address ...	424
	assemble ...	425
	batch ...	426
	breakpoint ...	427
	cache ...	429
	dbgexit ...	431
	download ...	432
	extwin ...	433
	finish ...	434
	go ...	435
	help ...	436
	hook ...	437
	ie ...	438
	jump ...	439
	map ...	440
	mdi ...	442
	memory ...	443
	module ...	445
	next ...	446
	refresh ...	447
	register ...	448
	reset ...	449
	run ...	450
	step ...	451
	stop ...	452
	upload ...	453
	version ...	454
	watch ...	455
	where ...	456
	wish ...	457
	xcoverage ...	458
	xtime ...	459
	xtrace ...	460

APPENDIX A INPUT CONVENTIONS ... 462

A. 1	Character set ...	462
A. 2	Symbols ...	463
A. 3	Numeric Values ...	464
A. 4	Expressions and Operators ...	464

APPENDIX B TERMINOLOGY ... 467

B. 1	Terminology ...	467
------	-----------------	-----

APPENDIX C MESSAGES ... 469

C.1	Error/Warning Messages from Debugger Part ...	469
	C.1.1 Display format of debugger ...	469
	C.1.2 Fatal error messages ...	469
	C.1.3 Syntax error messages ...	474
	C.1.4 Warning message or question message ...	491
C.2	Error/Warning Messages From The Simulator Part ...	494
	C.2.1 Display format of simulator ...	494

- C.2.2 Error messages ... 494
- C.2.3 Warning message ... 508

APPENDIX D KEY FUNCTION LIST ... 511

- D. 1 Function List of Special Function Keys ... 511
- D. 2 Function List of Function Keys ... 512
- D. 3 Function List of Special Function Keys (Shift + key) ... 512
- D. 4 Function List of Function Keys (Shift + key) ... 513
- D. 5 List of Special Function Keys (Ctrl + key) ... 513
- D. 6 Function List of Function Keys (Ctrl + key) ... 513
- D. 7 Function List of Control Keys (Ctrl + key) ... 514
- D. 8 List of Special Function Keys (Ctrl + Shift + key) ... 515

APPENDIX E INDEX ... 516

LIST OF FIGURES

Figure No. Title Page

1-1	Example of SM850 System Configuration ...	20
3-1	Configuration Dialog Box ...	28
3-2	Main Window ...	29
3-3	V850 Simulator GUI Window ...	29
3-4	Exit Debugger Dialog Box ...	29
3-5	Message Box for Confirmation of Stopping Execution ...	30
4-1	Debugger Settings Dialog Box (PM plus) ...	32
5-1	Examples of External Parts of SM850 ...	36
5-2	Parts Window (With Menu Displayed) ...	38
5-3	Input 0/1 Editor Window ...	40
5-4	Input timing Chart Editor Window ...	40
5-5	Down Load Dialog Box ...	41
5-6	V850 Simulator GUI Window (With Message Displayed) ...	42
5-7	Pull-Up / Pull-Down Dialog Box ...	42
5-8	Output Timing Chart Window ...	43
5-9	Peripheral I/O Event & Action Setting Dialog Box ...	44
5-10	Down Load Dialog Box ...	44
5-11	Memory Space Managed by SM850 (With uPD703000) ...	45
5-12	Flow of Stub Function ...	54
7-1	Main Window ...	69
7-2	Toolbar with Only Graphics (default) ...	70
7-3	Toolbar with Graphics and Characters ...	70
7-4	Status Bar ...	87
7-5	Configuration Dialog Box ...	89
7-6	Extended Option Dialog Box ...	95
7-7	Debugger Option Dialog Box ...	99
7-8	Add Source path Dialog Box ...	101
7-9	Font Dialog Box ...	107
7-10	Project File Save Dialog Box ...	109
7-11	Project File Load Dialog Box ...	113
7-12	View File Save Dialog Box ...	115
7-13	View File Load Dialog Box ...	119
7-14	Download Dialog Box ...	122
7-15	The Progress of Download ...	125
7-16	Upload Dialog Box ...	126
7-17	Load Module List Dialog Box ...	129
7-18	Browse Dialog Box ...	131
7-19	Address Move Dialog Box ...	133
7-20	Source Text Move Dialog Box ...	135
7-21	Trace Move Dialog Box ...	138
7-22	Symbol To Address Dialog Box ...	141
7-23	Source Window ...	144
7-24	Source Search Dialog Box ...	157
7-25	Assemble Window ...	160
7-26	Assemble Search Dialog Box ...	166
7-27	Memory Window ...	169
7-28	Memory Search Dialog Box ...	174
7-29	Memory Fill Dialog Box ...	177
7-30	Memory Copy Dialog Box ...	179
7-31	Memory Compare Dialog Box ...	181
7-32	Confirmation Dialog Box ...	182
7-33	Memory Compare Result Dialog Box ...	183
7-34	DMM Dialog Box ...	185
7-35	Watch Window ...	187
7-36	Quick Watch Dialog Box ...	194
7-37	Add Watch Dialog Box ...	198
7-38	Change Watch Dialog Box ...	202
7-39	Local Variable Window, ...	205

7-40	Stack Trace Window ... 208
7-41	Register Window ... 212
7-42	Register Select Dialog Box ... 215
7-43	IOR Window ... 217
7-44	IOR Select Dialog Box ... 222
7-45	Add I/O Port Dialog Box ... 225
7-46	Trace Window ... 228
7-47	Trace Search Dialog Box ... 237
7-48	Trace Data Select Dialog Box ... 243
7-49	Coverage Window ... 246
7-50	Coverage Search Dialog Box ... 251
7-51	Coverage-Clear Dialog Box ... 254
7-52	Coverage-Address Dialog Box ... 256
7-53	Coverage-Condition Setting Dialog Box ... 258
7-54	Coverage-Efficiency View Dialog Box ... 261
7-55	Event Manager ... 263
7-56	Event Dialog Box ... 271
7-57	Event Link Dialog Box ... 281
7-58	Break Dialog Box ... 286
7-59	Trace Dialog Box ... 290
7-60	Snap Shot Dialog Box (with Register Selected) ... 296
7-61	Stub Dialog Box ... 303
7-62	Timer Dialog Box ... 307
7-63	Timer Result Dialog Box ... 313
7-64	Delay Count Dialog Box ... 315
7-65	Reset Debugger Dialog Box ... 317
7-66	About Dialog Box ... 319
7-67	Exit Debugger Dialog Box ... 321
7-68	Console window ... 323
7-69	V850 Simulator GUI Window ... 324
7-70	IOR Event & Action Dialog Box ... 327
7-71	Input 0/1 Editor Window ... 331
7-72	Input timing Chart Editor Window ... 337
7-73	Pin Setting Dialog Box ... 342
7-74	Down Load Dialog Box ... 345
7-75	Output Setting Dialog Box ... 347
7-76	Output Timing Chart Window ... 350
7-77	Search Window ... 354
7-78	Parts Window ... 357
7-79	Toolbar (Parts Window) ... 358
7-80	Mouse Position and Coordinates ... 365
7-81	Buttons Dialog Box ... 368
7-82	Key Matrixes Dialog Box ... 372
7-83	LEDs Dialog Box ... 376
7-84	7seg LEDs Dialog Box ... 379
7-85	14seg LEDs Dialog Box ... 383
7-86	Level Gauges Dialog Box ... 387
7-87	DC Motors Dialog Box ... 390
7-88	Buzzers Dialog Box ... 393
7-89	Internal Interrupt Button Dialog Box ... 396
7-90	Pull-Up / Pull-Down Dialog Box ... 399
7-91	Serial GUI Window ... 402
7-92	Bitmap Entry Dialog Box ... 405
7-93	Error Bitmap File ... 408
7-94	Open Dialog Box ... 410
7-95	Save As Dialog Box ... 412
7-96	Speed Option Dialog Box ... 414
C-1	Error/Warning Messages from Debugger Part ... 469
C-2	Simulator Error/Warning Dialog Box ... 494

LIST OF TABLES

Table No. Title Page

5-1	External Parts of SM850 and Setting Dialog Boxes ...	36
5-2	Operation of External Parts at CPU Reset ...	38
5-3	Timing of Wait Value ...	41
5-4	Various Event Conditions ...	49
5-5	Operation of Tracer (During Next Over Execution) ...	52
5-6	List of View Files ...	56
5-7	List of Information Files ...	56
5-8	List of Setting Files ...	57
7-1	SM850 Window List (Debugger) ...	64
7-2	SM850 Window List (Simulator) ...	66
7-3	Break Cause ...	88
7-4	Settable Sizes as Internal ROM/RAM ...	91
7-5	Size of Internal RAM and Start Address ...	91
7-6	Mapping Unit in Configuration Dialog Box ...	93
7-7	Contents Saved to Project File ...	109
7-8	Extension Corresponding to Current Window ...	116
7-9	Type of File That Can Be Loaded on View File Load Dialog Box ...	120
7-10	Type of File That Can Be Downloaded ...	123
7-11	Type of File That Can Be Uploaded ...	127
7-12	Type of File That Can Be Displayed in Browse Dialog Box ...	132
7-13	Frame Number Specification Format ...	139
7-14	Specifying Symbols ...	142
7-15	Details of Setting/Deleting Breakpoint ...	146
7-16	Display Color of Breakpoint and Its Meaning ...	147
7-17	Meaning of Event Display Mark ...	147
7-18	Details of Drag & Drop Function (Line/Address) ...	155
7-19	Details of Drag & Drop Function (Character String) ...	156
7-20	Data Display Format (Watch-Related) ...	190
7-21	Number of Clocks and Time Tag Value ...	230
7-22	Status When Tracer Is Stopped ...	232
7-23	Cursor Position and Jump Pointer ...	233
7-24	Types of Status Conditions ...	238
7-25	List of Access Size Conditions (Trace) ...	239
7-26	Settable Range of Address Condition ...	240
7-27	Settable Range of Data Condition ...	241
7-28	Status List of Coverage Data ...	248
7-29	Maximum Number of Valid Events for Each Event Condition ...	263
7-30	Marks of Event Icon ...	265
7-31	Color of Character on Mark and its Meaning ...	265
7-32	Address Condition and Jump Pointer ...	266
7-33	Separator for Displaying Event Details ...	267
7-34	List of Status Conditions ...	273
7-35	List of Access Size Conditions (Event) ...	274
7-36	Settable Range of Data Condition ...	276
7-37	Various Event Conditions for Which Event Link Condition Can Be Use ...	280
7-38	Number of Events Settable in Break Condition Setting Area ...	287
7-39	Relationship between Registration Number and Bitmap File ...	407
7-40	Simulation Function ...	415
8-1	List of Debugger Control Commands ...	416
8-2	List of Console/Tcl Commands ...	418
8-3	Message ID ...	420
A-1	Usable Character Set ...	462
A-2	List of Special Characters ...	462
A-3	Input Format of Numeric Values ...	464
A-4	List of Operators ...	464
A-5	Operator Priority ...	466
A-6	Range of Radixes ...	466
B-1	Delimiter ...	467

D-1	Function List of Special Function Keys ...	511
D-2	Function List of Function Keys ...	512
D-3	Function List of Special Function Keys (Shift + key) ...	512
D-4	Function List of Function Keys (Shift + key) ...	513
D-5	List of Special Function Keys (Ctrl + key) ...	513
D-6	Function List of Function Keys (Ctrl + key) ...	513
D-7	Function List of Control Keys (Ctrl + key) ...	514
D-8	List of Special Function Keys (Ctrl + Shift + key) ...	515

CHAPTER 1 OVERVIEW

1.1 Overview

The system simulator SM850 for the V850 Series (hereafter referred to as the SM850) is a software tool developed for NEC's V850 Series of 32-bit microcontrollers for embedded control. This software tool is intended to enable efficient debugging/simulation of user programs.

The SM850 implements the functions of an emulator and target system by software.

By preparing the SM850 on the host machine, therefore, data can actually be input to the user program and the output resulting from execution of the user program can be displayed.

As a result, the program can be logically debugged at an early stage, even before the emulator and target system are ready.

The SM850 runs on a host machine that uses Windows as the operating system and employs an easy-to-understand, easy-to-use GUI (Graphical User Interface).

The commands that are often used are displayed as buttons, so that they can be executed with a single mouse click. In this way, an environment with excellent operability can be provided.

1.2 Features

The SM850 has the following features.

(1) Source debugging

A C source program and source program in assembly language can be debugged.

(2) Target-less evaluation

By simulating the operations of the target device, including those of the internal peripheral units and interrupt processing, as well as CPU operations, the logic of the user program can be debugged at an early stage, without an in-circuit emulator.

(3) Support of integrated debugging environment

The operability is similar to that of an in-circuit emulator.

(4) Various simulation functions provided

a) External components

By supplying standard "external components" such as LEDs, key matrixes, and motors that use the GUI, a dummy environment of the target system can be easily configured. Data can be input to or output from the external components during simulation.

b) configuring user system

The user logic block in the target system can be configured (programmed) by the user, by using the user open interface.

c) Data input function

Data with timing information created with two types of input editors can be input during simulation. The output result can be displayed on a timing chart.

d) Peripheral I/O event & action setting function

An interrupt can be generated at any time or data can be set by using an event set to a peripheral I/O register or address.

(5) Supply of simulation operation modes

Simulation operation modes that can be used in accordance with the debugging aim are supplied.

a) Instruction operation mode

This mode is used to simulate only instructions to increase the execution speed. It is effective for debugging the logic of a user program.

b) Peripheral operation mode (can be specified only when the target device is the V851, V852, V853, or V854)

This mode is used to verify the internal/external peripheral operations while accurately simulating pipeline processing. In this mode, I/O data and the external peripherals dependent on the device can be used as components so that the device can be debugged while the peripheral operations are visually verified.

Caution The instruction operation mode has almost the same function as the peripheral operation mode when the V851, V852, V853, or V854 is used as the target device. For details, refer to the document supplied with the product.

(6) Monitor function (automatic display updating function when execution is stopped)

If execution of the user program is stopped, the values of the window displayed on the screen are automatically updated.

(7) Saving/restoring debugging environment

The debugging environment including information on setting of breakpoints and events, downloading files, and display status and position of windows can be saved to a file (project file).

By loading this project file, the debugging environment can be restored.

(8) Function expansion by TIP or ToolLink

By associating with a task debugger (RD) and system performance analyzer (AZ) supporting TIP (Tool Interface Protocol) or ToolLink, the debugging efficiency of the user program using a real-time OS (RX) can be dramatically improved.

(9) Batch execution by command and creation of custom window

A console window that allows batch processing on the command line and creation of the user's own custom window has been added.

1.3 System Configuration

The SM850 executes debugging/simulation by downloading the object file of the target device in the load module format to the target memory of the SM850.

The SM850 consists of a debugger part that has debugging functions and a simulator part that simulates the operations of the target device and target system.

1.3.1 Example of system configuration

Figure 1-1 shows an example of the system configuration of the SM850.

Figure 1-1 Example of SM850 System Configuration

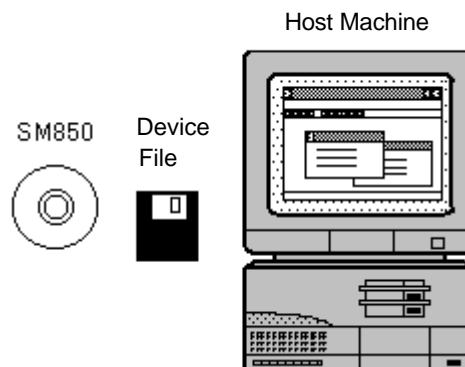

1.3.2 Internal configuration of SM850

The SM850 consists of the following:

- Debugger
- Simulator

When the SM850 is started, the main window of the debugger and the main window of the simulator are automatically opened. (The main window of the simulator is displayed as a button on the Windows task bar).

Each window and dialog box are opened from these main windows.

1.4 Operating Environment

The SM850 has the following hardware and software requirements:

1.4.1 Hardware environment

(1) Host machine (any of the following)

- IBM PC/AT™ -compatible machine

1.4.2 Software environment

(1) Operating system (any of the following)

Windows98, Windows2000, Windows NT4.0 (Service Pack5 or above), Windows Me, Windows XP Home Edition, Windows XP Professional

Caution Regardless of which of the OSs above is used, we recommend that the latest Service Pack is installed.

(2) Device file

The device file of the target device to be used.

1.5 Notes on Source-Level Debugging

To perform source-level debugging, add an option (-g option) to generate debug information when the source file is compiled.

If this option is not added, the source file cannot be debugged at the source level.

CHAPTER 2 INSTALLATION

This chapter explains the procedure of installing and uninstalling SM850.

2.1 Installing SM850

To use the SM850, the SM850 and a device file are necessary. Install the device file with the dedicated installer "DFINST.exe" (supplied with the SM850).

Caution To install the SM850 again after the SM850 has been installed once, be sure to uninstall the SM850. If the SM850 is installed in a directory different from that in which the SM850 has been already installed, without uninstalling the SM850, the SM850 that has already been installed cannot be uninstalled.

To install the SM850, prepare the following:

- SM850 system disk

An example of installing the SM850 is shown below.

In this example, the settings are as follows:

Install directory	C:\NECTools32
CD-ROM drive	Drive Q
Directory to which Windows is installed	C:\WINDOWS

2.1.1 Installing procedure

- 1 Start Windows.
- 2 Insert the SM850 system disk to the CD-ROM drive.
- 3 Start Explorer and double-click "Setup.exe" in the drive Q.

- 4 After setup initialization, the setup program is started. Click the <Next> button.

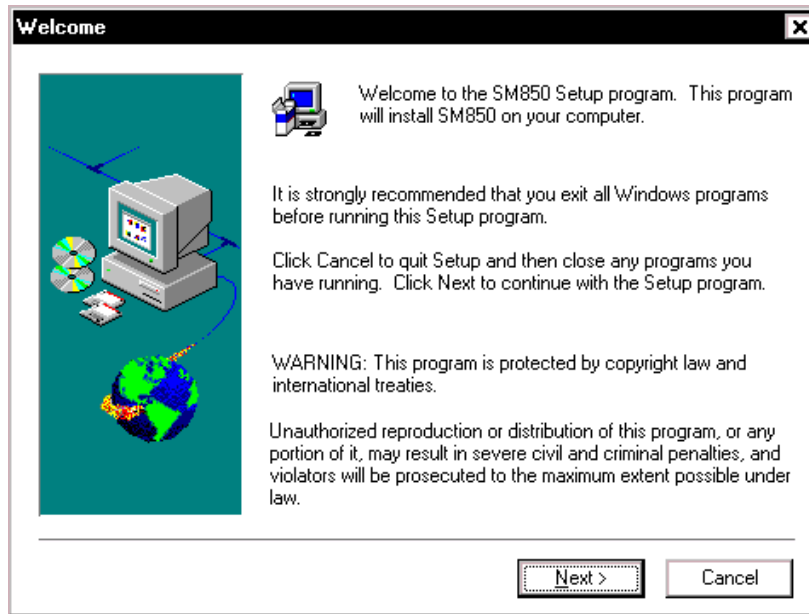

- 5 At this time, your agreement with the Software License Agreement is necessary. Click the <Yes> button. To stop installation, click the <No> button.

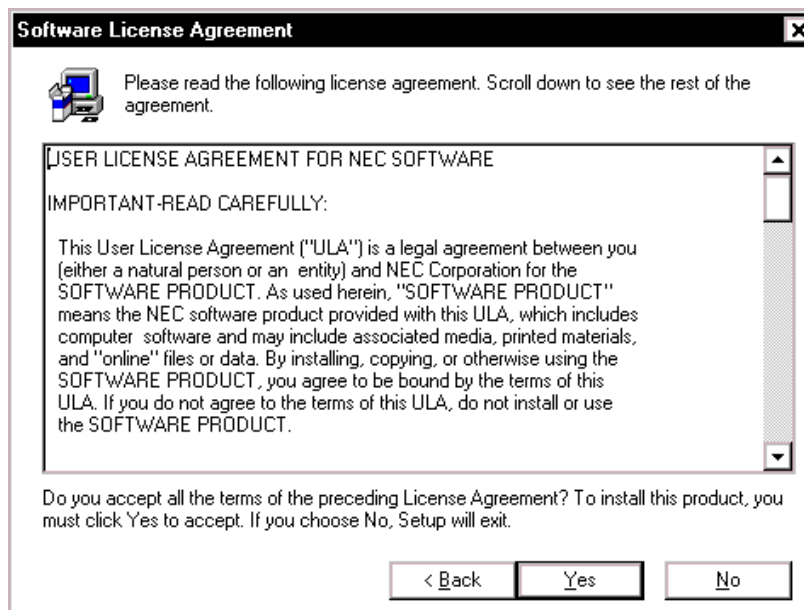

- 6 Input the product ID. The product ID of the SP product may be input. Click the <Next> button.



- 7 Select items to be installed, and the drive and directory in which the SM850 is to be installed. The default drive and directory is "C:\NECTools32".
To change the drive and directory, click the <Browse...> button. After each item has been set, click the <Next> button. To stop installation, click the <No> button.

Caution If the SM850 previously installed is not uninstalled, a confirmation dialog box inquiring if the SM850 is uninstalled is displayed.

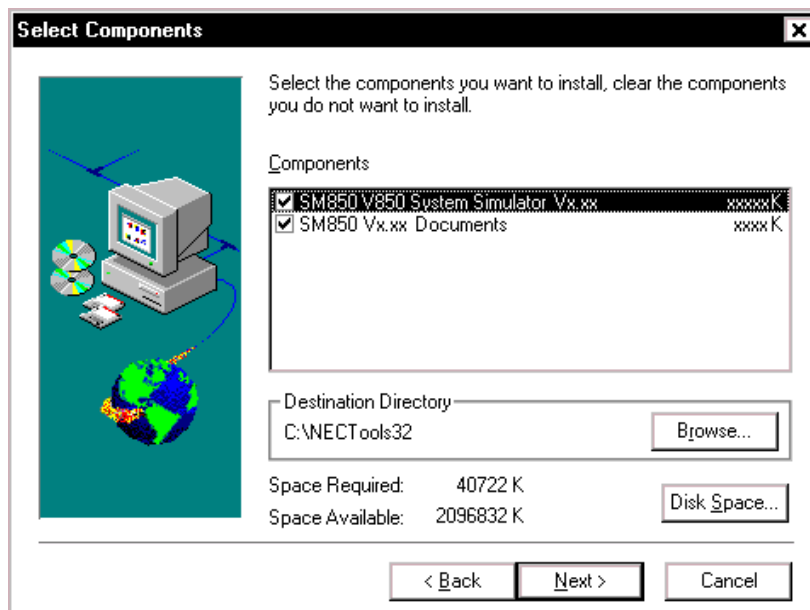

- 8 Specify the name of the folder to which the icon of the SM850 is to be registered. Specify a group name, and click the <Next> button. To stop installation, click the <Cancel> button. The default folder is "NEC Tools32".

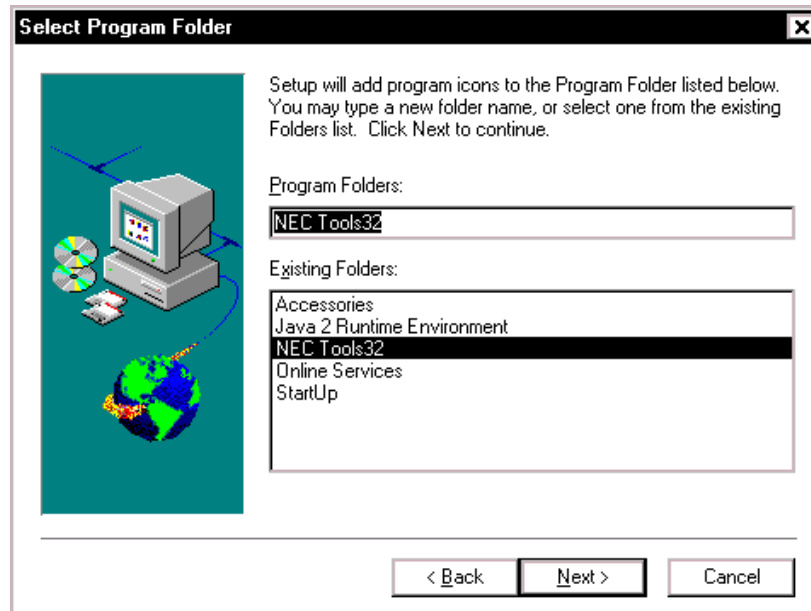

- 9 Final check for starting installation
Confirm the set contents. If you don't need to change the setting, click the <Next> button. To change the setting, click the <Back> button and change the setting. If there are any problems, stop installation by clicking the <Cancel> button.

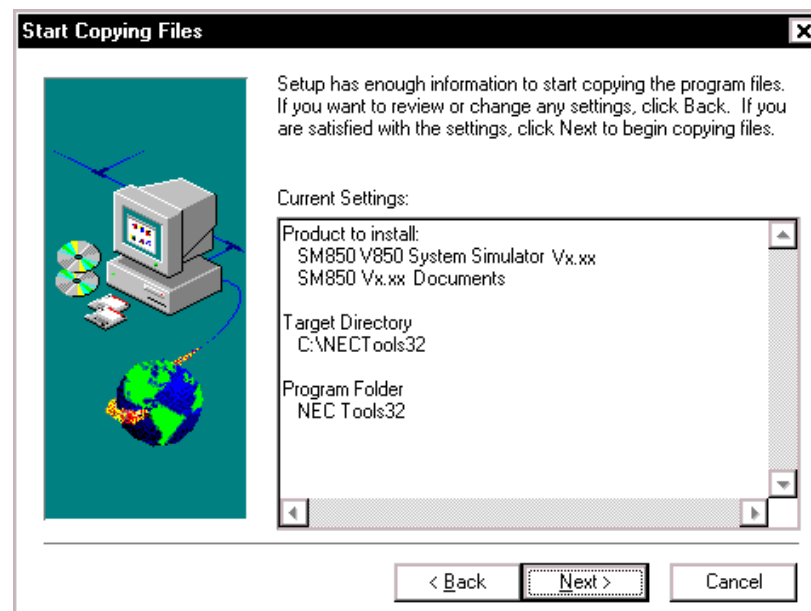

- 10 Copy the files to the specified directory.

11 Completing installation

When the installation has been completed, a dialog box indicating that setup has been completed is opened. Click the <Finish> button.

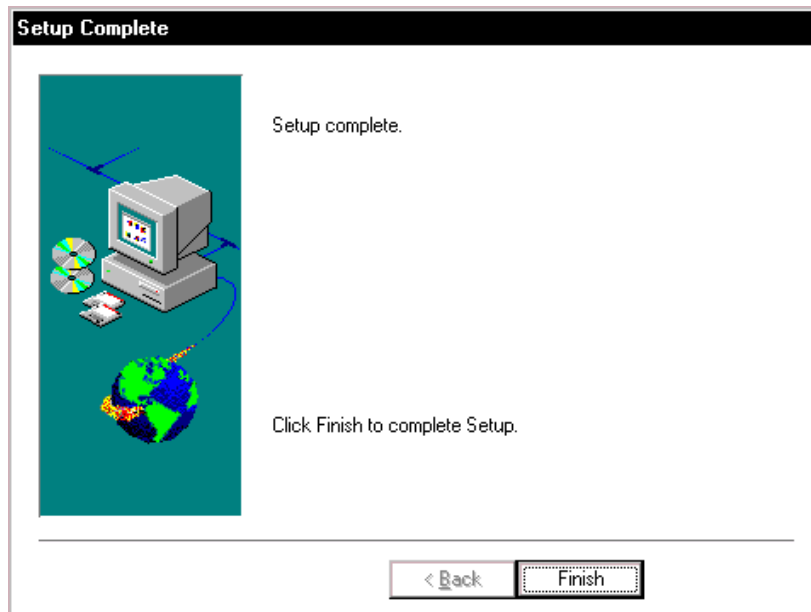

12 When the system disk has been copied, the icon of the SM850 is registered to the "NEC Tools32" group. This completes the installation of the SM850.

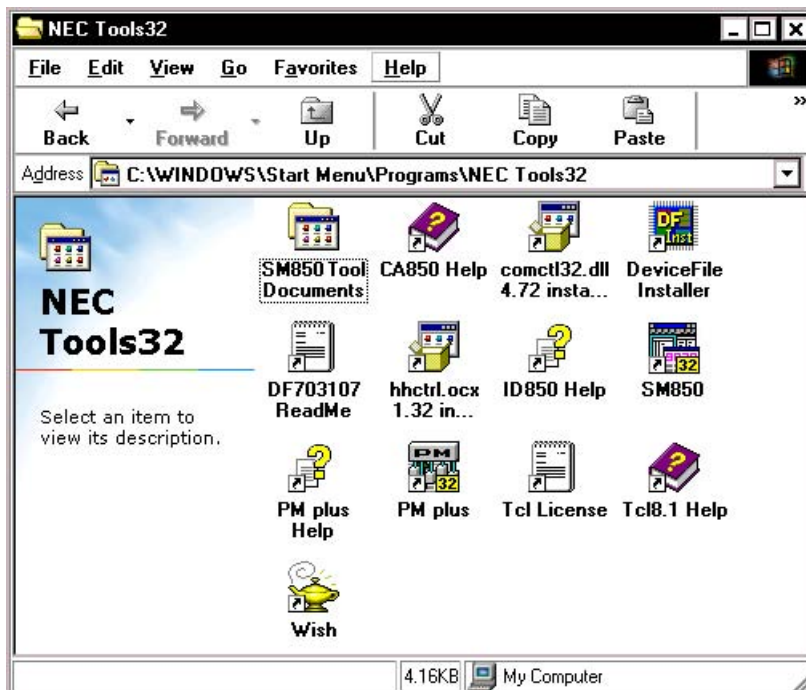

2.2 Uninstalling SM850

This section explains how to uninstall the SM850 .

2.2.1 Uninstalling procedure

- 1 Start Windows.
- 2 Start [Add and Delete Application] from the Control Panel.
- 3 [NEC SM850 V850 System Simulator Vx.xx] from the list displayed at [Setup and Delete], and click the < Add/Remove...> button.

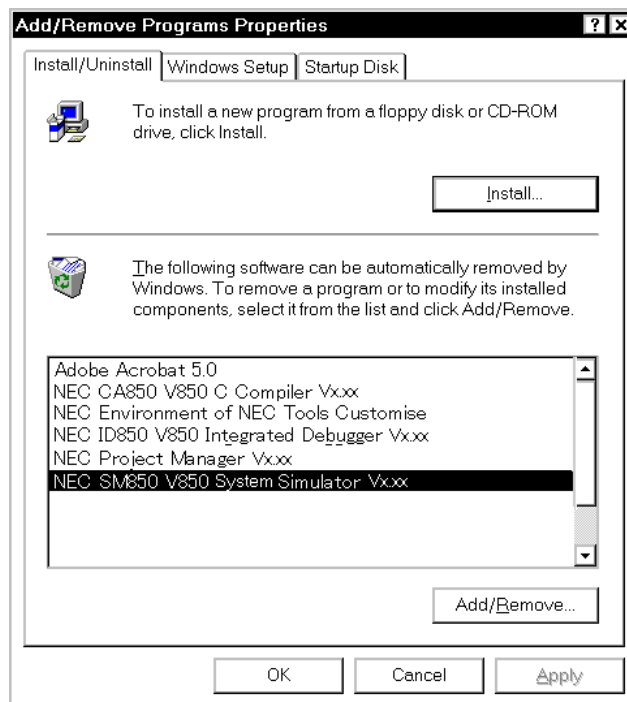

- 4 The Confirm File Deletion dialog box will be displayed. Click the <Yes> button.

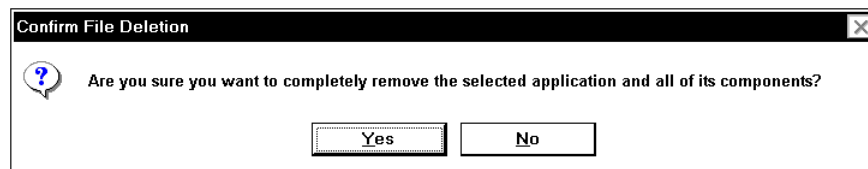

- 5 The program will be deleted. When the message "Uninstalling is complete." is displayed, click the <OK> button.
- 6 This completes the uninstallation of the SM850.

CHAPTER 3 STARTING AND TERMINATING

This chapter explains the procedure of starting and terminating the SM850.

3.1 Starting

Start the SM850 as follows:

- 1 Turn on the power to the PC.
- 2 Start Windows on the PC.
- 3 Select [Start] -> [Program] -> [NEC Tools32] -> [SM850] from the Windows start menu to start the SM850. The Configuration dialog box will be opened.
- 4 Set the items related to the operating environment of the SM850 in the Configuration dialog box. After setting each item, click the <OK> button in the dialog box.

Figure 3-1 Configuration Dialog Box

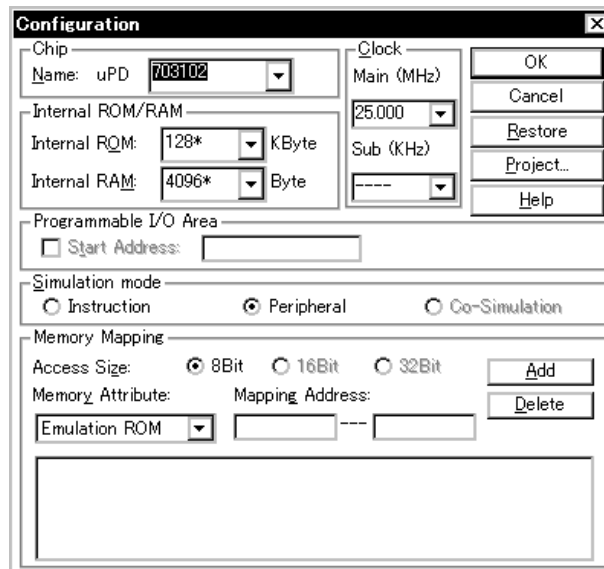

- 5 The Main window will be opened and the SM850 can be operated. Mainly use this window for debugging. At the same time, the main window of the simulator "V850 Simulator GUI"^{Note} (Figure 3-3) will be opened and displayed on the Windows task bar. This window is used to perform simulator operations, such as those related to peripheral simulation and external components.

Note If the V850E/XXX is selected as the target device, the V850E Simulator GUI window will be opened.

Figure 3-2 Main Window

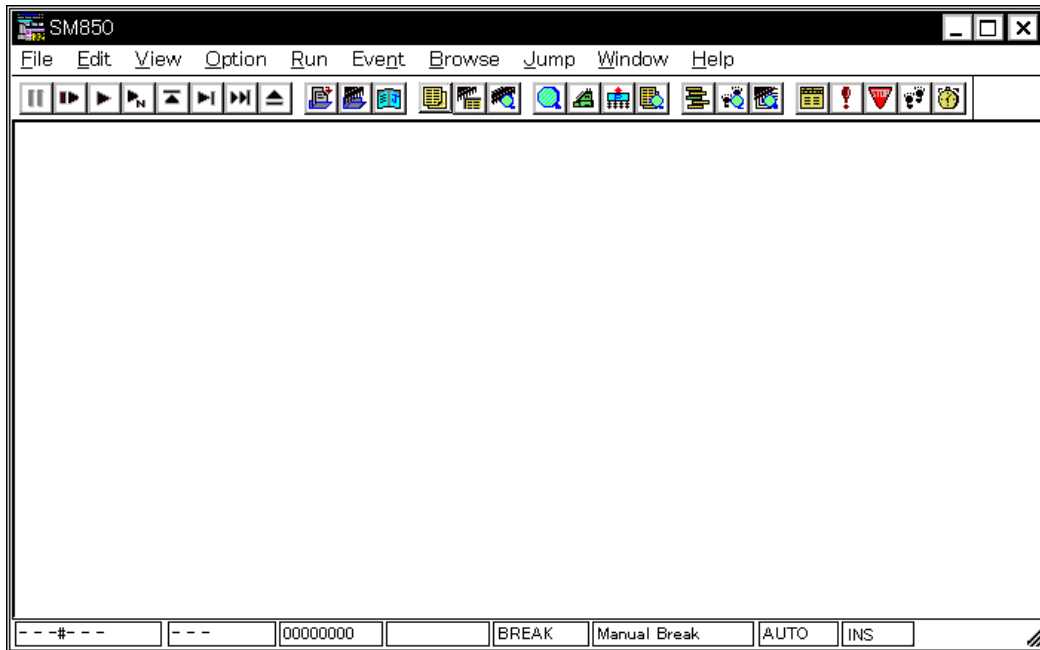
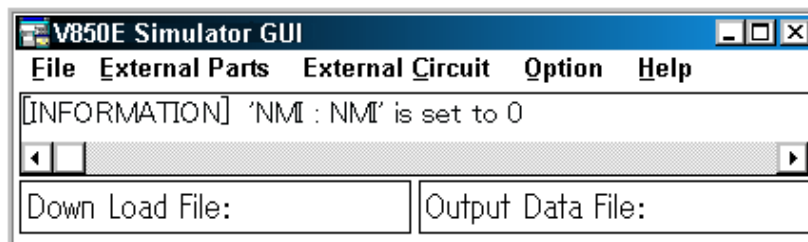

Figure 3-3 V850 Simulator GUI Window



3.2 Terminating

Terminate the SM850 as follows:

- 1 Select the [File] menu -> [Exit] on the Main window or the [File] menu -> [Exit from Simulator] on the V850 Simulator GUI window. The following Exit Debugger dialog box will be opened:

Figure 3-4 Exit Debugger Dialog Box

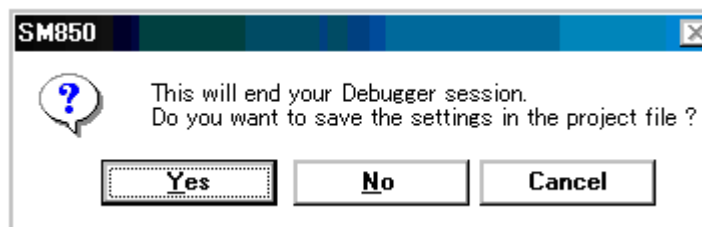

If the above operation is performed while the user program is being executed, the dialog box shown in Figure 3-5 is opened.

In this case, clicking the <Yes> button opens the Exit Debugger dialog box.

Figure 3-5 Message Box for Confirmation of Stopping Execution

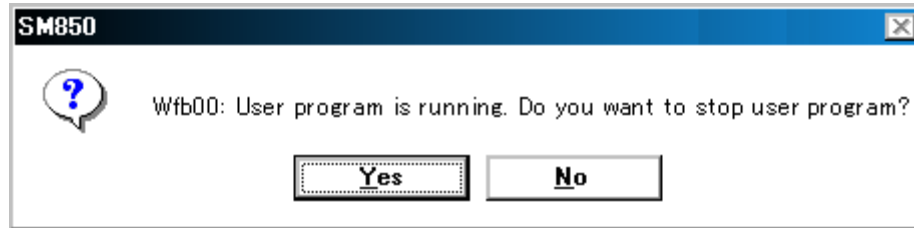

- 2 To save the current debugging environment to a project file, click the <Yes> button.
If the <No> button is clicked, all the windows are closed and the SM850 is terminated.

CHAPTER 4 ASSOCIATION WITH PM plus

This chapter explains the procedure and points to be noted when a function to associate the PM plus is used.

The SM850 can automatically perform a series of operations in development processes, such as **creating source files -> compiling -> debugging -> correcting source files**, in association with the PM plus.

The operation explained in this chapter requires a PM plus(V5.00 or later).

Caution If a load module file is created by using the Windows command prompt, the function to associate the SM850 with the PM plus cannot be used.

4.1 Setting Build Mode

To debug the load module file created by the PM plus on the SM850 at the source level, build to output symbol information for debugging must be performed to create a load module file. This setting can be performed by selecting [Debug Build] on the PM plus.

4.2 Registering Debugger to PM plus Project

The debugger to be used or the load module files to be downloaded can be specified for each project in the PM plus.

Select a debugger using the following procedure:

4.2.1 Selecting debugger

The procedure for selecting the debugger is as follows:

Creating a new workspace

- 1 Select [File] menu -> [New Workspace...] on the PM plus.
-> This opens the dialog box to create a new workspace using the wizard format.
- 2 Creating the necessary settings for the workspace with the wizard, the [New Workspace - Step 7/8 (Select Debugger)] dialog box will be opened. Specify [SM850 V850 System Simulator] in this dialog box.
-> For details of the setting, refer to the PM plus online help or user's manual.

Using an existing workspace

- 1 Select [Tool] menu -> [Debugger Settings...] on the PM plus.
-> The Debugger Settings dialog box will be opened.
- 2 Specify [SM850 V850 System Simulator] and click the <OK> button in this dialog box.

The SM850 is registered as the debugger of the active project.

The SM850 icon is displayed on the toolbar of the PM plus.

4. 2. 2 Downloading multiple load module files

The load module files of the same project group are downloaded to the debugger.

For details of the project group, refer to the PM plus online help or user's manual.

Download multiple load module files in the following steps.

- 1 Select [Tool] menu -> [Debugger Settings...] on the PM plus.
-> The Debugger Settings dialog box will be opened.

Figure 4-1 Debugger Settings Dialog Box (PM plus)

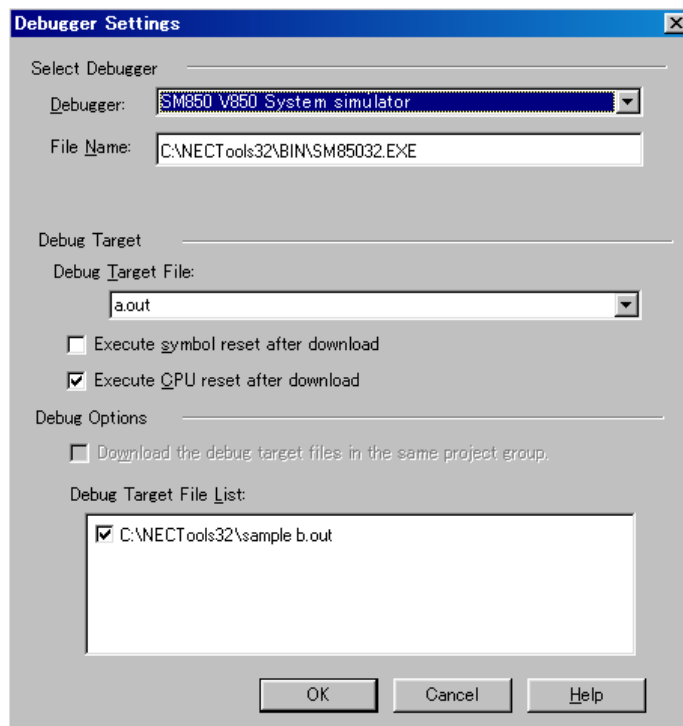

- 2 Specify [SM850 V850 System Simulator] in this dialog box.
- 3 Specify the load module file to be downloaded first in the [Debug Target File] when the debugger is started.
- 4 Check the [Download the debug target files in the same project group] check box, and select the debug target files in the same group to be downloaded in the Debug Target File List.
->The selected file will be downloaded right after the file specified in [Debug Target File] when the debugger is started. Note that when these files are downloaded, symbol reset and CPU reset are not executed.
- 5 Click the <OK> button.

Remark Multiple load module files that are being downloaded can be checked in the Load Module List dialog box dialog box of the SM850.

4.3 To Start SM850 from PM plus

The SM850 can be started from the PM plus as follows:

- Click the SM850 starting button on the toolbar of the PM plus.
- Select the [Build] menu -> [Debug] on the PM plus.
- Select the [Build] menu -> [Build and Debug] on the PM plus.
- Select the [Build] menu -> [Rebuild and Debug] on the PM plus.

If the debugging environment of the SM850 is saved to a project file currently being used by the PM plus, it will be started in the debugging environment saved in the project file.

If the debugging environment of the SM850 is not saved to a project file being used by the PM plus, the Configuration dialog box is opened. At this time, the device type (Chip name) cannot be changed.

4.3.1 Restoring debugging environment

The previous debugging environment can be restored by the following procedure when the SM850 is started from the PM plus:

- 1 Create a new workspace (project file : e.g., sample.prj) on the PM plus.

Caution In the SM850 and PM plus, the environment information is saved to a project file and referenced. The extension of the project file that can be used by the SM850 and PM plus is prj. For the information that is saved or restored by the project file, refer to the online help or the user's manual of each product.

- 2 Start the SM850 from the PM plus. Because a new project file is created, set items other than the device type (Chip name) in the Configuration dialog box in the same manner as when only the SM850 is started.
- 3 Download the load module file to be debugged with the Download dialog box of the SM850.
- 4 Debug the load module file on the SM850.
- 5 Click the <Yes> button on the Exit Debugger dialog box when the SM850 is terminated.
-> The debugging environment will be saved to the project file (sample.prj) for the PM plus when the SM850 is terminated (the debug environment can also be saved to the sample.prj file by overwriting the project file at times other than the completion of SM850 debugging).
- 6 When the SM850 is next started up after the sample.prj file is read by PM plus, the debug environment at the point when the project file was saved is automatically restored.

4.4 Auto Load

If a bug is found while the load module file is being debugged by the SM850, correct the source file using the following procedure. Compiling and re-downloading the file can be automatically executed (Refer to "Auto load by correcting source code").

The load module is downloaded again to the SM850 by compiling and linking the file on the PM plus with

the activated SM850 (refer to "Auto load by starting debugger").

4. 4. 1 Auto load by correcting source code

Correct the source file for auto load as follows:

- 1 Open the source file to be corrected in the Source window. Select [File] menu -> [Open] and specify the file to be corrected on the SM850 (if the file is already open in the Source window, that window is displayed in the forefront).
-> The specified file will be opened in the Source window.
- 2 Select [Edit] menu -> [Correct Source] on the SM850.
-> An editor will be opened and the specified source file will be read.
- 3 Correct the source file on the editor.
- 4 Terminate the editor.

Caution The CPU reset is not performed when the load module file is automatically downloaded. The debug window that was opened when the editor was called, and each event setting will be restored. If the previously used line or symbol has been deleted as a result of correcting the source file, the following happens:

- A variable that was displayed is dimmed.
- The event mark of an event condition is displayed in yellow.

- 5 Select [Build] menu -> [Build and Debug], or [Build] -> [Rebuild and Debug] on the PM plus.

4. 4. 2 Auto load by starting debugger

If the following operation is performed on the PM plus with the SM850 started, the load module will be automatically downloaded to the SM850.

- Selecting the [Build] menu -> [Build and Debug] on the PM plus.
- Selecting the [Build] menu -> [Rebuild and Debug] on the PM plus.

The CPU reset is not performed after the load module has been downloaded.

CHAPTER 5 FUNCTIONS OF SM850

This chapter explains the basic debugging functions and the original simulation functions of the SM850.

Simulation functions of SM850

- External Parts
- Data Input Function
- Peripheral I/O Event & Action Setting Function

Debugging functions

- Debugging functions of SM850
- Setting Debugging Environment
- Program Execution Function
- Event function
- Break function
- Trace function
- Coverage Measurement Function
- Snapshot Function
- Stub Function
- Register Manipulation Function
- Memory Manipulation Function
- Watch Function
- Time Measurement Function
- Load/Save Function
- Real-Time RAM Sampling Function

5.1 External Parts

The SM850 provides standard external parts that input/output data to/from peripheral I/O via a GUI, enabling the configuration of a dummy target system.

Figure 5-1 Examples of External Parts of SM850

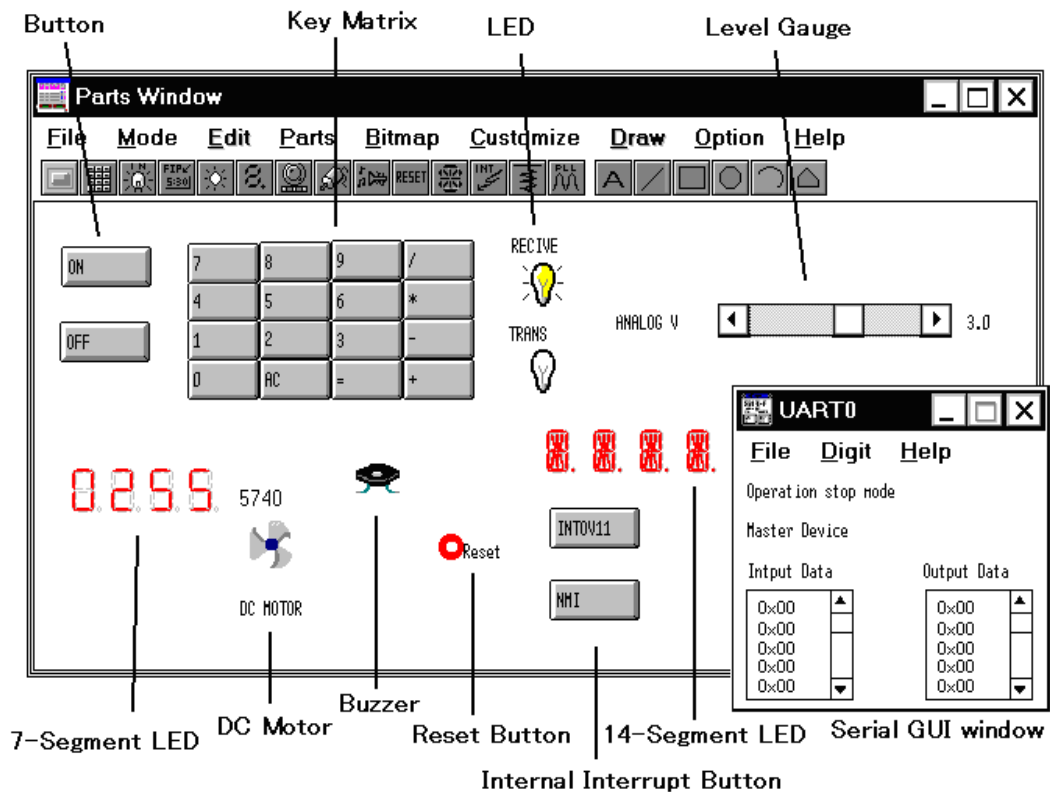

The SM850 provides the following external parts:

Table 5-1 External Parts of SM850 and Setting Dialog Boxes

External Component	Contents
Button	Can be connected to any pin. By clicking the displayed button, a value can be input to the pin. ->Buttons dialog box
Key matrix	A key matrix can be connected to any pin, and data can be input using two or more keys. ->Key Matrixes dialog box
LED	An LED can be connected to any pin, and the output from the pin can be indicated by lighting or extinguishing the LED. ->LEDs dialog box
Level gauge	Any value within a specified range can be assigned to a pin connected to an A/D converter. ->Level Gauges dialog box
7-segment LED	Any 8 pins (7 pins for figures and 1 pin for decimal point) can be assigned to a 7-segment LED, with one pin assigned to the digit signal, and the display on the 7-segment LED can be changed by the value of each pin. When output from the pin assigned to the digital signal is active, the 7-segment LED lights or turns off. ->7seg LEDs dialog box

Table 5-1 External Parts of SM850 and Setting Dialog Boxes

External Component	Contents
DC motor	A DC motor can be connected to any pin. The output value from the pin is indicated by revolution or stoppage of the DC motor. The total time for which the active value has been output is counted from the start of simulation and displayed. ->DC Motors dialog box
Buzzer ^{Note}	A buzzer can be connected to any pin, and the output status can be indicated by the buzzer sound or a bitmap. ->Buzzers dialog box
Reset button	By clicking the displayed reset button, the hardware reset can be performed.
14-segment LED	Any 15 pins (14 pins for figures and 1 pin for decimal point) can be assigned to a 14-segment LED, with one pin assigned to the digit signal, and the display on the 14-segment LED can be changed by the value of each pin. When output from the pin assigned to the digital signal is active, the 14-segment LED lights or turns off. ->14seg LEDs dialog box
Internal interrupt button	A button can be connected to any internal interrupt. By clicking the displayed button, an internal interrupt can be generated. ->Internal Interrupt Button dialog box
Setting pull-up/down resistor	Whether a pin is connected to a pull-up/down resistor can be specified. ->Pull-Up / Pull-Down dialog box
Serial GUI	The operation mode and I/O information of the serial interface can be displayed. ->Serial GUI window

Note To issue the buzzer sound, a sound board and a speaker are required.

Remark Some external parts cannot be selected, depending on the target device.

5. 1. 1 Creating external parts

External parts are created in the Parts window.

Selecting the [Parts] menu in the Parts window or clicking a button on the tool bar opens a setting dialog box. The connection information on a external component and a pin can be specified in this dialog box.

For details, refer to the explanation of each dialog box (e.g. Buttons dialog box).

Figure 5-2 Parts Window (With Menu Displayed)

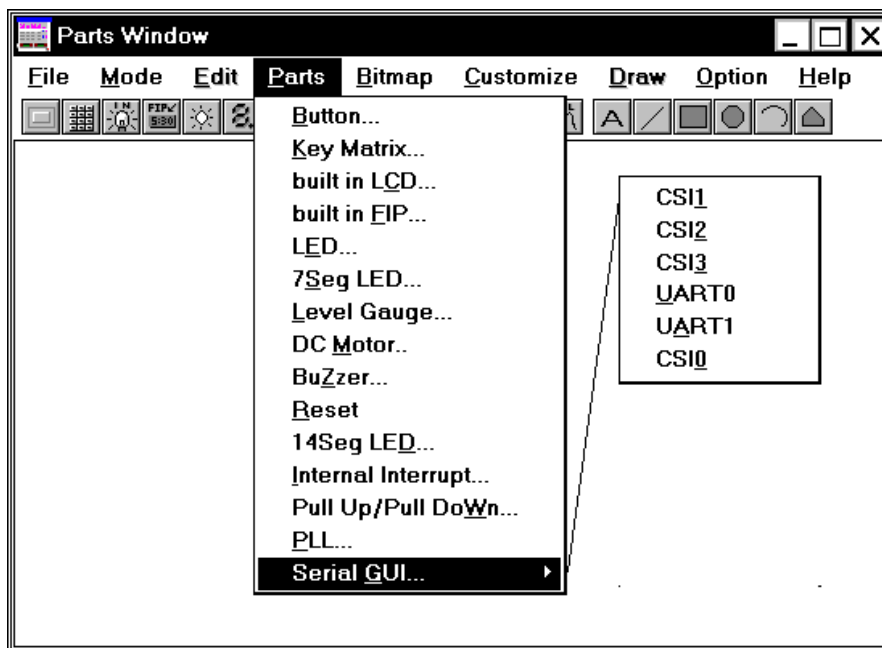

5. 1. 2 I/O operation of external parts and displaying I/O result

External parts set in each dialog box are displayed in the Parts window and can be used as the pins of signals during simulation. By using a displayed external component, the result of input/output can be checked or a value can be input to the simulator.

For details on the I/O operation of each external component, refer to the explanation of the setting dialog box of each external component. Note that I/O operations can be performed with the Parts window in the execution mode.

5. 1. 3 Operation of external parts at CPU reset

Table 5-2 shows the operation of each external component when a CPU reset is generated from the debugger.

Table 5-2 Operation of External Parts at CPU Reset

External Component	External Parts at CPU Reset
Button	All buttons are inactive.
Key	All keys are not pressed.
LED	All LEDs are inactive.
Level gauge	All level gauges are displayed in white.
7/14segment LED	The input value is 0. The scroll thumb of the scroll bar is at the leftmost position. The operating point of the dial is at the lower left part.
DC motor	All DC motors are inactive. The total number of clocks is 0.
Buzzer	A buzzer is inactive.
Internal interrupt button	All buttons are not pressed.

Table 5-2 Operation of External Parts at CPU Reset

External Component	External Parts at CPU Reset
Serial GUI	Initialized

5.1.4 Editing in Parts window

The Parts window can be edited by operations such as moving components, drawing characters, lines, and rectangles, and pasting the bitmap of an external component.

To edit the Parts window, select [Mode] -> [Edit] from the menu bar on the Parts window. As a result, the Parts window is set in the placement mode and the window can be edited.

In the placement mode, the mouse cursor changes to "+" and a window that indicates the mouse pointer position by coordinates (x and y) pops up.

For details on the editing, refer to the Parts window.

5.2 Data Input Function

The SM850 can input data during simulation that contains the timing information for input pins created using two types of input editors. In addition, the output result from the simulator can be saved to a file, or a timing chart can be displayed.

5.2.1 Creating/editing input data

A data file with timing information can be created and edited on the Input 0/1 Editor window or Input timing Chart Editor window.

(1) Input 0/1 Editor window

This window is used to set the input data of any pin by a numeric value in 1-bit units, at any timing. A wait value (input timing) and a input data can be set by using a loop.

Figure 5-3 Input 0/1 Editor Window

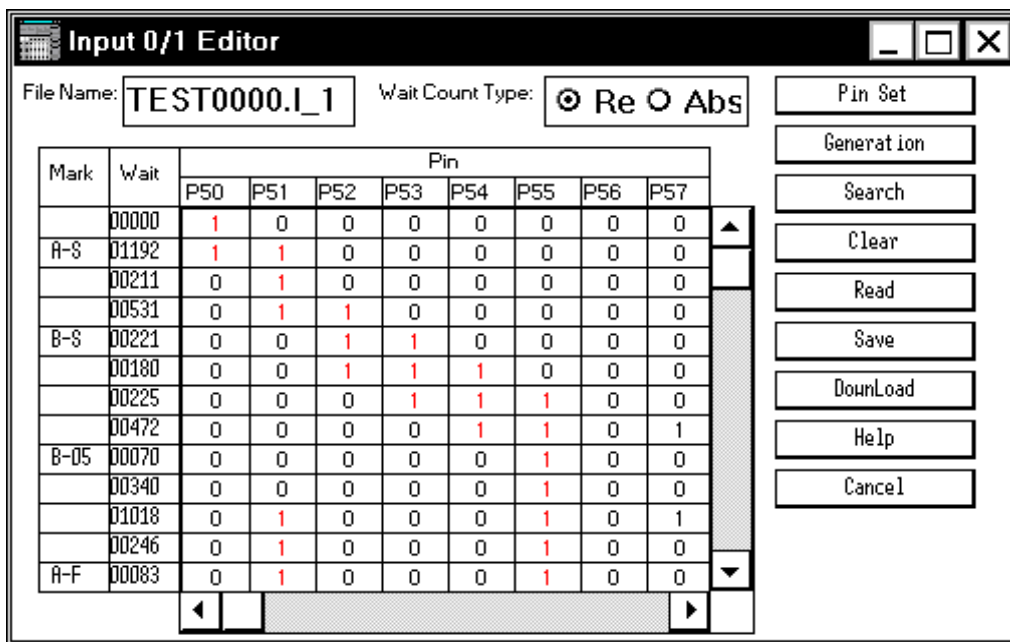

(2) Input timing Chart Editor window

This window is used to set the input timing and input data on a timing chart. Data can be set by setting a wait value (input timing) or a time axis.

Figure 5-4 Input timing Chart Editor Window

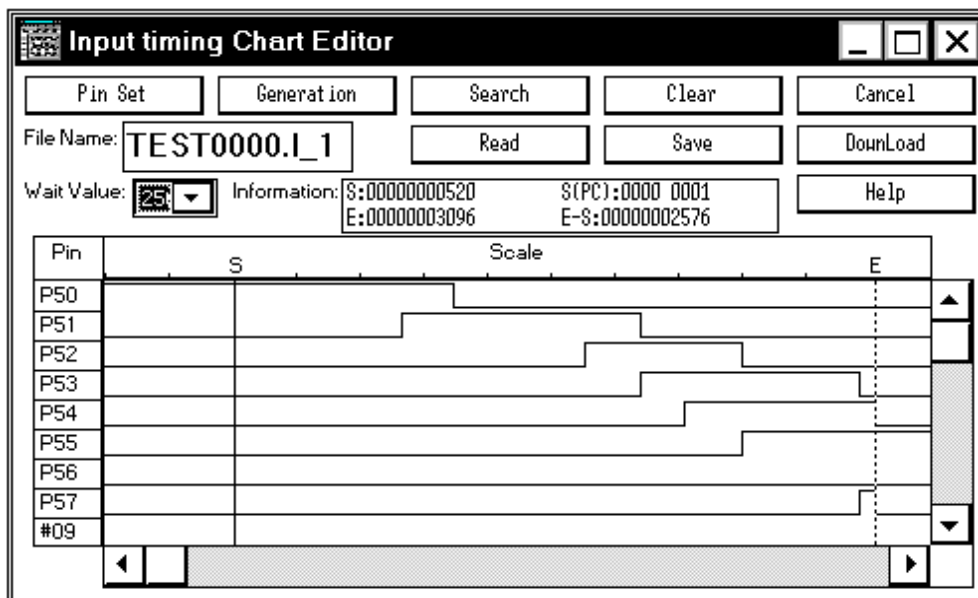

The created data is saved as an input data file. Specify any of the following extensions and the timing of the wait value when saving the data:

Table 5-3 Timing of Wait Value

Extension	
.i_0	File in which the timing of data input is described at the execution timing of an instruction that accesses a certain pin. * The set wait value in this file is ignored.
.i_1	The timing of the data input is described in CPU clock units in this file. * The CPU clock unit and main clock unit are the same.
.i_2	The timing of the data input is described in units of 1/4 main clocks in this file.
.i_3	The timing of the data input is described in units of main clocks in this file.

5. 2. 2 Downloading input data file

An input data file is downloaded with the Down Load dialog box.

Figure 5-5 Down Load Dialog Box

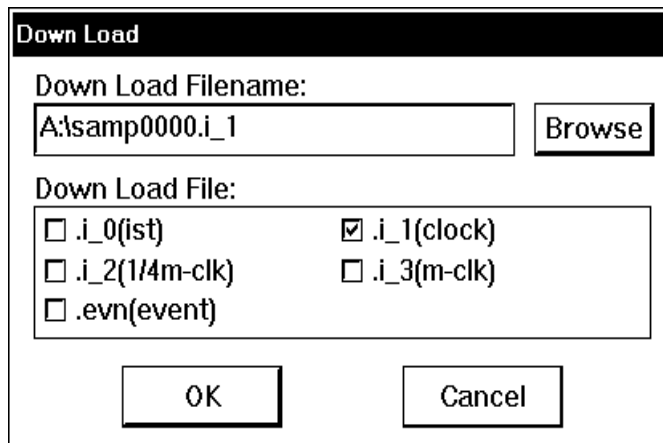

By downloading the input data file (.i_x), a signal input from an external source to the pin is set.

Files of the same file name except the file identifier can be simultaneously downloaded and simulated. Up to five files (including an event condition file) can be downloaded.

A file can be downloaded at any time, except while the CPU is operating.

The priority of the input data set later is higher^{Caution}.

Caution If an input data file is downloaded while an external component for input is being displayed, input from the input data file takes precedence. If an external component for input is displayed while an input data file is being downloaded, input from the external component takes precedence.

5. 2. 3 Processing when input data is not set

If a pin whose value is undefined because no description is made in the input data file (.i_x) and because the pin is not pulled up is accessed during program execution, the value of the pin is initialized to 0. In this

case, a default value message is displayed in the message area of the V850 Simulator GUI window.

Figure 5-6 V850 Simulator GUI Window (With Message Displayed)

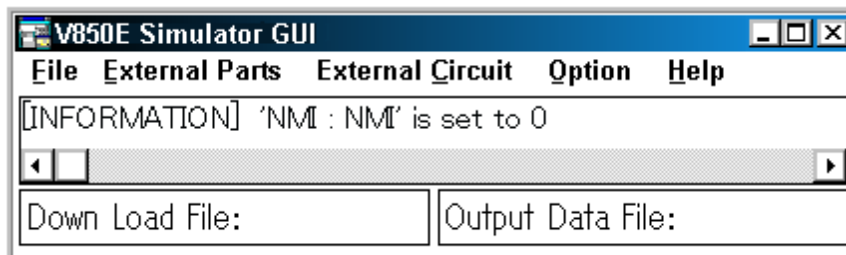

So that this message is not output, connect a pull-up/down resistor to the pin in advance in the Pull-Up / Pull-Down dialog box.

Figure 5-7 Pull-Up / Pull-Down Dialog Box

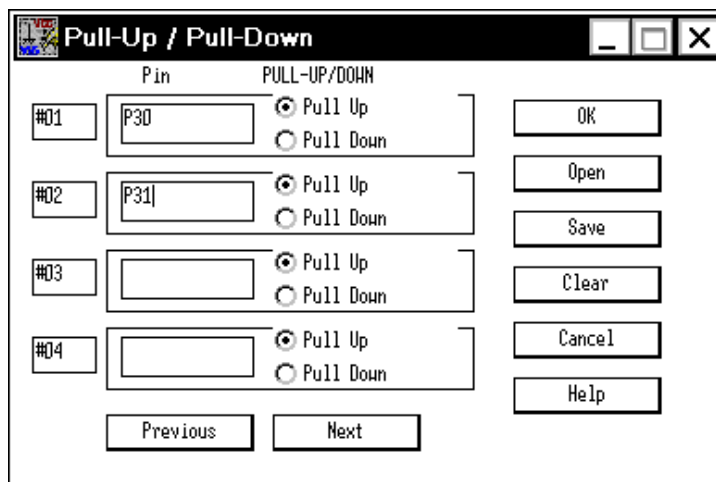

5. 2. 4 Outputting data to file and displaying data

The output status can be output to a file with the Output Setting dialog box.

If output of a timing chart is specified in the Output Setting dialog box, the Output Timing Chart window is opened and the output status can be displayed on a timing chart.

An identifier (.out) is automatically appended to the output file.

Figure 5-8 Output Timing Chart Window

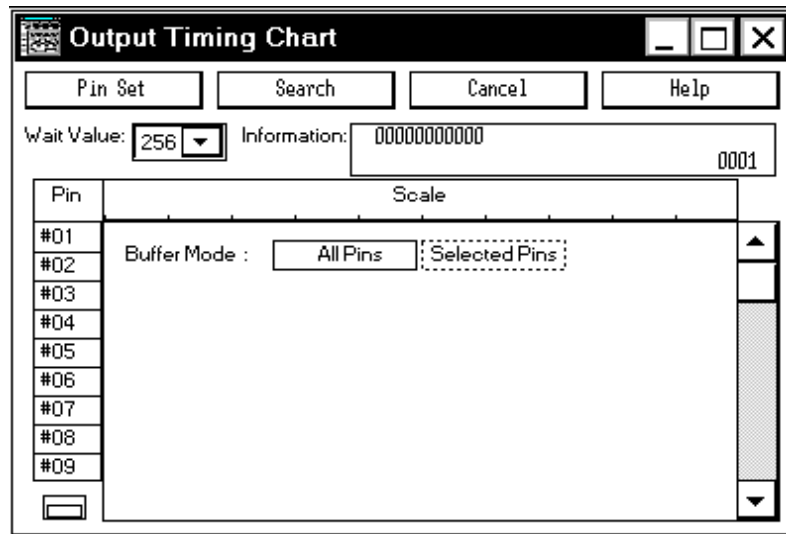

In addition to the data output from a peripheral I/O register, the data input to a peripheral I/O register can also be saved to the output file, so that the I/O status can be checked later.

5.3 Peripheral I/O Event & Action Setting Function

The SM850 can generate an interrupt at specified time after an event condition has been satisfied by using an event set to a peripheral I/O register or any address as a trigger. It can also set data to any address, peripheral I/O register, or pin, and reflect this data during simulation.

5.3.1 Setting event and action

An event condition and the operation (action) to be performed after the event condition has been satisfied are set in the IOR Event & Action dialog box.

Figure 5-9 Peripheral I/O Event & Action Setting Dialog Box

An event condition can be specified by any address, register name, access status, access size, data condition, or mask condition. By specifying the timing as an action, an interrupt can be generated or data can be set in a specified area (an address, peripheral I/O register, or pin).

The set event condition and action are saved to an event condition file (.evn).

5.3.2 Downloading event condition file

The set event condition file can be downloaded with the Down Load dialog box.

Figure 5-10 Down Load Dialog Box

By downloading the event condition file (.evn), the event is registered to the simulator, and the event can be checked during simulation.

5.4 Debugging functions of SM850

The debugging functions of the SM850 are almost equivalent to those of the ID850, but there are slight

differences because the ID850 does not use an in-circuit emulator and implements debugging by software.

(1) Mapping function

The SM850 virtually manages a contiguous memory space the same as that of the target device specified in the Configuration dialog box, by securing an alternate memory on the host machine. Consequently, the size of the internal ROM/RAM area can be changed or any memory area can be mapped as an emulation ROM/RAM area.

Figure 5-11 shows the target memory space if the uPD703000 is specified in the Configuration dialog box as the CPU to be used.

Figure 5-11 Memory Space Managed by SM850 (With uPD703000)

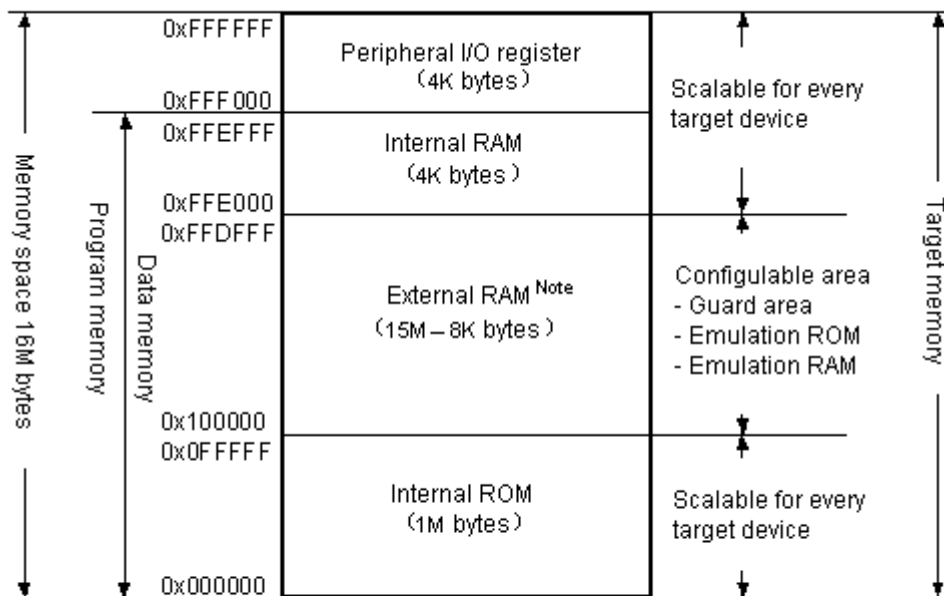

Note : 15M = 16M (All space) - 1M (Internal ROM)
8K = 4K (Internal RAM) + 4K (Peripheral I/O)

(2) Specifying simulation operation mode

A simulation operation mode can be specified in accordance with the debugging stage with the Configuration dialog box. For details, refer to "Supply of simulation operation modes" and the document supplied with the product.

(3) Event function

The following features are available:

- Event conditions of the same name can be used for multiple various event conditions.
- Setting external sense data is invalid.
- A pass count can be set.

(4) Break function

The following features are available:

- Software break event conditions cannot be set.
- Up to 64 break event conditions can be set

(5) Timer function

The following features are available:

- Eight timer event conditions can be set.
- The average, maximum, minimum, and total execution time of a zone specified by a timer event condition can be measured.
- The maximum execution measurement time is about 7 minutes 9 seconds (resolution: 0.1 us).

(6) Trace function

The following features are available:

- Trace capacity can be specified (0 frame to 16M frames).
- Block information is displayed.
- Types of trace modes are displayed.
 - A: All trace or section trace
 - Q: Qualify trace
 - S: Step execution trace
- Branch source address is displayed.

5.5 Setting Debugging Environment

Set a debugging environment with the Configuration dialog box that is opened when the debugger is started, or the Extended Option dialog box or Debugger Option dialog box.

By creating a file (project file) to which the current debugging environment is saved during debugging, and loading this file, the debugging environment when the project file is saved can be restored.

To manipulate the project file, use the Project File Save dialog box and Project File Load dialog box.

After the project file has been loaded, the size and position of the displayed window are returned to the previous size and status (refer to "Table 7-7 Contents Saved to Project File").

To load the project file when starting up the debugger, press the <Project...> button in the Configuration dialog box. It can also be specified that the project file is automatically loaded each time the debugger is started up (refer to "To automatically load a project file").

5.6 Program Execution Function

The program execution function is used to start execution of the user program by the CPU and operation of the tracer.

These functions can be executed by selecting the [Run] menu or the corresponding function button, and the execution formats are classified into real-time execution and non-real-time execution.

5. 6. 1 Real-time execution function

The following real-time execution functions are available:

- [Go] (Go button)
- [Ignore break points and Go] (GoN button)
- [Start From Here] (Start function)
- [Come Here] (Come function)
- [Restart] (ReGo button)

(1) [Go] (Go button)

The user program is executed starting from the address indicated by the current PC register and is stopped if a set break event condition is satisfied. Each analyzer prepares for operation as soon as execution of the user program is started, and is executed or stopped by a condition set as an event condition (break event condition or trace event condition).

(2) [Ignore break points and Go] (GoN button)

This command executes the user program starting from the address indicated by the current PC register. Execution of the user program continues, ignoring set breakpoints.

(3) [Start From Here] (Start function)

This command executes the user program starting from the specified address. Execution of the user program is stopped when a set break event condition is satisfied.

(4) [Come Here] (Come function)

The user program is executed from the address indicated by the current PC register to the address selected in the line/address display area of the Source window or the Assemble window, and then a break occurs.

While the user program is being executed, the break event currently set does not occur.

(5) [Restart] (ReGo button)

The CPU is reset and the user program is executed starting from address 0.

This is the same operation as "resetting the CPU before execution of the user program and executing [Go]".

5. 6. 2 Non-real-time execution function

The following non-real-time execution functions are available:

- [Step In] (Step button)
- [Next Over] (Over button)
- [Slow Motion]

(1) [Step In] (Step button)

The operation differs depending on whether this function is executed in the Source window or the Assemble window.

In the Source window

Step execution of one line of the source text is performed starting from the current PC register value and the contents of each window are updated.

In the Assemble window

One instruction is executed from the current PC register value and the contents of each window are updated.

(2) [Next Over] (Over button)

The operation differs depending on whether the instruction to be executed is the jarl instruction or any other instruction.

jarl instruction

Next step execution is performed, assuming the function or subroutine called by the jarl instruction as one step (step execution continues until the nesting level becomes the same as when the jarl instruction was executed).

Instruction other than jarl

The same processing as [Step In] is performed.

(3) [Slow Motion]

Step execution of one line is performed from the address indicated by the current PC register value in the source mode. In the instruction mode, step execution of one instruction is performed. The contents of each window are updated each time step execution is performed. This operation is repeated until the user executes [Stop].

5.7 Event function

An event is a specific status of the target system during user program execution, such as "address 0x1000 is fetched" or "data is written to address 0x2000".

The SM850 uses an event to trigger an action of functions such as break and trace functions. An event function is used to set, delete, and reference a specific status of the target system that triggers an action (debugging action) as an event condition.

5.7.1 Using event function

So that an action that is triggered by an event function in accordance with the user's debugging aim, the following various event conditions must be set.

Table 5-4 Various Event Conditions

Set Condition	Setting Dialog Box	Contents
Break event	Break dialog box	Condition in which the execution of the user program or the operation of the tracer is stopped.
Trace event	Trace dialog box	Condition in which the process of user program execution is saved to the trace memory.
Snapshot event	Snap Shot dialog box	Condition in which the timing of executing a snapshot is specified. The following three snap data items can be registered: - Register value - Peripheral I/O register value - Memory contents
Stub event	Stub dialog box	Condition in which the timing of inserting the program is specified when the stub function is used. (To return from a specified function if a stub event occurs, be sure to describe the JMP [r31] instruction in the function.)
Timer event	Timer dialog box	Condition in which the timing of starting and stopping time measurement is specified when zone measurement is performed.

These various event conditions are set independently as an "Event condition" or "Event link condition", or as a combination of these. To use the event function of the SM850, therefore, first create the necessary "Event condition" and "Event link condition", and set the various event conditions shown in the Table 5-4 by using these conditions.

5.7.2 Event condition

Create an event condition in the Event dialog box.

Set an address condition, status condition, and data condition in this dialog box. Specify a combination of these as one event condition and name and register this event condition. The registered event condition can be used to set various event conditions. However, the number of event conditions that can be set is limited.

The event condition that is created when a breakpoint is set in the Source window or the Assemble window can also be used (Breakpoint setting/deletion function).

5.7.3 Event link condition

An event link condition specifies sequential constraints for each event, so that two or more events are treated as a single event.

To create an event link condition, use the Event Link dialog box.

By arranging already registered event conditions in this dialog box, one event link condition can be named and registered. The registered event link condition can be used to set various event conditions in the same manner as the event condition. However, the number of event conditions that can be set is limited.

5.7.4 Setting of various event conditions

Various event conditions listed in Table 5-4 are individually created in the corresponding dialog box.

To create various event condition, drag and drop the event icon of an event condition or event link condition registered on the Event Manager to the condition area of each setting dialog box.

The created various event condition is set by clicking the <Set> or <OK> button in the setting dialog box. The mark of the event that has been set is displayed in red. After the event has been set, a debugging action occurs as various event condition.

Up to 256 various event conditions can be registered. The number of various event conditions that can be "set" differs depending on the various event condition (refer to "Table 7-29 Maximum Number of Valid Events for Each Event Condition").

5.8 Break function

The break function is used to stop execution of the user program by the CPU and operation of the tracer.

The following types of break functions are available:

- Event detection break
- Break by Come function
- Break on satisfaction of condition of step execution
- Forced break
- Fail-safe break

Caution The event detection break is not performed when [Come Here], [Step In], [Return Out], or [Next Over] described in "Program Execution Function" is executed.

(1) Event detection break

Event detection break is a function used to stop execution of the user program by detecting a set break event condition. This break is valid for [Go], [Go & Go], [Start From Here], and [Restart].

In the case of [Go & Go], however, the contents of each window are updated and the user program is executed again after the event detection break has occurred. Set a break event as follows:

- Set as an execution event in the Source window or Assemble window (Breakpoint setting/deletion function).
- Set in the Break dialog box.

(2) Break by Come function

The Break by Come function is used to stop the user program that is executed by the [Come Here] command, by detecting an address specified in the Source window or Assemble window. When execution of the user program has been stopped, the breakpoint by the Come function is eliminated.

While the user program is being executed by using this function, a break event that has been set does not occur.

(3) Break on satisfaction of condition of step execution

Break on satisfaction of condition of step execution is a function used to stop execution of the user program when the end condition of each command ([Step In], [Next Over], [Return Out], and [Slowmotion]) is satisfied.

Because one instruction is executed, stopped, and the condition is confirmed at one time, the processing time is longer than that of real-time execution.

(4) Forced break

Forced break is a function used to forcibly stop execution of the user program. It is valid for all the program execution commands. Force break includes the following:

- [Stop] command: Forcibly stops execution of the user program.

(5) Fail-safe break

A fail-safe break is a function for forcibly stopping the user program when the user program has executed a prohibited action on the memory and registers.

The types of fail-safe break functions are as follows:

Non-map break	This break occurs if an attempt is made to access a non-map area.
Write-protect break	This break occurs if an attempt is made to write to memory that must not be written to, such as ROM.
Peripheral I/O register Illegal access break	This break occurs if an attempt is made to access peripheral I/O registers illegally.

Note that if a fail-safe break occurs, there may be a problem with the user program or the set environment of the SM850 may be wrong.

5.9 Trace function

The trace function is used to save the history of the data indicating the execution process of the user program to the trace memory. The trace data saved to the trace memory can be checked in the Trace window.

The item to be displayed in the Trace window can be selected in the Trace Data Select dialog box.

To use the trace function, check that the trace function is valid by selecting the [Option] menu -> [Tracer ON]. The trace function is valid in the default status, and all data is unconditionally traced (unconditional trace) when the program is executed.

5.9.1 Operation of trace

The operation of the tracer differs as indicated in (1) to (3) below, depending on the style of execution of the user program.

(1) Operation during real-time execution

The operation of the tracer differs depending on the specified trace mode.

All trace (Unconditional trace)	Trace is started when real-time execution of the program is specified, and ends when a break occurs.
Conditional trace	Trace is started or stopped by the condition set in the Trace dialog box (if a break occurs while a trace is being executed, however, trace is stopped immediately).

These trace modes can be set by selecting the [Run] menu -> [Conditional Trace /Unconditional Trace].

(2) Operation during Step In execution

The tracer operates every step execution, and trace data of one step is successively added to the trace memory.

(3) Operation during Next Over execution

The operation of the tracer differs depending on the instruction to which Next Over is to be executed.

Table 5-5 Operation of Tracer (During Next Over Execution)

Instruction	Tracer Operation
jarl disp22, [lp] instruction	The jarl instruction and the subroutine that was called are traced.
Other instructions	The same operation as that during Step In execution is performed.

5.9.2 Trace condition setting function

The following setting types of trace condition are available:

(1) Setting trace mode

Two trace modes, unconditional trace and conditional trace, are available.

(2) Setting of tracer control mode

The tracer has a ring structure.

The following operation modes of the tracer can be selected from the [Run] menu:

Non-Stop	Goes around the trace memory and overwrites data from the oldest frame (default).
Full Stop	Goes around the trace memory and then stops the tracer.
Full Break	Goes around the trace memory and then stops the tracer and program execution.
Delay Trigger Stop	Traces data by the number of delay count frames and stops the tracer when a delay trigger event has occurred.

Delay Trigger Break	Traces data by the number of delay count frames and stops the tracer and program execution when a delay trigger event has occurred.
---------------------	---

(3) Setting trace event condition

A trace event condition triggers starting/stopping trace execution when a conditional trace is set.

A trace event condition is set in the Trace dialog box.

The following types of trace event conditions can be specified:

Section trace	Executes a trace between two specified conditions (in a specific zone). A section trace (zone trace) can be executed by setting a trace start event and trace end event and executing a conditional trace.
Qualify trace	Executes a trace only when a condition is satisfied. If two or more events are set as qualify trace events, a qualify trace can be executed by executing a conditional trace. A qualify trace can be executed by setting a qualify trace event and executing a conditional trace.
Delay trigger trace	Executes a trace by the number of delay counts after a condition has been satisfied. A delay trigger trace can be executed by setting a delay trigger event condition, setting a delay count in the Delay Count dialog box, and executing a conditional trace.

5.10 Coverage Measurement Function

Coverage is a function used to record the status (such as execution, read, and write) for each address when the user program is executed.

Coverage measurement can be performed by selecting the [Option] menu -> [Coverage ON], and the status of each address is recorded in the coverage memory by executing the program.

The coverage results can be checked in the Coverage window. This window displays the results of coverage executed in the 1 MB space specified in the Coverage-Address dialog box.

The efficiency of the coverage can be checked in the Coverage-Efficiency View dialog box that is opened by clicking the <View> button on the Coverage-Condition Setting dialog box.

5.11 Snapshot Function

Snapshot is a function used to save the contents of registers, memory, and peripheral I/O registers to the trace memory as snap data while the user program is being executed.

A snap event condition specifies the trigger by which a snapshot is to be executed.

The snap event condition can be set in the Snap Shot dialog box.

The following snap data can be collected:

- Register value (program registers, system registers)
- Peripheral I/O register value
- Memory contents

One snap event condition can specify collection of up to 16 snap data.

5.12 Stub Function

The stub function is used to execute the user program (sub-program) that has been downloaded or written by online assembly to a vacant memory area in advance when an event occurs.

A stub event condition is a trigger by which the stub function is to be executed. The snap event condition can be set in the Stub dialog box.

Append the JMP [r31] instruction to the end of the sub-program that is executed when a stub event occurs, otherwise, malfunction may occur.

Use the stub function in the "after" break mode. If it is used in the "before" break mode, only the sub-program is repeated.

Figure 5-12 Flow of Stub Function

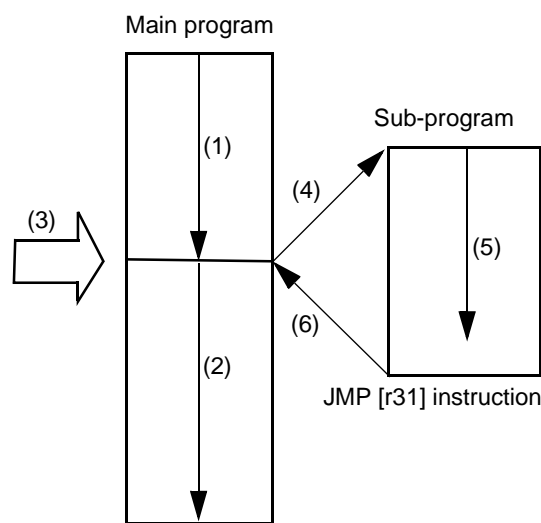

If stub function is not used

(1) and (2) are executed.

If stub function is used

- 1 (1) is executed.
- 2 A stub event occurs in (3) and a break occurs.
- 3 The simulator sets the current address to the r31 register in (4), and rewrites the PC value to the entry address of the sub-program.
- 4 (5) is executed.
- 5 Execution is returned to the main program by the JMP instruction at the end of the sub-program in (6).

5.13 Register Manipulation Function

The register manipulation function is used to display or change the contents of the program registers, system registers, and peripheral I/O registers.

This function can be used in the Register window or IOR window. To change the register to be displayed in each window, use the Register Select dialog box or IOR Select dialog box.

A user-defined I/O port can be displayed or changed by registering it to the Add I/O Port dialog box. In a device supporting programmable IOR, programmable IOR can be displayed or changed by using the Configuration dialog box.

5. 14 Memory Manipulation Function

As a memory manipulation function, the memory contents can be displayed or changed by using mnemonic codes, hexadecimal codes, and ASCII codes.

This function can be used in the Memory window or Assemble window. The contents of memory can be copied, initialized, and compared.

5. 15 Watch Function

Data (variable) values can be checked or changed in the Watch window.

Local variables can be checked or changed in the Local Variable window.

The contents of a variable value can be easily referenced in the Source window or Assemble window by placing the mouse cursor on the selected variable (balloon watch function).

5. 16 Time Measurement Function

The time measurement function is used to measure the full execution time from the start of execution of the user program to the occurrence of a break, or the execution time of the user program in a specific zone by using a timer event.

A timer event condition specifies the trigger by which time measurement is started or stopped. Set a timer event condition in the Timer dialog box. The time from the start of execution of the user program to the occurrence of a break can be easily measured by using the Run-Break event registered in advance.

To use the timer function, select the [Option] menu -> [Timer On] to set the timer to ON. If the timer is set to OFF, the timer does not operate. However, the Run-Break event is not affected regardless of whether the timer is set to ON or OFF.

To stop the timer currently in operation during simulation, select the [Run] menu -> [Timer Stop]. To operate the timer when it is stopped, select the [Run] menu -> [Timer Start]. These two menus are toggled and alternately displayed depending on the current timer status.

5. 17 Load/Save Function

The load/save function is used to load/save each file.

The SM850 loads/saves each file individually.

These three types of files can be handled:

view files	File recording the screen information when it is saved. By loading this file, a reference file is opened in the Source window.
Information file	File recording the set data and debugging environment as information on the user program and debugger.
Setting files	File recording the window information.

5. 17. 1 View files

The list of the view files to be handled is shown below:

These files can be manipulated in the View File Load dialog box and View File Save dialog box.

Table 5-6 List of View Files

File Type	Contents
Source Text (*.SVW)	Source window view file Records the source text in the Source window.
Assemble (*.DIS)	Assemble window view file Records the assembly information in the Assemble window.
Memory (*.MEM)	Memory window view file Records the memory information in the Memory window.
Register (*.RGW)	Register window view file Records the register information in the Register window.
Local Variable (*.LOC)	Local Variable window view file Records the local variable information in the Local Variable window.
Stack Trace (*.STK)	Stack Trace window view file Records the stack trace information in the Stack Trace window.
Trace (*.TVW)	Trace window view file Records the trace information in the Trace window.
Coverage (*.COV)	Coverage window view file Records the coverage information in the Coverage window.
Console (*.LOG)	Console window view file Records the information in the Console window.

5. 17. 2 Information files

The list of the information files to be handled is shown below.

Table 5-7 List of Information Files

File Name (Extension)	Contents	Dialog Box
Object file (*.HEX)	Stores the object codes of the user program.	Download dialog box, Upload dialog box
Load module file (*.OUT)	Stores the object codes, symbols, and source information of the user program.	Download dialog box
Project File (*.PRJ)	Stores the debugging environment	Project File Load dialog box, Project File Save dialog box

Table 5-7 List of Information Files

File Name (Extension)	Contents	Dialog Box
Binary file (*.BIN)	Records data in binary format.	Download dialog box, Upload dialog box
Coverage result file (*.CVB)	Stores the coverage results.	Download dialog box, Upload dialog box

A project file sets the display information, size, and display position of a window or dialog box, and restores the debugging environment to the previous status (when the project file was saved) when it is loaded.

5. 17. 3 Setting files

The list of the setting files to be handled is shown below:

These files can be manipulated in the View File Load dialog box and View File Save dialog box.

Table 5-8 List of Setting Files

File Name (Extension)	Contents
Watch setting file (*.WCH)	Stores the watch setting contents of the Watch window.
Peripheral I/O register setting file (*.OR)	Stores the peripheral I/O register setting contents of the IOR window.
Event setting file (*.EVN)	Stores the event setting contents of the Event Manager.

5. 18 Real-Time RAM Sampling Function

The real-time RAM sampling functions are used to read and display the memory contents, even during user program execution, if a variable allocated to a range in which the memory contents can be read, or the memory contents are displayed.

This function can be checked in the Watch window or Memory window.

Settings related to this function are performed in the Extended Option dialog box.

CHAPTER 6 OPERATION

This chapter explains the flow of basic debugging operations using the SM850 and the following functions:

- Flow of Debugging Operations
- Active Status and Static Status
- Jump Function
- Trace Result with Linking Window

6.1 Flow of Debugging Operations

(1) Setting debugging environment

Prepare for debugging.

-> Configuration dialog box

Download a load module file to be debugged.

-> Download dialog box

Checking the loaded file.

-> Load Module List dialog box

(2) Displaying source program

By downloading a load module file with debug information, the corresponding source file is automatically displayed.

-> Source window

(3) Displaying disassemble result

The disassembled result of the downloaded user program is displayed.

-> Assemble window

(4) Setting breakpoint

Breakpoints can be set easily in the Source window, Assemble window, and Watch window.

-> Breakpoint setting/deletion function

-> To set a breakpoint for read/write access to a variable

(5) Setting event

Register event conditions and event link conditions.

-> Event dialog box, Event Link dialog box

Setting of various event conditions

Set a various event condition by using the Event Manager or an event icon in the event manager area on each various event setting dialog box.

Each various event condition corresponds to the following various event setting dialog box.

Break event condition -> Break dialog box

Trace event condition -> Trace dialog box

Snap event condition -> Snap Shot dialog box

Stub event condition -> Stub dialog box

Timer event condition -> Timer dialog box

Checking setting status of various event conditions

-> Event dialog box or the event manager area in each various event setting dialog box

(6) Executing user program

By executing the user program, the PC advances to the set breakpoint, break event, or forced breakpoint (refer to "Program Execution Function").

Use the execution control button or [Run] menu to execute the user program.

(7) Checking trace data

-> Trace window

(8) Editing, checking, and changing memory contents

-> Memory window, Memory Copy dialog box, Memory Fill dialog box, Memory Compare dialog box, Memory Compare Result dialog box

(9) Registering, checking, and changing variable value

-> Watch window, Quick Watch dialog box, Add Watch dialog box, Change Watch dialog box, Local Variable window

(10) Checking stack contents

-> Stack Trace window

(11) Checking and changing of registered contents of register value

-> Register window, Register Select dialog box

The value of the PC register can also be checked in the Source window and Assemble window.

(12) Checking and changing peripheral I/O register value

-> IOR window, IOR Select dialog box

(13) Registering, checking, and changing user-defined I/O port value

-> Add I/O Port dialog box, IOR window

(14) Changing mnemonic and executing online assembly

-> Assemble window, Source window

(15) Checking execution time of user program

-> Timer dialog box, Timer Result dialog box, Trace window

(16) Checking coverage measurement result

-> Coverage window, Coverage-Clear dialog box, Coverage-Address dialog box, Coverage-Condition Setting dialog box, Coverage-Efficiency View dialog box

(17) Searching character string in each window

By clicking the < Search...> button in the window in which searching is to be executed, the following types of searching dialog boxes are opened:

Source Search dialog box, Assemble Search dialog box, Memory Search dialog box, Trace Search dialog box, Coverage Search dialog box

(18) Manipulating view file

-> View File Save dialog box, View File Load dialog box

(19) Uploading memory contents and coverage result

-> Upload dialog box

(20) Saving debugging environment to project file

-> Project File Save dialog box

(21) Organizing dummy target system

Set or display external parts (such as buttons and LEDs connected to pins).

-> Setting dialog box of each part, Parts window

(22) I/O data of pin during simulation

a) Creating and editing input data

-> Input 0/1 Editor window, Input timing Chart Editor window

b) Downloading input data

-> Down Load dialog box

c) Outputting output data to file and displaying data

-> Output Setting dialog box, Output Timing Chart window

(23) Taking action after satisfaction of event condition

a) Setting event and action (creating event condition file)

-> IOR Event & Action dialog box

b) Downloading event condition file

-> Down Load dialog box

(24) Terminating SM850

-> Exit Debugger dialog box

6.2 Active Status and Static Status

The Source window, Assemble window, Memory window, and Coverage window have the following two window statuses:

Active status	The display position and contents of the window in the active status are automatically updated in association with the current PC value. This window is also the jump destination of the jump function. If this window is linked with the Trace window, the contents displayed in the active window are updated in association with the Trace window. Only one window can be opened in the active status. Select this status by the [Window] menu.
Static status	The display position of the window in the static status does not move in association with the current PC value, but the displayed contents are updated. The static window is not used as the jump destination of the jump function. In addition, it is not linked with the Trace window. If an active window is already open, the next window is opened in the static status. Two or more static windows can be opened at the same time. Select this status by the [Window] menu.

Because two or more static windows can be opened, the current status of the windows can be temporarily held.

6.3 Jump Function

The jump function is used to jump to Source window, Assemble window, Memory window, or Coverage window from a jump pointer that is the line or address on which the cursor is placed, and display the contents of the jump destination window from the jump pointer.

You can jump among the above windows, or from Trace window, Stack Trace window, Event Manager, and Register window to the above windows.

Jump method

- 1 Move the cursor to the line or address that is to be used as the jump pointer, on the window from which jumping is possible (select an event icon on the Event Manager).
- 2 Select the following menu item to which execution is to jump from the [Jump] menu.
 - Source window->Select [Source].
 - Assemble window->Select [Assemble].
 - Memory window->Select [Memory].
 - Coverage window->Select [Coverage].

Caution If a program code does not exist on the line at the cursor position, the first address of the line with a program code above or below that line is used as the jump pointer.

Details of jump source address

To jump from the following windows, the jump destination is as follows:

- To jump from the Trace window to the Memory window or Coverage window, the jump source address differs depending on the cursor position in the trace result display area.

If the cursor is at an access address, access data, or access status	-> Access address
Other than above	-> Fetch address
To jump to the Source window or Assemble window	-> Fetch address

- To jump from the Register window, move the cursor to a register value.
- To jump from the Stack Trace window, the jump destination is as follows:

[With current function]

- If the jump destination is the Source window -> Jumps to the current PC line.
- If the jump destination is a window other than the Source window -> Jumps to the current PC address.

[With function other than current function]

- If the jump destination is the Source window
-> Jumps to the line that calls a nested function.
- If the jump destination is a window other than the Source window
-> Jumps to the address next to the instruction that calls a nested function.

6.4 Trace Result with Linking Window

By linking Trace window with each window (Source window, Assemble window, Memory window, or Coverage window), the corresponding part can be displayed on the linked window, by using the address at the cursor position on the Trace window as a pointer.

If the cursor is moved on the Trace window, the corresponding part on the linked window is highlighted or indicated by the cursor position.

To link a window

- 1 Set the Trace window as the current window.
- 2 Select a window to be linked with the [View] menu -> [Window Synchronize].
Source window ->Select [Source].
Assemble window ->Select [Assemble].
Memory window ->Select [Memory].
Coverage window ->Select [Coverage].
- 3 Move the cursor to the line to be linked in the trace result display area of the Trace window.
- 4 Using the address of the line selected in 3 as a pointer, the corresponding part is highlighted (or indicated by the cursor position) in the display area of the window selected in 2.

Caution The linking source address differs as follows depending on the cursor position in the trace result display area if the Memory window or Coverage window is linked.

Access address, access data, access status -> Access address

Others -> Fetch address

When the Source window or Assemble window is linked, the fetch address is always used as the pointer.

CHAPTER 7 WINDOW REFERENCE

This chapter explains the details of the window/dialog box functions of the SM850.

7.1 Window List

Table 7-1 and Table 7-2 lists the windows of the SM850.

Table 7-1 SM850 Window List (Debugger)

Window Name	Contents
Main window	This window is displayed first, when the debugger is started. It controls execution of the user program. Various windows are opened from this window.
Configuration dialog box	Displays and sets the debugger operation environment.
Extended Option dialog box	This dialog box is used to display and set the extended options of the debugger.
Debugger Option dialog box	Displays and sets options.
Font dialog box	Displays the types of fonts displayed in the Source window and sets the size of the font.
Project File Save dialog box	Saves the debug environment.
Project File Load dialog box	Loads the debug environment.
View File Save dialog box	Saves the contents of the current window to a view file or event setting file.
View File Load dialog box	Reads the view file or source event setting file of each window.
Download dialog box	Loads an object file and binary file.
Upload dialog box	Saves the memory contents to a file.
Load Module List dialog box	Lists the names and file path names of the downloaded load module files.
Browse dialog box	Debugger Option dialog box, Select the file to be set in Source Search dialog box.
Source Text Move dialog box	This dialog box is used to specify a file to be displayed in Source window and the position from which displaying the file is to be started.
Address Move dialog box	Specifies the start address to display the contents of the Memory window, Assemble window or Coverage window.
Trace Move dialog box	Specifies the start address to display the contents of the Trace window.
Symbol To Address dialog box	Displays the addresses and symbol values of variables and functions.
Source window	Displays a source file or text file.
Source Search dialog box	Searches for a character string in a source file.
Assemble window	Disassembles the program and executes online assembly.
Assemble Search dialog box	Searches the contents of the Assemble window.
Memory window	Displays and modifies the contents of memory.
Memory Search dialog box	Searches the contents of the Memory window.

Table 7-1 SM850 Window List (Debugger)

Window Name	Contents
Memory Fill dialog box	Initializes the memory contents with specified data.
Memory Copy dialog box	Copies the memory.
Memory Compare dialog box	Compares the memory.
Memory Compare Result dialog box	Displays the result of comparing the memory.
DMM dialog box	Sets addresses and data subject to DMM.
Watch window	Displays and modifies variables.
Quick Watch dialog box	Temporarily displays and changes the value of a variable.
Add Watch dialog box	Registers a variable to be displayed in the Watch window.
Change Watch dialog box	Changes a variable to be displayed in the Watch window.
Local Variable window	Displays and changes the local variable in the current function.
Stack Trace window	Displays and changes the stack contents of the current user program.
Register window	Displays and changes the contents of the registers (program registers and system registers).
Register Select dialog box	Selects a register to be displayed in the Register window.
IOR window	Displays and changes the contents of the peripheral I/O registers.
IOR Select dialog box	Selects a peripheral I/O register or I/O port to be displayed in the IOR window.
Add I/O Port dialog box	Registers an I/O port to be displayed in the IOR window.
Trace window	Displays trace results.
Trace Search dialog box	Searches trace data.
Trace Data Select dialog box	Selects items to be displayed in the Trace window.
Coverage window	Displays the coverage results.
Coverage Search dialog box	Searches coverage results.
Coverage-Clear dialog box	Clears the coverage results.
Coverage-Address dialog box	Selects the coverage measurement range as a space of 1 MB or more.
Coverage-Condition Setting dialog box	Sets a coverage efficiency measurement range.
Coverage-Efficiency View dialog box	Displays the coverage results in terms of efficiency.
Event Manager	Displays, enables/disables, and deletes each event condition.
Event dialog box	Registers and displays event conditions.
Event Link dialog box	Registers and displays event link conditions.
Break dialog box	Registers, sets, and displays break event conditions.
Trace dialog box	Registers, sets, and displays trace event conditions.
Snap Shot dialog box	Registers, sets, and displays snapshot event conditions.
Stub dialog box	Registers, sets, and displays stub event conditions.
Timer dialog box	Displays execution time measurement result, and registers, sets, and displays timer event conditions.
Timer Result dialog box	Displays execution time measurement results.
Delay Count dialog box	Sets the delay count of a trace.

Table 7-1 SM850 Window List (Debugger)

Window Name	Contents
Reset Debugger dialog box	Initializes the SM850, target CPU, and symbol information.
About dialog box	Displays the version of the SM850.
Exit Debugger dialog box	Terminate the SM850.
Console window	Inputs commands.
Error/Warning dialog box	Displays error/warning messages.

Table 7-2 SM850 Window List (Simulator)

Window Name	Contents
V850 Simulator GUI window	Main window of simulator (SM850)
I/O Event & Action dialog box	Sets and displays an event and action for a peripheral I/O register or any address.
Input 0/1 Editor window	Sets an input value (0 or 1) to an input pin.
Input timing Chart Editor window	Sets an input value (in timing chart format) to an input pin specified with the Input timing Chart Editor window.
Pin Setting dialog box	Sets a pin name to be displayed in the Input 0/1 Editor window, Input timing Chart Editor window and Output Timing Chart window.
Down Load dialog box	Downloads an input file and event condition file.
Output Setting dialog box	Saves a file of output results from output pins and sets timing chart display.
Output Timing Chart window	Displays the I/O data and interrupt signals of pins in a timing chart.
Search window	Searches I/O data.
Parts window	Sets and displays external parts.
Buttons dialog box	Sets information on connection between the buttons to be displayed in the Parts window and pins.
Key Matrixes dialog box	Sets information on connection between the key matrixes to be displayed in the Parts window and pins.
LEDs dialog box	Sets information on connection between the LEDs to be displayed in the Parts window and pins.
7seg LEDs dialog box	Sets information on connection between the 7-segment LEDs to be displayed in the Parts window and pins.
14seg LEDs dialog box	Sets information on connection between the 14-segment LEDs to be displayed in the Parts window and pins.
Level Gauges dialog box	Sets information on connection between the level gauges to be displayed in the Parts window and pins.
DC Motors dialog box	Sets information on connection between the level gauges to be displayed in the Parts window and pins.
Buzzers dialog box	Sets information on connection between the buzzers to be displayed in the Parts window and pins.
Internal Interrupt Button dialog box	Sets information on connection between the internal interrupt buttons to be displayed in the Parts window and pins.

Table 7-2 SM850 Window List (Simulator)

Window Name	Contents
Pull-Up / Pull-Down dialog box	Sets information on the pin connection of the pull-up/down resistors to be displayed in the Parts window.
Serial GUI window	Displays the I/O information on the serial interface.
Bitmap Entry dialog box	Registers or deletes the bit map file of the external component to be displayed in the Parts window.
Open dialog box	Specifies a file to be manipulated.
Save As dialog box	Saves the file subject to operation.
Speed Option dialog box	Selects the simulation function to meet the purpose of the user, so that the simulator runs at high speed.

7.2 Explanation of Windows

This section explains each debug window as follows:

Window/dialog name

Briefly explains the function of the window or dialog box and points to be noted.

In addition, the display image of the window or dialog box is also illustrated.

Items of related operation are also explained.

Opening

Explains how to open the window or dialog box.

If two or more methods of opening are listed, the window or dialog box can be opened by any of them.

Explanation of each area

Explains items to be set to or displayed in each area of the window or dialog box.

Functions often used (right-click menu)

Explains the context menu that is displayed in the window when the right mouse button is clicked.

From the context menu, convenient functions often used in this window can be selected with a single action (window only).

Function buttons

Explains the operation of each button in the window or dialog box.

Related operations

Explains the operation of a window or dialog box related to this window or dialog box.

Main window

This window is automatically opened when the SM850 is started up and initialized. It exists on the screen until the SM850 is terminated. Other windows are manipulated from this window. Execution of the user program is controlled in this window.

Execution of the user program is controlled in the following three modes:

Source mode	Debugs the user program at the source level.
Instruction mode	Debugs the user program at the instruction level.
Auto mode	Automatically selects the source mode or instruction mode.

The auto mode is set when the debugger is started up.

Figure 7-1 Main Window

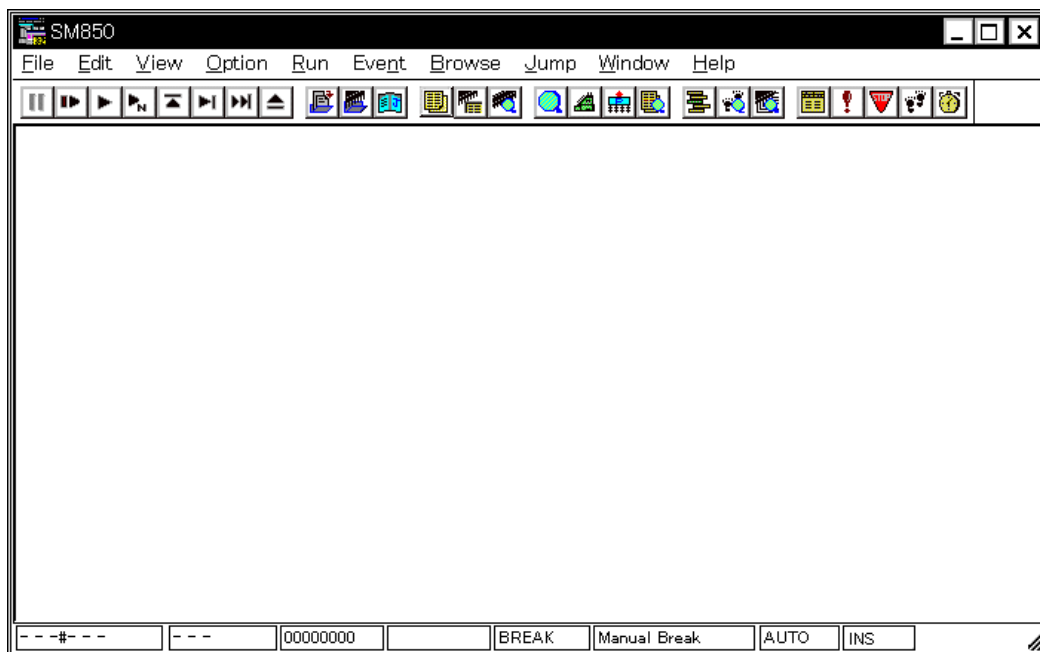

This section explains the following items:

- Toolbar
- Menu bar
- Window display area
- Status bar

Toolbar

The toolbar is a collection of buttons that can execute often-used commands with a single action. Each

button is graphically displayed to indicate the image of its function. This toolbar can be displayed in the following two modes. The modes are selected in Debugger Option dialog box.

Figure 7-2 Toolbar with Only Graphics (default)





























Figure 7-3 Toolbar with Graphics and Characters



Whether the toolbar is displayed or not can be specified by selecting [Option] -> [Tool Bar] from the menu bar. This toolbar can be moved inside or outside the main window by dragging and dropping with the mouse.

The meaning of each button on the toolbar is as follows. When the mouse cursor is placed on a button of the toolbar, a tool hint pops up several seconds later.

 Stop	Stops execution of the user program. Same function as [Run] -> [Stop] on the menu bar.
 ReGo	Resets the CPU and executes the user program. Same function as [Run] -> [Restart] on the menu bar.
 Go	Executes the user program from the current PC without resetting the CPU. Same function as [Run] -> [Go] on the menu bar.
 Go	Executes the user program without a break occurrence. Same function as [Run] -> [Ignore break points and Go] on the menu bar.
 Ret	The user program is real-time executed until execution returns. Same function as [Run] -> [Return Out] on the menu bar * This command is used for a function described in C language.
 Step	Step execution (executes instructions in the program one by one.) If a function or subroutine is called, its instructions are executed one by one. Same function as [Run] -> [Step In] on the menu bar.
 Over	Next step execution (executes the program, assuming a function/call statement as one step.) If a function or subroutine is called, its instructions are not executed on a step-by-step basis. Same function as [Run] -> [Next Over] on the menu bar.
 Res	Resets the CPU. Same function as [Run] -> [CPU Reset] on the menu bar.
 Open	Opens View File Load dialog box. Same function as [File] -> [Open...] on the menu bar.
 Load	Opens Download dialog box. Same function as [File] -> [Download...] on the menu bar.

 Proj	Opens Project File Load dialog box. Same function as [File] -> [Project] -> [Open...] on the menu bar.
 Src	Displays the source text. Opens Source window. Same function as [Browse] -> [Source Text] on the menu bar.
 Asm	Displays the disassemble results. Opens Assemble window. Same function as [Browse] -> [Assemble] on the menu bar.
 Mem	Displays the contents of the memory. Opens Memory window. Same function as [Browse] -> [Memory] on the menu bar.
 Wch	Displays the watch contents. Opens Watch window. Same function as [Browse] -> [Watch] on the menu bar.
 Reg	Displays the register contents. Opens Register window. Same function as [Browse] -> [Register] on the menu bar.
 IOR	Displays the contents of the Peripheral I/O registers. Opens IOR window. Same function as [Browse] -> [I/O Register] on the menu bar.
 Loc	Displays the local variable contents. Opens Local Variable window. Same function as [Browse] -> [Local Variable] on the menu bar.
 Stk	Displays the stack contents. Opens Stack Trace window. Same function as [Browse] -> [Stack Trace] on the menu bar.
 TrW	Displays the trace results. Opens Trace window. Same function as [Browse] -> [Trace] on the menu bar.
 Cov	Displays coverage measurement results. Opens Coverage window. Same function as [Browse] -> [Coverage] on the menu bar.
 Mgr	Opens Event Manager. Same function as [Event] -> [Event Manager] on the menu bar.
 Evn	Registers and sets events. Opens Event dialog box. Same function as [Event] -> [Event...] on the menu bar.
 Brk	Registers and sets break events. Opens Break dialog box. Same function as [Event] -> [Break...] on the menu bar.
 Trc	Registers and sets trace events. Opens Trace dialog box. Same function as [Event] -> [Trace...] on the menu bar.
 Tim	Registers and sets timer events. Opens Timer dialog box. Same function as [Event] -> [Timer...] on the menu bar.

Menu bar

The menu bar consists of the following menus:

- (1) [File] menu
- (2) [Edit] menu
- (3) [View] menu
- (4) [Option] menu
- (5) [Run] menu
- (6) [Event] menu
- (7) [Browse] menu
- (8) [Jump] menu
- (9) [Window] menu
- (10) [Help] menu

(1) [File] menu

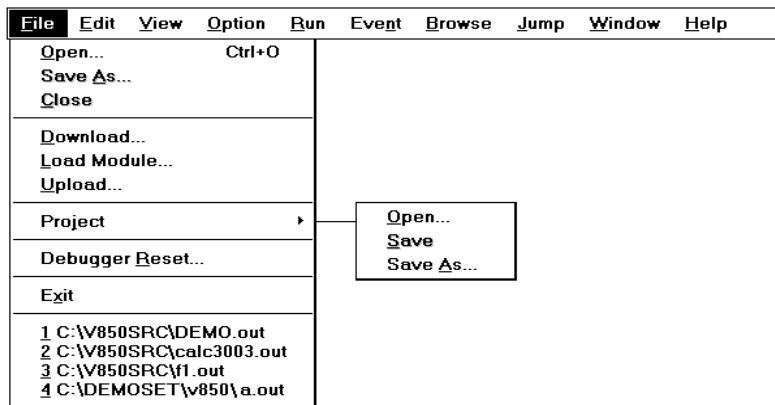

Open...	Loads a view file, source file, or text file. Opens View File Load dialog box. The operation differs depending on the extension of the file selected in the dialog box.
Save As...	Saves the contents displayed on the current window to the file whose name is specified. Opens View File Save dialog box.
Close	Closes the current window.
Download...	Downloads a program. Opens Download dialog box.
Load Module...	Lists the names of the files that have been downloaded. Opens Load Module List dialog box.
Upload...	Uploads a program. Opens Upload dialog box.
Project	Manipulates a project file.

Open...	Opens a project file. Opens Project File Load dialog box.
Save	Overwrites the current status to the project file currently being read to the debugger.
Save As...	Saves the current status to a specified project file. Opens Project File Save dialog box.
Debugger Reset...	Initializes the target CPU, symbols, and debugger. Opens Reset Debugger dialog box.
Exit	Terminates the debugger. Opens Exit Debugger dialog box.
(Open file)	Lists the names of the files opened.

(2) **[Edit]** menu

File	Edit	View	Option	Run	Event	Browse	Jump	Window	Help
	Cut		Ctrl+X						
	Copy		Ctrl+C						
	Paste		Ctrl+V						
	Write in		Enter						
	Restore		Esc						
	Memory								
	Edit Source								

Fill...	
Copy...	
Compare...	
Modify...	

Cut	Cuts a selected character string and saves it to the clipboard buffer.
Copy	Copies a selected character string and saves it to the clipboard buffer.
Paste	Pastes the contents of the clipboard buffer to the text cursor position.
Write in	Writes the modified contents to the target.
Restore	Cancel the modification.
Memory	Manipulates the memory contents.
Fill...	Initializes the memory. Opens Memory Fill dialog box.
Copy...	Copies the memory. Opens Memory Copy dialog box.
Compare...	Compares the memory. Opens Memory Compare dialog box.
Modify...	Rewrites the memory contents in close to real time during user program execution. Opens DMM dialog box.
Edit Source	Opens the source file displayed in the active Source window with the editor specified by the PM plus when the PM plus runs.

(3) [View] menu

This menu displays different items depending on the window that is active. The following items may be displayed:

- Common items
- Source window-dedicated items
- Assemble window-dedicated items
- Memory window-dedicated items
- Watch window-dedicated items
- Register window-dedicated items
- IOR window-dedicated items
- Local Variable window-dedicated items, Stack Trace window-dedicated items
- Trace View window-dedicated items
- Coverage window-dedicated items
- Event Manager-dedicated items

Common items

File	Edit	View	Option	Run	Event	Browse	Jump	Window	Help
		Search...		Ctrl+G					
		Moye...		Ctrl+J					
		Quick Watch...		Ctrl+W					
		Add Watch...							
		View Watch							
		Change Watch...							
		Delete Watch		Del					
		Symbol...							

Search...	Performs a search. Opens the search dialog box corresponding to the current window. Same operation as the <Search> button.
Moye...	Moves the display position. Opens the specification dialog box corresponding to the current window.
Quick Watch...	Temporarily displays the contents of the specified data. Opens Quick Watch dialog box.
Add Watch...	Registers the specified data to the Watch window. Opens Add Watch dialog box.
View Watch	Adds the selected data to the Watch window. If the data is a symbol, it is added in accordance with the setting of Debugger Option dialog box.
Change Watch...	Changes the data on the line selected by the Watch window. Opens Change Watch dialog box. This menu is valid only when a variable is selected in Watch window.
Delete Watch	Deletes the selected watch point from the Watch window. This menu is valid only when a variable is selected in Watch window.

Symbol...	Displays the address of the specified variable or function, or the value of the specified symbol. Opens Symbol To Address dialog box.
---------------------------	--

Source window-dedicated items

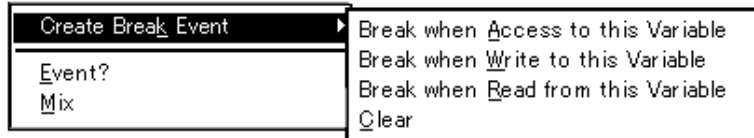

Create Break Event	Creates a break event by using the selected variable.
Break when Access to this Variable	Creates a break event that can be accessed for read/write.
Break when Write to this Variable	Creates a break event that can be accessed for write.
Break when Read from this Variable	Creates a break event that can be accessed for read.
Clear	Deletes a break event corresponding to the selected variable.
Event?	Displays the event information of a line at the cursor position or a selected variable name. If an event is set, Event dialog box is opened.
Mix	Specifies whether the results of assembly are displayed in mixed display mode, or not displayed. Checked: Mixed display Not checked: No display (default)

Assemble window-dedicated items

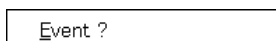

Event?	Displays the event information of the address at the cursor position. If an event is set, Event dialog box is opened.
------------------------	--

Memory window-dedicated items

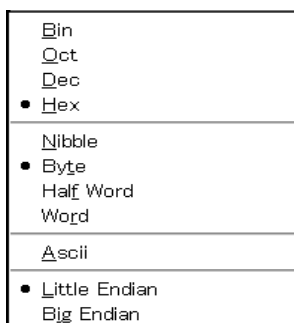

Bin	Displays binary numbers.
Oct	Displays octal numbers.
Dec	Displays decimal numbers.
Hex	Displays hexadecimal numbers (default).
Nibble	Displays in 4-bit units.
Byte	Displays in 8-bit units (default).
Half Word	Displays in 16-bit units.
Word	Displays in 32-bit units.
Ascii	Selects whether ASCII characters are displayed or not. Checked: Displayed Not checked: No display (default)
Little Endian	Displays in little endian (default).
Big Endian	Displays in big endian.

Watch window-dedicated items

Only "selected items" can be manipulated in the Watch window.

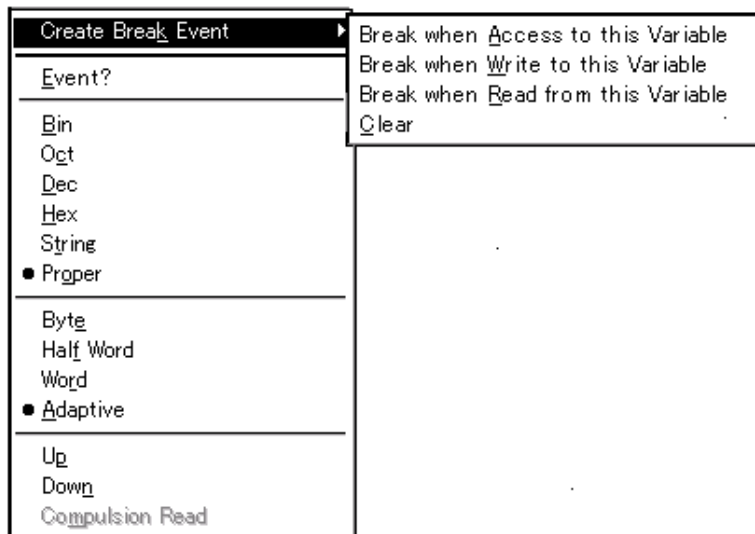

Create Break Event	Creates a break event by using the selected item.
Break when Access to this Variable	Creates a break event that can be accessed for read/write.
Break when Write to this Variable	Creates a break event that can be accessed for write.
Break when Read from this Variable	Creates a break event that can be accessed for read.
Clear	Deletes a break event corresponding to the selected item.
Event?	Displays the event information of the variable selected. If an event is set, Event dialog box is opened.

Bin	Displays binary numbers.
Oct	Displays octal numbers.
Dec	Displays decimal numbers.
Hex	Displays octal numbers.
String	Displays character strings.
Proper	Displays the default value of each variable. Symbols are displayed in accordance with the setting of Debugger Option dialog box (default).
Byte	Displays in 8-bit units.
Half Word	Displays in 16-bit units.
Word	Displays in 32-bit units.
Adaptive	Displays the default value of each variable. Only this item is valid for a symbol in C language. Symbols are displayed in accordance with the setting of Debugger Option dialog box (default).
Up	Moves up one line.
Down	Moves down one line.
Compulsion Read	Forcibly reads the peripheral I/O registers that are disabled from being read because their values will be changed, or the data of the I/O ports and I/O protect area added in Add I/O Port dialog box.

Register window-dedicated items

Bin Oct Dec <input checked="" type="radio"/> Hex
Pick Up Select...

Bin	Displays binary numbers.
Oct	Displays octal numbers.
Dec	Displays decimal numbers.
Hex	Displays hexadecimal numbers (default).
Pick Up	Displays only the registers selected in Register Select dialog box. Checked: Displays only the selected register. Not checked: Displays all the registers (default).
Select...	Opens Register Select dialog box.

IOR window-dedicated items

<input type="radio"/> Bin <input type="radio"/> Oct <input type="radio"/> Dec <input checked="" type="radio"/> Hex
<input type="radio"/> Sort By Name <input checked="" type="radio"/> Sort By Address <input type="radio"/> UnSort
<input checked="" type="checkbox"/> Attribute
<input type="checkbox"/> Pick Up <input type="checkbox"/> Select...
<input type="checkbox"/> Compulsion Read

Bin	Displays binary numbers.
Oct	Displays octal numbers.
Dec	Displays decimal numbers.
Hex	Displays hexadecimal numbers (default).
Sort By Name	Displays in alphabetical order.
Sort By Address	Displays in address order (default).
Unsort	Does not sort.
Attribute	Displays or does not display an attribute field (Attribute). Checked: Displayed (default) Not checked: Not displayed
Pick Up	Displays only the registers selected in IOR Select dialog box. Checked: Displays only the selected register. Not checked: Displays all the registers (default).
Select...	Opens IOR Select dialog box.
Compulsion Read	Forcibly reads the peripheral I/O registers that are disabled from being read because their values will be changed, or the data of the I/O ports and I/O protect area added in Add I/O Port dialog box.

Local Variable window-dedicated items, Stack Trace window-dedicated items

<input type="radio"/> Bin <input type="radio"/> Oct <input type="radio"/> Dec <input type="radio"/> Hex <input type="radio"/> String <input checked="" type="radio"/> Proper

Bin	Displays binary numbers.
Oct	Displays octal numbers.
Dec	Displays decimal numbers.
Hex	Displays octal numbers.
String	Displays character strings.

Proper	Displays the default value of each variable (default).
------------------------	--

Trace View window-dedicated items

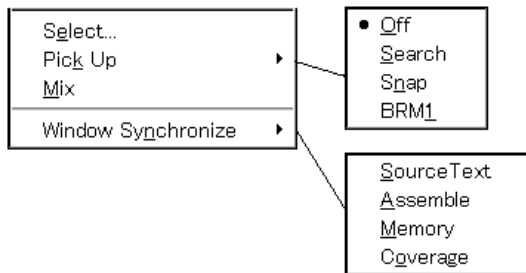

Select...	Selects the contents to be displayed. Opens Trace Data Select dialog box.
Pick Up	Performs the setting for pickup display.
Off	Does not pick up and display (default).
Search	Picks up and displays a frame that satisfies the search condition.
Snap	Picks up and displays a snap frame.
BRM1	Picks up and displays the first M1 fetch frame after a program branch.
Mix	Specifies whether the results of assembly are displayed in mixed display mode, or not displayed. Checked: Mixed display Not checked: No display (default)
Window Synchronize	Sets linking between Trace window and the following windows. A checked window is linked.
Source Text	Links Source window.
Assemble	Links Assemble window.
Memory	Links Memory window.
Coverage	Links Coverage window.

Coverage window-dedicated items

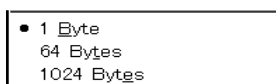

1Byte	Displays in 1-byte units (default).
64Bytes	Displays in 64-byte units.
1024Bytes	Displays in 1024-byte units.

Event Manager-dedicated items

Select <u>A</u> ll Event Ctrl+A
Delete <u>E</u> vent Del
Sort By <u>N</u> ame
Sort By <u>K</u> ind
• <u>U</u> nSort
<u>D</u> etail
• <u>O</u> verview

Select <u>A</u> ll Event	Selects all the events registered to the Event Manager.
Delete <u>E</u> vent	Deletes a selected event.
Sort By <u>N</u> ame	Displays icons in the order of event names.
Sort By <u>K</u> ind	Displays icons in the order of event types.
<u>U</u> nSort	Does not sort icons (default).
<u>D</u> etail	Detailed display
<u>O</u> verview	List display (default)

(4) [Option] menu

File	Edit	View	Option	Run	Event	Browse	Jump	Window	Help				
✓ Tool Bar ✓ Status Bar ✓ Button													
										Source Mode Instruction Mode • Auto Mode			
										Configuration... Extended Option... Debugger Option... Add I/O Port...			
Trace Clear Coverage				Clear... Select...									
✓ Coverage ON ✓ Timer ON ✓ Tracer ON				Condition... Efficiency...									

Tool Bar	Selects whether the tool bar is displayed (default) or not.
Status Bar	Selects whether the status bar is displayed (default) or not.
Button	Selects whether the buttons on each window are displayed (default) or not.
Source Mode	Executes step execution at the source level (in line units).
Instruction Mode	Executes step execution at the instruction level (in instruction units).
Auto Mode	Automatically selects step execution at the source level or step execution at the instruction level (default). Step execution is performed at the source level (in a mode other than mixed display mode) if Source window is active. It is performed at the instruction level if Assemble window is active. If neither window is active, step execution is performed at the source level.

Configuration...	Sets the environment. Opens Configuration dialog box.
Extended Option...	Sets extended functions. Opens Extended Option dialog box.
Debugger Option...	Sets debugger options. Opens Debugger Option dialog box.
Add I/O Port...	Adds user-defined I/O ports. Opens Add I/O Port dialog box.
Trace Clear	Clears the trace data. This item is displayed only when Trace window is active.
Coverage	Opens the following dialog boxes related to coverage measurement.
Clear...	Clears the coverage measurement results. Opens Coverage-Clear dialog box.
Select...	Selects the coverage measurement range as a space of 1 MB or more. Opens Coverage-Address dialog box.
Condition...	Sets a coverage efficiency measurement condition. Opens Coverage-Condition Setting dialog box.
Efficiency...	Displays coverage efficiency. Opens Coverage-Efficiency View dialog box.
Coverage ON	Turns ON/OFF coverage measurement (default: ON). This item cannot be selected during user program execution.
Timer ON	Turns ON/OFF timer measurement (default: ON). This item cannot be selected during user program execution. The timer measuring Run-Break time cannot be stopped.
Tracer ON	Turns ON/OFF the tracer (default: ON). This item cannot be selected during user program execution.

(5) [Run] menu

File	Edit	View	Option	Run	Event	Browse	Jump	Window	Help
					Restart		F4		
					Stop		F2		
					Go		F5		
					Ignore break points and Go		Ctrl+F5		
					Return Out		F7		
					Step In		F8		
					Next Over		F10		
					Start From Here		Shift+F6		
					Come Here		F6		
					Go & Go				
					Slowmotion				
					CPU Reset		F3		
					Change PC		Ctrl+F9		
					Break Point		F9		
					• Uncond. Trace ON				
					Cond. Trace ON				
					Trace Control Mode				
					Coverage Start				
					Timer Start				
					Tracer Start				
								<ul style="list-style-type: none"> • Non Stop Full Stop Full Break Delay Trigger Stop Delay Trigger Break 	

Restart	Resets the CPU and executes the program. Same operation as the ReGo button
Stop	Forcibly stops program execution. Same operation as the Stop button
Go	Executes the program from the current PC. Same operation as the Go button
Ignore break points and Go	Executes the program, ignoring break points being set. Same operation as the GoN button
Return Out	The user program is real-time executed until execution returns. Same operation as the Ret button Note: This menu item is available only for a function described in C language.
Step In	Executes the instructions in the program one by one (step execution). If a function or subroutine is called, its instructions are executed one by one. Same operation as the Step button
Next Over	Executes the instructions in the program one by one (Next step execution). If a function or subroutine is called, its instructions are not executed on a step-by-step basis. Same operation as the Over button
Start From Here	Executes the program from the cursor position on Source window or Assemble window (Start function).
Come Here	Executes the program from the current PC to the cursor position in the Source window or Assemble window (Come function).
Go & Go	Continues executing the program. If a break occurs because a break condition is satisfied, the window is updated and the program is executed again. Each time a break has occurred, the same operation as clicking the Go button is performed.
Slowmotion	Continues step execution. Each time step execution has been performed, the window is updated and then step execution is performed again. Same operation as clicking the Step each time a break has occurred.
CPU Reset	Resets the CPU. Same operation as the Res button
Change PC	Sets the address at the cursor position in the Source window or Assemble window to the PC.
Break Point	Sets or cancels a breakpoint at the cursor position in the Source window or Assemble window.
Uncond. Trace ON	Validates unconditional trace so that trace can always be executed during program execution (default). The trace mode cannot be changed while the tracer is activated.
Cond. Trace ON	Validates conditional trace and traces in accordance with the trace condition during program execution. The trace mode cannot be changed while the tracer is activated.
Tracer Control Mode	Selects settings related to the tracer from the following menus:

Non Stop	Goes around the trace memory and overwrites data from the oldest frame (default).
Full Stop	Goes around the trace memory and then stops the tracer.
Full Break	Goes around the trace memory and then stops the tracer and program execution
Delay Trigger Stop	Traces data by the number of delay count frames and stops the tracer when a delay trigger event has occurred.
Delay Trigger Break	Traces data by the number of delay count frames and stops the tracer and program execution when a delay trigger event has occurred.
Coverage Start/ Coverage Stop	Starts coverage measurement when it is stopped, or stops it when it is in progress. This item is invalid if the program is not being executed or if the coverage function is OFF (if [Option] -> [Coverage ON] is not checked). Immediately after program execution has been started with the coverage function ON, coverage measurement is in progress.
Timer Start/ Timer Stop	Starts timer measurement when it is stopped, or stops it when it is in progress. This item is invalid if the program is not being executed, if a timer event is not used, and if the timer function is OFF (if [Option] -> [Timer ON] is not checked). Immediately after program execution has been started with the timer function ON, timer measurement is in progress.
Tracer Start/ Tracer Stop	Starts the tracer when it is stopped, or stops it when it is in progress. This item is invalid if the program is not being executed and if the trace function is OFF (if [Option] -> [Tracer ON] is not checked). Immediately after program execution has been started with the tracer function ON, the tracer is executed.

(6) [Event] menu

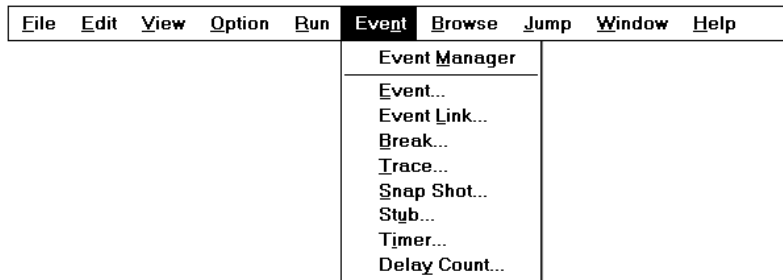

Event Manager	Manages various event conditions. Opens Event Manager. Same operation as the Mgr button
Event...	Registers an event condition. Opens Event dialog box. Same operation as the Evn button
Event Link...	Registers an event link condition. Opens Event Link dialog box.
Break...	Registers and sets a break condition. Opens Break dialog box. Same operation as the Brk button

Trace...	Registers and sets a trace event condition. Opens Trace dialog box. Same operation as the Trc button
Snap Shot...	Registers and sets a snap event condition. Opens Snap Shot dialog box.
Stub...	Registers and sets a stub event condition. Opens Stub dialog box.
Timer...	Registers and sets a timer event condition. Opens Timer dialog box. Same operation as the Tim button
Delay Count...	Sets a delay count and displays the delay value. Opens Delay Count dialog box.

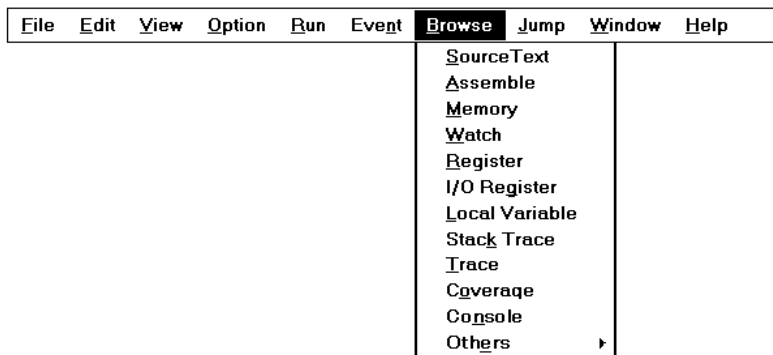
(7) **[Browse]** menu

Source Text	Displays a source text. Opens Source window. Same operation as the Src button If there is a Source Text window already open in the active status, it is opened in the static status.
Assemble	Displays the disassemble results. Opens Assemble window. Same operation as the Asm button If there is a Assemble window already open in the active status, it is opened in the static status.
Memory	Displays the contents of the memory. Opens Memory window. Same operation as the Mem button If there is a Memory window already open in the active status, it is opened in the static status.
Watch	Displays the watch contents. Opens Watch window. Same operation as the Wch button
Register	Displays the register contents. Opens Register window. Same operation as the Reg button
I/O Register	Displays the contents of the Peripheral I/O registers. Opens IOR window. Same operation as the IOR button

Local Variable	Displays the local variable. Opens Local Variable window. Same operation as the Loc button
Stack Trace	Displays the stack trace results. Opens Stack Trace window. Same operation as the Stk button
Trace	Displays the trace results. Opens Trace window. Same operation as the TrW button
Coverage	Displays coverage measurement results. Opens Coverage window. Same operation as the Cov button.
Console	Opens Console window.
Others	Displays other windows. Displays a user-defined window list.

(8) [Jump] menu

File	Edit	View	Option	Run	Event	Browse	Jump	Window	Help
							SourceText	Ctrl+U	
							Assemble	Ctrl+D	
							Memory	Ctrl+M	
							Coverage	Ctrl+I	

Source Text	Displays the corresponding source text and source line, using the data value selected in the current window as the jump destination address. If no line information is at the jump destination address, however, you cannot jump. Opens Source window. If an active Source window is open, that window is displayed in the forefront (so that it can be manipulated).
Assemble	Disassembles and displays the results from the jump destination address specified by the data value selected in the current window. Opens Assemble window. If an active Assemble window is open, that window is displayed in the forefront (so that it can be manipulated).
Memory	Displays the memory contents from the jump destination address specified by the data value selected in the current window. Opens Memory window. If an active Memory window is open, that window is displayed in the forefront (so that it can be manipulated).
Coverage	Displays coverage measurement results from the jump destination address specified by the data value selected in the current window. Opens Coverage window. If an active Coverage window is open, that window is displayed in the forefront (so that it can be manipulated).

(9) [Window] menu

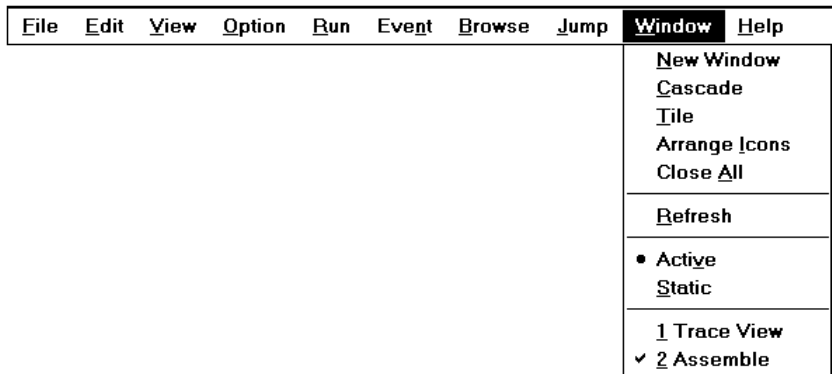

New Window	Opens a new window displaying the same contents as those of the current window. This menu is valid only when the current window is Source window, Assemble window, Memory window, or Coverage window.
Cascade	Cascade display of the windows in the Main window.
Tile	Tile display of the windows in the Main window.
Arrange Icons	Rearranges the icons in the Main window.
Close All	Closes all windows, except the Main window.
Refresh	Updates the contents of the window with the latest data.
Active	Sets the window in the active status. If the window is already in the active status, a check mark is shown on the left of this item.
Static	Sets the window in the static status. If the window is already in the static status, a check mark is shown on the left of this item.
(Open Window)	Lists the windows that are open. The window with the check mark shown on the side of the figure is the current window. By selecting a window name, the selected window is used as the current window.

(10) [Help] menu

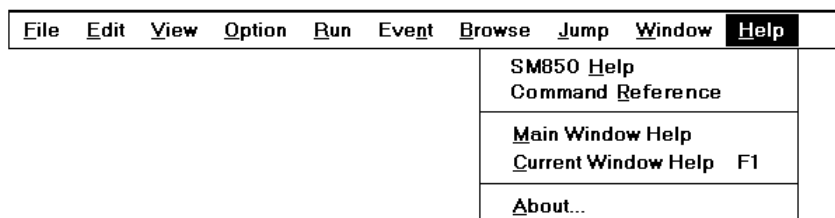

SM850 Help	Displays the help of SM850 .
Command Reference	Opens the Help window of COMMAND REFERENCE.
Main Window Help	Displays the help of the Main window.
Current Window Help	Displays the help of the current window.

About...	Displays the version of the debugger. Opens About dialog box.
--------------------------	--

Window display area

This area (at the center) displays various debug windows.

The displayed window can be changed in size or an icon can be created in this area.

Status bar

The status bar is displayed at the bottom of the window and indicates the status of the debugger and simulator.

While the user program is being executed, the status bar is displayed in red.

Whether the status bar is displayed or not can be selected by selecting [Option] -> [Status Bar] from the menu bar.

Figure 7-4 Status Bar

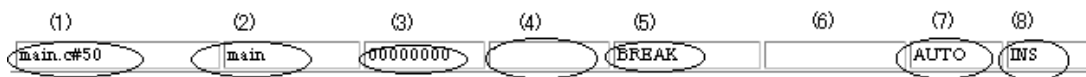

(1) Program name	Displays the program file name indicated by the PC value.
Source name	Displays the source file name indicated by the PC value.
Line number	Displays the line number indicated by the PC value.
(2) Function name	Displays the function name indicated by the PC value.
(3) PC value	Displays the current PC value.
(4) CPU status	Displays the status of the CPU (target device). (If there are two or more CPU statuses, they delimited with ' ' and displayed.) STANDBY... Stanby mode RESET... Reset status
(5) IE status	Displays the status of the simulator. (If there are two or more the statuses, they delimited with ' ' and displayed.) RUN... User program execution in progress (the color of the status bar changes). STEP... Step execution in progress TRC... Tracer operating TIM.. Timer operating COV... Coverage operation in progress BREAK... Break occurring.
(6) Break Cause	Displays Table 7-3 Break Cause.

(7) STEP mode	Displays the step execution mode. Displays that the following modes are selected from the [Option] menu: SRC...Source mode INST...Instruction mode AUTO...Automatic mode
(8) Key input mode	Displays the key input mode. INS... Insertion mode OVR...Overwrite mode The Memory window is fixed to OVR mode.

Table 7-3 Break Cause

Display	Meaning
Manual Break	Forced break
Temporary Break	Temporary break
Event Break	Break by event
Trace Full Break	Break due to trace full
Non Map Break	Non-mapped area is accessed.
Write Protect	An attempt has been made to write to a write-protected area.
IOR Illegal	An illegal access is made to a peripheral I/O register.
Security Protect	A security protected area is accessed.

Configuration dialog box

This dialog box is used to display and set the operating environment of the simulator.

This dialog box is automatically displayed after the debugger is started up.

To use the debugger, the operating environment of the simulator must be first set in this dialog box.

However, no setting is required to read a project as the results of reading the project file are reflected in this dialog box.

Figure 7-5 Configuration Dialog Box

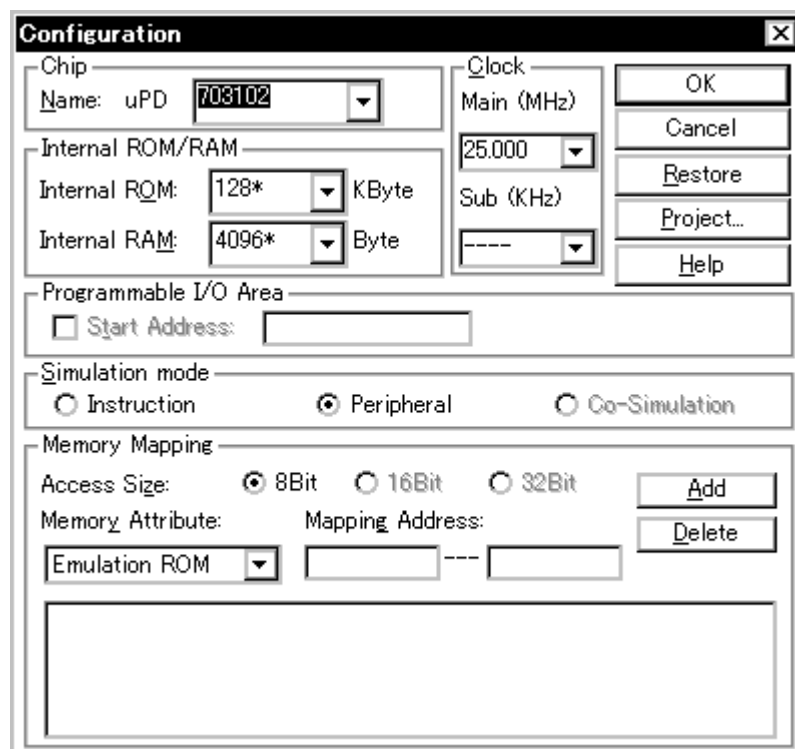

This section explains the following items:

- Opening
- Explanation of each area
 - Setting of memory mapping
- Function buttons

Opening

This dialog box can be opened as follows:

- Automatically when the debugger is started up
- Select [Option] -> [Configuration...] from the menu bar.
(or press Alt+O, and C in that order)

Explanation of each area

The Configuration dialog box consists of the following areas:

- (1) Chip (CPU selection area)
- (2) Internal ROM/RAM (internal ROM/RAM setting area)
- (3) Programmable I/O Area (programmable I/O area address setting area)
- (4) Clock (CPU clock source selection area)
- (5) Simulation mode (simulation mode selection area)
- (6) Memory Mapping (mapping setting area)

(1) Chip (CPU selection area)

This area is used to select the CPU.

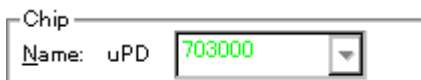

Only the chip names registered to a registry by the DFINST utility are listed.

Specify a chip name from the drop-down list under [Name](#).

A chip name can be specified only when the debugger is started up. The chip name selected at the previous startup is selected by default. If the chip name is not stored, the top chip name that is registered is selected by default.

(2) Internal ROM/RAM (internal ROM/RAM setting area)

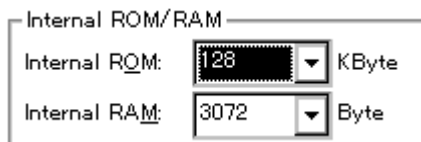

This area is used to set the size of the internal RAM and internal ROM of the CPU.

The default value is automatically displayed with "*" suffixed, when [Chip](#) is selected.

To change the size of the internal RAM and internal ROM, select the size from the drop-down list under Internal RAM and Internal ROM.

If the selected size cannot be implemented because of the constraints of the simulator, the debugger automatically adjusts the size (therefore, a size larger than that previously specified may be displayed when the Configuration dialog box is displayed again).

The settable sizes are as follows:

Table 7-4 Settable Sizes as Internal ROM/RAM

Models	Internal ROM Both Alignment and Settable Range (KByte)	Internal RAM Both Alignment and Settable Range (Byte)
V850	0, 32, 64, 128, 256, 512, 1024	1024, 2048, 3072, 4096, 6144, 8192, 10240, 12288, 16384, 20480, 24576, 28672
V850E	0, 32, 64, 128, 256, 512, 1024	1024, 2048, 3072, 4096, 6144, 8192, 10240, 12288, 16384, 20480, 24576, 28672, 36864, 45056, 53248, 61440

If the internal RAM size is changed, the internal RAM's start address shifts as shown below:

Table 7-5 Size of Internal RAM and Start Address

Types	Internal RAM Size (Bytes)	Start Address of Internal RAM
V85X, V850/XXX	1 to 4096	0xFFE000
	to 12288	0xFFC000
	to 28672	0xFF8000
V850E/MS1	1 to 4096	0x3FFE000
	to 12288	0x3FFC000
	to 28672	0x3FF8000
	to 61440	0x3FF0000
V850ES	1 to 4096	Depends on the device
	to 12288	
	to 28672	
	to 61440	

(3) Programmable I/O Area (programmable I/O area address setting area)

Programmable I/O Area Start Address:

This area is used to specify usage of the programmable I/O area and the start address.

If programmable I/O is used for a device that supports the programmable I/O, the start address can be specified via keyboard input when the check box is checked. The address is aligned to 16 KB.

If the device has an extended I/O area whose address is fixed, the address setting and the check are executed automatically.

(4) Clock (CPU clock source selection area)

This area is used to select a clock source to be input to the CPU.

(5) Simulation mode (simulation mode selection area)

This area is used to select an operation mode of the simulator from the following:

Instruction	Instruction operation mode Peripheral simulation is not performed ^{Note} .
Peripheral	Peripheral operation mode (default) Peripheral simulation is performed. This mode can be selected if the target device is the V851, V852, V853, or V854.
Co-Simulation	Cannot be selected.

The operation mode can be switched between these during debugging.

Note Peripheral simulation is performed in the instruction operation mode when a device other than the V851, V852, V853, and V854 is selected. For details, refer to "Supply of simulation operation modes" and the document supplied with the product.

(6) Memory Mapping (mapping setting area)

This area is used to set mapping by specifying the access size, memory attribute, and address.

Access Size (selection of memory access size)

Selects memory access size. Fixed to 8 bit

8Bit	Accesses memory with ld.b instruction/st.b instruction.
------	---

Memory Attribute (mapping attribute specification)

The following mapping attributes can be selected. Select a mapping attribute according to the usage .

Emulation ROM	Selects the simulator alternate ROM.
Emulation RAM	Selects the simulator alternate RAM.

Mapping Address (mapping address specification)

Specify the address to be mapped.

Input the higher and lower addresses from the keyboard.

Setting of memory mapping

Specify [Memory Attribute](#) and [Mapping Address](#) and then click the <Add> button.

-> The attribute of [Memory Attribute](#), address range of [Memory Mapping](#), and memory mapping corresponding to the data of the bus width are set and displayed on a list.

For mapping attributes, the mapping units are adjusted when the <Add> button is clicked. If the mapping unit does not match, the minimum settable range including the specified address is mapped.

The mapping unit is as follows:

Table 7-6 Mapping Unit in Configuration Dialog Box

Mapping Area	Mapping Unit
Emulation ROM Emulation RAM	In 64 KB units Because the simulator secures an alternate memory on the host computer on which it operates, the size of mapping depends on the size of the memory and virtual memory mounted on the host computer. If a ROMless product is selected with the V850 Series, memory can be mapped to 0xFFFFF.

Deleting memory mapping

Select mapping to be deleted from the list and click the <Delete> button.

-> This deletes the selected mapping.

Function buttons

OK	Validates the current environment. Sets the environment and closes this dialog box. If an error occurs after clicking the <OK> button, the debugger can no longer continue and is terminated.
Cancel	Cancels the changes and closes this dialog box.
Restore	Restores the previous environment settings status before this dialog box was opened.
Project...	Opens the Project File Load dialog box. If an error occurs while a project file is being opened or read, the debugger can no longer continue and is terminated.
Help	Opens the Help window.

Extended Option dialog box

This dialog box is used to display and set the extended options of the debugger.

Figure 7-6 Extended Option Dialog Box

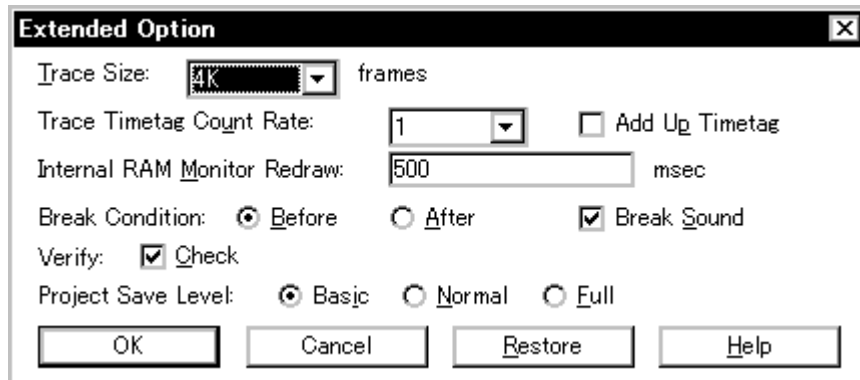

This section explains the following items:

- Opening
- Explanation of each area
- Function buttons

Opening

This dialog box can be opened as follows:

- Select [Option] ->[Extended Option...] from the menu bar.
(or press Alt+O, and X in that order.)

Explanation of each area

The Extended Option dialog box consists of the following areas:

- (1) Trace Timetag Count Rate (trace time tag counter division ratio selection area)
- (2) Trace Size (trace buffer size setting area)
- (3) Add Up Timetag (total time tag specification area)
- (4) Internal RAM Monitor Redraw (real-time internal RAM sampling time setting area)
- (5) Break condition (break mode setting area)
- (6) Break Sound (beep sound specification area)
- (7) Verify Check (verify specification area)
- (8) Project Save Level (project save level selection area)

(1) Trace Timetag Count Rate (trace time tag counter division ratio selection area)Trace Timetag Count Rate: 

This area is used to set the division ratio of the counter used for time tag display in Trace window.

If the division ratio is set, the number of clocks necessary for counting up the counter displayed for time tag is changed.

The selectable division ratios are 1 (default value), 2, 4, 8, 16, 32, 64, 128, 256, 512, 1K, 4K, 8K, 16K, 64K, 256K, or 1M.

(2) Trace Size (trace buffer size setting area)Trace Size:  frames

This area is used to set the size (frame units) in which execution of the user program is to be traced.

The following sizes can be set:

Frame Size	Setting Unit
0 to 64K	4K
64K to 1M	64K
1M to 6M	1M

(3) Add Up Timetag (total time tag specification area) Add Up Timetag

This area is used to specify whether time tags of trace data are totaled or not.

This check box is not checked by default, and the time tags are not totaled.

(4) Internal RAM Monitor Redraw (real-time internal RAM sampling time setting area)Internal RAM Monitor Redraw: msec

This area is used to specify the sampling time (msec) for real-time internal RAM sampling.

The internal RAM area can be sampled in real time during simulation.

The variables and data allocated to this area can be displayed in close to real time in Watch window and Memory window.

The sampling time can be specified in a range of 0 to 65500 in units of 100 msec. If 0 is specified, or if this area is blank, the sampling time is not displayed in real time.

(5) Break condition (break mode setting area)Break Condition: Before After

This area is used to select whether a break occurs before or after the instruction of a breakpoint is executed. This setting affects only hardware breaks.

Before	Sets a Run event as an event before executing (default). The event occurs before the instruction is executed.
After	Sets a Run event as an event after executing. The event occurs after the instruction is executed.

(6) Break Sound (beep sound specification area) Break Sound

This area is used to specify whether a beep sound is issued upon the occurrence of a break. If the check box is checked, a beep sound is issued when a break occurs (default).

(7) Verify Check (verify specification area) Verify Check

This area is used to specify whether a verify check is performed when data has been written to memory.

If the check box is checked, a verify check is performed when download, memory fill, or memory copy is executed (default). A verify check is also performed when a variable or data is changed in Watch window or Memory window and is written to memory.

(8) Project Save Level (project save level selection area)Project Save Level: Basic Normal Full

This area is used to select the save level of a project file related to the simulator.

Basic	Saves only the user-set debug environment (such as window status and event setting status) (default).
Normal	Saves the contents of Basic and the status of the internal instructions of the simulator (project information such as instructions, memory, registers, and peripheral I/O registers), which are stopped.
Full	Saves contents of Normal and all debug information generated during simulation (such as trace and coverage results).

Function buttons

OK	Validates the settings and closes this dialog box.
Cancel	Cancels the settings and closes this dialog box.
Restore	Restores the previous settings before this dialog box was opened.
Help	Opens the Help window.

Debugger Option dialog box

This dialog box is used to display and set the extended options of the debugger.

Figure 7-7 Debugger Option Dialog Box

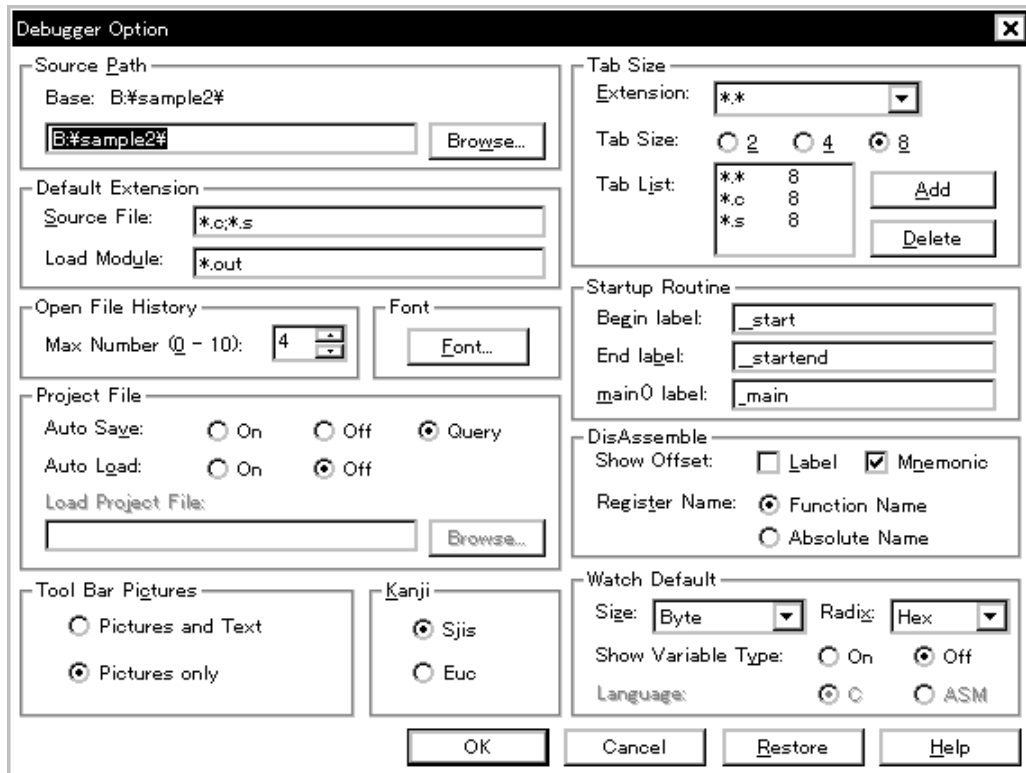

This section explains the following items:

- Opening
- Explanation of each area
- Function buttons

Opening

This dialog box can be opened as follows:

- Select [Option] -> [Debugger Option...] from the menu bar (or press Alt+O, and G in that order).

Explanation of each area

The Debugger Option dialog box consists of the following areas:

- (1) Source Path (source path specification area)
- (2) Default Extension (default extension specification area)
- (3) Open File History (open file history setting area)
- (4) Font (display font setting area)
- (5) Project File (project file setting area)
- (6) Tool Bar Pictures (toolbar display button setting area)
- (7) Kanji (Kanji code setting area)
- (8) Tab Size (tab size setting area)
- (9) Startup Routine (start-up symbol setting area)
- (10) DisAssemble (offset display setting area)
- (11) Watch Default (watch symbol setting area)

(1) **Source Path (source path specification area)**

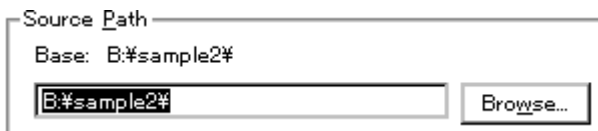

This area is used to specify the directory in which a source file or text file is searched.

A path can be input from the keyboard or set by the <Browse...> button. A relative path can also be specified.

The directory that is the basis of a relative path is displayed on the right of **Base:**. The base directory is determined in the following sequence:

- Directory to which the project file has been loaded
- Directory to which a load module or hex file has been loaded last
- Current directory of Windows

To delimit paths, use ";" (semicolon) or "," (comma).

Japanese characters can be specified in a source path (Japanese version only).

Example: If a source is in the following directory

B:\src

C:\asm

The source path is specified as follows:

B:\src; C:\asm

Clicking the <Browse...> button displays the Add Source Path dialog box shown in Figure 7-8, and a source path can be added.

Reference Immediately after the Debugger Option dialog box has been opened, the base directory is selected and opened

If the selected directory has already been set for the source path, a source path is not added.

Figure 7-8 Add Source path Dialog Box

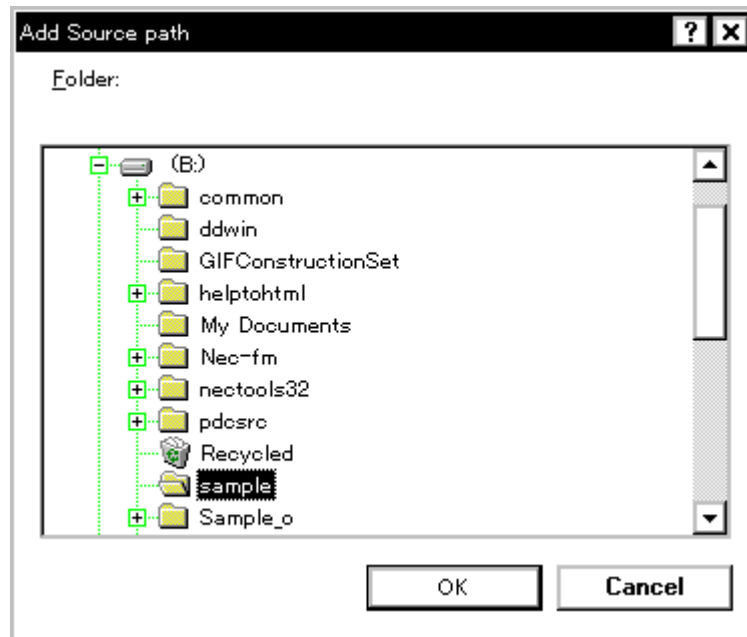

(2) **Default Extension** (default extension specification area)

Default Extension

Source File:

Load Module:

Delimit extensions with " " (blank), ";" (semicolon) or "," (comma).

Source File	Set the extension of a source file that is displayed when the Browse dialog box is opened by selecting [File] -> [Open...] from the menu bar. The default extension is "*.C, *.S" .
Load Module	Set the extension of a load module that is displayed when Download dialog box is opened. The default extension is "*.OUT" .

(3) **Open File History** (open file history setting area)

Open File History

Max Number (0 - 10):

This area is used to set the number of histories (0 to 10) of the open file displayed in the bottom field of the [File] menu. If 0 is set, no history is displayed on the menu.

The default value is 4.

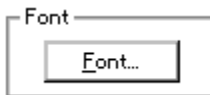
(4) Font (display font setting area)

This area is used to specify the font displayed on the Source window. Clicking the button opens the Font dialog box in which the font to be displayed and its size can be set.

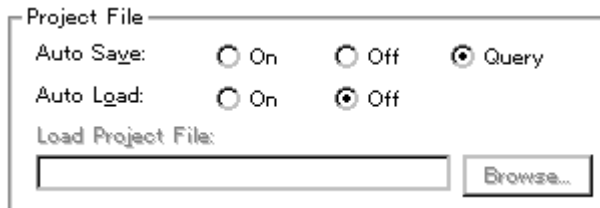
(5) Project File (project file setting area)

This area is used to set automatic saving and loading of the project file.

Auto save

Sets whether the project file is automatically saved at the SM850 termination.

On	Automatically saves the project file at the SM850 termination.
Off	Does not automatically save the project file at the SM850 termination.
Query	Displays the Exit Debugger dialog box at the SM850 termination (default).

Auto Load

Sets whether the project file is automatically loaded at the SM850 start up.

On	Automatically loads the project file at the SM850 start up. Sets whether the Load Project File is automatically loaded
Off	Does not automatically loads the project file at the SM850 start up. (default)

Load Project File

Specify the project file to be loaded automatically.

This item can be specified only when [On](#) is specified for [Auto Load](#).

Set a project file name by inputting from the keyboard or clicking the <Browse...> button. Clicking the <Browse...> button displays Browse dialog box.

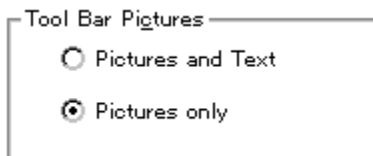
(6) Tool Bar Pictures (toolbar display button setting area)

This area sets the buttons to be displayed on the toolbar.

Pictures and Text	Displays a button on which a graphic and character are displayed.
Pictures only	Displays a button with only graphic (default).

(7) Kanji (Kanji code setting area)

This area is used to specify Kanji codes to be displayed in the Source window and Trace window.

Kanji codes can be specified only on the Japanese Windows.

Sjis	Uses SJIS as Kanji codes (default).
Euc	Uses EUC as Kanji codes.

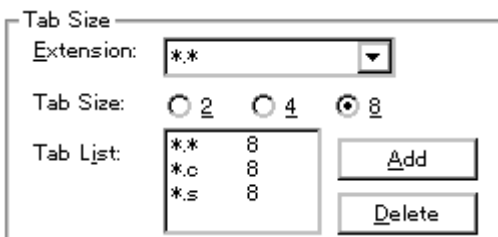
(8) Tab Size (tab size setting area)

This area is used to set the tab size for each extension when files are displayed.

Extension

Set an extension. Input an extension from the keyboard, or select one from the drop-down list.

Tab Size

Select the tab size. Select how many spaces are displayed as a tab code.

2	Displays two spaces.
4	Displays four spaces.
8	Displays eight spaces.

Tab List

Displays the tab size set for each extension.

To change the tab size setting,

select **Extension** and **Tab Size** and click the <Add> button.

The selected tab size is changed to the tab size set in **Extension**.

To delete the tab size setting,

select the setting to be deleted from **Tab List** and click <Delete> button.

The setting of the extension currently selected will be deleted.

(9) Startup Routine (start-up symbol setting area)

This area is used to specify the first address and end address of the text area (code area) of the start-up routine by symbols.

Specify the symbol of the first address as **Begin label**, and the symbol of the last address as **End label**.

In this way, the source file can be automatically opened if an object file in the load module format is downloaded in Download dialog box. Specify the source file to be displayed at this time as **main() label**, as a display start symbol.

If the specified symbol is not correct, the source file cannot be opened until the PC reaches the address range of the corresponding source file. In addition, the start-up routine cannot be skipped by step execution.

Begin label	Symbol of first address (default: <code>_start</code>)
End label	Symbol of end address (default: <code>_startend</code>)
main() label	Display start symbol (default: <code>_main</code>)

Caution Be sure to specify this area. If this area is blank, the dialog box cannot be closed.

(10) DisAssemble (offset display setting area)

Performs the setting for disassemble display.

Show Offset

Specifies whether an offset (symbol + offset) is displayed during disassemble display.

When the offset is not displayed, only a symbol that matches a numeric value is displayed, if any. If no matching symbol is found, the numeric value is displayed as a hexadecimal number unchanged.

Label	Specifies whether the offset is displayed in the Label field. This check box is not checked in the default condition, and the offset is not displayed.
Mnemonic	Specifies whether the offset is displayed in the Mnemonic field. This check box is checked in the default condition, and the offset is displayed.

Register Name (register name display selection area)

This area is used to select the method of displaying register names in mnemonics during disassemble display.

Function Name	Displays register names as function names or nicknames.
Absolute Name	Displays register names as absolute names.

(11) Watch Default (watch symbol setting area)

Watch Default

Size: Radix:

Show Variable Type: On Off

Language: C ASM

This area is used to specify a symbol to be watched.

Size (default size specification)

Sets the display size of data if [Adaptive] is selected in Watch window.

Byte	8-bit display(default)
Half Word	16-bit display
Word	32-bit display

Radix (default radix specification)

Sets the default radix in which data is to be displayed if [Proper] is specified in Watch window.

Hex	Displays data in hexadecimal numbers (default).
Dec	Displays data in decimal numbers.
Oct	Displays data in octal numbers.
Bin	Displays data in binary numbers.
String	Character string

Show Variable Type (display/non-display of variable type)

Selects whether the type of a variable is displayed or not.

On	Displays the type of a variable.
--------------------	----------------------------------

Off	Does not display the type of a variable (default).
-----	--

Language (display/non-display of type of variable)

Selects the display format of the base number.

With the V800, the display format is fixed to C-like and cannot be selected.

C	Displays a C-like base number (default).
ASM	Displays an assembly language-like base number.

Function buttons

OK	Validates the settings and closes this dialog box.
Cancel	Cancel the settings and closes this dialog box.
Restore	Restores the previous settings before this dialog box was opened.
Help	Opens the Help window.

Font dialog box

This dialog box is used to select the font to be displayed in the Source window.

Figure 7-9 Font Dialog Box

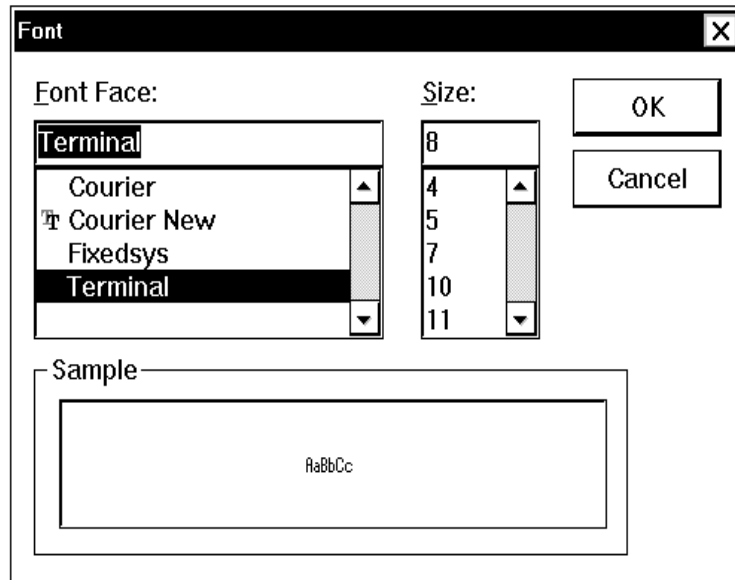

This section explains the following items:

- Opening
- Explanation of each area
- Function buttons

Opening

This dialog box can be opened as follows:

- Click the button in Debugger Option dialog box.

Explanation of each area

The Font dialog box consists of the following areas:

- (1) Font Face: (font name specification area)
- (2) Size: (font size specification area)
- (3) Sample (sample display area)

(1) Font Face: (font name specification area)

Font Face:

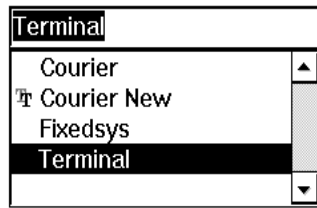

This area is used to select a font from the fonts currently usable.

Only fonts with equal width (fonts with a constant stroke width and a fixed pitch) are enumerated.

When a font name is selected from the list, the font name is displayed in the text box, and the font size that can be used with that font is displayed under [Size](#).

(2) Size: (font size specification area)

Size:

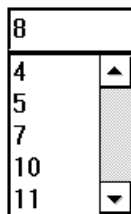

This area is used to specify the font size.

On the drop-down list, the font size usable for the font specified in [Font Face](#) is displayed in point units.

When the font size is selected from the drop-down list, the selected font size is displayed in this area.

The font size can also be directly input to the text box from the keyboard.

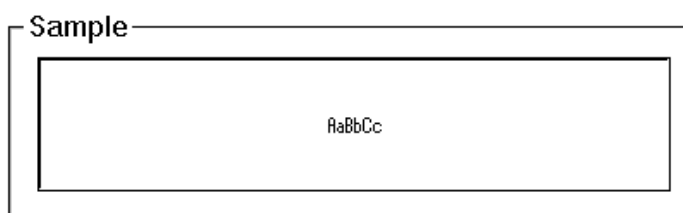
(3) Sample (sample display area)

This area displays a sample character string of the specified font and size.

Function buttons

OK	Changes the font and its size in the Source window as specified, and closes this dialog box.
Cancel	Closes the dialog box without changing the font.

Project File Save dialog box

Saves the debug environment.

It is used to save a new project file or an existing file with the file name changed (refer to "Setting Debugging Environment").

When a file is saved, the size and position of the window that has been displayed are also saved.

Figure 7-10 Project File Save Dialog Box

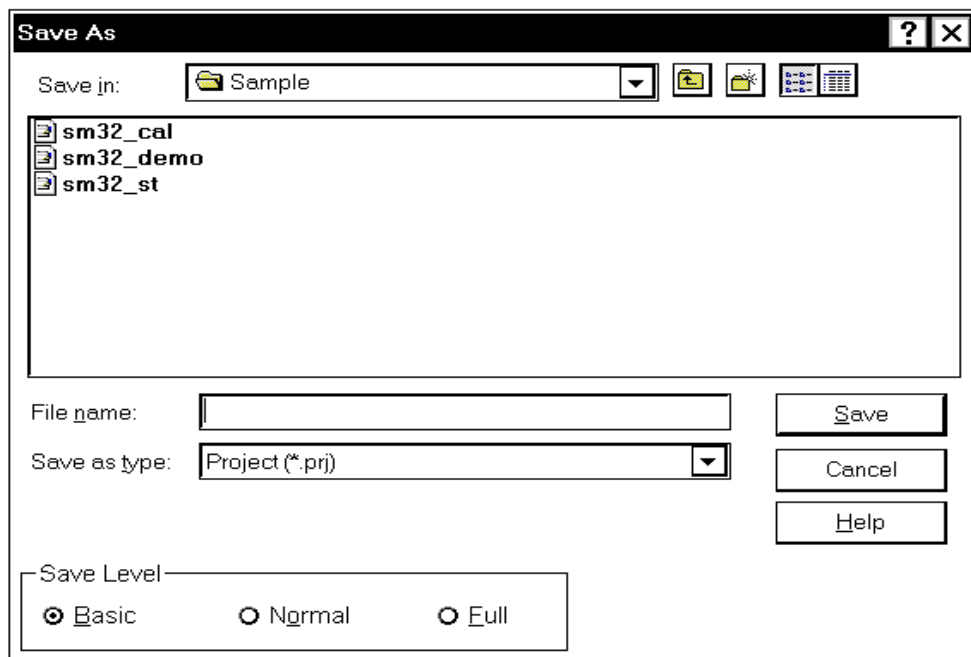

The following contents are saved to the project file:

Table 7-7 Contents Saved to Project File

Window Name	Set Data
Configuration dialog box	All items (target device, clock setting, pin mask setting, mapping information)
Main window	Display position, tool bar/status bar/button display information, execution mode, information, trace on/off information, coverage on/off information
Download dialog box	File information to be downloaded
Extended Option dialog box, Debugger Option dialog box	Set information
Source window	Display information, font information of window
Assemble window, Memory window	Display information of window, display start address

Table 7-7 Contents Saved to Project File

Window Name	Set Data
Stack Trace window, IOR window, Local Variable window, Trace window, Event Manager, Coverage window, Console window, Expansion window	Display information of window
Event dialog box	Display information of window, event information
Event Link dialog box	Display information of window, link event information
Break dialog box	Display information of window, break event information
Trace window	Display information of window, trace event information
Snap Shot dialog box	Display information of window, snap event information
Stub dialog box	Display information of window, stub event information
Timer dialog box	Display information of window, timer event information
Register window	Display information of window, display bank information
Watch window	Display information of window, watch registration information
Add I/O Port dialog box	Added I/O port information
DMM dialog box	DMM information
Delay Count dialog box	Delay count value
V850 Simulator GUI window, Parts window, Output Timing Chart window	Display information of window, pin status

This section explains the following items:

- Opening
- Explanation of each area
- Function buttons
- Related operations
 - To automatically save a project file

Opening

This dialog box can be opened as follows:

- Select [File] -> [Project] -> [Save As...] from the menu bar (or press Alt+F, J and A in that order).

To save a file of same name as a project file previously loaded or saved

- Select [File] -> [Project] -> [Save...] on the menu bar (or press Alt+F, J and S in that order).

Explanation of each area

The Project File Save dialog box consists of the following areas:

- (1) Save in:, File name: (file selection area)
- (2) Save as type: (extension selection area)
- (3) Save Level (save level selection area)

(1) Save in:, File name: (file selection area)

This area is used to specify a file name. A file name can be directly input from the keyboard, or selected from the list at the upper part of this area.

Up to 64 character string with a extension can be specified.

(2) Save as type: (extension selection area)

This area is used to specify the extension (.PRJ) of the project file to be loaded.

If the extension is omitted, .PRJ is appended as the default extension.

(3) Save Level (save level selection area)

The image shows a rectangular dialog box titled "Save Level". Inside the box, there are three radio button options: "Basic" (which is selected with a filled circle), "Normal" (with an empty circle), and "Full" (with an empty circle).

This area is used to select the save level of a project file related to the simulator.

Basic	Saves only the user-set debug environment (such as window status and event setting status).
Normal	Saves the contents of Basic and the status of the internal instructions of the simulator (project information such as instructions, memory, registers, and peripheral I/O registers), which are stopped.
Full	Saves contents of Normal and all debug information generated during simulation (such as trace and coverage results).

In the default condition, the save level specified in Extended Option dialog box is assumed. If the save level is changed, it is reflected in the Extended Option dialog box.

Function buttons

Save	Saves the project information to the selected file. After saving, the dialog box is closed.
Cancel	Closes this dialog box without saving the file.
Help	Opens the Help window.

Related operations

To automatically save a project file

Use Project File (project file setting area) in Debugger Option dialog box that is opened when [Option] -> [Debugger Option...] is selected from the menu bar.

Select On for Auto Save in this area. The current environment will be automatically saved to the project file when the dialog box is closed.

Project File Load dialog box

This dialog box is used to return the debug environment to the previous environment.

After a file has been loaded, the size and position of the window is returned to the previous status (status saved to a project file) (refer to "Setting Debugging Environment").

After a project file has been loaded, it is displayed on the top of an active Source window if any.

By loading the project file, the items to be saved in Table 7-7 Contents Saved to Project File are set.

Caution If a project file different from the target device after the debugger has been loaded is loaded, the debugger loads the project file after it has been reset (the debugger is then used as the target device specified by the project file).

Figure 7-11 Project File Load Dialog Box

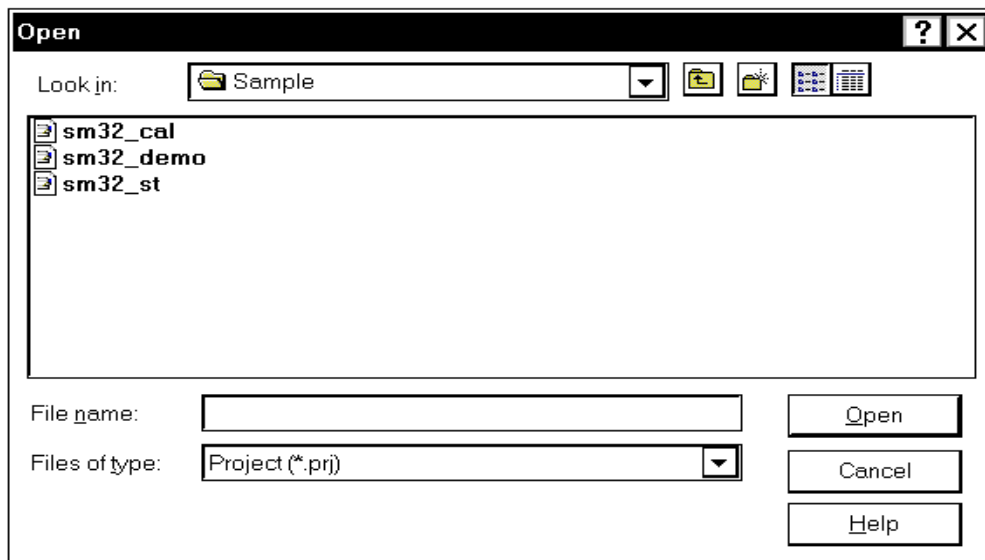

This section explains the following items:

- Opening
- Explanation of each area
- Function buttons
- Related operations
 - To automatically load a project file

Opening

This dialog box can be opened as follows:

- Click the Proj button.
- Select [File] -> [Project] -> [Open...] on the menu bar (or press Alt+F, J and O in that order).

Explanation of each area

The Project File Load dialog box consists of the following areas:

- (1) Look In: , File name: (file selection area)
- (2) Files of type: (extension selection area)

(1) Look In: , File name: (file selection area)

This area is used to specify a file name. A file name can be directly input from the keyboard, or selected from the list at the upper part of this area.

Up to 64 character string with a extension can be specified.

(2) Files of type: (extension selection area)

This area is used to specify the extension (.PRJ) of the project file to be loaded.

Function buttons

Open	Loads the selected file. After loading the file, this dialog box is closed.
Cancel	Closes this dialog box without loading the file.
Help	Opens the Help window.

Related operations

To automatically load a project file

Use Project File (project file setting area) in Debugger Option dialog box that is opened when [Option] -> [Debugger Option...] is selected from the menu bar.

Select On for Auto Load in this area and specify the name of the project file to be loaded automatically in the Load Project File area. The specified project file will be automatically loaded when the system is started next time.

View File Save dialog box

This dialog box is used to save the contents of the current window to a view file or event setting file when a dialog box is opened.

Figure 7-12 View File Save Dialog Box
View File Save Dialog Box (Example: to Save Assemble Window)

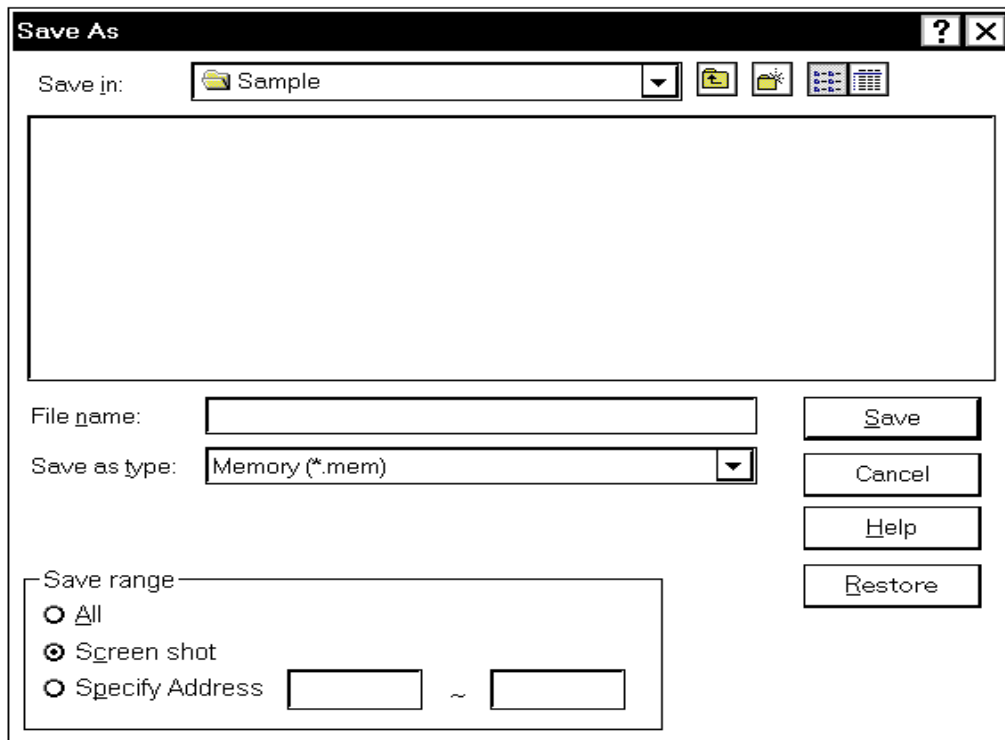

This section explains the following items:

- Opening
- Explanation of each area
- Function buttons

Opening

This dialog box can be opened as follows:

- When the window to be saved is the current window
Select [File] -> [Save As...] from the menu bar
(or press Alt+F and A in that order).

Explanation of each area

This dialog box consists of the following areas:

- (1) Save in:, File name: (file selection area)
- (2) Save as type: (extension selection area)
- (3) Save range (save range setting area)

(1) Save in:, File name: (file selection area)

This area is used to specify a file name. A file name can be directly input from the keyboard, or selected from the list at the upper part of this area.

(2) Save as type: (extension selection area)

This area is used to specify the type (extension) of the file.

The extension of the file corresponding to the current window is displayed as follows:

Table 7-8 Extension Corresponding to Current Window

File Type (Extension)	Current Window Name
Source Text (*.SVW)	Source window
Assemble (*.DIS)	Assemble window
Memory (*.MEM)	Memory window
Watch(*.WCH)	Watch window
Register (*RGW)	Register window
I/O Register (*.IOR)	IOR window
Local Variable (*.LOC)	Local Variable window
Stack Trace (*.STK)	Stack Trace window
Trace (*.TVW)	Trace window
Coverage (*.COV)	Coverage window
Event(*.EVN)	Event Manager
Console (*.LOG)	Console window
All (*.*)	All files

(3) Save range (save range setting area)

Save range

All

Screen shot

Specify Address ~

This area is displayed if the current window to be saved is the Assemble window, Memory window, Coverage window, Source window, or Trace window.

Specify the range of data to be saved by selecting any of the following:

All	Saves the entire range, from the first line to the last line.
Screen shot	Saves the area visible on the screen, from the top line on the screen to the bottom line. If the Source window is in the mixed display mode, however, the window contents are saved from the source line that includes the area visible on the screen.
Specify Line Specify Frame Specify Address above any	Specify the start line and end line of the area to be saved. If the start line and end line are omitted, the first line and last line are assumed. For details, it is as follows.

Specify Line (if current window is Source window)

Specify Line ~

Specify the range of the line numbers to be saved. The default radix for inputting a numeric value is decimal.

If the Source window is in the mixed display mode, the mixed displayed part on the specified line is also saved.

If a range of 100 lines or more is specified, a message dialog box is displayed to indicate the progress of saving. To stop saving midway, click the <Stop> button in the message dialog box.

Specify Frame (if current window is Trace window)

Specify Frame ~

Specify the range of trace frames to be saved (for how to specify, refer to "Trace Move dialog box").

The default radix for inputting a numeric value is hexadecimal.

If a range of 100 frames or more is specified, a message dialog box is displayed to indicate the progress of saving. To stop saving midway, click the <Stop> button in the message dialog box.

Specify Address (if current window is Assemble window, Memory window, or Coverage window)

Specify Address ~

This area is used to specify the address range in which data is to be saved to the file. An address can be also specified by a symbol or expression (refer to "Table 7-14 Specifying Symbols"). The default radix for inputting a numeric value is hexadecimal.

If a range of 256 bytes or more is specified, a message dialog box is displayed to indicate the progress of saving. To stop saving midway, click the <Stop> button in the message dialog box.

Function buttons

Save	Saves the information of the current dialog box to the selected file. After saving, the dialog box is closed.
Cancel	Closes this dialog box without saving the file.
Help	Opens the Help window.
Restore	Restores the status before this dialog box was opened.

View File Load dialog box

This dialog box is used to read the view file, source file, text file, event setting file, watch setting file, or peripheral I/O register setting file saved in the View File Save dialog box, and open a window.

The window to be opened and its status differ as follows, depending on the file to be loaded.

Loading source file to which symbol information has been read

If there is a Source window in the active status, it is opened in the static status; otherwise, the Source window is opened in the active status.

Loading source file to which symbol information has not been read, or view file

A window of text-format files is opened in the Source window in the static status.

Loading event setting file

The Event Manager is opened, and the event setting contents will return to the previous environment.

Loading watch setting file

The Watch window is opened, and the watch setting contents will return to the previous environment.

Loading peripheral I/O register setting file

The IOR window is opened, and the peripheral I/O register setting contents will return to the previous environment.

Figure 7-13 View File Load Dialog Box

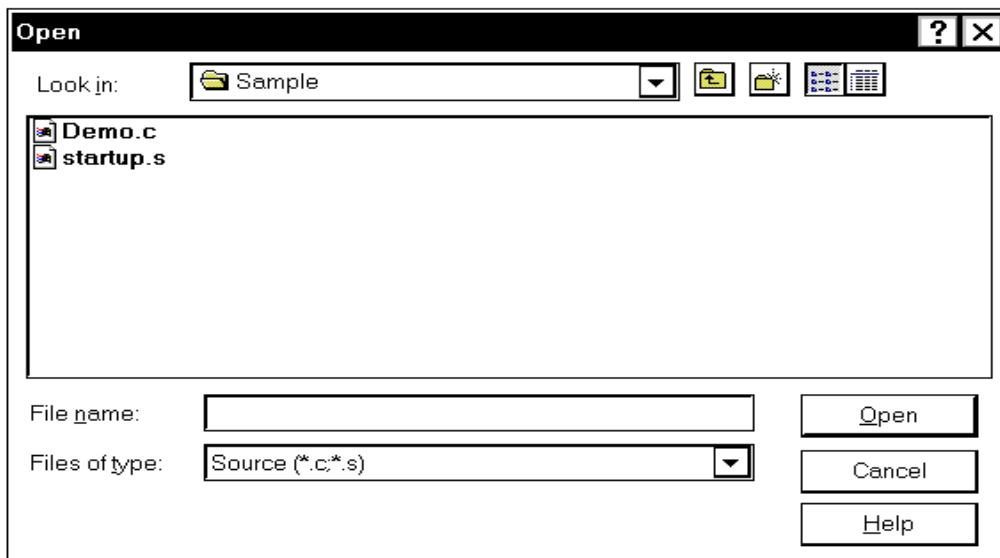

This section explains the following items:

- Opening
- Explanation of each area

- Function buttons

Opening

This dialog box can be opened as follows:

- Click the Open button.
- Select [Eile] -> [Open...] on the menu bar
(or press Alt+F and O in that order, or press Ctrl+O).

Explanation of each area

This dialog box consists of the following areas:

- (1) Look In: , File name: (file selection area)
- (2) Files of type: (extension selection area)

(1) Look In: , File name: (file selection area)

This area is used to specify a file name. A file name can be directly input from the keyboard, or selected from the list at the upper part of this area.

Up to 64 character string with a extension can be specified.

(2) Files of type: (extension selection area)

This area is used to specify the type (extension) of the file to be loaded.

Table 7-9 Type of File That Can Be Loaded on View File Load Dialog Box

File Type (Extension)	Meaning
Source (*.C, *.S)	Source file The extension of the source (c, s) can be changed in Debugger Option dialog box.
Text (*.TXT)	Text file
Source Text (*.SVW)	Source windowView files
Assemble (*.DIS)	Assemble window view files
Memory (*.MEM)	Memory window view files
Watch (*.WCH)	Watch window setting files
Register (*.RGW)	Register window view files
I/O Register (*.IOR)	IOR window setting files
Local Variable (*.LOC)	Local Variable window view files
Stack Trace (*.STK)	Stack Trace window view files
Trace (*.TVW)	Trace window view files
Coverage (*.COV)	Coverage window view files

Table 7-9 Type of File That Can Be Loaded on View File Load Dialog Box

File Type (Extension)	Meaning
Event (*.EVN)	Event setting file
Console (*.LOG)	Console window
All (*.*)	All files

Function buttons

Open	Loads the selected file. After loading the file, this dialog box is closed.
Cancel	Closes this dialog box without loading the file.
Help	Opens the Help window.

Download dialog box

This dialog box is used to select the name and format of a file to be downloaded, and downloads memory contents or coverage results to the simulator.

If an object file in the load module format has been downloaded, the corresponding source file is searched, and Source window is automatically opened.

Up to 20 load module files can be downloaded.

To check the loaded files, use Load Module List dialog box that is opened when [File] -> [Load Module] is selected from the menu bar.

Format of file that can be downloaded

- NEC load module format (ELF (.OUT))
- Intel Hex format (standard, extended)
- Motorola Hex format S type (S0, S2, S3, S7, S8)
- Extended Tektronix Hex format
- Binary data format
- Coverage result

Caution If a file other than an object file in the load module format is loaded, source debugging cannot be executed.

Figure 7-14 Download Dialog Box

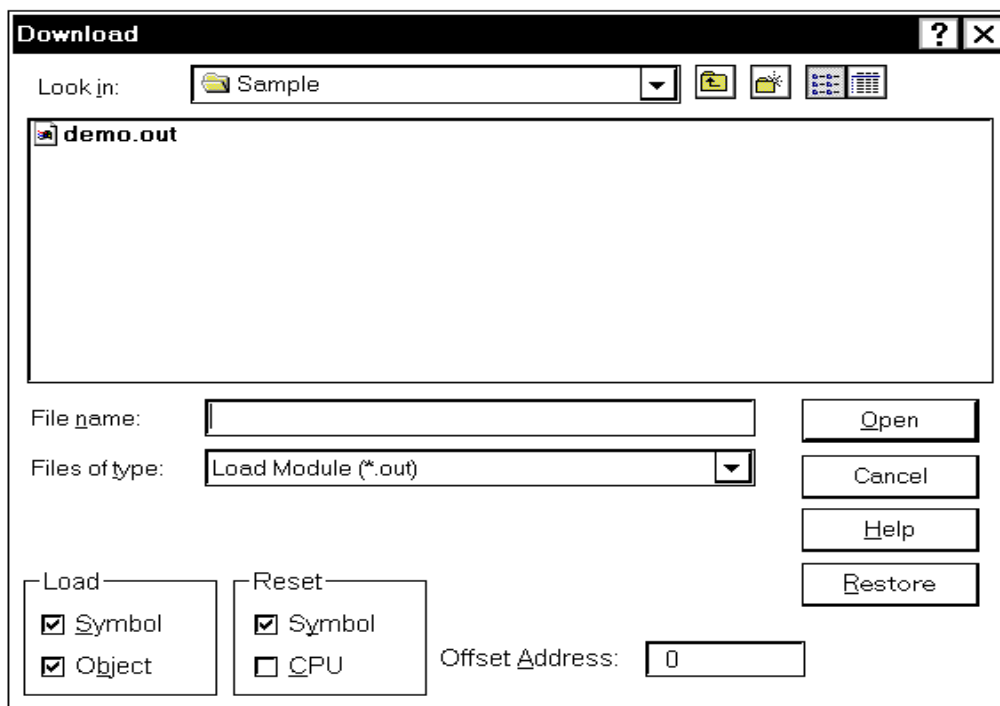

This section explains the following items:

- Opening
- Explanation of each area
- Function buttons
- Cancel processing

Opening

This dialog box can be opened as follows:

- Click the **Load** button.
- Select [File] -> [D]ownload... on the menu bar (or press Alt+F, and D in that order).

Explanation of each area

- (1) Look In: , File name: (file selection area)
- (2) Files of type: (extension selection area)
- (3) Offset Address: (offset setting area)
- (4) Load (load condition specification area)
- (5) Reset (reset condition specification area)

(1) Look In: , File name: (file selection area)

This area is used to specify a file name. A file name can be directly input from the keyboard, or selected from the list at the upper part of this area.

Two or more files can be specified in this dialog box. To specify two or more files, delimit each file name with " " (double quotation mark). Files can also be specified by clicking the mouse button while holding down the Shift or Ctrl key.

Up to 64 character string with a extension can be specified.

(2) Files of type: (extension selection area)

This area is used to specify the type (extension) of the file to be downloaded.

The contents displayed on the drop-down list are as follows:

Table 7-10 Type of File That Can Be Downloaded

Contents (extension)	Format
Load Module(*.OUT)	Load module format
Hex Format(*.HEX)	Hex format (automatic format identification)
Binary Data(*.BIN)	Binary data format

Table 7-10 Type of File That Can Be Downloaded

Contents (extension)	Format
Coverage (*.CVB)	Coverage result

Reference These are default extensions; other extensions can also be used.

The default extension of the displayed load module can also be specified under Default Extension (default extension specification area) in Debugger Option dialog box.

(3) **Offset Address: (offset setting area)**

Offset Address:

This area is used to specify the offset address that is used when a file is loaded (for binary data, specify the start address). An address can be also specified by a symbol or expression (refer to "Table 7-14 Specifying Symbols"). The default radix for inputting a numeric value is hexadecimal.

(4) **Load (load condition specification area)**

Load

Symbol

Object

This area is used to set a load condition.

This setting is valid only if a file in the load module format is specified.

Symbol	Specifies whether symbol information is read (when checked, default) or not. The memory capacity can be saved by not reading symbol information when a program consisting of two or more load module files is to be debugged and if the symbol information of some modules does not have to be read.
Object	Specifies whether object information is read (when checked, default) or not.

(5) **Reset (reset condition specification area)**

Reset

Symbol

CPU

This area is used to set a reset condition.

This setting is valid only if a file in the load module format is specified.

Symbol	Specifies whether symbol information is reset (when checked, default) or not. When debugging a program consisting of two or more load module files, load each one of the load module files without resetting the symbol information. When downloading two or more load module files, take care that location addresses do not overlap.
CPU	Specifies whether the CPU is reset or not (not checked, default).

Function buttons

Open	Loads the selected file. After loading the file, this dialog box is closed.
Cancel	Closes this dialog box without loading the file.
Help	Opens the Help window.
Restore	Restores the input data to the original status.

Cancel processing

The following dialog box appears while downloading and the downloading can be cancelled at any time.

The progress of the download is displayed in the dialog box.

This dialog box is closed automatically after completing downloading.

If an error occurs during the download, an error message will be displayed in a new window.

Figure 7-15 The Progress of Download

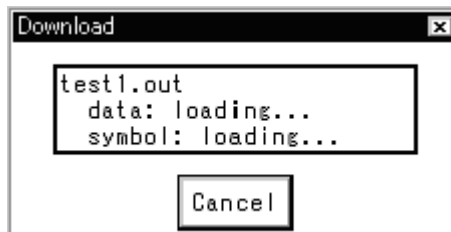

Upload dialog box

This dialog box is used to set the name and format of the file to which memory contents or coverage results are to be saved.

Format of specifiable file

- Intel Hex format (extended ... 20-bit address)
- Motorola Hex format (S0, S3, S7 ... 32-bit address)
- Extended Tektronix Hex format
- Binary data format
- Coverage result

Figure 7-16 Upload Dialog Box

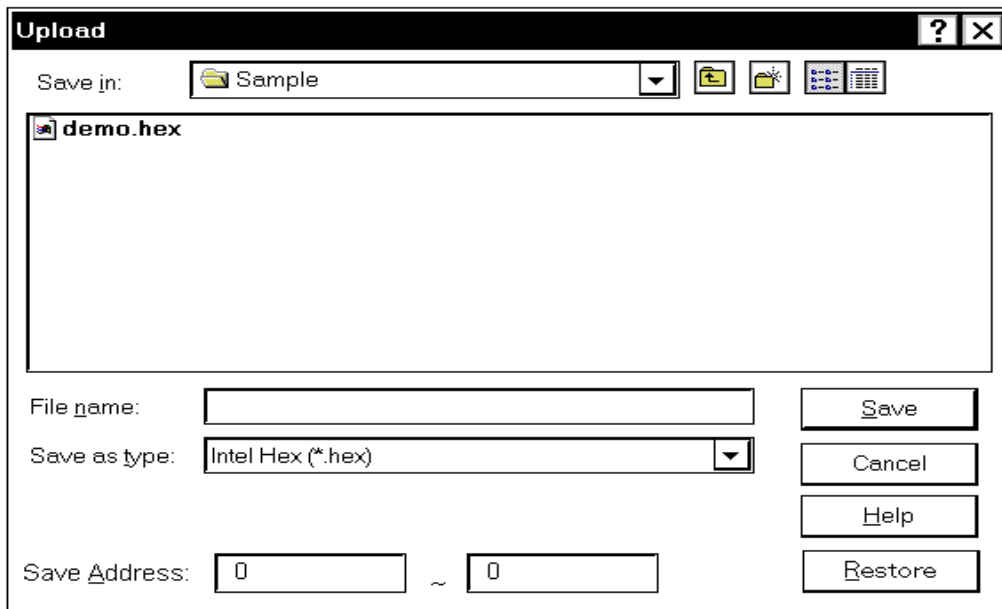

This section explains the following items:

- Opening
- Explanation of each area
- Function buttons

Opening

This dialog box can be opened as follows:

- Select [File] -> [Upload...] on the menu bar (or press Alt+F, and U in that order).

Explanation of each area

The Upload dialog box consists of the following areas:

- (1) Save in:, File name: (saved file name specification area)
- (2) Save as type: (extension selection area)
- (3) Save Address: (save range setting area)

(1) Save in:, File name: (saved file name specification area)

This area is used to specify a file name. A file name can be directly input from the keyboard, or selected from the list at the upper part of this area.

Up to 64 characters can be specified including the extension.

(2) Save as type: (extension selection area)

This area is used to specify the type (extension) of the file. The format of the data to be saved to the file is determined by the extension.

If "All (*.*)" is selected, however, the default Intel extended Hex format is selected. The contents displayed on the drop-down list are as follows:

Table 7-11 Type of File That Can Be Uploaded

Contents (extension)	Format
Intel Hex (*.HEX)	Intel extended Hex format
Motorola Hex (*.HEX)	Motorola Hex format
Tektro Hex (*.HEX)	Extended Tektronix Hex format
Binary Data (*.BIN)	Binary data format
Coverage (*.CVB)	Coverage result
All (*.*)	All files

Reference These are default extensions; other extensions can also be used.

(3) Save Address: (save range setting area)

Save Address: ~

This area is used to specify the address range in which data is to be saved to the file. An address can be also specified by a symbol or expression (refer to "Table 7-14 Specifying Symbols").

The default radix for inputting a numeric value is hexadecimal.

Function buttons

Save	Saves data in the specified address range to the specified file and closes this dialog box. Closes this dialog box. The font of the Source window is changed to the specified font face and font size, and then the dialog box is closed
Cancel	Closes this dialog box without saving the data to the file.
Help	Opens the Help window.
Restore	Restores the input data to the original status.

Load Module List dialog box

This dialog box can be used to check the file name and file path name of a load module that has already been downloaded. By using the <Download> button, The Download dialog box can be opened and a load module can be downloaded.

Figure 7-17 Load Module List Dialog Box

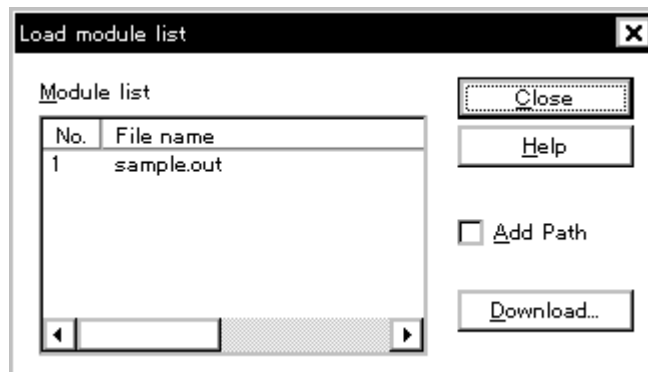

This section explains the following items:

- Opening
- Explanation of each area
- Function buttons

Opening

This dialog box can be opened as follows:

- Select [Eile] -> [Load Module...] on the menu bar (or press Alt+F, and L in that order).

Explanation of each area

The Load module list dialog box consists of the following items:

- (1) Module list (file name display area)
- (2) Add Path (path name addition check box)

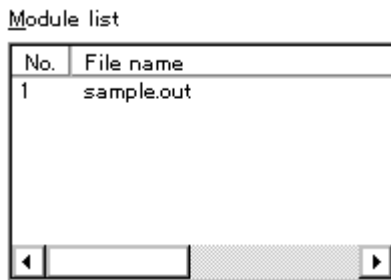
(1) Module list (file name display area)

This area displays the names of the load module files that have already been downloaded.

The numbers displayed in the "No." field indicate the sequence in which the load module file names were read. The file names are displayed with the full path if the path name addition check box is checked; otherwise, only the file names will be displayed.

If the file names do not fit in the screen, the screen can be scrolled by using the mouse or the arrow keys of the keyboard. If symbol information has been reset in the Reset Debugger dialog box, or if symbol information has been reset in the Download dialog box, the load module file names downloaded before that are cleared.

(2) Add Path (path name addition check box)

Add Path

This area is used to specify whether load module file names are displayed with the path (checked) or only file names are displayed (not checked, default) in the file name display area.

Function buttons

Close	Closes this dialog box.
Help	Opens the Help window.
Download...	Opens Download dialog box. A new load module can be downloaded. The file name of the newly downloaded module will be added to the file name display area when the Download dialog box is closed.

Browse dialog box

This dialog box is used to select the file to be set in the Source Search dialog box or the Source Text Move dialog box.

Reference If this dialog box is opened for the first time after the system has been started up, the directory first specified by the source path is displayed. When the dialog box is opened the second and subsequent times, the previously displayed directory is recorded and displayed again. If the <Cancel> button is pressed, however, the previously displayed directory is not recorded.

Figure 7-18 Browse Dialog Box

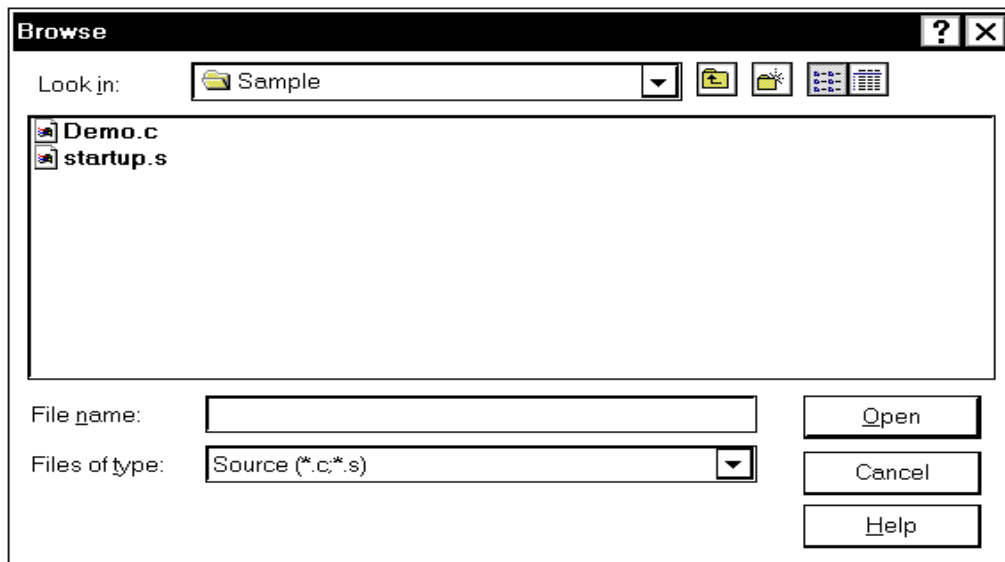

This section explains the following items:

- Opening
- Explanation of each area
- Function buttons

Opening

This dialog box can be opened as follows:

- Click the <Browse...> button in the Source Search dialog box or the Source Text Move dialog box.

Explanation of each area

The Browse dialog box consists of the following areas:

- (1) Look In: , File name: (file selection area)
- (2) Files of type: (extension selection area)

(1) Look In: , File name: (file selection area)

This area is used to specify a file name. A file name can be directly input from the keyboard, or selected from the list at the upper part of this area.

Up to 64 character string with a extension can be specified.

(2) Files of type: (extension selection area)

This area is used to specify the type (extension) of the file to be opened.

Table 7-12 Type of File That Can Be Displayed in Browse Dialog Box

File Type (Extension)	Meaning
Source (*.C, *.S)	Source file The extension of the source (c, s) can be changed in Debugger Option dialog box.
Text(*.TXT)	Text file
All(*.*)	All files

Function buttons

Open	Sets the selected file. After setting the file, closes this dialog box.
Cancel	Does not set the file and closes this dialog box.
Help	Opens the Help window.

Address Move dialog box

This dialog box is used to specify the address from which displaying memory contents, results of disassembly, results of coverage, or I/O registers are to be displayed. This dialog box is displayed if [View] -> [Move] is selected from the menu bar while the Memory window, the Assemble window, the Coverage window, or the IOR window is opened, and enables the display start address of data to be changed.

Figure 7-19 Address Move Dialog Box
(Example: When Memory Window Is Open)



This section explains the following items:

- Opening
- Explanation of each area
- Function buttons

Opening

This dialog box can be opened as follows:

When the Memory window, Assemble window, Coverage window, or IOR window is opened

- Select [View] -> [Move...] from the menu bar
(or press Alt+V and V in that order, or press Ctrl+J).

Explanation of each area

The Address Move dialog box consists of the following areas:

- (1) To (address specification area)

(1) To (address specification area)



This area is used to specify an address. In the default condition, the string selected in the window that called this dialog box, the current PC value (Memory window, Assemble window, Coverage window),

or blank (IOR window) is displayed.

An address can be also specified by a symbol or expression (refer to "Table 7-14 Specifying Symbols"). The default radix for inputting a numeric value is hexadecimal.

By displaying the input history, the contents previously input can be reused.

Up to 16 input histories can be recorded.

Function buttons

OK	Displays the memory contents, results of disassembly, results of coverage, or I/O registers.
Cancel	Closes this dialog box.
Restore	Restores the input data to the original status.
Help	Opens the Help window.

Source Text Move dialog box

This dialog box is used to specify a file to be displayed in the Source window and the position from which displaying the file is to be started.

This dialog box is selected if [View] -> [Move...] is selected from the menu bar while the Source window is open, and enables the display start position of a file to be changed (a new window is not opened).

Figure 7-20 Source Text Move Dialog Box

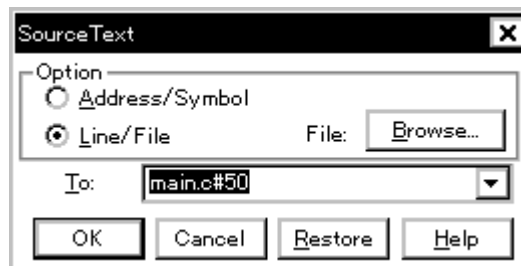

This section explains the following items:

- Opening
- Explanation of each area
- Specifying
 - Specifying a display start position by an address (or symbol).
 - Specifying a file to be displayed in the Source window
- Function buttons

Opening

This dialog box can be opened as follows:

When the Source window is active

- Select [View] -> [Move...]
(or press Alt+V and V in that order, or press Ctrl+J).

Explanation of each area

The Source Move dialog box consists of the following areas:

- (1) Option (input mode selection area)
- (2) To (file/address specification area)

(1) Option (input mode selection area)

This area is used to select the input mode when the display start position is specified.

Address/Symbol	If the display start position is specified by an address (or symbol)
Line/File	If the display start position is specified by a line number (or file name)

(2) To (file/address specification area)

This area is used to specify the file name or address to be displayed. In the default condition, the character string selected in the window that called this dialog box is displayed in this area. If no character string has been selected, the first character string of the input history is displayed. If no input history is available, the current PC is displayed. As necessary, the character string displayed in this area can be changed by directly inputting a character string from the keyboard.

By displaying the input history, the contents previously input can be reused. Up to 16 input histories can be recorded.

Specifying

On this dialog box, the following two items can be specified.

- Specifying a display start position by an address (or symbol).
- Specifying a file to be displayed in the Source window

Specifying a display start position by an address (or symbol).

Select **Address/Symbol** under **Option** and specify the address from which display is to be started for **To**.

An address can be also specified by a symbol or expression (refer to "Table 7-14 Specifying Symbols"). The default radix for inputting a numeric value is hexadecimal.

Clicking the <OK> button displays the source text so that the source line corresponding to the specified address value can be viewed.

Specifying a file to be displayed in the Source window

Select **Line/File** under **Option** and specify the name of the file to be displayed in the Source window for **To**. Specification can be made using only the file name, or using an absolute path or relative path.

If only the file name is specified, or if a relative path is specified, the files in the directory of the source path specified in Debugger Option dialog box are sequentially searched. The file that is found first as a result of searching is displayed.

In addition to a file name, a line number can be also specified as follows:

<<path name>file name#>line number

Delimit the file name from the line number with "#". Specify the line number in decimal. The file name may be omitted. The default radix for inputting a numeric value is hexadecimal.

Clicking the <OK> button displays the specified file with the specified line number as the first line. If the file name omitted, the file being displayed is displayed starting from the specified line. If the line number is omitted, the file is displayed starting from its first line.

Function buttons

Browse...	Opens the Browse dialog box.
OK	Starts displaying the source text from the specified position.
Cancel	Closes this dialog box.
Restore	Restores the input data to the original status.
Help	Opens the Help window.

Trace Move dialog box

This dialog box is used to specify the position from which displaying the Trace window is started.

This dialog box is displayed if [View] -> [Move...] is selected from the menu bar while the Trace window is open, and enables the display start position of the trace results to be changed.

Figure 7-21 Trace Move Dialog Box

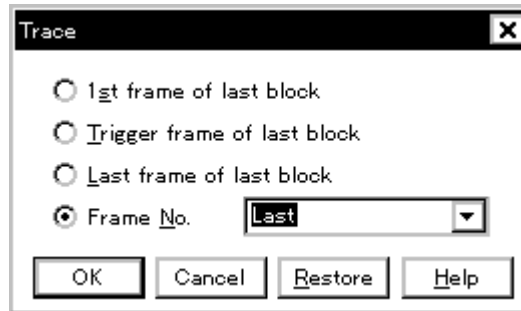

This section explains the following items:

- Opening
- Explanation of each area
- Function buttons

Opening

This dialog box can be opened as follows:

When the Trace window is displayed

- Select [View] -> [Move...]
(or press Alt+V and V in that order, or press Ctrl+J).

Explanation of each area

The Trace Move dialog box consists of the following areas:

- (1) Frame selection area
- (2) Frame number specification area

(1) Frame selection area

- 1st frame of last block
 Trigger frame of last block
 Last frame of last block
 Frame No.

This area is used to specify the frame at the destination.

1st frame of last block	Moves the display start position to the to first frame in the newest block of trace data.
Trigger frame of last block	Moves the display start position to a trigger frame in the newest block frame of trace data.
Last frame of last block	Moves the display start position to the last frame of trace data.
Frame No.	Moves the display start position to the specified frame number. If 0 is specified, the display start position is moved to the first frame of trace data. If this item is checked, the focus moves to the text box on the side.

(2) Frame number specification area

- Frame No.

This area is used to specify a frame number if Frame No. is selected in the frame selection area. In the default condition, the character string selected in the window that called this dialog box or "Last" is selected. As necessary, however, this can be changed by directly inputting a character string from the keyboard.

The default radix for inputting a numeric value is hexadecimal.

A frame number can also be specified in the following format. The uppercase and lowercase characters of the input character string are not distinguished. In addition, a frame number can also be specified in abbreviated form.

Table 7-13 Frame Number Specification Format

Specification	Abbreviation	Contents
+numeric value	None	Moves backward (downward on screen) the display start position from the frame at the cursor by the specified number of frames (numeric value).
-numeric value	None	Moves forward (upward on screen) the display start position from the frame at the cursor by the specified number of frames (numeric value).
Top	O	Moves the display start position to the first frame of trace data.
First	S	Moves the display start position to the first frame of the current trace block.
Trigger	T	Moves the display start position to the trigger frame of the current trace block.

Table 7-13 Frame Number Specification Format

Specification	Abbreviation	Contents
Last	L	Moves the display start position to the last frame of the current trace block.
Bottom	B	Moves the display start position to the last frame of trace data.

By displaying the input history, the contents previously input can be reused. Up to 16 input histories can be recorded.

Function buttons

OK	Starts trace display from the specified position.
Cancel	Closes this dialog box.
Restore	Restores the input data to the original status.
Help	Opens the Help window.

Symbol To Address dialog box

Displays the address of the specified variable or function, or the value of the specified symbol.

Figure 7-22 Symbol To Address Dialog Box



This section explains the following items:

- Opening
- Explanation of each area
- Function buttons

Opening

This dialog box can be opened as follows:

- Select [V]iew -> [S]ymbol... from the menu bar (or press Alt+V and Y in that order).

Explanation of each area

The Symbol To Address dialog box consists of the following areas:

- (1) Symbol: (symbol specification and conversion result display areas)
- (2) Radix (display radix specification area)

(1) Symbol: (symbol specification and conversion result display areas)

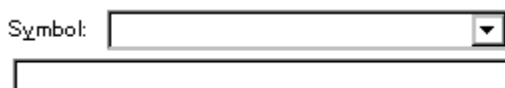

The upper area (symbol specification area) is used to specify the variable, function name, symbol name, or line number to be converted.

In addition, an I/O port name, peripheral I/O register name, register name, PSW flag name, or expression can be also specified.

In the lower area (conversion result display area), the variable, address of the function, value of the symbol, address of the line number, or value of the expression specified under **Symbol** is displayed. The address value of an I/O port name or peripheral I/O register name, the register contents of a register name, or flag value of a PSW flag name is displayed. The specification method is indicated below.

Table 7-14 Specifying Symbols

Conversion Target	Specification Method
Variable	var file#var (to specify a static function with file name) func#var (to specify a static function with function name) file#var (to specify a static function with file name and function name)
Function	func file#func (to specify a static function with file name)
Label	label file#label(to specify a local label with file name)
Line number of source file	prog\$file#var file#no
I/O Port	portname
I/O Register	I/O regname
Register	regname
PSW Flag	pswname

Remark var: Variable name, func: Function name, file: File name, label: Label name, bitsym: Bit symbol name, portname: I/O port name, I/O regname: Peripheral I/O register name, regname: Register, pswname: PSW flag name, no: Line number of source file

"#" is used as a separator for file names, variables, function names, and line numbers.

If a specified symbol is not found in the scope, all symbols (static variables, static functions, local labels) are searched.

In the default status, a symbol name takes precedence. To temporarily change the priority, prefixing "\$" to a symbol gives the priority to a register name.

To specify a load module name when two or more load modules are read, use "\$" as a separator to delimit the load module name from a file name, variable, function name, or symbol name.

In the default condition, the character string selected in the window that called this dialog box is displayed. As necessary, input data from the keyboard to change the character string. The default radix for inputting a numeric value is decimal.

To change the contents of the symbol specification area, click the <OK> button. The conversion result will be displayed in the conversion result display area.

By displaying the input history, the contents previously input can be reused. Up to 16 input histories can be recorded.

(2) Radix (display radix specification area)

Radix: Hex Dec Oct Bin

This area is used to specify the radix of the data to be displayed in the conversion result display area.

Hex	Hexadecimal number (default).
Dec	Decimal number
Oct	Octal number
Bin	Binary number

Function buttons

OK	If the contents of the symbol specification area have been changed, converts the symbol. After conversion, closes the dialog box if the contents of the symbol specification area have not been changed.
Cancel	Closes this dialog box.
Restore	Restores the input data to the original status. If the <OK> button has already been clicked, the data is restored to the status immediately after the <OK> button was clicked.
Help	Opens the Help window.

Source window

This window displays source files or text files.

In Mixed display mode, the program can be disassembled and displayed and online assembly can be executed while source files are being displayed.

The Source window that is displaying the source file to which symbol information is read may be in two statuses: Active Status and Static Status.

Caution If program codes is described in an include file and these codes are included in multiple files, the line numbers and addresses do not correspond on a one-to-one bases. In such an include file, function that indicates the correspondence relationship between line numbers and addresses dose not correctly operate.

Figure 7-23 Source Window

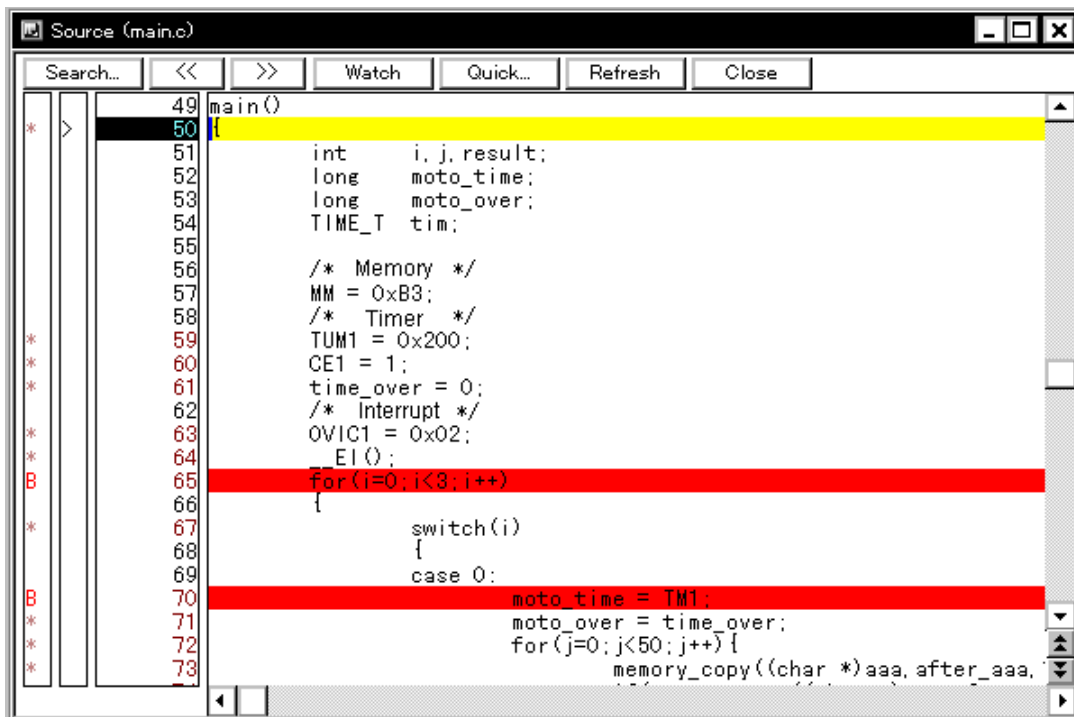

This section explains the following items:

- Opening
- Explanation of each area
 - Breakpoint setting/deletion function
- Functions often used (right-click menu)
- Function buttons

- Related operations

Concerning display

- Mixed display mode
- To set a source path
- To change the display start position
- To display another source file
- To specify the default extension of a source file
- To convert a symbol
- To specify the symbol of a start-up routine
- To set an opened file history
- To set a beep sound to be issued upon break
- To change the displayed font
- To change the displayed tab size

Concerning operation

- Start function
- Come function
- Program counter setting function
- Jump function
- To change disassembled contents
- Watch function (referencing data value)
- To search in a source program
- To set event after execution
- Drag & drop function (line/address)
- Drag & drop function (character string)

Opening

This window can be opened as follows:

- This window is automatically opened if the corresponding source file exists after the download module file has been downloaded.
- Click the **Src** button.
- Select [**B**rowse] -> [**S**ource] from the menu bar (or press Alt+B, and S in that order).
- Select [**J**ump] -> [**S**ource] from the menu bar (or press Alt+J and S in that order, or press Ctrl+U).
- Click the <Open> button with selecting a source file or text file in the View File Load dialog box.

Explanation of each area

The Source window consists of the following areas:

- (1) Point mark area
- (2) Current PC mark area
- (3) Line number/address display area
- (4) Source text display area

(1) Point mark area



This area displays the Breakpoint setting/deletion function, Event setting status, and Program code.

Breakpoint setting/deletion function

By clicking this area with the mouse, a breakpoint can be set or deleted.

Setting a breakpoint

A breakpoint can be set on a line for which "*" is displayed in the point mark area (if "*" is not displayed for the line, the breakpoint is set on the line above or below the line, whichever has "*" displayed).

If a breakpoint is set on a line on which an event breakpoint has already been set, "A" indicating that multiple events have been set is displayed.

Deleting a breakpoint

Click the position at which the breakpoint to be deleted is set.

If another event remains, however, the mark of that event is displayed.

Table 7-15 Details of Setting/Deleting Breakpoint

Display Status of Line	Operation on clicking
Blank or with mark other than B	Sets a hardware breakpoint Blank -> Displays B (red) mark Other than B mark -> Displays A mark (indicating setting of multiple events)
With B (red, green, black) mark (Hardware breakpoint setting status)	Deletes a hardware breakpoint. ->Blank

The 'B' mark is displayed in the following colors, depending on the type and status of the breakpoint.

A breakpoint becomes valid as soon as it has been set in the point mark area.

Table 7-16 Display Color of Breakpoint and Its Meaning

Display Color	Meaning
B (red)	Valid hardware breakpoint (after execution) is set.
B (green)	Valid hardware breakpoint (before execution) is set. * This breakpoint is set, taking precedence over the hardware breakpoint after execution.
B (black)	Invalid hardware breakpoint is set. This hardware breakpoint can be validated on the Event Manager or in the Break dialog box.

Event setting status

The setting status of various events can be displayed.

If an execution event or access event is set on the corresponding line, a mark corresponding to the type of event is displayed.

If an address range is specified as the address condition of the event, the lower addresses of the range are displayed.

The mask specification of the address condition is not reflected.

Table 7-17 Meaning of Event Display Mark

Mark	Meaning
E	Setting of event condition
L	Setting of event for event link condition
B	Setting of break event
T	Setting of trace event
Ti	Setting of timer event
S	Setting of snapshot event
U	Setting of stub event
A	Setting of multiple events

Program code

The line marked '*' in the point mark area indicates that a program code corresponding to the line number exists. This program code is displayed only if a load module has been downloaded and symbol information has been read.

(2) Current PC mark area

The mark '>', which indicates the current PC value (PC register value), is displayed in this area. Clicking this mark with the mouse displays a pop-up window that shows the PC register value. By double-clicking the current PC mark area, the program can be executed up to a specified line.

(3) Line number/address display area

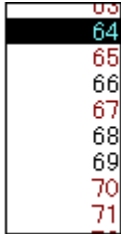

This area displays the line numbers of a source file or text file.

If a Program code corresponding to a line number of the source file exists, the character of the line number is displayed in **red**. If a program code does not exist, the character of the line number is displayed in black.

In the mixed display mode, disassembled addresses are displayed. The characters of an address are displayed in gray.

In this area, any position can be selected (highlighted) by clicking the mouse button. The selected line number of an address can be dragged to another window or area, so that its variable value can be displayed or the line number of the address can be specified as an event condition (refer to "Drag & drop function (line/address)").

(4) Source text display area

This area displays source files or text files. In the mixed display mode, disassemble display and online assemble can also be executed (refer to "To change disassembled contents").

A data value can be temporarily displayed by selecting (highlighting) a character string and placing the mouse cursor over it (Balloon watch function).

The current PC line and the line on which a breakpoint is set are emphasized for display, as follows:

Current PC line (Yellow)	This line is the source line or disassemble display line corresponding to the current PC value (indicated by '>').
Breakpoint setting line (red)	This line is the source line or a disassemble display line on which a valid breakpoint is set (indicated by a 'B' mark in red or green).

In the mixed display mode, the color of only the disassemble display line is changed (the source line is displayed in the normal color).

In this area, the following functions can be used on the line or address on which the cursor is placed (start address of program code):

- > Start function
- > Come function
- > Program counter setting function
- > Jump function

Caution If a Program code does not exist on the source line, the top address of the line above or below the line on which a program code exists is manipulated by these functions.

These functions cannot be performed in the following cases. The corresponding menu will be dimmed and cannot be selected.

If a file other than a source file is displayed

While the user program is being executed

A character string selected in this area can be dragged and dropped to another window or dialog box (refer to "Drag & drop function (character string)").

Functions often used (right-click menu)

In this window, functions that are often used can be selected from the menu that is displayed by clicking the right mouse button. In this way, the same function can be used more easily than with the normal procedure.

Move...	Moves the display position. Opens the Source Text Move dialog box.
Mix	Turns on/off mixed display of disassembly. Checked: Mixed display Not checked: No display (default)
Add Watch	Adds the specified data to the Watch window. Opens the Add Watch dialog box.
Symbol	Displays the address of the specified variable or function, or the value of the specified symbol. Opens the Symbol To Address dialog box.
Break when Access to this Variable	Creates a break event for a read/write access.
Break when Write to this Variable	Creates a break event for a write access.
Break when Read from this Variable	Creates a break event for a read access.
Clear	Deletes the selected break event condition.
Come Here	Executes the program from the current PC to the cursor position (Come function).
Break Point	Sets or deletes a breakpoint at the cursor position.
Change PC	Sets the address at the cursor position to the PC.
Assemble	Disassembles and displays starting from the jump destination address specified by the data value at the cursor position. Opens the Assemble window. If an active Assemble window is open, that window is displayed in the forefront (so that it can be manipulated).

Memory	Displays the memory contents starting from the jump destination address specified by the data value at the cursor position. Opens the Memory window. If an active Memory window is open, that window is displayed in the forefront (so that it can be manipulated).
Coverage	Displays the coverage measurement results starting from the jump destination address specified by the data value at the cursor position. Opens the Coverage window. If an active Coverage window is open, that window is displayed in the forefront (so that it can be manipulated).

Function buttons

Search...	Opens the Source Search dialog box and searches a character string of the source text. If a character string is selected in the source text display area, the Source Search dialog box is opened to search the character string. If no character string is selected, the Source Search dialog box is opened with nothing specified to be searched. Specify a search method in the Source Search dialog box. The result of search is highlighted in the Source window. This is the same operation as selecting [View] -> [Search...] from the menu bar. This button is invalid while the user program is executed.
<<	Searches forward (upward on screen) for the text that satisfies the search condition set in the Source Search dialog box, starting from the address at the cursor position. This button is displayed as the <Stop> button during a search. This button is invalid while the user program is executed.
>>	Searches backward (downward on screen) for the text that satisfies the search condition set in the Source Search dialog box, starting from the address at the cursor position. This button is displayed as the <Stop> button during a search. This button is invalid while the user program is executed.
Stop (during search)	Stops searching.
Watch	Adds the variables selected in the source text display area to the Watch window. If the Watch window is not opened, it is opened. If no text is selected in the source text display area, the Watch window is only opened. This is the same operation as selecting [View] -> [View Watch] from the menu bar.
Quick...	Temporarily displays the contents, such as a variable, selected in the source text display area in the Quick Watch dialog box. Opens the Quick Watch dialog box. If no text is selected in the source text display area, the Quick Watch dialog box is only opened. This is the same operation as selecting [View] -> [Quick Watch] from the menu bar.
Refresh	Updates the contents of the window with the latest data.
Close	Closes this window.

Related operations

Mixed display mode

The normal display mode and mixed display mode can be alternately selected by selecting [View] -> [Mix] from the menu bar.

Normal display mode

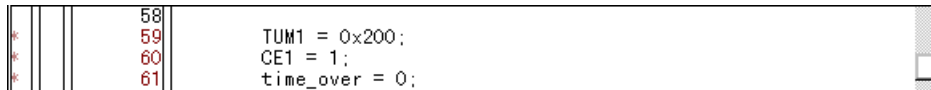

```

58
* 59 TUM1 = 0x200;
* 60 CE1 = 1;
* 61 time_over = 0;

```

In the normal display mode, general text files can be displayed as well as source files.

Mixed display mode

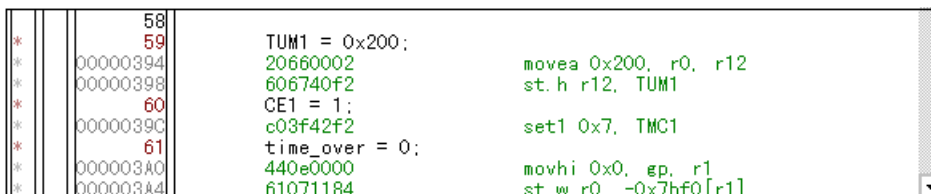

```

58
* 59 TUM1 = 0x200;
* 00000394 20660002 movea 0x200, r0, r12
* 00000398 606740f2 st.h r12, TUM1
* 60 CE1 = 1;
* 0000039C c03f42f2 set1 0x7, TMC1
* 61 time_over = 0;
* 000003A0 440e0000 movhi 0x0, gp, r1
* 000003A4 61071184 st.w r0, -0x7bf0[r1]

```

In the mixed display mode, disassembly of programs combined with source files is displayed and online assembly is carried out. (This mode is valid only when a load module is being downloaded and symbol information is being read, and the source file that corresponds to the downloaded load module is displayed).

If a program code corresponds to the line of the displayed source file, the disassembly line is displayed next to the source line. In the disassembly line, an address label, a code data, and a disassembled mnemonic are displayed (the starting position for display of the mnemonic can be adjusted by the tab size setting value).

To execute online assembly, move the cursor to a mnemonic. The results of online assembly are also reflected in the Memory window.

The contents displayed in the mixed display mode can be saved as a view file.

To set a source path

Set a source path under Source Path (source path specification area) in the Debugger Option dialog box that is opened by selecting [Option] -> [Debugger Option] from the menu bar.

To change the display start position

Change the display start position in the Source Text Move dialog box that is opened when right-click menu -> [Move...] is selected in the Source window.

To display another source file

Select [File] -> [Open] from the menu bar and specify a file.

To specify the default extension of a source file

Set a source path under Default Extension (default extension specification area) in the Debugger Option dialog box that is opened by selecting [Option] -> [Debugger Option] from the menu bar.

To convert a symbol

Convert symbols in the Symbol To Address dialog box that is opened when right-click menu -> [Symbol...] is selected in the Source window.

To specify the symbol of a start-up routine

Specify the symbol of a start-up routine under Startup Routine (start-up symbol setting area) in the Debugger Option dialog box that is opened by selecting [Option] -> [Debugger Option...] from the menu bar. If the setting in this area is wrong, the source file cannot be opened.

To set an opened file history

Set an opened file history under Open File History (open file history setting area) in the Debugger Option dialog box that is opened by selecting [Option] -> [Debugger Option...] from the menu bar. The number of a history display of the opened files can be specified in this area.

To set a beep sound to be issued upon break

Set the beep sound under Break Sound (beep sound specification area) in the Extended Option dialog box that is opened by selecting [Option] -> [Extended Option...] from the menu bar.

To change the displayed font

Change the displayed font in the Font dialog box that can be opened by clicking the <Font...> button in the Debugger Option dialog box that is opened when [Option] -> [Debugger Option...] is selected from the menu bar.

To change the displayed tab size

The displayed tab size can be specified for each file extension under Tab Size (tab size setting area) in the Debugger Option dialog box that is opened when [Option] -> [Debugger Option...] is selected from the menu bar.

Start function

This function is used to execute the user program from the line on which the cursor is placed.

Method

Move the cursor to the line from which the program is to be executed, and select right-click menu -> [Start From Here].

Come function

This function is used to execute the user program to the line on which the cursor is placed (while the user program is being executed in this mode, the break event currently set does not occur).

Method

Move the cursor to the line on which the break is to occur, and select right-click menu -> [Come Here].

Program counter setting function

This function is used to set the address of the line on which the cursor is placed to the program counter (PC).

Method

Move the cursor to the line that is to be set to the PC, and select [Run] -> [Change PC] from the menu

bar.

Jump function

This function is used to jump to the Memory window, using the selected variable as a jump pointer.

The jump destination window will be displayed from the vicinity of the jump pointer.

- 1 Select the name of variable as a jump pointer with the mouse.
 - 2 In the Main window, to jump to the Memory window
Select [Jump] -> [Memory] from the menu bar.
(or press Alt+J and E in that order, or press Ctrl+M).
- To jump from the Trace window to the Memory window or Coverage window, the jump source address differs as follows, depending on the cursor position in the trace result display area:

If the cursor is at an access address, access data, or access status	-> Access address
Other than above	-> Fetch address
To jump to the Source window or Assemble window	-> Fetch address

- To jump from the Register window, move the cursor to a register value.
- To jump from the Stack Trace window, the jump destination is as follows:

[With current function]

- If the jump destination is the Source window
-> Jumps to the current PC line.
- If the jump destination is a window other than the Source window
-> Jumps to the current PC address.

[With function other than current function]

- If the jump destination is the Source window
-> Jumps to the line that calls a nested function.
- If the jump destination is a window other than the Source window
-> Jumps to the address next to the instruction that calls a nested function.

To change disassembled contents

To change the disassembled contents, move the cursor to the mnemonic field (the overwrite and insertion modes are alternately selected by pressing the Insert key).

If an attempt is made to move the cursor to another line after the disassembled contents have been changed in the mnemonic field, the new contents are checked. If the new contents are illegal, the code data on the line where the contents have been changed is indicated as '*'. In this case, the new contents are not written to memory even if the cursor is moved to another line.

The contents changed in the mnemonic field are written into the memory by pressing the Enter key.

When the Enter key is pressed, the new contents are checked and, if they are illegal, the code data on the illegal line is indicated by '*'. If even one line is illegal, the new contents are not written into the memory.

In this case, correct the contents. To discard the contents, press the ESC key. If the contents are

correct and if the Enter key is pressed, the contents are written into the memory, and then the cursor moves to the next line in the mnemonic field, so that the data on the next line can be changed.

Watch function (referencing data value)

Data values can be displayed as follows:

To temporarily display a value

The following two methods can be used:

- Select (highlight) a character string and put the mouse cursor on it then the data value is displayed (Balloon watch function).
- Select (highlight) a character string and click the <Quick> button. The Quick Watch dialog box will be opened to display the data value.

To trace the change of a data value

Register a variable or symbol to the Watch window in either of the following ways:

- Select (highlight) the character string whose data value is to be displayed, click the <Watch> button, or drag the character string to the Watch window and register it to the window (Drag & drop function (character string)).
- Select (highlight) the character string whose a data value is to be displayed and register the data value from the Add Watch dialog box that is opened when right-click menu -> [Add Watch] is selected.

To search in a source program

Use the Source Search dialog box that is opened by clicking the <Search...> button in the Source window.

If the character string to be searched exists in the window, select that character string and click the <Search...> button. The selected character string will be opened in the specified format.

To set event after execution

Set an event after execution under Break condition (break mode setting area) in the Extended Option dialog box that is opened by selecting [Option] -> [Extended Option...] from the menu bar. If a normal hardware breakpoint is set after this setting was performed, the hardware breakpoint is set as an event after execution. In the default condition, an event before execution is set.

Drag & drop function (line/address)

The line number or address selected and highlighted can be dragged to another window or area.

If the position of the line number or address selected in this area is dragged with the left mouse button, the shape of the mouse cursor changes from an arrow to '-'. When the cursor is moved to the window or area in which they can be dropped, the mouse cursor changes to 'OK'.

In the window in which the line number of the address has been dropped, an operation is performed on the dropped address or the address that is obtained from the dropped line number. The operation to be performed after dropping the line number or address differs, depending on the window or area in which the line number or address has been dropped.

Table 7-18 Details of Drag & Drop Function (Line/Address)

Window/Area to Drop to	Operation After Drop
The Event Manager or the event manager area in each various event setting dialog box	Automatically creates an execution event condition by using the dropped line number or address as an address condition. Event condition names are automatically created as Evt00001, Evt00002, and so on. An external sense data condition and path count are not specified. The address condition is set for the closest symbol in the format of symbol name + offset value.
Condition setting area in each various event setting dialog box (other than address and data setting areas)	Automatically creates an execution event condition by using the dropped line number or address as an address condition. The automatically created event condition is set in each condition setting area in which the line number or address has been dropped. Event condition names are automatically created as Evt00001, Evt00002, and so on. An external sense data condition and path count are not specified. The address condition is set for the closest symbol in the format of symbol name + offset value.
Condition setting area in each various event setting dialog box (address and data setting areas)	The text of the dropped line number or address is set in the area in which the line number or address has been dropped. The address condition is set for the closest symbol in the format of symbol name + offset value.

Caution The various event setting dialog boxes includes the Event dialog box, Event Link dialog box, Break dialog box, Trace dialog box, Snap Shot dialog box, Stub dialog box, and Timer dialog box.

Drag & drop function (character string)

A selected text can be moved to another window or area by dragging and dropping.

- 1 If the selected text is dragged by using the left mouse button, the shape of the mouse cursor changes from an arrow to '!'.
- 2 When the cursor is moved to the window or area in which the text can be dropped, the mouse cursor changes to 'OK'.

The operation to be performed after dropping the text differs, depending on the window or area in which the text has been dropped.

Table 7-19 Details of Drag & Drop Function (Character String)

Window/Area to Drop to	Operation After Drop												
The Event Manager or the event manager area in each various event setting dialog box	<p>If the dropped text can be converted as a symbol into an address value, an event condition in the Access status (all access statuses) or Execute status is automatically created, using the converted address value as an address condition. Event condition names are automatically created as Evt00001, Evt00002, and so on. An external sense data condition and path count are not specified. The address condition is set by the dropped text. The relationship between the event condition to be created and the symbol is as follows:</p> <table border="1" data-bbox="762 645 1246 824"> <thead> <tr> <th><u>Symbol</u></th> <th><u>Status</u></th> </tr> </thead> <tbody> <tr> <td>Variable</td> <td>Access(R/W)</td> </tr> <tr> <td>Function</td> <td>Execute</td> </tr> <tr> <td>Symbol in the data section</td> <td>Access(R/W)</td> </tr> <tr> <td>Symbol in the code section</td> <td>Execute</td> </tr> <tr> <td>Other</td> <td>Access(R/W)</td> </tr> </tbody> </table>	<u>Symbol</u>	<u>Status</u>	Variable	Access(R/W)	Function	Execute	Symbol in the data section	Access(R/W)	Symbol in the code section	Execute	Other	Access(R/W)
<u>Symbol</u>	<u>Status</u>												
Variable	Access(R/W)												
Function	Execute												
Symbol in the data section	Access(R/W)												
Symbol in the code section	Execute												
Other	Access(R/W)												
Condition setting area in each various event setting dialog box (other than address and data setting areas)	<p>If the dropped text can be converted as a symbol into an address value, an event condition in the Access status (all access statuses) or Execute status is automatically created, using the converted address value as an address condition. The automatically created event condition is set in each condition setting area in which the line number or address has been dropped. Event condition names are automatically created as Evt00001, Evt00002, and so on. An external sense data condition and path count are not specified. The address condition is set by the dropped text. The relationship between the event condition to be created and the symbol is as follows:</p> <table border="1" data-bbox="762 1223 1246 1402"> <thead> <tr> <th><u>Symbol</u></th> <th><u>Status</u></th> </tr> </thead> <tbody> <tr> <td>Variable</td> <td>Access(R/W)</td> </tr> <tr> <td>Function</td> <td>Execute</td> </tr> <tr> <td>Symbol in the data section</td> <td>Access(R/W)</td> </tr> <tr> <td>Symbol in the code section</td> <td>Execute</td> </tr> <tr> <td>Other</td> <td>Access(R/W)</td> </tr> </tbody> </table>	<u>Symbol</u>	<u>Status</u>	Variable	Access(R/W)	Function	Execute	Symbol in the data section	Access(R/W)	Symbol in the code section	Execute	Other	Access(R/W)
<u>Symbol</u>	<u>Status</u>												
Variable	Access(R/W)												
Function	Execute												
Symbol in the data section	Access(R/W)												
Symbol in the code section	Execute												
Other	Access(R/W)												
Condition setting area in each various event setting dialog box (address and data setting areas)	The dropped text is set in the area.												
Watch window	If the dropped text is recognizable as a symbol, the contents of the symbol are displayed.												

Caution The various event setting dialog boxes includes the Event dialog box, Event Link dialog box, Break dialog box, Trace window, Snap Shot dialog box, Stub dialog box, and Timer dialog box.

Source Search dialog box

This dialog box is used to search for the character string in the Source window.

By setting each item and then clicking the <Find Next> button, searching can be started.

By clicking the <Set Find> button, the direction buttons ("<<" and ">>") in the Source window can be used for the search.

Figure 7-24 Source Search Dialog Box



This section explains the following items:

- Opening
- Explanation of each area
- Function buttons

Opening

This dialog box can be opened as follows:

When Source window is displayed

- Click the <Search> button.
(or press Ctrl and G in that order).
- Select [View] -> [Search...]
(or press Alt+V, and S in that order).

Explanation of each area

The Source Search dialog box consists of the following areas:

- (1) Find What (search data specification area)
- (2) Match Case (search condition specification area)
- (3) Direction (search direction specification area)
- (4) File (search file specification area)

(1) Find What (search data specification area)

Find What:

This area is used to specify the data to be searched.

In the default condition, the character string selected in the window that called this dialog box is displayed. As necessary, input data from the keyboard to change the character string.

Up to 256 character string can be specified.

By displaying the input history, the contents previously input can be reused. Up to 16 input histories can be recorded.

(2) Match Case (search condition specification area)

Match Case

This area is used to specify whether uppercase and lowercase characters are distinguished, before searching is started.

Checked	Distinguished (default)
Not checked	Not distinguished

(3) Direction (search direction specification area)

Direction
 Up Down

This area is used to specify the direction of the search.

Up	Forward search. Searches data forward (upward on screen) from the current position of the cursor.
Down	Backward search (default). Searches data backward (downward on screen) from the current position of the cursor.

(4) File (search file specification area)

File:

This area is used to specify the file to be searched.

If no file is specified, searching is executed in the window that called this dialog box.

Function buttons

Find Next	Searches the specified data in accordance with a given condition. If the specified character string is found as a result of a search, it is highlighted. To continue searching, click this button again.
Set Find	Sets the specified condition as the search condition and closes this dialog box.
Stop (during search)	Stops searching.
Cancel	Closes this dialog box. This button is displayed as the <Stop> button while data is being searched.
Browse...	Opens Browse dialog box.
Help	Opens the Help window.

Assemble window

This window is used to disassemble and display programs. It is also used to execute online assembly.

To execute online assembly, move the cursor to a mnemonic. The results of online assembly are also reflected in the Memory window.

The Assemble window has two statuses: Active Status and Static Status.

Figure 7-25 Assemble Window

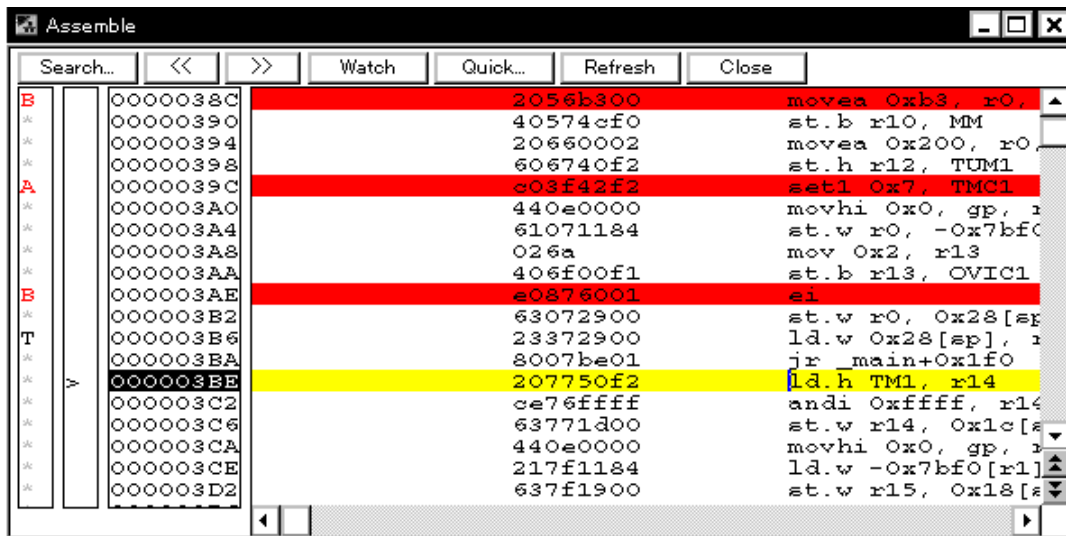

This section explains the following items:

- Opening
- Explanation of each area
- Functions often used (right-click menu)
- Function buttons
- Related operations

Concerning display

- To change the display start position
- To change the displayed offset and register name

Concerning operation

- Start function
- Come function
- Program counter setting function
- Jump function
- To change the disassembled contents

- Watch function (referencing data value)
- To search in the Assemble window
- To set event after execution
- Drag & drop function (line/address)
- Drag & drop function (character string)

Opening

This window can be opened as follows:

- Click the **Asm** button.
- Select [**B**rowse] -> [**A**ssemble] from the menu bar (or press Alt+B, and A in that order).
- Select [**J**ump] -> [**A**ssemble] from the menu bar (or press Alt+J and A in that order, or press Ctrl+D).

Explanation of each area

The Assemble window consists of the following areas:

- (1) Point mark area
- (2) Current PC mark area
- (3) Address specification area
- (4) Disassemble display area

(1) Point mark area



This area is displayed the Breakpoint setting/deletion function and the Event setting status.

(2) Current PC mark area



The mark '>', which indicates the current PC value (PC register value), is displayed in this area.

By double-clicking the current PC mark area, the program can be executed up to a specified line.

(3) Address specification area

```

000003AA
000003AE
000003B2
000003B6
000003BA
000003BE
000003C2

```

This area displays the disassembly start address. When this area is clicked, an address highlighted and selected.

This area has the Drag & drop function (line/address) and the Trace Result with Linking Window function.

(4) Disassemble display area

026a	mov Ox2, r13
406f00f1	st.b r13, OVIC1
20875001	st
63072900	st.w r0, Ox28[sp]
23372900	ld.w Ox28[sp], r1
8007be01	jr _main+Ox1f0
207750f2	ld.h TM1, r14
ce76ffff	andi Oxffff, r14
63771300	st.w r14, Ox1c[sp]
440e0000	movhi Ox0, gp, 1
217f1184	ld.w -Ox7bf0[r1]
637f1900	st.w r15, Ox18[sp]

This area displays the labels and code data of addresses, and disassembled mnemonics.

The current PC line and breakpoint setting line are displayed in different colors for emphasis (refer to "Source text display area").

The disassembled mnemonics displayed in the mnemonic field can be changed (refer to "To change disassembled contents").

If the number of new instruction bytes is less than the number of previous instruction bytes as a result of changing, as many 'NOP' instructions as necessary are inserted. If the number of new instruction bytes is more than the number of previous instruction bytes, the next instruction is overwritten. In this case also, as many 'NOP' instructions as necessary are inserted. The same applies to instructions that straddle over source lines.

In this area, the following functions can be used on the line or address on which the cursor is placed (start address of program code):

- > Start function
- > Come function
- > Program counter setting function
- > Jump Function

A character string selected in this area can be dragged and dropped in another window or dialog box (refer to "Drag & drop function (character string)").

Functions often used (right-click menu)

In this window, functions that are often used can be selected from the menu that is displayed by clicking

the right mouse button. In this way, the same function can be used more easily than with the normal procedure.

Move...	Moves the display position. Opens the Address Move dialog box.
Add Watch	Adds the specified data to the Watch window. Opens the Add Watch dialog box.
Symbol	Displays the address of the specified variable or function, or the value of the specified symbol. Opens the Symbol To Address dialog box.
Come Here	Executes the program from the current PC to the cursor position (Come function).
Change PC	Sets the address at the cursor position to the PC.
Break Pont	Sets or deletes a breakpoint at the cursor position.
Source Text	Displays the corresponding source text and source line, using the data value at the cursor position as the jump destination address. If no line information exists at the jump destination address, however, you cannot jump. Opens the Source window. If an active Source window is open, that window is displayed in the forefront (so that it can be manipulated).
Memory	Displays the memory contents starting from the jump destination address specified by the data value at the cursor position. Opens the Memory window. If an active Memory window is open, that window is displayed in the forefront (so that it can be manipulated).
Coverage	Displays the coverage measurement results starting from the jump destination address specified by the data value at the cursor position. Opens the Coverage window. If an active Coverage window is open, that window is displayed in the forefront (so that it can be manipulated).

Function buttons

Search...	Opens the Assemble Search dialog box and searches for a character string of mnemonics. If a character string is selected in the disassemble display area, the Assemble Search dialog box is opened to search for the character string. If no character string is selected, the Assemble Search dialog box is opened with nothing specified to be searched. Specify a search method in the Assemble Search dialog box. The result of search is highlighted in the Assemble window. This is the same operation as selecting [View] -> [Search...] from the menu bar.
<<	Searches forward (upward on screen) for the contents that satisfy the search condition set in the Assemble Search dialog box, starting from the address at the cursor position. This button is displayed as the <Stop> button during a search.

>>	Searches backward (downward on screen) for the contents that satisfy the search condition set in the Assemble Search dialog box, starting from the address at the cursor position. This button is displayed as the <Stop> button during a search.
Stop (during search)	Stops searching.
Watch	Adds the symbols selected in the disassemble display area to the Watch window. If the Watch window is not opened, it is opened. If no text is selected in the disassemble display area, the Watch window is only opened. This is the same operation as selecting [View] -> [View Watch] from the menu bar.
Quick...	Temporarily displays the contents, such as symbols, selected in the disassemble display area on the Quick Watch dialog box. Opens the Quick Watch dialog box. If no text is selected in the disassemble display area, the Quick Watch dialog box is only opened. This is the same operation as selecting [View] -> [Quick Watch...] from the menu bar.
Refresh	Updates the contents of the window with the latest data.
Close	Closes this window.

Related operations

To change the display start position

Change the display start position in the Address Move dialog box, which is opened when right-click menu -> [Move...] is selected in the Assemble window.

To change the displayed offset and register name

Change the display offset or register name under DisAssemble (offset display setting area) in the Debugger Option dialog box that is opened when [Option] -> [Debugger Option...] is selected from the menu bar. A function name or an absolute name can be selected as a register name.

Start function

For the operation, refer to "Start function" in the Source window.

Come function

For the operation, refer to "Come function" in the Source window.

Program counter setting function

For the operation, refer to "Program counter setting function" in the Source window.

Jump function

For the operation, refer to "Jump function" in the Source window.

To change the disassembled contents

For the operation, refer to "To change disassembled contents" in the Source window.

Watch function (referencing data value)

For the operation, refer to "Watch function (referencing data value)" in the Source window.

To search in the Assemble window

Use the Assemble Search dialog box, which can be opened by clicking the <Search...> button in the Assemble window. If the character string to be searched is existed in the window, select that character string and click the <Search...> button. The selected character string is opened in the specified format.

To set event after execution

For the operation, refer to "To set event after execution" in the Source window.

Drag & drop function (line/address)

For the operation, refer to "Drag & drop function (line/address)" in the Source window.

Drag & drop function (character string)

For the operation, refer to "Drag & drop function (character string)" in the Source window.

Assemble Search dialog box

This dialog box is used to search the contents of Assemble window.

Successive character strings included in an input character string and disassembler character string are compared as one blank character.

By setting each item and then clicking the <Find Next> button, searching can be started.

By clicking the <Set Find> button, the direction buttons ("<<" and ">>") in the Assemble window can be used for the search.

Figure 7-26 Assemble Search Dialog Box

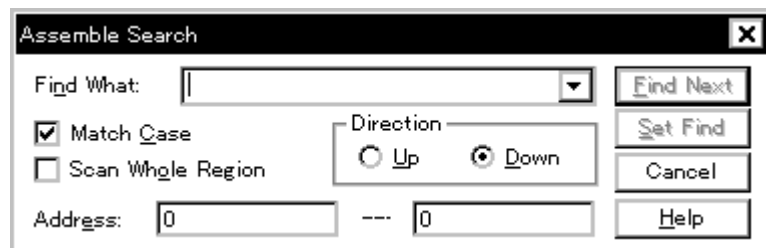

This section explains the following items:

- Opening
- Explanation of each area
- Function buttons

Opening

This dialog box can be opened as follows:

When Assemble window is the current window

- Click the <Search> button.
(or press Ctrl+G).
- Select [View] -> [Search...]
(or press Alt+V, and S in that order).

Explanation of each area

The Assemble Search dialog box consists of the following areas:

- (1) Find What (search data specification area)
- (2) Match Case (search condition specification area)
- (3) Scan Whole Region (search condition specification area)
- (4) Direction (search direction specification area)

(5) Address (search range specification area)

(1) **Find What** (search data specification area)

Find What:

This area is used to specify the data to be searched.

In the default condition, the character string selected in the window that called this dialog box is displayed. As necessary, input data from the keyboard to change the character string.

Up to 256 character string can be specified.

By displaying the input history, the contents previously input can be reused. Up to 16 input histories can be recorded.

(2) **Match Case** (search condition specification area)

Match Case

This area is used to specify whether uppercase and lowercase characters are distinguished, before searching is started.

Checked	Distinguished (default)
Not checked	Not distinguished

(3) **Scan Whole Region** (search condition specification area)

Scan Whole Region

This area is used to specify whether the specified range is fully searched or not.

Checked	Searches the entire range.
Not checked	Searches the remaining part of the range (default)

(4) **Direction** (search direction specification area)

Direction
 Up Down

This area is used to specify the direction of the search.

Up	Forward search. Searches data forward (upward on screen) from the current position of the cursor.
Down	Backward search (default). Searches data backward (downward on screen) from the current position of the cursor.

(5) Address (search range specification area)

Address: ---

This area is used to specify the address to be searched.

An address can be also specified by a symbol or expression (refer to "Table 7-14 Specifying Symbols"). The default radix for inputting a numeric value is hexadecimal.

Function buttons

Find Next	Searches the specified data in accordance with a given condition. If the specified character string is found as a result of a search, it is highlighted. To continue searching, click this button again.
Set Find	Sets the specified condition as the search condition and closes this dialog box.
Stop (during search)	Stops searching.
Cancel	Closes this dialog box. This button is displayed as the <Stop> button while data is being searched.
Help	Opens the Help window.

Memory window

This window is used to display and change the memory contents.

The display start position when the Memory window is opened is as follows:

First time	Display starts from the first address of the real-time RAM sampling area.
Second and subsequent times	Display starts from the address at which an active status window was closed (if an active status window has never been closed, display starts from the first display start position).

Even while the program is being executed, the range set in the Extended Option dialog box can be displayed in real time.

The Memory window has two statuses: Active Status and Static Status.

Figure 7-27 Memory Window

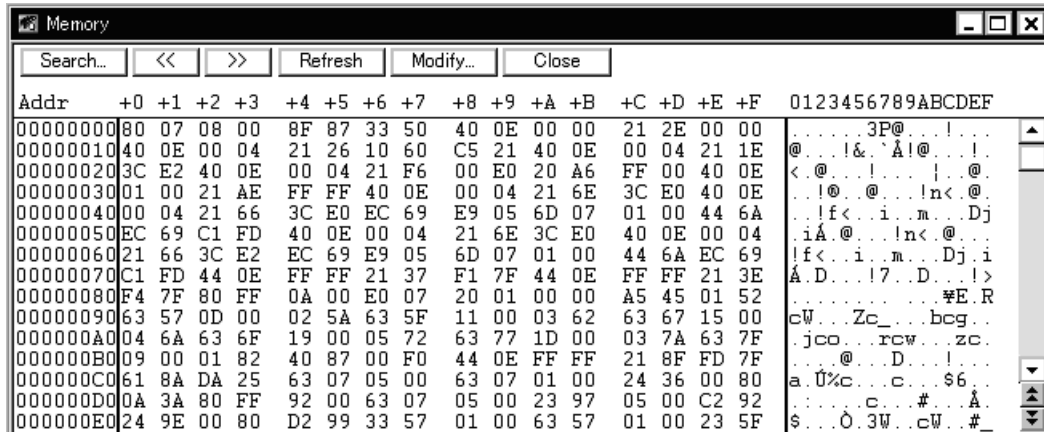

This section explains the following items:

- Opening
- Explanation of each area
- Functions often used (right-click menu)
- Function buttons
- Related operations
 - To change the memory contents
 - To change the display start position
 - To search in the Memory window
 - To display ASCII characters
 - To initialize the memory contents with a specified code

- To copy the memory contents
- To compare the memory contents
- To verify and check a memory write

Opening

This window can be opened as follows:

- Click the **Mem** button.
- Select [**B**rowse] -> [**M**emory...] from the menu bar (or press Alt+B, and M in that order).
- Select [**J**ump] -> [**M**emory...] from the menu bar (or press Alt+J, and M in that order).

Explanation of each area

The Memory window consists of the following areas:

- (1) Addr (address display area)
- (2) +0 +1 +2....(memory display area)
- (3) 0 1 2 3.... (ASCII display area)

(1) Addr (address display area)

```
Addr
00FFE000
00FFE010
00FFE020
00FFE030
00FFE040
00FFE050
00FFE060
00FFE070
```

This area displays memory addresses.

(2) +0 +1 +2....(memory display area)

```
+0 +1 +2 +3 +4 +5 +6 +7 +8 +9 +
00 20 00 00 00 00 08 00 00 00 0
00 00 04 00 00 00 00 00 0C 08 0
02 00 00 00 40 00 00 80 00 00 0
02 02 00 00 60 00 02 01 00 00 0
00 00 00 00 00 00 00 00 00 08 0
00 00 00 00 00 00 00 00 00 00 0
```

This area is used to display and change the memory contents.

Data into which the current memory contents are to be changed is displayed in red and is actually written to the target when the Enter key is pressed. The contents (displayed in red) can be canceled by the ESC key. Up to 256 bytes can be specified at one time.

This area is also used as a jump pointer of the jump function. In addition, it also has the Trace Result

with Linking Window function.

(3) 0 1 2 3.... (ASCII display area)

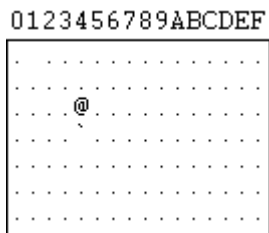

This area is used to display and change the memory contents in ASCII characters.

This area is displayed when right-click menu -> [Ascii] is selected. Display of this area can be turned on/off by this menu item.

Data can be changed in this area in the same manner as in the memory display area.

This area is also used as a jump pointer of the jump function.

Functions often used (right-click menu)

In this window, functions that are often used can be selected from the menu that is displayed by clicking the right mouse button. In this way, the same function can be used more easily than with the normal procedure.

Move...	Moves the display position. Opens the Address Move dialog box.
Bin	Displays binary numbers.
Oct	Displays octal numbers.
Dec	Displays decimal numbers.
Hex	Displays hexadecimal numbers (default).
Nibble	Displays in 4-bit units.
Byte	Displays in 8-bit units (default).
Half word	Displays in 16-bit units.
Word	Displays in 32-bit units.
Ascii	Turns on/off display of ASCII characters. Checked: Displayed Not checked: No display (default)

Function buttons

Search...	Opens the Memory Search dialog box and searches for character strings from the displayed memory contents, or memory contents. Selected data (a memory value) is displayed in the Memory Search dialog box as data to be searched. If the Memory Search dialog box is opened without data specified, specify data from the keyboard. The result of the search is highlighted in the Memory window.
<<	Searches the memory contents satisfying the search condition set in the Memory Search dialog box, forward (upward on screen) from the address at the cursor position. This button is displayed as the <Stop> button during a search.
>>	Searches the memory contents satisfying the search condition set in the Memory Search dialog box, backward (downward on screen) from the address at the cursor position. This button is displayed as the <Stop> button during a search.
Stop (during search)	Stops searching.
Refresh	Updates the contents of the window with the latest data.
Modify...	Opens the DMM dialog box. This button is invalid at a break.
Close	Closes this window.

Related operations

To change the memory contents

To change the memory contents, move the cursor to the memory display area or ASCII display area in the window, and write data directly from the keyboard. The amount of memory contents that can be changed at one time is 256 bytes or less. To set the change, press the return key. To cancel the change, press the ESC key.

To change the display start position

Use the Address Move dialog box, which can be opened by selecting right-click menu -> [Move] in the Memory window.

To search in the Memory window

Use the Memory Search dialog box, which can be opened by clicking the <Search...> button in the Memory window. If the character string to be searched exists in the window, select that character string and click the <Search...> button. The selected character string is opened in the specified format. Non-mapped, peripheral I/O register, and I/O protect areas are not searched.

To display ASCII characters

The memory contents are displayed in ASCII characters when right-click menu -> [Ascii] is selected in the Memory window.

To turn off display of ASCII characters, select [Ascii] again to remove the check mark.

To initialize the memory contents with a specified code

Initialize the memory contents with a specified code in the Memory Fill dialog box, which can be opened by selecting [Edit] -> [Memory] -> [Initialize] from the menu bar.

If verify check is enabled in the Extended Option dialog box, verify check is executed after initialization.

To copy the memory contents

Copy the memory contents in the Memory Copy dialog box, which can be opened by selecting [Edit] -> [Memory] -> [Copy] from the menu bar.

If verify check is enabled in the Extended Option dialog box, verify check is executed after copy.

To compare the memory contents

Compare the memory contents in the Memory Compare dialog box, which can be opened by selecting [Edit] -> [Memory] -> [Compare] from the menu bar.

If a difference is found as a result of comparison, the Memory Compare Result dialog box is opened and the details are displayed in this dialog box.

To verify and check a memory write

Use the Extended Option dialog box, which is opened by selecting [Option] -> [Extended Option] from the menu bar. To execute a verify check, check the [Verify] check box.

Memory Search dialog box

This dialog box is used to search the memory contents of the part of Memory window at which the cursor is located.

If the cursor is in the memory display area, the memory display area is searched for specified data, which is assumed to be a binary data string. If the cursor is in the ASCII display area, the ASCII display area is searched for specified data, which is assumed to be an ASCII character string.

By setting each item and then clicking the <Find Next> button, searching can be started.

By clicking the <Set Find> button, the direction buttons ("<<" and ">>") in the Memory window can be used for the search.

Non-mapped, peripheral I/O register, and I/O protect areas are not searched.

Figure 7-28 Memory Search Dialog Box

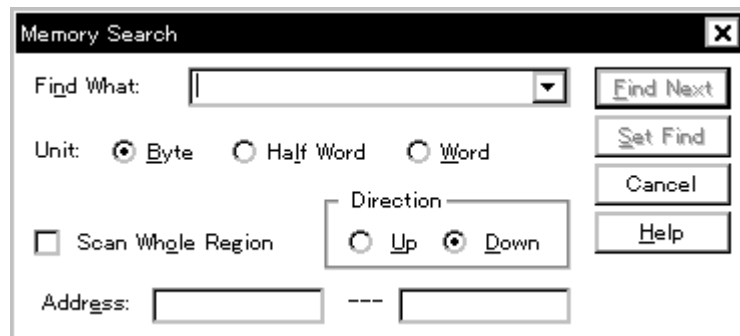

This section explains the following items:

- Opening
- Explanation of each area
- Function buttons

Opening

This dialog box can be opened as follows:

When Memory window is the current window

- Click the <Search> button.
(or press Ctrl+G).
- Select [View] -> [Search...]
(or press Alt+V, and S in that order).

Explanation of each area

The Memory Search dialog box consists of the following areas:

- (1) Find What (search data specification area)
- (2) Unit (search condition specification area)
- (3) Scan Whole Region (search condition specification area)
- (4) Direction (search direction specification area)
- (5) Address (search range specification area)

(1) Find What (search data specification area)

Find What:

This area is used to specify the data to be searched.

In the default condition, the character string selected in the window that called this dialog box is displayed. As necessary, input data from the keyboard to change the character string.

When searching the memory display area, up to 16 data items can be specified. Delimit each data with a "blank character". When searching the ASCII display area, data of up to 256 characters can be specified. A "blank character" in the data is treated as a blank character.

By displaying the input history, the contents previously input can be reused. Up to 16 input histories can be recorded.

(2) Unit (search condition specification area)

Unit: Byte Half Word Word

This area is used to specify the number of bits of the data to be searched in the memory display area.

Byte	Searches the data as 8-bit data (default).
Half Word	Searches the data as 16-bit data.
Word	Searches the data as 32-bit data.

(3) Scan Whole Region (search condition specification area)

Scan Whole Region

This area is used to specify whether the specified range is fully searched or not.

Checked	Searches the entire range.
Not checked	Searches the remaining part of the range (default)

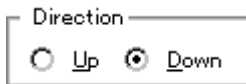
(4) Direction (search direction specification area)

This area is used to specify the direction of the search.

Up	Forward search. Searches data forward (upward on screen) from the current position of the cursor.
Down	Backward search (default). Searches data backward (downward on screen) from the current position of the cursor.

(5) Address (search range specification area)

This area is used to specify the address to be searched.

An address can be also specified by a symbol or expression (refer to "Table 7-14 Specifying Symbols"). The default radix for inputting a numeric value is hexadecimal.

Function buttons

Find Next	Searches the specified data in accordance with a given condition. If the specified character string is found as a result of a search, it is highlighted. To continue searching, click this button again.
Set Find	Sets the specified condition as the search condition and closes this dialog box.
Stop (during search)	Stops searching.
Cancel	Closes this dialog box. This button is displayed as the <Stop> button while data is being searched.
Help	Opens the Help window.

Memory Fill dialog box

This dialog box is used to initialize the memory contents in the Memory window with specified codes.

Figure 7-29 Memory Fill Dialog Box



This section explains the following items:

- Opening
- Explanation of each area
- Function buttons

Opening

This dialog box can be opened as follows:

- Select [E]dit -> [M]emory -> [F]ill from the menu bar.
(or press Alt+E, M and F in that order).

Explanation of each area

The Memory Fill dialog box consists of the following areas:

- (1) Address (address range specification area)
- (2) fill code (data specification area)

(1) Address (address range specification area)

Address
From: --

This area is used to specify the memory address range whose contents are to be initialized.

An address can be also specified by a symbol or expression (refer to "Table 7-14 Specifying Symbols"). The default radix for inputting a numeric value is hexadecimal.

Input the first address to be initialized and then the last address to be initialized.

(2) fill code (data specification area)

fill code =>

This area is used to specify the data with which the memory contents are to be initialized.

Up to 16 binary data strings (byte data strings) can be specified.

Delimit each data with a "blank character".

Function buttons

OK	Initializes the memory.
Stop (during initialization)	Stops initialization. While initialization is in progress, the <Cancel> button is replaced by the <Stop> button.
Cancel	Closes this dialog box. While memory contents are being initialized, this button is replaced by the <Stop> button.
Restore	Restores the input data to the original status.
Help	Opens the Help window.

Memory Copy dialog box

This dialog box is used to copy the memory contents in the Memory window.

Figure 7-30 Memory Copy Dialog Box

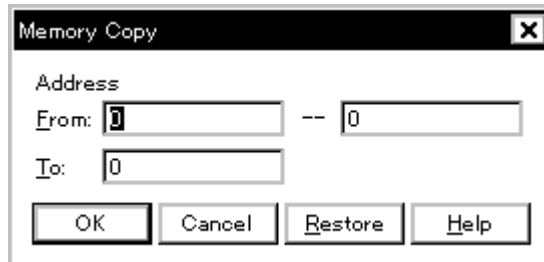

This section explains the following items:

- Opening
- Explanation of each area
- Function buttons

Opening

This dialog box can be opened as follows:

- Select [E]dit -> [M]emory -> [C]opy from the menu bar.
(or press Alt+E, M and C in that order).

Explanation of each area

The Memory Copy dialog box consists of the following area:

- (1) Address (address range specification area)

(1) Address (address range specification area)

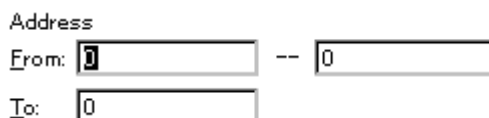

This area is used to specify the copy source and copy destination addresses.

An address can be also specified by a symbol or expression (refer to "Table 7-14 Specifying Symbols"). The default radix for inputting a numeric value is hexadecimal.

From	Specify the address range of the copy source. Input the first address of the copy source and then the end address.
To	Specify the first address of the copy destination.

Function buttons

OK	Copies the memory.
Stop (during copying)	Stops copying. While copying is in progress, the <Cancel> button is replaced by the <Stop> button.
Cancel	Closes this dialog box. While copying is in progress, this button is replaced by the <Stop> button.
Restore	Restores the input data to the original status.
Help	Opens the Help window.

Memory Compare dialog box

This dialog box is used to compare the memory contents in the Memory window.

Figure 7-31 Memory Compare Dialog Box

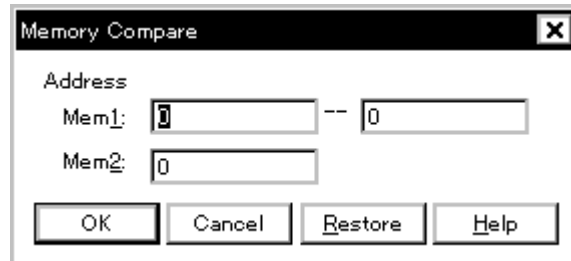

This section explains the following items:

- Opening
- Explanation of each area
- Function buttons

Opening

This dialog box can be opened as follows:

- Select [Edit] -> [Memory] -> [Compare] from the menu bar.
(or press Alt+E, M and P in that order).

Explanation of each area

The Memory Compare dialog box consists of the following area:

- (1) Address (comparison range specification area)

(1) Address (comparison range specification area)

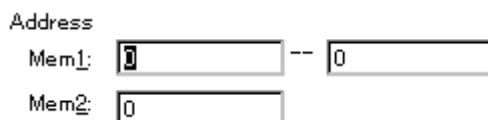

This area is used to specify the comparison source address and comparison destination address.

An address can be also specified by a symbol or expression (refer to "Table 7-14 Specifying Symbols"). The default radix for inputting a numeric value is hexadecimal.

Mem1	Specify the address range of the comparison source. Input the first address of the comparison source and then the end address.
Mem2	Specify the first address of the comparison destination.

Function buttons

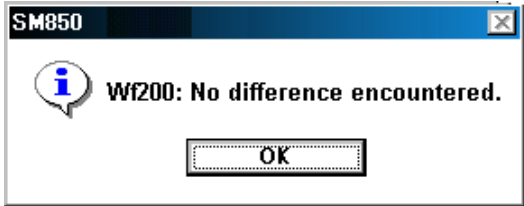
OK	<p>Compares the memory. If no difference is found as a result of comparison, a confirmation dialog box is displayed. If a difference is found, Memory Compare Result dialog box is opened.</p> <p style="text-align: center;">Figure 7-32 Confirmation Dialog Box</p>  <p style="text-align: center;">Clicking the <OK> button ends memory comparison.</p>
Stop (during comparison)	<p>Stops memory comparison. While comparison is in progress, the <Cancel> button is replaced by the <Stop> button.</p>
Cancel	<p>Closes this dialog box. While comparison is in progress, this button is replaced by the <Stop> button.</p>
Restore	Restores the input data to the original status.
Help	Opens the Help window.

Memory Compare Result dialog box

Displays the result of comparing the memory.

This dialog box is displayed if any difference is found in the memory contents when the memory has been compared in Memory Compare dialog box.

Figure 7-33 Memory Compare Result Dialog Box

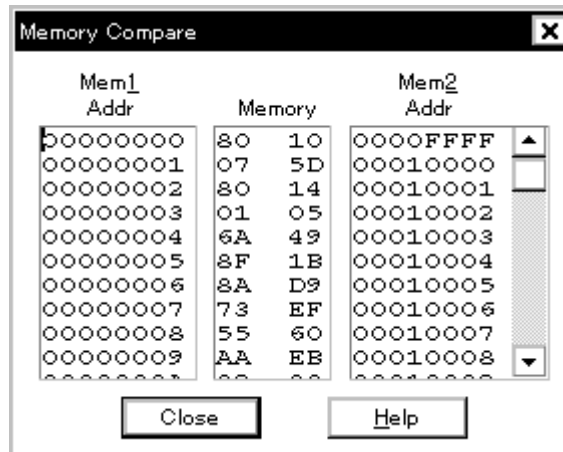

This section explains the following items:

- Explanation of each area
- Function buttons

Explanation of each area

The Memory Compare Result dialog box consists of the following area:

- (1) Mem1, Mem2 (comparison result display area)

- (1) **Mem1, Mem2** (comparison result display area)

Mem1 Addr	Memory	Mem2 Addr
00000000	80 10	0000FFFF
00000001	07 5D	00010000
00000002	80 14	00010001
00000003	01 05	00010002
00000004	6A 49	00010003
00000005	8F 1B	00010004
00000006	8A D9	00010005
00000007	73 EF	00010006
00000008	55 60	00010007
00000009	AA EB	00010008

This area displays the results of comparing the memory. Only differences that have been found as a

result of comparison are displayed.

Mem1 Addr	Displays a comparison source address in which a difference has been found.
Memory	Displays the data in which a difference has been found. Left: Comparison source data Right: Comparison destination data
Mem2 Addr	Displays the comparison destination address at which a difference has been found.

Function buttons

Close	Closes this dialog box.
Help	Opens the Help window.

DMM dialog box

This dialog box is used to set addresses and data for DMM (Dynamic Memory Modification).

DMM is used to rewrite the memory contents in real time while the user program is being executed.

Because this function is implemented by software emulation, however, the user program under execution is temporarily stopped and then executed again.

Caution The following points must be noted when using the DMM function.

- If the program is stopped immediately before rewriting the memory because a break event is generated, the generated break event is invalid because program execution is resumed, regardless of the break event.
- Verify check is always invalid.

Figure 7-34 DMM Dialog Box

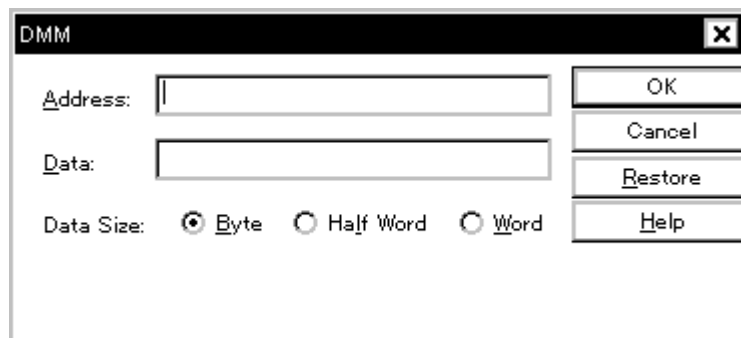

This section explains the following items:

- Opening
- Explanation of each area
- Function buttons

Opening

This dialog box can be opened as follows:

- Select [E]dit -> [M]emory -> [M]odify from the menu bar.
(or press Alt+E, M and M in that order).
- Click the <Modify> button in the Memory window.

Explanation of each area

The DMM dialog box consists of the following areas:

- (1) Address (address setting area)
- (2) Data (data setting area)
- (3) Data Size (data size setting area)

(1) **Address** (address setting area)

Address:

This area is used to specify the address to which data is to be written.

An address can be also specified by a symbol or expression (refer to "Table 7-14 Specifying Symbols"). The default radix for inputting a numeric value is hexadecimal.

(2) **Data** (data setting area)

Data:

This area is used to specify the data to be written to the memory address specified in [Address](#).

One binary data string can be specified at one time. Specify the data size in Data Size. Specify the data size in [Data Size](#). The default radix for inputting a numeric value is hexadecimal.

(3) **Data Size** (data size setting area)

Data Size: [B](#)yte [H](#)alf [W](#)ord [W](#)ord

This area is used to specify the size of the data to be written.

Byte	Writes data specified in Data as 8-bit data.
Half Word	Writes data specified in Data as 16-bit data.
Word	Writes data specified in Data as 32-bit data.

Function buttons

OK	Writes the data.
Cancel	Closes this dialog box.
Restore	Restores the input data to the original status.
Help	Opens the Help window.

Watch window

This window is used to display and change specified data.

The result of updating and rewriting data in this window will be reflected in the Memory window.

This window can also display wide-ranging data (such as global variables and public symbols) in real time even during program execution, in the same way as the Memory window.

To set a breakpoint for read/write access to a variable can be performed by a single action from the menu that is displayed by clicking the right mouse button.

Caution If a local variable and a global variable exist with the same name, the local variable takes priority.

Figure 7-35 Watch Window

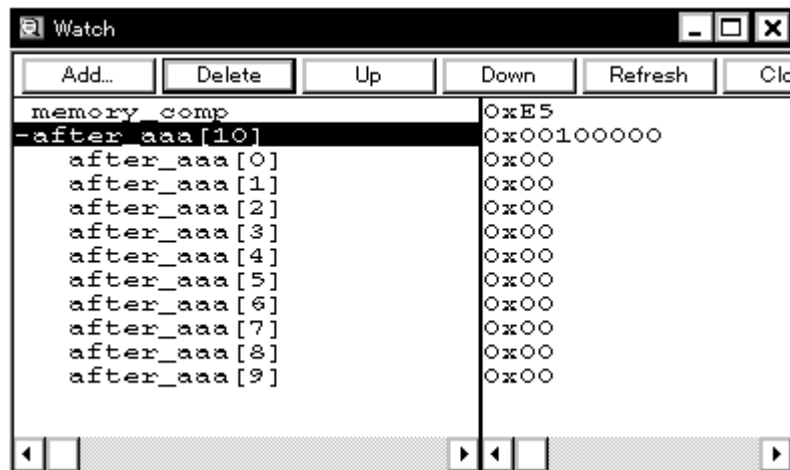

This section explains the following items:

- Opening
- Explanation of each area
- Functions often used (right-click menu)
- Function buttons
- Related operations
 - To add/delete displayed data (variable)
 - To change data on the selected line
 - To temporarily display a data (variable) value
 - To display/change a local variable value
 - To set a breakpoint for read/write access to a variable
 - To change displayed radix/size

Opening

This window can be opened as follows:

- Click the **Wch** button.
Select [**B**rowse] -> [**W**atch] from the menu bar,
(or press Alt+B, and W in that order).

Select data in the Source window or Assemble window,

- Select [**V**iew] -> [**V**iew Watch] from the menu bar,
(or press Alt+ V, and I in that order),
or click the <Watch> button.

In the Quick Watch dialog box or Add Watch dialog box dialog box,

- Click the <Add> button.

Explanation of each area

The Watch window consists of the following areas:

- (1) Left field (symbol name display area)
- (2) Right field (data value display/setting area)

(1) Left field (symbol name display area)

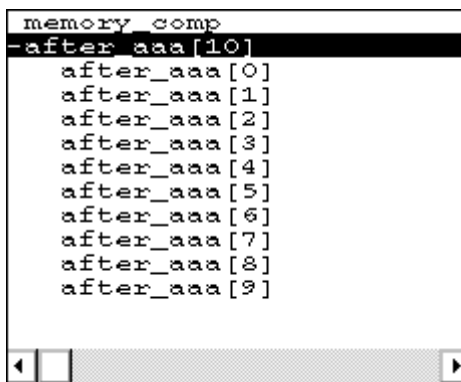

```

memory comp
-after aaa[10]
after_aaa[0]
after_aaa[1]
after_aaa[2]
after_aaa[3]
after_aaa[4]
after_aaa[5]
after_aaa[6]
after_aaa[7]
after_aaa[8]
after_aaa[9]

```

This area is used to display variable names, symbol names and types, and tag names of structures or unions.

Refer to "Name (symbol specification area)" in the Add Watch dialog box for details on the displayed contents.

'+' is prefixed to the displayed arrays, pointer variables, and structures or unions. These variables are expanded and displayed as follows when they are double-clicked:

Array	All the elements of the variable are displayed in accordance with the type of the array variable.
-------	---

Pointer variable	The data indicated by the pointer is displayed.
Structure/union	All the members of the structure/union are displayed in accordance with the type of the member variable. If a structure or union is defined in the structure or union, the structure name or union name of the internal structure or union is also displayed. The internal structure or union can be also expanded by using '+'.

'+' of the variable that has been expanded and displayed changes to '-'. If the variable is double-clicked in this status, the expanded display is canceled. Expanded display can be also specified or canceled by selecting a variable with the arrow keys and then pressing the Enter key.

If an access breakpoint is set for a variable or a symbol in the Watch window, the symbol name display area is highlighted in gold.

Reference If an array has too many variables and takes too long to expand, a warning message is displayed.

(2) Right field (data value display/setting area)

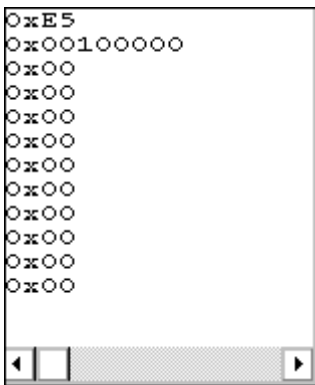

This area is used to display and change data values.

A value is updated when execution is stopped. To save a value, select [File] -> [Save As...] from the menu bar when the Save window is the current window. This area is blank if getting data has failed.

'?' is displayed for data that has been invalidated because of a change in the scope or optimized compiling. The contents of the change are written into the target when the Enter key is pressed. The previous value can be canceled by the ESC key.

The display format is as follows:

Table 7-20 Data Display Format (Watch-Related)

Display Data	Contents
Integer	Displayed in the same manner as the language specified in the Debugger Option dialog box. C-like (value: xxxx) Hexadecimal (0x xxxx) Decimal (xxxx) Octal (0 xxxx) Binary (0b xxxx) Assembly language-like (value: xxxx) Hexadecimal (xxxx H) Decimal (xxxx T) Octal (xxxx Q) Binary (0b xxxx Y)
Enumeration type	Member name
If scope is specified	Displayed in accordance with specified scope
Floating-point type	Single precision/double precision supported The input/display format is as follows: [+ -] inf [+ -] nan [+ -] integer e [+ -]exponent [+ -] integer.fraction [e [+ -]exponent

The size and radix of a data value can be specified on the [View] menu for each variable.

However, the display size cannot be selected if the display size is fixed, such as for variables in C or bit symbols or registers of the assembler.

If [View] -> [Adaptive] or [View] -> [Proper] from the menu bar is selected, the size and radix specified in the Debugger Option dialog box are used for display (refer to "To change displayed radix/size").

Functions often used (right-click menu)

In this window, functions that are often used can be selected from the menu that is displayed by clicking the right mouse button. In this way, the same function can be used more easily than with the normal procedure.

Break when Access to this Variable	Creates a break event that occurs if the selected variable is accessed for read/write.
Break when Write to this Variable	Creates a break event that occurs if the selected variable is accessed for write.
Break when Read from this Variable	Creates a break event that occurs if the selected variable is accessed for read.
Clear	Deletes the break event corresponding to the selected variable.
Event?	Displays the event information of the line at the cursor position or the selected variable. If an event is set, Event dialog box is opened.

Change Watch...	Changes the selected data.
Delete Watch	Deletes the selected watch point from the window.
Bin	Displays the selected line in binary numbers.
Oct	Displays the selected line in octal numbers.
Dec	Displays the selected line in decimal numbers.
Hex	Displays the selected line in hexadecimal numbers.
String	Displays the selected line as a character string.
Proper	Displays the selected line as the default value of each variable. Symbols are displayed in accordance with the setting of Debugger Option dialog box (default).
Byte	Displays the selected line in 8-bit units.
Half Word	Displays the selected line in 16-bit units.
Word	Displays the selected line in 32-bit units.
Adaptive	Displays the selected line as the default value of each variable. Only this item is valid for a symbol in C language. Symbols in assembly language are displayed in accordance with the setting of Debugger Option dialog box (default).
Up	Moves the selected line one line up.
Down	Moves the selected line one line down.

Function buttons

Add...	Opens the Add Watch dialog box. If data is specified and the <Add...> button is clicked in the Add Watch dialog box, the specified data is added to the Watch window.
Delete	Deletes the specified data from the Watch window. The DEL key performs the same operation.
Up	Moves the selected data one line up.
Down	Moves the selected data one line down.
Refresh	Updates the contents of the window with the latest data.
Close	Closes this window.

Related operations

To add/delete displayed data (variable)

Addition method (any of the following)

- Select a variable name or symbol name and click the <Watch> button in the Source window or Assemble window.

- Select a variable name or symbol name in the Source window or Assemble window, and drag it to the Watch window.
- Specify a variable name or symbol name and click the <Add> button in the Quick Watch dialog box or Add Watch dialog box.

Deletion method

- Click a variable name or symbol name (two or more variable or symbol names can be selected using the Shift or Ctrl key), and click the <Delete> button. A line with an expanded hierarchy, such as the elements of an array, and members of structures and unions cannot be changed.

To change data on the selected line

To change data (variables), select a line to be changed in the Watch window and select right-click menu -> [Change Watch...]. The Change Watch dialog box will be opened to change the data.

A line with an expanded hierarchy, such as the elements of an array, and members of structures and unions cannot be deleted.

To temporarily display a data (variable) value

A data (variable) value can be temporarily displayed in the following two ways:

To display using the balloon watch function

Select data (a variable name) in the Source window or Assemble window. Then place the mouse cursor on the selected character string. The value of the selected data will be displayed.

To display in the Quick Watch dialog box

Select data (a variable name) in the Source window or Assemble window. Then click the <Quick...> button. The value of the selected data will be displayed in the Quick Watch dialog box.

To display/change a local variable value

A local variable value can be checked or changed in the Local Variable window, which is opened when the **Loc** button is clicked.

In this window, the local variable in the current function is automatically displayed and the displayed variable cannot be added or deleted.

To change a local variable value, move the cursor to the local variable value display/changing area on the window and write a value in this area directly from the keyboard.

To determine the displayed contents, use the Enter key. To cancel, use the ESC key.

To set a breakpoint for read/write access to a variable

Select a variable in the Watch window and select [Break when Access to this Variable], [Break when Write to this Variable] or [Break when Read from this Variable] from the right-click menu. In this way, a hardware break event will be created in the valid status in accordance with the selected item.

Whether the event has been correctly created can be confirmed on the Event Manager.

To change displayed radix/size

Changing each data (variable) at any time

Select a data (variable) name to be changed in the Watch window or Quick Watch dialog box, and select the radix and size from the right-click menu.

Specifying default condition

Adaptive (when display size is specified) or Proper (when display radix is specified) for watching a symbol that specifies a default value can be set as the default assumption.

This is done in the Watch Default area of the Debugger Option dialog box, which is opened when [Option] -> [Debugger Option...] is selected from the menu bar.

The size specified under Size is displayed when Adaptive is specified, and the radix specified under Radix is displayed when Proper is specified.

Quick Watch dialog box

This dialog box is used to temporarily display or change specified data.

Figure 7-36 Quick Watch Dialog Box

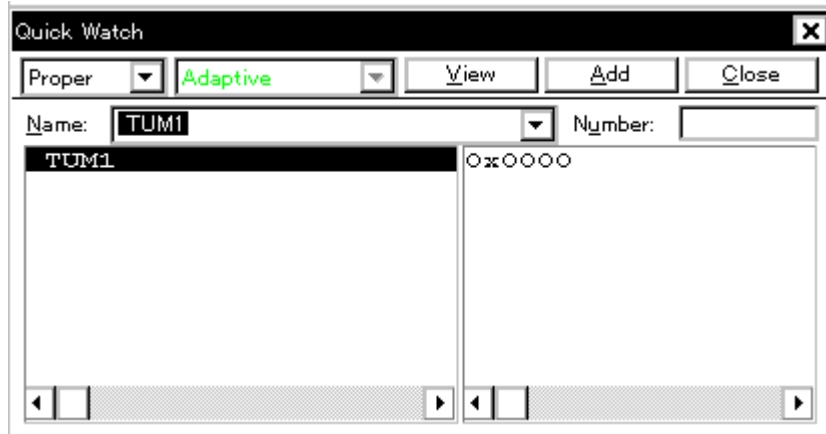

This section explains the following items:

- Opening
- Explanation of each area
- Function buttons

Opening

This dialog box can be opened as follows:

- Select [View] -> [Quick Watch...]
(or press Alt+V, and Q in that order).
- Click the <Quick> button in Source window.
(or press Ctrl+W).
- Click the <Quick> button in Assemble window.
(or press Ctrl+W).

Explanation of each area

The Quick Watch dialog box consists of the following areas:

- (1) Name (symbol specification area)
- (2) Symbol name display area
- (3) Data value display/setting area
- (4) Display radix selection area (upper left field)

- (5) Display size selection area (second upper left field)
- (6) Number (display number specification area)

(1) Name (symbol specification area)

Name:

This area is used to specify the data to be displayed.

In the default condition, the character string selected in the window that called this dialog box is displayed. As necessary, input data from the keyboard to change the character string. This area is blank if no character string is selected.

By displaying the input history, the contents previously input can be reused. Up to 16 input histories can be recorded.

If the contents of **Name** have been changed, the data specified in **Name** can be displayed in the field below by clicking the <View> button.

(2) Symbol name display area

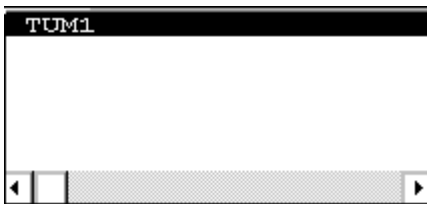

This area is used to display the variable name and the symbol name.

The displayed contents are the same as those of Name (symbol specification area) in the Add Watch dialog box.

(3) Data value display/setting area

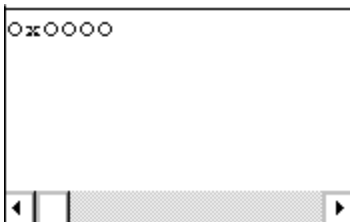

This area is used to display and change data values. The displayed contents and display method are the same as those of Watch window.

The displayed contents are the same as those of Right field (data value display/setting area) in the Watch window.

(4) Display radix selection area (upper left field)

Proper

This area is used to select the display radix.

The display radix of the data name selected in the symbol name display area will be changed.

Proper	Variable The default value of each variable is displayed. Symbol Displays data with the radix set in Debugger Option dialog box.
Hex	Displays data in hexadecimal numbers (0xxxxx)
Dec	Displays data in decimal numbers (xxxx)
Oct	Displays data in octal numbers (0xxxx)
Bin	Displays data in binary numbers (0bxxxx)
String	Displays character strings.

(5) Display size selection area (second upper left field)



This area is used to select the display size.

The display size of the data selected in the symbol name display area will be changed.

If the display size is fixed, such as when a variable in C or register is to be displayed, it cannot be changed.

Adaptive	Variable The default value of each variable is displayed. Symbol Displays data with the size set in Debugger Option dialog box.
Byte	Displays data in 8 bits.
Half Word	Displays data in 16 bits.
Word	Displays data in 32 bits.

(6) Number (display number specification area)

Number:

This area is used to specify the number of data to be displayed.

Specify blank or a number of 1 to 256.

If this area is blank, data is displayed as a simple variable.

If a number of 1 or more is specified, data is displayed as an array variable.

If an array variable is displayed, '+' is prefixed to the data. By double-clicking this '+', all the elements of the data are expanded and displayed in accordance with the type of the data ('-' is prefixed to the expanded data. If this '-' is double-clicked, the expanded display is canceled).

If the number of data to be displayed is fixed, such as when a variable in C or register is to be displayed, the specified number of data is invalid.

Function buttons

View	Displays the data specified in Name in the field below.
Add	Displays the data specified in Name to the Watch window.
Close	Closes this dialog box. Data that has not actually been written to the target will be canceled.

Add Watch dialog box

This dialog box is used to register data to be displayed in the Watch window.

Multiple data with the same symbol name can be registered.

Figure 7-37 Add Watch Dialog Box

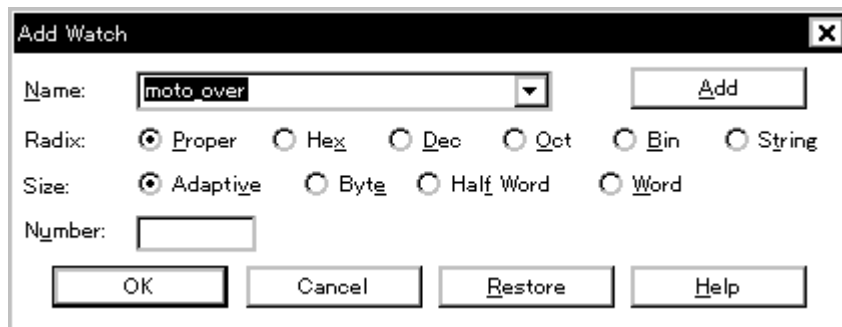

This section explains the following items:

- Opening
- Explanation of each area
- Function buttons

Opening

This dialog box can be opened as follows:

- Select [V]iew -> [A]dd W[atch...] from the menu bar (or press Alt+V, and W in that order).
- Click the <Add> button in Watch window.

Explanation of each area

The Add Watch dialog box consists of the following areas:

- (1) Name (symbol specification area)
- (2) Radix (display radix selection area)
- (3) Size (display size specification area)
- (4) Number (display number specification area)

(1) Name (symbol specification area)

Name:

This area is used to specify data to be added to the Watch window.

In the default condition, the character string selected in the window that called this dialog box is displayed. As necessary, input data from the keyboard to change the character string. This area is blank if no character string is selected.

By displaying the input history, the contents previously input can be reused. Up to 16 input histories can be recorded.

The format in which a variable can be input and how a variable is handled when a scope is specified are as follows:

- Variable Name

Variable expression : Variable Name

Variable expression[Constant value Variable Name]	Elements of array
Variable expression . Member name	Entity members of structure/union
Variable expression -> Member name	Members of structure/union indicated by pointer
*Variable expression	Value of pointer variable
&Variable expression	Address where variable is located

- Register name
- IOR name, IOR bit name
- Label and address of immediate value
- Register name . bit
- Label name . bit , address of immediate value . bit
- Specification of scope

Scope Specification	Program name	File name	Function name	Variable Name
prog\$file#func#var	prog	file	func	var
prog\$file#var	prog	file	Global	var
prog\$func#var	prog	Global	func	var
prog\$var	prog	Global	Global	var
file#func#var	Current	file	func	var
file#var	Current	file	Global	var
func#var	Current	Current	func	var
var	Current	Current	Current	var

(2) Radix (display radix selection area)Radix: Proper Hex Dec Oct Bin String

This area is used to change the radix of the data to be displayed.

Proper	Variable The default value of each variable is displayed. Symbol Displays data with the radix set in Debugger Option dialog box.
Hex	Displays data in hexadecimal numbers (0x xxxx)
Dec	Displays data in decimal numbers (xxxx)
Oct	Displays data in octal numbers (0 xxxx)
Bin	Displays data in binary numbers (0b xxxx)
String	Displays character strings.

(3) Size (display size specification area)Size: Adaptive Byte Half Word Word

This area is used to change the size of data to be displayed.

If the display size is fixed, such as when a variable in C or a bit symbol or register of the assembler is to be displayed, it cannot be changed.

Adaptive	Variable The default value of each variable is displayed. Symbol Displays data with the size set in Debugger Option dialog box.
Byte	Displays data in 8 bits.
Half Word	Displays data in 16 bits.
Word	Displays data in 32 bits.

(4) Number (display number specification area)Number:

This area is used to specify the number of data to be displayed.

Specify blank or a number of 1 to 256.

If this area is blank, data is displayed in Watch window as a simple variable.

If a number of 1 or more is specified, data is displayed in the Watch window as an array variable.

The maximum number of lines that can be displayed in the Watch window is 10,000.

If an array variable is displayed, '+' is prefixed to the data. By double-clicking this '+', all the elements of the data are expanded and displayed in accordance with the type of the data ('-' is prefixed to the expanded data. If this '-' is double-clicked, the expanded display is canceled).

If the number of data to be displayed is fixed, such as when a variable in C or register is to be

displayed, the number of data is invalid in the Watch window even if it has been changed.

Function buttons

Add	Adds the specified data to the Watch window. The dialog box remains open.
OK	Adds the specified data to the Watch window. Closes this dialog box.
Cancel	Closes this dialog box.
Restore	Restores the input data to the original status.
Help	Opens the Help window.

Change Watch dialog box

This window is used to change the data on a line selected in the Watch window.

A line with an open hierarchy, such as the elements of an array, and members of structures and unions cannot be changed.

When watch data is changed, the contents of the selected line are replaced with the new data.

The symbol name can be changed even if it results in duplication of a name already in use with existing data.

Figure 7-38 Change Watch Dialog Box

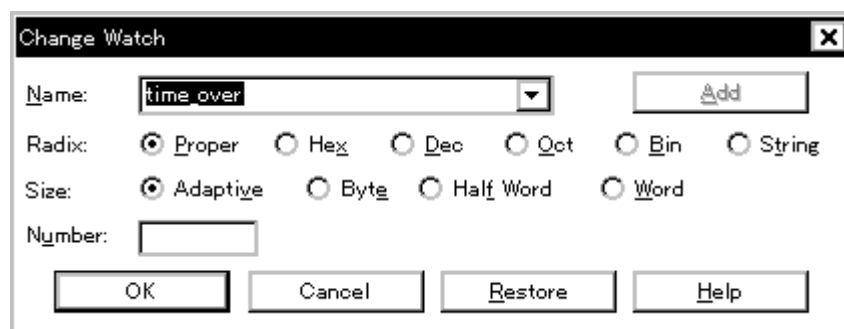

This section explains the following items:

- Opening
- Explanation of each area
- Function buttons

Opening

This dialog box can be opened as follows:

When the Watch window is open or a line is selected

- Select [View] -> [Change Watch...] from the menu bar (or press Alt+V, and G in that order).

Explanation of each area

The Change Watch dialog box consists of the following areas:

- (1) Name (symbol specification area)
- (2) Radix (display radix selection area)
- (3) Size (display size specification area)
- (4) Number (display number specification area)

(1) Name (symbol specification area)

Name:

This area is used to change a symbol name.

By displaying the input history, the contents previously input can be reused. Up to 16 input histories can be recorded.

The format in which a symbol name can be input is the same as that of Name (symbol specification area) in the Add Watch dialog box.

(2) Radix (display radix selection area)

Radix: Proper Hex Dec Oct Bin String

This area is used to change the radix of data to be displayed.

Proper	Variable The default value of each variable is displayed. Symbol Displays data with the radix set in Debugger Option dialog box.
Hex	Displays data in hexadecimal numbers (0x xxxx)
Dec	Displays data in decimal numbers (xxxx)
Oct	Displays data in octal numbers (0 xxxx)
Bin	Displays data in binary numbers (0b xxxx)
String	Displays character strings.

(3) Size (display size specification area)

Size: Adaptive Byte Half Word Word

Displays and modifies variables.

If the display size is fixed, such as when a variable in C or register is to be displayed, it cannot be changed.

Adaptive	Variable The default value of each variable is displayed. Symbol Displays data with the size set in Debugger Option dialog box.
Byte	Displays data in 8 bits.
Half Word	Displays data in 16 bits.
Word	Displays data in 32 bits.

(4) Number (display number specification area)

Number:

This area is used to specify the number of data to be displayed.

Specify blank or a number of 1 to 256.

If this area is blank, data is displayed in Watch window as a simple variable.

If a number of 1 or more is specified, data is displayed in the Watch window as an array variable.

The maximum number of lines that can be displayed in the Watch window is 10,000.

If an array variable is displayed, '+' is prefixed to the data. By double-clicking this '+', all the elements of the data are expanded and displayed in accordance with the type of the data ('-' is prefixed to the expanded data. If this '-' is double-clicked, the expanded display is canceled).

If the number of data to be displayed is fixed, such as when a variable in C or register is to be displayed, the number of data is invalid in the Watch window even if it has been changed.

Function buttons

Add	Cannot be selected.
OK	Replaces the registration contents currently selected with the specified data, and then closes this dialog box. Closes this dialog box.
Cancel	Closes this dialog box.
Restore	Restores the input data to the original status.
Help	Opens the Help window.

Local Variable window

This window is used to display and change the local variable in the current function.

This window automatically displays the local variable in the current function. It is linked with the jump function of the Stack Trace window, and displays the local variable in the function jumped when jumping to the Source window. Variables cannot be added or deleted.

Figure 7-39 Local Variable Window,

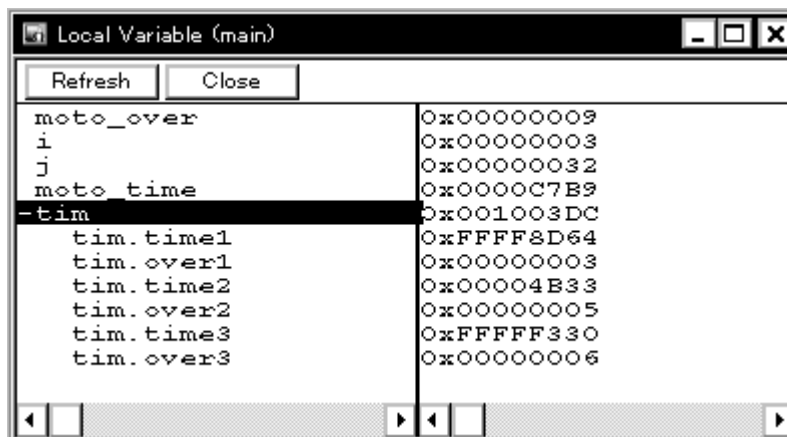

This section explains the following items:

- Opening
- Explanation of each area
- Functions often used (right-click menu)
- Function buttons

Opening

This window can be opened as follows:

- Click the **Loc** button.
- Select [Browse] -> [Local Variable] from the menu bar, (or press Alt,+B, and L in that order).

Explanation of each area

The Local Variable window consists of the following areas:

- (1) Left field (local variable name display area)
- (2) Right field (local variable value display/setting area)

(1) Left field (local variable name display area)

```

moto_over
i
j
moto_time
-tim
tim.time1
tim.over1
tim.time2
tim.over2
tim.time3
tim.over3

```

This area displays local variable name.

Auto, internal Static, and Register variables can be displayed.

The display format is the same as that of the Watch window.

This area cannot be edited directly.

(2) Right field (local variable value display/setting area)

```

0x00000009
0x00000003
0x00000032
0x0000C7B9
0x001003DC
0xFFFF8D64
0x00000003
0x00004B33
0x00000005
0xFFFFF330
0x00000006

```

This area displays local variable values.

The display format of the variable value is the same as that of the Watch window.

The display radix of variables can be switched by the menu selection in accordance with each variable.

The new value is written into the target when the Enter key is pressed. The previous value can be canceled by the ESC key.

Functions often used (right-click menu)

In this window, functions that are often used can be selected from the menu that is displayed by clicking the right mouse button. In this way, the same function can be used more easily than with the normal procedure.

Add Watch	Registers a selected character string to the Watch window. Opens the Add Watch dialog box.
Bin	Displays the selected line in binary numbers.
Oct	Displays the selected line in octal numbers.

Dec	Displays the selected line in decimal numbers.
Hex	Displays the selected line in hexadecimal numbers.
String	Displays the selected line as a character string.
Proper	Displays the selected line as the default value of each variable. Symbols are displayed in accordance with the setting of Debugger Option dialog box (default).

Function buttons

Refresh	Updates the contents of the window with the latest data.
Close	Closes this window.

Stack Trace window

This window is used to display or change the current stack contents of the user program.

From this window, you can also jump to the Source window, Assemble window, Memory window, and Coverage window corresponding to the stack contents.

Caution The stack trace display function may not operate correctly if there is a function that does not create a stack frame. In addition, [ERROR] may be displayed during prologue or epilogue processing of a function.

Figure 7-40 Stack Trace Window

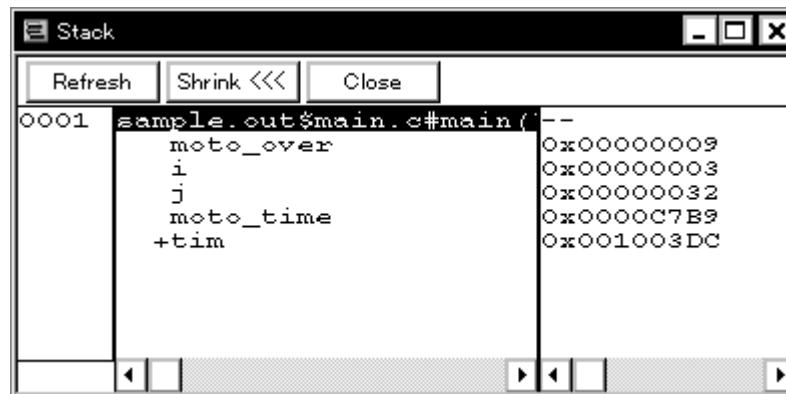

This section explains the following items:

- Opening
- Explanation of each area
- Functions often used (right-click menu)
- Function buttons

Opening

This window can be opened as follows:

- Click the **Stk** button.
- Select [Browse] -> [Stack Trace] from the menu bar, (or press Alt+B , and K in that order).

Explanation of each area

The Stack Trace window consists of the following areas:

- (1) Left field (stack frame number display area)
- (2) Center field (stack frame contents display area)
- (3) Right field (stack contents display/setting area)

(1) Left field (stack frame number display area)



This area assigns numbers to and displays the stack contents.

A stack frame number is a natural number starting from 1. The shallower the nesting of the stack, the higher the number. This means that a function having stack number one higher than that of a certain function is the function that calls the certain function.

(2) Center field (stack frame contents display area)

```
sample.out$main.c#main(  
  moto_over  
  i  
  j  
  moto_time  
  +tim
```

This area displays the stack frame contents.

It displays function names or local variable names. Note, however, that this area cannot be directly edited.

If the stack contents consist of a function, they are displayed as follows:

program name\$file name#function name (argument list) #line number

If this line is double-clicked, the operation will be the same as jumping to the Source window of the jump function (i.e., the local variable in the function to which execution has jumped will be displayed in the Local Variable window).

If the function has a local variable, the local variable will be displayed on the next and subsequent lines.

If the stack contents consist of a local variable, its type and name are displayed. These are displayed

in the same manner as in the Watch window. Note that the internal Static and Register variables are not displayed.

(3) Right field (stack contents display/setting area)

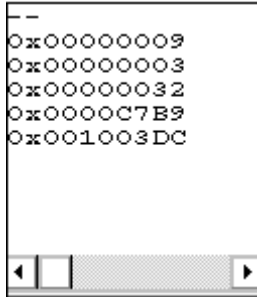

This area is used to display or change the stack contents.

'-' or a local variable value is displayed. If the stack contents are a function '-' is displayed and the function cannot be changed.

If the stack contents are a local variable, the variable value is displayed in the same manner as in the Watch window.

The display radix of variables can be switched by the menu selection in accordance with each variable.

A variable value can be changed. The new value is written into the target when the Enter key is pressed. The previous value can be canceled by the ESC key.

This area is used as the jump source area of the jump function.

Functions often used (right-click menu)

In this window, functions that are often used can be selected from the menu that is displayed by clicking the right mouse button. In this way, the same function can be used more easily than with the normal procedure.

Bin	Displays the selected line in binary numbers.
Oct	Displays the selected line in octal numbers.
Dec	Displays the selected line in decimal numbers.
Hex	Displays the selected line in hexadecimal numbers.
String	Displays the selected line as a character string.
Proper	Displays the selected line as the default value of each variable. Symbols are displayed in accordance with the setting of Debugger Option dialog box (default).

Source Text	<p>Displays the corresponding source text and source line from the jump destination address specified by the data value at the cursor position (the local variable in the function to which you have jumped is displayed in the Local Variable window).</p> <p>If no line information exists at the jump destination address, however, you cannot jump.</p> <p>Opens the Source window.</p> <p>If an active Source window is open, that window is displayed in the forefront (so that it can be manipulated).</p>
Assemble	<p>Disassembles and displays starting from the jump destination address specified by the data value at the cursor position.</p> <p>Opens the Assemble window.</p> <p>If an active Assemble window is open, that window is displayed in the forefront (so that it can be manipulated).</p>
Memory	<p>Displays the memory contents starting from the jump destination address specified by the data value at the cursor position.</p> <p>Opens the Memory window.</p> <p>If an active Memory window is open, that window is displayed in the forefront (so that it can be manipulated).</p>
Coverage	<p>Displays the coverage measurement results starting from the jump destination address specified by the data value at the cursor position.</p> <p>Opens the Coverage window.</p> <p>If an active Coverage window is open, that window is displayed in the forefront (so that it can be manipulated).</p>

Function buttons

Refresh	Updates the contents of the window with the latest data.
Shrink<<<	Collapses the local variable list of the selected function.
Expand>>>	Displays the local variable list of the selected function.
Close	Closes this window.

Register window

This window is used to display and change the contents of registers (program registers and system registers).

The register to be displayed in this window can be selected in the Register Select dialog box.

Figure 7-41 Register Window

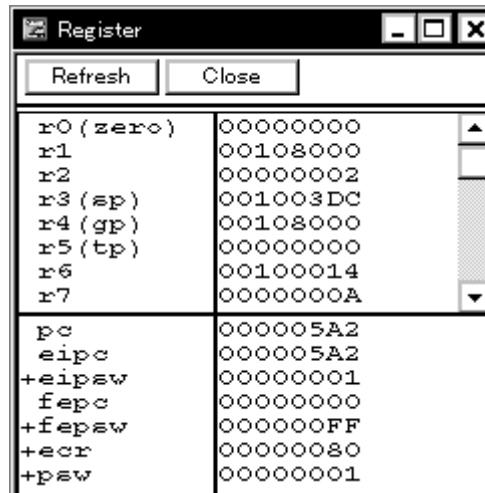

Register	
Refresh Close	
r0 (zero)	00000000
r1	00108000
r2	00000002
r3 (sp)	001003DC
r4 (gp)	00108000
r5 (tp)	00000000
r6	00100014
r7	0000000A
pc	000005A2
eipc	000005A2
+eipsw	00000001
fepc	00000000
+fepsw	000000FF
+ecr	00000080
+psw	00000001

This section explains the following items:

- Opening
- Explanation of each area
- Functions often used (right-click menu)
- Function buttons
- Related operations
 - To change a register value
 - To select the register to be displayed

Opening

This window can be opened as follows:

- Click the **Reg** button.
- Select [Browse] -> [Register] from the menu bar, (or press Alt+B, and R in that order).

Explanation of each area

The Register window consists of the following areas:

- (1) Upper left field (program register display area)
- (2) Lower left field (system register display area)

(1) Upper left field (program register display area)

r0 (zero)	00000000
r1	00108000
r2	00000002
r3 (sp)	001003DC
r4 (gp)	00108000
r5 (tp)	00000000
r6	00100014
r7	0000000A

This area is used to display or change the contents of program registers.

The new value is written into the target when the Enter key is pressed. The previous value can be canceled by the ESC key.

This area is also used as a jump pointer of the jump function.

(2) Lower left field (system register display area)

pc	000005A2
eipc	000005A2
+eipsw	00000001
fepc	00000000
+fepsw	000000FF
+ecr	00000080
+psw	00000001

This area is used to display or change the contents of system registers.

The new value is written into the target when the Enter key is pressed. The previous value can be canceled by the ESC key.

If the name of a register with '+' prefixed is double-clicked, the names and values of its flags are displayed, and '+' changes to '-'. This '+' can be also changed to '-' by selecting a register name with the arrow keys and pressing the Enter key.

This area is also used as a jump pointer of the jump function.

Functions often used (right-click menu)

In this window, functions that are often used can be selected from the menu that is displayed by clicking the right mouse button. In this way, the same function can be used more easily than with the normal procedure.

Add Watch	Registers a selected character string to the Watch window. Opens the Add Watch dialog box.
-----------	---

Bin	Displays the selected line in binary numbers.
Oct	Displays the selected line in octal numbers.
Dec	Displays the selected line in decimal numbers.
Hex	Displays the selected line in hexadecimal numbers (default).
Pick Up	Displays only the registers selected in Register Select dialog box. Checked: Displays only the selected register. Not checked: Displays all the registers (default).
Select...	Opens the Register Select dialog box.

Function buttons

Refresh	Updates the contents of the window with the latest data.
Close	Closes this window.

Related operations

To change a register value

To change the value of a register, move the cursor to the system register display area or program register display area in the window, and directly write a value from the keyboard.

Press the return key to set the new value. To cancel the change, press the ESC key.

To select the register to be displayed

Use the Register Select dialog box, which can be opened by selecting right-click menu -> [Select...] in the Register window.

Register Select dialog box

This dialog box is used to select registers that are not displayed in the Register window.

Figure 7-42 Register Select Dialog Box

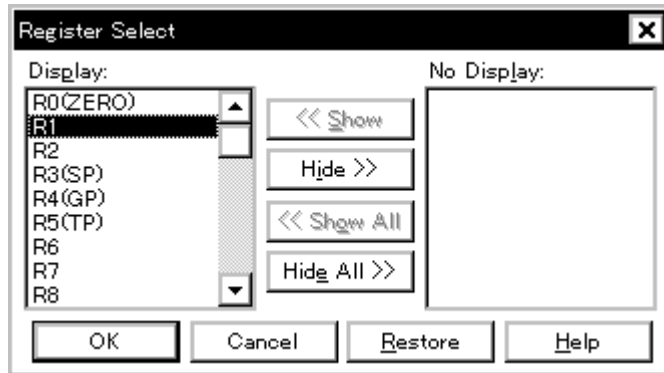

This section explains the following items:

- Opening
- Explanation of each area
- Function buttons

Opening

This dialog box can be opened as follows:

When Register window is the current window,

- Select [View] -> [Select...] from the menu bar (or press Alt+V, and E in that order).

Explanation of each area

The Register Select dialog box consists of the following area:

- (1) Display, No Display (display register selection area)

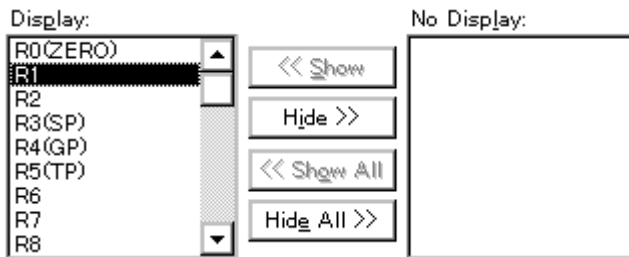
(1) Display, No Display (display register selection area)

This area is used to select registers that are displayed in the Register window, and those that are not.

Display	Registers displayed in the Register window.
No Display	Registers not displayed in the Register window.

To display or not display a register in the Register window, select a register name from these lists, and click the <<<Show> or <Hide>>> button. To display all the registers, click the <<<Show All> button. To not display any of the registers, click the <<<Hide All> button.

The function of each button is as follows:

<< Show	Moves the register selected from the No Display list to Display .
Hide >>	Moves the register selected from the Display list to No Display .
<< Show All	Moves all registers to Display .
Hide All >>	Moves all registers to No Display .

When selecting a register from the lists, two or more registers can be selected by clicking any of the above buttons while holding down the Ctrl or Shift key.

Function buttons

OK	Reflects the selection in this dialog box in Register window and closes this dialog box.
Cancel	Cancels the changes and closes this dialog box.
Restore	Restores the original status.
Help	Opens the Help window.

IOR window

This window is used to display and change the contents of peripheral I/O registers and the I/O ports that have been registered in the Add I/O Port dialog box.

Note, however, that the values of read-only peripheral I/O registers and I/O ports cannot be changed. In addition, the peripheral I/O registers and I/O ports that cause the device to operate when they are read are read-protected and therefore cannot be read.

To read these registers, select a register, and select and execute [Compulsion Read] from the right-click menu.

Reference If the device supports programmable I/O registers and a programmable I/O area has been set in the Configuration dialog box, the programmable I/O registers are also displayed. If the value of an I/O port address is defined, the I/O port name is displayed in light color.

Figure 7-43 IOR Window

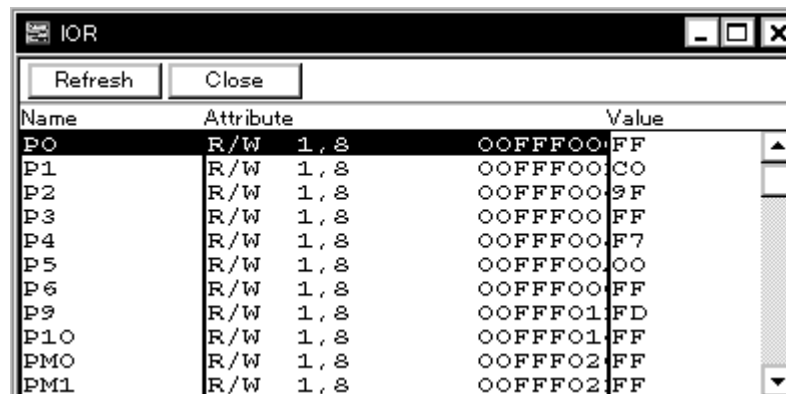

The screenshot shows a window titled "IOR" with "Refresh" and "Close" buttons. Below the buttons is a table with three columns: "Name", "Attribute", and "Value". The table lists several entries, including P0 through P10 and PM0 through PM1. The "Attribute" column shows "R/W" and "1, 8". The "Value" column shows hexadecimal values. The entries for P0 through P10 are highlighted in black.

Name	Attribute	Value
P0	R/W 1, 8	00FFFF00FF
P1	R/W 1, 8	00FFFF00C0
P2	R/W 1, 8	00FFFF009F
P3	R/W 1, 8	00FFFF00FF
P4	R/W 1, 8	00FFFF00F7
P5	R/W 1, 8	00FFFF0000
P6	R/W 1, 8	00FFFF00FF
P9	R/W 1, 8	00FFFF01FD
P10	R/W 1, 8	00FFFF01FF
PM0	R/W 1, 8	00FFFF02FF
PM1	R/W 1, 8	00FFFF02FF

This section explains the following items:

- Opening
- Explanation of each area
- Functions often used (right-click menu)
- Function buttons
- Related operations
 - To change a peripheral I/O register value
 - To select a peripheral I/O register or I/O port to be displayed
 - To change the display sequence
 - To change the display radix
 - To add, change the contents of, and delete a user-defined I/O port
 - To change the display start position

Opening

This window box can be opened as follows:

- Click the **IOR** button.
- Select **[Browse] -> [I/O Register]** from the menu bar (or press Alt,+B, and G in that order).

Explanation of each area

The IOR window consists of the following areas:

- (1) Name (peripheral I/O register name display area)
- (2) Attribute (attribute display area)
- (3) Value (peripheral I/O register contents display area)

(1) Name (peripheral I/O register name display area)

```
Name
P0
P1
P2
P3
P4
P5
P6
P7
P8
P9
P10
PM0
PM1
```

This area displays the names of peripheral I/O registers and I/O ports.

When the V850E is used, it also displays the programmable peripheral I/O registers and expansion peripheral I/O registers.

If the value of an I/O port address is not defined, the I/O port name displayed in light color.

(2) Attribute (attribute display area)

```
Attribute
R/W 1, 8 00FFFF00
R/W 1, 8 00FFFF01
R/W 1, 8 00FFFF02
R/W 1, 8 00FFFF03
R/W 1, 8 00FFFF04
R/W 1, 8 00FFFF05
R/W 1, 8 00FFFF06
R/W 1, 8 00FFFF07
R/W 1, 8 00FFFF08
R/W 1, 8 00FFFF09
R/W 1, 8 00FFFF0A
R/W 1, 8 00FFFF0B
```

This area displays the read/write attributes, access types, and absolute addresses of the peripheral I/O registers and I/O ports. when the bit peripheral I/O register is displayed, bit-offset value is also displayed.

It can be specified whether this area is displayed or not, by selecting **[View] -> [Attribute]** from the

menu bar. As an attribute, the following contents are displayed.

Read/Write Attribute

R	Read only
W	Write only
R/W	Read/write
*	Register that is read via an emulation register to prevent the device from operating when this register is read. To read this attribute directly from a peripheral I/O register, execute [View] -> [Compulsion Read] from the menu bar. Even a write-only peripheral I/O register can also be read via an emulation register. However, some devices do not support this function.

Access Type

1	Can be accessed in bit units.
8	Can be accessed in byte units.
16	Can be accessed in halfword units.
32	Can be accessed in word units.

(3) Value (peripheral I/O register contents display area)

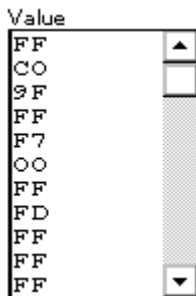

This area is used to display and change the contents of a peripheral I/O register and I/O port.

The contents are displayed differently as follows, depending on the attribute:

Black Display	Read only or read/write
--	Write only
**	Value changes if read

The new value is written into the target when the Enter key is pressed. The previous value can be canceled by the ESC key.

The value of read-protected peripheral I/O registers and I/O ports can be read by selecting right-click menu -> [Compulsion Read].

Functions often used (right-click menu)

In this window, functions that are often used can be selected from the menu that is displayed by clicking the right mouse button. In this way, the same function can be used more easily than with the normal procedure.

Move...	Moves the display position. Opens the Address Move dialog box.
Add Watch	Registers a selected character string to the Watch window. Opens the Add Watch dialog box.
Add I/O Port ...	Adds user-defined I/O ports. Opens the Add I/O Port dialog box.
Bin	Displays the selected line in binary numbers.
Oct	Displays the selected line in octal numbers.
Dec	Displays the selected line in decimal numbers.
Hex	Displays the selected line in hexadecimal numbers (default).
Sort By Name	Displays in alphabetical order.
Sort By Address	Displays in address order (default).
Unsort	Does not sort.
Attribute	Displays or does not display an attribute area (Attribute). Checked: Displayed (default) Not checked: Not displayed
Pick Up	Displays only the registers selected in IOR Select dialog box. Checked: Displays only the selected register. Not checked: Displays all the registers (default).
Select...	Opens the IOR Select dialog box.
Compulsion Read	Forcibly reads the peripheral I/O registers that are disabled from being read because their values will be changed, or the data of the I/O ports and I/O protect area added in Add I/O Port dialog box.

Function buttons

Refresh	Updates the contents of the window with the latest data.
Close	Closes this window.

Related operations

To change a peripheral I/O register value

To change the contents of a peripheral I/O register or I/O port, move the cursor to the Value area on the window, and write a value directly from the keyboard.

Press the return key to set the new value. To cancel the change, press the ESC key.

Note that the values of read-only peripheral I/O registers and I/O ports cannot be changed.

To select a peripheral I/O register or I/O port to be displayed

Use the IOR Select dialog box, which can be opened by selecting right-click menu -> [Select...] in the IOR window.

To change the display sequence

The display sequence can be changed by selecting right-click menu -> [Sort By Name/Sort By Address/Unsort].

To change the display radix

Select the line whose radix is to be changed, and select right-click menu -> [Bin/Oct/Dec/Hex].

To add, change the contents of, and delete a user-defined I/O port

To manipulate an I/O port, use the Add I/O Port dialog box, which can be opened by selecting right-click menu -> [Add I/O Port...] in the IOR window.

To change the display start position

Use the Address Move dialog box, which can be opened by selecting right-click menu -> [Move...] in the Assemble window.

IOR Select dialog box

This dialog box is used to select peripheral I/O registers and I/O ports that are not displayed the IOR window.

It is also used to specify the sequence in which registers and ports are displayed.

Figure 7-44 IOR Select Dialog Box

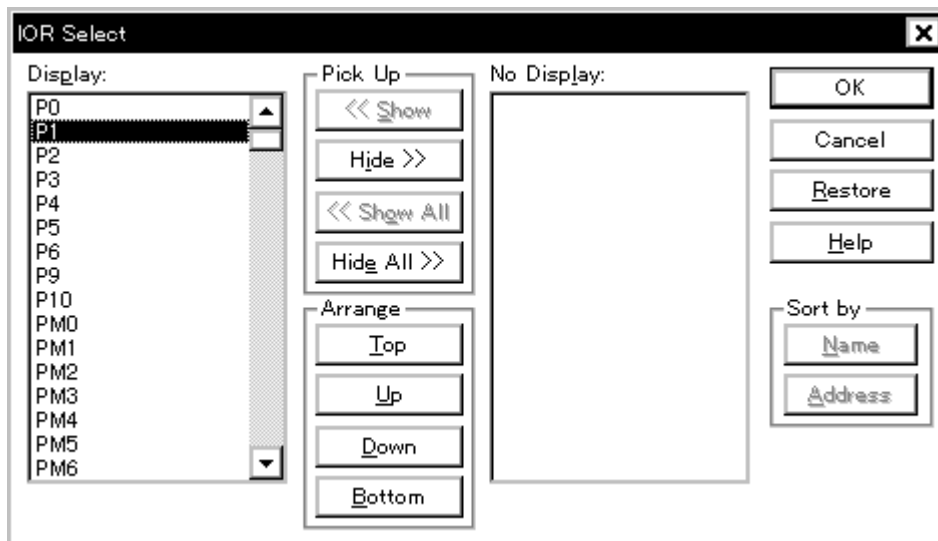

This section explains the following items:

- Opening
- Explanation of each area
- Function buttons

Opening

This dialog box can be opened as follows:

When IOR window is the current window

- Select [V]iew -> [S]elect... from the menu bar (or press Alt+V, and E in that order).

Explanation of each area

The IOR Select dialog box consists of the following areas and buttons:

- (1) Display, Pick Up, No Display (display peripheral I/O register selection area)
- (2) Arrange (display sequence specification button)

(3) Sort by (No Display list display sequence change button)

(1) **Display, Pick Up, No Display** (display peripheral I/O register selection area)

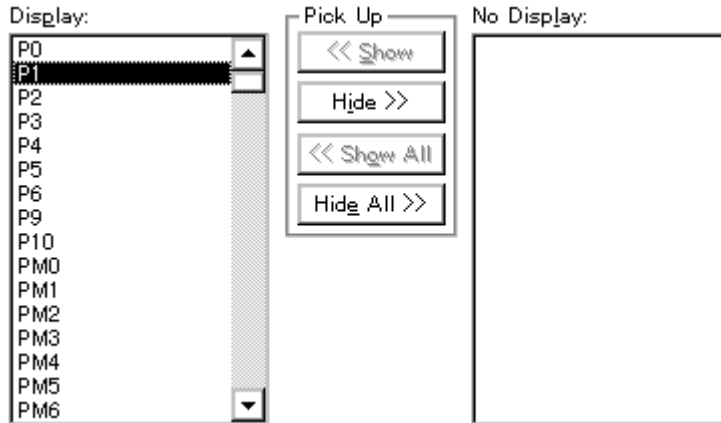

This area is used to select registers and I/O ports that are displayed or not displayed on the IOR window.

Display	Registers and I/O ports are displayed in the IOR window
No Display	Registers and I/O ports are not displayed in the IOR window

To display or not display a register or I/O port in the IOR window, select the name of the register or I/O port from these lists, and click the <<<Show> or <Hide>>> button. To display all the peripheral I/O registers, click the <<<Show All> button; to not display any of the registers, click the <Hide All>>> button.

<< Show	Moves the register or I/O port selected from the No Display list to Display .
Hide >>	Moves the register or I/O port selected from the Display list to No Display .
<< Show All	Moves all the registers and I/O ports to Display .
Hide All >>	Moves all the registers and I/O ports to No Display .

When selecting a peripheral I/O register from the list, two or more registers can be selected by clicking any of the above buttons with the Ctrl or Shift key held down.

(2) **Arrange** (display sequence specification button)



This button sets the sequence in which the registers and I/O ports are displayed in the [Display](#) list.

A peripheral I/O register or I/O port selected in the **Display** list can be moved to the top of the list by pressing the <Top> button, or to the bottom of the list by pressing the <Bottom> button. The <Up> button moves the register or port one line up. The <Down> button moves the register or port one line down.

Top	Moves the selected peripheral I/O register or I/O port to the top of the list.
Up	Moves the selected peripheral I/O register or I/O port one line up.
Down	Moves the selected peripheral I/O register or I/O port one line down.
Bottom	Moves the selected peripheral I/O register or I/O port to the bottom of the list.

(3) Sort by (No Display list display sequence change button)



This button selects the sequence in which peripheral I/O registers and I/O ports are displayed in the **No Display** list.

Pressing the <Name> button sorts the registers and ports into alphabetical order. The <Address> button sorts them into address order.

Name	Displays in alphabetical order.
Address	Displays in address order.

Function buttons

OK	Reflects the selection in this dialog box in IOR window and closes this dialog box.
Cancel	Cancels the changes and closes this dialog box.
Restore	Restores the original status.
Help	Opens the Help window.

Add I/O Port dialog box

This dialog box is used to register an I/O port to be added to the IOR window.

Figure 7-45 Add I/O Port Dialog Box

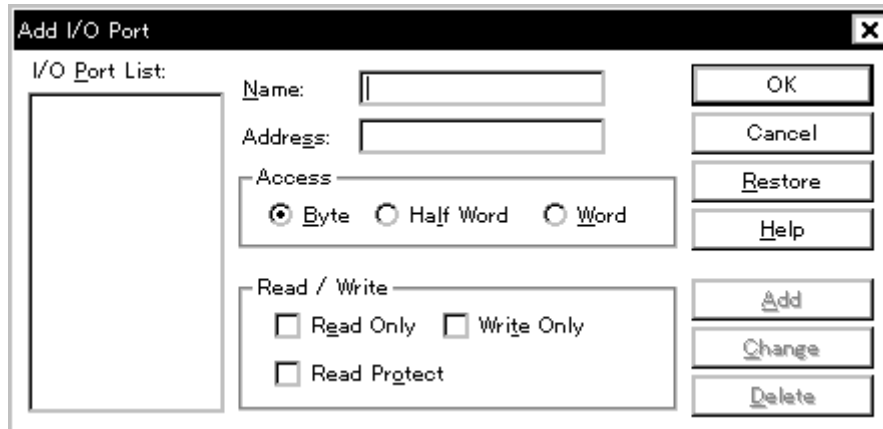

This section explains the following items:

- Opening
- Explanation of each area
- Function buttons

Opening

This dialog box can be opened as follows:

- Select [Option] ->[Add I/O Port...] from the menu bar (or press Alt+O, and P in that order).

Explanation of each area

The Add I/O Port dialog box consists of the following areas:

- (1) I/O Port List: (I/O port selection area)
- (2) Name: (I/O port name specification area)
- (3) Address: (I/O port address specification area)
- (4) Access (access size specification area)
- (5) Read / Write (access attribute specification area)

(1) I/O Port List: (I/O port selection area)

I/O Port List:

This area lists the I/O ports currently registered.

If a new I/O port is registered, it is added to this list. In addition, an I/O port already registered can be selected and changed or deleted.

(2) Name: (I/O port name specification area)Name:

This area is used to specify an I/O port name to be added. An I/O port name can be up to 15 characters long.

(3) Address: (I/O port address specification area)Address:

This area is used to specify the address of the I/O port to be added.

Only an address in one of these areas can be specified: IOR area, Emulation ROM area or Emulation RAM area any of these areas.

An address can be also specified by a symbol or expression (refer to "Table 7-14 Specifying Symbols"). The default radix for inputting a numeric value is hexadecimal.

(4) Access (access size specification area)

Access

 Byte
 Half Word
 Word

This area is used to specify the access size of the I/O port to be added.

Byte	8 bits (default)
Half Word	16 bits
Word	32 bits

(5) Read / Write (access attribute specification area)

Read / Write	
<input type="checkbox"/> Read Only	<input type="checkbox"/> Write Only
<input type="checkbox"/> Read Protect	

This area is used to specify the access attribute of the I/O port to be added.

In the default condition, all the attributes are not checked (i.e., the I/O port can be both read and written).

Read Only	Read only
Write Only	Write only
Read Protect	Read-protected

Function buttons

OK	Reflects the result of addition in IOR window and closes this dialog box.
Cancel	Cancels changes and closes this dialog box.
Restore	Restores the original status.
Help	Opens the Help window.
Add	Adds an I/O port of the specified address.
Change	Changes the setting of the I/O port selected in I/O Port List .
Delete	Deletes the I/O port selected in I/O Port List .

Trace window

The Trace window displays the trace results.

This window is only in the active status and is updated when a break occurs or step execution is performed. The source file can also be displayed with the trace results (refer to "Normal display and mixed display").

A horizontal line (Block information) is displayed to indicate the end of program execution. The cause of stopping the program is displayed when the tracer is stopped (refer to "Table 7-22 Status When Tracer Is Stopped").

The tracer is enabled by selecting [Option] -> [Tracer On] from the menu bar.

To manipulate the tracer during program execution, select [Run] -> [Tracer Start/Stop] from the menu bar.

For details of the trace function, refer to "Trace function".

Figure 7-46 Trace Window

Frame	Time	Address	Data	Status	Address	Data	Status	Jmpaddr	DisAsm
A 4076	4	000002EE	23870500	M1					ld.w 0x4[sp], r12
A 4077					001003C0	00100007	R		
A 4078	33	000002F2	4C5F0000	M1					st.b r11, 0x0[r12]
A 4079					00100007	08	W		
A 4080	2	000002F6	23FF0900	M1					ld.w 0x8[sp], lp
A 4081					001003C4	000001D2	R		
A 4082	35	000002FA	4C1A0000	M1					add 0xc, sp
A 4083	1	000002FC	7F000000	M1					jmp [lp]
A 4084	3	000001D2	235F0500	BRM1				000002FC	ld.w 0x4[sp], r11
A 4085					001003CC	00000167	R		
A 4086	25	000001D6	415A0000	M1					add 0x1, r11
A 4087	2	000001D8	635F0500	M1					st.w r11, 0x4[sp]
A 4088					001003CC	00000168	W		
A 4089	1	000001DC	23870900	M1					ld.w 0x8[sp], r12
A 4090					001003D0	00100007	R		
Compulsory Break									
A 4092	36	000001E0	41620000	M1					add 0x1, r12
A 4093	2	000001E2	63670900	M1					st.w r12, 0x8[sp]
A 4094					001003D0	00100008	W		
Event Break									

This section explains the following items:

- Opening
- Explanation of each area
- Functions often used (right-click menu)
- Function buttons
- Related operations
 - To make the trace function usable
 - To set trace control mode
 - To set a section trace event and quality trace event

- To change the display start position
- To search trace data
- To clear trace data
- To turn on/off the tracer during program execution
- For pick up display
- To display the source text (mixed display mode)
- To select the display item and change the display radix
- To set a time tag counter, count rate, and total time tag

Opening

This window can be opened as follows:

- Click the **TrW** button.
- Select [Browse] -> [Trace] from the menu bar (or press Alt+B, and T in that order).

Explanation of each area

The Trace window consists of the following areas:

- (1) Point mark display area
- (2) Trace mode display area
- (3) Trace result display area

(1) Point mark display area

This area displays Event setting status.

If an execution event or access event is set at the corresponding trace address, the mark corresponding to the type of the event is displayed.

The mark displayed is not that during trace but an event mark that is set when the trace result is displayed.

(2) Trace mode display area

This area displays the types of trace modes.

If a qualify trace condition is satisfied while a section trace condition is satisfied, 'Q' is displayed.

A	Fully or section traced frame
Q	Qualify traced frame
S	Step executed frame
T	Delay trigger frame

(3) Trace result display area

Frame	Time	Address	Data	Status	Address	Data	Status	Jmpaddr	DisAsm
4083	1	000002FC	7F000000	M1					jmp [lp]
4084	3	000001D2	235F0500	BRM1				000002FC	ld.w 0x4[sp], r11
4085					001003CC	00000167	R		
4086	25	000001D6	415A0000	M1					add 0x1, r11
4087	2	000001D8	635F0500	M1					st.w r11, 0x4[sp]
4088					001003CC	00000168	W		

(a) (b) (c) (d) (e) (f)

This area displays the trace results.

This area has two display modes: Normal display and mixed display. In addition, Jump Function and Trace Result with Linking Window can be used in this area.

Whether each of the following sub-areas is displayed or not can be selected in the Trace Data Select dialog box.

(a) Frame (trace frame number display)

This area displays trace frame numbers.

(b) Time (time tag display)

This area displays how many clocks the target chip has required since execution of the preceding trace contents was started until execution of the current trace contents is started. As the display contents, display of the number of clocks or display of time can be selected in the Trace Data Select dialog box. In addition, the division rate of the number of counts can be selected up to 1M in the Extended Option dialog box.

The number of clocks and time tag value correspond as follows:

Table 7-21 Number of Clocks and Time Tag Value

Number of Clocks	Time Tag Value			
	Division rate 1	Division rate 2	Division rate 4	Division rate 8
1	1	1	1	1
2	2	2	2	2
3	3	2	2	2
4	4	3	2	2
5	5	3	2	2
6	6	4	3	2
7	7	4	3	2
8	8	5	3	2
9	9	5	3	2

If <Add Up Timetag> is checked, the total is displayed.

(c) Address Data Status (fetch access display)

This area displays the result of fetching the program.

The display contents of **Address** and **Data** differ depending on the **Status** display.

Status

The following types of statuses are available:

Program fetch display

BRM1	Fetching of first byte of first instruction after branch A line is displayed in blue for emphasis if the fetched address is the top of a symbol.
M1	Fetching of first byte of instruction
Blank	Fetching of sixth or eighth bytes of instruction * With V850E

Snap display

SNAP	Snap display
------	--------------

Reference When a 6-byte or 8-byte instruction code is displayed, the first 4 bytes are displayed in the first frame, and the other bytes are displayed in the second and third frames. If two instructions are executed at the same time, one frame is displayed on two lines. The instruction code at the lower address is displayed on the first line and the instruction code at the higher address is displayed on the second line.

Address Data

Displays addresses and data. The display contents differ as follows, depending on the Status display.

Program fetch display

Address	Displays the fetch address
Data	Displays the fetch data

Snap display

Item	Snap Type	Display Contents
Address	Register	Register name
	Peripheral I/O register	Peripheral I/O register name
	Memory	Memory address
Data	Register	Register value
	Peripheral I/O register	Peripheral I/O register value
	Memory	Memory contents

(d) Address Data Status (data access display)

This area displays the result of accessing data.

Status

R	Data read
W	Data write

(e) Jmpaddress (branch source address display)

The last address of the branch source is displayed only when the status is BRM1.

(f) DisAsm (mnemonic display)

This area displays the result of disassembly (only when the status of fetch access display is BRM1 or M1).

To display instruction codes when two instructions are simultaneously executed, one instruction is displayed on the first line, and the other instruction is displayed on the second line.

Block information

Block information is written if the previous and current execution modes are as follows:

If previous execution mode is real-time execution

-> If the current execution mode is real-time execution (if execution has been stopped once) or step execution.

If previous execution mode is step execution

-> If the current execution mode is real-time execution or step execution with execution address changed.

Cause of stopping tracer

The tracer may be stopped by the following types of causes:

Table 7-22 Status When Tracer Is Stopped

Cause	Meaning
Event Break	Break by event
Trace Full Break	Break because trace memory is full
Non Map Break	A non-mapped break has been accessed.
Write Protect	An attempt has been made to write to a write-protected area.
IOR Illegal	An illegal access is made to a peripheral I/O register.
Relocation Break	A relocation instruction different from the initial setting has been executed.
Step Break	Step execution break
Compulsory Break	Manual break
Stack Overflow	Break by stack overflow
Uninitialize Memory read	Memory not initialized has been read.
Time Over Break	Break because execution time is over.
Target VCC Break	Target VCC break

Table 7-22 Status When Tracer Is Stopped

Cause	Meaning
Latchup Break	Latch-up break
Target Reset Error	Break by target reset error
Target Clock	Target clock break
Trace Stop	Trace stop
Security Protect	A security protected area is accessed.

Normal display and mixed display

In the normal display mode, only the trace result is displayed.

In the mixed display mode, the source file is also displayed along with the trace result.

If a program code corresponds on the program fetch address to be displayed, a source file line is displayed before the line indicating the result of tracing that program fetch address.

Frame	Time	Address	Data	Status	Address	Data	Status	Jmpaddr	DisAsm
4084	3	000001D2	235F0500	BRM1				000002FC	ld.w 0x4[sp], r11
			mem_a++;/* 1 Move the address pointer*/						
4085					001003CC	00000167	R		
4086	25	000001D6	415A0000	M1					add 0x1, r11
4087	2	000001D8	635F0500	M1					st.w r11, 0x4[sp]
4088					001003CC	00000168	W		
4089	1	000001DC	23670900	M1					ld.w 0x8[sp], r12
			mem_b++;/* 1 Move the address pointer*/						
4090					00100300	00100007	R		

The source file line is displayed, emphasized in green.

The display mode can be alternately changed by selecting [View] -> [Mix] from the menu bar.

Caution The mixed display mode is valid only when the load module has been downloaded and symbol information is read, and when a fetch address, fetch data, fetch status, or result of disassembly is displayed.

Jump function

This function allows you to jump to the Source window, Assemble window, Memory window or Coverage window, using the cursor position as a jump pointer (refer to "Jump Function").

To jump from the Trace window, the jump pointer changes as follows, depending on the area in which the cursor is positioned:

Table 7-23 Cursor Position and Jump Pointer

Cursor Position	Jump Pointer
Access Address Display Area	Access address (If the jump destination is the Source window or Assemble window, the fetch address is always used as the jump pointer.)
Access Data Display Area	
Access Status Display Area	
Other	Fetch address

Functions often used (right-click menu)

In this window, functions that are often used can be selected from the menu that is displayed by clicking the right mouse button.

In this way, the same function can be used more easily than with the normal procedure.

Move...	Moves the display position. Opens the Trace Move dialog box.
Trace Clear	Clears the trace data.
Select	Selects the contents to be displayed. Opens the Trace Data Select dialog box.
Pick Up	Performs the setting for pickup display.
Off	Does not pick up and display (default).
Search	Picks up and displays a frame that satisfies the search condition.
Snap	Picks up and displays a snap frame.
BRM1	Picks up and displays the first M1 fetch frame after a program branch.
Mix	Specifies whether the results of assembly are displayed in mixed display mode, or not displayed. Checked: Mixed display Not checked: No display (default)
Window Synchronize	Links the Trace window with the following windows:
Source Text	Links the Source window.
Assemble	Links the Assemble window.
Memory	Links the Memory window.
Coverage	Links the Coverage window.
Source Text	Displays the corresponding source text and source line, using the data value at the cursor position as the jump destination address. If no line information exists at the jump destination address, however, you cannot jump. Opens the Source window. If an active Source window is open, that window is displayed in the forefront (so that it can be manipulated).
Assemble	Disassembles and displays starting from the jump destination address specified by the data value at the cursor position. Opens the Assemble window. If an active Assemble window is open, that window is displayed in the forefront (so that it can be manipulated).
Memory	Displays the memory contents starting from the jump destination address specified by the data value at the cursor position. Opens the Memory window. If an active Memory window is open, that window is displayed in the forefront (so that it can be manipulated).
Coverage	Displays the coverage measurement results starting from the jump destination address specified by the data value at the cursor position. Opens the Coverage window. If an active Coverage window is open, that window is displayed in the forefront (so that it can be manipulated).

Function buttons

Search...	Opens the Trace Search dialog box and searches or picks up trace results. The searched result will be highlighted in the Trace window. This button cannot be selected when a snap frame or BRM1 frame is picked up and displayed. This is the same operation as selecting [View] -> [Search...] from the menu bar.
<<	Searches forward (upward on screen) for a trace result that satisfies the search condition set in the Trace Search dialog box. This button cannot be selected while pickup display is being performed.
>>	Searches backward (downward on screen) for a trace result that satisfies the search condition set in the Trace Search dialog box. This button cannot be selected while pickup display is being performed.
Refresh	Updates the contents of the window with the latest data.
Close	Closes this window.

Related operations

To make the trace function usable

Select and check [Option] -> [Tracer On] from the menu bar. To invalidate the tracer, select [Tracer On] again and remove the check mark.

To set trace control mode

Select [Run] -> [Tracer Control Mode] from the menu bar and select one of the following modes:

Non Stop	Goes around the trace memory and overwrites data from the oldest frame (default).
Full Stop	Goes around the trace memory and then stops the tracer.
Full Break	Goes around the trace memory and then stops the tracer and program execution
Delay Trigger Stop	Traces data by the number of delay count frames and stops the tracer when a delay trigger event has occurred.
Delay Trigger Break	Traces data by the number of delay count frames and stops the tracer and program execution when a delay trigger event has occurred.

To set a section trace event and quality trace event

Use the Trace dialog box which can be opened by clicking the **Trc** button.

To change the display start position

Use the Trace Move dialog box that can be opened by selecting right-click menu -> [Move...] in the Trace window.

To search trace data

Select right-click menu -> [Pick Up] -> [Off] in the Trace window and click the <Search...> button. The Trace Search dialog box will be opened, enabling trace results to be searched.

To clear trace data

Select the right-click menu -> [Trace Clear] in the Trace window.

This will clear the trace buffer (display contents of the Trace window).

To turn on/off the tracer during program execution

To temporarily stop coverage, select [Run] -> [Tracer Stop] from the menu bar during program execution. To resume tracer operation, select [Tracer Start].

This operation can be performed only while the program is being executed.

It cannot be performed if the tracer function is disabled (when [Option] -> [Tracer On] is not checked).

For pick up display

Only specific trace data can be picked up and displayed in the Trace window.

A snap frame, M1 fetch frame, and picking up a frame that satisfies a given search condition can be selected as pickup conditions.

To pick up and display a snap frame or M1 fetch frame

Select right-click menu-> [Snap/BRM1] in the Trace window. A snap frame or M1 fetch frame will be picked up and displayed in the Trace window.

To pick up and display only a frame that satisfies the search condition

Select right-click menu -> [Search] in the Trace window and click the <Search> button. The Trace Search dialog box will be opened, enabling data to be picked up to be set.

To display the source text (mixed display mode)

Select the right-click menu -> [Mix] in the Trace window.

To select the display item and change the display radix

Use the Trace Data Select dialog box, which can be opened by selecting the right-click menu -> [Select...] in the Trace window.

The display radix can be changed in the fetch data display area and access data display area.

To set a time tag counter, count rate, and total time tag

Use the Extended Option dialog box, which can be opened by selecting [Option] -> [Expanded Option...] from the menu bar.

Trace Search dialog box

This dialog box is used to search or pick up trace data in Trace window.

This dialog box is used to search trace data if it is opened by selecting [View] -> [Pick Up] -> [Off] from the menu bar. It is used to pick up and display trace data if it is opened by selecting [View] -> [Pick Up] -> [Search] from the menu bar.

By setting each item and then clicking the <Find Next> button, searching can be started.

By clicking the <Set Find> button, the direction buttons ("<<" and ">>") in the Trace window can be used for the search.

Caution The Trace Search dialog box cannot be called if picking up snap frames and the first M1 fetch frame (BRM1) after program branch is specified using the menu bar or in Trace Data Select dialog box.

Figure 7-47 Trace Search Dialog Box

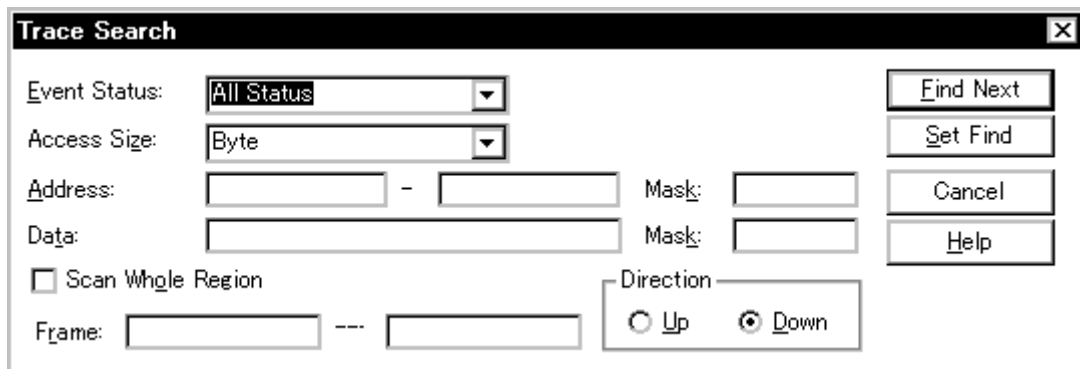

This section explains the following items:

- Opening
- Explanation of each area
- Function buttons

Opening

This dialog box can be opened as follows:

When Trace window is the current window

- Click the <Search> button.
(or press Ctrl+G).
- Select [View] -> [Search...]
(or press Alt+V, and S in that order).

Explanation of each area

The Trace Search dialog box consists of the following areas:

- (1) Event Status (status selection area)
- (2) Access Size (access size selection area)
- (3) Address, Mask (address setting area)
- (4) Data, Mask (data setting area)
- (5) Scan Whole Region (search condition specification area)
- (6) Direction (search direction specification area)
- (7) Frame (search range specification area)

(1) Event Status (status selection area)

Event Status:

This area is used to set and select a status condition.

A status condition can also be specified in abbreviated form. Uppercase and lowercase characters are not distinguished.

If a status condition is omitted, all frames (All status) are searched.

Table 7-24 Types of Status Conditions

Status	Abbreviation	Meaning
All status	ALL	All frames (default)
BRM1 Fetch	BRM1	First M1 fetch after program branch
M1 Fetch	M1	M1 fetch (including BRM1)
R/W	RW	Data read/write (including R, W)
Read	R	Data read
Write	W	Data write

(2) Access Size (access size selection area)

Access Size:

This area is used to set and select an access size condition.

By specifying an access size condition, the access width of a data condition to be detected by an access event is determined.

An access size condition can also be specified in abbreviated form. Uppercase and lowercase characters are not distinguished.

Table 7-25 List of Access Size Conditions (Trace)

Size	Abbreviation	Meaning
Byte	B	Searches for a data condition with 8-bit width (only during 8-bit access).
Half Word	HW	Searches for a data condition with 16-bit width (only during 16-bit access).
Word	W	Searches for a data condition with 32-bit width (only during 32-bit access).
No Condition	NC	Does not search based on access size (nothing can be input to the Data area).
Bit	1	<p>Searches for a data condition with 1-bit width (only during 8-bit access).</p> <p>In this case, a search is made for a data condition with 1-bit width. Because of the operation of the simulator, access to a bit is not directly detected; the simulator searches a dummy bit access by internally setting address conditions and data conditions as follows:</p> <p>Input example: Address: FE20.1 Data: 1</p> <p>Setting of trace search Address: fe20 Data: 00000010B Mask: 11111101B</p> <p>If another bit of the same address is accessed or if all the 8 bits of the same address are accessed, therefore, an event is detected in accordance with the specified status if the address and bit match the specified value of [address.bit].</p>

Caution If an access event is specified as a status condition, the alternative of Bit is not displayed. If Bit or 1 is specified, an error occurs.

If no access size condition is specified, a judgment is automatically made from the address condition and data condition, and the following is set:

- Bit if the address condition is set in bit units
- Byte if the address condition is set in 8-bit units
- Half Word if the address condition is set in 16-bit units
- Word if the address condition is set in 32-bit units
- No Condition if no data condition is specified

(3) **Address, Mask (address setting area)**

Address: - Mask:

[Address](#), which sets an address value and [Mask](#), which sets the mask value of an address value, are

set as address conditions.

An address can be also specified by a symbol or expression (refer to "Table 7-14 Specifying Symbols"). The default radix for inputting a numeric value is hexadecimal.

Both the address and mask may be omitted.

The following can be set:

Table 7-26 Settable Range of Address Condition

Settable range	Condition
0 =< address value =< 0xFFFFFFFF	None
0 =< mask value =< 0xFFFFFFFF	None

Address

Set an address condition.

The following can be set:

Set Point	Set a value to only the lower address, or set the same value to the lower address and the higher address. Mask can be set.
Set Range	Set a value to the lower address and the higher address. Mask cannot be set.
Setting of Bit	Set a value to only the lower address, or set the same value to the lower address and the higher address. Specify a value in the form of address.bit . Mask cannot be set. The value of bit, which indicates the bit position, must be 0 =< bit =< 7.

Mask

Set a mask value for an address value (only when a point is specified).

The address value of a bit whose mask value is 1 may be 0 or 1.

Example 1:

Address	0x4000 to 0x4000
Mask	0xFF

With this setting, addresses 0x4000 to 0x40FF satisfy the condition.

Example 2:

Address	0x4000 to 0x4000
Mask	0x101

With this setting, addresses 0x4000, 0x4001, 0x4100, and 0x4101 satisfy the condition.

(4) Data, Mask (data setting area)

Data: Mask:

Data, which sets an data value, and **Mask**, which sets the mask value of an data value, are set as data conditions.

The default radix for inputting a numeric value is hexadecimal.

Both the data and mask may be omitted.

The settable range differs as follows depending on the access size condition specified in the **Access Size** area.

Table 7-27 Settable Range of Data Condition

Access Size	Settable range
Byte	0 =< data value =< 0xFF 0 =< mask value =< 0xFF
Half Word	0 =< data value =< 0xFFFF 0 =< mask value =< 0xFFFF
Word	0 =< data value =< 0xFFFFFFFF 0 =< mask value =< 0xFFFFFFFF
Bit	Data value = 0 or 1 Mask value = Cannot be specified.

Data

Set a data value. Specify a value within the settable range.

A symbol or expression can be also specified by a symbol or expression (refer to "Table 7-14 Specifying Symbols").

Mask

Set a mask value for the data value.

When a mask is set, the data value for the bit whose mask value is 1 may be 0 or 1.

The data value for a bit whose mask value is 1 may be 0 or 1.

Example 1:

Data	0x4000
Mask	0xFF

With this setting, addresses 0x4000 to 0x40FF satisfy the condition.

Example 2:

Data	0x4000
Mask	0x101

With this setting, addresses 0x4000, 0x4001, 0x4100, and 0x4101 satisfy the condition.

(5) Scan Whole Region (search condition specification area)

Scan Whole Region

This area is used to specify whether the specified range is fully searched or not.

Checked	Searches the entire range.
Not checked	Searches the remaining part of the range (default)

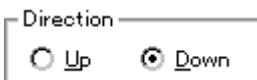
(6) Direction (search direction specification area)

This area is used to specify the direction of the search.

Up	Forward search. Searches data forward (upward on screen) from the current position of the cursor.
Down	Backward search (default). Searches data backward (downward on screen) from the current position of the cursor.

(7) Frame (search range specification area)

Frame: ---

This area is used to specify a frame number to be searched.

For how to specify a frame number, refer to "Table 7-13 Frame Number Specification Format".

The default radix for inputting a numeric value is decimal.

Function buttons

Find Next	Searches the specified data in accordance with a given condition. If the specified frame is found as a result of a search, it is highlighted. To continue searching, click this button again.
Set Find	Sets the specified condition as the search condition and closes this dialog box.
Pick Up (Stop (during search))	Picks up according to the specified condition of data search. If a frame that satisfies the condition is found as a result of a search, it is picked up. To pick up a frame that satisfies a different condition, press this button again.
Cancel	Closes this dialog box.
Help	Opens the Help window.

Trace Data Select dialog box

This dialog box is used to select items to be displayed in the Trace window.

Figure 7-48 Trace Data Select Dialog Box

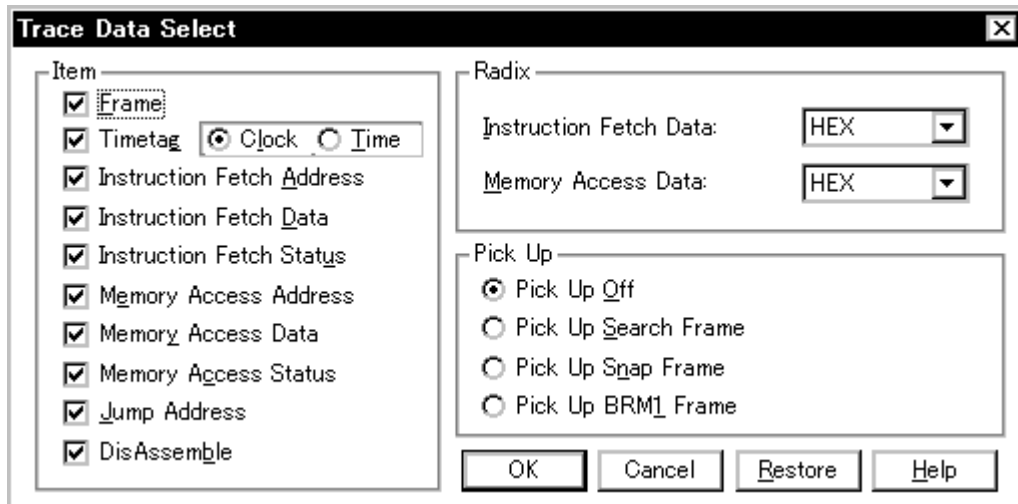

This section explains the following items:

- Opening
- Explanation of each area
- Function buttons

Opening

This dialog box can be opened as follows:

When Trace window is the current window

- Select [View] -> [Select...] from the menu bar (or press Alt+ V, and E in that order).

Explanation of each area

The Trace Data Select dialog box consists of the following areas:

- (1) Item (trace display item selection area)
- (2) Radix (trace display radix selection area)
- (3) Pick Up (pickup selection area)

(1) Item (trace display item selection area)

Item

Frame

Timetag Clock Time

Instruction Fetch Address

Instruction Fetch Data

Instruction Fetch Status

Memory Access Address

Memory Access Data

Memory Access Status

Jump Address

DisAssemble

This area is used to select items to be displayed in the Trace window. Displaying the following items may or may not be selected. The field checked is displayed.

Frame	Frame number display field
Timetag	Time tag display field Whether the clock or time is displayed can be selected. Clock... Clock display (default) Time... Time display
Instruction Fetch Address	Fetch address display field
Instruction Fetch Data	Fetch data display field
Instruction Fetch Status	Fetch status display field
Memory Access Address	Access address display field
Memory Access Data	Access data display field
Memory Access Status	Access status display field
Jump Address	Branch source address display field
DisAssemble	Disassemble display field

(2) Radix (trace display radix selection area)

Radix

Instruction Fetch Data:

Memory Access Data:

This area is used to select the radix in which data is to be displayed. Displaying the following items may or may not be selected.

Display field

Instruction Fetch Data	Fetch data display field
Memory Access Data	Access data display field

Display radix

HEX	Hexadecimal display
DEC	Displays decimal numbers.
OCT	Displays octal numbers.
BIN	Displays binary numbers.

(3) Pick Up (pickup selection area)

Pick Up

Pick Up Off

Pick Up Search Frame

Pick Up Snap Frame

Pick Up BRM1 Frame

This area is used to select a pick up condition.

Pick Up Off	No pick up display
Pick Up Search Frame	Picks up and displays a frame that satisfies the search condition.
Pick Up Snap Frame	Picks up and displays a snap frame.
Pick Up BRM1 Frame	Picks up and displays the first M1 fetch frame after a program branch.

Function buttons

OK	Reflects the results of selection in this dialog box in Trace window.
Cancel	Closes this dialog box.
Restore	Restores the original status.
Help	Opens the Help window.

Coverage window

This window displays the coverage results.

The coverage results are displayed only in the range of 0x0 to 0xFFFFFFFF and the range specified in the Coverage-Address dialog box.

Coverage measurement is performed by selecting [Option] -> [Coverage ON]. While the program is executed, coverage measurement is manipulated by [Run] -> [Coverage Start/Stop] from the menu bar.

The Coverage window has two window statuses: Active Status and Static Status.

Figure 7-49 Coverage Window

Addr	0	1	2	3	4	5	6	7	8	9	A	B	C	D	E	F
00000000	Ⓢ	Ⓢ	Ⓢ	Ⓢ	A	A	\$	\$	R	R	.	.	X	X	X	
00000010	.	.	R	R	W	W	W	W	A	A	A	A	A	A	W	
00000020	A	A	A	A	.	R	W	.	W	W	
00000030	X	X	X	X	X	X	.	.	Ⓢ	Ⓢ	Ⓢ	Ⓢ	Ⓢ	#	#	
00000040	Ⓢ	Ⓢ	A	A	A	A	A	A	R	A	\$	Ⓢ	Ⓢ	Ⓢ	Ⓢ	
00000050	\$	\$	A	A	A	A	A	A	A	A	A	A	A	A	A	
00000060	A	A	A	A	A	A	A	A	A	A	A	A	A	A	A	
00000070	#	Ⓢ	A	A	X	Ⓢ	A	A	A	A	Ⓢ	Ⓢ	A	A	Ⓢ	
00000080	Ⓢ	Ⓢ	Ⓢ	Ⓢ	#	#	#	#	X	X	X	X	X	X	X	
00000090	Ⓢ	Ⓢ	Ⓢ	Ⓢ	X	X	X	X	Ⓢ	Ⓢ	Ⓢ	Ⓢ	#	X	X	
000000A0																

This section explains the following items:

- Opening
- Explanation of each area
- Functions often used (right-click menu)
- Function buttons
- Related operations
 - To make the coverage measurement function usable
 - To specify the coverage measurement range
 - To change the display start position
 - To set and display the coverage efficiency display condition
 - To turn on/off coverage during program execution
 - To search the coverage results
 - To clear the coverage result
 - To change the display bytes

Opening

This window can be opened as follows:

- Click the **Cov** button.
- Select **[Browse] -> [Coverage]** from the menu bar (or press Alt+B, and O in that order).
- Select **[Jump] -> [Coverage]** from the menu bar (or press Alt+J and C in that order, or Ctrl+I).

Explanation of each area

The Coverage window consists of the following areas:

- (1) Addr (address display area)
- (2) 01234... (coverage display area)

(1) **Addr** (address display area)

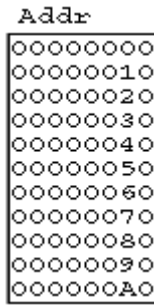

This area displays coverage addresses.

(2) **01234...** (coverage display area)

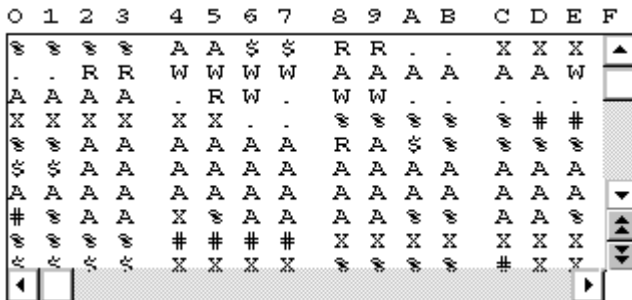

This area displays the coverage results.

To select a display mode, use the [View] menu.

Table 7-28 Status List of Coverage Data

In 1-byte display mode

Display	Meaning
.	Neither execute, read, nor write
X	Execute only
R	Read only
W	Write only
A	Read and write only
\$	Execute and read only
#	Execute and write only
%	Execute, read, and write

In 64-/1024-byte display mode

Display	Meaning
.	Neither execute, read, nor write any addresses in the 64-/1024-byte range
X	Execute all addresses in the 64-/1024-byte range
R	Read all addresses in the 64-/1024-byte range
W	Write all addresses in the 64-/1024-byte range
A	Read and write all addresses in the 64-/1024-byte range
\$	Execute and read all addresses in the 64-/1024-byte range
#	Execute and write all addresses in the 64-/1024-byte range
%	Execute, read, and write all addresses in the 64-/1024-byte range

This area has a jump function and a function to link the trace display.

Functions often used (right-click menu)

In this window, functions that are often used can be selected from the menu that is displayed by clicking the right mouse button. In this way, the same function can be used more easily than with the normal procedure.

Move...	Moves the display position. Opens the Address Move dialog box.
1Byte	Displays in 1-byte units (default).
64Bytes	Displays in 64-byte units.
1024Bytes	Displays in 1024-byte units.

Source Text	Displays the corresponding source text and source line, using the data value at the cursor position as the jump destination address. If no line information exists at the jump destination address, however, you cannot jump. Opens the Source window. If an active Source window is open, that window is displayed in the forefront (so that it can be manipulated).
Assemble	Disassembles and displays starting from the jump destination address specified by the data value at the cursor position. Opens the Assemble window. If an active Assemble window is open, that window is displayed in the forefront (so that it can be manipulated).
Memory	Displays the memory contents starting from the jump destination address specified by the data value at the cursor position. Opens the Memory window. If an active Memory window is open, that window is displayed in the forefront (so that it can be manipulated).
Clear...	Clears the coverage measurement results. Opens the Coverage-Clear dialog box.
Select...	Selects the coverage measurement range as a space of 1 MB or more. Opens the Coverage-Address dialog box.
Condition...	Sets a coverage efficiency measurement condition. Opens the Coverage-Condition Setting dialog box.
Efficiency...	Displays coverage efficiency. Opens the Coverage-Efficiency View dialog box.

Function buttons

Search...	Opens the Coverage Search dialog box and searches a coverage result. The searched result will be highlighted in the Coverage window. This button is valid only in the 1-byte display mode.
<<	Searches forward (upward on screen) for a coverage result that satisfies the search condition set in the Coverage Search dialog box, starting from the address at the cursor position. This button is displayed as the <Stop> button during a search. This button is valid only in the 1-byte display mode.
>>	Searches backward (downward on screen) for a coverage result that satisfies the search condition set in the Coverage Search dialog box, starting from the address at the cursor position. This button is displayed as the <Stop> button during a search. This button is valid only in the 1-byte display mode.
Stop (during search)	Stops searching.
Refresh	Updates the contents of the window with the latest data.
Close	Closes this window.

Related operations

To make the coverage measurement function usable

Select and check [Option] -> [Coverage On] from the menu bar. To disable coverage, select [Coverage On] again.

To specify the coverage measurement range

Use the Coverage-Address dialog box that can be opened by selecting right-click menu -> [Select...] in the Coverage window. A measurement range of 1 MB can be selected from a list.

To change the display start position

Use the Address Move dialog box that can be opened by selecting right-click menu -> [Move...] in the Coverage window.

To set and display the coverage efficiency display condition

Use the Coverage-Condition Setting dialog box, which can be opened by selecting right-click menu -> [Condition...] in the Coverage window.

As the address condition in which coverage efficiency is to be measured, an address range or a function can be specified.

The coverage efficiency status is displayed in the Coverage-Efficiency View dialog box, which can be opened by selecting right-click menu -> [Efficiency...] in the Coverage window.

To turn on/off coverage during program execution

To temporarily stop coverage, select [Run] -> [Coverage Stop] from the menu bar during program execution. To resume operation, select [Coverage Start].

This operation can be performed only while the program is being executed.

It cannot be performed if the coverage function is disabled (when [Option] -> [Coverage On] is not checked).

To search the coverage results

Use Coverage Search dialog box, which can be opened by clicking the <Search...> button in the Coverage window. Data is not searched in a non-mapped area.

To clear the coverage result

Use the Coverage-Clear dialog box that can be opened by selecting right-click menu -> [Clear...] in the Coverage window.

When the coverage measurement result is cleared, the contents of the Coverage window and Coverage-Efficiency View dialog box are initialized.

To change the display bytes

The display bytes can be changed by selecting right-click menu -> [1Byte/64Byte/1024 Byte] in the Coverage window.

Coverage Search dialog box

This dialog box is used to search coverage results in the Coverage window.

This dialog box can be called only in the 1-byte display mode.

By setting each item and then clicking the <Find Next> button, searching can be started.

By clicking the <Set Find> button, the direction buttons ("<<" and ">>") in the Coverage window can be used for the search.

Searching cannot be executed in a non-mapped area.

Figure 7-50 Coverage Search Dialog Box

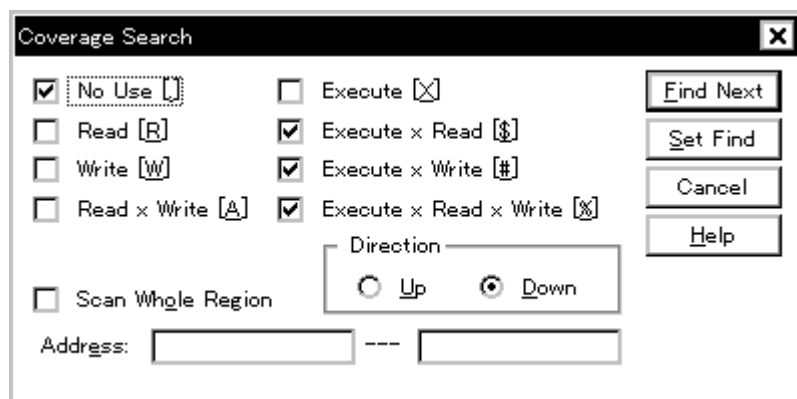

This section explains the following items:

- Opening
- Explanation of each area
- Function buttons

Opening

This dialog box can be opened as follows:

When the Coverage window is the current window

- Click the <Search...> button.
(or press Ctrl+G).
- Select [View] -> [Search...]
(or press Alt+V, and S in that order).

Explanation of each area

The Coverage Search dialog box consists of the following areas:

- (1) Search data specification area

- (2) Scan Whole Region (search condition specification area)
- (3) Direction (search direction specification area)
- (4) Address (search range specification area)

(1) Search data specification area

- No Use [.] Execute [X]
 Read [R] Execute x Read [\$]
 Write [W] Execute x Write [#]
 Read x Write [A] Execute x Read x Write [%]

Specify a search condition by checking any of the check boxes in this area.

If two or more check boxes are checked, the specified address is searched when any of the conditions of the check boxes is satisfied (OR search).

No Use [.]	Neither execute, read, nor write
Read [R]	Read only
Write [W]	Write only
Read x Write [A]	Read and write
Execute [X]	Execute only
Execute x Read[\$]	Execute and read
Execute x Write [#]	Execute and write
Execute x Read x Write [%]	Execute, read, and write

(2) Scan Whole Region (search condition specification area)

- Scan Whole Region

This area is used to specify whether the specified range is fully searched or not.

Checked	Searches the entire range.
Not checked	Searches the remaining part of the range (default)

(3) Direction (search direction specification area)

Direction

Up Down

This area is used to specify the direction of the search.

Up	Forward search. Searches data forward (upward on screen) from the current position of the cursor.
----	--

Down	Backward search (default). Searches data backward (downward on screen) from the current position of the cursor.
------	--

(4) **Address (search range specification area)**

Address: ---

This area is used to specify the address to be searched.

An address can be also specified by a symbol or expression (refer to "Table 7-14 Specifying Symbols"). The default radix for inputting a numeric value is hexadecimal.

Function buttons

Find Next	Searches the specified data in accordance with a given condition. If the specified character string is found as a result of a search, it is highlighted. To continue searching, click this button again.
Set Find	Sets the specified condition as the search condition and closes this dialog box.
Stop (during search)	Stops searching.
Cancel	Closes this dialog box. This button is displayed as the <Stop> button while data is being searched.
Help	Opens the Help window.

Coverage-Clear dialog box

This dialog box is used to clear the coverage measurement results in a specified address range. As a result, the contents of the Coverage window and Coverage-Efficiency View dialog box are initialized.

Figure 7-51 Coverage-Clear Dialog Box



This section explains the following items:

- Opening
- Explanation of each area
- Function buttons

Opening

This dialog box can be opened as follows:

- Select [Option] -> [Coverage] -> [Clear...] from the menu bar (or press Alt+O, O, and L in that order).

Explanation of each area

The Coverage-Clear dialog box consists of the following areas:

- (1) Address Range (address specification area)

(1) Address Range (address specification area)

Address Range: --

This area is used to specify the addresses whose coverage results are to be cleared.

An address can be also specified by a symbol or expression (refer to "Table 7-14 Specifying Symbols"). The default radix for inputting a numeric value is hexadecimal.

Function buttons

OK	Clears the coverage result in the address range specified in Address Range .
Stop (while cleared)	Stops clearing the coverage result.
Cancel	Closes this dialog box. This button is displayed as the <Stop> button while the coverage result is being cleared.
Restore	Restores the input data to the original status.
Help	Opens the Help window.

Coverage-Address dialog box

This dialog box is used to select the coverage measurement range of space of 1 MB or more to be displayed in the Coverage window.

Coverage measurement is executed within the specified address range.

The selectable coverage measurement range is as follows:

- With V850
Any 1 MB space of addresses 0x100000 to 0xFFFFFFFF
(Default: 0x100000 to 0x1FFFFFF)
- With V850E
Any 1 MB space of addresses 0x100000 to 0x3FFFFFFF
(Default: 0x100000 to 0x1FFFFFF)

In addition to the above, a coverage measurement range of a 1 MB space of addresses 0x000000 to 0x0FFFFFFF can be selected.

Figure 7-52 Coverage-Address Dialog Box

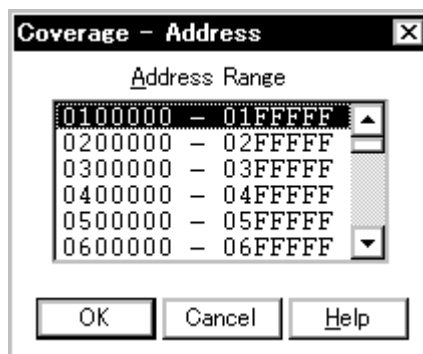

This section explains the following items:

- Opening
- Explanation of each area
- Function buttons

Opening

This dialog box can be opened as follows:

- Select [Option] -> [Coverage] -> [Select...] from the menu bar
(or press Alt+O, O, and S in that order).

Explanation of each area

The Coverage-Address dialog box consists of the following areas:

- (1) Address Range (address selection area)

- (1) **Address Range** (address selection area)

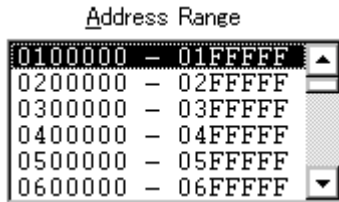

This area is used to select any 1 MB space.

The selected coverage measurement range is set by clicking the <OK> button.

Function buttons

OK	Validates the coverage measurement range selected in Address Range .
Cancel	Closes this dialog box.
Help	Opens the Help window.

Coverage-Condition Setting dialog box

This dialog box is used to specify the contents (condition) to be displayed in the Coverage-Efficiency View dialog box

Up to 16 conditions can be registered.

Figure 7-53 Coverage-Condition Setting Dialog Box

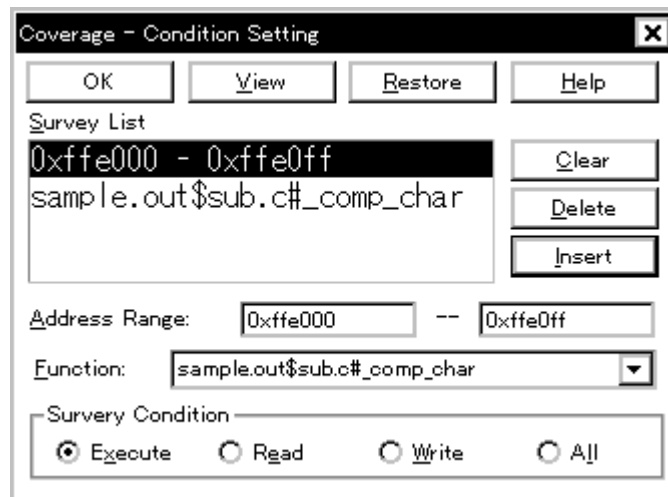

This section explains the following items:

- Opening
- Explanation of each area
- Specifying
- Function buttons

Opening

This dialog box can be opened as follows:

- Select [Option] -> [Coverage] -> [Condition...] from the menu bar (or press Alt+O, O, and O in that order).
- Click the <Condition> button in Coverage-Efficiency View dialog box.

Explanation of each area

The Coverage-Condition Setting dialog box consists of the following areas:

- (1) Survey List (selected list display area)
- (2) Address Range, Function (address condition specification area)

(3) Survey Condition (status condition specification area)

(1) **Survey List** (selected list display area)

Survey List
 0xffe000 - 0xffe0ff
 sample.out\$sub.c#_comp_char

This area displays a list of the conditions currently selected.

(2) **Address Range, Function** (address condition specification area)

Address Range: --
 Function:

This area specifies an address condition for the coverage efficiency.

An address condition can be specified in two ways. To specify a condition as an address range, use [Address Range](#). To specify a condition as a function, use [Function](#).

Address	An address can be also specified by a symbol or expression (refer to "Table 7-14 Specifying Symbols"). The default radix for inputting a numeric value is hexadecimal.
Function	A function can be specified by selecting from the drop-down list or by inputting from the keyboard. Specify a function name that has been registered to the load module file.

(3) **Survey Condition** (status condition specification area)

Survey Condition
 Execute Read Write All

This area is used to select a status condition for the coverage efficiency.

Execute	Percentage of program execution
Read	Percentage of memory read
Write	Percentage of memory write
All	Percentage of program execution, or memory read or write

Specifying

To set a display condition for the coverage efficiency

- 1 Open the Coverage-Condition dialog box.
Select [Option] -> [Coverage] -> [Condition...] from the menu bar
- 2 Specify Survey Condition (in Survey Condition (status condition specification area)).
Select Execute if a function is specified.
- 3 Specify Survey Condition (in Address Range, Function (address condition specification area)).
Specify Address Range or Function (in the address condition specification area).
- 4 Click the <Insert> button.

To delete a display condition for the coverage efficiency

- 1 Opens Coverage-Efficiency View dialog box.
Select [Option] -> [Coverage] -> [Condition...] from the menu bar
- 2 Select the condition to be deleted from Survey List (Survey List (selected list display area)).
- 3 Click the <Delete> button.

Function buttons

OK	Closes this dialog box.
View	Displays coverage efficiency. Opens Coverage-Efficiency View dialog box.
Restore	Restores the input data to the original status.
Help	Opens the Help window.
Clear	Clears the contents of Survey List Survey List (selected list display area).
Delete	Deletes the selected address range or function name from Survey List Survey List (selected list display area).
Insert	Registers the address range or function name specified in Address Range or Function Address Range, Function (address condition specification area) to Survey List Survey List (selected list display area).

Coverage-Efficiency View dialog box

This dialog box displays the coverage efficiency of the coverage results in the range specified in the Coverage-Condition Setting dialog box.

Figure 7-54 Coverage-Efficiency View Dialog Box

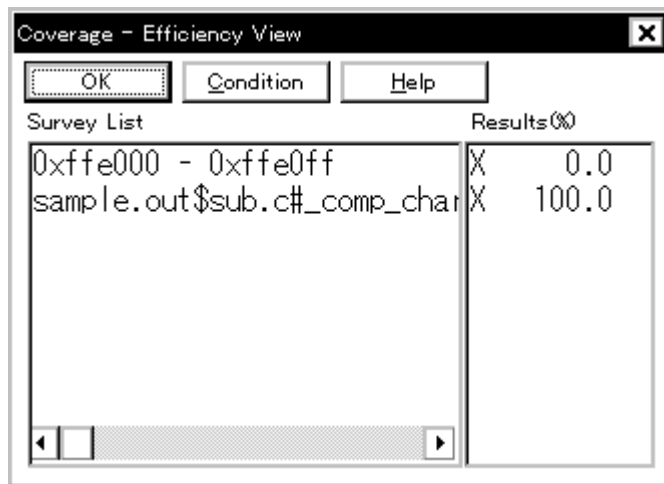

This section explains the following items:

- Opening
- Explanation of each area
- Function buttons

Opening

This dialog box can be opened as follows:

- Select [Option] -> [Coverage] -> [Efficiency...] from the menu bar (or press Alt+O, O, and E in that order).
- Click the <View> button in Coverage-Condition Setting dialog box.

Explanation of each area

The Coverage-Efficiency View dialog box consists of the following areas:

- (1) Survey List (coverage range display area)
- (2) Results(%) (coverage efficiency display area)

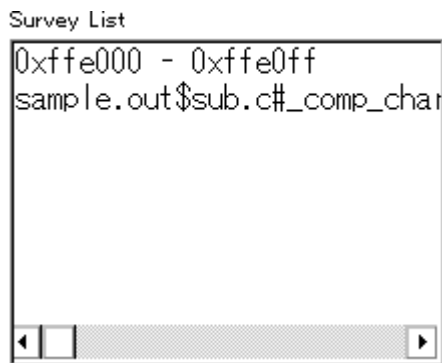
(1) Survey List (coverage range display area)

This area displays the coverage efficiency measurement range.

The area specified in Coverage-Condition Setting dialog box is displayed in this area.

If a function name is specified, "**program name\$file name#function name**" is displayed.

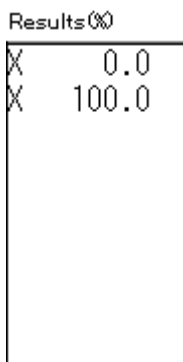
(2) Results(%) (coverage efficiency display area)

This area displays the coverage efficiency.

The coverage efficiency indicates how many specified statuses (execution, read, and write) are included in the measurement range, as a percentage (refer to "Table 7-28 Status List of Coverage Data").

Function buttons

OK	Closes this dialog box.
Condition	Sets the displayed contents of the coverage efficiency. Opens Coverage-Condition Setting dialog box.
Help	Opens the Help window.

Event Manager

This window is used to display, enable or disable, and delete various event conditions.

It is also used to register the various event conditions and manage the event conditions for setting them.

Up to 256 conditions can be registered as event conditions or various event conditions. However, the number of event conditions that can be used (enabled) at the same time is limited as follows:

Table 7-29 Maximum Number of Valid Events for Each Event Condition

Product Name	Event		Event link	Break	Trace	Snapshot	Stub	Timer
	Execution	Access						
SM	64		16	64	64	8	1	8

Figure 7-55 Event Manager

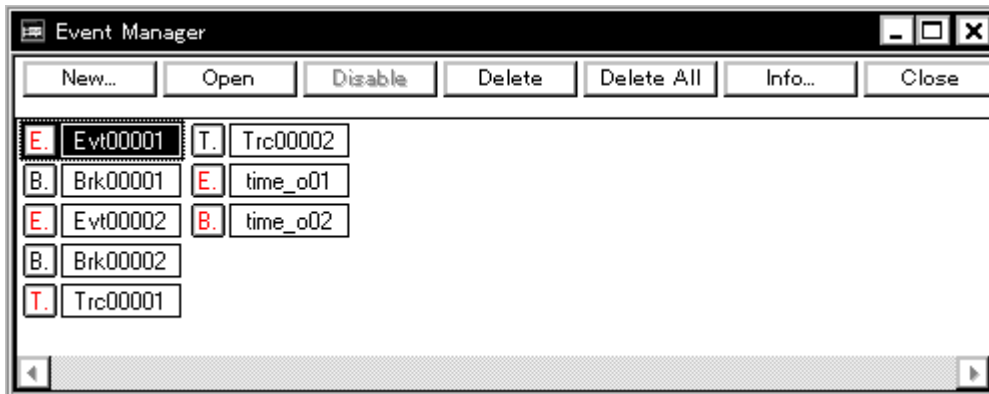

This section explains the following items:

- Opening
- Explanation of each area
- Functions often used (right-click menu)
- Function buttons
 - To save/restore event information
 - To enable/disable an event
 - To change the display sequence of event icons
 - To display details of event condition
 - To delete an event
 - To create an event condition
 - To create an event link condition
 - To set an event condition and event link condition as various event condition

Opening

This window can be opened as follows:

- Click the **Mgr** button.
- Select [Event] -> [Event Manager] from the menu bar (or press Alt+N, and M in that order).

In the Source window

Move the cursor to the source line in the source text display area where an event is set, or to the disassemble line in the mixed display mode.

- Select [View] -> [Event?] from the menu bar (or press Alt+V, and E in that order).

In the Assemble window

Move the cursor to the line in the mnemonic display/change area where an event is set.

- Select [View] -> [Event?] from the menu bar (or press Alt+V, and E in that order).

In the Event dialog box

- Click the <Manager> button (or press Alt+G).

In the Event dialog box

- Click the <Manager> button. (or press Alt+M).

Explanation of each area

The Event Manager consists of the following areas:

- (1) Event display area
- (2) Event details display area

(1) Event display area

[When list is displayed]

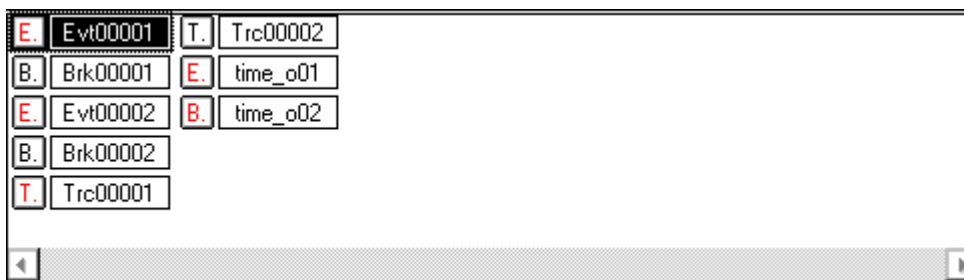

The event display area displays the icons (event icons) of the registered event, event link, break event,

trace event, snapshot event, stub event, and timer event conditions.

An event icon consists of a mark indicating the type of event, and an event name.

By selecting the right click menu -> [Detail], the details can be displayed (refer to "Event details display area").

The meaning of each mark is as follows:

Table 7-30 Marks of Event Icon

Mark	Meaning
E.	Event condition
L.	Event link condition
B.	Break event condition
T.	Trace event condition
S.	Snapshot event condition
U.	Stub event condition
Ti.	Timer event condition

The color of the character on the mark indicates the set status of the event.

Table 7-31 Color of Character on Mark and its Meaning

Character Color	Mark	Meaning
Red	E. L.	Indicates that the various event condition using this event condition or event link condition is enabled.
	B. T. Ti. U. S.	Indicates that this various event condition is enabled. This various event occurs when its condition is satisfied.
Black	E. L.	Indicates that this various event condition using this event condition or event link condition is disabled.
	B. T. Ti. U. S.	Indicates that this various event condition is disabled. This various event does not occur even when its condition is satisfied.
Yellow	E. L.	Indicates that the symbol specified for this event is held pending because it cannot be recognized by the program currently loaded.
	B. T. Ti. U. S.	Indicates that this various event is held pending. The various event does not occur even when its condition is satisfied.

This area also has the following four functions:

Jump function

If the selected icon is that of an event condition, you can jump to the Source window, Assemble window, Memory window, or Coverage window, using an address condition as the jump pointer. You can jump easily by using the right click menu.

The jump pointer will be as follows, depending on the set address condition.

Table 7-32 Address Condition and Jump Pointer

Setting of Address Condition	Jump Pointer
Setting as a point	Specified address
Setting as a range	Lower address (Point address before the mask if a mask is specified)
Setting as a bit	Address at the bit position

The jump destination window will be displayed from the jump pointer.

Open function

Opens the event setting dialog box corresponding to the selected event condition. Each setting dialog box displays the contents of the selected event condition.

Operation

- Double-click the icon, or click the <Open> button with selecting the icon.

Enable status selection function

The event corresponding to the selected icon can be enabled or disabled.

The break, trace, snapshot, stub, and timer events (but not the event and event link conditions) can be manipulated via their icons.

Operation

- 1 Click on the mark of the icon using the left mouse button.
- 2 Click the <Enable> or <Disable> button.

If the event is enabled, it is disabled (black); if the event is disabled, it is enabled (red). The < Enable> button is displayed if the icon of an event that is disabled is selected; the <Disable> button is displayed if the icon of an event that is enabled is selected.

Deletion function

The registered event and set contents of the selected icon can be deleted.

Operation

- 1 Select an icon. Two or more icons can be selected by using Shift and Ctrl keys. To select all the icons, select [View] -> [Select All] from the menu bar.
- 2 Click the <Delete> button or press the DEL key.

Caution An event condition or event link condition can be deleted only when it is not being used for another event condition. If it is being used for another event, delete the event that is using the event condition or event link condition, and then delete the event condition or event link condition.

(2) Event details display area

[In detailed display mode]

E	Evt00001	[S]EX [A]main.c#82(0x44e)
E	Evt00002	[S]EX [A]main.c#94(0x4be)
E	time_o01	[S]W [Z]W [A]time_over(0x100410)
B	Brk00001	[B]Evt00001
B	Brk00002	[B]Evt00002
B	time_o02	[B]time_o01

This area displays the detailed information corresponding to each event icon.

This area is displayed only in the detailed display mode.

Contents are displayed by using the following key information as a separator.

Table 7-33 Separator for Displaying Event Details

Key Information	Contents
Event condition	
[S]	Status condition
[Z]	Access size condition
[A]	Address condition Symbol or expression: (actual address)
[R]	Register condition
[D]	Data condition Symbol or expression: (actual address)
[P]	Pass count condition
[M]	Mask condition
Event link condition	
[P1] - [P4]	Event link condition on "n"th line
[D]	Disable condition
Break condition	
[B]	Break condition
Trace condition	
[M]	Trace mode
[T]	Delay trigger condition
[D]	Delay Count
[S]	Trace start condition
[E]	Trace end condition
[Q]	Qualify trace condition
Timer condition	
[S]	Timer measurement start condition
[E]	Timer measurement end condition
[U]	Timer measurement unit

Table 7-33 Separator for Displaying Event Details

Key Information	Contents
snapshot condition	
[SN]	Snapshot condition
[R]	Register condition
[M]	Memory condition Symbol or expression: (actual address)
[Z]	Access size condition
[G]	Peripheral I/O register condition
Stub condition	
[SU]	Stub condition
[A]	Jump Address Symbol or expression: (actual address)

Functions often used (right-click menu)

In this window, functions that are often used can be selected from the menu that is displayed by clicking the right mouse button. In this way, the same function can be used more easily than with the normal procedure.

Sort By Name	Displays icons in the order of event names.
Sort By Kind	Displays icons in the order of event types.
Unsort	Does not sort icons (default).
Detail	Displays the details.
Overview	Displays a list (default).
Source Text	Displays the corresponding source text and source line, using the position of the selected event as the jump destination address. If no line information exists at the jump destination address, however, you cannot jump. Opens the Source window. If an active Source window is open, that window is displayed in the forefront (so that it can be manipulated).
Assemble	Displays the Assemble window from the position of the selected event, which is used as the jump destination address. Opens the Assemble window. If an active Assemble window is open, that window is displayed in the forefront (so that it can be manipulated).
Memory	Displays the memory contents from the position of the selected event, which is used as the jump destination address. Opens the Memory window. If an active Memory window is open, that window is displayed in the forefront (so that it can be manipulated).

Coverage	Displays the coverage measurement result from the position of the selected event, which is used as the jump destination address. Opens the Coverage window. If an active Coverage window is open, that window is displayed in the forefront (so that it can be manipulated).
----------	--

Function buttons

New...	Opens the dialog box to create new event condition. By clicking each button, the corresponding event setting dialog box can be opened (with the new event name set). After the event setting dialog box has been opened, this dialog box is closed.
Open	Opens the event setting dialog box corresponding to the selected event condition. Each setting dialog box displays the contents of the selected event condition. This button is invalid if no event condition is selected or if two or more event conditions are selected. The Enter key performs the same operation.
Enable/ Disable	Enables or disables the selected various event condition (except event conditions and event link conditions). This button is invalid if an enabled/disabled event condition is not selected.
Delete	Deletes the selected event condition. When an event condition or an event link condition is to be deleted, an error occurs and the event condition or event link condition cannot be deleted if the event is used as a various event condition. This button is invalid if no event condition is selected.
Delete All	Deletes all event conditions.
Info...	Opens the Select Display Information dialog box. This dialog box is used to change the display mode and rearrange event names.
Sort by Name	Sorts events into name order.
Sort by Kind	Sorts events into type order.
Unsort	Displays events in the order in which they have been registered without sorting the events.
Detail	Sets the detailed display mode.
Overview	Sets the list display mode.
Cancel	Closes this dialog box (same as ESC key).
Close	Closes this window.

Related operations

To save/restore event information

Use this window as the current window, and open the View File Save dialog box by selecting [File] -> [Save As...] from the menu bar.

To restore the set status of an event, open the View File Load dialog box by clicking the **Open** button.

By loading an event setting file (*.evn), the previously set event information can be restored.

To enable/disable an event

An event can be enabled or disabled by clicking the mark of the event icon to be changed. By clicking Enable (red), the event can be disabled (black): by clicking Disable (black), the event can be enabled (red).

This change can be also performed on the Event Manager or in each event setting dialog box.

To change the display sequence of event icons

Select the right-click menu -> [Sort B Name/Sort By Kind/Unsort] on the Event Manager.

To display details of event condition

Select the right-click menu -> [Detail] on the Event Manager.

By selecting [Overview], the list can be displayed again.

To delete an event

Select the icon of the event to be deleted, and click the <Delete> button.

Caution An event condition or event link condition cannot be deleted if it is being used for an event. Delete the event first, and then delete the event condition or event link condition.

To create an event condition

Create an event condition in the Event dialog box, which can be opened by clicking the **Evn** button. In addition, an event condition that is created when a hardware break is set in the source can also be used (refer to "Breakpoint setting/deletion function").

To create an event link condition

Create an event link condition in the Event Link dialog box, which can be opened by selecting [Event] -> [Event Link] from the menu bar.

To set an event condition and event link condition as various event condition

Set an event condition or event link condition as a various event condition in the Break dialog box, Trace dialog box, Snap Shot dialog box, Stub dialog box, or Timer dialog box, which can be opened by clicking the corresponding button, such as <Break...> and <Trace...> in the Event dialog box or Event Link dialog box.

By dragging and dropping the event condition to be set from the Event Manager area at the lower part of the screen to the condition setting area on each event setting dialog box, the event condition can be easily set.

Each event setting dialog box can also be opened by selecting from the [Event] menu.

Event dialog box

Registers and displays event conditions.

An event condition registered in this dialog box will be automatically registered to the Event Manager.

As an event condition, one event can be set for two or more event conditions (break, trace, snapshot, stub, timer, and event link).

Up to 256 event conditions can be registered. However, the number of event conditions that can be simultaneously used is limited (refer to "Table 7-29 Maximum Number of Valid Events for Each Event Condition").

Figure 7-56 Event Dialog Box

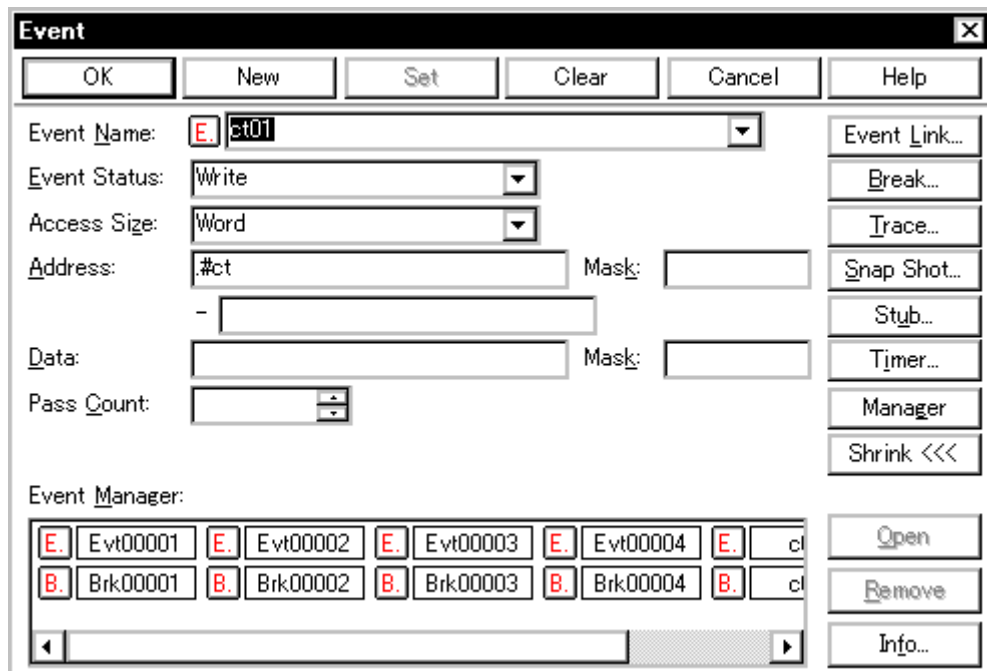

This section explains the following items:

- Opening
- Explanation of each area
- Function buttons

Opening

This dialog box can be opened as follows:

In normal mode

If the Event dialog box is opened as follows, an event condition can be registered without its purpose

being specified.

- Click the **EvN** button.
- Select [Event] -> [Event...] from the menu bar (or press Alt+N, and E in that order).

In select mode

If the <OK> button is pressed when the Event dialog box has been opened as follows, an event condition can be registered in the setting dialog box from which this dialog box was opened.

- In each event setting dialog box
Click the <Add Event> button.
(or press Alt and E in that order).
In the select mode, the setting dialog box from which the Event dialog box was opened is displayed on the title bar.

Explanation of each area

The Event dialog box consists of the following areas:

- (1) Event Name (event name setting area)
- (2) Event Status (status selection area)
- (3) Access Size (access size selection area)
- (4) Address, Mask (address setting area)
- (5) Data, Mask (data setting area)
- (6) Register Name (register setting area)
- (7) Pass Count (external sense data setting area)
- (8) Event Manager (event manager area)

(1) Event Name (event name setting area)

Event Name: E time o01

This area is used to set a event name.

Directly input an alphanumeric string of up to eight characters as a name.

To display the contents of an already created event condition, select from the drop-down list.

In the select mode, the selected event condition can be set in the event condition setting area of the setting dialog box that called the Event dialog box.

The mark on the left of this area indicates the utilization status of events (refer to "Table 7-31 Color of Character on Mark and its Meaning"). The gray E. mark indicates that the event condition is being edited and has not been registered yet.

(2) Event Status (status selection area)

Event Status: Write

This area is used to select a status condition.

By specifying a status condition, the type of the execution event and an access event is determined (if an execution event is specified, nothing can be input to the [Access Size](#), [Address Mask](#), and [Data](#) areas).

The status conditions that can be specified are listed below. A status condition can also be specified in abbreviated form.

Uppercase and lowercase characters are not distinguished in the input status condition.

Table 7-34 List of Status Conditions

<Execution event>

Status	Abbreviation	Meaning
Execution	EX	Program execution

<Access event>

Status	Abbreviation	Meaning
R/W	RW	Data read/write
Read	R	Data read
Write	W	Data write
Access	AC	All access statuses
Register Write	REGW	Register write
Register	REG	Register ^a .
Memory	MEM	Memory ^a .
R/W(Data not Equal)	RWND	Data read/write (An event occurs only if a data condition is not satisfied.) * Displayed only when V850E is selected
Read(Data not Equal)	RND	Data read (An event occurs only if a data condition is not satisfied.) * Displayed only when V850E is selected
Write(Data not Equal)	WND	Data write (An event occurs only if a data condition is not satisfied.) * Displayed only when V850E is selected

- a. The event condition of Register or Memory status can be used for Phase1 of the event link. It cannot be used except for Phase1 of break, trace, snapshot, stub, timer, or event link. These statuses can be used as events of AND condition by being set to Phase1 of event link. Events of AND condition are functions generate events when event conditions set to Phase1 of event link are activated simultaneously. Then event conditions of Execute status can be combined. In case just an event condition of Register or Memory status is set to Phase1 of event link, event conditions of Register status are the same operation as Register Write and those of Memory status are the same operation as Write.

(3) Access Size (access size selection area)

Access Size:

This area is used to set and select an access size condition.

By specifying an access size condition, the access width of a data condition to be detected by an access event is determined.

The access size conditions that can be specified are listed below. An access size condition can also be specified in abbreviated form. Uppercase and lowercase characters are not distinguished in the input access size condition.

Table 7-35 List of Access Size Conditions (Event)

Size	Abbreviation	Meaning
Byte	B	Detects data condition with 8-bit width (only during 8-bit access).
Half Word	HW	Detects data condition with 16-bit width (only during 16-bit access).
Word	W	Detects data condition with 32-bit width (only during 32-bit access).
No Condition	NC	Does not detect access size (nothing can be input to the Data area).
Bit	1	<p>Detects data condition with 1-bit width (only during 8-bit access). In this case, a data condition is detected with 1-bit width. Because of the operation of the simulator, access to a bit is not directly detected; the simulator detects a dummy bit access by internally setting address conditions and data conditions as follows:</p> <p>Input example: Address: fe20 Data: 1</p> <p>Setting to simulator) Address: fe20 Data: 0000010B Mask: 11111101B</p> <p>If another bit of the same address is accessed or if all the 8 bits of the same address are accessed, therefore, an event is detected in accordance with the specified status if the address and bit match the specified value of [address.bit].</p>

When data is written to a bit, all the 8 bits are read/written. If read or read/write is specified as the status, an event occurs if a read operation is performed at this time if the value of the specified [Address.bit] matches.

If no access size is specified, judgment is automatically made from the address condition and data condition, and the following is set:

- Bit if the address condition is set in bit units
- Byte if the address condition is set in 8-bit units
- Half Word if the address condition is set in 16-bit units

- Word if the address condition is set in 32-bit units
- No Condition if no data condition is specified

(4) **Address, Mask (address setting area)**

Address: Mask:
 -

Address, which sets an address value and **Mask**, which sets the mask value of an address value, are set as address conditions.

An address can be also specified by a symbol or expression (refer to "Table 7-14 Specifying Symbols"). The default radix for inputting a numeric value is hexadecimal.

Both the address and mask may be omitted.

Settable range

0 =< data value =< 0xFFFFFFFF

0 =< mask value =< 0xFFFFFFFF

Address

Set an address condition (lower address - higher address).

The following can be set:

Set Point	Set a value to only the lower address, or set the same value to the lower address and the higher address. Mask can be set.
Set Range	Set a value to the lower address and the higher address. Mask cannot be set.
Set Bit	Set a value to only the lower address, or set the same value to the lower address and the higher address. Specify a value in the form of address.bit . Mask cannot be set. The value of bit, which indicates the bit position, must be 0 =<bit =<7.

Mask

Set a mask value for the data value.

When a mask is set, the data value for the bit whose mask value is 1 may be 0 or 1.

The data value for a bit whose mask value is 1 may be 0 or 1.

Example 1:

Data	0x4000
Mask	0xFF

With this setting, addresses 0x4000 to 0x40FF satisfy the condition.

Example 2:

Data	0x4000
-------------	--------

Mask	0x101
------	-------

With this setting, addresses 0x4000, 0x4001, 0x4100, and 0x4101 satisfy the condition.

(5) **Data, Mask (data setting area)**

Data: Mask:

Data, which sets an data value, and **Mask**, which sets the mask value of an data value, are set as data conditions.

The default radix for inputting a numeric value is hexadecimal.

Both the data and mask may be omitted.

The settable range differs as follows depending on the access size condition specified in the **Access Size** area.

Table 7-36 Settable Range of Data Condition

Access Size	Settable range
Byte	0 =< data value =< 0xFF 0 =< mask value =< 0xFF
Half Word	0 =< data value =< 0xFFFF 0 =< mask value =< 0xFFFF
Word	0 =< data value =< 0xFFFFFFFF 0 =< mask value =< 0xFFFFFFFF
Bit	Data value = 0 or 1 Mask value = Cannot be specified.

Data

Set a data value. Specify a value within the settable range.

A symbol or expression can be also specified by a symbol or expression (refer to "Table 7-14 Specifying Symbols").

Mask

Set a mask value for the data value.

When a mask is set, the data value for the bit whose mask value is 1 may be 0 or 1.

The data value for a bit whose mask value is 1 may be 0 or 1.

Example 1:

Data	0x4000
Mask	0xFF

With this setting, addresses 0x4000 to 0x40FF satisfy the condition.

Example 2:

Data	0x4000
------	--------

Mask	0x101
------	-------

With this setting, addresses 0x4000, 0x4001, 0x4100, and 0x4101 satisfy the condition.

(6) Register Name (register setting area)

Register Name:

If **Register Write (REGW)** or **Register (REG)** is selected in Event Status (status selection area) , Address, Mask (address setting area) changes to this area.

Directly input a register name to this area, or select one from the drop-down list.

All the general-purpose registers can be specified. A register name can be specified as both a function name and an absolute name.

Uppercase and lowercase characters are not distinguished.

(7) Pass Count (external sense data setting area)

Pass Count:

This area is used to set a pass count condition (settable range: 1 to 32767).

A pass count specifies how many times an event condition must be satisfied during user program execution before a given condition is satisfied.

If the pass count is set to 1, the condition is satisfied as soon as the event condition has been satisfied.

If no pass count is specified, 1 is assumed.

(8) Event Manager (event manager area)

Event Manager:

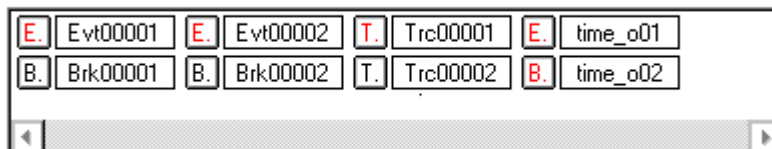

This area displays a list of break, trace and other registered events.

In this area, the following operations can be performed.

Displaying set contents

Select an event and click the <Open> button or double-click the event. The setting dialog box corresponding to the selected event will be opened and the set contents of the event will be displayed.

Delete

A selected event can be deleted by selecting the icon of the event and clicking the <Delete> button or pressing the DEL key while focussing on the event manager area.

Changing display mode and sorting

The display mode of and sorting in the event manager area can be selected by clicking the <Info...> button.

Function buttons

Setting-related buttons	
OK	Automatically registers the event condition being edited, if any, and closes this dialog box. In the select mode An event condition is selected and the setting dialog box (indicated on the title bar) that called the Event dialog box is displayed again. If the calling dialog box has already been closed, the select mode is returned to the normal mode, and the Event dialog box is not closed. Otherwise, this dialog box will be closed.
New	Newly creates an event condition in this dialog box. An event name is automatically created and a new event condition is prepared.
Set (when a new event is created or an event is changed)	Registers each event condition. Because the dialog box is not closed even after an event has been registered, new event conditions can be registered. In the select mode An event condition is selected. If there is an event being edited, it is automatically registered and selected.
Clear (when an event is not edited)	Clears the contents of the event condition. This button is displayed when an event condition has not been edited. This button and the <Restore> button are alternately displayed.
Restore (when an event is edited)	Restores the contents of an edited event condition. If an event condition not registered is displayed, all the fields other than the event name field are blank or the default values are set. This button and the <Clear> button are alternately displayed.
Cancel Close	Closes this dialog box. Even if an event condition is being edited, it is not registered and the dialog box is closed. <Cancel> is displayed if a condition is not created, changed, or deleted; <Close> is displayed if it is.
Help	Opens the Help window.
Buttons for opening each event setting dialog box	
Event Link...	Opens the Event Link dialog box.
Break...	Opens the Break dialog box.
Trace...	Opens the Trace dialog box.
Snap Shot...	Opens the Snap Shot dialog box.
Stub...	Opens the Stub dialog box.
Timer...	Opens the Timer dialog box.
Manager	Opens the Event Manager.
Buttons in event manager area	
Shrink <<< (When area is displayed)	Turns off display of the event manager area. At this time, the size of the dialog box is reduced.
Expand >>> (When area is not displayed)	Displays the event manager area. At this time, the size of the dialog box is expanded.

Open (When only one event is selected)	Opens the event setting dialog box corresponding to the selected event condition. Each setting dialog box displays the contents of the selected event condition. The Enter key performs the same operation.
Remove (When event is selected)	Deletes the selected event condition. When an event condition or an event link condition is to be deleted, an error occurs and the event condition or event link condition cannot be deleted if the event is used as an event condition.
Info...	Opens the Select Display Information dialog box. This dialog box is used to change the display mode and rearrange event names.
Sort by Name	Sorts events into type order.
Sort by Kind	Sorts events into type order.
Unsort	Displays events in the order in which they have been registered without sorting the events.
Detail	Sets the detailed display mode.
Overview	Sets the list display mode.
Cancel	Closes this dialog box (same as ESC key).

Event Link dialog box

This dialog box is used to register and display event link conditions.

A event link condition registered in this dialog box will be automatically registered to the Event Manager.

An event link condition is an event condition that is generated only if the user program is executed in the sequence specified by a set event condition.

Up to four sequences can be specified. If a disable condition is detected while the program is being executed, however, the event conditions that have so far been satisfied are initialized, and the event conditions are detected again starting from the first event condition. If a link condition and a disable condition are detected at the same time, the disable condition takes precedence.

An event link condition can be used for multiple various event conditions. The following various event conditions can use event link conditions:

Table 7-37 Various Event Conditions for Which Event Link Condition Can Be Use

Product name	Break condition	Trace condition	Snapshot condition	Stub condition	Timer condition
SM	OK	OK	OK	OK	OK

Up to 256 event link conditions can be registered. However, the number of event link conditions that can be simultaneously used (valid) is limited (refer to "Table 7-29 Maximum Number of Valid Events for Each Event Condition"). The maximum number of event link conditions simultaneously usable includes the valid event link conditions used for break, trace, snapshot, and stub event condition.

Figure 7-57 Event Link Dialog Box

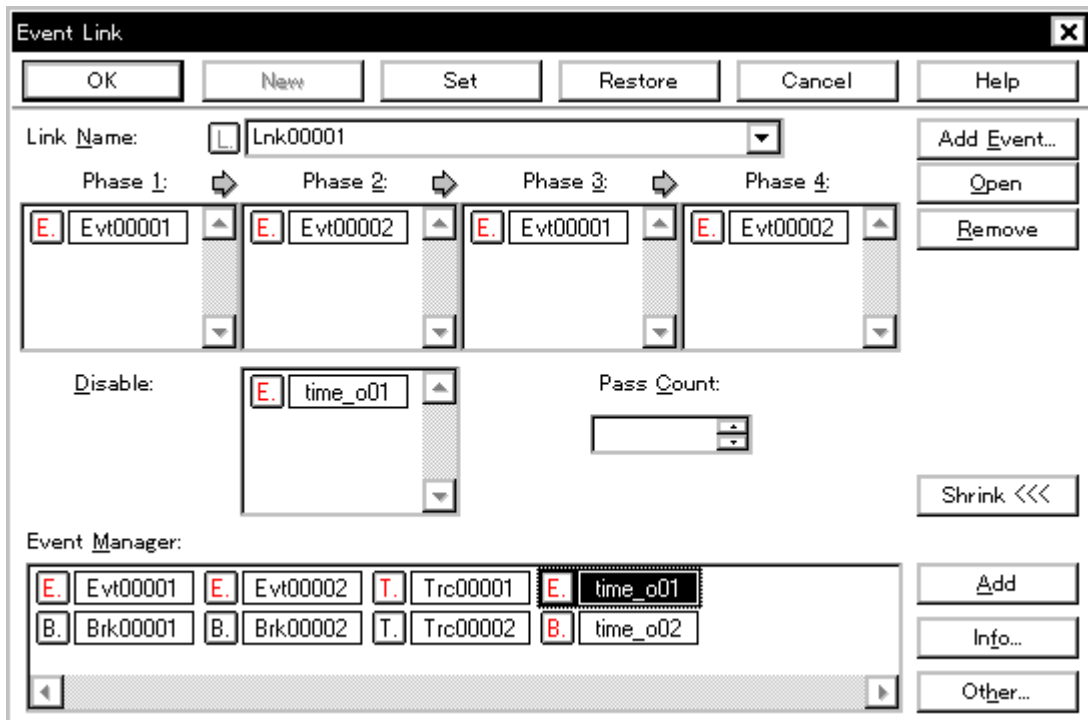

This section explains the following items:

- Opening
- Explanation of each area
- Function buttons

Opening

This dialog box can be opened as follows:

In normal mode

If the Event Link dialog box is opened as follows, an event link condition can be registered without its purpose being specified.

- Select [Event] -> [Event Link...] from the menu bar (or press Alt+N, and L in that order).

In select mode

If the <OK> button is pressed when the Event Link dialog box has been opened as follows, an event link condition can be registered in the setting dialog box from which this dialog box was opened.

- In each various event setting dialog box
Click the <Add Link...> button.
(or press Alt+L, and L in that order).
In the select mode, the setting dialog box from which the Event Link dialog box was opened is displayed on the title bar.

Explanation of each area

The Event Link dialog box consists of the following areas:

- (1) Link Name (event link name setting area)
- (2) Phase1, Phase2, Phase3, Phase4 (link condition setting area)
- (3) Disable (disable condition setting area)
- (4) Pass Count (pass count setting area)
- (5) Event Manager (event manager area)

(1) Link Name (event link name setting area)

Link Name:

This area is used to set a event link name.

Directly input an alphanumeric string of up to eight characters as a name.

To display the contents of an already created event link condition, select from the drop-down list.

In the select mode, the selected event condition can be set in the event link condition setting area of the setting dialog box that called the Event Link dialog box.

The mark on the left of this area indicates the utilization status of event link condition (refer to "Table 7-31 Color of Character on Mark and its Meaning"). The mark "L" in gray indicates that an event link condition is being edited and has not been registered yet.

(2) Phase1, Phase2, Phase3, Phase4 (link condition setting area)

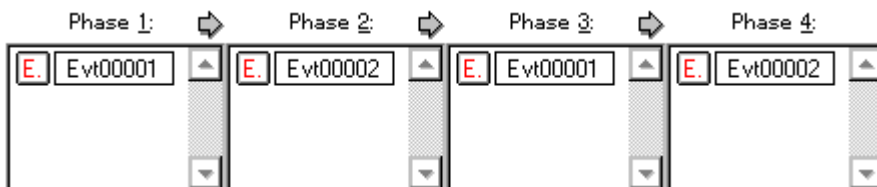

This area is used to specify the sequence in which event conditions and events are detected.

Set Phase 1 -> Phase 2 -> Phase 3 -> Phase 4, in that order. Phase 4 does not have to be set.

in this case, an event occurs when the event condition set for the last phase has been detected. An event condition can be set for only Phase 1 or the same event condition can be set for two or more Phases.

The number of event conditions that can be set for each Phase in this area is up to 10. However, the total number of event conditions settable in this area, including those set in the [Disable](#) area, is 64.

Setting event condition in each area

Select an event condition in the [Event Manager](#) area, and click the <Add> button or drag and drop an event condition. An event link condition can also be set by dragging and dropping not only in this dialog box, but also in the Event Manager area of each various event setting dialog box or the Event Manager.

In addition, the Event dialog box can be opened in "select mode" by clicking the <Add Event...> button,

and the event condition to be set can be selected.

In the event condition setting area in this dialog box, an event condition can be alternately copied or moved by dragging and dropping.

- If an event condition is dropped only by the mouse, it is moved.
- If an event condition is dropped with the Shift key held down, it is moved.
- If an event condition is dropped with the Ctrl key held down, it is copied.

(3) Disable (disable condition setting area)

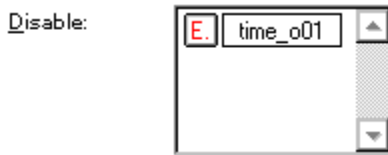

This area is used to set an event condition that invalidates the event conditions that have so far been satisfied (refer to "Setting event condition in each area").

The number of event conditions that can be set in this area is up to 10.

(4) Pass Count (pass count setting area)

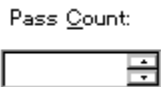

This area is used to set a pass count condition (settable range: 1 to 32767).

A pass count condition specifies how many times an event condition must be satisfied during user program execution before a given condition is satisfied.

If the pass count is set to 1, the condition is satisfied as soon as the event condition is satisfied.

If no pass count is specified, 1 is assumed.

(5) Event Manager (event manager area)

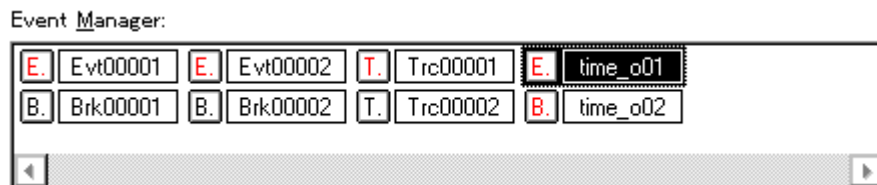

This area displays a list of break, trace and other registered various event conditions.

For details, refer to "Event Manager (event manager area)".

Function buttons

Setting-related buttons	
OK	Automatically registers the event condition being edited, if any, and closes this dialog box. In the select mode An event condition is selected and the setting dialog box (indicated on the title bar) that called the Event Link dialog box is displayed again. If the calling dialog box has already been closed, the select mode is returned to the normal mode, and the Event dialog box is not closed. Otherwise, this dialog box will be closed.
New	Newly creates an event link condition in this dialog box. An event link condition name is automatically created and a new event link condition is prepared.
Set (when a new event link is created or an event link is changed)	Registers the various event condition. Because the dialog box is not closed even after an event has been registered, new event link conditions can be registered. In the select mode An event condition is selected. If there is an event being edited, it is automatically registered and selected.
Clear (when an event is not edited)	Clears the contents of the event link condition. This button is displayed when an event link condition has not been edited. This button and the <Restore> button are alternately displayed.
Restore (when an event is edited)	Restores the contents of an edited event link condition. If an event link condition not registered is displayed, all the fields other than the event name field are blank or the default values are set. This button and the <Clear> button are alternately displayed.
Cancel Close	Closes this dialog box. Even if an event link condition is being edited, it is not registered and the dialog box is closed. <Cancel> is displayed if a condition is not created, changed, or deleted; <Close> is displayed if it is.
Help	Opens the Help window.
Buttons for opening each event setting dialog box	
Add Event...	Opens the Event dialog box in the select mode, and selects or newly creates an event condition to be set. The event condition will be added to the area selected when the < Add Event...> button is pressed.
Other...	Opens the dialog box for selecting the event type. By pressing each of the above buttons, each event setting dialog box can be opened in the new creation status.
Buttons in event manager area	
Shrink <<< (When area is displayed)	Turns off display of the event manager area. At this time, the size of the dialog box is reduced.
Expand >>> (When area is not displayed)	Displays the event manager area. At this time, the size of the dialog box is expanded.

Open (When only one event is selected)	Opens the event setting dialog box corresponding to the selected event condition. Each setting dialog box displays the contents of the selected event condition. The Enter key performs the same operation.
Remove (When event is selected)	Deletes the selected event condition. When an event condition or an event link condition is to be deleted, an error occurs and the event condition or event link condition cannot be deleted if the event is used as a various event condition.
Add	Sets additionally the event condition or event link condition selected in the event manager area to setting area with a focus. The area to be set additionally is the area which was selected when this button was selected.
Info...	Opens the Select Display Information dialog box. This dialog box is used to change the display mode and rearrange event names.
Sort by Name	Sorts events into type order.
Sort by Kind	Sorts events into type order.
Unsort	Displays events in the order in which they have been registered without sorting the events.
Detail	Sets the detailed display mode.
Overview	Sets the list display mode.
Cancel	Closes this dialog box (same as ESC key).

Break dialog box

This dialog box is used to register, set, and display break event conditions.

A break event condition registered in this dialog box will be automatically registered to the Event Manager.

A break event condition automatically becomes valid when it has been registered.

Up to 256 break event conditions can be registered. However, the number of break event conditions that can be simultaneously used is limited (refer to "Table 7-29 Maximum Number of Valid Events for Each Event Condition"). If the maximum number of break event conditions that can be used at the same time is exceeded or if the number of event conditions or event link conditions used exceeds the maximum limit, therefore, register a break event condition in the disabled state.

If [Run] -> [Ignore Break Point] is selected from the menu bar, a break event condition does not operate even if it is valid.

Figure 7-58 Break Dialog Box

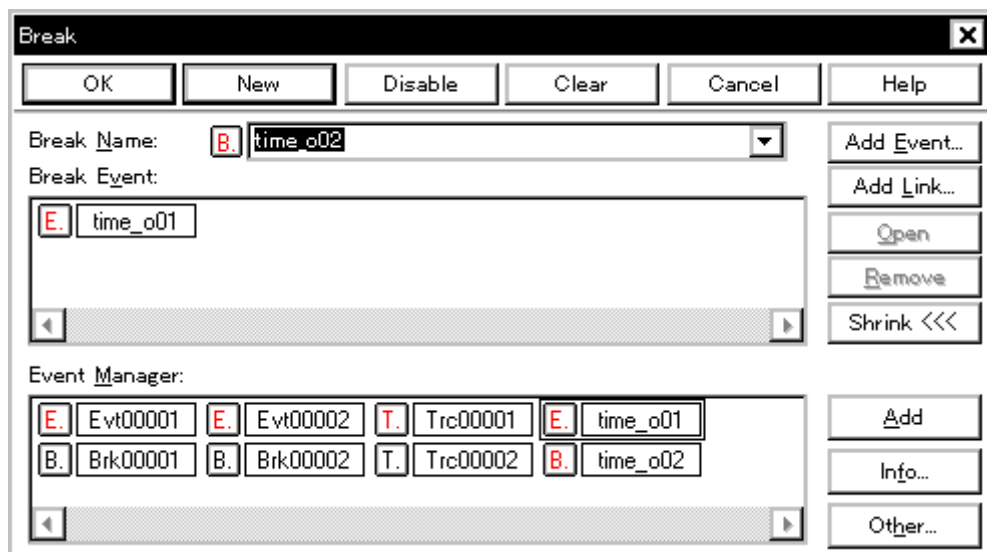

This section explains the following items:

- Opening
- Explanation of each area
- Function buttons

Opening

This dialog box can be opened as follows:

- Click the **Brk** button.
- Select [Event] -> [Break...] from the menu bar (or press Alt+N, and B in that order).

Explanation of each area

The Break dialog box consists of the following areas:

- (1) Break Name (break event name setting area)
- (2) Break Event (break condition setting area)
- (3) Event Manager (event manager area)

(1) Break Name (break event name setting area)

Break Name:  time_o02

This area is used to set a break event name.

Directly input an alphanumeric string of up to eight characters as a name.

To display the contents of an already created event condition, select from the drop-down list.

The mark on the left of this area indicates the utilization status of events (refer to "Table 7-31 Color of Character on Mark and its Meaning"). The gray mark indicates that an event condition is being edited and has not been registered yet.

By clicking the left mark, an event condition can be validated or invalidated.

(2) Break Event (break condition setting area)

Break Event:  time_o01

This area is used to set an event condition for break.

The number of event conditions that can be set in this area, combining execution events and access events, is as follows:

Table 7-38 Number of Events Settable in Break Condition Setting Area

Product Name	Total (execution/access)
SIM	64

The number of event link conditions explained in Maximum Number of Valid Events for Each Event Condition can be used as long as the number of event conditions does not exceed the maximum number of event conditions simultaneously usable.

Setting event condition and event link condition in each area

Select an event condition or event link condition in the [Event Manager](#) area, and click the <Add> button or drag and drop an event condition or event link condition. An event condition or event link condition can also be set by dragging and dropping not only in this dialog box, but also in the Event Manager area of each event setting dialog box and from the Event Manager.

In addition, Event dialog box or Event Link dialog box can be opened in "select mode" by clicking the <Add Event...> or <Add Link...> button, and the event condition or event link condition to be set can be selected.

In the event condition setting area in this dialog box, an event condition can be alternately copied or moved by dragging and dropping.

- If an event condition is dropped only by the mouse, it is moved.
- If an event condition is dropped with the Shift key held down, it is moved.
- If an event condition is dropped with the Ctrl key held down, it is copied.

(3) [Event Manager \(event manager area\)](#)

This area displays a list of break, trace and other registered events.

For details, refer to "Event Manager (event manager area)".

Function buttons

Setting-related buttons	
OK	Automatically registers the event condition being edited, if any, and closes this dialog box. The event condition becomes valid as soon as it has been registered.
New	Newly creates an event condition in this dialog box. An event name is automatically created and a new event condition is prepared.
Set (when a new event is created or an event is changed)	Registers each event condition. Because the dialog box is not closed even after an event has been registered, new event conditions can be registered. Each event condition becomes valid as soon as it has been registered. If an already registered event condition is displayed, the <Enable> or <Disable> button is alternately displayed.
Enable/Disable (when a registered event is displayed)	Validates (enables) or invalidates (disables) the selected event condition. However, event conditions and event link conditions cannot be enabled or disabled. This button and the <Set> button are alternately displayed.
Clear (when an event is not edited)	Clears the contents of the event condition. This button is displayed when an event condition has not been edited. This button and the <Restore> button are alternately displayed.

Restore (when an event is edited)	Restores the contents of an edited event condition. If an event condition not registered is displayed, all the fields other than the event name field are blank or the default values are set. This button and the <Clear> button are alternately displayed.
Cancel Close	Closes this dialog box. Even if an event condition is being edited, it is not registered and the dialog box is closed. <Cancel> is displayed if a condition is not created, changed, or deleted; <Close> is displayed if it is.
Help	Opens the Help window.
Buttons for opening each event setting dialog box	
Add Event...	Opens the Event dialog box in the select mode, and selects or newly creates an event condition to be set. The event condition will be added to the area selected when the < Add Event...> button is pressed.
Add Link...	Opens the Event Link dialog box in the select mode, and selects or newly creates an event link condition. The event link condition will be added to the area selected when the <Add Link...> button is pressed.
Other...	Opens the Select Event Type dialog box. By pressing each of the above buttons, each event setting dialog box can be opened in the new creation status.
Buttons in event manager area	
Shrink <<< (When area is displayed)	Turns off display of the event manager area. At this time, the size of the dialog box is reduced.
Expand >>> (When area is not displayed)	Displays the event manager area. At this time, the size of the dialog box is expanded.
Open (When only one event is selected)	Opens the event setting dialog box corresponding to the selected event condition. Each setting dialog box displays the contents of the selected event condition. The Enter key performs the same operation.
Remove (When event is selected)	Deletes the selected event condition. When an event condition or an event link condition is to be deleted, an error occurs and the event condition or event link condition cannot be deleted if the event is used as an event condition.
Add	Sets additionally the event condition or event link condition selected in the event manager area to setting area with a focus. The area to be set additionally is the area which was selected when this button was selected.
Info...	Opens the Select Display Information dialog box. This dialog box is used to change the display mode and rearrange event names.
Sort by Name	Sorts events into name order.
Sort by Name	Sorts events into type order.
Unsort	Displays events in the order in which they have been registered without sorting the events.
Detail	Sets the detailed display mode.
Overview	Sets the list display mode.
Cancel	Closes this dialog box (same as ESC key).

Trace dialog box

This dialog box is used to register, set, and display trace event conditions.

In this dialog box, the following types of trace event conditions can be set:

- Event condition for delay trigger
- Event condition for starting section trace
- Event condition for ending section trace
- Event condition for qualify trace

To use the above trace event conditions, select [Run] -> [Cond. Trace ON] from the menu bar.

A trace event condition registered in this dialog box will be automatically registered to the Event Manager.

A trace event condition automatically becomes valid when it has been registered.

Up to 256 trace event conditions can be registered. However, the number of trace event conditions that can be simultaneously used is 64 (refer to "Table 7-29 Maximum Number of Valid Events for Each Event Condition").

If the maximum number of trace event conditions that can be used at the same time is exceeded or if the number of event conditions or event link conditions used exceeds the maximum limit, therefore, register a trace event condition in the disabled state.

Figure 7-59 Trace Dialog Box

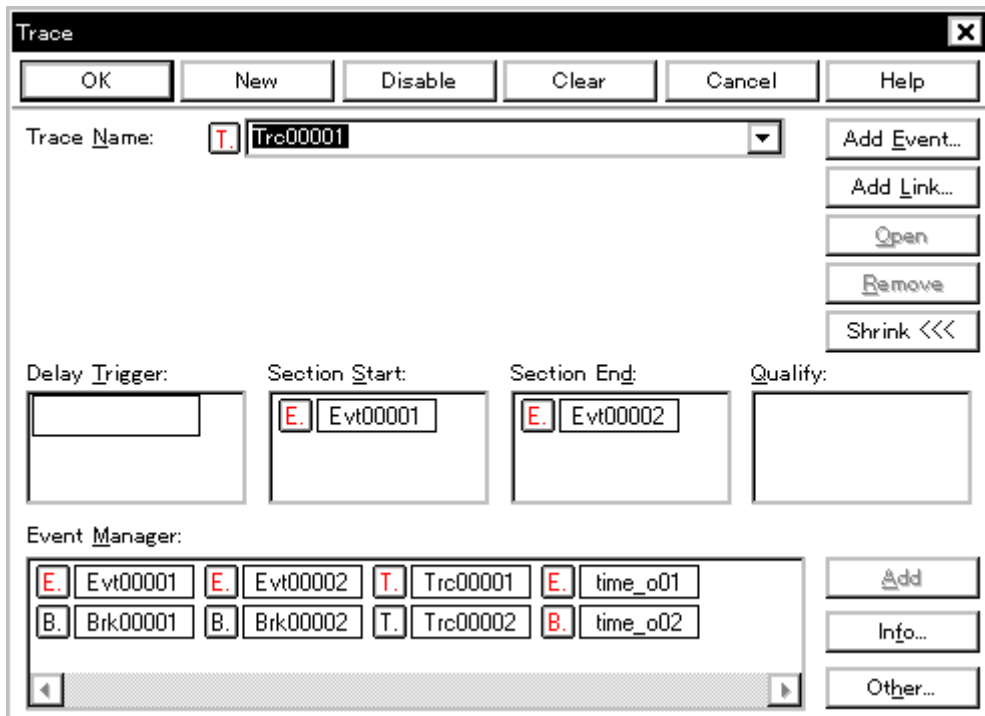

This section explains the following items:

- Opening
- Explanation of each area
- Function buttons
- Related operations
 - To set delay count

Opening

This dialog box can be opened as follows:

- Click the **Trc** button.
- Select [Event] -> [Trace...] from the menu bar (or press Alt+N, and T in that order).
- Click the <Trace> button in the Event dialog box (or press Alt+T in that order).

Explanation of each area

The Trace dialog box consists of the following areas:

- (1) Trace Name (trace event name setting area)
- (2) Delay Trigger (delay trigger condition setting area)
- (3) Section Start, Section End (section trace range condition setting area)
- (4) Qualify (qualify trace condition setting area)
- (5) Event Manager (event manager area)

(1) Trace Name (trace event name setting area)

Trace Name: 

This area is used to set a trace event name.

Directly input an alphanumeric string of up to eight characters as a name.

To display the contents of an already created event condition, select from the drop-down list.

The mark on the left of this area indicates the utilization status of events (refer to "Table 7-31 Color of Character on Mark and its Meaning"). The gray mark indicates that an event condition is being edited and has not been registered yet.

By clicking the left mark, an event condition can be validated or invalidated.

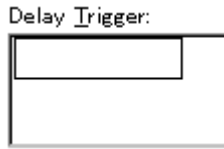
(2) Delay Trigger (delay trigger condition setting area)

This area is used to set an event condition for a delay trigger.

To set a delay count, use Delay Count dialog box that can be opened by selecting [Event] -> [Delay Count...]

 from the menu bar.

The number of event conditions that can be set in this area, combining execution events and access events, is as follows:

Product Name	Total (execution/access)
SIM	64

The number of event link conditions explained in Maximum Number of Valid Events for Each Event Condition can be used as long as the number of event conditions does not exceed the maximum number of event conditions simultaneously usable.

To set an event condition, drag the icon of the event to be set from the [Event Manager](#) area, and drop it in this area. For details, refer to "Setting event condition and event link condition in each area".

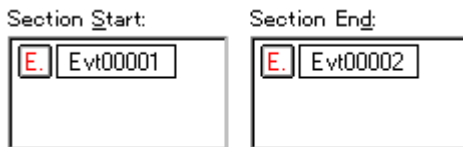
(3) Section Start, Section End (section trace range condition setting area)

This area is used to set event conditions for starting and stopping a section trace.

By setting a trace start event condition as [Section Start](#) and a trace end event condition as [Section End](#), a section trace (zone trace) can be performed.

The number of event conditions that can be set in this area, combining execution events and access events, is as follows:

Product Name	Total (execution/access)
SIM	64

The number of event link conditions explained in Maximum Number of Valid Events for Each Event Condition can be used as long as the number of event conditions does not exceed the maximum number of event conditions simultaneously usable.

To set an event condition, drag the icon of the event to be set from the [Event Manager](#) area, and drop it in this area. For details, refer to "Setting event condition and event link condition in each area".

(4) Qualify (qualify trace condition setting area)

Qualify:

This area is used to set an event condition for a qualify trace.

In a qualify trace, a trace is performed only when a trace condition is satisfied.

If two or more events are set, trace is performed when each event occurs.

The number of event conditions that can be set in this area, combining execution events and access events, is as follows:

Product Name	Total (execution/access)
SIM	64

The number of event link conditions explained in Maximum Number of Valid Events for Each Event Condition can be used as long as the number of event conditions does not exceed the maximum number of event conditions simultaneously usable.

Note that an event link condition cannot be set.

To set an event condition, drag the icon of the event to be set from the [Event Manager](#) area, and drop it in this area. For details, refer to "Setting event condition and event link condition in each area".

(5) Event Manager (event manager area)

Event Manager:

This area displays a list of break, trace and other registered various event conditions.

For details, refer to "Event Manager (event manager area)".

Function buttons

Setting-related buttons	
OK	Automatically registers the event condition being edited, if any, and closes this dialog box. The event condition becomes valid as soon as it has been registered.
New	Newly creates an event condition in this dialog box. An event condition name is automatically created and a new event condition is prepared.
Set (when a new event link is created or an event link is changed)	Registers the various event condition. Because the dialog box is not closed even after an event has been registered, new event conditions can be registered. Each event condition becomes valid as soon as it has been registered. If an already registered event condition is displayed, the <Enable> or <Disable> button is alternately displayed.
Enable/Disable (when a registered event is displayed)	Validates (enables) or invalidates (disables) the selected event condition. However, event conditions and event link conditions cannot be enabled or disabled. This button and the <Set> button are alternately displayed.
Clear (when an event is not edited)	Clears the contents of the event condition. This button is displayed when an event condition has not been edited. This button and the <Restore> button are alternately displayed.
Restore (when an event is edited)	Restores the contents of an edited event condition. If an event condition not registered is displayed, all the fields other than the event name field are blank or the default values are set. This button and the <Clear> button are alternately displayed.
Cancel Close	Closes this dialog box. Even if an event condition is being edited, it is not registered and the dialog box is closed. <Cancel> is displayed if a condition is not created, changed, or deleted; <Close> is displayed if it is.
Help	Opens the Help window.
Buttons for opening each event setting dialog box	
Add Event...	Opens the Event dialog box in the select mode, and selects or newly creates an event condition to be set. The event condition will be added to the area selected when the < Add Event...> button is pressed.
Add Link...	Opens the Event Link dialog box in the select mode, and selects or newly creates an event link condition. The event link condition will be added to the area selected when the <Add Link...> button is pressed.
Other...	Opens the dialog box for selecting the event type. By pressing each of the buttons, each various event setting dialog box can be opened in the new creation status.
Buttons in event manager area	
Shrink <<< (When area is displayed)	Turns off display of the event manager area. At this time, the size of the dialog box is reduced.
Expand >>> (When area is not displayed)	Displays the event manager area. At this time, the size of the dialog box is expanded.

Open (When only one event is selected)	Opens the various event setting dialog box corresponding to the selected event condition. Each setting dialog box displays the contents of the selected event condition. The Enter key performs the same operation.
Remove (When event is selected)	Deletes the selected event condition. When an event condition or an event link condition is to be deleted, an error occurs and the event condition or event link condition cannot be deleted if the event is used as a various event condition.
Add	Sets additionally the event condition or event link condition selected in the event manager area to setting area with a focus. The area to be set additionally is the area which was selected when this button was selected.
Info...	Opens the Select Display Information dialog box. This dialog box is used to change the display mode and rearrange event names.
Sort by Name	Sorts events into type order.
Sort by Kind	Sorts events into type order.
Unsort	Displays events in the order in which they have been registered without sorting the events.
Detail	Sets the detailed display mode.
Overview	Sets the list display mode.。
Cancel	Closes this dialog box (same as ESC key).

Related operations

To set delay count

To set a delay count, use Delay Count dialog box, which can be opened by selecting [Event] -> [Delay Count...] from the menu bar.

The set delay count is valid for trace event conditions for which a delay trigger event is set.

Snap Shot dialog box

This dialog box is used to register, set, and display snapshot event conditions.

A snapshot event condition registered in this dialog box will be automatically registered to the Event Manager.

A snapshot event condition automatically becomes valid when it has been registered.

Up to 256 snapshot event conditions can be registered. However, the number of snapshot event conditions that can be simultaneously used is eight (refer to "Table 7-29 Maximum Number of Valid Events for Each Event Condition").

If the maximum number of break event conditions that can be used at the same time is exceeded or if the number of event conditions or event link conditions used exceeds the maximum limit, therefore, register a break event condition in the disabled state.

Figure 7-60 Snap Shot Dialog Box (with Register Selected)

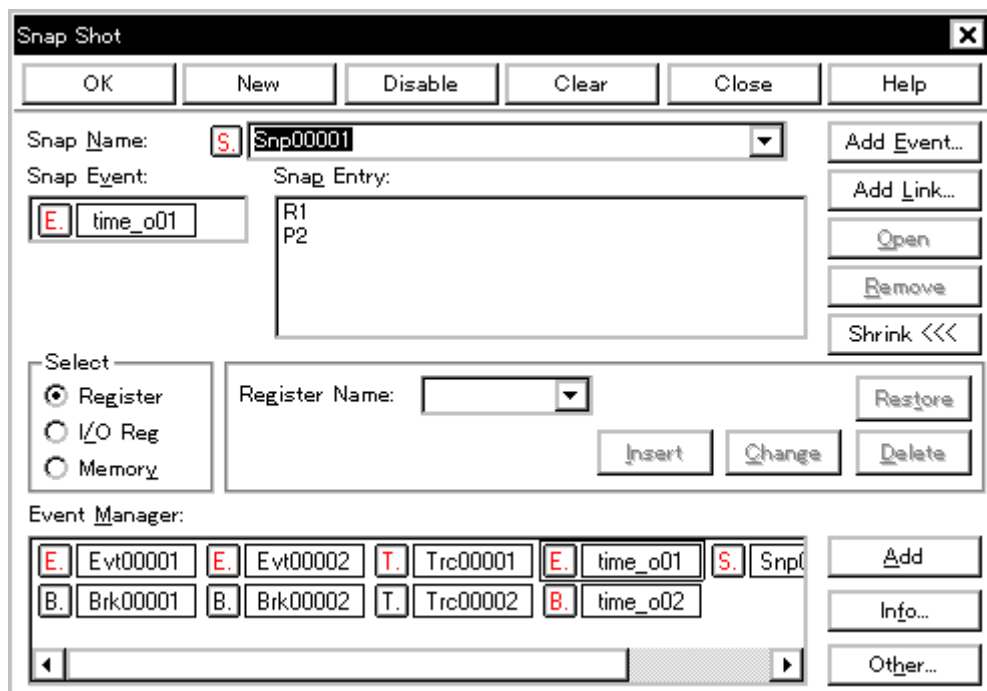

This section explains the following items:

- Opening
- Explanation of each area
- Function buttons

Opening

This dialog box can be opened as follows:

- Select [Event] -> [Snap Shot...] from the menu bar (or press Alt+N, and S in that order).
- Click the <Snap Shot...> button in the Event dialog box. (or press Alt and S in that order).

Explanation of each area

The Snap Shot dialog box consists of the following areas:

- (1) Snap Name (snapshot event name setting area)
- (2) Snap Event (snapshot condition setting area)
- (3) Select (snap data selection area)
- (4) Snap data setting area
- (5) Snap Entry (snap data display area)
- (6) Event Manager (event manager area)

(1) Snap Name (snapshot event name setting area)

Snap Name: 

This area is used to set a snapshot event name.

Directly input an alphanumeric string of up to eight characters as a name.

To display the contents of an already created event condition, select from the drop-down list.

The mark on the left of this area indicates the utilization status of events (refer to "Table 7-31 Color of Character on Mark and its Meaning"). The gray mark indicates that an event condition is being edited and has not been registered yet.

By clicking the left mark, an event condition can be validated or invalidated.

(2) Snap Event (snapshot condition setting area)

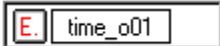
Snap Event: 

This area is used to set an event condition for the snapshot.

In the snapshot condition setting area, only one event condition and one event link condition can be set.

To set an event condition or event link condition, drag the icon of the event to be set from the [Event Manager](#) area, and drop it in this area. For details, refer to "Setting event condition and event link condition in each area".

(3) Select (snap data selection area)

Select

Register

I/O Reg

Memory

This area is used to select type of data subject to snapshot.

By selecting a data type, the item to be displayed in the snap data setting area on the right of this area changes in accordance with the selected area.

Data Type	Contents	Item in Right Area (Snap Data Setting Area)
Register	A register can be registered.	Register Name
I/O Reg	A peripheral I/O register can be registered.	I/O Reg Name
Memory	Memory can be registered.	Memory Address , Memory Display

(4) Snap data setting area

This area is used to register, change, or delete snap data.

The snap data registered, changed, or deleted in this area is reflected in the [Snap Entry](#) area.

If snap data is selected in the [Snap Entry](#) area, the contents of the selected snap data are displayed in this area.

As snap data, up to 16 registers, peripheral I/O registers, and memory addresses each can be registered; therefore, a total of 48 registers, peripheral I/O registers, and memory addresses can be registered.

This area displays different items, as follows, depending on the item selected in the [Select](#) field.

When [Register](#) is selected

Register Name:

[Register Name](#) (register name setting area)

This area is used to specify a register name.

To specify a register name, select a register name from the drop-down list.

Program registers and system registers can be specified. Uppercase and lowercase characters are not distinguished.

A register name can be specified as both a function name and an absolute name.

Note that all register names are displayed in uppercase characters in the Trace window, in the form of 'absolute name (function name)'.

When I/O Reg is selected
I/O Reg Name (peripheral I/O register name setting area)

This area is used to specify a peripheral I/O register name.

To specify a register name, either directly input one to the text box, or select one from the drop-down list.

Only the peripheral I/O registers that can be read can be specified. Uppercase and lowercase characters are not distinguished.

The peripheral I/O bit names and the I/O port name registered in the Add I/O Port dialog box cannot be specified.

Note that all the register names are displayed in uppercase characters in the Trace window.

When Memory is selected
Memory Address (memory address setting area)

This area is used to specify an address range of the memory (settable range: $0 \leq \text{address} \leq 0xFFFFFFFF$).

Start address - End address

If a value is input as only the start address and specifying the end address is omitted, it is assumed that the same value as the start address is specified as the end address. If the specified address range cannot be divided by the access size, the address range is rounded up to a range that can be divided by the access size.

An address can be also specified by a symbol or expression (refer to "Table 7-14 Specifying Symbols"). The default radix for inputting a numeric value is hexadecimal.

If addresses are registered or changed in this area by using expressions or symbols, the converted address values are displayed in the [Snap Entry](#) area along with the specified expressions and symbols.

In the Trace window, only the converted address values are displayed.

Memory Display (memory display size setting area)

This area is used to specify the access size of memory snap data.

To specify the access size, either directly input the size or select the size from the drop-down list.

Uppercase and lowercase characters are not distinguished.

Access Size	Abbreviation	Contents
Byte	B	Snapshot of memory in 8-bit units
Half Word	HW	Snapshot of memory in 16-bit units
Word	W	Snapshot of memory in 32-bit units

Buttons to manipulate snap data

The following buttons are used to register, change, and delete snap data.

Insert	Registers snap data. The registered snap data is inserted and displayed at the selected position in the Snap Entry area.
Change	Changes the contents of the snap data selected in the Snap Entry area to the contents of the snap data specified in this area.
Delete	Deletes the snap data selected in the Snap Entry area. The DEL key performs the same operation.
Restore	Restores the contents in the Snap Entry area.

(5) [Snap Entry](#) (snap data display area)

Snap Entry:

R1 P2

This area displays a list of registered snap data.

The registered snap data is written into the tracer when a snapshot event occurs.

If snap data is selected in this area, the contents of the selected snap data are displayed in each setting area.

Snap data is displayed as follows:

Register snap data:

R1 R3(SP)	Register name
--------------	---------------

Peripheral I/O register snap data:

P0 P1	Peripheral I/O register name
----------	------------------------------

Memory snap data:

0xFFE000,HW 0xFFE100-0xFFE10f	Start address <symbol expression> - End address <symbol expression>, Access size
----------------------------------	--

(6) Event Manager (event manager area)

Event Manager:

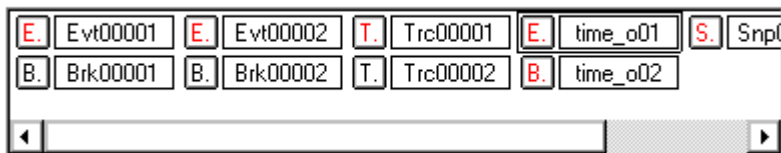

This area displays a list of break, trace and other registered various event conditions.

For details, refer to "Event Manager (event manager area)".

Function buttons

Setting-related buttons	
OK	Automatically registers the event condition being edited, if any, and closes this dialog box. The event condition becomes valid as soon as it has been registered.
New	Newly creates an event condition in this dialog box. An event condition name is automatically created and a new event condition is prepared.
Set (when a new event link is created or an event link is changed)	Registers the various event condition. Because the dialog box is not closed even after an event has been registered, new event conditions can be registered. Each event condition becomes valid as soon as it has been registered. If an already registered event condition is displayed, the <Enable> or <Disable> button is alternately displayed.
Enable/Disable (when a registered event is displayed)	Validates (enables) or invalidates (disables) the selected event condition. However, event conditions and event link conditions cannot be enabled or disabled. This button and the <Set> button are alternately displayed.
Clear (when an event is not edited)	Clears the contents of the event condition. This button is displayed when an event condition has not been edited. This button and the <Restore> button are alternately displayed.
Restore (when an event is edited)	Restores the contents of an edited event condition. If an event condition not registered is displayed, all the fields other than the event name field are blank or the default values are set. This button and the <Clear> button are alternately displayed.
Cancel Close	Closes this dialog box. Even if an event condition is being edited, it is not registered and the dialog box is closed. <Cancel> is displayed if a condition is not created, changed, or deleted; <Close> is displayed if it is.

Help	Opens the Help window.
Buttons for opening each event setting dialog box	
Add Event...	Opens the Event dialog box in the select mode, and selects or newly creates an event condition to be set. The event condition will be added to the area selected when the <Add Event...> button is pressed.
Add Link...	Opens the Event Link dialog box in the select mode, and selects or newly creates an event link condition. The event condition will be added to the area selected when the <Add Link...> button is pressed.
Other...	Opens the dialog box for selecting the event type. By pressing each of the buttons, each various event setting dialog box can be opened in the new creation status.
Buttons in event manager area	
Shrink <<< (When area is displayed)	Turns off display of the event manager area. At this time, the size of the dialog box is reduced.
Expand >>> (When area is not displayed)	Displays the event manager area. At this time, the size of the dialog box is expanded.
Open (When only one event is selected)	Opens the various event setting dialog box corresponding to the selected event condition. Each setting dialog box displays the contents of the selected event condition. The Enter key performs the same operation.
Remove (When event is selected)	Deletes the selected event condition. When an event condition or an event link condition is to be deleted, an error occurs and the event condition or event link condition cannot be deleted if the event is used as a various event condition.
Add	Sets additionally the event condition or event link condition selected in the event manager area to setting area with a focus. The area to be set additionally is the area which was selected when this button was selected.
Info...	Opens the Select Display Information dialog box. This dialog box is used to change the display mode and rearrange event names.
Sort by Name	Sorts events into type order.
Sort by Kind	Sorts events into type order.
Unsort	Displays events in the order in which they have been registered without sorting the events.
Detail	Sets the detailed display mode.
Overview	Sets the list display mode.
Cancel	Closes this dialog box (same as ESC key).

Stub dialog box

This dialog box is used to register, set, and display stub event conditions.

A stub event condition registered in this dialog box will be automatically registered to the Event Manager.

A stub event condition automatically becomes valid when it has been registered.

Up to 256 stub event conditions can be registered. However, the number of stub event conditions that can be simultaneously used is one (refer to "Table 7-29 Maximum Number of Valid Events for Each Event Condition"). If the maximum number of stub event conditions that can be used at the same time is exceeded or if the number of event conditions or event link conditions used exceeds the maximum limit, therefore, register a stub event condition in the disabled state.

Figure 7-61 Stub Dialog Box

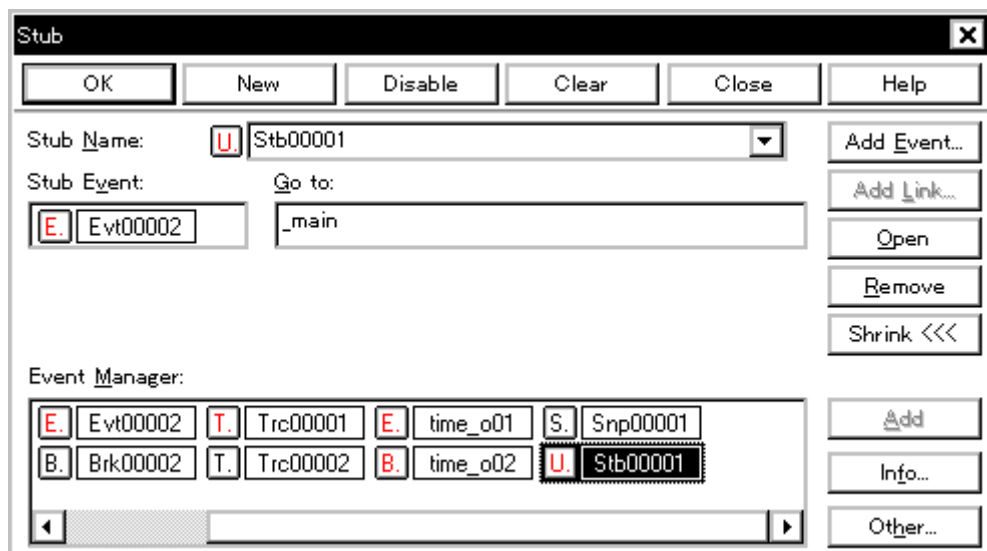

This section explains the following items:

- Opening
- Explanation of each area
- Function buttons

Opening

This dialog box can be opened as follows:

- Select [Event] -> [Stub...] from the menu bar (or press Alt+N, and U in that order).
- Click the <Stub...> button in the Event dialog box. (or press Alt+U).

Explanation of each area

The Stub dialog box consists of the following areas:

- (1) Stub Name (stub event name setting area)
- (2) Stub Event (stub condition setting area)
- (3) Go to (jump address setting area)
- (4) Event Manager (event manager area)

(1) Stub Name (stub event name setting area)

Stub Name: Stb00001

This area is used to set a stub event name.

Directly input an alphanumeric string of up to eight characters as a name.

To display the contents of an already created event condition, select from the drop-down list.

The mark on the left of this area indicates the utilization status of events (refer to "Table 7-31 Color of Character on Mark and its Meaning"). The gray mark indicates that an event condition is being edited and has not been registered yet.

By clicking the left mark, an event condition can be validated or invalidated.

(2) Stub Event (stub condition setting area)

Stub Event: Evt00002

This area is used to set an event condition for the stub.

In the stub condition setting area, only one event condition and one event link condition can be set.

To set an event condition, drag the icon of the event to be set from the [Event Manager](#) area, and drop it in this area. For details, refer to "Setting event condition and event link condition in each area".

(3) Go to (jump address setting area)

Go to:

This area is used to specify the top address of the function that is executed when a stub event occurs.

Settable range : $0 \leq \text{top address of function} \leq 0xFFFFFFFF$

An address can be also specified by a symbol or expression (refer to "Table 7-14 Specifying Symbols"). The default radix for inputting a numeric value is hexadecimal.

To return from the specified function when a stub event occurs, describe 'JMP [r31] instruction' in the function.

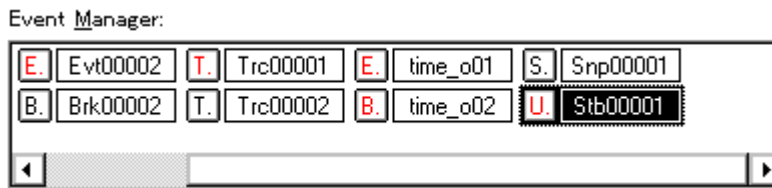
(4) Event Manager (event manager area)

This area displays a list of break, trace and other registered various event conditions.

For details, refer to "Event Manager (event manager area)".

Function buttons

Setting-related buttons	
OK	Automatically registers the event condition being edited, if any, and closes this dialog box. The event condition becomes valid as soon as it has been registered.
New	Newly creates an event condition in this dialog box. An event condition name is automatically created and a new event condition is prepared.
Set (when a new event link is created or an event link is changed)	Registers the various event condition. Because the dialog box is not closed even after an event has been registered, new event conditions can be registered. Each event condition becomes valid as soon as it has been registered. If an already registered event condition is displayed, the <Enable> or <Disable> button is alternately displayed.
Enable/Disable (when a registered event is displayed)	Validates (enables) or invalidates (disables) the selected event condition. However, event conditions and event link conditions cannot be enabled or disabled. This button and the <Set> button are alternately displayed.
Clear (when an event is not edited)	Clears the contents of the event condition. This button is displayed when an event condition has not been edited. This button and the <Restore> button are alternately displayed.
Restore (when an event is edited)	Restores the contents of an edited event condition. If an event condition not registered is displayed, all the fields other than the event name field are blank or the default values are set. This button and the <Clear> button are alternately displayed.
Cancel Close	Closes this dialog box. Even if an event condition is being edited, it is not registered and the dialog box is closed. <Cancel> is displayed if a condition is not created, changed, or deleted; <Close> is displayed if it is.
Help	Opens the Help window.
Buttons for opening each event setting dialog box	
Add Event...	Opens the Event dialog box in the select mode, and selects or newly creates an event condition to be set. The event condition will be added to the area selected when the < Add Event...> button is pressed.

Add Link...	Opens the Event Link dialog box in the select mode, and selects or newly creates an event link condition. The event link condition will be added to the area selected when the <Add Link...> button is pressed.
Other...	Opens the dialog box for selecting the event type. By pressing each of the buttons, each various event setting dialog box can be opened in the new creation status.
Buttons in event manager area	
Shrink <<< (When area is displayed)	Turns off display of the event manager area. At this time, the size of the dialog box is reduced.
Expand >>> (When area is not displayed)	Displays the event manager area. At this time, the size of the dialog box is expanded.
Open (When only one event is selected)	Opens the various event setting dialog box corresponding to the selected event condition. Each setting dialog box displays the contents of the selected event condition. The Enter key performs the same operation.
Remove (When event is selected)	Deletes the selected event condition. When an event condition or an event link condition is to be deleted, an error occurs and the event condition or event link condition cannot be deleted if the event is used as a various event condition.
Add	Sets additionally the event condition or event link condition selected in the event manager area to setting area with a focus. The area to be set additionally is the area which was selected when this button was selected.
Info...	Opens the Select Display Information dialog box. This dialog box is used to change the display mode and rearrange event names.
Sort by Name	Sorts events into type order.
Sort by Kind	Sorts events into type order.
Unsort	Displays events in the order in which they have been registered without sorting the events.
Detail	Sets the detailed display mode.
Overview	Sets the list display mode.
Cancel	Closes this dialog box (same as ESC key).

Timer dialog box

This dialog box is used to display the execution time measurement result, and register and set timer event conditions.

A timer event condition that has been registered in this dialog box is automatically registered to the Event Manager.

The execution time measurement result is displayed when the set timer event condition is selected.

A timer event condition automatically becomes valid when it has been registered.

Up to 256 timer event conditions can be registered. The number of timer event conditions that can be simultaneously used (validated) is limited (refer to "Table 7-29 Maximum Number of Valid Events for Each Event Condition").

If the maximum number of timer event conditions that can be used at the same time is exceeded or if the number of event conditions or event link conditions used exceeds the maximum limit, therefore, register a timer event condition in the disabled state.

Run-Break event

Run-Break is a timer event name given to a timer event condition that measures the execution time from execution to break. This timer event name is registered in the default condition and the execution time can be displayed by selecting it in the Timer Name area in this dialog box.

The Run-Break event for the SM850 is not included in the number of timer events simultaneously usable.

A timer event condition is satisfied only when the timer is valid.

Figure 7-62 Timer Dialog Box

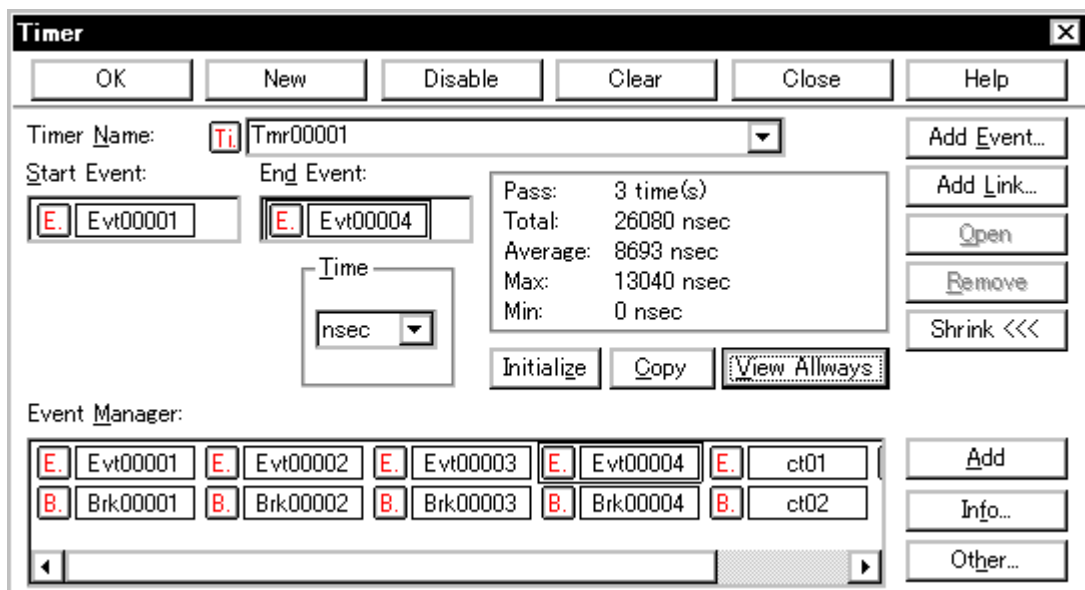

This section explains the following items:

- Opening
- Explanation of each area
- Function buttons

Opening

This dialog box can be opened as follows:

- Click the **Tim** button.
- Select [Event] -> [Timer...] from the menu bar (or press Alt+N, and I in that order).
- Click the <Timer... > button in the Event dialog box. (or press Alt+I).

Explanation of each area

The Timer dialog box consists of the following areas:

- (1) Timer Name (timer event name setting area)
- (2) Start Event, End Event (timer condition setting area)
- (3) Time (timer display unit selection area)
- (4) Execution time display area
- (5) Event Manager (event manager area)

(1) **Timer Name** (timer event name setting area)

Timer Name: 

This area is used to set a timer event name.

Directly input an alphanumeric string of up to eight characters as a name.

To display the contents of an already created event condition, select from the drop-down list.

The timer event name [Run-Break] that displays from execution to break is registered in the default condition, but is not displayed on the Event Manager.

The mark on the left of this area indicates the utilization status of events (refer to "Table 7-31 Color of Character on Mark and its Meaning"). The gray mark indicates that an event condition is being edited and has not been registered yet.

By clicking the left mark, an event condition can be validated or invalidated.

(2) Start Event, End Event (timer condition setting area)

This area is used to set an event condition for the timer.

Start Event	Set the event condition or event link condition that starts time measurement.
End Event	Set the event condition or event link condition that stops time measurement.

The number of event conditions that can be registered in the timer condition setting area is one for each of the start and end conditions. To set an event condition, drag the icon of the event to be set from the [Event Manager](#) area, and drop it in this area. For details, refer to "Setting event condition and event link condition in each area".

(3) Time (timer display unit selection area)

This area is used to select the unit in which the timer measurement result is to be displayed.

nsec	Nanoseconds (default)
usec	Microseconds
msec	Milliseconds
sec	Seconds
min	Minutes
clock	Number of Clocks

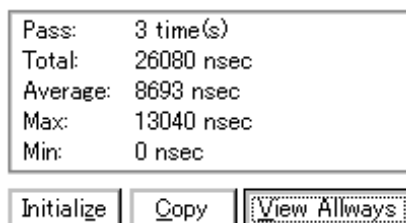
(4) Execution time display area

This area displays the result of measuring the execution time of the program.

Pass	Number of passes (Measurable number of times of execution: 4,294,967,295 max.) * This is not measured for Run-Break.
----------------------	--

Total	Total execution time in the measurement zone specified by start event and end event conditions (measurable execution time: 7 minutes 9 seconds max. ^{note})
Average	Average execution time * This is not measured for Run-Break.
Max	Maximum execution time * This is not measured for Run-Break.
Min	Minimum execution time * This is not measured for Run-Break.

note Resolution : 0.1us

The execution time display area is blank if measurement is not performed or the measurement result has been cleared.

Buttons to manipulate execution time display area

Initialize	Clears the measurement results.
Copy	Copies the measurement result to the clipboard in text format.
View Always	Displays the Timer Result dialog box in which the selected timer event condition or the measurement result of Run-Break is displayed.

(5) Event Manager (event manager area)

Event Manager:

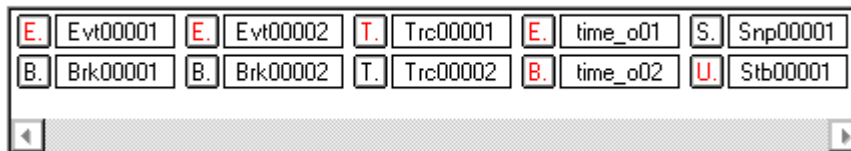

This area displays a list of break, trace and other registered various event conditions.

For details, refer to "Event Manager (event manager area)".

Function buttons

Setting-related buttons	
OK	Automatically registers the event condition being edited, if any, and closes this dialog box. The event condition becomes valid as soon as it has been registered.
New	Newly creates an event condition in this dialog box. An event condition name is automatically created and a new event condition is prepared.

Set (when a new event link is created or an event link is changed)	Registers the various event condition. Because the dialog box is not closed even after an event has been registered, new event conditions can be registered. Each event condition becomes valid as soon as it has been registered. If an already registered event condition is displayed, the <Enable> or <Disable> button is alternately displayed.
Enable/Disable (when a registered event is displayed)	Validates (enables) or invalidates (disables) the selected event condition. However, event conditions and event link conditions cannot be enabled or disabled. This button and the <Set> button are alternately displayed.
Clear (when an event is not edited)	Clears the contents of the event condition. This button is displayed when an event condition has not been edited. This button and the <Restore> button are alternately displayed.
Restore (when an event is edited)	Restores the contents of an edited event condition. If an event condition not registered is displayed, all the fields other than the event name field are blank or the default values are set. This button and the <Clear> button are alternately displayed.
Cancel Close	Closes this dialog box. Even if an event condition is being edited, it is not registered and the dialog box is closed. <Cancel> is displayed if a condition is not created, changed, or deleted; <Close> is displayed if it is.
Help	Opens the Help window.
Buttons for opening each event setting dialog box	
Add Event...	Opens the Event dialog box in the select mode, and selects or newly creates an event condition to be set. The event condition will be added to the area selected when the < Add Event...> button is pressed.
Add Link...	Opens the Event Link dialog box in the select mode, and selects or newly creates an event link condition. The event link condition will be added to the area selected when the <Add Link...> button is pressed.
Other...	Opens the dialog box for selecting the event type. By pressing each of the buttons, each various event setting dialog box can be opened in the new creation status.
Buttons in event manager area	
Shrink <<< (When area is displayed)	Turns off display of the event manager area. At this time, the size of the dialog box is reduced.
Expand >>> (When area is not displayed)	Displays the event manager area. At this time, the size of the dialog box is expanded.
Open (When only one event is selected)	Opens the various event setting dialog box corresponding to the selected event condition. Each setting dialog box displays the contents of the selected event condition. The Enter key performs the same operation.
Remove (When event is selected)	Deletes the selected event condition. When an event condition or an event link condition is to be deleted, an error occurs and the event condition or event link condition cannot be deleted if the event is used as a various event condition.
Add	Sets additionally the event condition or event link condition selected in the event manager area to setting area with a focus. The area to be set additionally is the area which was selected when this button was selected.

Info...	Opens the Select Display Information dialog box. This dialog box is used to change the display mode and rearrange event names.
Sort by Name	Sorts events into type order.
Sort by Kind	Sorts events into type order.
Unsort	Displays events in the order in which they have been registered without sorting the events.
Detail	Sets the detailed display mode.
Overview	Sets the list display mode.
Cancel	Closes this dialog box (same as ESC key).

Timer Result dialog box

This dialog box displays the result of measuring the execution time.

It displays the timer event condition set in the Timer dialog box and the result of measuring the execution time of [Run-Break].

The Timer Result dialog box corresponds to a timer event condition or [Run-Break] on a one-to-one basis, and two or more of this dialog box can be simultaneously opened. Up to 257 Timer Result dialog boxes can be opened, of which 256 correspond to timer event conditions and one corresponds to [Run-Break].

However, the number of timer event conditions that can be simultaneously measured is up to the number of timer event conditions that can be simultaneously used plus one for [Run-Break] (refer to "Table 7-29 Maximum Number of Valid Events for Each Event Condition").

Figure 7-63 Timer Result Dialog Box

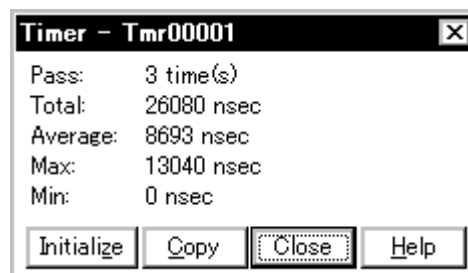

This section explains the following items:

- Opening
- Explanation of each area
- Function buttons

Opening

This dialog box can be opened as follows:

- Select a timer event condition or Run-Break in the Timer dialog box
Click the <View Always> button.
(or press Alt+V).

Explanation of each area

The Timer Result dialog box consists of the following areas:

- (1) Execution time display area

(1) Execution time display area

This area displays the result of measuring the execution time of the program (refer to "Execution time display area").

Function buttons

Initialize	Clears the measurement results.
Copy	Copies the measurement result to the clipboard in text format.
Close	Closes this dialog box.
Help	Opens the Help window.

Delay Count dialog box

This dialog box is used to set or display delay count values.

By setting a delay count value, a trace can be executed the number of times specified by the delay count value after the delay trigger event condition set in the Trace dialog box has been satisfied. The program can be executed and the tracer can be stopped.

Figure 7-64 Delay Count Dialog Box



This section explains the following items:

- Opening
- Explanation of each area
- Function buttons

Opening

This dialog box can be opened as follows:

- Select [Event] -> [Delay Count...] from the menu bar (or press Alt+N and Y in that order).

Explanation of each area

This dialog box consists of the following areas:

- (1) Delay Count (delay count setting area)

(1) Delay Count (delay count setting area)

Delay Count

This area is used to set or display a delay count value (unit: frames).

The settable range is 0 (default) to 32767.

Function buttons

OK	Sets the specified delay count and closes this dialog box.
Restore	Restores the previous delay count.
Cancel	Closes this dialog box.
Help	Opens the Help window.

Reset Debugger dialog box

This dialog box is used to initialize the debugger, CPU, and symbol information.

Specify what is to be initialized by using the check box. In the default condition, the debugger is initialized.

Figure 7-65 Reset Debugger Dialog Box

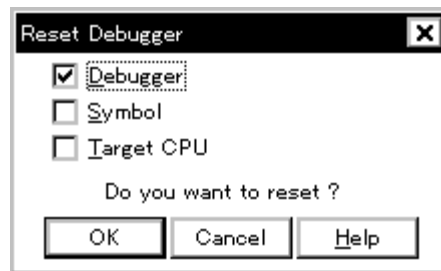

This section explains the following items:

- Opening
- Explanation of each area
- Function buttons

Opening

This dialog box can be opened as follows:

- Select [File] -> [Debugger Reset...] on the menu bar (or press Alt+F, and R in that order).

Explanation of each area

The Reset Debugger dialog box consists of the following areas:

- (1) Reset subject selection area

(1) Reset subject selection area

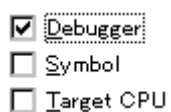

This area is used to select what is to be initialized.

Debugger	Initializes the debugger (default).
Symbol	Initializes the symbol information.
Target CPU	Initializes the CPU.

Function buttons

OK	Initializes the debugger, symbol information, or CPU.
Cancel	Ignores the setting and closes this dialog box.
Help	Opens the Help window.

About dialog box

This dialog box displays the version information of the debugger and simulator (the year is displayed in 4 digits).

The following version information is displayed:

- Product version of debugger
- Version of device file
- Version of GUI
- Version of debugger DLL
- Version of assembler DLL
- Version of executor
- Version of common peripheral simulation DLL

Figure 7-66 About Dialog Box

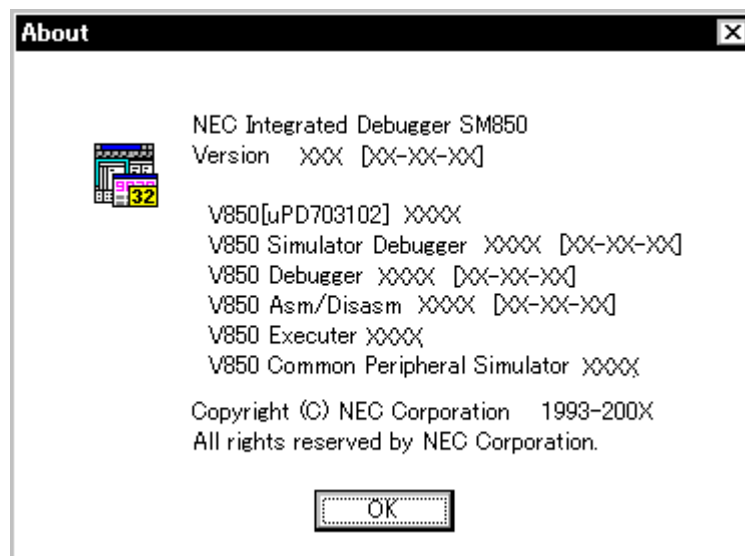

This section explains the following items:

- Opening
- Function buttons

Opening

This dialog box can be opened as follows:

- Select [H]elp]->[A]bout
(or press Alt+H, and A in that order).

Function buttons

OK	Closes this dialog box.
----	-------------------------

Exit Debugger dialog box

This dialog box is used to select whether the current debug environment is saved to a project file or not before terminating the debugger.

It can be specified in the Debugger Option dialog box that the debugger is terminated without this confirmation dialog box being opened.

Figure 7-67 Exit Debugger Dialog Box

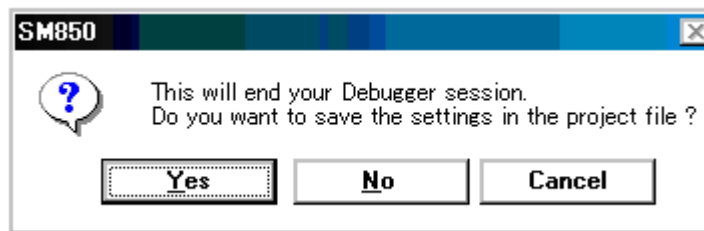

Reference If an attempt is made to terminate the debugger while the user program is being executed, the following message is displayed and the program execution can be stopped.

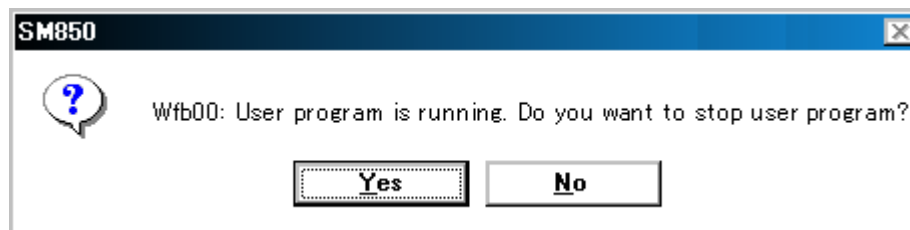

<Yes> button is selected

Execution of the user program is stopped and then the Exit Debugger dialog box is displayed.

If it is specified in the Debugger Option dialog box that the Exit Debugger dialog box is not to be displayed, however, the debugger is terminated.

<No> button is selected

Execution of the user program is not stopped and the Exit Debugger dialog box is not displayed. The debugger is not terminated.

This section explains the following items:

- Opening
- Function buttons

Opening

This dialog box can be opened as follows:

- Select [File] -> [Exit] from the menu bar (or press Alt+F, and X in that order).
- Press the Alt+F4 keys simultaneously.
- If forcible termination, such as to terminate the application, has been executed on the task list that terminates Windows.

Function buttons

Yes	Saves the current debug environment to a project file, closes all the windows, and terminates the debugger. If a project file name is not specified, the Project File Save dialog box is opened. If the < Cancel> button is selected on the Project File Save dialog box, the environment is neither saved to a project file nor is the debugger terminated. If a project file is loaded or saved during debugger operation, this button has the default focus.
No	Closes all the windows and terminates the debugger. If a project file is not loaded or saved during debugger operation, this button has the default focus.
Cancel	Closes this dialog box without executing anything.

Console window

This window is used to input commands that control the debugger.

Because the key bind is Emacs-like, the accelerator key is not acknowledged if the Console window is active.

However, the F1 key displays the help of the Console window.

While the Console window is open, an error message window with only an <OK> button is displayed in the Console window.

Refer to "COMMAND REFERENCE" for details on the command specifications.

Figure 7-68 Console window

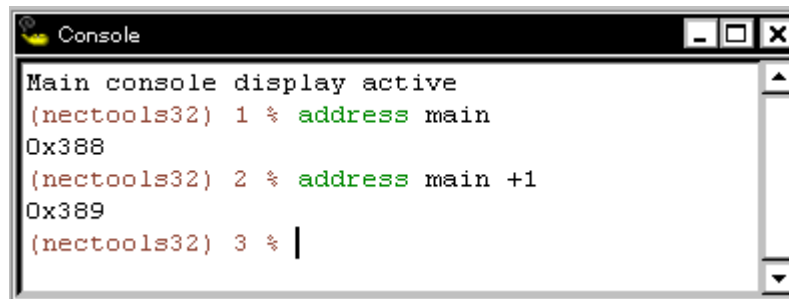

This section explains the following items:

- Opening

Opening

This window can be opened as follows:

- Select [B]rowse -> [C]onsole from the menu bar (or press Alt+B, and N in that order).

V850 Simulator GUI window

This is the main window of the simulator.

Windows related to the peripheral simulator and external parts are opened from this window.

This window is opened when the SM850 is started and remains on the screen until the simulator is terminated.

If this window is closed, the SM850 is terminated.

Figure 7-69 V850 Simulator GUI Window

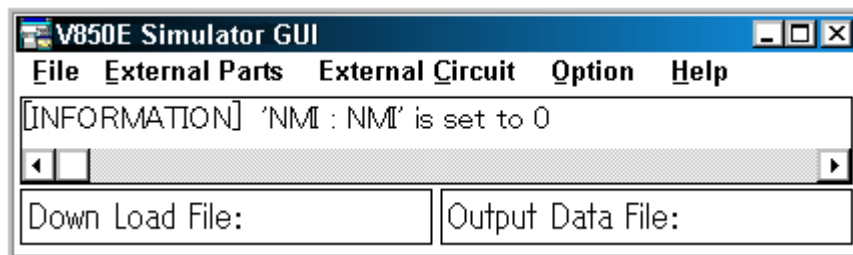

This section explains the following items:

- Opening
- Menu bar
- Message display area (at center of window)
- Area to display name of file to be simulated (lower part of window)

Opening

This window box can be opened as follows:

- Click the <V850 Simulator GUI> or <V850E Simulator GUI> button on the Windows task bar.

Menu bar

The menu bar consists of the following menus:

- (1) [File] menu
- (2) [External Parts] menu
- (3) [External Circuit] menu
- (4) [Option] menu
- (5) [Help] menu

(1) **[File] menu**

Select this menu to create a file for data input to the peripheral I/O registers (.i_x) or an event condition file (.env), download these files, specify output from the simulator, and terminate the simulator.

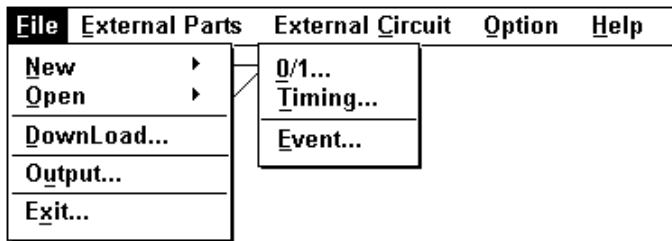

New	Opens a new window. If this menu is selected when the Input 0/1 Editor window or Input timing Chart Editor window has already been opened, the window already open pops up.
0/1...	Opens the Input 0/1 Editor window.
Timing...	Opens the Input timing Chart Editor window.
Event...	Opens the IOR Event & Action dialog box.
Open	Opens a file saved previously. Specify a file in the Open dialog box. If this menu is selected when the Input 0/1 Editor window or Input timing Chart Editor window is opened, a file newly specified in the already opened window is specified and pops up.
0/1...	Opens the Input 0/1 Editor window.
Timing...	Opens the Input timing Chart Editor window.
Event...	Opens the IOR Event & Action dialog box.
Download...	Opens the Down Load dialog box. The specified input data file (.i_x) or event condition file (.env) is downloaded. Clicking the <OK> button in the Down Load dialog box starts downloading of the specified file. However, this operation is not possible while the CPU is operating.
Output...	Opens the Output Setting dialog box. If "Output to file" is selected in the Output Setting dialog box, the output data is output to a file. If "Enable timing chart" is selected, the Output Timing Chart window is opened.
Exit...	Opens the Exit Debugger dialog box. Select <OK> in this dialog box to terminate the SM850.

(2) **[External Parts] menu**

Select this menu to open Parts window.

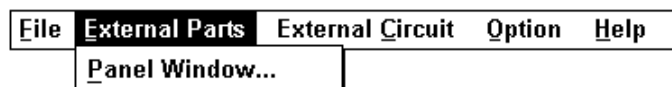

Panel Window...	Opens the Parts window.
---------------------------------	-------------------------

(3) [External Circuit] menu

Cannot be selected.

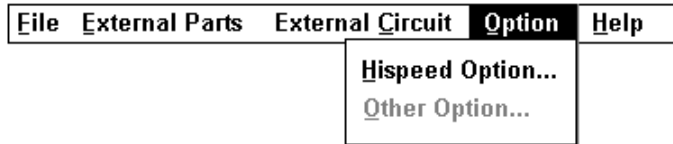
(4) [Option] menu

Hispeed Option...	Opens the Speed Option dialog box. Specify the option for operating the simulator at high speed.
Other Option...	Cannot be selected.

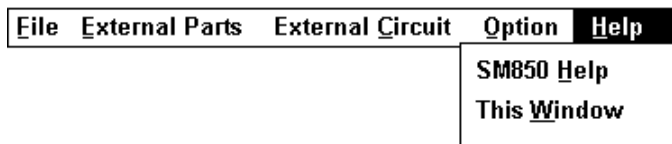
(5) [Help] menu

SM850 Help	Opens the Help window of SM850.
This Window	Displays the help window of this window.

Message display area (at center of window)

This area displays the default message if initialization is executed with no input message set.

No input data is set during simulation. If a request is received to read the input data from a pin to which a pull-up resistor is not connected, the value of the pin is initialized to 0. In this case, a message is displayed in this area.

Area to display name of file to be simulated (lower part of window)

This area displays the following information:

Down Load File:	Displays the name of the input data file currently downloaded. The identifier is .i_x. To specify a file, select [File] -> [Download] from the menu bar, or select the <Download> button in the Input timing Chart Editor window, Input 0/1 Editor window, or IOR Event & Action dialog box.
Output Data File:	Displays the name of the file in which the data output by the simulator is to be stored. The identifier is .out. To specify a file, select [File] -> [Output...] from the menu bar.

IOR Event & Action dialog box

This dialog box is used to set and display the event conditions of the peripheral I/O registers and an action (such as occurrence of an interrupt at a specified timing and data input) to be performed after a given event condition has been satisfied.

A created event condition and action can be saved to an event condition file (.evn), and can be downloaded when the CPU is not in operation. When an event condition file is downloaded, the events in the file are registered to the simulator so that they can be checked.

Up to 20 events and actions can be registered to one event condition file.

Figure 7-70 IOR Event & Action Dialog Box

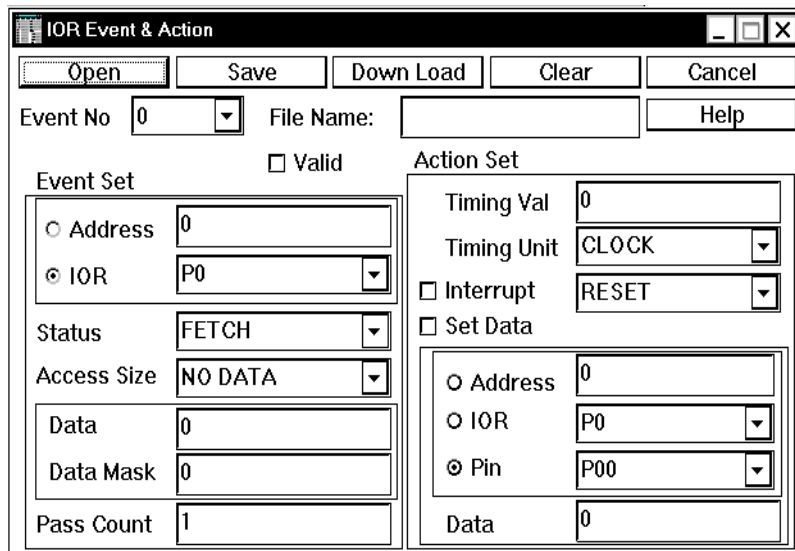

This section explains the following items:

- Opening
- Explanation of each area
- Function buttons

Opening

This dialog box can be opened as follows:

- In the V850 Simulator GUI window
Select [File] -> [New] -> [Event...] from the menu bar
(or press Alt+F, N and E in that order).
Select [File] -> [Open] -> [Event...] from the menu bar
(or press Alt+F, O and E in that order).

Explanation of each area

The IOR Event & Action dialog box consists of the following areas:

- (1) Event No (event number setting area)
- (2) File Name: (event condition file name display area)
- (3) Event Set (event setting area)
- (4) Action Set (action setting area)

(1) Event No (event number setting area)

Event No

Select the ID number (0 -19) to be assigned to an event & action from the drop-down list. If the event has not been set yet, the input field is displayed in the default condition. If an event ID already set is selected, its contents are displayed in each area.

Valid

Valid	If the Valid check box is checked, the event of Event No currently selected becomes valid.
-------	--

(2) File Name: (event condition file name display area)

File Name:

This area displays the name of the file that is currently open and can be saved.

This area is not displayed if a new file is created. When the file is saved (by clicking the <Save> button), a name is given to the file.

To read the contents of a file previously saved, specify the file by using the <Open> button.

(3) Event Set (event setting area)

Event Set	
<input type="radio"/> Address	<input type="text" value="0"/>
<input checked="" type="radio"/> IOR	<input type="text" value="P0"/>
Status	<input type="text" value="FETCH"/>
Access Size	<input type="text" value="NO DATA"/>
Data	<input type="text" value="0"/>
Data Mask	<input type="text" value="0"/>
Pass Count	<input type="text" value="1"/>

This area is used to set event conditions. Specify the following items in this area:

Address IOR	<p>Specify the memory area where the event is to occur. Select either Address or IOR by using the option button.</p> <p>Address If Address is selected, input an address. The event occurs when this address is accessed. The addresses in the entire memory space can be specified.</p> <p>IOR If IOR is selected, specify a peripheral I/O register name. The event occurs when this register is accessed. Select an address or register from the drop-down list, or input an address or register name from the keyboard (default). * For the specifiable peripheral I/O register names, refer to the user's manual of the device used.</p>
Status	<p>Specify the access status in which an event occurs. Select an access status from FETCH (default), READ, WRITE, or READ/WRITE from the drop-down list, or input a status from the keyboard.</p>
Access Size	<p>Specify the access size by which an event occurs. Select access size from NO DATA (default), 1 BYTE, 2 BYTE, or 4 BYTE from the drop-down list, or input a size from the keyboard.</p>
Data	<p>Specify the data condition in which an event occurs. This setting is invalid if NO DATA is specified for Access Size. If 1 BYTE, 2 BYTE or 4 BYTE is specified, a data condition can be specified in a given range.</p>
Data Mask	<p>Specify the data mask condition in which an event occurs. A value of up to 4 bytes can be specified. This setting is invalid if NO DATA is specified for Access Size.</p>
Pass Count	<p>Specify how many times the above event condition (specified in the Event Set area) is to be satisfied. A value of up to 2 bytes can be specified. If 1 (default) is set, it is assumed that an event occurs when the event condition is satisfied once.</p>

(4) Action Set (action setting area)

Action Set

Timing Val	0
Timing Unit	CLOCK
<input type="checkbox"/> Interrupt	RST
<input type="checkbox"/> Set Data	
<input type="radio"/> Address 0	
<input type="radio"/> IOR PD	
<input checked="" type="radio"/> Pin P00	
Data	0

This area is used to set the action to be performed when an event occurs. Specify when the action is to be started and what action is to be performed.

Timing Val	<p>Specify the start timing of the action (in Timing Unit units). A value of up to 2 bytes can be specified. The default value is 0, which means that the action is started as soon as an event has occurred.</p>
-------------------	--

Timing Unit	Specify the unit for Timing Val. Select a unit from the drop-down list (refer below) or input a unit from the keyboard. CLOCK CPU clock unit (default) * M-CLK Main clock unit INS Instruction unit * The CPU clock unit and main clock unit are the same.
Interrupt	If this check box is checked, an interrupt signal is generated as an action. Select an interrupt name from the drop-down list, or input from the keyboard. * For the specifiable interrupt names, refer to the user's manual of the device used.
Set Data	If this check box is checked, a value is input to a specified address, IOR, or pin as an action. Use the option button for specification. Address Specify the address to which data is to be input. The addresses in the entire memory space can be specified. IOR Specify the peripheral I/O register to which data is to be input. Select a register from the drop-down list, or input a register from the keyboard. Pin Specify the name of the pin to which data is to be input. Select a register from the drop-down list, or input a register from the keyboard. * For the specifiable pin names and peripheral I/O register names, refer to the user's manual of the device used.
Data	Specify the data to be input to a specified address, IOR, or pin. If Address or IOR above is selected, a value of up to 4 bytes can be specified. If Pin is specified, a value of 0 or 1 can be specified.

Function buttons

Open	Opens the Open dialog box The specified event condition file (.evn) is read.
Save	Opens the Save As dialog box The set window to be performed are saved to an event condition file (.evn). * When specifying a file name in the Save As dialog box, be sure to use four characters followed by 0000.evn (e.g., abcd0000.evn or efgi0000.evn).abcd0000.evn,efgi0000.evn etc.)
Down Load	Opens the Down Load dialog box The specified file is downloaded to the simulator.
Clear	Opens a dialog box that asks you if the data should be initialized. If the <OK> button is selected, data being created and not saved to a file is initialized. Use this button to start editing the file again from where data was last saved to the file.
Cancel	Opens a dialog box that inquires asks you if the dialog box should be closed. If the <OK> button is selected, the dialog box is closed.
Help	Opens the Help window.

Input 0/1 Editor window

This is one of the input editor windows and is used to set input data of any timing to an input pin as a numeric value.

The following data can be displayed in this window:

- Newly created input data
- Previously created input data (to be edited)
- File simulated previously and saved to an output file

Input data can be saved to an input data file (.i_x). By downloading this file, an input signal can be generated from a pin during simulation.

Figure 7-71 Input 0/1 Editor Window

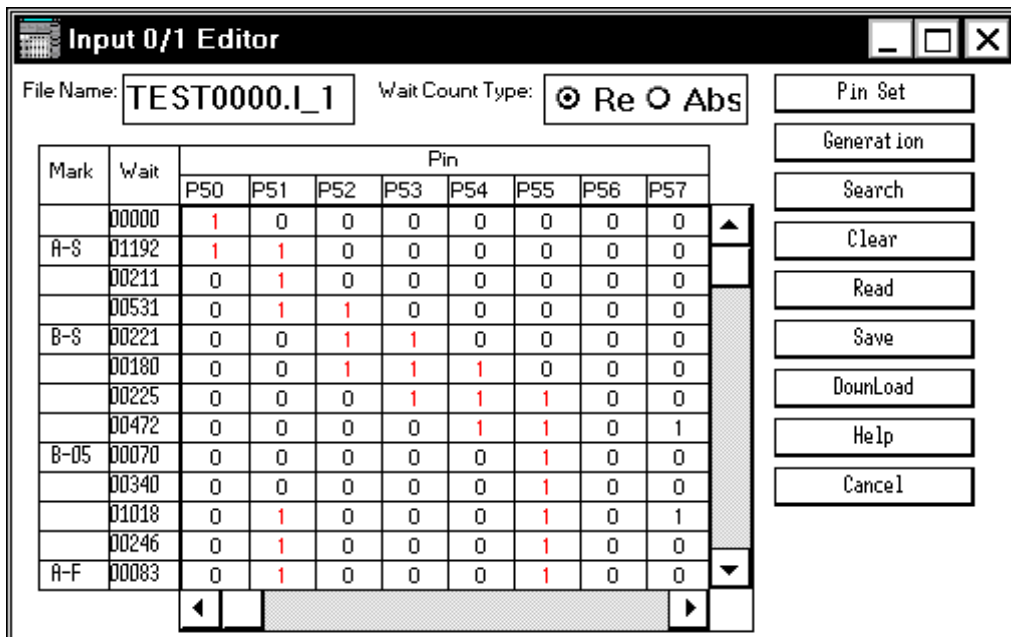

This section explains the following items:

- Opening
- Explanation of each area
- Operation
- Function buttons

Opening

This window box can be opened as follows:

- In the V850 Simulator GUI window
Select [E] -> [N] -> [Q/1...] from the menu bar
(or press Alt+F, N and 0 in that order).
Select [E] -> [O] -> [Q/1...] from the menu bar
(or press Alt+F, O and 0 in that order).

Explanation of each area

The Input 0/1 Editor window consists of the following areas:

- (1) File Name: (input data file name display area)
- (2) Wait Count Type: (wait display selection area)
- (3) Mark, Wait, Pin (input data setting table)

(1) File Name: (input data file name display area)

File Name:

This area displays the name of the file that is currently open and can be saved.

This area is not displayed if a new file is created. When the file is saved (by clicking the <Save> button), a name is given to the file.

(2) Wait Count Type: (wait display selection area)

Wait Count Type: Rel Abs

This button selects display of the timing (wait) at which data is to be input during simulation. Select the start of the wait time by using the option button.

Rel.	(Relative display) Wait time starts with the input of the previous data.
Abs	(Absolute display) Wait time starts with the start of simulation. * If wait is displayed for absolute display (Abs), the carry from the top in the edit/display area is displayed in the form of XXXXXxxxxx in the lower part of the Wait field.

(3) **Mark, Wait, Pin** (input data setting table)

Mark	wait	Pin							
		P50	P51	P52	P53	P54	P55	P56	P57
	00000	1	0	0	0	0	0	0	0
A-S	01192	1	1	0	0	0	0	0	0
	00211	0	1	0	0	0	0	0	0
	00531	0	1	1	0	0	0	0	0
B-S	00221	0	0	1	1	0	0	0	0
	00180	0	0	1	1	1	0	0	0
	00225	0	0	0	1	1	1	0	0
	00472	0	0	0	0	1	1	0	1
B-05	00070	0	0	0	0	0	1	0	0
	00340	0	0	0	0	0	1	0	0
	01018	0	1	0	0	0	1	0	1
	00246	0	1	0	0	0	1	0	0
A-F	00083	0	1	0	0	0	1	0	0

This table is used to set or display data to be input to a specified pin.

When the wait time specified in the **Wait** field has expired, the data set for each pin in the **Pin** field is input from each pin.

Eight pins are displayed in 10 stages in the default condition. Up to 48 pins can be specified. The size of this window can be varied.

Mark	<p>Displays or sets loop information.</p> <p>By clicking this field, loop information is set by using the following symbols (X indicates an order such as ABC, and Y indicates a numeric value).</p> <p>By this the information in the specified area can be input repeatedly.</p> <p>X-S Start position of the loop specified as the Xth.</p> <p>X-Y End position of the Xth loop.</p> <p style="padding-left: 20px;">This loop is repeated Y times ($1 \leq Y \leq 99$).</p> <p style="padding-left: 20px;">* Actually, the loop is repeated Y+1 times.</p> <p>X-F End position of the Xth loop.</p> <p style="padding-left: 20px;">This loop is repeated until simulation ends.</p> <p>Each time the left button of the mouse is clicked, X-S, X-F, and X-Y are selected in that order. The value of Y is incremented by one each time the right mouse button is clicked when X-Y is selected. It is decremented by one each time the right mouse button is clicked with the Shift key held down.</p>
-------------	--

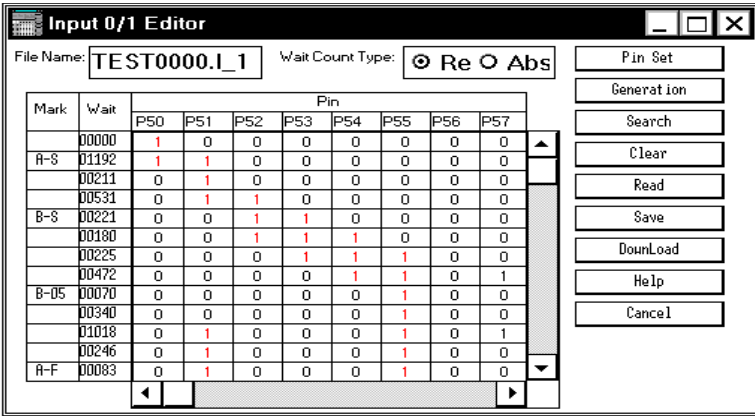
<p>Wait</p>	<p>Set the timing of inputting the data in the Pin field to a specified pin, as a wait value. An integer of 1 to 65535 can be specified. If 65535 is exceeded, use one more stage for setting. Directly write a numeric value to this field from the keyboard. Select the unit of Wait from the following when the file is to be saved (to save the file, use the <Save> button):</p> <ul style="list-style-type: none"> .i_0 ist (instruction unit) <ul style="list-style-type: none"> * The set wait value in this file is ignored. .i_1 clock (CPU clock unit) <ul style="list-style-type: none"> * The CPU clock unit and main clock unit are the same. .i_2 1/4m-clk (1/4 main clock unit) .i_3 m-clk (main clock unit) <p>If abs. is specified for Wait Count Type, the carry from the top stage in the Wait field is displayed in the lower part of this field in the form of XXXXXxxxxxx.</p> <p>Example: In the following figure, the wait value at the top stage is 108001. Therefore, the wait value at the bottom stage is 108010.</p> 
<p>Pin</p>	<p>Specify the name of the pin to which data is to be input and the data to be input according to the timing specified in the Wait field.</p> <p>For the pin name, either open Pin Setting dialog box by using the <Pin Set> button and create a new pin name, or read a pin setting information file (.pin) by using the <Read> button on that dialog box. To edit an input data file (.i_x) previously saved, specify a file name using the <Read> button and read the file.</p> <p>If the left mouse button is clicked in the pin name display area where a pin name is set, the displayed pin name changes color from black to purple, indicating that the pin has been selected.</p> <p>If this input data file is downloaded, the data of only the selected pin is downloaded.</p> <p>If a display name is set, the display name* is displayed instead of a pin name.</p> <p>* For the display name, refer to the explanation of the Pin Setting dialog box.</p>

Operation

Setting input data

On the setting table of input data, 0 (LOW), 1 (HIGH), or Z (high impedance) can be set for an input pin. For an analog input pin, a numeric value in the range of the number of bits of the A/D converter can be set^{Note}.

To set a new pin, set a pin name in the Pin field. "EOF" will be set on the first stage of the data setting table. By clicking this "EOF", one line of the input data can be inserted.

Note This differs depending on the device used.

- Setting of input pin

Mouse operation	Meaning
Left click	Value changes in the order of 0, 1, and Z.

- Setting of analog input pin

Mouse operation	Meaning
Left click	Value is incremented by one.
Right click	Value is decremented by one.
While holding down the Shift key (Left/right) click	Value changes by 10.

- With analog output pin*

If the output signal does not change, "^" indicating that the data is the same as that on the above line is displayed.

* Displayed when an output data file (.out) is read.

When an existing input data file is read and edited, input data can be added or changed by the same operation as above.

Selecting pin to which data is to be downloaded

If the pin name displayed in the **Pin** field is clicked, the color of the clicked pin changes from black to purple, indicating that the pin has been selected.

By saving and downloading this input data file, the data of only the selected pin (in purple) can be downloaded. Here is an example:

Example:

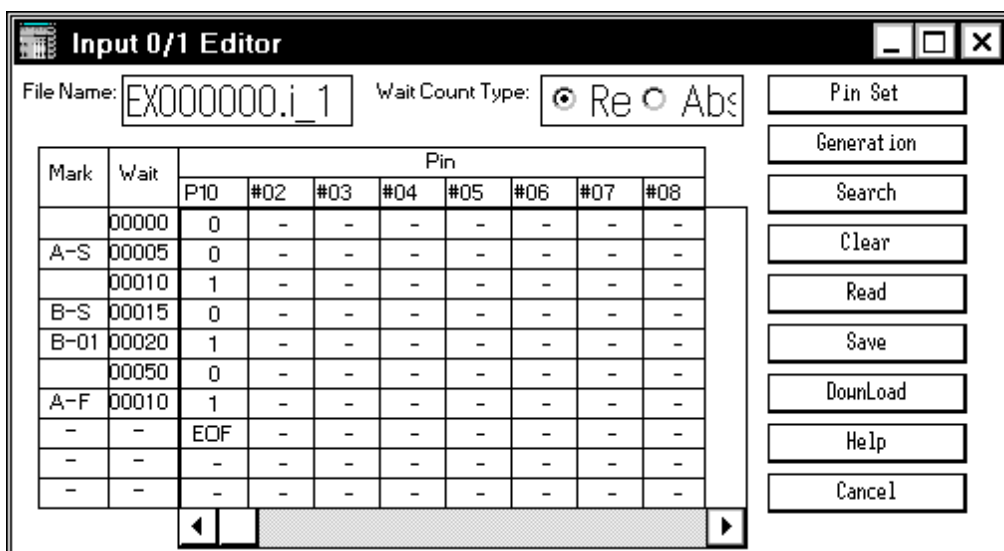

If the above file is downloaded, data is input to pin P10, as follows:

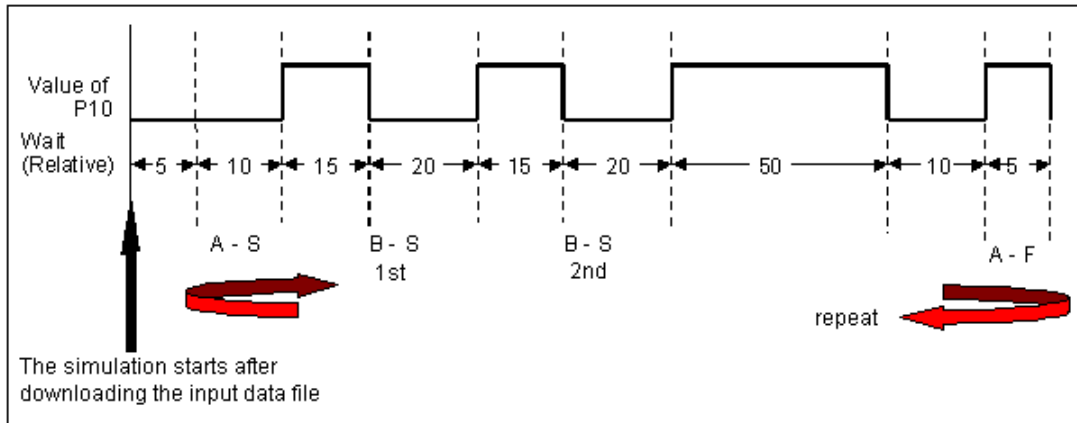

Function buttons

Pin Set	Opens the Pin Setting dialog box The specified pin will be set in the Pin field.
Generation	Cannot be selected.
Search	Opens the Search window Data in the input data file can be searched.
Clear	Initializes the contents being created and not yet saved to a file. Use this button to start editing the file again from where data was last saved to the file.
Read	Opens the Open dialog box The specified input data file (.i_x) will be read.
Save	Opens the Save As dialog box The contents of the set window are saved as an input data file (.i_x). * When specifying a file name in the Save As dialog box, be sure to use four characters followed by 0000.i_x (e.g., abcd0000.i_0 or efgi0000.i_1).
DownLoad	Opens the Down Load dialog box The specified file is downloaded to the simulator.
Help	Opens the Help window.
Cancel	Ignores the setting and closes this window.

Input timing Chart Editor window

This is one of the editor windows and is used to set an input timing chart and input data in 1-bit units to an input pin.

The following data can be displayed in this window:

- Newly created input data
- Previously created input data (to be edited)
- File simulated previously and saved to an output file

Input data can be saved to an input data file (.i_x). By downloading this file, an input signal can be generated from a pin during simulation.

Figure 7-72 Input timing Chart Editor Window

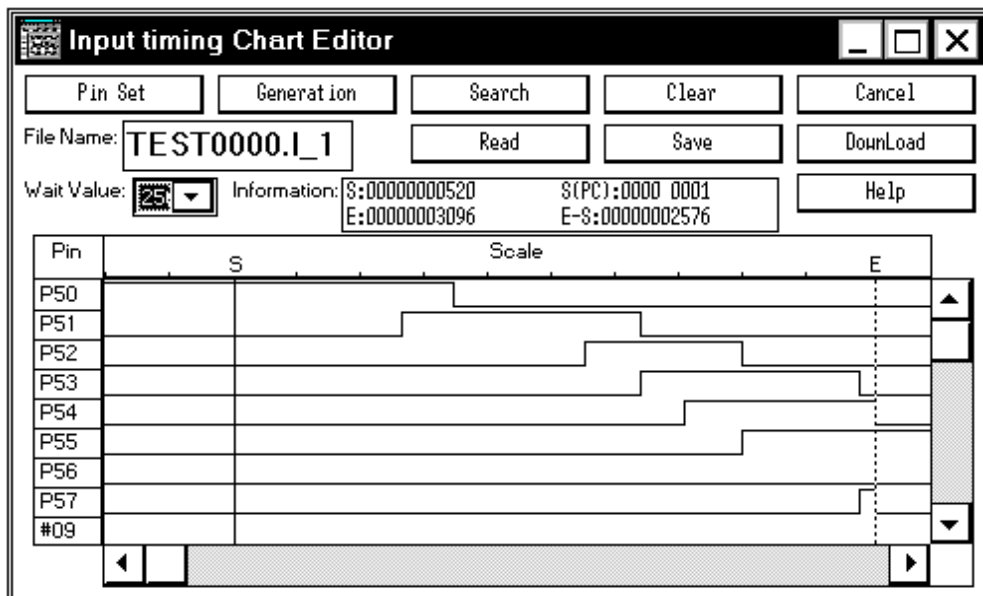

This section explains the following items:

- Opening
- Explanation of each area
- Operation
- Function buttons

Opening

This window box can be opened as follows:

- In V850 Simulator GUI window
Select [File] -> [New] -> [Timing...] from the menu bar
(or press Alt+F, N and T in that order).
Select [File] -> [Open] -> [Timing...] from the menu bar
(or press Alt+F, O and T in that order).

Explanation of each area

The Input timing Chart Editor window consists of the following areas:

- (1) File Name: (input data file name display area)
- (2) Wait Value (wait value setting area)
- (3) Information (information display area)
- (4) Timing chart setting area

(1) File Name: (input data file name display area)

File Name:

This area displays the name of the file that is currently open and can be saved. This area is not displayed if a new file is created. A name is given to the file when it is saved.

(2) Wait Value (wait value setting area)

Wait Value:

This area is used to set the timing (wait) at which data is input during simulation.

Wait Value	<p>Select a wait value (timing of data input) from the drop-down list (1, 2, 4, 8, 16, 32, 64, 128, 256, or 512). This value is used as one division of the scale.</p> <p>Select the unit of Wait from the following when the file is to be saved (to save the file, use the <Save> button):</p> <p>.i_0 ist (instruction unit) * The set wait value in this file is ignored.</p> <p>.i_1 clock (CPU clock unit) * The CPU clock unit and main clock unit are the same.</p> <p>.i_2 1/4m-clk (1/4 main clock unit)</p> <p>.i_3 m-clk (main clock unit)</p>
-------------------	--

(3) Information (information display area)

Information:

This area displays the first wait value if the time axis is not displayed.

Double-clicking near the character scale displays time axis cursor S and time axis marker E in the timing chart setting area, and the following values are displayed in the information display area:

S	Wait value from the beginning of the file to the location indicated by S
E	Wait value from the beginning of the file to the location indicated by E
S(PC)	PC value of the address at which the output value at the location indicated by S is generated (if .out file is read)
E-S	Wait value from the location indicated by S to the location indicated by E

Remark The time axis can be moved by dragging the character S or E.

(4) Timing chart setting area

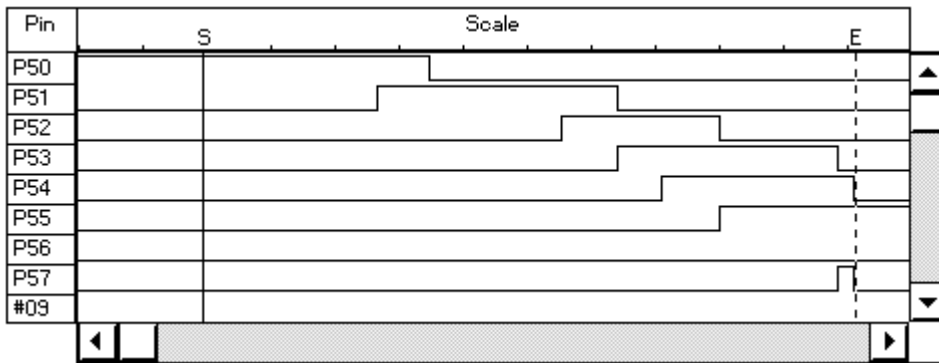

This area is used to set an input timing chart and input data for a specified pin.

The data of only an input pin can be edited. Nine pins are displayed in the default condition. Up to 48 signals can be displayed.

The size of this window can be varied.

Pin	<p>Specify the name of the pin to which data is to be input.</p> <p>For the pin name, either open the Pin Setting dialog box by using the <Pin Set> button and create a new pin name, or read a pin setting information file (.pin) by using the <Read> button on that dialog box.</p> <p>To edit an input data file (.i_x) previously saved, specify a file name using the <Read> button and read the file.</p> <p>If the left mouse button is clicked in the pin name display area where a pin name is set, the displayed pin name changes color from black to purple, indicating that the pin has been selected.</p> <p>If this input data file is downloaded, the data of only the selected pin is downloaded.</p> <p>If a display name is set, the display name* is displayed instead of a pin name.</p> <p>* For the display name, refer to the Pin Setting dialog box.</p>
-----	---

Time axis cursor, time axis marker	<p>Double-clicking near the character Scale displays a solid line and a dotted line.</p> <p>The solid line is the time axis cursor (S) and the dotted line is the time axis marker (E). After the time axis cursor and time axis marker have been displayed, each can be moved by dragging it with the mouse.</p> <p>If the time axis cursor or time axis marker has been moved to the left in the timing chart setting area and therefore cannot be displayed in the area, S or E is displayed at the upper left part of the Scale field. If the axis or marker has been moved to the right in the timing chart setting area and cannot be displayed in the area, S or E is displayed at the upper right part of the Scale field.</p>
---------------------------------------	--

Operation

Setting input data/timing

To set new data, set a pin name in the **Pin** field and double-click at any location in the timing chart setting area. A waveform can be input. If data has been fully set in the timing chart setting area, data of one division of the **Scale** can be added by clicking "EOF" displayed at the rightmost position of the **Scale** field with the right mouse button. Note .

The set waveform can be changed by using the mouse as follows in the timing chart setting area:

Caution The horizontal scroll bar is also displayed.

- With input pin

Operation	Modification
Double-clicking left button	One division changes to HIGH.
Double-clicking right button	One division changes to LOW.
Double-clicking left button with Shift key held down	One division changes to high impedance.

- With analog input pin

Operation	Modification
Double-clicking left button	Value of one division incremented by one.
Double-clicking right button	Value of one division decremented by one.
Double-clicking left button with Shift key held down	Value of one division changes by 10.
Dragging horizontal line of timing chart with mouse	Value changes by up and down movement.

If the right button of the mouse is clicked in this area, the name and value of the pin clicked at the lower right part of the information display area (**Information**) are displayed.

When an existing input data file is read and edited, input data can be added or changed by the same operation as above.

Selecting pin to which data is to be downloaded

If the pin name displayed in the [Pin](#) field is clicked, the color of the clicked pin changes from black to purple, indicating that the pin has been selected. By saving and downloading this input data file, the data of only the selected pin (in purple) can be downloaded.

Function buttons

Pin Set	Opens the Pin Setting dialog box The specified pin will be set in the Pin field.
Generation	Cannot be selected.
Search	Opens the Search window Data in the input data file can be searched.
Clear	Initializes the contents being created and not yet saved to a file. Use this button to start editing the file again from where data was last saved to the file.
Read	Opens the Open dialog box The specified input data file (.i_x) will be read.
Save	Opens the Save As dialog box The contents of the set window are saved as an input data file (.i_x). * When specifying a file name in the Save As dialog box, be sure to use four characters followed by 0000.i_x (e.g., abcd0000.i_0 or efgi0000.i_1).
DownLoad	Opens the Down Load dialog box The specified file is downloaded to the simulator.
Help	Opens the Help window.
Cancel	Ignores the setting and closes this window.

Pin Setting dialog box

This dialog box is used to set a pin to be displayed in the Input 0/1 Editor window, Input timing Chart Editor window, and Output Timing Chart window. A pin name can be set in this dialog box. The set pin name can be saved to or read from a file (.pin).

In addition, a name (display name) can be also given to the pin.

Figure 7-73 Pin Setting Dialog Box

Pin Setting	
#01	AN10 : analog input
#02	P00 : P00/T0110
#03	#03
#04	#04

Buttons: Previous, Next, OK, Save, Open, Clear, Cancel

This section explains the following items:

- Opening
- Explanation of each area
- Function buttons

Opening

This window box can be opened as follows:

- Click the <Pin Set> button in the Input 0/1 Editor window
- Click the <Pin Set> button in the Input timing Chart Editor window
- Click the <Pin Set> button in the Output Timing Chart window
- Click the <Pin Set> button in the Search window

Explanation of each area

This dialog box consists of the following areas:

- (1) Pin number display area
- (2) Pin name setting area

(1) Pin number display area

This area displays the numbers of the pins.

To set more than five pins, update the pin numbers by clicking the <Next> button.

Up to 48 pins can be set.

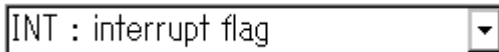
(2) Pin name setting area

This area is used to specify the pin name that corresponds to a pin number.

Select a pin name from the drop-down list, or input a name from the keyboard.

To set the selected pin name, use the TAB key or <Previous> or <Next> button.

If the pin name "PXX" is specified in the field immediately before, the pin name next to PXX is displayed in the drop-down list of the next field. Once a pin has been set, it is not displayed in the drop-down list.

Giving display name to pin

In addition, a name (display name) can be also given to the pin.

The display name of the pin is displayed in the Pin field of the window that has called this dialog box.

To give the display name "XXXXXXX", for example, set the pin name in the pin name setting area, erase the pin name, and input "@XXXXXXX".

To clear a display name, erase the pin name in the pin name setting area, and input "@".

Referencing display name

A display name is not displayed in the pin name setting area even if a display name has been set for a pin. Erase the pin name, input "@@", and move the input focus by using the TAB key.

Function buttons

Previous	Displays setting information on four pin numbers preceding the pin currently displayed.
Next	Displays setting information on four pin numbers following the pin currently displayed.
OK	Validates the setting and closes the dialog box. The pin name (or display name) is set in the Pin field of the window that has called this dialog box
Save	Opens the Save As dialog box. The displayed contents will be saved to a pin information file. A pin information file has the extension (.pin).
Open	Opens the Open dialog box. The pin setting information of a specified file (.pin) will be read.

Clear	Ignores the setting and closes the window. Use this button to start editing the file again from where data was last saved to the file.
Cancel	Ignores the setting and closes this window.

Down Load dialog box

This dialog box is used to check the name and type of the file to be downloaded, and download the file.

Up to five files of the same name, except the extension, can be downloaded while the CPU is not in operation.

Data input to the simulator that has been specified more recently has the higher priority.

Caution If an input data file is downloaded while an external component for input is being displayed, input from the input data file takes precedence. If an external component for input is being displayed while an input file is being downloaded, input from the external component is enabled. At this time, an information dialog box indicating that the connection destination has been changed is opened.

Figure 7-74 Down Load Dialog Box

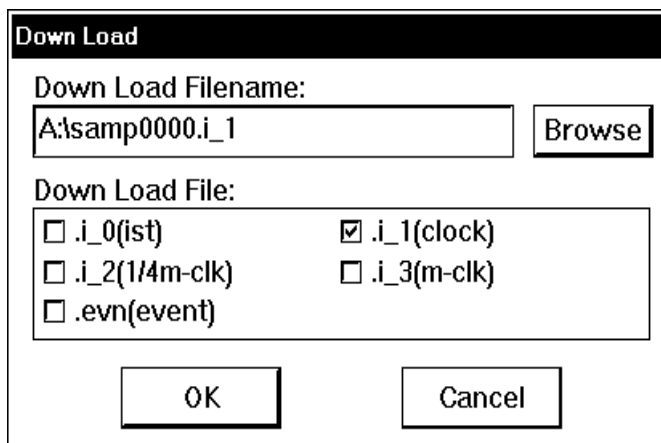

This section explains the following items:

- Opening
- Explanation of each area
- Function buttons

Opening

This dialog box can be opened as follows:

- In the V850 Simulator GUI window
Select [File] -> [DownLoad...] on the menu bar
(or press Alt+F, and D in that order).
- In the IOR Event & Action dialog box
Click the <Down Load> button.

- In the Input 0/1 Editor window
Click the <Down Load> button.
- In the Input timing Chart Editor window
Click the <Down Load> button.

Explanation of each area

This dialog box consists of the following areas:

- (1) Down Load Filename: (file name specification area)
- (2) Down Load File: (file type specification area)

(1) Down Load Filename: (file name specification area)

Down Load

This area is used to input the name of the file to be downloaded.

Input a file name from the keyboard, or select one from the Open dialog box, which can be opened by using the <Browse> button.

(2) Down Load File: (file type specification area)

Down Load File:

.i_0(ist) .i_1(clock)
 .i_2(1/4m-clk) .i_3(m-clk)
 .evn(event)

This area is used to specify the type of the file to be downloaded. The file type can be specified by using a checkbox.

Up to five types of files can be simultaneously downloaded. If two or more files are specified, they are sequentially downloaded starting from the top. If the same pin is used for input in two or more files, the input of the file downloaded later becomes valid.

If no file type is selected, a message box with the message "All downloaded data will be cleared." pops up. If the <OK> button is clicked, nothing will be downloaded.

Function buttons

Browse	Opens the Open dialog box. This area is used to select the file to be download.
OK	Validates the setting, downloads the specified file, and closes the dialog box.
Cancel	Ignores the setting and closes this window.

Output Setting dialog box

This dialog box is used to perform the settings necessary for saving the data of the pin being simulated to an output file.

It is also used to select whether the Output Timing Chart window is to be displayed.

Figure 7-75 Output Setting Dialog Box

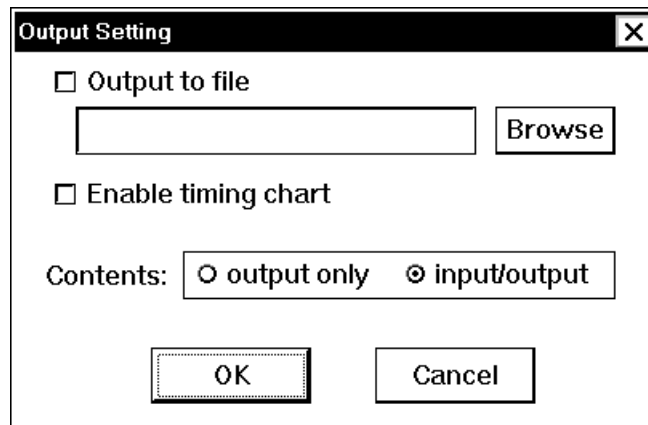

This section explains the following items:

- Opening
- Explanation of each area
- Function buttons

Opening

This dialog box can be opened as follows:

- In the V850 Simulator GUI window
Select [File] -> [Output...] on the menu bar
(or press Alt,+F, and U in that order).

Explanation of each area

This dialog box consists of the following areas:

- (1) File output specification area
- (2) Timing chart output specification area

(1) File output specification area Output to file

	Browse
--	--------

This area is used to select whether the data of the pin being simulated is to be saved to a file.

Output to file	<p>To save the data, check this check box.</p> <p>To specify a file name (.out), click the <Browse> button and search a file name, or input a file name from the keyboard.</p> <p>Remove the check from this check box if the data is not to be saved to a file, or to abort output of the data to the file.</p> <p>Information on all the pins is output to the file (this is independent of timing chart output).</p>
-----------------------	---

(2) Timing chart output specification area Enable timing chart

Contents: output only input/output

This area is used to select whether the data of the pin being simulated is output as a timing chart.

Enable timing chart	<p>Check this check box to output data in the form of a timing chart. The data is displayed in the Output Timing Chart window.</p> <p>Remove the check from the check box to not display the data as a timing chart.</p>
Contents:	<p>Specify the contents to be displayed on a timing chart by using the option button.</p> <p>output only Saves information on the output pin.</p> <p>input/output Saves information on the input/output pin.</p>

Editing .out file as input data

- 1 Read a file (.out) by using the <Read> button in either the Input 0/1 Editor window or Input timing Chart Editor window.
- 2 The data is not displayed only by reading it. Specify the name of a pin whose data has been saved to the file (.out), by using the <Pin Set> button in the Input 0/1 Editor window. The contents of the file will be then displayed.
- 3 After editing the data, save the data to an input data file by using the <Save> button. At this time, the identifier of the file must be .i_2.

Function buttons

Browse	<p>Opens the Open dialog box.</p> <p>The specified file will be the output destination file.</p>
---------------	--

OK	Validates the setting and closes the dialog box. If "Output to file" is selected, the pin information is saved to a specified file. If "Enable timing chart" is selected, the Output Timing Chart window is opened and the specified contents are displayed.
Cancel	Ignores the setting and closes this dialog box.

Output Timing Chart window

This window displays a timing chart of the data output from the program currently simulated and related input data and interrupt signals. It also displays the data from all the peripheral I/O registers on one window.

This window supports the project files of the debugger.

This window displays the data from all the peripheral I/O registers on one window.

Figure 7-76 Output Timing Chart Window

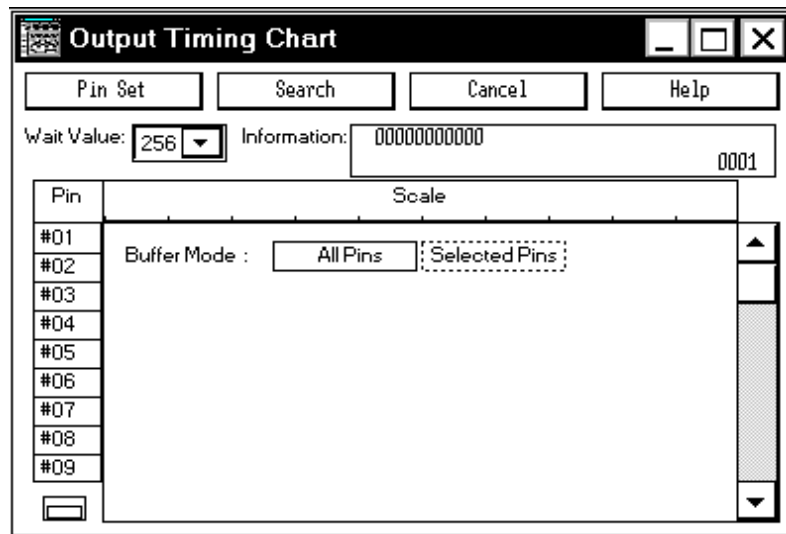

This section explains the following items:

- Opening
- Explanation of each area
- Function buttons

Opening

This window can be opened as follows:

- 1 In the V850 Simulator GUI window
Select [E]ile -> [O]utput... from the menu bar
(or press Alt+F, and U in that order).
- 2 In the Output Setting dialog box
Check [Enable timing chart] and click the <OK> button.

Explanation of each area

The Output Timing Chart window consists of the following areas:

- (1) Wait Value: (wait value setting area)
- (2) Information: (information display area)
- (3) Timing chart display area

(1) Wait Value: (wait value setting area)

Wait Value: ▾

Select a wait value (timing of display data) from the drop-down list

The selected value will be one division of the **Scale** (unit: 1/4 main clock).

The values that can be selected from the drop-down list are: 16, 32, 64, 128, 256, 512, 1024, 2048, 4096, and 8192.

(2) Information: (information display area)

Information: 0001

This area displays the wait value from the beginning of simulation to the part executed last, and the pin change point if the time axis is not displayed. Double-clicking near the character **Scale** displays time axis cursor S and time axis marker E in the timing chart display area, and the following values:

S	Wait value from the beginning of simulation to the location indicated by S
E	Wait value from the beginning of simulation to the location indicated by E
E-S	Wait value from the location indicated by S to the location indicated by E

Reference 1 Double-clicking in this area selects the "Display Off (non display)" and increases the execution speed of simulation. To turn the display on, double click again.

Reference 2 The wait value is displayed in units of 1/4 main clocks (1/4m-clk).

The figure at the lower right part of this area indicates the change point of a pin*.

Up to 1350 pin change points can be displayed. If 1350 is exceeded, the information in the buffer is sequentially overwritten by the latest information, starting from the information at the beginning of the buffer (the displayed number of change points will not increase from 1350). If two or more pins change at the same time, it is counted as only one change point.

* A change point means the location at which the data of a pin changes (H to L, L to H, or between H/L and Z).

(3) Timing chart display area

This area displays changes in the data of a specified pin as a timing chart.

A scroll bar that is used to scroll the timing chart up, down, to the left, and to the right is also displayed.

The HIGH and LOW signals are displayed in green. The high-impedance signal is displayed in red at the center. The information in a range not buffered is displayed in blue at the center.

In the default condition, nine signals are displayed. Up to 48 signals can be displayed.

The size of this window can be varied.

Reference Double-clicking in this area selects "Display Off (non display)" and increases the execution speed of simulation. To turn the display on, double click again.

Pin	<p>Displays the name of the pin that has generated the timing chart, and interrupt signal pins.</p> <p>For the pin name, either open the Pin Setting dialog box by using the <Pin Set> button and create a new pin name, or read a pin setting information file (.pin) by using the <Read> button on that dialog box.</p>
Time axis cursor, time axis marker	<p>Double-clicking near the character Scale displays a solid line and a dotted line.</p> <p>The solid line is the time axis cursor (S) and the dotted line is the time axis marker (E). After the time axis cursor and time axis marker have been displayed, each can be moved by dragging it with the mouse.</p> <p>If the time axis cursor or time axis marker has been moved to the left in the timing chart setting area and therefore cannot be displayed in the area, S or E is displayed at the upper left part of the Scale field. If the axis or marker has been moved to the right in the timing chart setting area and cannot be displayed in the area, S or E is displayed at the upper right part of the Scale field.</p> <p>The time axis can be moved by dragging the character E or S. If the time axis has been moved to a part that does not have data, "[]" is displayed on S or E.</p> <p>If INT is specified as a pin name, an interrupt waveform* is displayed. If an interrupt occurs, the waveform is displayed as HIGH.</p> <p>* An interrupt waveform is displayed as, for example, "+P0" if interrupt INTPO occurs (if the interrupt request flag is set), and as "-P0" if that interrupt has been processed (if the interrupt request flag is cleared). If two or more interrupts occur at the same time, "+P0+P1" is displayed. While two or more interrupts are occurring, the waveform changes its color from green to red.</p>

To select pin to be buffered

By selecting **All Pins** or **Selected Pins**, which is displayed at reset, the information to be output to the output buffer during execution can be specified.

Selecting All Pins	Information on all the pins of the target device is output to the output buffer (default).
Selecting Selected Pins	Only the information displayed in the Pin field of the Output Timing Chart window is output to the output buffer.

To turn off display of Function buttons and Information: (information display area)

The double rectangle at the lower left of the window is a toggle switch that is used to change the display object in the Output Timing Chart window.

This toggle switch can be used to reduce the Output Timing Chart window.

If this toggle switch is clicked while the function buttons and the Information area are displayed, the display is changed as follows:

Clicking once	Turns off display of the function buttons.
Clicking twice	Turns off display of the function buttons and Information area.
Clicking three times	Displays all (restores the originals status).

Function buttons

Pin Set	Opens the Pin Setting dialog box The specified pin will be set in the Pin field.
Search	Opens the Search window Data in the output data file can be searched.
Cancel	Opens a confirmation dialog box. If the <OK> button is clicked, closes the Output Timing Chart window.
Help	Opens the Help window.

Search window

This window is used to search data in an input data file or output buffer.

It searches data displayed in the Input 0/1 Editor window, Input timing Chart Editor window, and Output Timing Chart window.

Note that interrupt signals and analog input/output signals cannot be searched.

Once the set data has been searched, it is held until the simulator is terminated. If this window is closed once and then opened again, the previous information is displayed.

Figure 7-77 Search Window

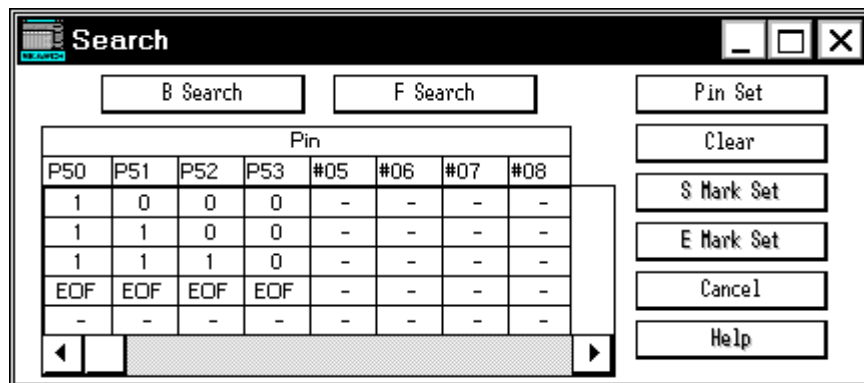

This section explains the following items:

- Opening
- Explanation of each area
- Function buttons

Opening

This window box can be opened as follows:

- Click the <Search> button in the Input 0/1 Editor window
- Click the <Search> button in the Input timing Chart Editor window
- Click the <Search> button in the Output Timing Chart window

Explanation of each area

The Search window consists of the following areas:

- (1) Search data setting table

(1) Search data setting table

This area is used to set the pattern of the data to be searched for each pin.

Eight pins are displayed in five stages in the default condition. The number of pins and stages displayed can be changed.

Pin	Specify the name of the pin whose data is to be searched. For the pin name, either open the Pin Setting dialog box by using the <Pin Set> button and create a new pin name, or read a pin setting information file (.pin) by using the <Open> button on that dialog box. If a display name is set for the pin, the display name is displayed.
-----	--

In the search data setting table, 1 (HIGH), Z (high impedance), 0 (LOW), or - (don't care) can be set.

An analog input pin, analog output pin, and interrupt signal cannot be searched.

Searching data**1 Set data to be searched.**

If a pin name is set in the Pin field, EOF is set in the data setting table. By clicking this EOF, one line of data to be searched can be inserted. In the clicked field, data is set with the pin status on the immediately preceding line changed to the next alternative (1 -> Z -> - -> 0, in that order). In the other fields, data with the same status as that on the immediately preceding line is set.

The data to be searched can be changed in the order of 1, Z, -, and 0, by clicking the mouse.

2 Start searching.**In the Input timing Chart Editor window or, Output Timing Chart window**

The searching can be started by clicking the <B Search> or <F Search> button.

The data that matches the specified data is indicated by a red line.

By clicking the <S Mark Set> or <E Mark Set> button at this time, a time axis can be set at the matching data.

Once matching data has been found, searching is started again from that part, unless the data to be searched is changed or the display is scrolled.

In the Input 0/1 Editor window

The searching can be started by clicking the <U Search> or <D Search> button.

The data that matches specified data is displayed at the top. No red line is displayed in this case.

To set new data to be searched

Erase the old data by clicking the <Clear> button and then set new data.

Two windows cannot be opened at the same time.

Function buttons

B Search	Searches for matching data from the end of the part currently displayed toward the beginning. To search data in the Input 0/1 Editor window, this button is replaced by the <U Search> button.
----------	---

F Search	Searches for matching data from the beginning of the part currently displayed toward the end. To search data in the Input 0/1 Editor window, this button is replaced by the <D Search> button.
Pin Set	Opens the Pin Setting dialog box The specified pin will be set in the Pin field.
Clear	Clears all the set contents.
S Mark Set	This button can be selected if data that matches the specified data has been found as a result of a search. When this button is selected, the time axis cursor S moves to the position of the matching data. * This button is valid only if data is searched in the Input timing Chart Editor window or Output Timing Chart window.
E Mark Set	This button can be selected if data that matches the specified data has been found as a result of a search. When this button is selected, the time axis marker E moves to the position of the matching data. * This button is valid only if data is searched in the Input timing Chart Editor window or Output Timing Chart window.
Cancel	Closes this window.
Help	Opens the Help window.

Parts window

This window is used to configure a dummy target system. It displays external parts.

The Parts window can be used to configure a dummy target system by setting external parts. The set external parts are displayed in this window, and are used as pins of signals during simulation in the execution mode.

In addition, these components can also be moved in the window in the placement mode.

Information on the component placed in the window can be saved to a file (.pnl). In addition, the saved file can be read.

Caution For the operation of the I/O panel when the CPU is reset, refer to "Operation of external parts at CPU reset".

Figure 7-78 Parts Window

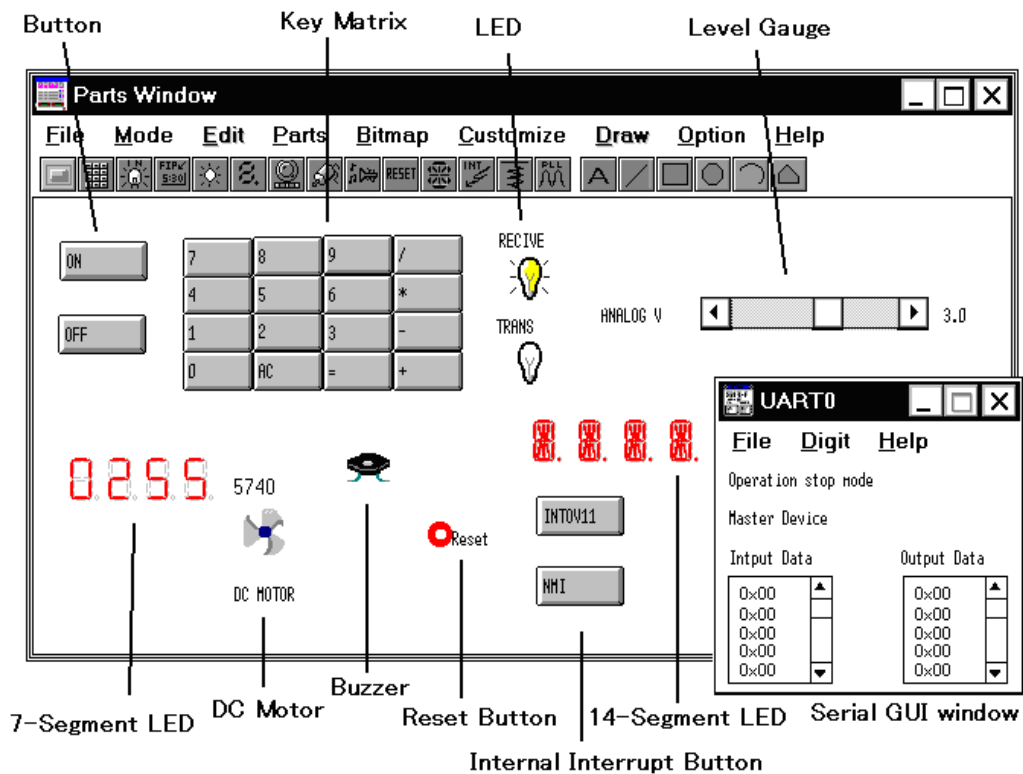

This section explains the following items:

- Opening
- Toolbar
- Menu bar
- Setting

Opening

This window can be opened as follows:

- In the V850 Simulator GUI window
Select [External Parts] -> [Panel Window...] from the menu bar
(or press Alt+E, and P in that order).

Toolbar

The toolbar is used to open each external component setting window (except the Serial GUI window).

The same operation can be also performed by selecting the [Parts] menu.

Display of the toolbar can be alternately turned on or off by selecting [Option] -> [Tool Bar] from the menu bar.

Figure 7-79 Toolbar (Parts Window)



	Opens the Buttons dialog box.
	Opens the Key Matrixes dialog box.
	Cannot be selected.
	Cannot be selected.
	Opens the LEDs dialog box.
	Opens the 7seg LEDs dialog box.
	Opens the Level Gauges dialog box.
	Opens the DC Motors dialog box.
	Opens the Buzzers dialog box.
	Displays a reset button in the window.
	Opens the 14seg LEDs dialog box.
	Opens the Internal Interrupt Button dialog box.
	Opens the Pull-Up / Pull-Down dialog box.

	Cannot be selected.
	Cannot be selected.
	Cannot be selected.
	Cannot be selected.
	Cannot be selected.
	Cannot be selected.
	Cannot be selected.

Menu bar

Displaying the menu bar can be turned on or off by selecting [MENU Valid] in the control menu box of this window.

(1) [File] menu

Select this menu to save information on the Parts window to a file (.pnl) or read saved information from a file.

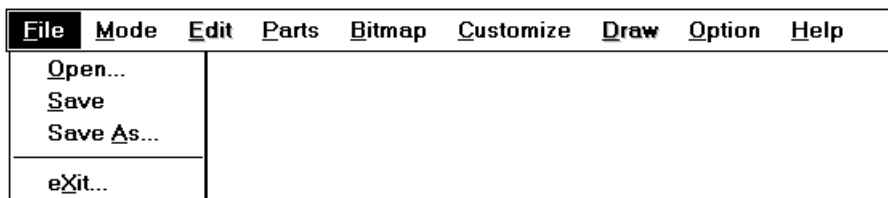

Open...	Opens the Open dialog box. Information on the Parts window can be read from a specified file (.pnl).
Save	Overwrites and saves the current information on the Parts window to the file currently being read (.pnl).
Save As...	Opens the Save As dialog box. The current information on the Parts window can be saved to a specified file (.pnl).
eXit	Closes this window.

(2) [Mode] menu

This menu is used to select the mode in which simulation is executed (execution mode) or the mode in which an external component can be connected to a pin or the placement of an external pin can be changed (placement mode), in the window.

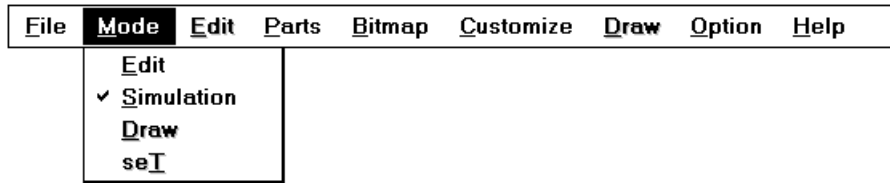

Edit	Displays a dialog box that indicates the position (x and y coordinates) of the mouse cursor and sets the window in the placement mode. This menu is used to move or edit the external component displayed on the Parts window, can be select the [Edit] menu.
Simulation	Sets the window in the execution mode. The simulation of parts is possible. (default)
Draw	Cannot be selected.
seI	Cannot be selected.

(3) [Edit] menu

This menu is used to move or edit the external part displayed on the Parts window, so that the user can freely create the image of a system.

This menu can be selected only in the placement mode.

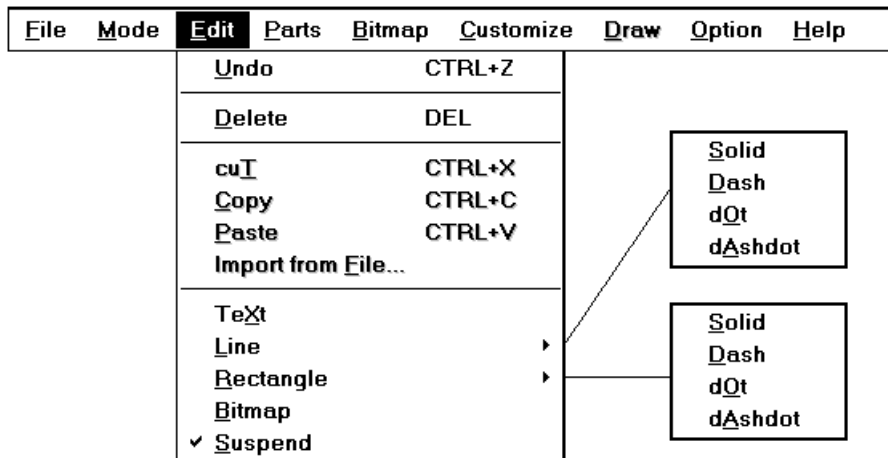

Undo	Restores the original status after a change, such as moving a component, has been made in the window.
Delete	If this is selected when a component has been selected by the mouse, the selected component is deleted.
cuI	Cannot be selected.
Copy	Cannot be selected.
Paste	Cannot be selected.
Import from File...	Cannot be selected.
teXt	Opens a dialog box for inputting characters. In this dialog box, input a character, click the location at which the character is to be placed, and then click the <OK> button.

<u>L</u> ine	Select this to draw a straight line in the window. Select any of the following from the submenu:
<u>S</u> olid	Draws a solid line.
<u>D</u> ash	Draws a dashed line.
<u>dO</u> t	Draws a dotted line.
<u>dA</u> shdot	Draws an alternate long and short dash line.
<u>R</u> ectangle	Select this to draw a rectangle in the window. Select any of the following from the submenu:
<u>S</u> olid	Draws a rectangle in solid line.
<u>D</u> ash	Draws a rectangle in dashed line.
<u>dO</u> t	Draws a rectangle in dotted line.
<u>dA</u> shdot	Draws a rectangle in an alternate long and short dash line.
<u>B</u> itmap	Select this to change the bitmap of the component displayed in the window (button and DC motor only). Open the Bitmap window and select a bitmap (the selected bitmap will be highlighted). Click the position at which a new bitmap is to be pasted.
<u>S</u> uspend	Select this to stop editing such as input and to move, delete, or undo the editing of a component.

(4) [Parts] menu







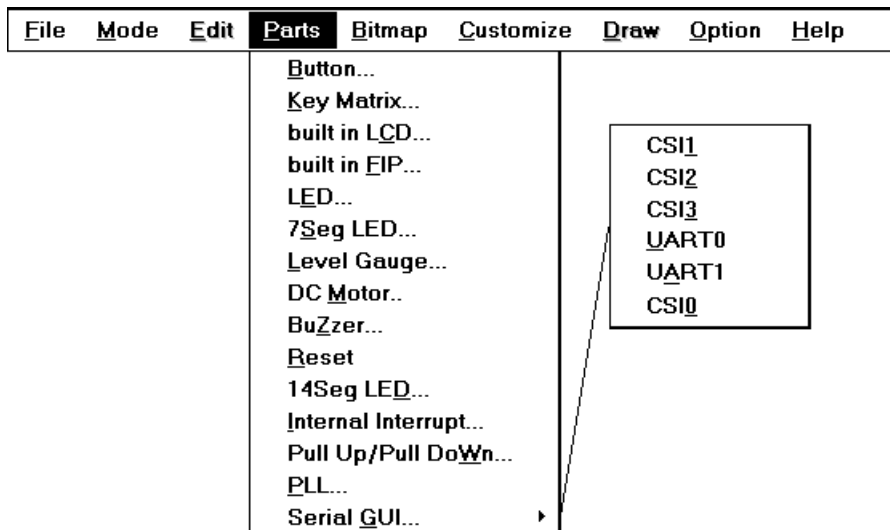



Select this menu to set the connection relationship with the supplied external parts.

When setting is complete, the corresponding component is displayed in this window and is used as the pin for inputting/outputting signals during simulation.

If the submenu is selected, the corresponding setting window is opened and the environment of the connection between pins and external parts can be set.



<u>B</u> utton...	Opens the Buttons dialog box  button's operation is the same as clicking this button.
-------------------	---

Key Matrix...	Opens the Key Matrixes dialog box  button's operation is the same as clicking this button.
built in LCD...	Cannot be selected.
built in EIP...	Cannot be selected.
LED...	Opens the LEDs dialog box  button's operation is the same as clicking this button. .
7Seg LED...	Opens the 7seg LEDs dialog box  button's operation is the same as clicking this button. .
Level Gauge...	Opens the Level Gauges dialog box  button's operation is the same as clicking this button. Note that this item can be selected only with a device that includes an internal A/D converter.
DC Motor...	Opens the DC Motors dialog box  button's operation is the same as clicking this button.
BuZzer...	Opens the Buzzers dialog box  button's operation is the same as clicking this button.
Reset...	Displays a reset button in the window. If the reset button is clicked during simulation, a reset signal is input to the simulator.  button's operation is the same as clicking this button.
14Seg LED...	Opens the 14seg LEDs dialog box  button's operation is the same as clicking this button.
Internal Interrupt...	Opens the Internal Interrupt Button dialog box  button's operation is the same as clicking this button.
Pull Up/Pull DoWn...	Opens the Pull-Up / Pull-Down dialog box  button's operation is the same as clicking this button.
PLL...	Cannot be selected.
Serial GUI...	Opens the Serial GUI window of the corresponding channel when the submenu is selected. * The submenu differs depending on the device.

(5) [Bitmap] menu

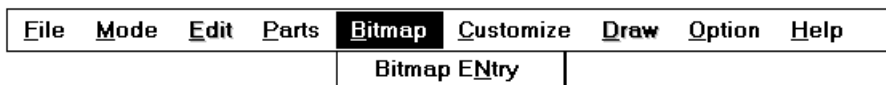

Bitmap ENtry	Opens the Bitmap Entry dialog box
------------------------------	-----------------------------------

(6) [Customize] menu

Select this menu to load the file (.dll) necessary for using the external component created by the user.

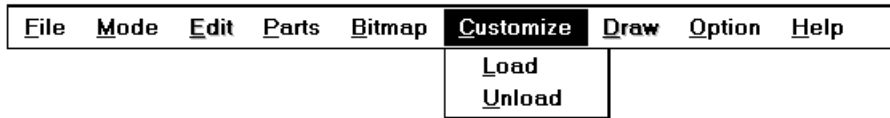

Caution If the Parts window is closed with information on the user DLL saved or loaded to a project file, the position of the user custom component displayed in the Parts window is different from the position that was saved to the file, even if the user DLL is read by opening a load or project file.

Load...	Opens the Read dialog box. The specified user DLL file will be read. Up to 6 files can be read.
Unload	Invalidates all the user DLL files currently loaded.

(7) [Draw] menu

Cannot be selected.

(8) [Option] menu

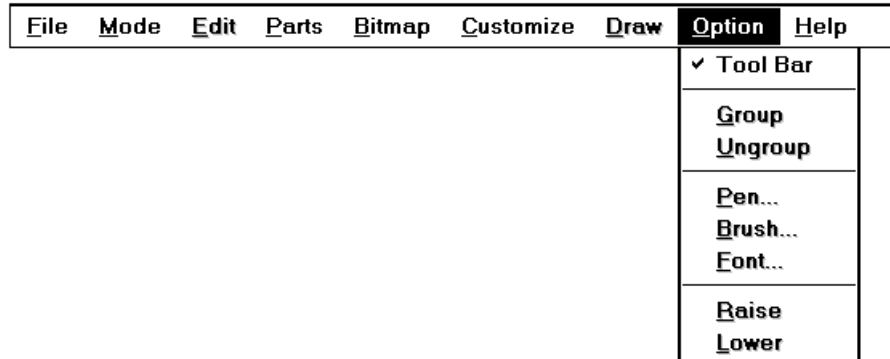

Tool Bar	Turns on or off display of the toolbar. If this is checked, the toolbar is displayed (default).
Group	Cannot be selected.
Ungroup	Cannot be selected.
Pen...	Cannot be selected.
Brush...	Cannot be selected.
Font...	Cannot be selected.
Raise	Cannot be selected.
Lower	Cannot be selected.

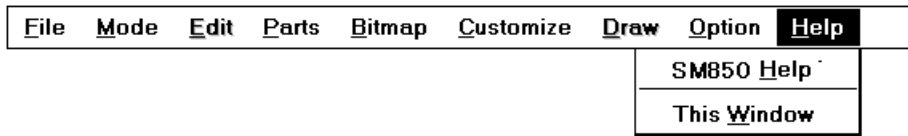
(9) [Help] menu

SM850 <u>H</u> elp	Opens the Help window of SM850.
This <u>W</u> indow	Opens the Help window.

Setting**Input operation from external parts**

An input operation from an external parts is enabled if the Parts window is in the execution mode. For details, refer to the setting dialog box page of each component.

Displaying external parts

The external parts displayed in the setting dialog box of each external parts is displayed in the Parts window according to the following rules:

- If components are cascade displayed, the component displayed first is shown in front. Therefore, a component newly created may be hidden behind the component displayed first. In this case, move the new component forward.
- If components that are cascade displayed are saved to the information file (.pnl) or project file (.prj) of the window and then the components are displayed by reading information from these files, the components are displayed in this order: Button -> Key matrix -> LED -> 7-segment LED -> Level gauge -> DC motor -> Buzzer -> Reset button -> 14-segment LED -> Internal interrupt button.

Scroll bar

If the components do not fit in the Parts window while they are connected, a scroll bar is displayed.

By using this scroll bar, even components that are larger than the screen can be created. In addition, the screen can also be reduced so that only the desired component is viewed.

The scroll bar can be manipulated regardless of the mode.

Editing in Parts window

The following editing modes of the Parts window can be used when the window is in the placement mode:

- <Moving external parts, characters, lines, and rectangles>
- <Deleting external parts, characters, lines, and rectangles>
- <Restoring modification>
- <Input characters>
- <Inputting lines>
- <Inputting rectangles>
- <Re-pasting bitmaps>
- <Stopping editing>

- <Other>

In the placement mode, the following window indicated by the mouse position and the coordinates is displayed.

Figure 7-80 Mouse Position and Coordinates

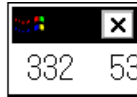

<Moving external parts, characters, lines, and rectangles>

- 1 Click the component (external component ^{Note}, character, line, or rectangle) to be moved.
 - > The selected external component is indicated by a blue dotted line. If a character, line, or rectangle is selected, the display color changes from black to blue.
- 2 While holding down the left mouse button on the selected component, move (drag) the component. Release the mouse button when the component has reached the desired position.
 - > The selected component will move to the specified position.

To move two or more components at the same time, click the second component while holding down the Shift key, and drag and drop it, still holding down the Shift key.

Up to 16 components can be selected at the same time.

Note An external component can be moved in units of the pin connected to it.
A 7-segment LED or 14-segment LED can be moved in component units.

<Deleting external parts, characters, lines, and rectangles>

- 1 Click the component (external component, character, line, or rectangle) to be moved.
 - > The selected external component is indicated by a blue dotted line. If a character, line, or rectangle is selected, the display color changes from black to blue.
- 2 Select [Edit] -> [Delete] from the menu bar.
 - >The selected component will be deleted.

To delete two or more components at the same time, click the second component while holding down the Shift key, and select [Edit] -> [Delete] from the menu bar.

Caution An external component is deleted in units of the pin connected to it.
A 7-segment LED or 14-segment LED is deleted in component units.

<Restoring modification>

If any modification has been made on the Parts window, one status before the modification can be restored by selecting [Edit] -> [Undo] from the menu bar.

Modifications cannot be restored retrogressively.

<Input characters>

Up to 20 character strings can be written in the window.

- 1 Select [Edit] -> [TeXt] from the menu bar.
-> A dialog box requesting input of characters will be opened.

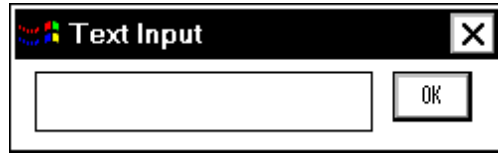

- 1 Click the part of the Parts window where characters are to be input.
->The clicked part is marked.
- 2 Move the cursor to the character input dialog box, and input a character string from the keyboard.
The number of characters that can be input at one time is 20 characters.
- 3 Click the <OK> button.
-> The input character string will be written at the position specified in 2.

<Inputting lines>

Up to 20 lines can be drawn in the window.

- 1 Select [Edit] -> [Line] from the menu bar. Select the line type from the submenu.
- 2 Determine the start position using the left mouse button.
- 3 If the mouse is moved, a straight line will be displayed from the start and end points of the mouse movement.
- 4 Determine the end point of the line by clicking the left mouse button.
->The start point and end point will be connected with a straight line (the thickness of the line is fixed).

<Inputting rectangles>

Up to 20 rectangles can be drawn in the window.

- 1 Select [Edit] -> [Rectangle] from the menu bar. Select the line type from the submenu.
- 2 Determine the position of the upper left corner of the rectangle using the left mouse button.
- 3 Move the mouse. A rectangle will be displayed, with the current mouse position assumed as the lower right corner.
- 4 Determine the lower right corner of the rectangle by clicking the left mouse button.
->A rectangle will be displayed between the upper left corner previously specified and the current position of the mouse (the thickness of the lines is fixed).

<Re-pasting bitmaps>

The bitmap of an external component (button and DC motor only) can be replaced with another bitmap that has already been registered.

For how to register a bitmap file, refer to the explanation of the Bitmap Entry dialog box. Note that the bitmap window explained below and the Bitmap Entry dialog box cannot be manipulated at the same time.

- 1 Select [Edit] -> [Bitmap] from the menu bar.
->The bitmap window will open.

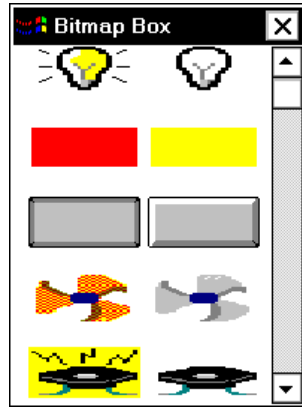

- 2 Click the bitmap to be replaced from the bitmap window that has been opened.
->The selected bitmap will be highlighted.
- 3 Click the external component that is to be replaced in the Parts window.
->The bitmap selected in 2 will be replaced by the external component in the Parts window.

If a button is replaced with another bitmap, the function name is not displayed.

<Stopping editing>

To move, delete, or restore a component after a character, line, or rectangle has been input or a bitmap has been replaced, select [Edit] -> [Suspend] from the menu bar. [Suspend] on the pull-down menu will be checked, and the component being edited can be moved, deleted, or restored.

This field is also checked immediately after the mode has been changed to the placement mode.

<Other>

When inputting a character, line, or rectangle, or when a bitmap box is selected, the editing function currently selected persists until another editing function, such as inputting another character, line, or rectangle, or selecting another bitmap, or stopping editing, is selected.

Buttons dialog box

This dialog box is used to set or change the connection information of the button to be displayed in the Parts window.

Data can be input to the simulator from the displayed button.

The connection information can be saved to a file (.btn). In addition, the saved file can be read.

Caution To set a button, follow these steps:

- 1 Set a pull-up/down resistor (refer to "Pull-Up / Pull-Down dialog box").
- 2 Set a button.

If a button has been set first, open the Buttons dialog box again after setting a pull-up/down resistor, and click the <OK> button.

When the button is pressed, the value specified by the [Active] option button in the connection information area is input to the input pin connected to the button.

When the button is not pressed, the value specified in the Pull-Up / Pull-Down dialog box is assumed.

When a pull-up/down resistor is not set, the simulator assumes that the value when the button is not pressed is 0.

Figure 7-81 Buttons Dialog Box

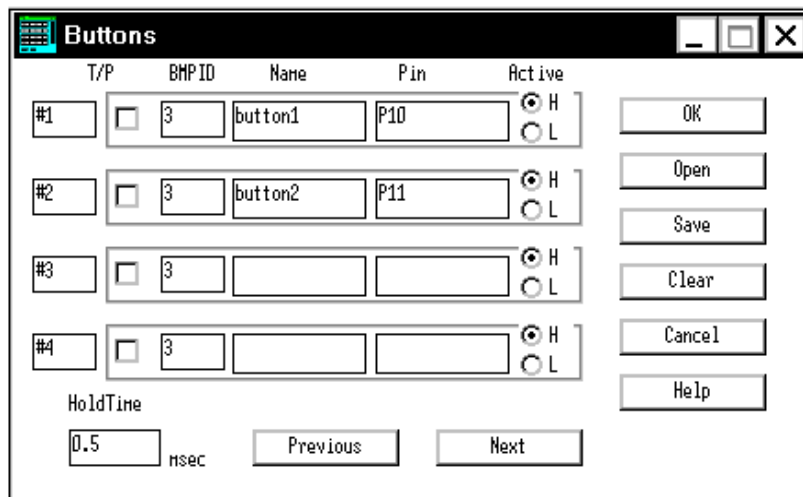

This section explains the following items:

- Opening
- Explanation of each area
- Setting
- Function buttons

Opening

This dialog box can be opened as follows:

- 1 In the V850 Simulator GUI window
Select [External Component] -> [Parts...] from the menu bar
(or press Alt+E, and P in that order).
- 2 Click the  button in the Parts window.
or select [Parts] -> [Button...] from the menu bar
(or press Alt+P, and B in that order).

Explanation of each area

The Buttons dialog box consists of the following areas:

- (1) Button ID display area
- (2) Connection information setting area
- (3) Hold Time (hold time setting area)

(1) Button ID display area

#1

This area displays the ID number to be assigned to the button to be set.

To set five or more buttons, click the <Next Page> button. The set information will be cleared and the ID number will be updated.

Up to 32 ID numbers can be set.

(2) Connection information setting area

T/P	BMP ID	Name	Pin	Active
<input type="checkbox"/>	3	button1	P10	<input checked="" type="radio"/> H <input type="radio"/> L

This area is used to set or display information on the connection between a button and a pin.

Set each field in this area.

Function	This check box specifies whether the button is provided with a toggle function or a push function. If this check box is checked, the toggle function is provided. When the push function is provided, a hold time must be set.
BMP ID	Specify the registration number of the bitmap when the button is displayed on the Parts window, in numerals. If an ID number does not exist or if no ID number is specified, a bitmap with registration number 3 is selected as default (refer to "Bitmap Entry dialog box").

Name	Specify the character string to be displayed above the button. Up to 8 characters can be input in characters.
Pin	Specify the name of the pin to be connected to the button. Up to eight characters can be input. * For the specifiable pin names, refer to the user's manual of the device used.
Active	Specify the active status of the set button by using the option button. The default status is active-high (H).

(3) **Hold Time (hold time setting area)**

HoldTime

msec

This area sets the hold time of a button for which the push function is specified.

The settable range is 0.001 ms to 999 ms. The default value is 0.5 ms.

Setting

Input operation of button

By pressing the displayed button, data can be input to the pin connected to the button.

Display example:

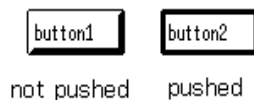

The data that can be input differs depending on whether the toggle or push function is provided for the button.

<Button with toggle function>

Each time the button is pressed, the information at that point is loaded to the simulator. The input value is retained and simulation continues until the button is pressed again.

<Button with push function>

By pressing the button, the information at that point is loaded to the simulator. The input value is retained for the hold time of the button and simulation continues. When the hold time has expired, the value returns to the original value.

Function buttons

Previous	Displays the setting four ID numbers before the ID number currently displayed, in each area.
Next	Displays the setting four ID numbers after the ID number currently displayed, in each area.
OK	Checks for errors in the set connection information. If an error or warning has occurred, a message is displayed on the dialog box. If an error or warning has not occurred, control is transferred to the Parts window, and the set external component is displayed.
Open	Opens the Open dialog box. Connection information will be read from a previously saved file (.btm).
Save	Opens the Save As dialog box. The displayed connection information will be saved to a file (.btm).
Clear	Clears the set contents.
Cancel	Ignores the setting and closes this dialog box.
Help	Opens the Help window.

Key Matrixes dialog box

This dialog box is used to set or change the connection information of the button to be displayed in the Parts window.

Data can be input to the simulator from the displayed button.

A key matrix consisting of input and output pins can be specified in units of 4-4, and a matrix of up to 16-16 can be specified.

The connection information can be saved to a file (.key). In addition, the saved file can be read.

Caution To set a key matrix, follow these steps:

- 1 Set a pull-up/down resistor (refer to "Pull-Up / Pull-Down dialog box").
- 2 Set a key matrix.

If a key matrix has been set first, open the Key Matrixes dialog box again after setting a pull-up/down resistor, and click the <OK> button.

When a key is pressed, the output value of the output pin connected to that key is input to the input pin connected to the key.

When the key is not pressed, the value specified in the Pull-Up / Pull-Down dialog box is assumed.

If a pull-up/down resistor is not set, the simulator assumes the value when the key is not pressed is 0.

Figure 7-82 Key Matrixes Dialog Box

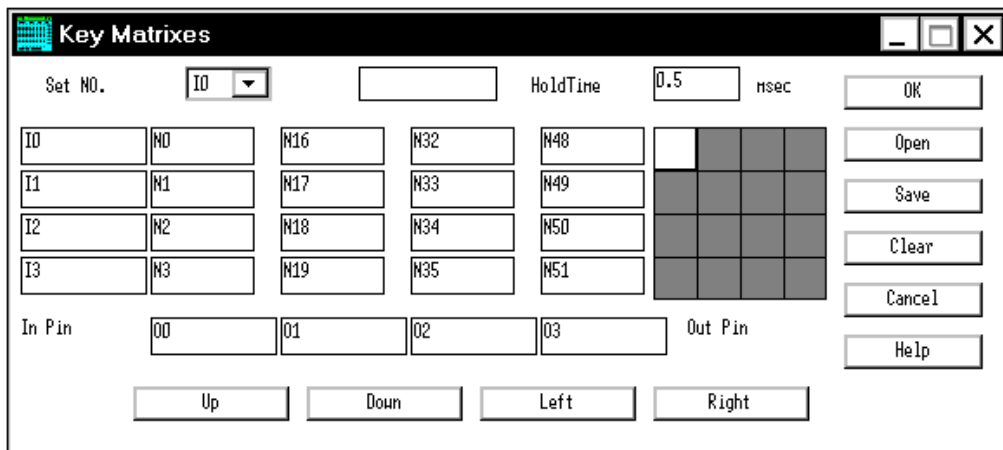

This section explains the following items:

- Opening
- Explanation of each area
- Setting
- Function buttons

Opening

This dialog box can be opened as follows:

- 1 In the V850 Simulator GUI window
Select [E]xternal Parts] -> [P]anel Window...] from the menu bar
(or press Alt+E, and P in that order).
- 2 Click the  button in the Parts window.
or select [P]arts] -> [K]ey Matrix...] from the menu bar
(or press Alt+P, and K in that order).

Explanation of each area

The Key Matrixes dialog box consists of the following areas:

- (1) In Pin, Out Pin (input/output pin setting area)
- (2) Key name setting area
- (3) Hold Time (hold time setting area)
- (4) Set NO. (successive setting area)
- (5) Set position display area

(1) In Pin, Out Pin (input/output pin setting area)

I0					
I1					
I2					
I3					
In Pin	00	01	02	03	Out Pin

This area is used to set the name of the input pin (pin input to the simulator: "Ix" (x indicates a numeral) is displayed in the default condition) and the name of the output pin (pin output by the simulator: "Ox" is displayed in the default condition) that constitute a key matrix.

Up to eight characters can be input.

Caution For the specifiable pin names, refer to the user's manual of the device used.

(2) Key name setting area

N0	N16	N32	N48
N1	N17	N33	N49
N2	N18	N34	N50
N3	N19	N35	N51

This area is used to specify the character string that is displayed above a key when a key matrix is displayed on the Parts window.

Up to 6 characters can be input.

In the default condition, the set number "Nx" (x indicates a numeral) is displayed in each setting area.

(3) Hold Time (hold time setting area)

HoldTime msec

This area is used to specify the time for which the input value is to be held. The settable range is 0.001 to 999 ms. The default value is 0.5 ms.

If two or more keys that are input to input pins of the same name are clicked within the specified hold time, the key clicked last is valid.

(4) Set NO. (successive setting area)

Set NO.

This area is used to set pin and key names successively.

Select the default set number (**Ix,Ox,Nx**) from the pull-down menu, and input the corresponding pin name or key name to the text area on the right and press the return key. The input pin name or key name will be then reflected in the setting area below.

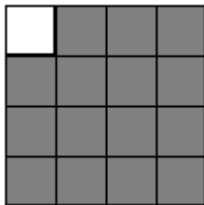
(5) Set position display area

This area indicates the position of the currently displayed key matrix in the 16-16 key matrix setting area by a white area.

To move the set position, use the following four buttons:

Up	Displays the set contents with the input setting pin shifted four positions up, without the output setting pin being affected.
----	--

Down	Displays the set contents with the input setting pin shifted four positions down, without the output setting pin being affected.
Right	Displays the set contents with the input setting pin shifted four positions to the right, without the output setting pin being affected.
Left	Displays the set contents with the input setting pin shifted four positions to the left, without the output setting pin being affected.

Setting

To operate two or more keys simultaneously

Click one of the keys to be input simultaneously with the right mouse button to set in the wait status (displayed in red). Next, click the other key with the left mouse button. This releases the first key from the wait status, enabling both the keys to be input at the same time. By setting two or more keys in the wait status, more than two keys can be input simultaneously. If the keys are input to the same input pin, however, the key input last is valid.

To lock input value of key

If a key is clicked with the left mouse button with the right button held down, the input value of that key at that time is locked (displayed in green). If a key that is input to the same input key as the locked key is clicked at this time, the input value of the key input last is valid. If the hold time of that key has elapsed, however, the input value while the key is locked is assumed again.

If the locked key is clicked with the left mouse button, the key is unlocked. If it is clicked with the right mouse button, the key is placed in the wait status (displayed in red).

Function buttons

OK	Checks for errors in the set connection information. If an error or warning has occurred, a message is displayed on the dialog box. If an error or warning has not occurred, control is transferred to the Parts window, and the set external component is displayed.
Open	Opens the Open dialog box. Connection information will be read from a previously saved file (.key).
Save	Opens the Save As dialog box. The displayed connection information will be saved to a file (.key).
Clear	Clears the set contents.
Cancel	Ignores the setting and closes this dialog box.
Help	Opens the Help window.

LEDs dialog box

This dialog box is used to set or change the connection information of the LED to be displayed in the Parts window.

The displayed LED lights or turns off, indicating the status of the output from the simulator.

The connection information can be saved to a file (.led). In addition, the saved file can be read.

Figure 7-83 LEDs Dialog Box

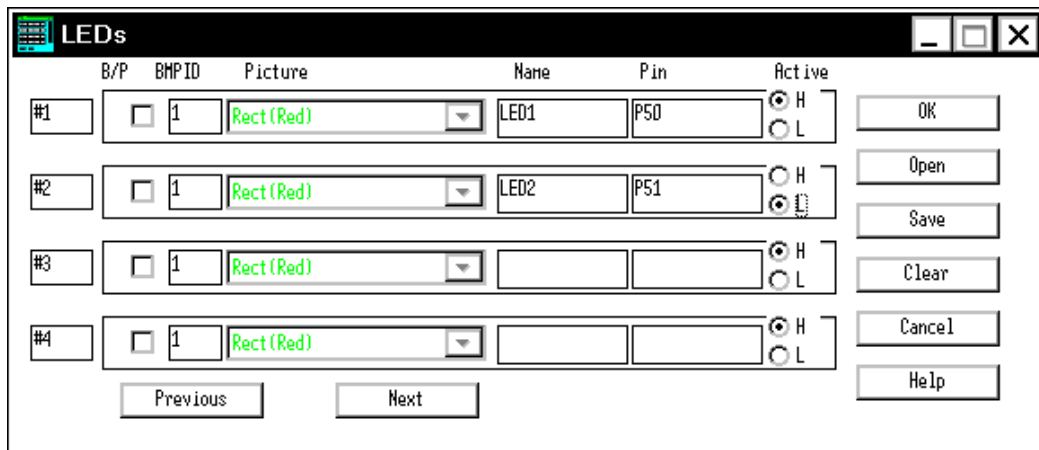

This section explains the following items:

- Opening
- Explanation of each area
- Setting
- Function buttons

Opening

This dialog box can be opened as follows:

- 1 In the V850 Simulator GUI window
Select [External Parts] -> [Panel Window...] from the menu bar
(or press Alt+E, and P in that order).
- 2 Click the  button in the Parts window.
or select [Parts] -> [LED...] from the menu bar
(or press Alt+P, and E in that order).

Explanation of each area

The LEDs dialog box consists of the following areas:

- (1) LED ID display area
- (2) Display format setting area
- (3) Connection information setting area

(1) LED ID display area

This area displays the ID number to be assigned to the LED to be set.

To set five or more LEDs, click the <Next> button and update the ID number.

Up to 32 ID numbers can be set.

(2) Display format setting area

This area is used to specify a display format in the Parts window. A figure or bitmap can be selected.

The default format is a bitmap in the shape of a light bulb.

B/P	If this check box is checked, the figure specified in the Picture field is displayed; if it is not checked, the bitmap specified in the BMP ID field is displayed.
BMP ID	If the B/P check box is not checked, specify the registration number of the bitmap to be displayed, in numerals. If no ID number exists or is specified, the default bitmap of registration number 1 (figure of bulb) is selected (for how to register a bitmap, refer to "Bitmap Entry dialog box").
Picture	If the B/P check box is checked, specify the figure to be displayed. A total of 6 patterns of rectangles or circles in red, green, or yellow, can be selected for the figure from the drop-down list.

(3) Connection information setting area

This area is used to specify the connection information of a pin.

Name	Specify the character string to be displayed. Up to 8 characters can be input.
-------------	---

Pin	Specify the name of an output pin to be connected. Up to eight characters can be input. * For the specifiable pin names, refer to the user's manual of the device used.
Active	Specify the active status of the set LED by using the option button. The default status is active-high (H).

Setting

LED display

The output status (active/inactive) of the connected pin is displayed real-time by two types of bitmaps.

Display example:



Active



InActive

If a figure such as a rectangle or circle is selected as the display format, the figure is displayed in the specified color if the output status is active. If the output status is inactive, only the frame of the figure is displayed.

Function buttons

Previous	Displays the setting four ID numbers before the ID number currently displayed, in each area.
Next	Displays the setting four ID numbers after the ID number currently displayed, in each area.
OK	Checks for errors in the set connection information. If an error or warning has occurred, a message is displayed on the dialog box. If an error or warning has not occurred, control is transferred to the Parts window, and the set external component is displayed.
Open	Opens the Open dialog box. Connection information will be read from a previously saved file (.led).
Save	Opens the Save As dialog box. The displayed connection information will be saved to a file (.led).
Clear	Clears the set contents.
Cancel	Ignores the setting and closes this dialog box.
Help	Opens the Help window.

7seg LEDs dialog box

This dialog box is used to set or change the connection information of the 7-segment LED pin to be displayed in the Parts window.

The displayed 7-segment LED displays the status of the output from the simulator.

The connection information can be saved to a file (.seg). In addition, the saved file can be read.

Figure 7-84 7seg LEDs Dialog Box

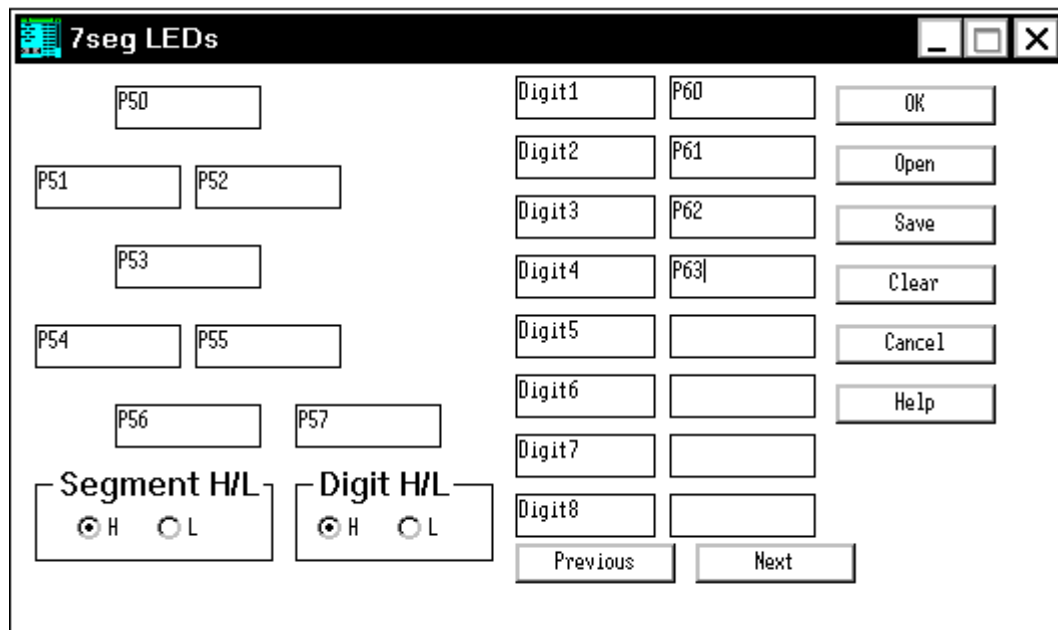

This section explains the following items:

- Opening
- Explanation of each area
- Setting
- Function buttons

Opening

This dialog box can be opened as follows:

- 1 In the V850 Simulator GUI window
Select [External Parts] -> [Panel Window...] from the menu bar
(or press Alt+E, and P in that order).

- 2 Click the  button in the Parts window.
or select [Parts] -> [7Seg LED...] from the menu bar
(or press Alt+P, and S in that order).

Explanation of each area

The 7seg LEDs dialog box consists of the following areas:

- (1) Segment signal setting area
- (2) Segment H/L (segment signal active status display area)
- (3) Digit signal setting area
- (4) Digit H/L (digit signal active status display area)

(1) Segment signal setting area

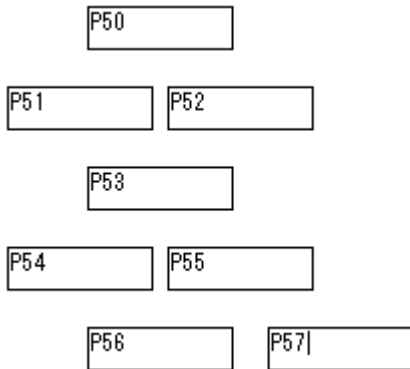

The diagram shows seven rectangular input fields arranged in a 7-segment pattern. The fields are labeled P50, P51, P52, P53, P54, P55, P56, and P57.

This area is used to specify the name of the pin to be connected to the segment signal of the 7-segment LED.

Up to eight characters can be input.

Caution For the specifiable pin names, refer to the user's manual of the device used.

(2) Segment H/L (segment signal active status display area)



The diagram shows a rectangular box with the title "Segment H/L" at the top. Below the title are two radio buttons: one labeled "H" (which is selected) and one labeled "L".

This area is used to specify the active status of the segment signal via the option button.

The default status is active-high (H).

(3) Digit signal setting area

Digit1	P60
Digit2	P61
Digit3	P62
Digit4	P63
Digit5	
Digit6	
Digit7	
Digit8	

This area is used to specify the name of a pin that is connected to the digit signal of the 7-segment LED.

Up to eight characters can be input.

To set nine digits or more, click the <Next> button and update the digit. Up to 16 digits can be set.

For the set signal, successively specify connection pins, starting from the lowest digit.

Caution For the specifiable pin names, refer to the user's manual of the device used.

(4) Digit H/L (digit signal active status display area)

Digit H/L	
<input checked="" type="radio"/> H	<input type="radio"/> L

This area is used to specify the active status of the digit signal via the option button.

The default status is active-high (H).

Setting**7-segment LED display**

The output information of the connected pin is received as the result of one simulation, and the 7-segment LED is displayed according to that value.

Until the value of the digit signal changes, the segment that lights remain lit, and the segment that turns off remains dark. When the value of the digit signal changes, the display is updated in accordance with the changes in the segment signal.

The segment that lights is indicated in red and the segment that remains dark is indicated in white (only a frame is displayed).

Display example:**Function buttons**

Previous	Displays the set contents eight digit signals before the digit signal currently displayed, in each area.
Next	Displays the set contents eight digit signals after the digit signal currently displayed, in each area.
OK	Checks for errors in the set connection information. If an error or warning has occurred, a message is displayed on the dialog box. If an error or warning has not occurred, control is transferred to the Parts window, and the set external component is displayed.
Open	Opens the Open dialog box. Connection information will be read from a previously saved file (.seg).
Save	Opens the Save As dialog box. The displayed connection information will be saved to a file (.seg).
Clear	Clears the set contents.
Cancel	Ignores the setting and closes this dialog box.
Help	Opens the Help window.

14seg LEDs dialog box

This dialog box is used to set or change the connection information of the 14-segment LED pin to be displayed in the Parts window.

The displayed 14-segment LED displays the status of the output from the simulator.

The connection information can be saved to a file (.s14). In addition, the saved file can be read.

Figure 7-85 14seg LEDs Dialog Box

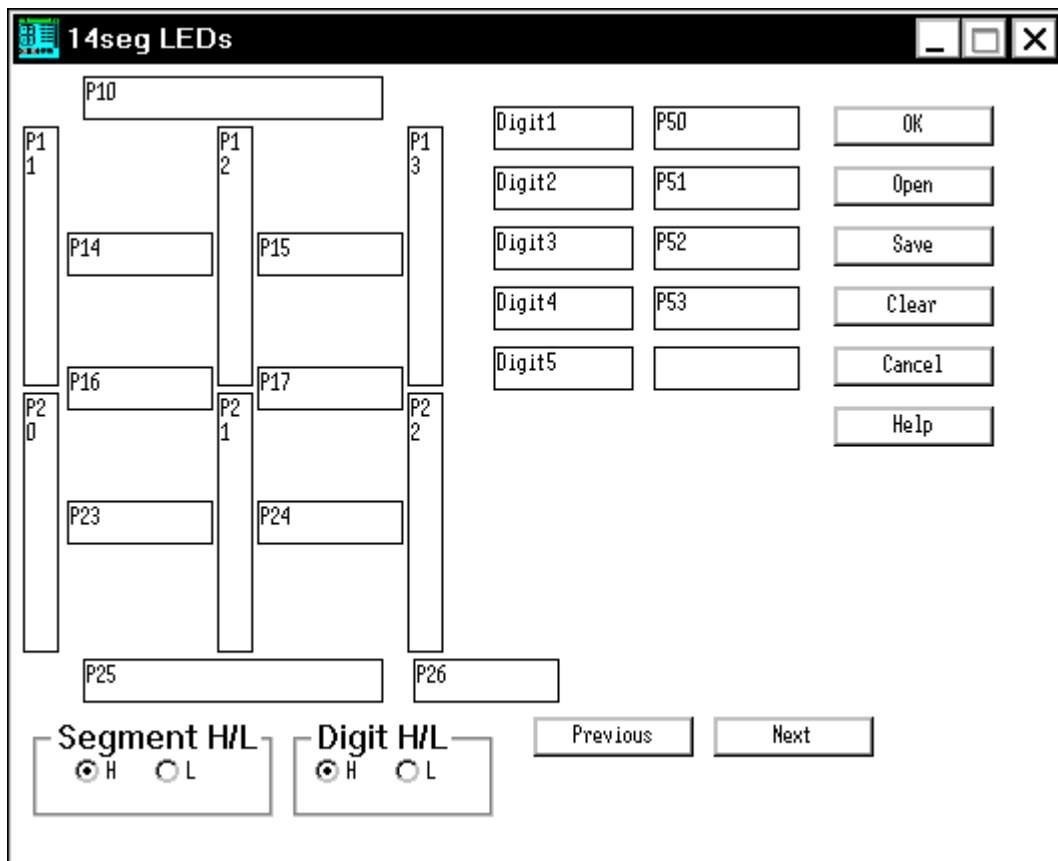

This section explains the following items:

- Opening
- Explanation of each area
- Setting
- Function buttons

Opening

This dialog box can be opened as follows:

- 1 In the V850 Simulator GUI window
Select [External Parts] -> [Panel Window...] from the menu bar
(or press Alt+E, and P in that order).
- 2 Click the  button in the Parts window.
or select [Parts] -> [14Seg LED...] from the menu bar
(or press Alt+P, and D in that order).

Explanation of each area

The 14seg LEDs dialog box consists of the following areas:

- (1) Segment signal setting area
- (2) Segment H/L (segment signal active status display area)
- (3) Digit signal setting area
- (4) Digit H/L (digit signal active status display area)

(1) Segment signal setting area

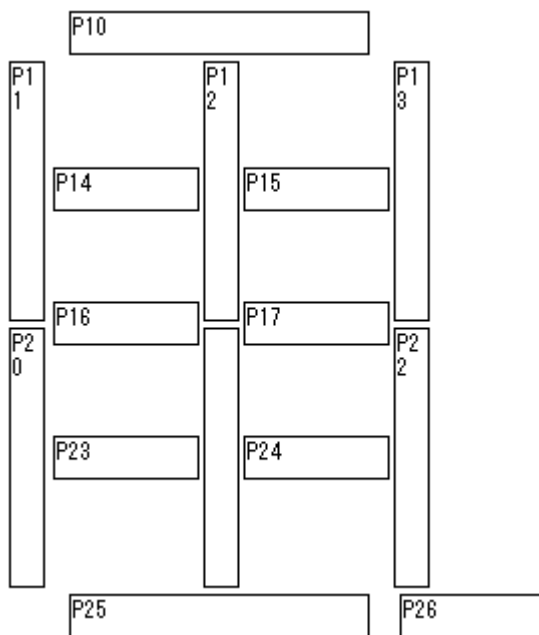

This area is used to specify the name of the pin to be connected to the segment signal of the 14-segment LED.

Up to eight characters can be input.

Caution For the specifiable pin names, refer to the user's manual of the device used.

(2) Segment H/L (segment signal active status display area)

This area is used to specify the active status of the segment signal via the option button.

The default status is active-high (H).

(3) Digit signal setting area

Digit1	P50
Digit2	P51
Digit3	P52
Digit4	P53
Digit5	

This area is used to specify the name of a pin that is connected to the digit signal of the 14-segment LED.

Up to eight characters can be input.

To set six digits or more, click the <Next> button and update the digit. Up to 10 digits can be set. For the set signal, successively specify connection pins, starting from the lowest digit.

Caution For the specifiable pin names, refer to the user's manual of the device used.

(4) Digit H/L (digit signal active status display area)

This area is used to specify the active status of the digit signal via the option button.

The default status is active-high (H).

Setting**14-segment LED display**

The output information of the connected pin is received as the result of one simulation, and the 14-segment LED is displayed according to that value.

Until the value of the digit signal changes, the segment that lights remain lit, and the segment that turns off remains dark. When the value of the digit signal changes, the display is updated in accordance with the changes in the segment signal.

The segment that lights is indicated in red and the segment that remains dark is indicated in white (only

a frame is displayed).

Display example:



Function buttons

Previous	Displays the set contents five digit signals before the digit signal currently displayed, in each area.
Next	Displays the set contents five digit signals after the digit signal currently displayed, in each area.
OK	Checks for errors in the set connection information. If an error or warning has occurred, a message is displayed on the dialog box. If an error or warning has not occurred, control is transferred to the Parts window, and the set external component is displayed.
Open	Opens the Open dialog box. Connection information will be read from a previously saved file (.s14).
Save	Opens the Save As dialog box. The displayed connection information will be saved to a file (.s14).
Clear	Clears the set contents.
Cancel	Ignores the setting and closes this dialog box.
Help	Opens the Help window.

Level Gauges dialog box

This dialog box is used to set or change the connection information of the level gauge to be displayed in the Parts window.

Data can be input to the simulator from the displayed level gauge (scroll bar or dial). However, only analog input pins can be connected to the level gauge.

The connection information can be saved to a file (.lev). In addition, the saved file can be read.

Caution The Level Gauges dialog box can be selected only for a device with an internal A/D converter. For the specifiable pin names, refer to the user's manual of the device used.

Figure 7-86 Level Gauges Dialog Box

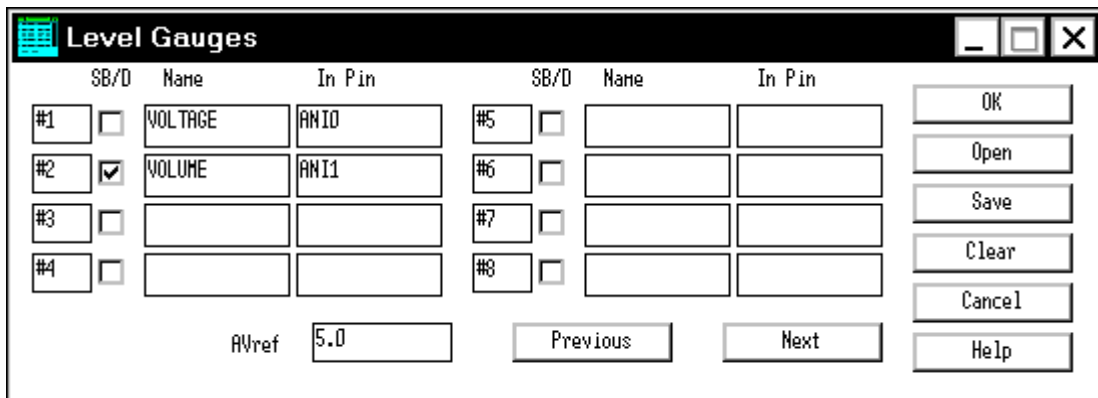

This section explains the following items:

- Opening
- Explanation of each area
- Setting
- Function buttons

Opening

This dialog box can be opened as follows:

- 1 In the V850 Simulator GUI window
Select [External Parts] -> [Panel Window...] from the menu bar
(or press Alt+E, and P in that order).
- 2 Click the  button in Parts window.
or select [Parts] -> [Level Gauge...] from the menu bar
(or press Alt+P, and L in that order).

Explanation of each area

The Level Gauges dialog box consists of the following areas:

- (1) Level gauge ID display area
- (2) Connection information setting area
- (3) AVref (reference voltage value setting area)

(1) Level gauge ID display area

This area displays the ID number to be assigned to the level gauge to be set. To set nine or more level gauges, click the <Next> button and update the ID number. Up to 16 ID numbers can be set.

(2) Connection information setting area

SB/D	Name	In Pin
<input type="checkbox"/>	VOLTAGE	AIN0

This area is used to set or display information on the connection between a level gauge and a pin.

This check box specifies the type of the level gauge to be displayed.

SB/D	This check box specifies the type of the level gauge to be displayed. If this box is checked, the level gauge is displayed as a dial; if it is not checked, the level gauge is displayed as a scroll bar.
Name	Specify the character string to be displayed on the side of the level gauge. Up to eight characters can be input.
In Pin	This area is used to specify the name of the analog input pin to be connected to the level gauge. Up to eight characters can be input. * For the specifiable pin names, refer to the user's manual of the device used.

(3) AVref (reference voltage value setting area)

AVref

This area is used to set the reference voltage value of the A/D converter.

The reference voltage can be set within the range of the operating supply voltage to the first decimal place (the default value is 0.5 V).

This reference voltage determines the operation range of the scroll bar or dial displayed in the Parts window.

Setting

Inputting from level gauge

By operating the displayed scroll bar or dial, an analog signal can be input from the level gauge. The

maximum value of the analog signal that can be input is the value specified in the [AVref](#) area.

Two types of level gauges are available: a scroll bar and a dial.

Display example:



<Inputting via scroll bar>

By moving the scroll thumb, the analog value, which is displayed in black, can be changed.

When the analog value has reached the value to be input, click the right button of the mouse on the scroll bar. In this way, the displayed analog value can be input. At this time, the value is displayed in red.

The scroll thumb can be moved by dragging or clicking the left mouse button at any position.

<Inputting via dial>

By moving the <red> mark (operating point) on the dial, the analog value, which is displayed in black, can be changed.

When the analog value has reached the value to be input, click the right button of the mouse on the dial.

In this way, the displayed analog value can be input. At this time, the value is displayed in red.

The operating point can be moved by dragging or clicking the left mouse button at any position.

Function buttons

Previous	Displays the setting eight ID numbers before the ID number currently displayed, in each area.
Next	Displays the setting eight ID numbers after the ID number currently displayed, in each area.
OK	Checks for errors in the set connection information. If an error or warning has occurred, a message is displayed on the dialog box. If an error or warning has not occurred, control is transferred to the Parts window, and the set external component is displayed.
Open	Opens the Open dialog box. Connection information will be read from a previously saved file (.lev).
Save	Opens the Save As dialog box. The displayed connection information will be saved to a file (.lev).
Clear	Clears the set contents.
Cancel	Ignores the setting and closes this dialog box.
Help	Opens the Help window.

DC Motors dialog box

This dialog box is used to set or change the connection information of the DC motor to be displayed in the Parts window.

The displayed DC motor displays the output status of the connected pin as a bitmap or as the number of revolutions.

The connection information can be saved to a file (.mtr). In addition, the saved file can be read.

Figure 7-87 DC Motors Dialog Box

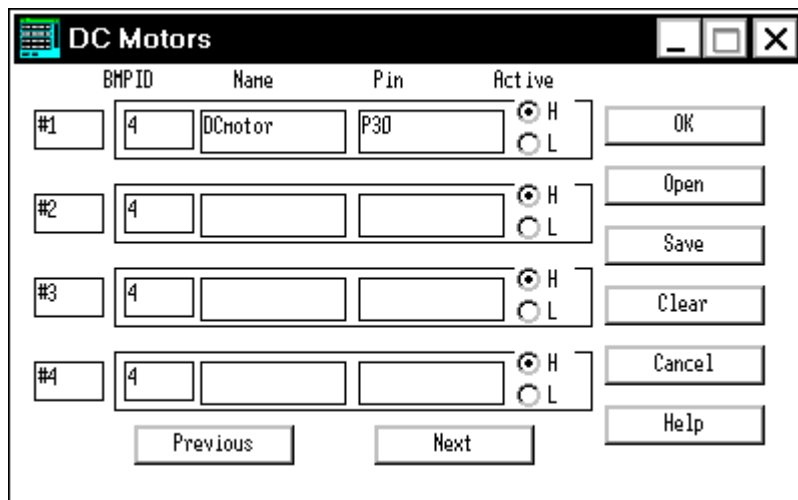

This section explains the following items:

- Opening
- Explanation of each area
- Setting
- Function buttons

Opening

This dialog box can be opened as follows:

- 1 In the V850 Simulator GUI window
Select [External Parts] -> [Panel Window...] from the menu bar
(or press Alt+E, and P in that order).
- 2 Click the  button in the Parts window.
or select [Parts] -> [DC Motor...] from the menu bar
(or press Alt+P, and M in that order).

Explanation of each area

The DC Motors dialog box consists of the following areas:

- (1) DC motor ID display area
- (2) Connection information setting area

(1) DC motor ID display area

This area displays the ID number to be assigned to the DC motor to be set. To set five or more DC motors, click the <Next> button and update the ID number.

Up to 32 ID numbers can be set.

(2) Connection information setting area

BMP ID	Name	Pin	Active
<input type="text" value="4"/>	<input type="text" value="DCmotor"/>	<input type="text" value="P30"/>	<input checked="" type="radio"/> H <input type="radio"/> L

This area is used to set or display information on the connection between a DC motor and pins.

BMP ID	Specify the registration number of the bitmap when the button is displayed on the Parts window, in numerals. If an ID number does not exist or if no ID number is specified, a bitmap with registration number 4 is selected as default(refer to "Bitmap Entry dialog box").
Name	Specify the character string to be displayed. Up to eight characters can be input.
Pin	Specify the name of the port pin or multiplexed pin to be connected to the DC motor. Up to eight characters can be input. * For the specifiable pin names, refer to the user's manual of the device used.
Active	Specify the active status of the set DC motor via the option button. The default status is active-high (H).

Setting

DC motor display

The value of the output pin connected to the DC motor is displayed on a bitmap, in accordance with its active status (active-high or active-low). The output value is displayed in brown if the DC motor is active, and displayed in gray if the motor is inactive.

In addition, the total number of clocks during which the motor remains active from the beginning of simulation is also displayed.

The total number of clocks is counted up to 10 digits. After the 10th digit, the count value is returned to 0.

Display example:**Function buttons**

Previous	Displays the setting four ID numbers before the ID number currently displayed, in each area.
Next	Displays the setting four ID numbers after the ID number currently displayed, in each area.
OK	Checks for errors in the set connection information. If an error or warning has occurred, a message is displayed on the dialog box. If an error or warning has not occurred, control is transferred to the Parts window, and the set external component is displayed.
Open	Opens the Open dialog box. Connection information will be read from a previously saved file (.mtr).
Save	Opens the Save As dialog box. The displayed connection information will be saved to a file (.mtr).
Clear	Clears the set contents.
Cancel	Ignores the setting and closes this dialog box.
Help	Opens the Help window.

Buzzers dialog box

This dialog box is used to set or change the connection information of the buzzer to be displayed in the Parts window.

The output status is indicated by a bitmap or buzzer sound.

The connection information can be saved to a file (.buz). In addition, the saved file can be read.

Figure 7-88 Buzzers Dialog Box

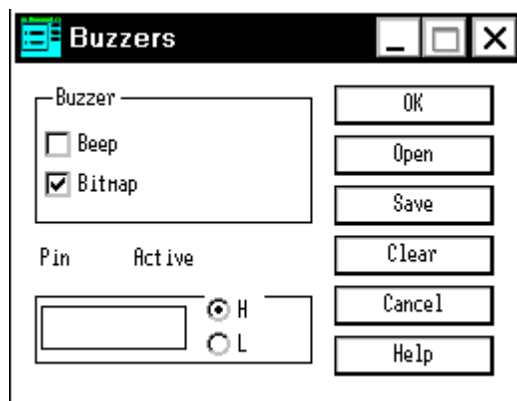

This section explains the following items:

- Opening
- Explanation of each area
- Setting
- Function buttons

Opening

This dialog box can be opened as follows:

- 1 In V850 Simulator GUI window
Select [External Parts] -> [Panel Window...] from the menu bar
(or press Alt+E, and P in that order).
- 2 Click the  button in Parts window.
or select [Parts] -> [Buzzer...] from the menu bar
(or press Alt+P, and Z in that order).

Explanation of each area

The Buzzers dialog box consists of the following areas:

- (1) Buzzer (buzzer output format setting area)
- (2) Pin, Active (buzzer connection pin setting area)

(1) Buzzer (buzzer output format setting area)

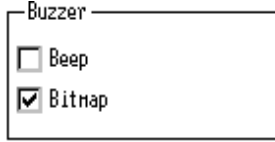

This area is used to specify the output format of the buzzer via a check box. Both Sound Output and Bitmap display can be specified.

Beep	If this check box is checked, the output from a pin is indicated by a sound. * To use this function, a sound board and a speaker are necessary.
Bitmap	If this check box is checked, the output from a pin is displayed as a bitmap.

(2) Pin, Active (buzzer connection pin setting area)

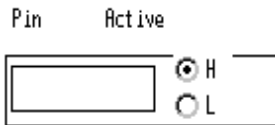

This area is used to set information on the pin to be connected to the buzzer.

Pin	Input the name of the pin to be connected to the buzzer from the keyboard. Up to eight characters can be input. * For the specifiable pin names, refer to the user's manual of the device used.
Active	Select the active status of the set buzzer via the option button. The default status is active-high (H).

Setting

Buzzer display

The active-level output of the pin connected to the buzzer is indicated by a bitmap and/or buzzer sound.

The output value (active/inactive) of the pin is displayed on the bitmap, as follows:

Display example:



The buzzer sound is issued if the connected pin outputs the value of the active level (when the level of the pin changes from the inactive level to the active level).

Function buttons

OK	Validates the setting and transfers control to the Parts window. When a bitmap display is specified, the output status is displayed on a bitmap.
Open	Opens the Open dialog box. Connection information will be read from a previously saved file (.buz).
Save	Opens the Save As dialog box. The displayed connection information will be saved to a file (.buz).
Clear	Clears the set contents.
Cancel	Ignores the setting and closes this dialog box.
Help	Opens the Help window.

Internal Interrupt Button dialog box

This dialog box is used to set or change the connection information of the internal interrupt button to be displayed in the Parts window.

An interrupt can be issued to the simulator from the displayed button.

The connection information can be saved to a file (.itr). In addition, the saved file can be read.

Figure 7-89 Internal Interrupt Button Dialog Box

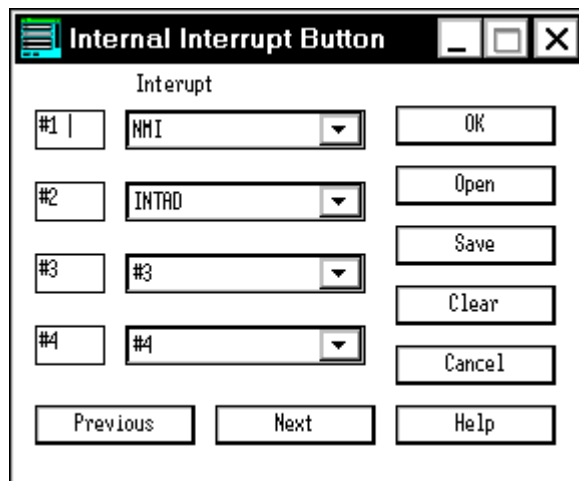

This section explains the following items:

- Opening
- Explanation of each area
- Setting
- Function buttons

Opening

This dialog box can be opened as follows:

- 1 In the V850 Simulator GUI window
Select [External Parts] -> [Panel Window...] from the menu bar
(or press Alt+E, and P in that order).
- 2 Click the  button in the Parts window.
or select [Parts] -> [Internal Interrupt...] from the menu bar
(or press Alt+P, and I in that order).

Explanation of each area

The Internal Interrupt Button dialog box consists of the following areas:

- (1) Internal interrupt button ID display area
- (2) Interrupt (internal interrupt name setting area)

(1) Internal interrupt button ID display area



This area displays the ID number to be assigned to the button to be set.

To set five or more buttons, click the <Next> button and update the ID number.

Up to 20 ID numbers can be set.

(2) Interrupt (internal interrupt name setting area)

Interrupt



Select the name of the internal interrupt to be connected from the drop-down list in this area.

Caution For the specifiable interrupt names, refer to the user's manual of the device used.

Setting

Input operation of internal interrupt button

By clicking the displayed button, an internal interrupt can be generated.

Display example:



By clicking the displayed button, an internal interrupt can be generated.that this button does not have a function to set the input timing.

Caution For the timing at which interrupts can be acknowledged, refer to the user's manual of the device used.

Function buttons

Previous	Displays the setting four ID numbers before the ID number currently displayed, in each area.
----------	--

Next	Displays the setting four ID numbers after the ID number currently displayed, in each area.
OK	Checks for errors in the set connection information. If an error or warning has occurred, a message is displayed on the dialog box. If an error or warning has not occurred, control is transferred to the Parts window, and the set external component is displayed.
Open	Opens the Open dialog box. Connection information will be read from a previously saved file (.itr).
Save	Opens the Save As dialog box. The displayed connection information will be saved to a file (.itr).
Clear	Clears the set contents.
Cancel	Ignores the setting and closes this dialog box.
Help	Opens the Help window.

Pull-Up / Pull-Down dialog box

This dialog box is used to set information on the pin to be connected to a pull-up/down resistor.

If a pull-up/down resistor is connected to a pin that sets the button or key matrix of an external component, set a pull-up/down resistor in this dialog box before setting the pin to be connected in each connection dialog box. The connection information can be saved to a file (.pud). In addition, the saved file can be read.

Figure 7-90 Pull-Up / Pull-Down Dialog Box

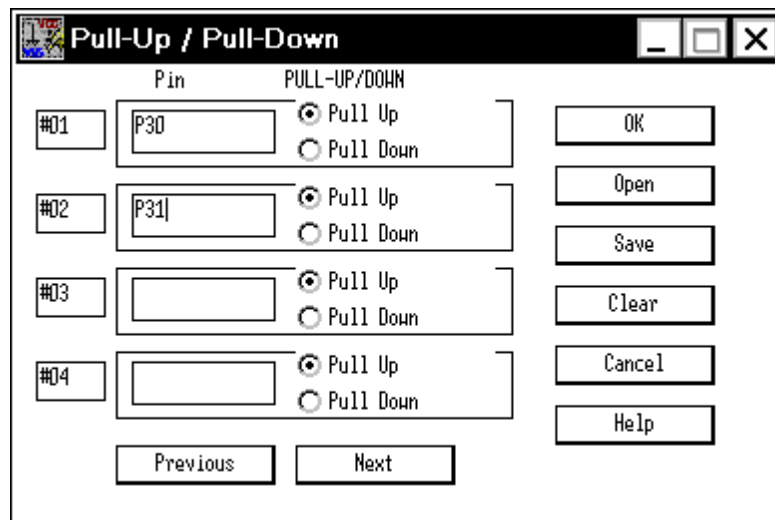

This section explains the following items:

- Opening
- Explanation of each area
- Function buttons

Opening

This dialog box can be opened as follows:

- 1 In the V850 Simulator GUI window
Select [External Parts] -> [Panel Window...] from the menu bar
(or press Alt+E, and P in that order).
- 2 Click the  button in the Parts window.
or select [Parts] -> [Pull Up/Pull Down...] from the menu bar
(or press Alt+P, and W in that order).

Explanation of each area

The Pull-Up/Pull-Down dialog box consists of the following areas:

- (1) Pull-up/down ID display area
- (2) Connection information setting area

(1) Pull-up/down ID display area



This area displays the ID number to be assigned to the pin to which a pull-up/down resistor is to be connected.

To set five or more pins, click the <Next> button and update the ID number.

Up to 40 ID numbers can be set.

(2) Connection information setting area

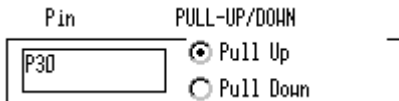

This area is used to set or display information on the connection between a pull-up/down resistor and a pin.

Pin	Specify the name of the pin to be connected to a pull-up/down resistor. Up to eight characters can be input. * For the specifiable pin names, refer to the user's manual of the device used.
PULL-UP/DOWN	Select whether the initial status of the pin is to have a pull-up resistor connected (default) or a pull-down resistor connected via the option button.

Function buttons

Previous	Displays the setting four ID numbers before the ID number currently displayed, in each area.
Next	Displays the setting four ID numbers after the ID number currently displayed, in each area.
OK	Checks for errors in the set connection information. If an error or warning has occurred, a message is displayed on the dialog box. If an error or warning has not occurred, control is transferred to the Parts window, and the set external component is displayed.
Open	Opens the Open dialog box. Connection information will be read from a previously saved file (.pud).
Save	Opens the Save As dialog box. The displayed connection information will be saved to a file (.pud).
Clear	Clears the set contents.

Cancel	Ignores the setting and closes this dialog box.
Help	Opens the Help window.

Serial GUI window

The operation mode and I/O information of the serial interface can be displayed.

The Serial GUI window displays the operation mode and I/O information of each channel of the serial interface selected from the submenu. Serial GUI windows of different channels can be simultaneously opened.

Figure 7-91 Serial GUI Window

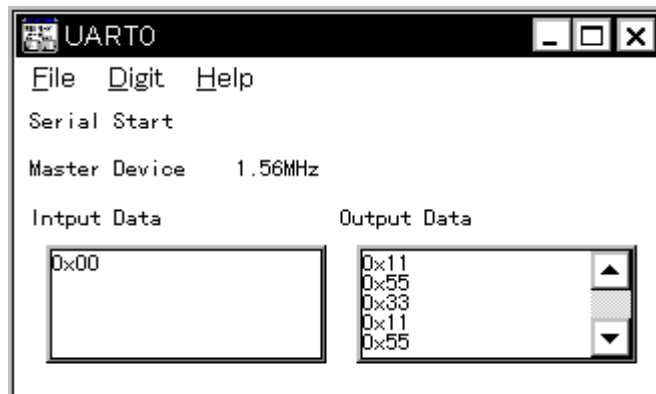

This section explains the following items:

- Opening
- Explanation of each area
- Menu bar

Opening

This dialog box can be opened as follows:

- 1 In the V850 Simulator GUI window
Select [External Parts] -> [Panel Window...] from the menu bar
(or press Alt+E, and P in that order).
- 2 In the Parts window
Select [Parts] -> [Serial GUI...] -> [Submenu (differs depending on the device)] from the menu bar.

Explanation of each area

The Serial GUI window consists of the following areas:

- (1) Operation information display area
- (2) Input Data, Output Data (I/O information display area)

(1) Operation information display area

```
Serial Start
Master Device 1.56MHz
```

The first line of this area displays the operation mode of the serial interface. Depending on the operation of the serial interface, "Serial Start" or "Operation Stop Mode" is displayed.

The second line indicates whether the serial interface operates as the master or a slave. When the interface operates as the master, the number of operating clocks is also displayed.

(2) Input Data, Output Data (I/O information display area)

```
Input Data      Output Data
0x00           0x11
               0x55
               0x33
               0x11
               0x55
```

This area displays the data input to (received by) or output (transmitted) from the serial interface. The data is displayed when all the bits of data have been completely received or transmitted.

The number of data that can be displayed is five in the default condition, but it can be increased to up to 20 by changing the size of the window.

It can be also specified, by using the [Digit] menu, whether the data is displayed as hexadecimal or binary numbers.

Note The scroll bar can also be used to specify the number of data. However, use the scroll bar only when simulation is stopped.

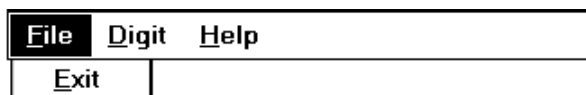
Menu bar**(1) [File] menu**

Exit	Closes this window.
------	---------------------

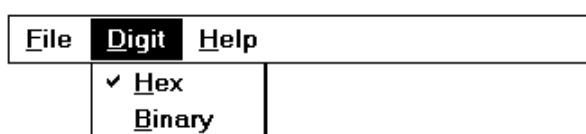
(2) [Digit] menu

Hex	Displays the data in the I/O information display area as hexadecimal numbers (default).
Binary	Displays the data in the I/O information display area as binary numbers.

(3) **[Help] menu**

File	Digit	Help
		SM850 <u>H</u>elp
		This <u>W</u>indow

SM850 <u>H</u>elp	Opens the Help window of SM850.
This <u>W</u>indow	Opens the Help window.

Bitmap Entry dialog box

This dialog box is used to register the bitmap file of the external component to be displayed in the Parts window.

In this dialog box, a bitmap file newly created by the user can be registered or an unnecessary bitmap file can be deleted.

A registration number is assigned to a newly registered bitmap file. This bitmap file can be used to display the bitmap of an external component for which the bitmap display can be changed.

Up to 384 bitmap files can be registered.

The connection information can be saved to a file (.bit).

Figure 7-92 Bitmap Entry Dialog Box

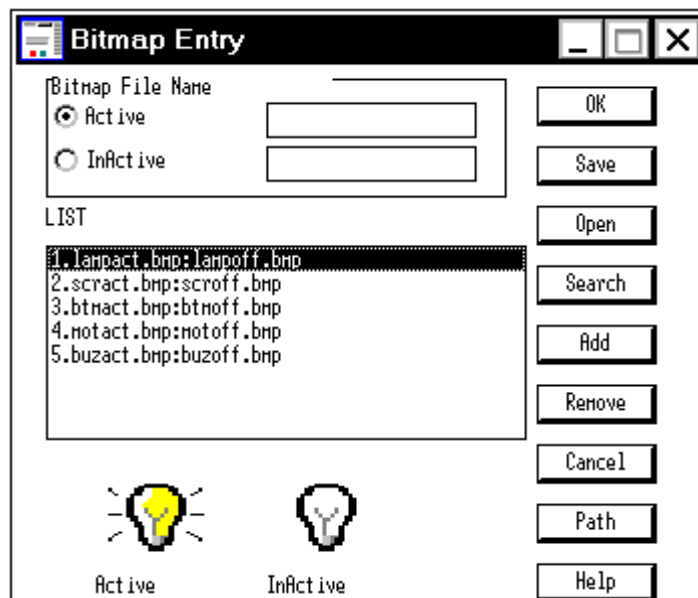

This section explains the following items:

- Opening
- Explanation of each area
- Setting
- Function buttons

Opening

This dialog box can be opened as follows:

- 1 In the V850 Simulator GUI window
Select [External Parts] -> [Panel Window...] from the menu bar
(or press Alt+E, and P in that order).
- 2 In the Parts window Select [Bitmap] -> [Bitmap Entry] from the menu bar
(or press Alt+B, and N in that order).

Explanation of each area

The Bitmap Entry dialog box consists of the following areas:

- (1) Bitmap File Name (bitmap file name specification area)
- (2) LIST (registered bitmap file display area)

(1) Bitmap File Name (bitmap file name specification area)

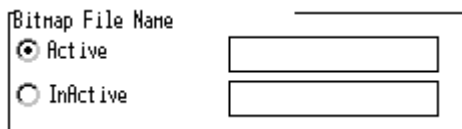

This area specifies the bitmap file names to be registered and whether each bitmap file is active or inactive.

Select in which status, active or inactive, a bitmap file is to be registered, via the option button. Search and specify a file name using the <Search> button, or directly input a file name.

Note that a path is ignored even if the file name is specified with a full path.

(2) LIST (registered bitmap file display area)



This area displays the bitmap file names already registered in the following format:





1. lampact.bmp : lampoff.bmp
- (1) (2) (3)
- (1) Registration number
(2) Active status file name
(3) Inactive status file name

In the default condition, five bitmap files (with registration numbers 1 to 5) are registered.

If this area is selected by the mouse, a sample is displayed at the lower part of the dialog box as

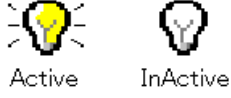
follows:

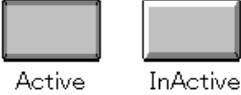
Table 7-39 Relationship between Registration Number and Bitmap File

Registration No.	Active status	Inactive Status
1	lampact.bmp	lampoff.bmp
		
2	scract.bmp	scroff.bmp
		
3	btmact.bmp	btmoff.bmp
		
4	motact.bmp	motoff.bmp
		
5	buzact.bmp	buzoff.bmp
		

Setting

Registering bitmap file

To register a bitmap file, follow these steps:

- 1 Click the <Path> button. A dialog box will open. In this dialog box, specify the path to the directory where the bitmap file to be registered exists. Up to 128 characters can be input.
If a path is not specified, it is assumed that the file exists in the directory where the bitmap file of the simulator exists.



To set the path, click the <OK> button^{Note1}. Only one path can be set^{Note2}.

Note1 To cancel the path that has been set, click the <Cancel> button.

Note2 If a new path is set after a path has already been set, the path set first becomes invalid. If the <OK> button is clicked with nothing specified, however, the path already set becomes valid as is.

- 2 Click the active option button. Search a file name to be specified as an active bitmap using the <Search> button, or directly input a file name from the keyboard. In the same manner, register an inactive bitmap file. If a file is not registered, nothing is displayed in the inactive status^{Note}.

Note A bitmap file in only the inactive state cannot be registered.

- 3 Click the <Add> button. A registration number will be assigned to the specified bitmap file, and the bitmap file will be displayed as a sample. If no bitmap file exists when registration information is read from a project file (.prj) or by using the <Open> button, an error bitmap prepared by the system is displayed.

Figure 7-93 Error Bitmap File



Deleting registered bitmap file

To delete a registered bitmap file, follow these steps:

- 1 Select the registration number to be deleted from the registration list by clicking the mouse.
- 2 Click the <Remove> button.

The deleted bitmap registration number will be missing. Registration numbers 1 to 5 cannot be deleted.

Function buttons

OK	Validates the registration or deletion and transfers control to the Parts window.
Save	Opens the Save As dialog box. The displayed registration information will be saved to a file (.bit).
Open	Opens the Open dialog box. Registration information will be read from a specified file (.bit).
Search	Opens the Browse dialog box. Search and specify the bitmap file name to be registered.
Add	Registers the specified bitmap file and displays it as a sample.
Remove	Deletes the specified bitmap file from the registration list. The bitmap number of the deleted file will be missing. The default registration files cannot be deleted.
Cancel	Ignores the setting and closes this dialog box.
Path	Sets a path to the directory where the bitmap file to be registered exists.
Help	Opens the Help window.

Open dialog box

This dialog box is used to specify or select a file to be manipulated. This dialog box uses the standard dialog box of Windows.

In this dialog box, the specified file is searched from the drive or directory where the specified file exists, by the file type, and the file is opened.

Figure 7-94 Open Dialog Box

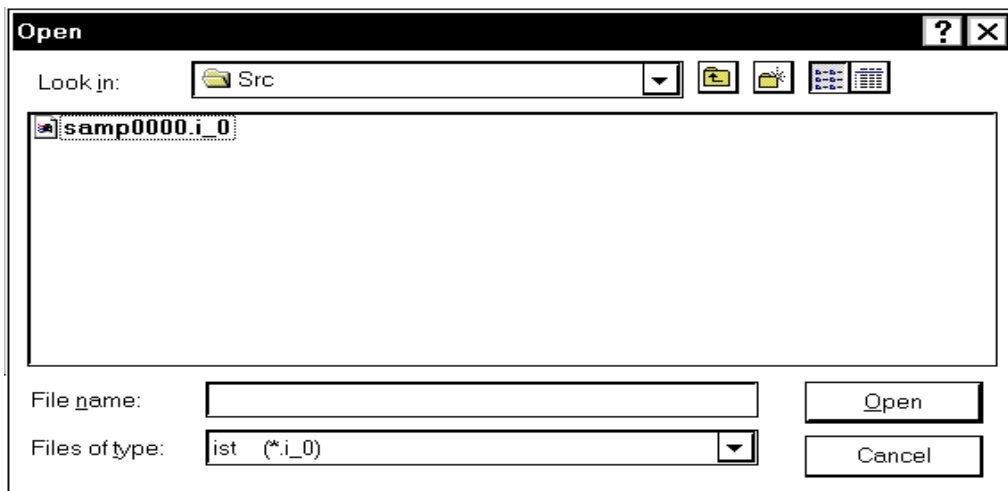

This section explains the following items:

- Explanation of each area
- Function buttons

Explanation of each area

The Open dialog box consists of the following areas:

- (1) Area to select Look in:
- (2) Area to specify File name: and Files of type:

(1) Area to select **Look in:**

Select the drive or directory where the specified file exists from the drop-down list.

The file at the specified location is displayed in the field at the lower part of the area.

(2) Area to specify File name: and Files of type:

File name	Input the name of the file to be specified from the keyboard. A file name can also be selected from the above field or by specifying a wildcard.
Files of type	Select the type of the specified file from the drop-down list. When the file type has been selected, the specified file is displayed in the field above the file name specification area.

Function buttons

Open	Opens the specified file.
Cancel	Ignores the setting and closes the dialog box.

Save As dialog box

This dialog box is used to specify or select a file to be saved. This dialog box uses the standard dialog box of Windows.

On this dialog box, a file can be named and saved to a specified directory.

Figure 7-95 Save As Dialog Box

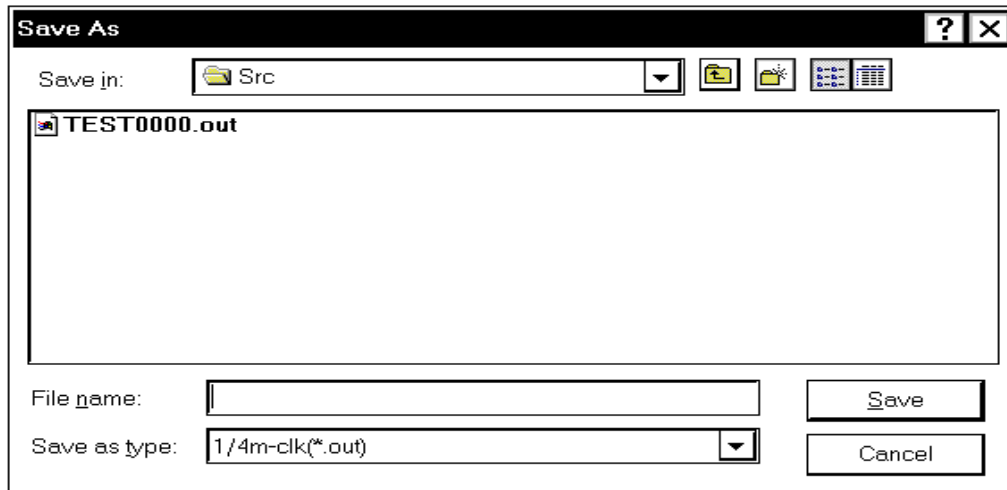

This section explains the following items:

- Explanation of each area
- Function buttons

Explanation of each area

This section explains the following items:

- (1) Area to select Save in:
- (2) Area to specify File name: and Save as type:

(1) Area to select **Save in:**

Select the drive or directory to which the file is to be saved from the drop-down list. The file at the specified location is displayed in the field at the lower part of the area.

(2) Area to specify File name: and Save as type:

File name	<p>Input the name of the file to be specified from the keyboard. In the default condition, an extension suitable for the window from which this dialog box was opened is displayed. To overwrite an existing file, select the file from the field above this area, or search the file using a wildcard. When .evn or .i_x is specified, be sure to specify four characters followed by 0000.i_x as the file name (e.g., abcd0000.i_0 or efgi0000.evn).</p>
Save as type	<p>Select the type of the file to be saved from the drop-down list. If this dialog box has been opened from the Input 0/1 Editor window or Input timing Chart Editor window, specify a wait unit in this field.</p>

Function buttons

Save	Saves the file contents under the specified file name at the specified location.
Cancel	Ignores the setting and closes the dialog box.

Speed Option dialog box

This dialog box is used to select Simulation Function to meet the purpose of the user, so that the simulator runs at high speed.

Figure 7-96 Speed Option Dialog Box

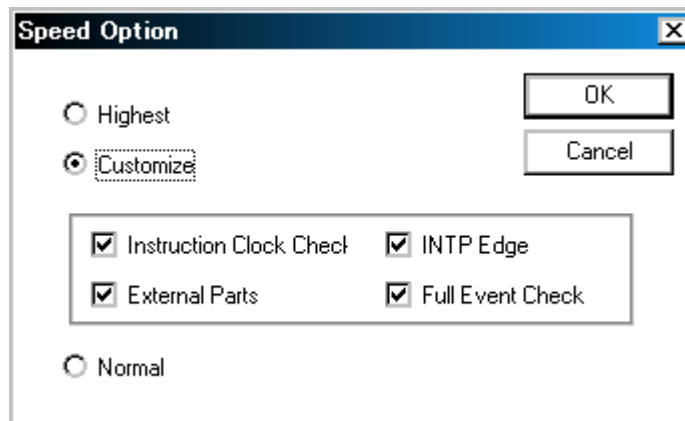

This section explains the following items:

- Opening
- Explanation of each area
- Function buttons

Opening

This dialog box can be opened as follows:

- In the V850 Simulator GUI window
Select [Option] -> [Speed Option...] from the menu bar
(or press Alt+O, and H in that order).

Explanation of each area

The Speed Option dialog box consists of the following areas:

- (1) Speed option select area

(1) Speed option select area

This area is used to select the speed option setting.

- **Highest**
Invalidates all the Simulation Function.
- **Customize**
Specifies each Simulation Function individually.

Table 7-40 Simulation Function

Instruction Clock Check	If this check box is checked, the instruction clock is measured correctly. If it is not checked, the measurement is executed with one command as one clock.
External Parts	If this check box is checked, the external parts function is validated. If it is not checked, only the user open interface function is valid. .
INTP Edge	If this check box is checked, the INTP edge is detected. If it is not checked, the INTP edge is not detected.
Full Event Check	If this check box is checked, all event checks are performed. If it is not checked, only one break event check is performed. Switching between trace valid/invalid or timer event valid/invalid is also performed by this option.

- **Normal** (default)
Validates all the Simulation Functions (speed simulation is not executed).

Function buttons

OK	Sets the speed option and closes this dialog box.
Cancel	Ignores the setting and closes this dialog box.

CHAPTER 8 COMMAND REFERENCE

This section explains the command functions of the SM850 in detail.

8.1 Command Line Rules

The specification of command lines has the following rules:

- Command name, option, and argument are specified for command line.
- To divide words, a space (space key or tab key) is used.
- At the end of a line, a line feed character or a semicolon is used.
- When a command name and an option are entered to the point of identifiability, they are recognized.
- In script, command names have to be entered completely.

Command format

command -options arg1 arg2 arg3 ...

8.2 Command List

The list of SM850 commands is shown in Table 8-1 and Table 8-2 .

Table 8-1 List of Debugger Control Commands

Command Name	Function
address	Evaluation of address expression Converts the address expression specified with expression into address.
assemble	Disassemble/line assemble (a) Assembles the character strings specified with code from the address specified with address.
batch	Executing batch (with echo) Executes in batch displaying files specified with scriptname on the screen.
breakpoint	Setting/deletion of breakpoint (b) Operates breakpoint specified with options and address.
cache	Setting of cache Sets I cache and D cache.
dbgexit	Terminating debugger Terminates the debugger.
download	Download of files (l) Downloads files specified with filename according to options.
extwin	Creation of expansion window Creates expansion window with scriptfile.
finish	Returning from function Executes until it returns to the program that called the current function.
go	Continuous execution (g) Executes program continuously.

Table 8-1 List of Debugger Control Commands

Command Name	Function
help	Display of help Displays help of Dcl.
hook	Setting of hook Sets the procedure for hook with scriptfile.
ie	Display/setting of IE register This command depends on the IE.
jump	Jump to window (j) Displays the window specified with options.
map	Setting/deletion of memory mapping Sets, deletes, and displays memory mapping.
mdi	Setting of expansion window Sets the size and title name of the expansion window.
memory	Display/setting of memory (m) Sets value in the memory of the address specified with address according to options.
module	Display of the list of files and functions Displays the list of files and functions of the load module specified with progname.
next	Procedure step (n) Executes the procedure steps.
refresh	Redrawing of window Redraws the window and updates the data.
register	Display/setting of register value and I/O register value Sets value in the register specified with regname.
reset	Reset Resets CPU, debugger or symbols.
run	Reset and execution of CPU (r) Resets program and executes it.
step	Step execution (s) Executes step execution.
stop	Stop execution Stops the program forcibly.
upload	Upload Saves the memory data or coverage data within the specified range in a file.
version	Display of the version information Displays the version information of the debugger.
watch	Display/setting of variables (w) Displays and sets the variables.
where	Trace of stack Executes the back-trace of the stack.
wish	Start of Tclet Starts the script using Tk (Tclet).
xcoverage	Operation of coverage Operates coverage.

Table 8-1 List of Debugger Control Commands

Command Name	Function
xtime	Operation of timer Operates timer.
xtrace	Operation of tracer Operates tracer.

Table 8-2 List of Console/Tcl Commands

Command Name	Function
alias	Creation of another name
cd	Change of directory
clear	Clears the screen
echo	Echo
exit	Close/end
history	Display of history
ls	Display of files
pwd	Check of the directory
source	Execution of batch
time	Measurement of time for commands
tkcon	Console control
unalias	Deletion of another name
which	Display of the command path or another name
Other commands	Based on Tcl/Tk 8.1

8.3 List of Variables

- dcl(chip) - Chip name read only
- dcl(prjfile) - Project file name read only
- dcl(srcpath) - Source path read only
- dcl(ieid) - IE type read only
- dcl(iestat) - IE status read only
- dcl(bkstat) - Break status read only
- env(LANG) - Language
- dcl_version - Dcl version read only

8.4 List of Packages

- tcltest - Restoration test
- cwind - Automatic window control
- BWidget - Toolkit

8.5 Key Bind

- tcsh + emacs like
- Complement of command name [Tab]
- Complement of file name [Tab]
- HTML help [F1]

8.6 Expansion window

The expansion windows can be created using Tk.

In the expansion windows, Widget is allocated with '.dcl' as a root instead of '.'.

When the following script files are allocated in bin/itcl/tools/, an expansion window is added on selecting [Browse] -> [Others] from the menu bar.

The mdi command, an exclusive command for expansion windows, has been added.

```
# Sample.tcl
wm protocol .dcl WM_DELETE_WINDOW { exit }
mdi geometry 100 50
button .dcl.b -text Push -command exit
pack .dcl.b
```

In expansion windows, Tk menu commands cannot be used because of the restrictions of MDI windows.

8.7 Callback Procedure

Expansion windows can hold dcl_asyncproc procedures called by asynchronous messages.

```

proc dcl_asyncproc {mid} {
  if {$mid == 19} {
    redraw
  }
}

```

The asynchronous message ID is passed for the argument of the `dcl_asyncproc` procedure.

The message IDs are shown below:

Table 8-3 Message ID

Message ID	Meaning
9	After changing configuration
10	After registering event
11	After deleting event
12	Before executing
13	After breaking
14	After resetting CPU
15	After resetting debugger
17	After changing extended option
18	After changing debugger option
19	After downloading
20	After changing memory or register
36	Before starting tracer
37	After stopping tracer
38	Before starting coverage
39	After stopping coverage
40	Before starting timer
41	After stopping timer
42	After clearing trace
45	After resetting symbol

8.8 Hook Procedure

A hook can be set in the debugger using the hook procedure.

The hook procedures are shown below:

BeforeDownload	Hook before downloading
AfterCpuReset	Hook after resetting CPU

BeforeCpuRun	Hook before starting execution
AfterCpuStop	Hook after breaking

By using hook procedures, register values can be changed before downloading programs or after resetting the CPU.

An actual example of the procedure is shown below. A hook is valid till the debugger is closed.

[When hook is set with debugger control command]

- 1 Create script file a. with an editor.
- 2 Start up the SM850, select [Browse] menu -> [Console], and open the Console window.
- 3 If the script file is executed in the window as below, the hook in the script file is set.
%hook test.tcl

[When hook is set on downloading of project file]

- 1 Create script file a. with an editor.

Caution Be sure that the script file name is the same as the project file.

Example:

The script file corresponding to test.prj is test.tcl.

Allocate test.prj, test.pri, and test.tcl in the same directory.

- 2 Start up the SM850 and read test.prj.
The hook in the script file is set.

An example of the contents of a script file is shown as below (using the V850E/MS1).

```

proc BeforeDownload {} {
    register MM 0x7
    register PMC8 0xff
    register PMC9 0xff
    register PMCX 0xe0
}

proc AfterCpuReset {} {
    register MM 0x7
    register PMC8 0xff
    register PMC9 0xff
    register PMCX 0xe0
}

```

8.9 Related Files

- Executes when the aliases.tcl console is opened.
Sets the default alias etc.
- Executes when the project file name.tcl project is opened.
The hook of BeforeDownload, AfterCpuReset, BeforeCpuRun and AfterCpuStop can be used.
- Executes when the load module name.tcl load module is downloaded.
The hook of BeforeDownload, AfterCpuReset, BeforeCpuRun and AfterCpuStop can be used.

8.10 Cautions

- The separator for file and path is a slash (/).
- When a console or an expansion window is active, the accelerator key cannot be acknowledged.
- When a console is open, error messages are output to the console.
- When the [F1] key on the console is pressed, the HTML format help is opened (not opened from the menu).
- To terminate the command forcibly, close the console.
- The execution of external commands (DOS commands) is OFF by default.

8.11 Commands

In this section, each command is explained using the format shown below.

Command name

Gives a brief explanation of the function of the command.

Name

Describes the command name.

Input format

Describes the input format of the command.

Functions

Explains the functions of the command.

Usage example

Shows an example of the usage of the command.

address

The following items are explained here.

- Name
- Input format
- Functions
- Usage example

Name

address - Evaluation of address expression

Input format

address *expression*

Functions

Converts the address expression specified by ***expression*** into address.

Usage example

```
(IDCON) 1 % address main
0xaa
(IDCON) 2 % address main+1
0xab
```

assemble

The following items are explained here.

- Name
- Input format
- Functions
- Usage example

Name

assemble - Disassemble/line assemble

Input format

assemble *?options? address ?code?*

Functions

Assembles the character strings specified by **code** from the **address** specified by address.

When '.' is specified for address, it is understood as an **address** continuing from the immediately previous assemble.

When **code** is omitted, it is assembled from the **address** specified by address.

The followings are **options**. They are ignored for assembly.

- code** Command code is also displayed. It is ignored for assembly.
- number number** *number* line is displayed. It is ignored for assembly.

Usage example

```
(IDCON) 1 % assemble -n 5 main
0x000000aa B7      PUSH HL
0x000000ab B1      PUSH AX
0x000000ac 891C    MOVW AX,SP
0x000000ae D6      MOVW HL,AX
0x000000af A100    MOV A,#0H
(IDCON) 2 % assemble main mov a,b
(IDCON) 3 % assemble . mov a,b
```

batch

The following items are explained here.

- Name
- Input format
- Functions
- Usage example

Name

batch - Executing batch (with echo)

Input format

batch scriptname

Functions

Executes in batch with displaying files specified by ***scriptname*** on the screen.

Nesting is possible.

Usage example

(IDCON) 1 % clear

(IDCON) 2 % batch bat_file.tcl

(IDCON) 3 % tkcon save a:/log.txt

breakpoint

The following items are explained here.

- Name
- Input format
- Functions
- Usage example

Name

breakpoint - Setting/deletion of breakpoint

Input format

breakpoint *?options? ?address1? ?address2?*

breakpoint *-delete brkno*

breakpoint *-enable brkno*

breakpoint *-disable brkno*

breakpoint *-information*

Functions

Operates the breakpoint specified by **options** and **address**.

If a breakpoint can be set correctly, the breakpoint number is returned.

The following are **options**:

-software	A software break is specified.
-hardware	A hardware break is specified (default).
-execute	The address execution break is set (default).
-beforeexecute	The break before address execution is set.
-read	An address data read break is set.
-write	An address data write break is set.
-access	An address data access break is set.
-size <i>size</i>	The access size is set (8, 16, or 32).
-data <i>value</i>	The data condition is set.
-datamask <i>value</i>	The data mask is set.
-extprobe <i>value</i>	The external sense data condition is set.

-extprobemask <i>value</i>	The external sense data mask is set.
-pass <i>value</i>	The path count is set.
-information	The list of breakpoints is displayed.
-delete	The breakpoint whose number is specified is deleted.
-disable	The breakpoint whose number is specified is disabled.
-enable	The breakpoint whose number is specified is enabled.

Usage example

(IDCON) 1 % breakpoint main

1

(IDCON) 2 % breakpoint -i

1 Brk00001 enable rammon.c#17

(IDCON) 3 % breakpoint -software sub

2

(IDCON) 4 % breakpoint -i

1 Brk00001 enable rammon.c#17

2 Brk00001 enable rammon.c#8

(IDCON) 5 % breakpoint -disable 2

(IDCON) 6 % breakpoint -i

1 Brk00001 enable rammon.c#17

2 Brk00001 disable rammon.c#8

(IDCON) 7 % breakpoint -delete 1

2 Brk00001 disable rammon.c#8

cache

The following items are explained here.

- Name
- Input format
- Functions
- Usage example

Name

cache - Setting of cache

Input format

cache

cache *config* *?-icache itype? ?-dcache dtype?*

cache *clear* *?-icache bool? ?-dcache bool?*

Functions

When **config** is specified for the subcommand, the cache type is set.

When **clear** is specified for the subcommand, whether cache clear is to be done by EXEC, or not, is set (default is clear)

When subcommand or below is omitted, the current status is displayed.

itype is selected from the following:

NB85E212	NB85E212 is used.
NB85E213	NB85E213 is used.
nouse	Not used (default).

dtype is selected from the following:

NB85E252	NB85E255 is used.
NB85E263	NB85E263 is used.
nouse	Not used (default).

Usage example

(IDCON) 1 % cache config -i NB85E212 -d NB85E252

(IDCON) 2 % cache

i-cache: NB85E212

d-cache: NB85E252

(IDCON) 3 % cache clear -i false

(IDCON) 4 % cache

i-cache: NB85E212 (persist)

d-cache: nouse

dbgexit

The following items are explained here.

- Name
- Input format
- Functions
- Usage example

Name

dbgexit - Terminating debugger

Input format

dbgexit *?options?*

Functions

Terminates the debugger.

The following are **options**:

-saveprj Project is saved on terminating debugger.

Usage example

(IDCON) 1 % dbgexit -saveprj

download

The following items are explained here.

- Name
- Input format
- Functions
- Usage example

Name

download - Download of files

Input format

download *?options? filename ?offset?*

Functions

Downloads file specified by **filename** according to **options**.

If **offset** is specified, the address is shifted by the **offset** (if the data is in binary format, the load start address is specified for **offset**).

-binary	Binary format data is downloaded.
-coverage	Coverage data is downloaded.
-append	Additional download is executed.
-nosymbol	Download is executed. Symbol information is not read.
-reset	CPU is reset after download.
-information	Download information is displayed.

Usage example

(IDCON) 1 % download test.lmf

extwin

The following items are explained here.

- Name
- Input format
- Functions
- Usage example

Name

extwin - Creation of expansion window

Input format

extwin *scriptfile*

Functions

Creates expansion window with ***scriptfile***.

Usage example

(IDCON) 1 % extwin d:/foo.tcl

finish

The following items are explained here.

- Name
- Input format
- Functions
- Usage example

Name

finish - Returning from function

Input format

finish

Functions

Executes until it returns to the program that called the current function.

Usage example

(IDCON) 1 % finish

go

The following items are explained here.

- Name
- Input format
- Functions
- Usage example

Name

go - continuous execution

Input format

go *?options?*

Functions

Executes the program continuously. When `-waitbreak` is specified, it waits for the program to stop.

The following are **options**:

- | | |
|---------------------|--|
| -ignorebreak | Breakpoint is ignored. |
| -waitbreak | The command waits for the program to stop. |

Usage example

(IDCON) 1 % go -w

help

The following items are explained here.

- Name
- Input format
- Functions
- Usage example

Name

help - Display of help

Input format

help

Functions

Displays Dcl help.

Usage example

(IDCON) 1 % help

hook

The following items are explained here.

- Name
- Input format
- Functions
- Usage example

Name

hook - Setting of hook

Input format

hook *scriptfile*

Functions

Sets the procedure for hook with ***scriptfile***.

Usage example

(IDCON) 1 % hook d:/foo.tcl

ie

The following items are explained here.

- Name
- Input format
- Functions
- Usage example

Name

ie - Display/setting of IE register

Input format

ie *reg address ?value?*

ie *dcu address ?value?*

Functions

The ie command depends on the IE.

Usage example

(IDCON) 1 % ie reg 0x100 1

(IDCON) 2 % ie dcu 0x100 1

jump

The following items are explained here.

- Name
- Input format
- Functions
- Usage example

Name

jump - Jump to window

Input format

jump *-source -line filename ?line?*

jump *?options? address*

Functions

Displays the window specified by *options*.

-source	The Source window is displayed from the address specified by address .
-assemble	The Assemble window is displayed from the address specified by address .
-memory	The Memory window is displayed from the address specified by address .
-coverage	The Coverage window is displayed from the address specified by address .
-line	The command is moved to the line specified by <i>ine</i> .

Usage example

(IDCON) 1 % jump -s main

(IDCON) 2 % jump -s -l mainfile.c 10

(IDCON) 3 % jump -m array

map

The following items are explained here.

- Name
- Input format
- Functions
- Usage example

Name

map - Setting/deletion of memory mapping

Input format

map *options address1 address2 ?accsize?*

Functions

Sets, deletes, and displays memory mapping.

The access size of 8, 16, or 32 is specified by **accsize** (the default is 8).

The following are **options**:

-erom	Alternate ROM is mapped.
-eram	Alternate RAM is mapped.
-extrom	Simulator alternate ROM is mapped.
-extram	Simulator alternate RAM is mapped.
-target	Target area is mapped.
-protect	I/O protect area is mapped.
-rrm	The starting address in the real-time RAM monitor area is set (only for V850).
-clear	All the settings for the mapping are deleted.
-information	Refer to the setting for the mapping.

Usage example

```
(IDCON) 1 % map -i
1: 0 0x7fff 8 {IROM}
```

2: 0x8000 0x87ff 8 {Target RRM}
3: 0x8800 0x9fff 8 {Target}
4: 0xa000 0xf7ff 8 {NonMap}
5: 0xf800 0xfaff - {NonMap}
6: 0xfb00 0xfedf 8 {Saddr}
7: 0xfef0 0xfeff 8 {Register}
8: 0xff00 0xffff 8 {SFR}
(IDCON) 2 % map -erom 0x100000 0x10ffff
(IDCON) 3 % map -c

mdi

The following items are explained here.

- Name
- Input format
- Functions
- Usage example

Name

mdi - Setting of expansion window

Input format

mdi *geometry ?x y? width height*

mdi *title string*

Functions

Sets the size and title name of the expansion window.

The command can be used only from the expansion window.

Usage example

(IDCON) 1 % mdi geometry 0 0 100 100

(IDCON) 2 % mdi title foo

memory

The following items are explained here.

- Name
- Input format
- Functions
- Usage example

Name

memory - Display/setting of memory

Input format

memory *?options? address ?value?*

memory *?options? -fill address1 address2 value*

memory *?options? -copy address1 address2 address3*

Functions

Sets **value** in the memory of the **address** specified by address according to **options**.

If **value** is omitted, display the value of the memory of the address specified by **address**.

If -fill is specified, value is filled from address1 to address2.

If -copy is specified, data from address1 to address2 is copied to address3.

The following are **options**:

-byte	Displayed/set in one-byte units (default).
-halfword	Displayed/set in halfword units.
-word	Displayed/set in word units.
-fill	The data is filled in.
-copy	The data is copied.
-noverify	Verification is not executed on writing.

Usage example

(IDCON) 1 % memory 100

0x10

(IDCON) 2 % memory 100 2

(IDCON) 3 % memory 100

0x02

(IDCON) 4 % memory -fill 0 1ff 0

module

The following items are explained here.

- Name
- Input format
- Functions
- Usage example

Name

module - Display of the list of files and functions

Input format

module *prognam* *?filename?*

Functions

Displays the list of files and functions of the load module specified by ***prognam***.

If filename is not specified, the list of files is displayed.

If filename is specified, the list of functions of the specified files is displayed.

Usage example

```
(IDCON) 1 % module rammon.lmf
```

```
1: rammon.c
```

```
(IDCON) 2 % module rammon.lmf rammon.c
```

```
1: rammon.c sub1
```

```
2: rammon.c main
```

next

The following items are explained here.

- Name
- Input format
- Functions
- Usage example

Name

next - Procedure step

Input format

next *?options?*

Functions

Executes the procedure steps. If functions are called, the step stops after executing function.

The following are **options**:

- | | |
|---------------------|---|
| -source | Command is executed in source line units (default). |
| -instruction | Command is executed in command units. |

Usage example

(IDCON) 1 % next -i

(IDCON) 2 % next -s

refresh

The following items are explained here.

- Name
- Input format
- Functions
- Usage example

Name

refresh - Redrawing of window

Input format

refresh

Functions

Redraws the window and updates the data.

Usage example

(IDCON) 1 % batch foo.tcl

(IDCON) 2 % refresh

register

The following items are explained here.

- Name
- Input format
- Functions
- Usage example

Name

register - Display/setting of register value and I/O register value

Input format

register *?options? regname ?value?*

Functions

Sets **value** in the register specified with **regname**.

If **value** is omitted, displays the value of the register specified by **regname**.

The following are **options**:

-force Compulsory reading is executed.

Usage example

(IDCON) 1 % register pc

0x100

(IDCON) 2 % register pc 200

(IDCON) 3 % register pc

0x200

reset

The following items are explained here.

- Name
- Input format
- Functions
- Usage example

Name

reset - Reset

Input format

reset *?options?*

Functions

Resets the CPU, debugger or symbols.

If options are omitted, the CPU is reset.

The following are **options**:

-cpu	CPU is reset (default).
-debugger	Debugger is reset.
-symbol	Symbol is reset.
-event	Event is reset.

Usage example

(IDCON) 1 % reset

run

The following items are explained here.

- Name
- Input format
- Functions
- Usage example

Name

run - Reset and execution of CPU

Input format

run *?options?*

Functions

Resets the program and executes it.

If -waitbreak is not specified, the command does not wait until the program stops.

The following are **options**:

-waitbreak

The command waits for the program to stop.

Usage example

(IDCON) 1 % run

(IDCON) 2 % run -w

step

The following items are explained here.

- Name
- Input format
- Functions
- Usage example

Name

step - Step execution

Input format

step *?options?*

Functions

Executes step execution.

If functions are called, the command stops at the head of the functions.

The following are **options**:

- | | |
|---------------------|---|
| -source | The command is executed in source line units (default). |
| -instruction | The command is executed in command units. |

Usage example

(IDCON) 1 % step -i

(IDCON) 2 % step -s

stop

The following items are explained here.

- Name
- Input format
- Functions
- Usage example

Name

stop - Stop executing

Input format

stop

Functions

Stops the program forcibly.

Usage example

(IDCON) 1 % run
(IDCON) 2 % stop

upload

The following items are explained here.

- Name
- Input format
- Functions
- Usage example

Name

upload - Upload

Input format

upload *?options? filename address1 address2*

Functions

Saves the memory data or coverage data within the specified range in a file.

The following are **options**:

-binary	The data is saved in binary format.
-coverage	The coverage data is saved.
-intel	The data is saved in Intel HEX format (default).
-motorola	The data is saved in Motorola HEX format.
-tektronix	The data is saved in Tektronix HEX format.
-force	The file is overwritten.

Usage example

(IDCON) 1 % upload -b foo.hex 0 0xffff

(IDCON) 2 % upload -c -f foo.cov 0 0xffff

version

The following items are explained here.

- Name
- Input format
- Functions
- Usage example

Name

version - Display of the version information

Input format

version

Functions

Displays the version information of the debugger.

Usage example

(IDCON) 1 % version

GUI : E2.00y [31-May-99]

Devicefile : 78K0[uPD780034] E1.01a

Debugger : 78K/0 Debugger E2.50c [02-Apr-99]

Executer : 78K/0 Executer E1.3c

Packet translator : 78K/0 Packet E2.00w

Assembler : 78K/0 Asm/Disasm E1.15a [01-Apr-99]

Tcl/Tk : 8.1.1

watch

The following items are explained here.

- Name
- Input format
- Functions
- Usage example

Name

watch - Display/setting of variables

Input format

watch *?options? variable ?value?*

Functions

Displays and sets the variables.

The following are **options**:

-binary	The value is displayed in binary digits.
-octal	The value is displayed in octal digits.
-decimal	The value is displayed in decimal digits.
-hexdecimal	The value is displayed in hexadecimal digits.
-string	The value is displayed in character strings.
-sizeof	The size, instead of the value, of variables is displayed in decimal digits.

Usage example

(IDCON) 1 % watch var

0x10

(IDCON) 2 % watch -d var

16

(IDCON) 3 % watch array[0] 0xa

where

The following items are explained here.

- Name
- Input format
- Functions
- Usage example

Name

where - Trace of stack

Input format

where

Functions

Executes the back-trace of the stack.

Usage example

```
(IDCON) 1 % where
1: test2.c#sub2(int i)#13
2: test.c#num(int i)#71
3: test.c#main()#82
```

wish

The following items are explained here.

- Name
- Input format
- Functions
- Usage example

Name

wish - Startup of Tclet

Input format

wish *scriptname*

Functions

Starts up the script using Tk (Tclet).

The expansion window can be created with Tclet.

Usage example

(IDCON) 1 % wish test.tcl

xcoverage

The following items are explained here.

- Name
- Input format
- Functions
- Usage example

Name

xcoverage - Operation of coverage

Input format

xcoverage *option*

Functions

Operates coverage.

The following are **options**:

- | | |
|---------------|---|
| -start | The coverage starts on executing the program. |
| -stop | The coverage stops on executing the program. |
| -clear | The coverage memory is cleared. |

Usage example

(IDCON) 1 % xcoverage -start

(IDCON) 2 % xcoverage -stop

(IDCON) 3 % xcoverage -clear

xtime

The following items are explained here.

- Name
- Input format
- Functions
- Usage example

Name

xtime - Operation of timer

Input format

xtime option

Functions

Operates timer.

The following are **options**:

- | | |
|-----------------|--|
| -start | Timer starts on executing the program. |
| -stop | Timer stops on executing the program. |
| -gobreak | Time from Go to Break is displayed with clock. |

Usage example

(IDCON) 1 % xtime -start

(IDCON) 2 % xtime -stop

xtrace

The following items are explained here.

- Name
- Input format
- Functions
- Usage example

Name

xtrace - Operation of tracer

Input format

xtrace *-dump ?-append? frameno ?filename?*

xtrace *-start*

xtrace *-stop*

xtrace *-clear*

xtrace *-addup bool*

xtrace *-mode mode*

Functions

Operates tracer.

The following are **options**:

-start	The tracer starts on executing the program.
-stop	The tracer stops on executing the program.
-clear	The trace data is dumped (default).
-dump	The dump result is redirected to the console window. If the file name is specified, the dump result is written in the file.
-append	The dump result is added to a file.
-addup <i>bool</i>	Whether the time tag is integrated or not is selected.
-mode <i>mode</i>	The trace control mode (any one of: all, cond, nonstop, fullstop, fullbreak, delaystop, delaybreak, machine, or event) is selected.

Usage example

```
(IDCON) 1 % xtrace -start
(IDCON) 2 % xtrace -stop
(IDCON) 3 % xtrace -dump 3
_01685 2 000000BC M1 br _sub2+0x2
_01686 4 0000009A BRM1 st.w r6, 0x8[sp]
_01687 3 0000009E BRM1 st.w r0, 0x0[sp]
(IDCON) 4 % xtrace -clear
(IDCON) 5 % xtrace -addup true
```

APPENDIX A INPUT CONVENTIONS

This appendix explains the input conventions of the following items:

- Character set
- Symbols
- Numeric Values
- Expressions and Operators

A. 1 Character set

The characters listed in Table A-1 can be used as the character set.

The characters listed in Table A-2 can be used as special characters.

Specify a line number as an integer constant, starting from 1.

Table A-1 Usable Character Set

Classification	Character
Alphabetic characters	Uppercase characters: A B C D E F G H I J K L M N O P Q R S T U V X W Z Lowercase characters: a b c d e f g h i j k l m n o p q r s t u v x w z
Numerals	0123456789
Character equivalent to alphabetic character	@_

Table A-2 List of Special Characters

Character	Name	Usage
(Left parenthesis	Changes operation order.
)	Right parenthesis	Changes operation order.
+	Plus	Addition operator or positive sign
-	Minus	Subtraction operator or negative sign
*	Asterisk	Multiplication operator or indirect reference operator
/	Slash	Division operator
%	Percent	Remainder operator
~	Tilde	Complement operator
	Vertical line	Bit sum operator
^	Circumflex	Bit difference operator
&	Ampersand	Bit product operator or address operator
[Left bracket	Array subscript operator or base register specification symbol

Table A-2 List of Special Characters

Character	Name	Usage
]	Right bracket	Array subscript operator or base register specification symbol
.	Period	Direct member operator or bit position specifier
,	Comma	Delimiter between operands

A. 2 Symbols

The following rules apply to symbols:

- 1 A symbol consists of characters A to Z, a to z, @, _ (underbar), . (period), and 0 to 9.
- 2 A symbol must start with a character other than numerals 0 to 9.
- 3 Uppercase characters (A to Z) and lowercase characters (a to z) are distinguished.
- 4 A symbol must be no more than 256 characters long (if a symbol of more than 265 characters is defined, only the first 256 characters are valid).
- 5 A symbol is defined by loading a load module file.
- 6 Symbols are classified into the following types by the valid range:
 - Global symbol (assembly language, C language)
 - Static symbol (C language)
 - In-file static symbol
 - In-function static symbol
 - Local symbol (C language)
 - In-file local symbol
 - In-function local symbol
 - In-block local symbol
- 7 The following symbols are available for each language used:
 - Assembly language
 - Label name
 - C language
 - Variable name (including pointer function name, enumeration type variable name, array name, structure name, and union name)
 - Function name, label name
 - Array element, structure element, union element, bit field (if the symbol is an array, structure, or union)
- 8 A symbol can be described instead of an address or numeric value.
- 9 The valid range of a symbol is determined based on the source debug information when the source file is assembled or compiled.
- 10 Describe only the symbol name of a global symbol.
- 11 A local symbol is expressed in pairs with a file name.

A. 3 Numeric Values

The following four types of numeric values can be used. The input format of each type is as shown below.

The suffix (bold) and the alphabetic characters of hexadecimal numbers may be uppercase or lowercase characters. If the first character is A to F, 0 must be prefixed to it.

In the input field of the debugger, decimal numbers or hexadecimal numbers are alternately selected, depending on the default radix.

Table A-3 Input Format of Numeric Values

numeric value	Input format
Binary number	n Y n...n Y (n=0,1)
Octal number	n O n...n O (n=0,1,2,3,4,5,6,7) n Q n...n Q (n=0,1,2,3,4,5,6,7)
Decimal number	n n...n n T n...n T (n=0,1,2,3,4,5,6,7,8,9)
Hexadecimal numbers	n n...n n H n...n H 0xn 0xn ...n (n=0,1,2,3,4,5,6,7,8,9,A,B,C,D,E,F)

A. 4 Expressions and Operators

Expressions

An expression consists of constants, register names, IOR names, and symbols coupled by operators.

If an IOR name, label name, function name, or variable name is described as a symbol, an address is calculated as the value of the symbol.

The elements making up an expression, except operators, are called terms (constants and labels).

Terms are called the first term, the second term, and so on, starting from the left.

Operators

The following operators of the C language can be used:

Table A-4 List of Operators

Symbol	Meaning	Explanation
Operators		
+	Addition	Returns the sum of the first and second terms.

Table A-4 List of Operators

Symbol	Meaning	Explanation
-	Subtraction	Returns the difference between the first and second terms..
*	Multiplication	Returns the product of the first and second terms.
/	Division	Divides the value of the first term by the value of the second term, and returns the integer of the result.
MOD %	Remainder	Divides the value of the first term by the value of the second term, and returns the remainder of the result.
- sign	Unary operator (negative)	Returns 2's complement of the value of the term.
+ sign	Unary operator (positive)	Returns the value of the term.
Logical operator		
NOT ~	Negation	Logically negates each bit of the term, and returns the result.
AND &	Logical product	Obtains the logical product of the values of the first and second terms on each bit, and returns the result.
OR 	Logical sum	Obtains the logical sum of the values of the first and second terms on each bit, and returns the result.
XOR ^	Exclusive logical sum	Obtains the exclusive logical sum of the values of the first and second terms on each bit, and returns the result.
Shift operator		
SHR >>	Right shift	Shifts the value of the first term by the value (number of bits) of the second term to the right, and returns the result. As many 0s as the number of shifted bits are inserted in the higher bits.
SHL <<	Left shift	Shifts the value of the first term by the value (number of bits) of the second term to the left, and returns the result. As many 0s as the number of shifted bits are inserted in the lower bits.
Byte separation operator		
HIGH	Higher byte	Of the lowest 16 bits of the term, returns the higher 8 bits.
LOW	Lower byte	Of the lowest 16 bits of the term, returns the lower 8 bits.
Word separation operator		
HIGHW	Higher word	Of the 32 bits of the term, returns the higher 16 bits.
LOWW	Lower word	Of the 32 bits of the term, returns the lower 16 bits.
Other		
(Left parenthesis	Performs the operation in () before the operation outside (). '(' and ')' are always used in pairs.
)	Right parenthesis	

Rules of operation

Operations are performed according to the priority of the operators.

Table A-5 Operator Priority

Priority	Operators
1 Higher	(,)
2	+ sign, - sign, NOT, , HIGH, LOW, HIGHW, LOWW
3	*, /,, MOD, %, SHR, >>, SHL, <<
4	+, -
5	AND, &
6 Lower	OR, , XOR, ^

- If the priorities of the operators are the same, the operation is performed from the left toward the right.
- Performs the operation in () before the operation outside ().
- Each term in an operation is treated as unsigned 32-bit data.
- All operation results are treated as unsigned 32-bit data.
- If an overflow occurs during operation, the lower 32 bits are valid, and the overflow is not detected.

Terms

To describe a constant for a term, the following numeric values can be described.

Table A-6 Range of Radixes

Radix	Range
Binary number	0Y <= value <= 11111111111111111111111111111111Y (32 digits)
Octal number	0O <= value <= 3777777777O
Decimal number	-2147483648 <= value <= 4294967295 (A negative decimal number is internally converted into a 2's complement.)
Hexadecimal numbers	0H <= value <= 0FFFFFFFH

APPENDIX B TERMINOLOGY

The major terms used throughout this manual are as follows:

- Current window
- Delimiter (separator)
- Program
- File
- Function
- Structure
- Stack frame number
- Line

B. 1 Terminology

Current window

The current window is the window you are now in and operating by means of key input and menu selection.

Delimiter (separator)

The following separators can be used as the delimiter of file names, function names, variable names, and line numbers.

Table B-1 Delimiter

Delimiter	Meaning
#	Used as a separator of file names, variable names, function names, and line numbers.
\$	Used as a separator of load module names, file names, variable names, and function names.

Program

A program is the execution unit to be debugged. The debugger manages each one of the load module files specified on downloading as a program.

To specify a program name, use a load module file name on downloading.

Current program

The current program is the program that contains the instruction currently breaking execution (instruction indicated by the PC).

When specifying a file in the current program, the program name may be omitted.

File

Up to 127 characters can be handled in a file name with path.

Depending on the type of file, however, a file name of more than 127 characters can be specified.

Current file

The current file is the source file that contains the instruction currently breaking execution (instruction indicated by the program counter (PC)).

When specifying a line or function in the current file, the file name may be omitted.

Function

Indicates the functions constituting a C source program.

Current function

The current function is the function that contains the instruction currently breaking execution (instruction indicated by the program counter (PC)).

When accessing a local variable in the current function, specifying the function name may be omitted.

Structure

Structures and unions in C language are called structures.

The name structure is used if a structure or union variable is used without members explicitly specified.

Stack frame number

The stack frame number is a decimal integer starting from 1 and is assigned to the stack contents.

The shallower the nesting level of the stack, the higher the number. A function having a stack number one less than that of a certain function is the function that calls the certain function.

Line

A line is specified in order to identify one line in the source file.

Specify a line number as an integer constant, starting from 1.

APPENDIX C MESSAGES

This appendix explains messages displayed in the Error/Warning dialog box of the simulator.

C.1 Error/Warning Messages from Debugger Part

C. 1. 1 Display format of debugger

Messages from the debugger part are generated and output to the Error/Warning dialog box when "information that should be informed to users (fatal error, syntax error, and warning or questions)" is detected while the debugger is executing processing.

The product name is displayed on the title bar of the dialog box.

Figure C-1 Error/Warning Messages from Debugger Part

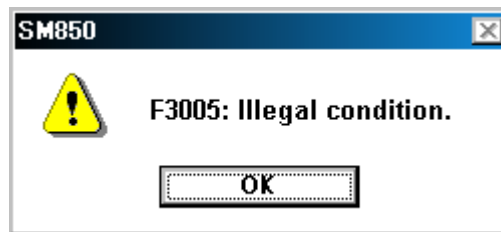

There are three types of messages in the debugger (fatal error message, syntax error message, and warning message or question message).

A : Fatal error messages

When a fatal error is detected in the debugger, a message is output to the Error dialog box before aborting the processing and terminating the debugger.

F : Syntax error messages

When a syntax error is detected in the debugger, a message is output to the Error dialog box before aborting the processing. At this time, opened windows and dialog boxes are closed.

W : Warning message or question message

When a warning or question is detected in the debugger, a message is output to the Warning dialog box before aborting the processing.

C. 1. 2 Fatal error messages

A list of the messages that are output when fatal errors are detected while the debugger is executing processing is shown below in numerical order.

A0101: Can not find initialization file (expc.ini).

A0102: Host name not found.

A0105: Failed in reading device file (d3xxx.800).

- 1) Necessary files may be damaged. Reinstall the device file.

A01a6: Executor is running.

A01a8: Failed in reading initialization file (expc.ini).

A01d0: Not enough memory in starting simulator.

A01d1: Not enough memory in starting simulator.

A04a1: Not enough memory for emulation.

A0600: Not enough memory for buffer.

- 1) There is not enough system memory. Close the applications being executed and the open files.

A1001: No entry exists for specified number.

A1002: Can not relocate internal RAM.

A1005: Illegal relocation address.

A1008: Not enough memory for tables.

- 1) There is not enough system memory. Close the applications being executed and the open files.

A1009: Already initialized.

A100a: Not initialized.

A1015: Programmable-IOR does not exist.

A1dbe: Error occurred inside debugger.

A2001: Illegal address.

A2009: Device file is damaged or error is in file.

A200b: Can not copy.

A200c: Not enough memory.

- 1) There is not enough system memory. Close the applications being executed and the open files.

A2222: Illegal condition.

A3012: Not enough memory.

- 1) There is not enough system memory. Close the applications being executed and the open files.

A4011: Not enough memory.

- 1) There is not enough system memory. Close the applications being executed and the open files.

A4018: Not enough memory.

- 1) There is not enough system memory. Close the applications being executed and the open files.

A5000: Illegal device file type.

A5001: Not enough memory.

- 1) There is not enough system memory. Close the applications being executed and the open files.

A5002: Can not open device file.

A5003: Reading of device file went wrong.

A5004: Can not close device file.

A5005: Illegal device file format.

- 1) Necessary files may be damaged. Reinstall the device file.

A5007: Device file has broken or error is in a file.

A500c: Failed in reading expc.ini.

A500d: Not enough memory.

- 1) There is not enough system memory. Close the applications being executed and the open files.

A5300: Illegal device file type.

A5301: Not enough memory.

- 1) There is not enough system memory. Close the applications being executed and the open files.

A5302: Can not open database file.

- 1) Necessary files may be damaged. Reinstall the simulator and device file.

A5303: Reading of database file went wrong.

A5304: Can not close database file.

A5305: Illegal database file format.

1) Necessary files may be damaged. Reinstall the debugger or simulator, and device file.

A5306: Database information has been already initialized.

A5307: Database information does not exist.

A7012: Not enough memory.

1) There is not enough system memory. Close the applications being executed and the open files.

A70fe: Bus hold error.

1) CPU is in the bus-hold status. Reset the debugger.

A7f03: Failed in canceling RUN/STEP.

A9000: Specified register symbol does not exist.

A9001: Specified register symbol ID does not exist.

A9003: Illegal condition.

A9004: Too large register size.

Aa005: Not enough memory.

1) There is not enough system memory. Close the applications being executed and the open files.

Aa00b: Can not close file.

Aa00c: Failed in reading file.

1) The file is damaged or does not exist. Recreate the file.

Aa013: Reading of file went wrong.

Ab009: Not enough memory.

1) There is not enough system memory. Close the applications being executed and the open files.

Ab00d: Current function does not exist.

Ab00e: Current line does not exist.

Ab00f: Tag not found.

Ab010: Failed in loading symbol table.

Ab011: Illegal line number.

Ab015: Reading of file went wrong.

1) The file is damaged or does not exist. Recreate the file.

Ab016: Can not open file.

1) The file is damaged or does not exist. Recreate the file.

Ab017: Failed in writing file.

1) The file is damaged or does not exist. Recreate the file.

Ab019: Reading of file went wrong.

Ab01a: Can not close file.

Ab01c: Too many entries of the task kind .

Ab023: Current stack frame is not active.

Ab024: Different section.

Ab030: Monitor timed out.

1) Check the power of the in-circuit emulator, cable connections, and setting of the interface board and restart the debugger.

Ab031: Already set in memory.

Ab032: Out of scope.

Ab033: LP is not stored.

Ab039: Failed in loading debug information.

Ab03a: No more section information.

Ab041: Specified file is not load module.

Ac002: Can not close file.

Ac003: Reading of file went wrong.

1) The file is damaged or does not exist. Recreate the file.

Ac004: Reading of file went wrong.

Ac009: Not enough memory.

1) There is not enough system memory. Close the applications being executed and the open files.

Ad000: Error occurred inside debugger.

Ad001: Not enough memory.

1) There is not enough system memory. Close the applications being executed and the open files.

Ad002: Failed in reading initialization file (expc.ini).

Ae008: Not enough memory

1) There is not enough system memory. Close the applications being executed and the open files.

Af000: Not enough memory.

1) There is not enough system memory. Close the applications being executed and the open files.

C. 1. 3 Syntax error messages

A list of the messages that are output when syntax errors are detected while the debugger is executing processing is shown below in numerical order.

F0002: This feature is not supported.

F0200: No mapped address was accessed.

1) External memory could not be accessed, as it is not set.

F02a0: Bus hold error.

1) CPU is in the bus-hold status. Reset the debugger.

F02a2: Can not compulsory break.

- F02d2: Not enough memory for trace-buffer.
- F0300: User program is running.
- F0301: User program is being broken.
- F0302: User program is being traced.
- F0303: Not traced.
- F0304: Trace memory is not set.
- F0306: No trace block exists.
- F0307: No event condition exists.
- F0308: No timer measurement is done.
- F0309: No trigger frame exists.
- F030a: Tracer is being stopped.
- F030b: Specified snap-event has not been registered.
- F030c: Specified stub-event has not been registered.
- F030d: Timer is running.
- F030e: Memory copy area is overlapped.
- F030f: Trace has been already set.
- F0310: Event condition is not set.
- F0311: Too many valid timer event conditions.
- F0312: Specified timer event is not set.
- F0313: illegal map range.
- 1) Check the setting in "Memory Mapping (mapping setting area)" in the Configuration dialog box.

- F0315: Delay trigger cannot set with trace full mode.
- F03a1: Step execution is being done.
- F03a2: Timer and Tracer are running.
- F03d0: Back-trace is being executed.
- F03d1: Back-trace is being stopped.
- F03d2: Back-trace execution point overrun oldest frame.
- F03d3: Register status or Memory status cannot be set up other than Phase1 of event link.
- F03d4: No back-trace information exists.
- F03d5: Last command can not be backstepped.
- F0400: Illegal condition.
- 1) Settings of the used in-circuit emulator and those of the Configuration dialog box may not match.
Check the Chip selection of "Chip (CPU selection area)".
- F0401: Result of timer measurement overflowed.
- F0402: Too many event conditions with path count.
- F0403: Too many address range conditions.
- F0404: Too many simultaneously-usable-event conditions.
- F0405: Too many snap-events.
- F0406: Too many stub-events.
- F0407: Too many initialization data.
- F0408: Too large search data (> 16 byte).
- F0409: Too large search data (> search range).

- F040a: Too many Linking-event conditions.
- F04a0: Too many software breaks (> 100).
- F04a2: Too many partition of bus size.
- F04a3: Too many execution-event conditions.
- F04a4: Too many bus-event conditions.
- F0b61: Section Trace event conditions overflow.
- F0c00: Monitor file read error.
- 1) Necessary files may be damaged. Reinstall the debugger.
- F0c20: Guarded area can not be accessed.
- F0c40: Status of effective event conditions cannot be changed.
- F0c41: Coverage test is being executed.
- F0c60: Event before execution cannot be set up other than break conditions.
- F0c61: Can not register event numbers which can not be used for hardware break.
- F0c62: Event numbers reserved for hardware breaks can not be used.
- F0ca1: Monitor file not found.
- 1) Necessary files may be damaged. Reinstall the debugger.
- F1003: Illegal relocation address.
- F1004: Illegal condition
- F1006: Illegal address.
- F100b: User program is running.
- F100c: Different bus size has been already specified.
- F100d: Too large bus size.

F100e: Too large bus partition size.

F100f: Target is not turned on.

F1010: Illegal map range.

F1011: Failed in setting internal ROM and RAM.

F1012: This feature is not supported.

F1013: No terminal name.

F1016: Programmable-IOR does not movable.

1) Necessary files may be damaged. Reinstall the latest device file.

F2000: Illegal I/O register name.

F2002: User program is running.

F2003: Illegal I/O register number.

F2004: Illegal bit number.

F2006: Hidden I/O register was specified.

F2007: I/O register of ban read/write was specified.

F2008: I/O register not existing was specified.

F200a: Illegal value specified for I/O register.

F3000: No mapped address was accessed.

1) The allocation addresses of the program and the addresses of the debugger may not match.
Set the mapping to the external memory in "Memory Mapping (mapping setting area)" in the Configuration dialog box according to the allocation addresses specified in the link directive file on compilation.

F3001: Memory has different value.

F3002: Illegal start address.

- F3003: Illegal end address
- F3004: Illegal start address and end address.
- F3005: Illegal condition.
- F3006: User program is running.
- F3007: Verification error.
- F3008: No condition specified.
- F3009: Parameter size does not align with access size alignment.
- F300a: Specified address does not align with access size alignment.
- F300b: Source address does not align with access size alignment.
- F300c: Destination address does not align with access size alignment.
- F300d: Illegal end address.
- F300e: Different access size in specified area.
- F300f: Different access size both in source and destination areas.
- F3010: Different access size in destination area.
- F3011: Different access size, source & destination.
- F3013: Failed in writing DMM.
- F3014: Overflowed mapping area.
- F3015: Processing was interrupted.
- F3016: This feature is not supported.
- F4000: Can not delete specified event.

- 1) The specified event cannot be deleted as it is being used under another condition. Invalidate it for other usages before deleting.

F4001: Illegal table number.

F4002: Illegal start address.

F4003: Illegal end address.

F4004: Illegal status.

F4005: Illegal data.

F4006: Specified event number has been already used.

F4007: Too many same events are registered.

F4008: Specified event has not been registered.

F4009: Illegal data size.

F400a: Illegal mode.

F400b: Setting value is inaccurate.

F400c: Event link conditions cannot be used for section trace conditions.

F400d: Too many identical events are registered (≥ 32767).

F400e: Specified event condition does not exist.

F400f: Illegal event link condition.

F4010: Function not found.

F4012: Timer is being disabled.

F4014: Can not use software break.

F4015: Can not use event condition specifying address range.

- F4016: Can not change event condition.
- F4017: Can not access word at odd address.
- F4019: This feature is not supported.
- F401a: No Event.
- F401b: Can not use tag-event.
- F401d: Start event and end event of timer are not made to the same setup.
- F401e: Too many trace-events.
- F401f: Path count cannot be set up.
- F4020: Address range cannot be set up in event before execution.
- F4021: Event conditions number overflow.
- F4022: Software DMM conditions number overflow.
- F4023: Real-time call conditions number overflow.
- F4024: Software break call conditions number overflow.
- F4318: Illegal memory bank setting.
- F5008: Can not open device file.
1) Necessary files may be damaged. Reinstall the device file.
- F500a: Specified device file is illegal version.
1) Necessary files may be damaged. Reinstall the device file.
- F5308: Can not open specified database file.
1) Necessary files may be damaged. Reinstall debugger or simulator.
- F5309: Specified database file is illegal version.
1) Necessary files may be damaged. Reinstall the debugger or simulator, and the device file.
- F6000: Current function does not exist.

- F6001: Illegal symbol name.
- F6002: Illegal condition.
- F6003: Illegal function name.
- F6004: Overflowed output buffer size.
- F6005: Illegal expression.
- F7000: Illegal mode.
- F7001: User program is running.
- F7002: User program has been stopped.
- F7003: Trace enabled.
- F7004: Trace memory is not set.
- F7005: Function return address does not exist, can not do step execution.
- F7801: End waiting state of step execution was canceled.
- F7802: End waiting state of step execution was canceled.
- F7f00: Aborted step execution.
- F7f02: Suspended step execution.
- F7f04: Can not execute non-mapped area.
- F7f05: This feature is not supported.
- F8000: Specified file was not found.
- F8001: Illegal line number.
- F8002: Current information is not set.

F8003: Illegal address.

F8004: This feature is not supported.

F9002: Illegal value.

F9005: This feature is not supported.

Fa001: Illegal expression.

Fa002: Start address is bigger than the end address.

Fa003: Illegal source path.

Fa004: Too long expression.

Fa006: Illegal argument.

Fa007: Illegal program number.

Fa008: Source path is not set.

Fa009: File not found.

Fa00a: Can not open file.

1) The file is damaged or does not exist. Recreate the file.

Fa00d: Not source file of load module.

Fa00e: Illegal line number.

Fa00f: Variable does not exist.

Fa011: Can not access register.

Fa012: Can not access memory.

Fa014: It was going to open the binary file.

Fa015: Can not get temporary path.

1) The disk is full. Delete or move unnecessary files and increase the available memory in the disk.

Fa016: Can not create temporary file.

- 1) The disk is full. Delete or move unnecessary files and increase the available memory in the disk.

Fa017: Can not remove temporary file.

Fa020: This feature is not supported.

Fa021: Symbol assigned to register cannot be specified.

Fb000: Illegal command line.

Fb001: Program information does not exist in specified load module file.

Fb002: File not found.

Fb003: Function not found.

Fb004: Selected load module different from kind(Chip) was loaded.

Fb005: Symbol not found.

- 1) The address could not be found. Specify a location holding address information.

Fb008: Illegal expression.

Fb00a: Illegal symbol in load module file.

Fb00b: Current program does not exist.

Fb00c: Current file does not exist.

Fb012: Too large line number.

Fb01b: Too long load module file name.

Fb01d: Address not found.

Fb01f: Can not find structure member.

Fb020: Can not find value.

Fb021: No debug information exists in load module file.

- 1) To create a load module with appended debug information, execute build in build mode of Debug Build.

Fb022: Illegal line number.

Fb026: Too many array dimensions (> 4).

Fb027: Found end of file.

- 1) The specified file may be damaged. Recreate the file.

Fb028: This feature is not supported.

Fb029: Illegal address.

Fb02b: Can not stack trace with current PC value.

Fb02c: Too many blocks for one function.

Fb02d: Illegal argument.

Fb02e: The file does not exist in the SOURCE PATH.

- 1) On stopping the program, the source that the debugger tried to display could not be found. Check if the path connects to the source (using "Source Path (source path specification area)" in the Debugger Option dialog box), or check if the source is in the same directory as the out file. Refer to the Assemble window on which the error message is displayed, and check if the corresponding path connects.

Fb02f: Information has been deleted because of optimization.

Fb034: Return execution from present PC position cannot be performed.

Fb037: Too Many Line-Numbers Information.

Fb038: Compiler version mismatch.

- 1) Recreate the load module with the latest compiler.

Fb040: Specified file is not load module.

- 1) This is not a linker output file. Source debug cannot be executed with the load module before output from the linker. Specify the load module output from the linker.

Fb32e: Illegal port number.

Fb32f: Illegal port name.

Fb330: Illegal port position.

Fb331: Illegal increment number.

Fb332: Port for memory bank is not set.

Fb333: Illegal bank number.

Fb334: Area for memory bank is not set.

Fc001: Can not open file.

1) The file is damaged or does not exist. Recreate the file.

Fc005: Illegal file type.

Fc006: Kind(Chip) of load module is illegal.

Fc007: Specified file is not load module.

1) This is not a linker output file. Source debug cannot be executed with the load module before output from the linker. Specify the load module output from the linker.

Fc008: Specified load module file (ELF) is old version.

Fc00a: No mapped address was accessed.

Fc00b: Load module is not loaded.

Fc00c: Illegal argument.

Fc00d: User program is running.

Fc00e: User program is being traced.

Fc00f: Interrupted.

Fc011: Illegal load module file format.

Fc012: Check sum error.

Fc013: Too wide address range to upload (> 1M byte).

Fc014: Failed in writing file.

1) The file is damaged or does not exist. Recreate the file.

Fc015: Illegal program number.

Fc016: Load information is full.

Fc018: Specified file is not load module.

1) This is not a linker output file. Source debug cannot be executed with the load module before output from the linker. Specify the load module output from the linker.

Fc019: Failed in writing memory.

Fc01b: Programmable-IOR address not specified.

1) Necessary files may be damaged. Reinstall debugger or simulator.

Fc100: This feature is not supported.

Fd004: Can not find Dynamic Link Library.

Fe000: Illegal argument.

Fe001: Illegal start address.

Fe002: Illegal end address.

Fe003: Too large size.

Fe004: Can not open file.

1) The file is damaged or does not exist. Recreate the file.

Fe005: Failed in reading file.

1) The file is damaged or does not exist. Recreate the file.

Fe006: Reading of file went wrong.

Fe007: Failed in writing file.

- 1) The file is damaged or does not exist. Recreate the file.

- Fe009: Illegal file format.

- Fe00a: Verification error.

- Fe010: This feature is not supported.

- Ff001: [XXX] not found.

- Ff004: Missing parameter.

- Ff005: Illegal function name.

- Ff006: Illegal number.

- Ff007: Start address is bigger than end address.

- Ff008: Illegal symbol or expression.

- Ff009: [XXX] This file is illegal type.

- Ff100: Disk cannot write or full.

- Ff101: File not found.

- Ff102: File not Create.

- Ff103: Old project file version.

- Ff104: Illegal project file format.

- Ff105: This file is a project file for [XXX].Please select a correct file.

- Ff201: Memory mapping error.

- Ff202: Verify error.

- Ff301: The symbol being used on the event condition can't be evaluated.

- Ff306: This name is too long.

- Ff307: There is the same name in other kinds.
- Ff308: An address can't be omitted.
- Ff309: Illegal address mask.
- Ff30a: Illegal data mask.
- Ff30b: Illegal ext probe mask.
- Ff30c: Illegal ext probe data.
- Ff30d: Illegal pass count.
- Ff30e: Illegal register name.
- Ff310: Illegal delay count.
- Ff312: [XXX] is already there.
- Ff313: Event number already exist.
- Ff314: Event name is not set.
- Ff315: [XXX] is already there.
- Ff316: Max number of enabled [XXX] event is over. Please disable other enabled [YYY] event.
- Ff317: Max number of set event is over.
- Ff31e: Illegal start address.
- Ff31f: Illegal end address.
- Ff350: There is a phase which event are not in the middle.
- Ff351: The same event is contained in Link and Disable.
- Ff352: An event isn't specified.

Ff400: Coverage mapping error.

Ff500: Illegal symbol.

Ff501: Illegal value.

Ff502: Illegal parameter.

Ff503: Max number of symbol is over.

Ff504: This variable cannot be set as a break.

1) Break cannot be set for the following variables.

- Local variables, static variables
- Array variables, member variables of structures/unions
- Register/peripheral IOR
- Variable expressions

Ff802: All events are deleted. because the use of external probe was changed.

Ff803: This event address is invalid on current configuration.

Ff804: Invalid PC value.

Ff805: Cannot set temporary break on this address.

Ff806: External data is being used by Debugger.

Ff900: Illegal I/O port name.

Ff901: Memory mapping error.

1) The specification of the address is illegal. The addresses that can be specified are in either the Target area or IOR area. Check in "Address: (I/O port address specification area)" in the Add I/O Port dialog box.

Ff902: Illegal access size.

Ff903: Illegal access type.

Ff904: There is the same name.

Ffa00: The [XXX] function of current program on PC position not found.

1) The symbol specified in main() label: in "Startup Routine (start-up symbol setting area)" in the Debugger Option dialog box could be found. Set a symbol of the main routine of the program. Default is `_main`.

Ffa01: The line information on PC position not found.

1) The source file corresponding to program counter (PC) value when the program was stopped could not be found. The following reasons are possible.

- 1 The source file exists in a location that the source path does not connect to.
- 2 The program stopped where the source files, such as library or RX, do not exist.
- 3 The program looped, jumped to an address that is not used by the program, and stopped there.

Ffc00: Help window cannot be started. Please install HTML Help environment with reference to a users manual.

Ffff: Interrupted.

C. 1. 4 Warning message or question message

A list of the messages that are output when warnings or questions are detected while the debugger is executing processing is shown below in numerical order.

W1014: Data is not exist.

W2005: I/O register of Read Protect attribute was specified.

W200d: No initialize data for SFR.

W4013: Access size is different from its mapped bus size.

W401c: Software break can not be set on this area.

W500b: Specified device file does not relocate IRAM.

W7010: No source information exists.

W7011: Unknown result of step execution.

Wb01e: No debug information (not compiled in Debug Build mode).

Wb036: Out of variable region.

Wb042: Symbol module is not initialized.

Wb335: Too long symbol name.

Wc017: Symbol information is duplicated, please reset symbols.

Wc01a: No mapped address was accessed.

Wc01c: Programmable IOR address mismatch.

1) Necessary files may be damaged. Reinstall the debugger or simulator.

Wc01d: Selected load module different from kind(Chip) was loaded.

Wf002: Not found [XXX]. Search from the beginning?

Wf003: Already exceed search region.

Wf106: CPU in the Project File was Changed. You must exit the debugger for the new CPU. Do you exit the Debugger?

Wf107: CPU in the Project File was Changed. Do you start the Debugger with this CPU?

Wf108: Selected project file different [YYY] from chip [XXX] was opened. Does it open, although the chip cannot be changed?

Wf109: Project Manager cannot be used with the debugger of this version. Please use PMplus.

Wf200: No differences encountered.

Wf203: When a program is running, while rewriting a memory, program execution stops for a moment. Do you wish to rewrite a memory?

Wf300: Would you like to save the changes made in [XXX]?

Wf302: Delete: [XXX]

Wf303: [XXX] is edited. Delete: [YYY]?

Wf304: [XXX] is edited. Save: [YYY]?

Wf305: [XXX] is already exist. Do you replace it?

Wf311: Only one [XXX] can be enabled. Do you make this [YYY] to enable?

Wf325: User program is running. Do you want to stop user program for a moment and set it?

Wf326: User program is running. Do you want to stop user program for a moment and delete it?

Wf401: Clear coverage?

Wf600: Save project file?

Wf700: Do you want to download Load Module File?

Wf905: [XXX] is already exist. Do you replace it?

Wf906: Would you like to register the change made in [XXX]?

Wfb00: User program is running. Do you want to stop user program?

C.2 Error/Warning Messages From The Simulator Part

C. 2. 1 Display format of simulator

Simulator messages are generated and output to the Error/Warning dialog box when "information to be reported to users (error or warning)" is detected while the simulator is executing processing.

"Error" or "Warning" is displayed on the title bar of the dialog box.

Figure C-2 Simulator Error/Warning Dialog Box

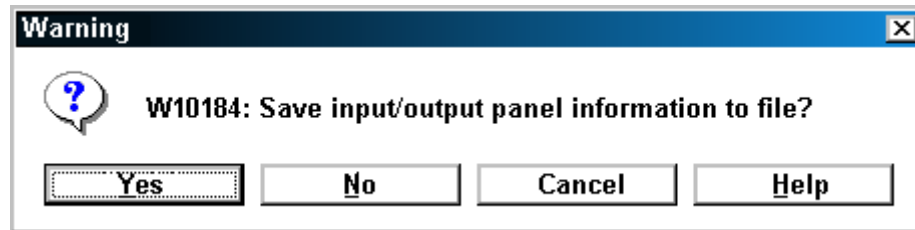

There are two types of simulator messages (error messages and warning messages).

E : Error messages

With the debugger, when an error is detected, a message is output to the Error dialog box and the processing is stopped.

W : Warning message

With the debugger, when a warning is detected, a message is output to the Warning dialog box and the processing is continued.

C. 2. 2 Error messages

A list of messages that are output when errors are detected while the simulator is executing processing is shown in numerical order.

E10000: Could not allocate input data buffer.

- 1) Area for input data buffer could not be secured on downloading. Close other applications and secure memory.

E10001: Could not allocate system memory for input data loading.

- 1) System memory for input data loading could not be secured. Close other applications and secure memory.

E10002: Could not allocate output data buffer.

- 1) Area for output data buffer could not be secured. Close other applications and secure memory.

E10003: Failed to load input data.

- 1) Input data could not be loaded. Close other applications and secure memory.

E10004: The main clock and sub clock cannot be set to 0Hz at the same time.

- 1) 0 Hz is set for both for main clock and subclock. Set another value for either the main clock or subclock.

E10005: An error occurred during output file operation. Simulation stopped.

- 1) An error occurred in an output file operation. Check the disk status to generate a correct file.

E10006: An error occurred in output data display. Simulation stopped.

- 1) An error occurred in an output data display operation of the Output Timing Chart window. Check the disk status to generate a correct file.

E10007: Failed to open output file.

- 1) Output file could not be opened. Check the disk status to generate a correct file.

E10008: Failed to write to output file.

- 1) Writing operation to output file failed. Check the disk status to generate a correct file.

E10009: Could not allocate memory.

- 1) Memory could not be secured. Close other applications and secure memory.

E1000a: The file name is not correct.

- 1) An incorrect file name was specified. Specify a correct file name.

E1000b: The file name or the path is not correct.

- 1) A non-existent file name was specified. Specify a correct file name or path name.

E1000c: Cannot overwrite file.

- 1) Writing to file failed. Check the disk status to generate a correct file.

E1000d: Cannot read file.

- 1) Reading from file failed. Verify that the file exists or check the contents of the file.

E1000e: Cannot create file.

- 1) File could not be created in the Download dialog box. Check the disk status to generate a correct file.

E1000f: The file type is not correct.

- 1) An attempt was made to save the file with an incorrect extension. Specify a correct extension to save the file.

E10010: Cannot search output signal.

- 1) An attempt was made to edit output signal search data in the Search window. Check the message and operation.

E10011: Cannot search interrupt data.

- 1) An attempt was made to edit interrupting signal search data in the Search window. Check the message and operation.

E10012: Cannot search analog output data.

- 1) An attempt was made to edit analog output signal search data in the Search window. Check the message and operation.

E10013: Cannot search analog input data.

- 1) An attempt was made to edit analog input signal search data in the Search window. Check the message and operation.

E10014: Could not find searching data.

- 1) The data matching the Search window data does not exist. Check the message.

E10015: Search window is already displayed.

- 1) An attempt was made to open two Search windows at the same time. Cancel the existing Search window and open a new one.

E10016: There is no data for loading in input data file.

- 1) Input data file was loaded to the end. Add the information you want to enter in the input data file.

E10017: Data cannot be input from external devices during backtrace execution.

- 1) On executing back-trace, An attempt was made to enter data from external parts. Do not enter from external parts during back trace.

E10018: Address(xxxxxxxx) is not correct.

- 1) The address value entered in the IOR Event & Action dialog box is outside the settable range. Enter a settable address value.

E1001a: STATUS(xxxxxxxx) is not correct.

- 1) The status entered in the IOR Event & Action dialog box is incorrect. Enter a settable status.

E1001b: Access Size(xxxxxxxx) is not correct.

- 1) The access size entered in the IOR Event & Action dialog box is incorrect. Enter a settable access size.

E1001c: Data(xxxxxxxx) is not correct.

- 1) The data value entered in IOR Event & Action dialog box is outside the settable range. Enter a settable data value.

E1001d: Data Mask(xxxxxxxx) is not correct.

- 1) The data mask value entered in the IOR Event & Action dialog box is outside the settable range. Enter a settable data mask value.

E1001e: Pass Count(xxxxxxxx) is not correct.

- 1) The path count value entered in the IOR Event & Action dialog box is outside the settable range. Enter a settable path count value.

E1001f: Timing Value(xxxxxxxx) is not correct.

- 1) The timing value entered in the IOR Event & Action dialog box is outside the settable range. Enter a settable timing value.

E10020: Interrupt name(xxxxxxxx) is not correct.

- 1) The unit of timing entered in the IOR Event & Action dialog box is incorrect. Enter a settable unit of timing.

E10021: Interrupt name(xxxxxxxx) is not correct.

- 1) The interrupt request name entered in the IOR Event & Action dialog box is incorrect. Enter a settable interrupt request name.

E10022: Pin name(xxxxxxxx) is not correct.

- 1) An incorrect pin name was set. Set a correct pin name.

E10023: Wait Value(xxxxxxxx) is not correct.

- 1) An incorrect wait value was set. Set a correct wait value.

E10024: IOR name(xxxxxxxx) is not correct.

- 1) The IOR name entered in the IOR Event & Action dialog box is incorrect. Enter a settable IOR name.

E10025: The data is empty.

- 1) An attempt was made to save an empty file. Create data.

E10026: This function is not supported in this version.

- 1) An attempt was made to use an unsupported function. Check the message and operation.

E10027: Editing the interrupt data is not permitted.

- 1) An attempt was made to edit interrupt signal data. Check the message and operation.

E10028: Editing the analog output data is not permitted.

- 1) An attempt was made to edit analog output signals. Check the message and operation.

E10029: Please input file name.

- 1) The OK button was clicked without entering a file name. Enter a file name.

E1002a: The File name has been changed to (xxxxxxx).

- 1) The file name entered in the Down Load dialog box is incorrect. Check the message and operation.

E1002b: This will overwrite download data of pin (xxxxxxx).

- 1) Data to the same pin were set for multiple files in the Down Load dialog box. Check the message and operation.

E1002c: Illegal pin name (xxxxxxx) exists.

- 1) An incorrect pin name is set. Set a correct pin name.

E1002d: Pin name (xxxxxxx) is not correct.

- 1) An incorrect pin name is set. Set a correct pin name.

E1002e: Pin name (xxxxxxx) has already been set.

- 1) The same pin was set more than once in the Pin Setting dialog box. Specify one pin for one place.

E1002f: The connection to the pin(xxxxxxx) will change.

- 1) An event that would change the destination of data captured at the pin occurred, or an external part was connected to the pin. Check the message.

E10030: Editing the output data is not permitted.

- 1) An attempt was made to edit output signal data. Check the operation.

E10031: Failed to open trace file.

- 1) Trace file could not be opened. Check the disk status.

E10032: Failed to write to trace file.

- 1) Writing to the trace file failed. Check the disk status.

E10033: Mismatch database-file(simulator) format. xxxx is expected version.

- 1) Database file for simulator is incorrect. Obtain the latest device file and database file and reinstall them.

E10034: Can not open data-basefile (simulator).

- 1) Database file for simulator cannot be opened. Check the disk status and reinstall a device file and a database file.

E10035: Unexpected contents of database-file (simulator).

- 1) Database file for simulator is incorrect. Obtain the latest device file and database file and reinstall them.

E10036: Creating file name (xxxx).

- 1) Outputting to a file now. Cancel the current file output and specify the file output again.

E10037: Please input file name.

- 1) Output file name is not specified. Specify an output file name.

E10038: Cannot display window.

- 1) Window handle is lacking. Close other applications to acquire a window handle and restart the simulator.

E10100: The selected pin name does not exist.

- 1) The set pin does not exist. Set a pin name that exists on the target device.

E10101: The pin name is a 2-byte name.

The set pin name is described with 2-byte characters. Describe the pin name with 1-byte characters.

E10102: No Key Matrix present.

- 1) No input pin or output pin is set in the Key Matrixes dialog box. Set at least one input pin and one output pin.

E10103: Hold time is invalid.

- 1) Retention time is not set within the settable range or is not a numerical value. Set the retention time within the range 999msec to 0.001msec.

E10104: Segment signal setting is invalid.

- 1) Pin names for segments are not described or the setting is not complete. Set all the eight (or fifteen) pins for segments.

E10105: Disit signal setting is invalid.

- 1) Pin names for digit signals are not described, or are set discontinuously. Set the pins for digit signals from the lowest digit continuously.

E10106: The selected pin is not an analog input pin.

- 1) Pin name of a pin not for analog data was set. Set a pin for analog data.

E10107: AVref is above/under operating voltage range.

- 1) AVref is not within the range of operating voltage. Set it within the range of operating voltage.

E10108: The segment/grid setting is above/under the range.

- 1) The range for the display segment is not set or the range for the display timing output is not set. Set the range for the display segment or display timing output.

E10109: FIP segment/grid setting is invalid.

- 1) The settings of the range for the display segment and display timing output are not correct. Set the range for the display segment and display timing output.

E1010a: The selected bit map file does not exist.

- 1) The bitmap file name of active/inactive status in the Bitmap Entry dialog box does not exist. Set an existing bitmap file name.

E1010b: No settings exist for the active bit map file.

- 1) An active bitmap file in the Bitmap Entry dialog box is not set. Set an active bitmap file.

E1010c: The selected bit map file is invalid.

- 1) A bitmap file specified in the Bitmap Entry dialog box is incorrect. Set a bitmap format file.

E1010d: The number of associated bit maps exceeded 384.

- 1) The registered bitmap files are more than the maximum number, 384, in the Bitmap Entry dialog box. Make the number of files registered 384 or fewer.

E1010e: The bit map ID is a 2-byte ID.

- 1) The bitmap numbers are described with 2-byte characters in the Bitmap Entry dialog box. Set the bitmap number with 1-byte characters.

E1010f: The number of associated text/line/rectangle exceeded 20.

- 1) The sum of the character strings, lines, or rectangles is over 20 in the Parts window. Stop entering characters, lines, or rectangles.

E10110: Could not get address of user's function.

- 1) The function names specified in functions called from user DLL (UpCallFuncName, UpLoadProjName, UpSaveProjName, UpResetFuncName) did not exist or were not exported. Create the function names specified in simulation call function, or declare EXPORTS in def file.

E10111: An error occurred during 7 Segment LED Port Setting Window creation.

- 1) Window handle is lacking. Close other applications to acquire a window handle and restart the simulator.

E10112: An error occurred during Button Port Setting Window creation.

- 1) Window handle is lacking. Close other applications to acquire a window handle and restart the simulator.

E10113: An error occurred during Internal Interrupt Button Setting Window creation.

- 1) Window handle is lacking. Close other applications to acquire a window handle and restart the simulator.

E10114: An error occurred during Buzzer Select Window creation.

- 1) Window handle is lacking. Close other applications to acquire a window handle and restart the simulator.

E10115: An error occurred during FIP Select Window creation.

- 1) Window handle is lacking. Close other applications to acquire a window handle and restart the simulator.

E10116 An error occurred during Key Port Setting Window creation.

- 1) Window handle is lacking. Close other applications to acquire a window handle and restart the simulator.

E10117: An error occurred during LCD Port Setting Window creation.

- 1) Window handle is lacking. Close other applications to acquire a window handle and restart the simulator.

E10118: An error occurred during LED Port Setting Window creation.

- 1) Window handle is lacking. Close other applications to acquire a window handle and restart the simulator.

E10119: An error occurred during Port Level Gauge Setting Window creation.

- 1) Window handle is lacking. Close other applications to acquire a window handle and restart the simulator.

E1011a: An error occurred during DC Motor Port Setting Window creation.

- 1) Window handle is lacking. Close other applications to acquire a window handle and restart the simulator.

E1011b: Could not allocate bit map association table.

- 1) Window handle is lacking. Close other applications to acquire a window handle and restart the simulator.

E1011c: An error occurred during 14 Segment LED Port Setting Window creation.

- 1) Window handle is lacking. Close other applications to acquire a window handle and restart the simulator.

E1011d: Could not make buzzer sound.

- 1) A soundboard and a speaker are lacking. Mount a soundboard and a speaker.

E1011e: Could not create Buzzer Display Window.

- 1) Window handle is lacking. Close other applications to acquire a window handle and restart the simulator.

E1011f: Could not create DC Motor Display Window.

- 1) Window handle is lacking. Close other applications to acquire a window handle and restart the simulator.

E10120: Could not allocate FIP display table.

- 1) Memory could not be secured. Close other applications and secure memory.

E10121: Could not allocate LCD display table.

- 1) Memory could not be secured. Close other applications and secure memory.

E10122: Could not allocate LED display table.

- 1) Memory could not be secured. Close other applications and secure memory.

E10123: Could not create LED Display Window.

- 1) Window handle is lacking. Close other applications to acquire a window handle and restart the simulator.

E10124: The selected pin name is already set.

- 1) An attempt was made to re-set a pin that had already been set in the Buttons dialog box. Do not set a pin that has been already set.

E10125: Could not create Reset Button Window.

- 1) Window handle is lacking. Close other applications to acquire a window handle and restart the simulator.

E10126: An error occurred during the creation of the brush for the 7 segment LED.

- 1) The brush handle could not be secured. Close other applications and restart the simulator.

E10127: An error occurred during the creation of the pen for the 7 segment LED.

- 1) The pen handle could not be secured. Close other applications and restart the simulator.

E10128: An error occurred during covering of the 7 segment LED.

- 1) The drawing of the 7-segment display was not correct. Close other applications and restart the simulator.

E10129: An error occurred during the selection of the pen for the 7 segment LED.

- 1) The drawing of the 7-segment display was not correct. Close other applications and restart the simulator.

E1012a: An error occurred during the selection of the brush for the 7 segment LED.

- 1) The drawing of the 7-segment display was not correct. Close other applications and restart the simulator.

E1012b: An error occurred during drawing of the 7 segment LED.

- 1) The drawing of the 7-segment display was not correct. Close other applications and restart the simulator.

E1012c: Could not create 7 Segment LED Display Window.

- 1) Window handle is lacking. Close other applications to acquire a window handle and restart the simulator.

E1012d: An error occurred during usre's dll loading.

- 1) An attempt was made to read a user DLL that is incorrect. Use a correct user DLL.

E1012e: An error occurred during usre's dll opening.

- 1) An attempt was made to read a user DLL that is incorrect. Use a correct user DLL.

E1012f: An error occurred during GDI object creating.

- 1) Failed to secure a correct bitmap format drawing in placement mode in the Parts window. Close other applications and restart the simulator.

E10130: An error occurred during the creation of the brush for the 14 segment LED.

- 1) The brush handle could not be secured. Close other applications and restart the simulator.

E10131: An error occurred during the creation of the pen for the 14 segment LED.

- 1) The pen handle could not be secured. Close other applications and restart the simulator.

E10132: An error occurred during covering of the 14 segment LED.

- 1) The drawing of the 14-segment display was not correct. Close other applications and restart the simulator.

E10133: An error occurred during the selection of the pen for the 14 segment LED.

- 1) The drawing of the 14-segment display was not correct. Close other applications and restart the simulator.

E10134: An error occurred during the selection of the brush for the 14 segment LED.

- 1) The drawing of the 14-segment display was not correct. Close other applications and restart the simulator.

E10135: An error occurred during drawing of the 14 segment LED.

- 1) The drawing of the 14-segment display was not correct. Close other applications and restart the simulator.

E10136: Could not create 14 Segment LED Display Window.

- 1) Window handle is lacking. Close other applications to acquire a window handle and restart the simulator.

E10137: The path is illegal.

- 1) On registering a bitmap, an incorrect path was specified. Specify a correct path.

E10138: An error occurred during memory allocation.

- 1) Memory could not be secured. Close other applications and secure memory.

E10139: Allocation error.

- 1) Memory could not be secured. Close other applications and secure memory.

E1013a: An error occurred during PLL Information Window creation.

- 1) Window handle is lacking. Close other applications to acquire a window handle and restart the simulator.

E1013b: An error occurred during Serial Information Window creation.

- 1) Window handle is lacking. Close other applications to acquire a window handle and restart the simulator.

E1013c: Setting Data is invalid.

- 1) An incorrect frequency was set in the PLL information window. Set a correct frequency.

E1013d: Cannot Group 7/14 Segment.

- 1) Selected and tried to group a 7/14 segment. Deselect a 7/14 segment for grouping.

E1013e: An error occurred during Pull-Up / Pull-Down Setting Window creation.

- 1) Window handle is lacking. Close other applications to acquire a window handle and restart the simulator.

E1013f: Register class entry error.

- 1) Window class could not be registered. Close other applications and secure memory.

E10140: Could not allocate DC motor display table.

- 1) Memory could not be secured. Close other applications and secure memory.

E10141: This function is not supported in this device.

- 1) An attempt was made to use an unsupported function. Select a function supported by the target device.

E10142: The number of loaded user's dll is over max number.

- 1) The user DLL read functions are more than the maximum number, 6. Make read functions 6 or fewer.

E10143: An error occurred during memory allocation.

- 1) Memory could not be secured. Close other applications and secure memory.

E10144: An error occurred during memory locking.

- 1) Memory could not be secured. Close other applications and secure memory.

E10145: Illegal Bit Pattern.

- 1) The register settings related to interrupts are incorrect. Verify the register settings related to interrupts.

E10146: CPU-clk is fxt/2,but you set SCC.

- 1) The setting that stops subclock oscillation was set, although the CPU is running with the subclock. Run the subclock.

E10147: By Vector simulator returned state not expected.Vector Simulator running?

- 1) The CAN simulator is not running or has stopped. Start the CAN simulator or change it to the run status.

E10148: Write access violation.

- 1) The write-protected FCAN register was written to. Stop the write operation.

E10149: Read access violation.

- 1) An attempt was made to read the read-protected FCAN register. Stop the read operation.

E1014a: Writing to CxBRP/CxSYNC is only possible in INIT mode.

- 1) CxBRP/CxSYNC was written to when it was not in INIT mode. Write in INIT mode.

E1014b: Loading Interface file to Vector 'NecSim.Dll' failed.

- 1) NecSim.Dll, which is necessary for communication with the CAN simulator, is not on the path. Set the path for NecSim.Dll on the system.

E1014c: Determining functions in Vector Interface Library failed.

- 1) NecSim.Dll may be damaged, or the version may be old. Reinstall the latest simulator.

E1014d: An error occurred in communication with a CAN simulator.

- 1) A system error occurred in communication with the CAN simulator. Check the executing environment of the CAN simulator.

E10200: The active H/L is not HIGH or LOW.

- 1) The described active H/L is a value other than HIGH or LOW. Describe HIGH or LOW in the active H/L.

E10201: The channel number is not 4 or 8.

- 1) The described number of the channels is a value other than 4 or 8. Describe 4 or 8 for the number of the channels according to the number of the pins.

E10202: The phase is not 0 or 1.

- 1) The described excitation value is a value other than 0 or 1. Describe 0 or 1 for excitation according to the excitation method.

E10203: The minimum step angle does not divide to 360.

- 1) The described minimum step angle is a value that cannot divide 360 evenly. Describe an integer value that can divide 360 evenly for the minimum step angle.

E10204: The picture type is not PIC_RECT or PIC_ELL.

- 1) The described value for the type of figure in the parameter is a value other than macro PIC_RECT or PIC_ELL. Describe PIC_RECT or PIC_ELL for the type of figures.

E10205: The color type is not PIC_RED or PIC_YELLOW or PIC_GREEN.

- 1) The described value for the type of color in the parameter is a value other than macro PIC_RED, PIC_YELLOW, or PIC_GREEN. Describe one of PIC_RED, PIC_YELLOW, or PIC_GREEN for the type of color.

E10206: The view type is no 0 or 1.

- 1) The described value of the figure style is a value other than 0 or 1. Describe 0 or 1 for the parameter figure style.

E10207: The first bit of serial input data is not MSB or LSB.

- 1) The described value of the first bit of the parameter is a value other than 1 or 0. Describe 1 or 0 for the first bit of the parameter.

E10208: The active H/L of output1 is not HIGH or LOW.

- 1) The described value of the active H/L of output 1 for the parameter is a value other than HIGH or LOW. Describe HIGH or LOW for the active H/L of output 1 for the parameter.

E10209: The active H/L of output2 is not HIGH or LOW.

- 1) The described value of the active H/L of output 1 for the parameter is a value other than HIGH or LOW. Describe HIGH or LOW for the active H/L of output 1 for the parameter.

E1020a: The port name is a 2-byte name.

- 1) The port name of the parameter is described with 2-byte characters. Describe the port name of the parameter with 1-byte characters.

E1020b: The selected port name does not exist.

- 1) A nonexistent port name is described as the port name of the parameter. Describe a port name existing on a target device.

E1020c: The parameter is NULL pointer.

- 1) An incorrect parameter is described in a function. Describe a correct parameter.

E1020d: The function xxxx can not set in UOxxx.dll.

- 1) This function was described in UOxxx.dll. Use it in UPxxx.dll.

E1020e: The function xxxx can not set in UPxxx.dll.

- 1) This function was described in UPxxx.dll. Use it in UOxxx.dll.

E1020f: The function xxxx does not set previous.

- 1) A necessary notification function was not notified previously. Call the necessary notification function previously.

E10210: The register type is not REG_PC or REG_PSW or REG_SP.

- 1) A register other than the control register was specified. Do not specify a register other than the control register.

E10211: Illegal parameter.

- 1) The parameter of the setting for a memory access event is incorrect. Check the parameter.

E10212: Too many Memory-event condition.

- 1) The number of memory access events is more than the maximum settable number, 32. Set 32 or fewer.

E1ffff: Error Occurred.

- 1) An internal error occurred. Notify the manufacturer.

C. 2. 3 Warning message

Here is a list of the messages that are output when warnings are detected while the simulator is executing processing, in numerical order.

W10080: Could not open input data file. Do you want to continue simulation?

- 1) Input data file could not be opened. Check the disk status and specify a correct file name.

W10081: Accessed a port used as address/data bus. Do you want to continue simulation?

- 1) A pin used as an address/data bus was accessed as a port. Access a pin accessible as a port.

W10082: Accessed a port used as data bus. Do you want to continue simulation?

- 1) A pin used as a data bus was accessed as a port. Access a pin accessible as a port.

W10083: Accessed a port used as control signal output. Do you want to continue simulation?

- 1) A pin used as a control signal output function was accessed as a port. Access a pin accessible as a port.

W10084: A pin not supported in the chip under simulation was accessed.
Do you want to continue simulation?

- 1) A pin that was not in the device under simulation was accessed. Use a pin that exists in the device under simulation

W10085: Failed to restore input file pointer during backtrace execution. Do you want to continue simulation?

- 1) On executing back-trace, the input file pointer could not be restored. Check the disk status to generate a correct file.

W10086: Failed to restore output file pointer during backtrace execution. Do you want to continue simulation?

- 1) On executing back-trace, the output file pointer could not be restored. Check the disk status to generate a correct file.

W10088: This will initialize all data.

- 1) The <Clear> button was clicked. Check the message and operation.

W10089: This will overwrite present data.

- 1) On editing data, the button which performs overwrite was clicked. Check the message and operation.

W1008a: This will end Input 0/1 Editor.

- 1) The <Cancel> button in the Input 0/1 Enter window was clicked. Check the message and operation.

W1008b: This will end Input Timing Chart Editor.

- 1) The <Cancel> button in the Input Timing Chart Editor window was clicked. Check the message and operation.

W1008c: This will end output timing chart.

- 1) The <Cancel> button in the Output Timing Chart Editor window was clicked. Check the message and operation.

W1008d: This will initialize all download data.

- 1) The file type to be loaded was not selected in the Down Load dialog box. Check the message and operation.

W1008e: This will end IOR Event & Action Setting Dialog.

- 1) The <Cancel> button in the IOR Event & Action dialog box was clicked. Check the message and operation.

W1008f: Accessed a port used as address bus. Do you want to continue simulation?

- 1) A pin used as an address bus was accessed as a port. Access a pin accessible as a port.

W10090: Creation of output file discontinued.

- 1) The specification to create output file was cleared. Check the message and operation.

W10180: Hold time is not set. Hold time is set to 0.5 msec.

- 1) Retention time is not set. Set the retention time.

W10181: AVref is not set. AVref is set 5.0v,continue?

- 1) AVref is not set. Set AVref.

W10182: The active and inactive bit map file names are the same,continue?

- 1) The specification of an active bitmap file name and an inactive bitmap file name is the same in the Bitmap Entry dialog box. Set different names for an active and an inactive bitmap files.

W10183: The created bitmap is canceled, continue?

- 1) The created bitmap information is not saved in a file. Save the created bitmap in a file with a paint tool etc.

W10184: Save input/output panel information to file?

- 1) Termination of the I/O panel was selected. Check the message and operation.

W10280: Data cannot be input from external devices during backtrace execution.

- 1) Data input during back-trace is prohibited. Do not input data while executing back-trace.

APPENDIX D KEY FUNCTION LIST

Debugging can be efficiently executed by using special function keys.

Note that, in the following explanation, ordinary key representation (generic key representation) is used because the key representation differs depending on the type of keyboard.

Table D-1 through Table D-8 list the functions of the respective keys.

D. 1 Function List of Special Function Keys

Table D-1 Function List of Special Function Keys

Key	Function
BackSpace	Deletes one character before the cursor and moves the cursor to the position of the deleted character. At this time, the character string following the cursor moves forward.
Delete	Deletes one character after the cursor and move the character string following the cursor forward. Deletes a various event condition selected in the Event Manager or each event dialog box. Deletes the data selected in the Watch window.
Insert	Alternately selects the insert mode and overwrite mode in the Source window and Assemble window. However, this key is invalid in the Memory, Register, and IOR windows, and only the overwrite mode can be used as an input mode.
PrintScreen	Loads the entire display screen to the clipboard as a bitmap image (function of Windows).
Esc	Closes the pull-down menu. Closes the modal dialog box. Restores the input data.
Alt	Moves the cursor to the menu bar.
End	Moves the cursor to the end of the line.
Home	Moves the cursor to the beginning of the line.
PageUp	Scrolls the screen one screen up. The cursor also moves up to the top of the screen.
PageDown	Scrolls the screen one screen down. The cursor also moves up to the top of the screen.
Space	Inserts one blank character.
Tab	Moves the cursor to the next item.
Up arrow key	Moves the cursor up. If the cursor is at the bottom of the screen, scrolls the screen up one line at a time.
Down arrow key	Moves the cursor down. If the cursor is at the top of the screen, scrolls the screen down one line at a time.
Right arrow key	Moves the cursor to the left. If the cursor is at the leftmost position on the screen, scrolls the screen one column to the right.

Table D-1 Function List of Special Function Keys

Key	Function
Left arrow key	Moves the cursor to the right. If the cursor is at the rightmost position on the screen, scrolls the screen one column to the left.
Enter	Sets the input data. Presses the default push button.

D. 2 Function List of Function Keys

Table D-2 Function List of Function Keys

Key	Function
F1	Opens the Help window.
F2	Forcibly stops program execution. Same function as [Run] -> [Stop] on the menu bar.
F3	Resets the CPU. Same function as [Run] -> [CPU Reset] on the menu bar.
F4	Resets the CPU and executes the program. Same function as [Run] -> [Restart] on the menu bar.
F5	Executes the program. Same function as [Run] -> [Go] on the menu bar.
F6	Executes the program to the cursor position in the Source or Assemble window. Same function as [Run] -> [Come Here] on the menu bar
F7	The user program is real-time executed until execution returns. Same function as [Run] -> [Return Out] on the menu bar
F8	Step execution. Same function as [Run] -> [Step In] on the menu bar.
F9	Sets a breakpoint at cursor position in Source or Assemble window. Same function as [Run] -> [Break Point] on the menu bar.
F10	Next step execution. Same function as [Run] -> [Next Over] on the menu bar.

D. 3 Function List of Special Function Keys (Shift + key)

Table D-3 Function List of Special Function Keys (Shift + key)

Key	Function
End	Expands the selection range to the end of the line.
Home	Expands the selection range to the beginning of the line.
Left arrow key	Expands the selection range one character to the left.
Right arrow key	Expands the selection range one character to the right.

D. 4 Function List of Function Keys (Shift + key)

Table D-4 Function List of Function Keys (Shift + key)

Key	Function
F6	Executes the program from the cursor position in the Source or Assemble window. Same function as [Run] -> [Start From Here] on the menu bar.
F9	Resets the CPU. Same function as [Run] -> [CPU Reset] on the menu bar.

D. 5 List of Special Function Keys (Ctrl + key)

Table D-5 List of Special Function Keys (Ctrl + key)

Key	Function
End	Displays the last line. The cursor will also move to the last line.
Home	Displays the first line. The cursor will also move to the first line.
Left arrow key	Moves the cursor one word to the left. If the cursor at the leftmost position on the screen, scrolls the screen one column to the right.
Right arrow key	Moves the cursor one word to the right. If the cursor at the rightmost position on the screen, scrolls the screen one column to the left.

D. 6 Function List of Function Keys (Ctrl + key)

Table D-6 Function List of Function Keys (Ctrl + key)

Key	Function
F5	Ignores break points being set, and executes the program. Same function as [Run] -> [Ignore break points and Go] on the menu bar.
F9	Sets the address at the cursor position in the Source window or Assemble window to the PC. Same function as [Run] -> [Change PC] on the menu bar.

D. 7 Function List of Control Keys (Ctrl + key)

Table D-7 Function List of Control Keys (Ctrl + key)

Key	Function
A	Selects all the events registered to the Event Manager. Same function as [View] -> [Select All Event] on the menu bar in the Event Manager.
C	Copies a selected character string and saves it to the clipboard buffer.
D	Disassembles and displays the results from the jump destination address specified by the data value selected in the current window. Opens the Assemble window. Same function as [Jump] -> [Assemble] on the menu bar.
E	Opens the source file displayed in the active Source window with the editor specified by the PM plus when the PM plus is running. Same function as [Edit] -> [Edit Source] on the menu bar.
G	Performs a search. Opens the search dialog box corresponding to the current window. Same function as [View] -> [Search...] on the menu bar.
I	Displays the memory contents from the jump destination address specified by the data value selected in the current window. Opens the Coverage window. Same function as [Jump] -> [Coverage] on the menu bar.
J	Moves the display position. Opens the Source Move, Address Move, or Trace Move dialog box, depending on the current window. Same function as [View] -> [Move...] on the menu bar.
M	Displays the memory contents from the jump destination address specified by the data value selected in the current window. Opens the Memory window. Same function as [Jump] -> [Memory...] on the menu bar.
O	Loads a view file, source file, or text file. Opens the View File Load dialog box. The operation will differ depending on the extension of the file. view file: Displays the file in the corresponding window. Others: Displays the file in the Source window. Same function as [File] -> [Open...] on the menu bar.
S	Saves the data displayed in the current window to the view file. Same function as [View] -> [Save...] on the menu bar.
U	Displays the corresponding source text and source line, using the data value selected in the current window as the jump destination address. Opens the Source window. Same function as [Jump] -> [Source Text] on the menu bar.
V	Pastes the contents of the clipboard buffer to the text cursor position.
W	Temporarily displays the contents of the specified data. Opens the Quick Watch dialog box. Same function as [View] -> [Quick Watch...] on the menu bar.
X	Cuts a selected character string and saves it to the clipboard buffer. Same function as [Edit] -> [Cut...] on the menu bar.

D. 8 List of Special Function Keys (Ctrl + Shift + key)

Table D-8 List of Special Function Keys (Ctrl + Shift + key)

Key	Function
Left arrow key	Expands the selection range one word to the left.
Right arrow key	Expands the selection range one word to the right.

APPENDIX E INDEX

Numerics

- 14seg LEDs dialog box ... 383
- 7seg LEDs dialog box ... 379

A

- About dialog box ... 319
- Active status ... 61
- Add I/O Port dialog box ... 225
- Add Watch dialog box ... 198
- address ... 416, 424
- Address Move dialog box ... 133
- All trace ... 52
- ASCII display ... 171
- assemble ... 416, 425
- Assemble Search dialog box ... 166
- Assemble window ... 160
- Auto Load ... 114
- Auto load ... 33, 102
- Auto save ... 102, 112

B

- Balloon watch function ... 55, 148, 192
- batch ... 416, 426
- Bitmap Entry dialog box ... 405
- Block information ... 232
- Break condition ... 97
- Break dialog box ... 286
- Break function ... 50
- breakpoint ... 416, 427
- Breakpoint for read/write access ... 192
- Breakpoint setting/deletion function ... 146
- Browse dialog box ... 131
- Build mode ... 31
- Buttons dialog box ... 368
- Buzzers dialog box ... 393

C

- cache ... 416, 429
- Callback procedure ... 419
- Cause of stopping tracer ... 232
- Change Watch dialog box ... 202
- Character set ... 462
- Color of character on event mark ... 265
- Come function ... 47, 50, 152
- Command ... 19, 323
- Command line ... 416
- Command list ... 416
- Command reference ... 416
- Compulsion read ... 217, 219
- conditional trace ... 52
- Configuration dialog box ... 28, 89
- Console window ... 323
- Contents Saved to Project File ... 109
- Coverage measurement function ... 53
- Coverage Search dialog box ... 251
- Coverage window ... 246

- Coverage-Address dialog box ... 256
- Coverage-Clear dialog box ... 254
- Coverage-Condition Setting dialog box ... 258
- Coverage-Efficiency View dialog box ... 261
- Current window ... 467

D

- Data display format ... 190
- Data input ... 39
- Data output ... 42
- dbgexit ... 416, 431
- DC Motors dialog box ... 390
- Debugger ... 20
- Debugger Option dialog box ... 99
- Debugging environment ... 46
- Delay count ... 315
- Delay trigger ... 292
- Delay trigger break ... 53
- Delay trigger stop ... 52
- Delay trigger trace ... 53
- Delimiter ... 467
- Device file ... 21
- Disable condition ... 283
- Display color of breakpoint ... 146, 147
- Display files ... 56
- Displaying Event Details ... 267
- Down Load dialog box ... 345
- Download ... 41, 44
- download ... 416, 432
- Download dialog box ... 122
- Drag & drop function ... 154, 155

E

- Error message ... 469, 494
- Error/warning message ... 469
- Event after execution ... 154
- Event condition ... 49
- Event dialog box ... 271
- Event display mark ... 147
- Event function ... 48
- Event link condition ... 49
- Event Link dialog box ... 280
- Event Manager ... 263
- Execution mode ... 359
- Exit Debugger dialog box ... 321
- Expressions ... 464
- Extended Option dialog box ... 95
- External parts ... 35
- External parts at CPU reset ... 38
- extwin ... 416, 433

F

- Fail-safe break ... 51
- Fatal error message ... 469
- File ... 467
- finish ... 416, 434

- Flow of debugging operations ... 58
 - Font ... 102
 - Font dialog box ... 107
 - Format of file that can be downloaded ... 122
 - Format of specifiable file ... 126
 - Full break ... 52
 - Full stop ... 52
 - Function ... 468
- G**
- g option ... 21
 - go ... 416, 435
- H**
- help ... 417, 436
 - hook ... 417, 437
 - Hook procedure ... 420
 - Host machine ... 20
- I**
- I/O Port ... 217, 225
 - ie ... 417, 438
 - Illegal access break ... 51
 - Information files ... 56
 - initialized ... 317
 - Input 0/1 Editor window ... 331
 - Input conventions ... 462
 - Input timing Chart Editor window ... 337
 - Installing ... 22
 - Internal Interrupt Button dialog box ... 396
 - IOR Event & Action dialog box ... 327
 - IOR Select dialog box ... 222
 - IOR window ... 217
- J**
- JMP [r31] ... 54
 - jump ... 417, 439
 - Jump address ... 304
 - Jump function ... 61, 153
- K**
- Kanji code ... 103
 - Key function list ... 511
 - Key Matrixes dialog box ... 372
- L**
- LEDs dialog box ... 376
 - Level Gauges dialog box ... 387
 - Linking window ... 62
 - Load module list dialog box ... 129
 - Load/save function ... 55
 - Local Variable window, ... 205
- M**
- Main window ... 28, 69
 - Main Window of Simulator GUI ... 324
 - map ... 417, 440
 - Mapping unit ... 93
 - Marks of Event Icon ... 265
 - mask ... 241, 275, 276
 - Maximum number of valid events ... 263
 - mdi ... 417, 442
 - memory ... 417, 443
 - Memory Compare dialog box ... 181
 - Memory Compare Result dialog box ... 183
 - Memory Copy dialog box ... 179
 - Memory Fill dialog box ... 177
 - Memory manipulation function ... 55
 - Memory Search dialog box ... 174
 - Memory window ... 169
 - Menu bar ... 72
 - Messages ... 469
 - Display format ... 469, 494
 - Error message ... 494
 - Fatal error message ... 469
 - Syntax error message ... 469, 474
 - Warning message ... 494, 508
 - Warning message or question message ... 469, 491
 - Mixed display ... 151, 233
 - mnemonic ... 232
 - module ... 417, 445
- N**
- next ... 417, 446
 - Non map break ... 51
 - Non-mapped area ... 251
 - Non-real-time execution function ... 47
 - Non-stop ... 52
 - Normal mode ... 271, 281
- O**
- Offset setting ... 124
 - Online assembly ... 160
 - Open dialog box ... 410
 - Operating environment ... 20
 - Operating system ... 21
 - Operators ... 464
 - Output Setting dialog box ... 347
 - Output Timing Chart window ... 350
- P**
- Parts window ... 357
 - Pass count ... 283
 - Peripheral I/O event & action ... 43
 - Pick up ... 245
 - Pickup display ... 236
 - Pin Setting dialog box ... 342
 - Placement mode ... 357, 359
 - PM plus ... 31
 - Point mark area ... 146, 161
 - Product ID ... 24
 - Program ... 467
 - Program code ... 147, 149
 - Program counter setting ... 152
 - Program execution function ... 46

Program register ... 213
 Programmable IOR ... 54
 Project file ... 46, 102, 321
 Project File Load dialog box ... 113
 Project File Save dialog box ... 109
 Pull-Up / Pull-Down dialog box ... 399

Q

Qualify trace ... 53, 293
 Quick Watch dialog box ... 194

R

Range of radixes ... 466
 Real-time execution ... 47
 refresh ... 417, 447
 register ... 417, 448
 Register manipulation function ... 54
 Register Select dialog box ... 215
 Register window ... 212
 Registering debugger ... 31
 reset ... 417, 449
 Reset Debugger dialog box ... 317
 Right-click menu ... 68
 run ... 417, 450
 Run-Break event ... 55, 307

S

Save As dialog box ... 412
 Search window ... 354
 Section trace ... 53, 292
 Select mode ... 272, 278, 281, 284
 Selecting debugger ... 31
 Serial GUI window ... 402
 Setting event condition in each area ... 282
 Setting files ... 57
 Show offset ... 104
 Simulation functions ... 18, 35
 Simulation operation modes ... 19
 Simulator ... 20
 Snap data ... 298
 Snap Shot dialog box ... 296
 Snapshot function ... 53
 Source Move dialog box ... 135
 Source Path ... 100
 Source Search dialog box ... 157
 Source window ... 144
 Specification of scope ... 199
 Specifying Symbols ... 142
 Speed Option dialog box ... 414
 Stack frame ... 209, 468
 Start function ... 47, 152
 Start-up symbol ... 104
 Static status ... 61
 Status bar ... 87
 step ... 417, 451
 stop ... 417, 452
 Structure ... 468
 Stub dialog box ... 303
 Stub function ... 54
 Symbol To Address dialog box ... 141

Symbols ... 463
 Syntax error message ... 469, 474
 System register ... 213
 System simulator ... 18

T

Tab size ... 103
 Terminology ... 467
 Time measurement function ... 55
 Time tag ... 96, 230
 Timer event ... 55
 Timer Result dialog box ... 313
 Toolbar ... 69
 Trace condition ... 52
 Tracer control mode ... 235
 Trace Data Select dialog box ... 243
 Trace dialog box ... 290
 Trace function ... 51
 Trace memory ... 51
 Trace Move dialog box ... 138
 Trace Search dialog box ... 237
 Trace window ... 228
 Tracer control mode ... 52

U

Unconditional trace ... 52
 Uninstalling ... 27
 upload ... 417, 453
 Upload dialog box ... 126

V

V850 Simulator GUI Window ... 324
 V850 Simulator GUI window ... 28
 Verify check ... 97
 version ... 417, 454
 View file ... 56
 View File Load dialog box ... 119
 View File Save dialog box ... 115

W

Warning message ... 469, 494, 508
 Warning message or question message ... 469, 491
 watch ... 417, 455
 Watch function ... 55, 154
 Watch symbol setting ... 105
 Watch window ... 187
 where ... 417, 456
 Window lists ... 64
 Window reference ... 64
 wish ... 417, 457
 Write-protect break ... 51

X

xcoverage ... 417, 458
 xtime ... 418, 459
 xtrace ... 418, 460

Facsimile Message

Although NEC has taken all possible steps to ensure that the documentation supplied to our customers is complete, bug free and up-to-date, we readily accept that errors may occur. Despite all the care and precautions we've taken, you may encounter problems in the documentation. Please complete this form whenever you'd like to report errors or suggest improvements to us.

From:

Name

Company

Tel.

FAX

Address

Thank you for your kind support.

North America

NEC Electronics Inc.
Corporate Communications Dept.
Fax: +1-800-729-9288
+1-408-588-6130

Hong Kong, Philippines, Oceania

NEC Electronics Hong Kong Ltd.
Fax: +852-2886-9022/9044

Asian Nations except Philippines

NEC Electronics Singapore Pte. Ltd.
Fax: +65-250-3583

Europe

NEC Electronics (Europe) GmbH
Technical Documentation Dept.
Fax: +49-211-6503-274

Korea

NEC Electronics Hong Kong Ltd.
Seoul Branch
Fax: +82-2-528-4411

Japan

NEC Semiconductor Technical Hotline
Fax: +81- 44-435-9608

South America

NEC do Brasil S.A.
Fax: +55-11-6462-6829

Taiwan

NEC Electronics Taiwan Ltd.
Fax: +886-2-2719-5951

I would like to report the following error/make the following suggestion:

Document title: _____

Document number: _____ Page number: _____

If possible, please fax the referenced page or drawing.

Document Rating	Excellent	Good	Acceptable	Poor
Clarity	<input type="checkbox"/>	<input type="checkbox"/>	<input type="checkbox"/>	<input type="checkbox"/>
Technical Accuracy	<input type="checkbox"/>	<input type="checkbox"/>	<input type="checkbox"/>	<input type="checkbox"/>
Organization	<input type="checkbox"/>	<input type="checkbox"/>	<input type="checkbox"/>	<input type="checkbox"/>