

## Renesas RA Family

## Getting Started with the Graphics Application

### Introduction

This application note describes creation of an application that uses Graphical User Interfaces with an EK-RA6M3G kit, referred to as 'graphics application'. This application is geared towards providing a reference for developing complex multi-threaded applications with a touch screen graphical Human Machine Interface (HMI) by using the Renesas Flexible Software Package (FSP) and SEGGER AppWizard.

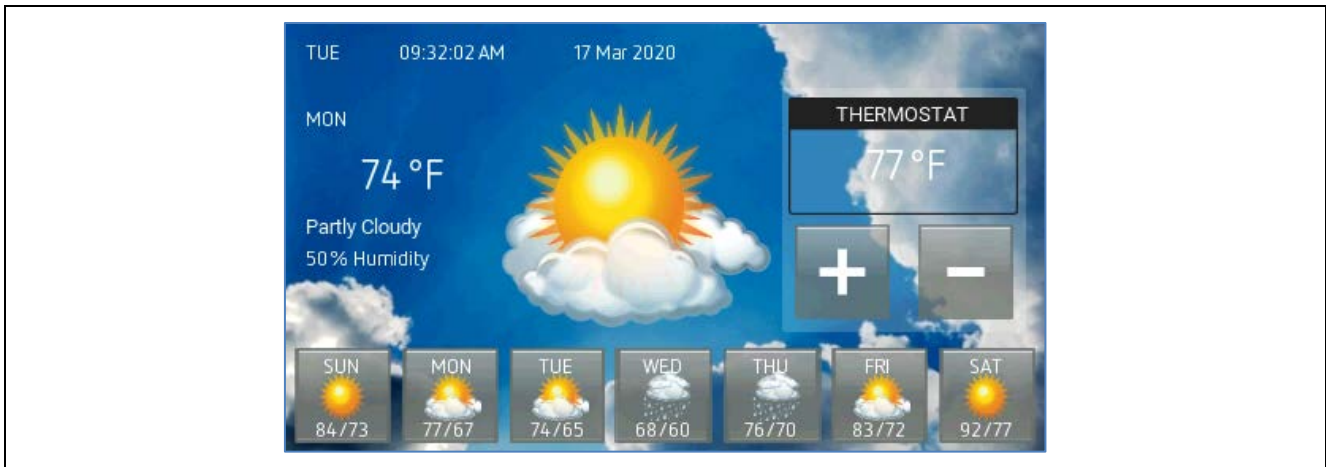

**Figure 1. Weather Panel of the Graphics Application on Renesas EK-RA6M3G**

This application is developed using the Renesas RA Flexible Software Package (FSP), which provides a quick and versatile way to build secure connected Internet of Things (IoT) devices using the Renesas RA family of Arm®-based microcontrollers (MCUs). RA FSP provides production ready peripheral drivers to take advantage of the RA FSP ecosystem along with SEGGER emWin library and FreeRTOS. In addition, Ethernet, USB, and file system stacks support are also available. This powerful suite of tools provides a comprehensive, integrated framework for rapid development of complex embedded applications.

This application note assumes that you are familiar with the concepts associated with writing multi-threaded applications under a Real Time Operating System (RTOS) environment, such as FreeRTOS. This application note makes use of RTOS features such as threads and semaphores. Knowledge of operating these with FreeRTOS can help in understanding the supplied application project in source. For more detailed information on FreeRTOS features, refer to the FreeRTOS User Manual.

The graphics application is developed using the Renesas e<sup>2</sup> studio Integrated Development Environment (IDE). This e<sup>2</sup> studio is a free application that you can download from the Renesas website. While building applications under the Renesas FSP Platform is considerably faster than developing similar applications in other environments, there is still a learning curve to understand the steps necessary to construct complex multi-threaded HMI applications quickly. This application note walks you through all the steps necessary, including the following:

- Board setup.
- Application overview.
- Detailed explanation uses of the graphical screens.
- SEGGER AppWizard project integration.
- SEGGER AppWizard interactions setup.
- Adding an emWin widget that is not yet available in AppWizard.
- FSP configuration.
- Application design highlights.
- Using the General-Purpose Timer to drive a PWM backlight control signal.
- Importing, loading, and running the project.

## Required Resources

### Development tools and software

- e<sup>2</sup> studio v2024-01.1
- Renesas Flexible Software Package (FSP) v5.2.0
- AppWizard V1.42\_6.36

### Hardware

- Renesas EK-RA6M3G kit (RA6M3 MCU Group)  
(<https://www.renesas.com/us/en/products/software-tools/boards-and-kits/eval-kits/ek-ra6m3g.html>)

## Reference Manuals

- RA Flexible Software Package Documentation Release v5.2.0
- AppWizard User Guide & Reference Manual Version 1.42\_6.36
- emWin User Guide & Reference Manual Version 6.36
- Renesas RA6M3 Group User's Manual Rev.1.20
- EK-RA6M3G-v1.0 Schematics

## Contents

|  |    |
|--|----|
| 1. Board Setup .....   | 4  |
| 2. Application Overview .....                                    | 5  |
| 2.1 RA6M3 MCU Peripherals used by the Graphics Application ..... | 5  |
| 2.2 Human-Machine Interface (HMI) .....                          | 6  |
| 2.3 Graphics Application Panels .....                            | 7  |
| 3. AppWizard Overview .....                                      | 7  |
| 3.1 Create New Project Using the AppWizard .....                 | 10 |
| 3.2 Design Weather Panel Buttons Using AppWizard .....           | 12 |
| 3.3 Setup AppWizard Interactions.....                            | 13 |
| 3.4 Add emWin Widget to AppWizard Project.....                   | 14 |
| 4. Understanding the Graphics Application .....                  | 14 |
| 4.1 Source Code Layout.....                                      | 14 |
| 4.2 Application Block Diagram .....                              | 16 |
| 4.3 Thread Overview .....  | 17 |
| 4.3.1 emWin Thread.....  | 17 |
| 4.3.2 Touch Thread .....   | 18 |
| 5. FSP Configuration .....                                       | 18 |
| 5.1 Components Tab .....   | 19 |
| 5.2 Stacks Tab.....  | 20 |
| 5.3 Thread Objects .....   | 22 |
| 5.4 Module Configuration .....                                   | 23 |
| 5.4.1 GLCDC Configuration .....                                  | 23 |

---

|       |  |    |
|-------|--|----|
| 5.4.2 | TCON Configuration .....                             | 24 |
| 5.4.3 | Touch Controller Configuration .....                 | 27 |
| 5.4.4 | PWM Configuration .....                              | 29 |
| 6.    | Application Code Highlights .....                    | 32 |
| 6.1   | Threads and Main.....                                | 32 |
| 6.1.1 | AppWizard/emWin Initialization.....                  | 33 |
| 6.1.2 | emWin Events and Messages.....                       | 33 |
| 6.1.3 | AppWizard Variables.....                             | 34 |
| 7.    | Importing and Building the Project .....             | 35 |
| 8.    | Downloading the Executable to the EK-RA6M3G Kit..... | 35 |
| 9.    | e <sup>2</sup> studio Tricks .....                   | 36 |
| 10.   | Website and Support .....                            | 38 |
|       | Revision History.....                                | 39 |

### 1. Board Setup

The EK-RA6M3G kit contains a few switch settings which must be configured prior to running the application associated with this application note. In addition to these switch settings, the boards also contain a USB debug port and connectors to access the J-Link® programming interface.

**Table 1. Switch Settings for EK-RA6M3G**

| Switch | Setting            |
|--------|--------------------|
| J8     | Jumper on pins 1-2 |
| J9     | Open               |

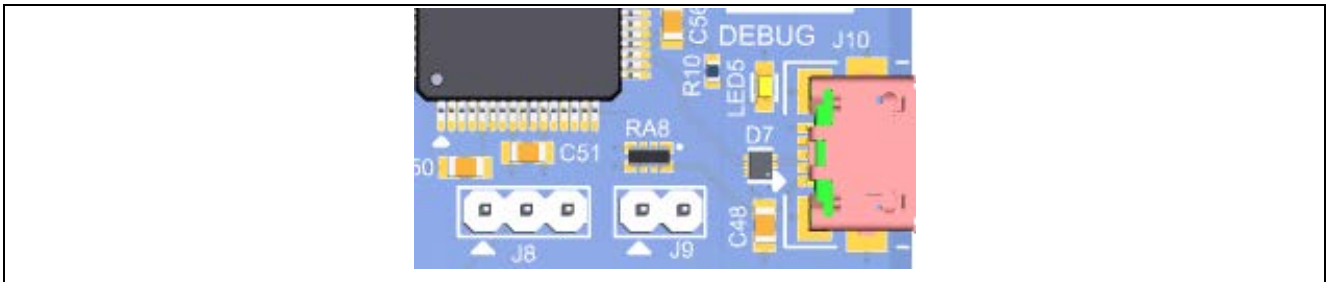

**Figure 2. J8 and J9 on EK-RA6M3**

The EK-RA6M3G kit consists of two boards: the EK-RA6M3 board featuring the RA6M3 MCU with an on-chip Graphics LCD Controller and a Graphics Expansion Board featuring a 4.3-inch 480 x 272-pixel TFT color LCD with capacitive touch overlay. The GPIO port pin driving the backlight controller is capable of PWM output using a timer peripheral in the MCU. As a result, the intensity of the LED backlight can be adjusted by the RA6M3 MCU.

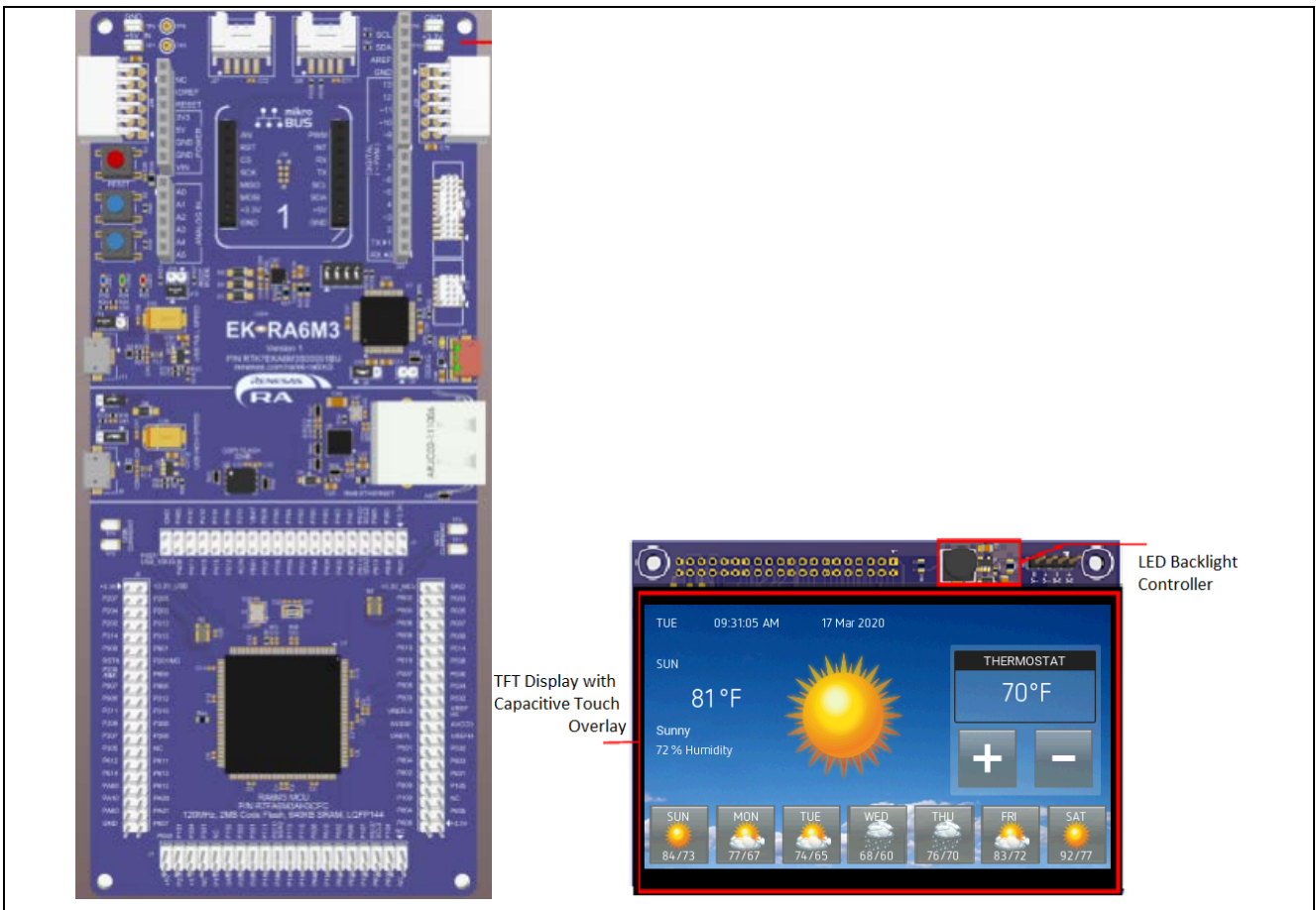

**Figure 3. EK-RA6M3G Kit**

## 2. Application Overview

One of the key goals of the provided graphics application is to demonstrate how to build applications which require complex HMI screens using SEGGER AppWizard and emWin library. The following list highlights all the key features of the graphics application:

- Complex HMI design using AppWizard.
- Multi-threaded applications using the FreeRTOS
  - Semaphore object.
- GLCDC configuration
  - Framebuffer configuration.
  - TCON configuration.
- Touch Panel, I2C touch controller driver ft5 x 06.
  - External IRQ mapping required.

In any software design, there are many ways to solve the same problem. The solution given in this application note is one approach.

### 2.1 RA6M3 MCU Peripherals used by the Graphics Application

The graphics application is complex and it uses the Renesas RA6M3 MCU. This MCU is built around an Arm® Cortex®-M4 device. Developing complex microcontroller-based applications is usually a multi-step process:

1. The first step usually involves gathering the application requirements and performing a high-level system design that maps the requirements onto the set of hardware components. The components are necessary to fulfill those requirements including the target MCU that will be used in the design, the tool chains required to build/debug the applications, and so forth.
2. The next step usually determines which on-board peripherals of the target MCU are used. In this step, it is often necessary to spend a considerable amount of time understanding the register map of the on-board peripherals and writing lower-level driver code necessary to expose the peripheral to the upper level application code. Most of this work has already been done in the FSP, considerably streamlining application development.
3. In addition to the on-board peripherals of the target MCU, the design often encompasses external hardware and how it is controlled. As an example, the EK-RA6M3G has the Graphics Expansion board, which is controlled directly by the on-chip Graphics LCD Controller (GLCDC) of the RA6M3 MCU.
4. The last step usually details how an application will be structured on top of the selected hardware to accomplish the initial requirements.

The graphics application requirements were first mapped to the on-board peripherals of the EK-RA6M3G kit. Figure 4 shows all the internal hardware peripherals used by the graphics application. This application note describes how each of these peripherals is configured using the FSP, and the considerations that were used for each peripheral as the application is being developed.

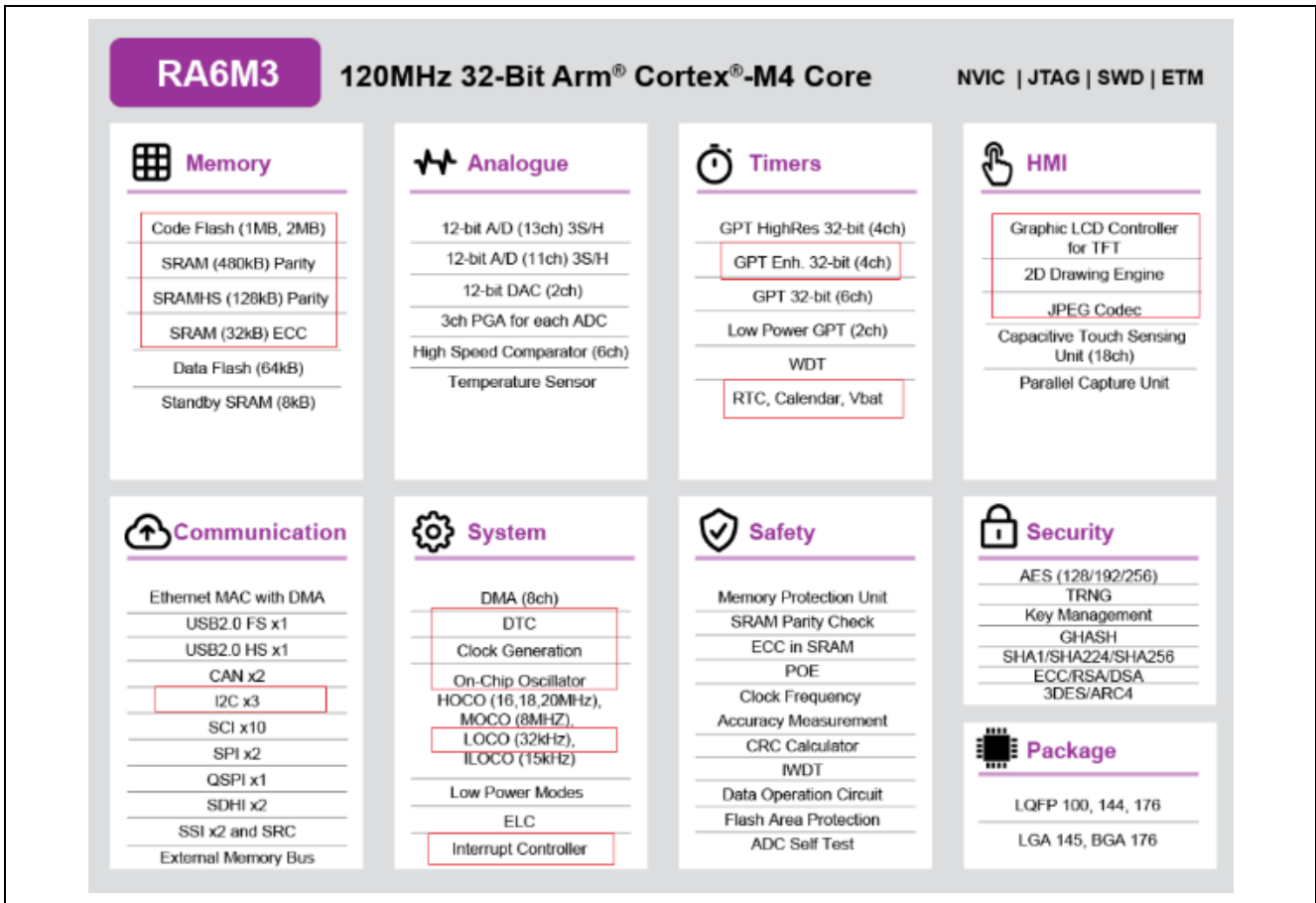

Figure 4. RA6M3 MCU Peripherals Used in the Graphics Application

## 2.2 Human-Machine Interface (HMI)

In many HMI applications, the most daunting task may be the GUI itself. In applications requiring a graphical HMI, it is generally considered best practice to separate the business logic from presentation. This abstracts the GUI from making decisions on what to display. Instead, it is now only concerned about how to display it. It relies on external logic to tell it what to display and when to display it.

Once you have gathered the requirements, achieved a top-level design, and identified the hardware necessary to implement that design, it is often beneficial to construct a GUI (Graphical User Interface) to help quickly communicate the look and feel of the system to others. This is where the SEGGER AppWizard comes into play.

The FSP natively supports the use of AppWizard and emWin library from SEGGER. You may choose to use emWin primitive calls directly in your application or choose to use the AppWizard to design your screens. AppWizard is a stand-alone tool that provides a point and click environment for generating all the screens necessary for your embedded application. Once designed, the tool outputs .c and .h files, which you then include into your application. All the application screens in the graphics application were built using the AppWizard.



### 2.3 Graphics Application Panels

The graphics application consists of two graphical panels, **Weather Panel**, and **Logging Panel**. In this application, we build separate static display designs for these two panels. The screen resolution on the EK-RA6M3G kit is 480 x 272 pixels.

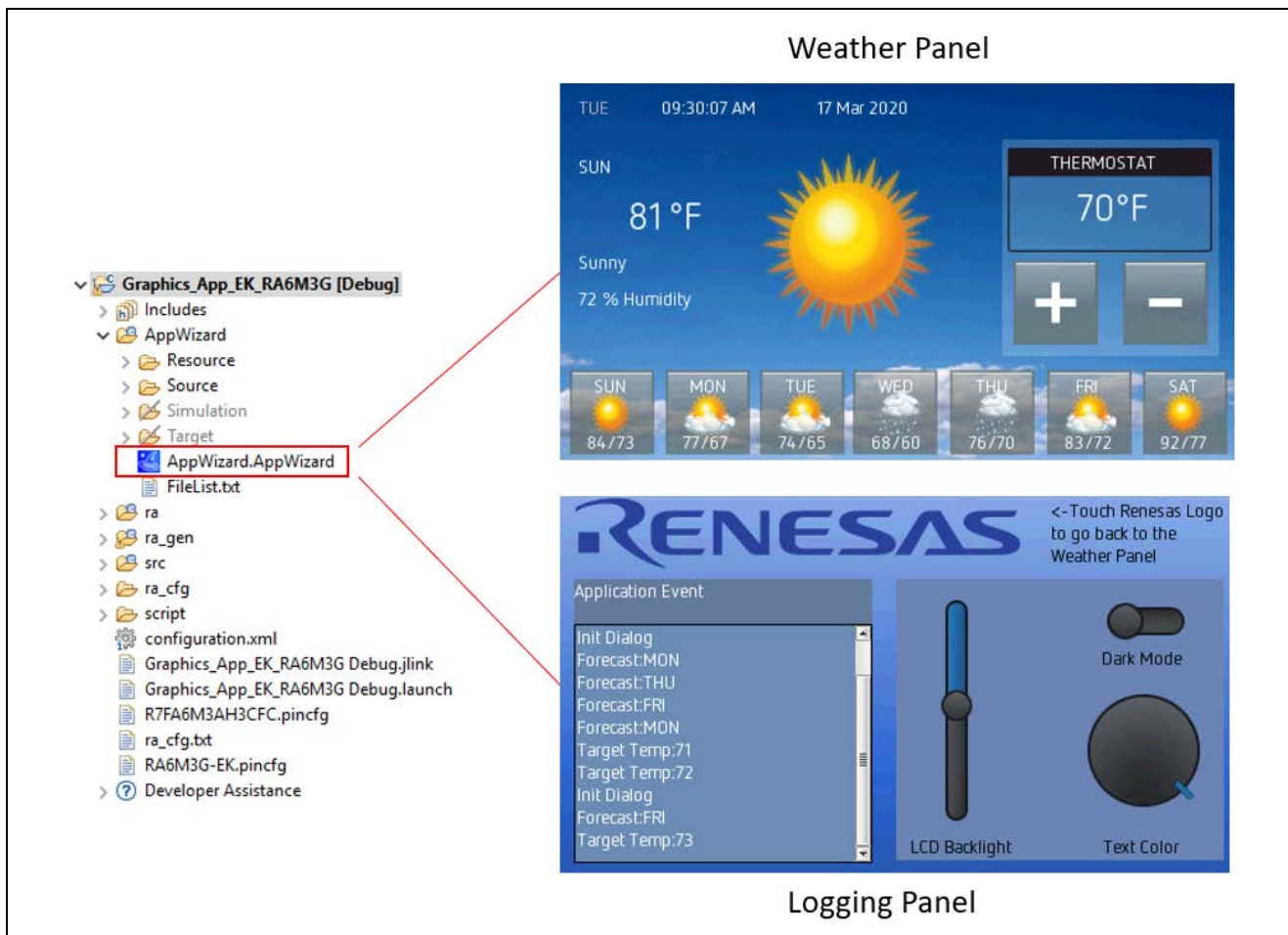

Figure 5. Screenshot of the Graphics Application

- Weather Panel** This is the first screen that appears on the kit on boot up. It shows Weather forecasts by selecting days or increase/decrease Temperature.
- Logging Panel** This panel shows events that occur in the **Weather Panel**, adjusts LCD backlight, or text color and background color of the Logging Editor.

### 3. AppWizard Overview

This section provides an overview of how graphical screens are designed and integrated into an FSP application using the AppWizard and emWin library. It is not meant as a replacement for the AppWizard or emWin documentation. When designing graphical interfaces for the Renesas FSP platform, you are encouraged to refer to the documentation for the AppWizard and emWin library.

The AppWizard presents a graphical point and click environment that allows you to quickly create all the screens needed for your embedded application. You can specify the screen resolution, color depth, and various other parameters such that what you see in the AppWizard that is running on your PC is what you will get on your embedded screens.

The AppWizard comes as a standard with some fonts and basic graphics for interfaces such as image, text, button, rotary, slider, and so forth. During your screen creation phase, you may provide the AppWizard with your own external images and font files to make your displays as fancy as needed.



**Figure 6. Screenshot of the Weather Panel being designed in the AppWizard**

The organization of the AppWizard is straightforward. The top center window, known as the **Editor** window, contains the screen being designed. On the upper left corner, you will find the **Add objects** window. This window shows the supported window objects in the AppWizard. It allows you to click on the object icons, and drag and place them in the Editor window. On the center left is **Hierarchic tree** window. The order in which you add items in the same level/parent determines the order that they are drawn in the final screens, so some planning is necessary. However, you still can change the order by using drag and drop or the **Move Up** and **Move Down** buttons. As is the case with most graphical design environments, screens are laid out in a hierarchy where the main window is usually the parent and all graphical objects contained in the window are children of that parent. The **Properties** window on the right side displays properties associated with a selected object. You may select objects from the **Hierarchic tree** window or from the **Editor** window.

The bottom left of the AppWizard screen contains **Quick Access Buttons** for managing resources such as Texts, Fonts, Images, Animations and Variables you used to create and interact with the screens. AppWizard supports multi-language designs as well.

The key to making any graphical design interactive is to associate events like button touches with the event handling code that implements the appropriate functionality. The **Interactions** window on the bottom center makes it easy for you to define the application's behavior on certain actions. These interactions can be done without any extra code, but AppWizard allows you to add your code to handle these actions and respond to GUI events.



| Interactions |   |                     |               |            |                          |  |
|--------------|---|---------------------|---------------|------------|--------------------------|--|
| +/-          |   | Emitter             | Signal        | Job        | Receiver                 | Comment  |
| X            | / | ID_SCREEN_MAIN      | INITDIALOG    | SETVIS     | ID_IMAGE_SUN_PRESSED     | Hide this image                                |
| X            | / | ID_SCREEN_MAIN      | INITDIALOG    | SETVIS     | ID_IMAGE_SUN             | Show this image                                |
| X            | / | ID_SCREEN_MAIN      | INITDIALOG    | SETVIS     | ID_IMAGE_MON_PRESSED     | Hide this image                                |
| X            | / | ID_SCREEN_MAIN      | INITDIALOG    | SETVIS     | ID_IMAGE_MON             | Show this image                                |
| X            | / | ID_SCREEN_MAIN      | INITDIALOG    | SETVIS     | ID_IMAGE_TUE_PRESSED     | Hide this image                                |
| X            | / | ID_SCREEN_MAIN      | INITDIALOG    | SETVIS     | ID_IMAGE_TUE             | Show this image                                |
| X            | / | ID_SCREEN_MAIN      | INITDIALOG    | SETVIS     | ID_IMAGE_WED_PRESSED     | Hide this image                                |
| X            | / | ID_SCREEN_MAIN      | INITDIALOG    | SETVIS     | ID_IMAGE_WED             | Show this image                                |
| X            | / | ID_SCREEN_MAIN      | INITDIALOG    | SETVIS     | ID_IMAGE_THU_PRESSED     | Hide this image                                |
| X            | / | ID_SCREEN_MAIN      | INITDIALOG    | SETVIS     | ID_IMAGE_THU             | Show this image                                |
| X            | / | ID_SCREEN_MAIN      | INITDIALOG    | SETVIS     | ID_IMAGE_FRI_PRESSED     | Hide this image                                |
| X            | / | ID_SCREEN_MAIN      | INITDIALOG    | SETVIS     | ID_IMAGE_FRI             | Show this image                                |
| X            | / | ID_SCREEN_MAIN      | INITDIALOG    | SETVIS     | ID_IMAGE_SAT_PRESSED     | Hide this image                                |
| X            | / | ID_SCREEN_MAIN      | INITDIALOG    | SETVIS     | ID_IMAGE_SAT             | Show this image                                |
| X            | / | ID_SCREEN_MAIN      | INITDIALOG    | SETVALUE   | ID_VAR_TARGET_TEMP       | Set default value                              |
| X            | / | ID_VAR_TIME_UPDATE  | VALUE_CHANGED |            |                          | Update time when this changed                  |
| X            | / | ID_VAR_TARGET_TEMP  | VALUE_CHANGED | SETVALUE   | ID_TEXT_TARGET_TEMP      | Set Thermostat Target temp                     |
| X            | / | ID_BUTTON_TEMP_UP   | CLICKED       | ADDVALUE   | ID_VAR_TARGET_TEMP       | Increase Thermostat target temp                |
| X            | / | ID_BUTTON_TEMP_DOWN | CLICKED       | ADDVALUE   | ID_VAR_TARGET_TEMP       | Reduce Thermostat target temp                  |
| X            | / | ID_BUTTON_SUN       | CLICKED       | SETVIS     | ID_IMAGE_SUN             | Toggle visibility                              |
| X            | / | ID_BUTTON_SUN       | CLICKED       | SETVIS     | ID_IMAGE_SUN_PRESSED     | Toggle visibility                              |
| X            | / | ID_BUTTON_SUN       | CLICKED       | SETCOORD   | ID_IMAGE_ANIM_CLOUD_M... | Set coordinate                                 |
| X            | / | ID_BUTTON_SUN       | RELEASED      | SETVIS     | ID_IMAGE_SUN             | Toggle visibility                              |
| X            | / | ID_BUTTON_SUN       | RELEASED      | SETVIS     | ID_IMAGE_SUN_PRESSED     | Toggle visibility                              |
| X            | / | ID_BUTTON_MON       | CLICKED       | SETVIS     | ID_IMAGE_MON             | Toggle visibility                              |
| X            | / | ID_BUTTON_MON       | CLICKED       | SETVIS     | ID_IMAGE_MON_PRESSED     | Toggle visibility                              |
| X            | / | ID_BUTTON_MON       | CLICKED       | ANIMCREATE |                          | Custom function to stop and remove cloudy ANIM |
| X            | / | ID_BUTTON_MON       | CLICKED       | ANIMCREATE |                          | Create and start cloudy ANIM                   |
| X            | / | ID_BUTTON_MON       | RELEASED      | SETVIS     | ID_IMAGE_MON             | Toggle visibility                              |
| X            | / | ID_BUTTON_MON       | RELEASED      | SETVIS     | ID_IMAGE_MON_PRESSED     | Toggle visibility                              |
| X            | / | ID_BUTTON_TUE       | CLICKED       | SETVIS     | ID_IMAGE_TUE             | Toggle visibility                              |
| X            | / | ID_BUTTON_TUE       | CLICKED       | SETVIS     | ID_IMAGE_TUE_PRESSED     | Toggle visibility                              |
| X            | / | ID_BUTTON_TUE       | CLICKED       | ANIMCREATE |                          | Custom function to stop and remove cloudy ANIM |
| X            | / | ID_BUTTON_TUE       | CLICKED       | ANIMCREATE |                          | Create and start cloudy ANIM                   |
| X            | / | ID_BUTTON_TUE       | RELEASED      | SETVIS     | ID_IMAGE_TUE             | Toggle visibility                              |
| X            | / | ID_BUTTON_TUE       | RELEASED      | SETVIS     | ID_IMAGE_TUE_PRESSED     | Toggle visibility                              |
| X            | / | ID_BUTTON_WED       | CLICKED       | SETVIS     | ID_IMAGE_WED             | Toggle visibility                              |
| X            | / | ID_BUTTON_WED       | CLICKED       | SETVIS     | ID_IMAGE_WED_PRESSED     | Toggle visibility                              |
| X            | / | ID_BUTTON_WED       | CLICKED       | SETCOORD   | ID_IMAGE_ANIM_CLOUD_M... | Set coordinate                                 |
| X            | / | ID_BUTTON_WED       | RELEASED      | SETVIS     | ID_IMAGE_WED             | Toggle visibility                              |
| X            | / | ID_BUTTON_WED       | RELEASED      | SETVIS     | ID_IMAGE_WED_PRESSED     | Toggle visibility                              |
| X            | / | ID_BUTTON_THU       | CLICKED       | SETVIS     | ID_IMAGE_THU             | Toggle visibility                              |
| X            | / | ID_BUTTON_THU       | CLICKED       | SETVIS     | ID_IMAGE_THU_PRESSED     | Toggle visibility                              |
| X            | / | ID_BUTTON_THU       | CLICKED       | SETCOORD   | ID_IMAGE_ANIM_CLOUD_M... | Set coordinate                                 |

Figure 7. AppWizard Interactions Window

### 3.1 Create New Project Using the AppWizard

The **Create New Project** dialog box is as shown in Figure 8. This dialog box is where you specify the project specific information such as the basic display settings as well as the path information for where AppWizard locates the files that result from the **Export & Save** process. The AppWizard also generates a simulation project in the folder `\Simulation` located in the project folder.

When you perform **Export & Save**, the AppWizard creates `.c` and `.h` files that contain all the information necessary to render the screens you built with AppWizard on the LCD in your embedded application. The **Project Path** is where you specify the default output directory for the Source, Header, and Resource files.

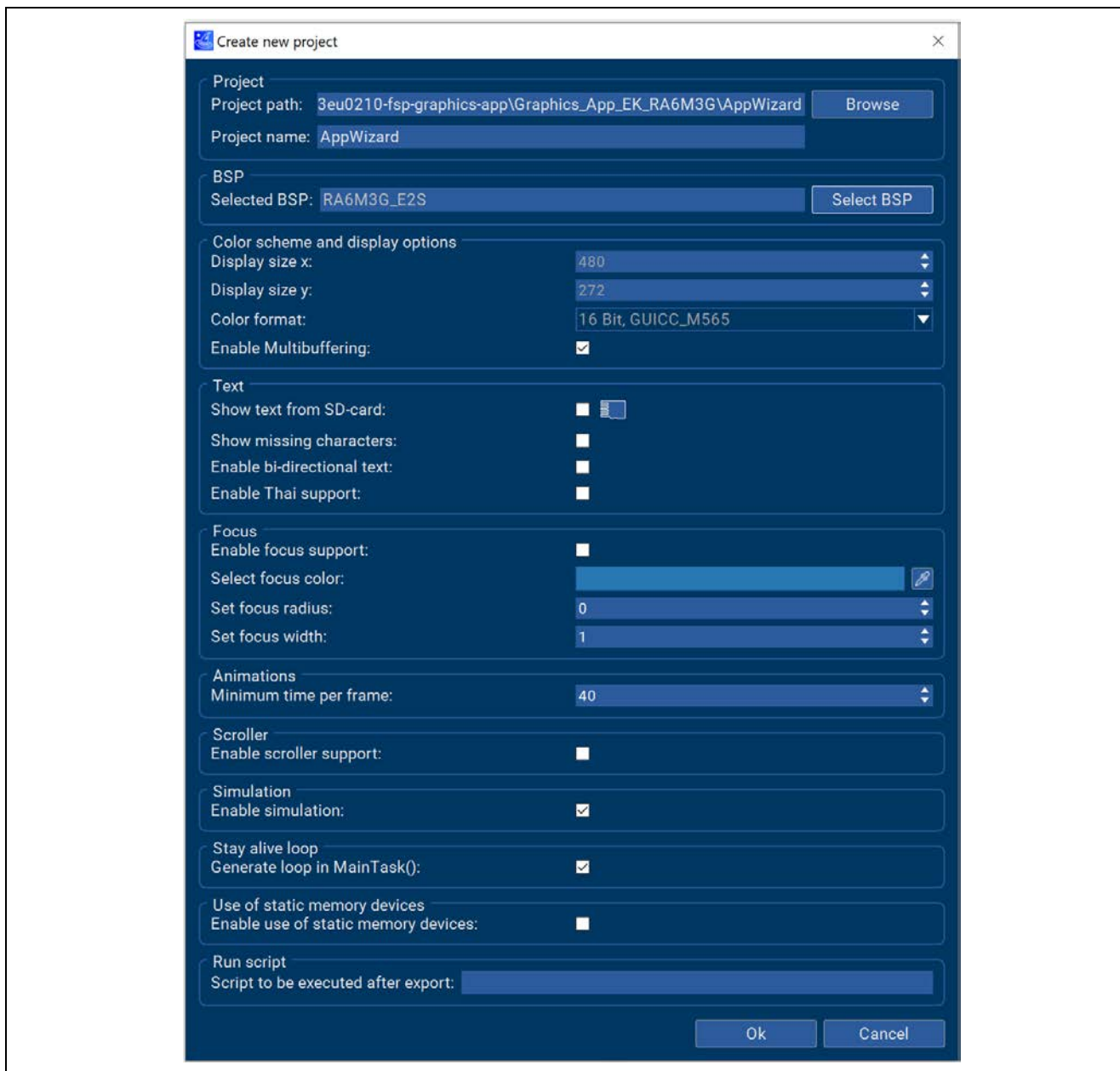

**Figure 8. Create New Project Dialog Box**

It is a good practice to save the Source, Header, and Resource files relative to the e<sup>2</sup> studio location. This makes it easy to move projects from one location to another or from one PC to another. In the case of the graphics application, you can see that all the directories are located under the AppWizard folder in the project directory created by e<sup>2</sup> studio. We recommend creating the e<sup>2</sup> studio project first, then creating the AppWizard folder as an e<sup>2</sup> studio source folder before creating an AppWizard project named AppWizard under the e<sup>2</sup> studio project folder.

After generating the AppWizard, you should exclude the Simulation and Target folders from Build before building the e<sup>2</sup> studio project. All the necessary library and header files for the target board are generated after you finish adding the emWin stack to your e<sup>2</sup> studio project.

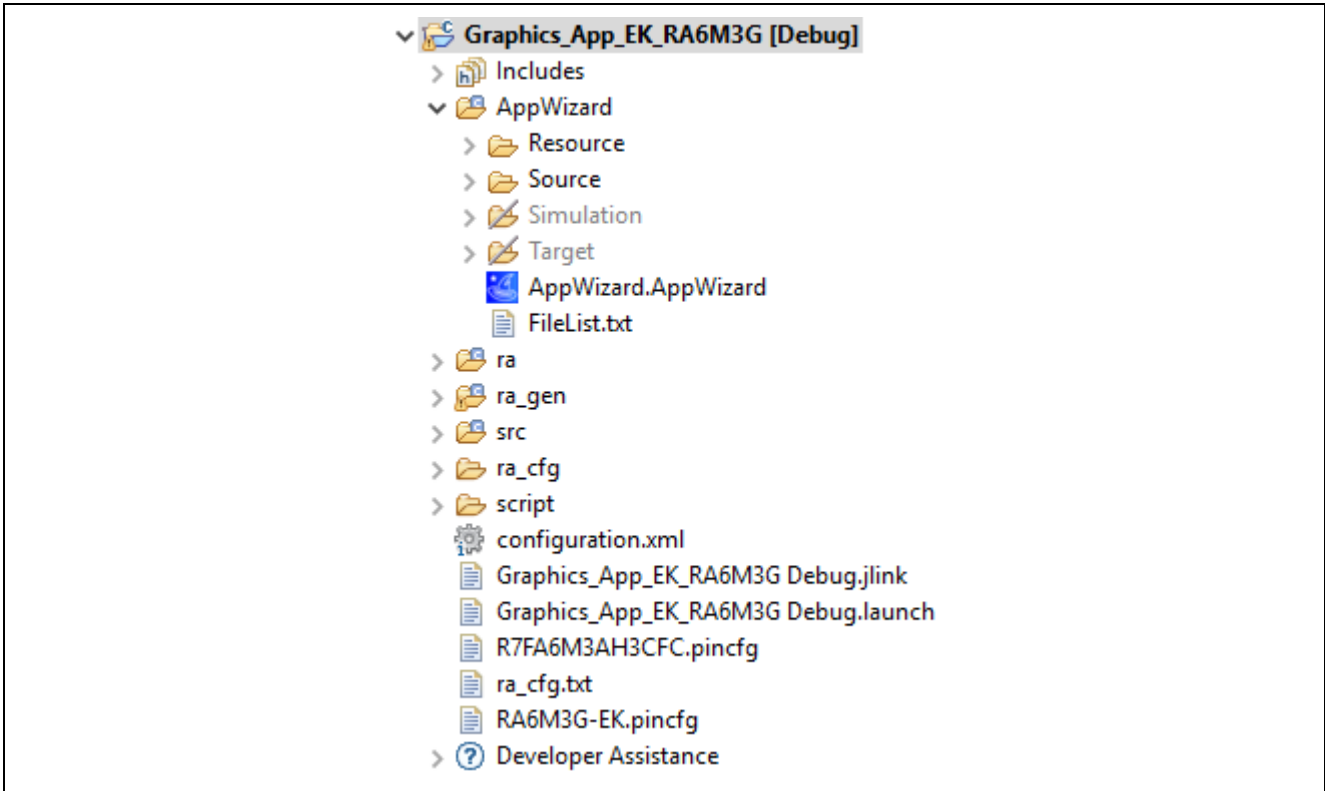

Figure 9. AppWizard Project File View in the Graphics Application Folder

Go to **Project > Properties > C/C++ Build > Settings > GNU ARM Cross C Compiler > Includes** to add the newly created AppWizard folder and its subfolders to the e<sup>2</sup> studio project include path as shown in Figure 10.

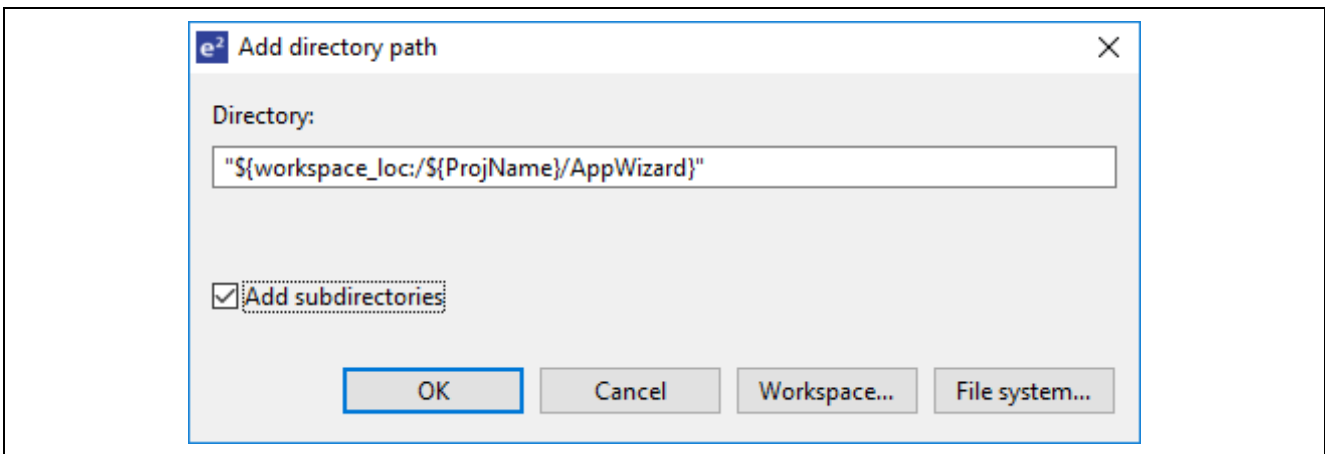

Figure 10. Adding the AppWizard Folder to the e<sup>2</sup> studio Project Include Path

### 3.2 Design Weather Panel Buttons Using AppWizard

The AppWizard User Manual and Quick Start Guide cover basic designs. The **Weather Panel** buttons, on the other hand, are more complex and are the target of this application note. These buttons are grouped in a Window widget that includes multiple objects. For example, the window ID\_WINDOW\_SUN consists of:

- ID\_WINDOW\_SUN  
— Window widget. The place holder to group the other widgets.
- ID\_MAGE\_SUN\_PRESSED  
— Image widget. Visible when the ID\_BUTTON\_SUN pressed, invisible when the ID\_BUTTON\_SUN released. Set bitmap using `bottom_button_trans_pressed.png`.

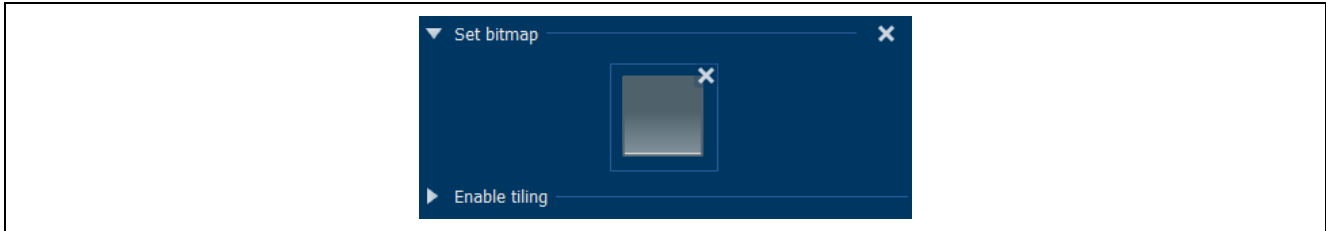

Figure 11. ID\_MAGE\_SUN\_PRESSED Bitmap Setting

- ID\_IMAGE\_SUN  
— Image widget. Invisible when the ID\_BUTTON\_SUN is pressed, visible when the ID\_BUTTON\_SUN released. Set bitmap using `bottom_button_trans.png`.

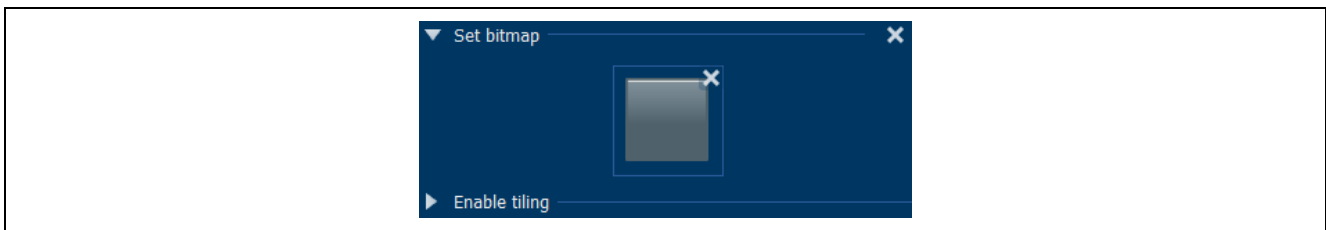

Figure 12. ID\_IMAGE\_SUN Bitmap Setting

- ID\_IMAGE\_SUNNY\_SUN  
— Image widget. Sunny icon. Set bitmap using `icon_sunny.png`.



Figure 13. ID\_IMAGE\_SUNNY\_SUN Bitmap Setting

- ID\_TEXT\_SUN  
— Text widget. The “SUN” text.
- ID\_TEXT\_SUN\_RANGE  
— Text widget. Shows temperature range.
- ID\_BUTTON\_SUN  
— Button widget. A transparent button without a bitmap image, placed on top of the other widgets. Some AppWizard interaction setups must be in place to create button pressed/release impression.

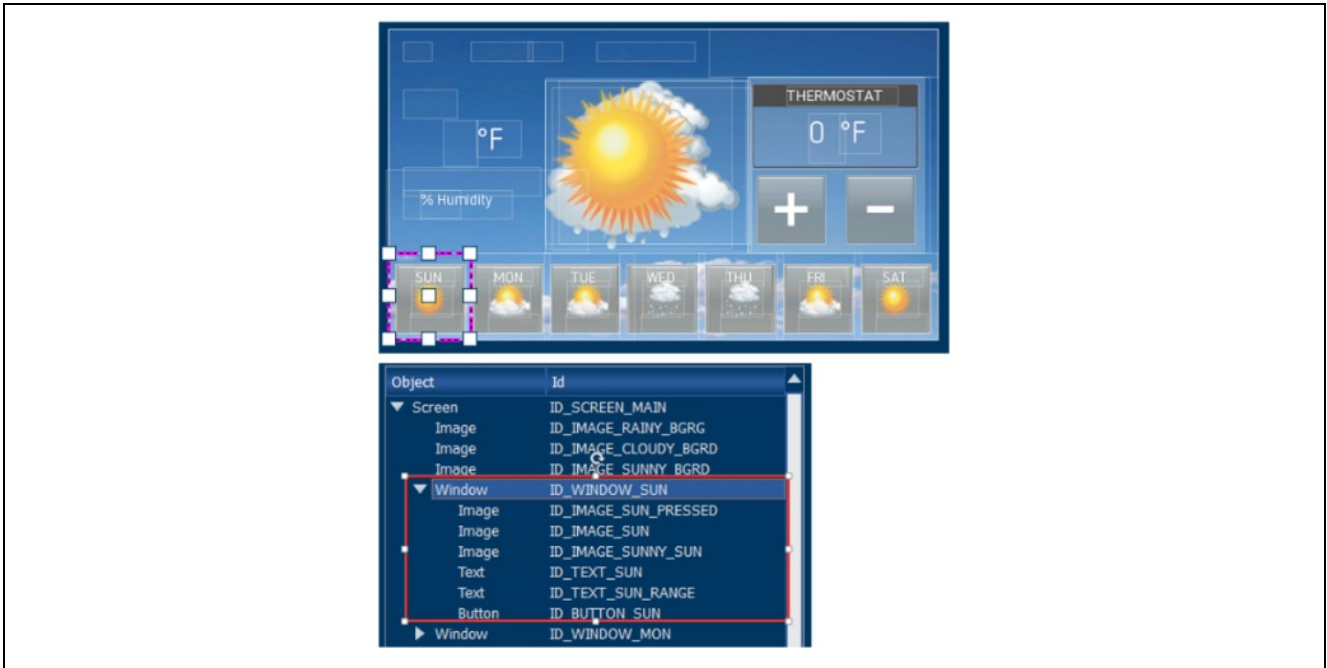

Figure 14. Design of the SUN Button Group

### 3.3 Setup AppWizard Interactions

Set the following interaction for the ID\_BUTTON\_SUN to create the button pressed/release as mentioned earlier in the Weather Panel Button Design section:

- The ID\_IMAGE\_SUN widget is invisible, toggling from visible to invisible when the transparent ID\_BUTTON\_SUN pressed.
- The ID\_IMAGE\_SUN widget is visible, toggling from invisible to visible when the transparent ID\_BUTTON\_SUN released.

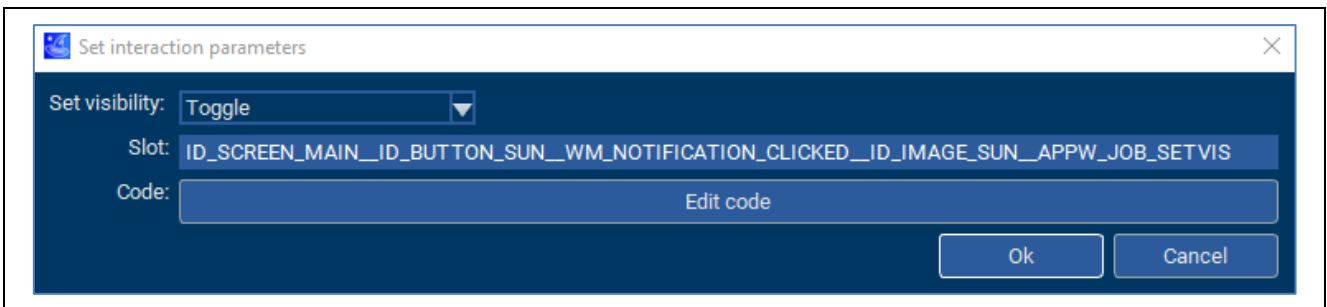

Figure 15. ID\_BUTTON\_SUN Interaction When Clicked

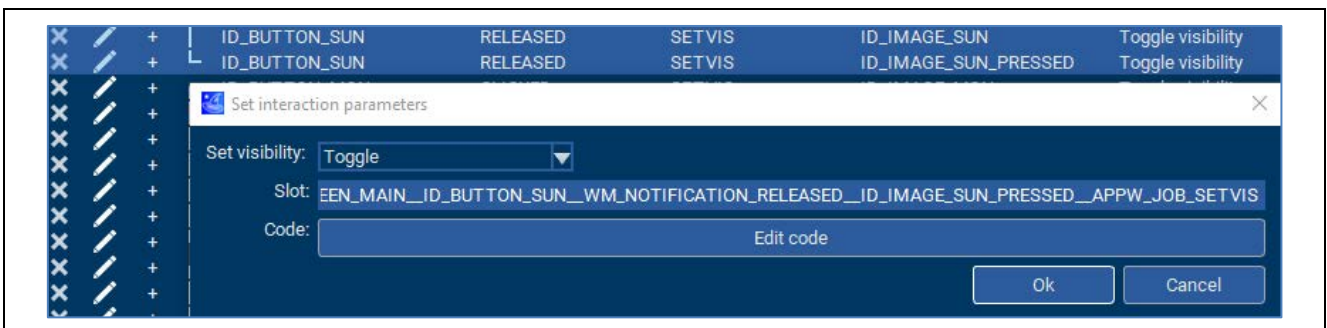

Figure 16. ID\_BUTTON\_SUN Interaction When Released



### 3.4 Add emWin Widget to AppWizard Project

You may need to use an emWin widget that is not yet supported by the AppWizard or need to create one in your custom code. The AppWizard allows that capability via the emWin API calls.

The **Logging Panel** in this graphics application features a Logging dialog created by using the Multiline Text widget.

The steps to add an emWin widget to AppWizard project are as follows:

- Create an emWin widget by using emWin APIs in the slot routine for the AppWizard screen in the CustomCode folder.
- Handle GUI events/message if needed via slot routines in the file <ScreenID > \_Slots.c located in the \AppWizard\Source\CustomCode folder.
- Figure 17 shows the function that creates the Multiline Text widget by using MULTIEDIT\_CreateEx API and other APIs.

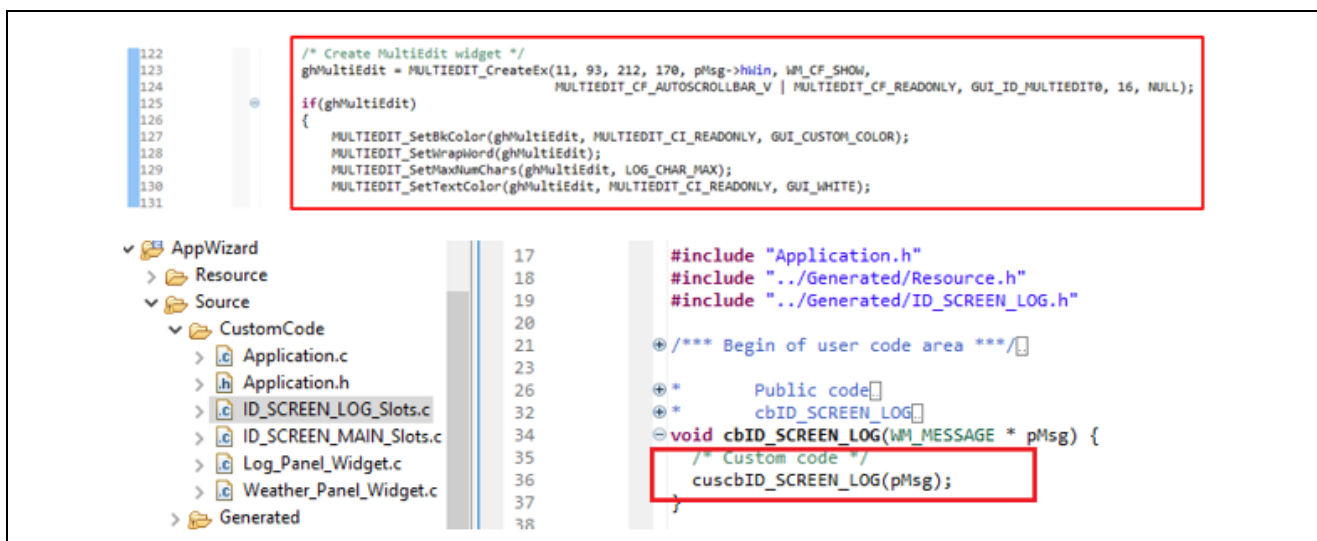

Figure 17. Adding Multiline Text Widget to AppWizard Application by using emWin APIs

## 4. Understanding the Graphics Application

While the HMI is certainly a large part of understanding any HMI application, there are many other areas that you must understand while developing with the Renesas FSP applications. These include how the project is physically structured in e<sup>2</sup> studio, how threads and thread resources are added to the project, how threads communicate, the state machine design, and how state data is shared among cooperating threads, and especially emWin thread.

### 4.1 Source Code Layout

Prior to diving into the actual application code, it is best to first understand the overall source code layout of an FSP project. Renesas FSP applications generally consist of two different types of code, your code, and auto-generated code. The auto-generated code can be further broken down into two sub-categories, code that is auto-generated by the FSP, and code that is auto-generated by AppWizard.

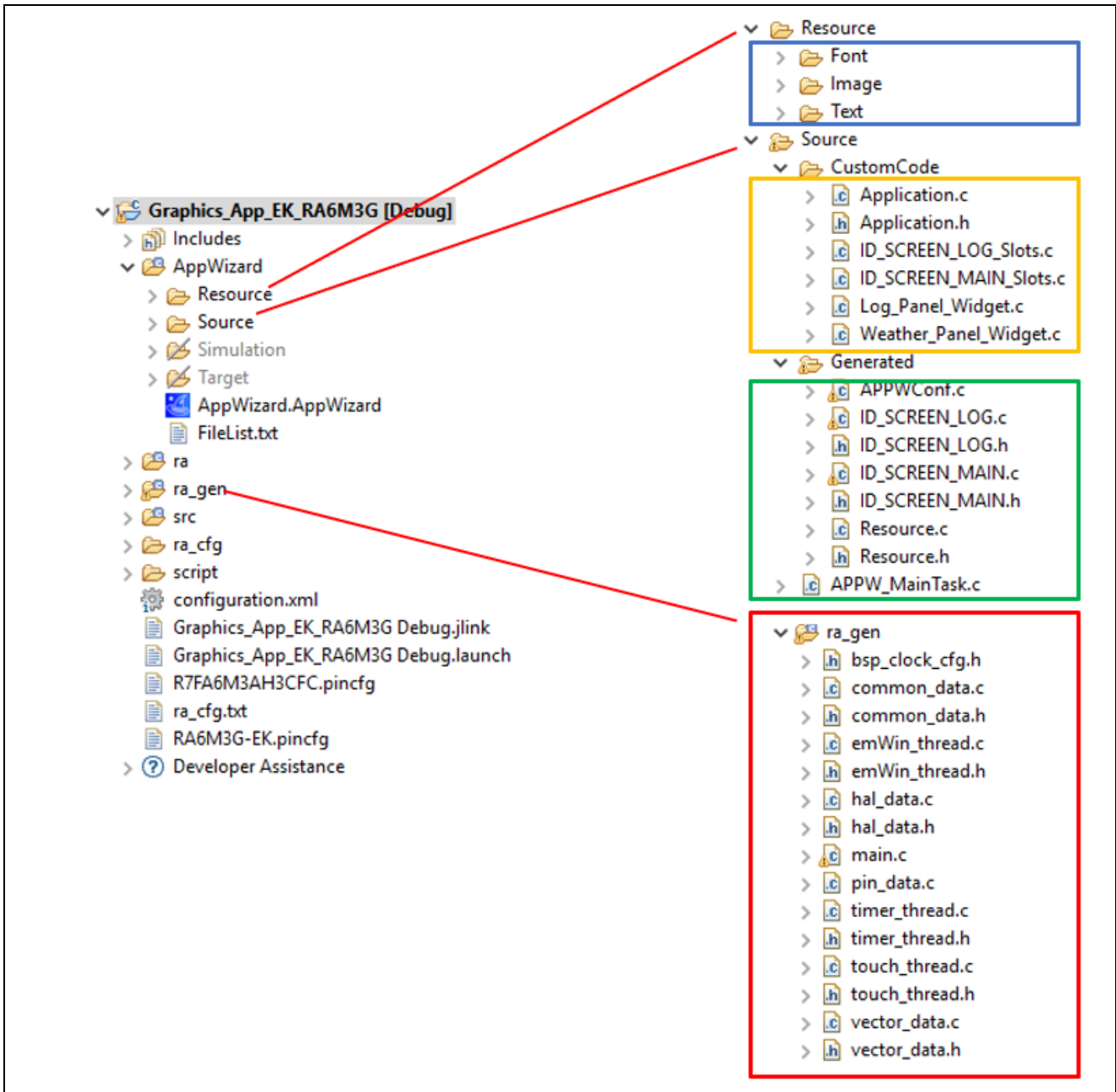

**Figure 18. Graphics Application Project Source File Layout**

Figure 18 above shows the source code layout for the EK-RA6M3G board. FSP auto-generated code is in the `ra_gen` folder, AppWizard auto-generated code is highlighted in the `Generated` folder, and the code you generated is in the `CustomCode` folder.

Your generated code `/AppWizard/Source/CustomCode` is mainly for HMI event handling. Your code in the `/src` folder is related to MCU peripherals and other functionalities.

### 4.2 Application Block Diagram

As mentioned, the graphics application consists of two panels, the **Weather Panel** and the **Logging Panel**. The two application panels interface with the graphics framework through interaction such as touch events, and data (variables) changes. It communicates with FSP and HAL drivers to send and receive touch sensing data, GPT PWM duty cycle, and RTC date and time.

The graphics framework includes the SEGGER AppWizard framework, emWin library, emWin RA port, and interfaces with several HAL drivers such as GLCDC, JPEG CODEC, and D/AVE 2D. Figure 19 shows the application diagram.

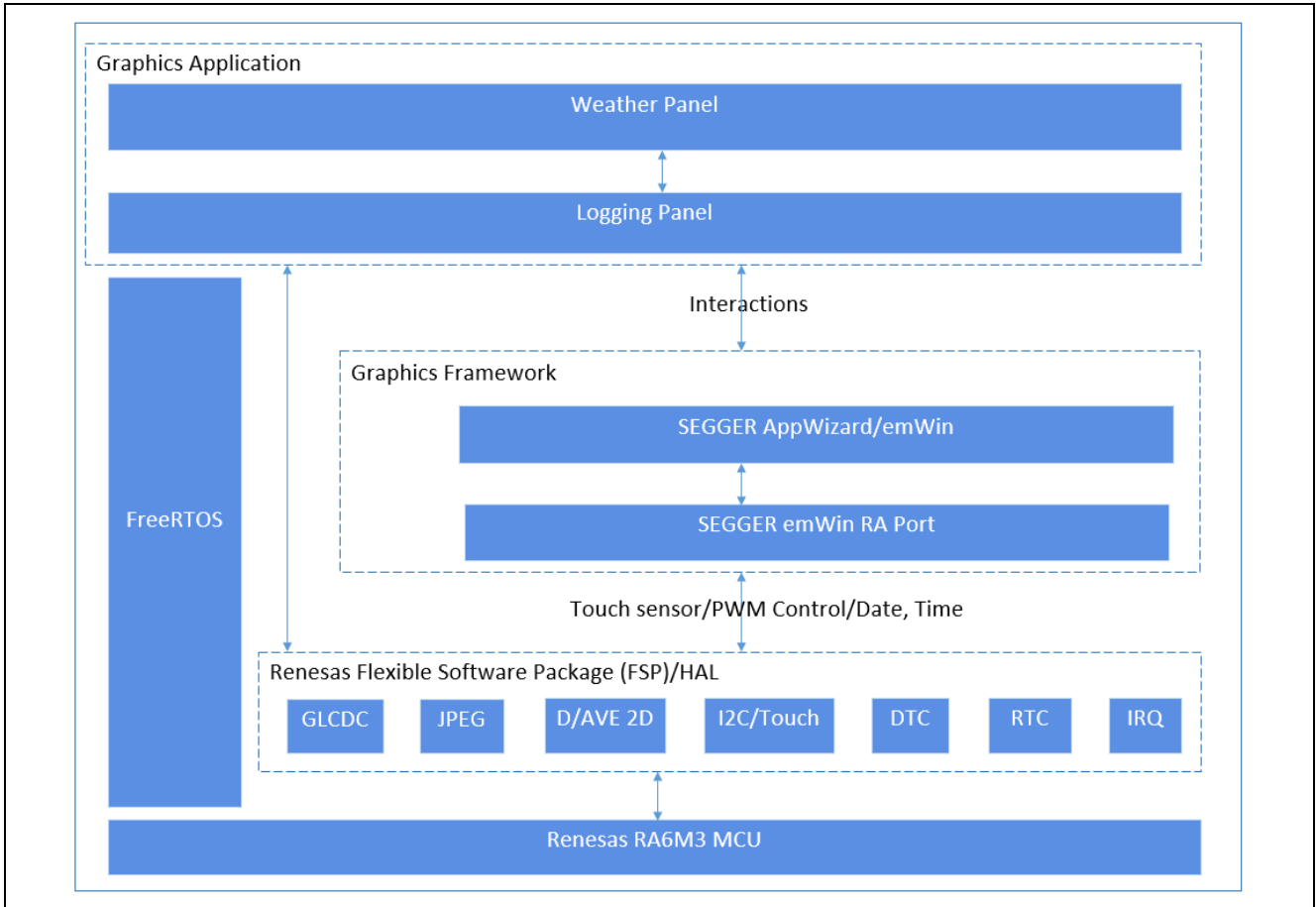

Figure 19. Application Block Diagram

### 4.3 Thread Overview

As mentioned in the introduction, the graphics application is a multi-threaded application, running under FreeRTOS. There are two types of threads found in an FSP application, those created by you, and those created automatically to support operation of FSP. While it is obvious as to what threads you created, it is not always obvious as to what threads are created by FSP. The graphics application uses both user-created threads and FSP threads. Threads communicate through the emWin type events using AppWizard and emWin APIs. The emWin thread processes data and touch events that are sent by the Touch thread and Timer thread. The FSP Configuration section details how to add your threads to your application. Figure 20 shows a high-level diagram of the threads and event flow in the graphics application. Notice the distinction between your threads and FSP threads.

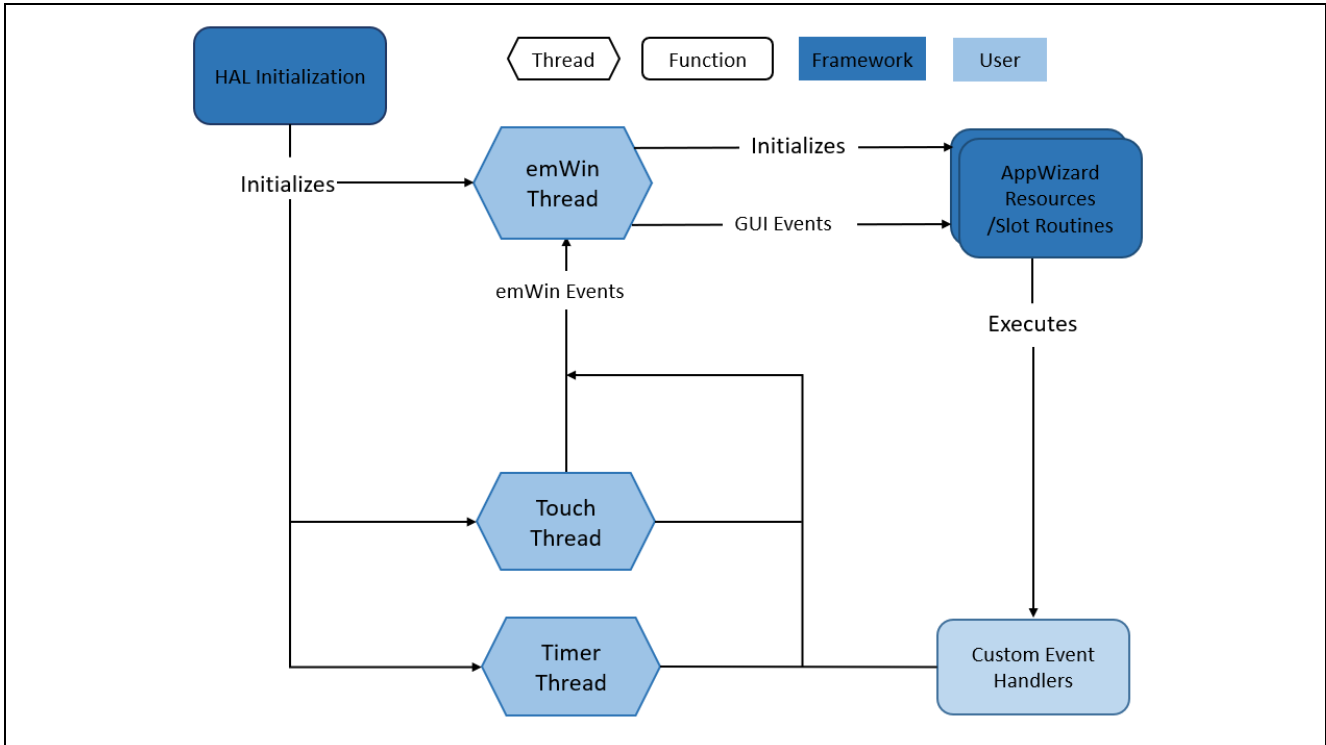

Figure 20. Graphics Application Event Flow

#### 4.3.1 emWin Thread

The emWin thread is an HMI thread that initializes various services and resources used by the graphics application. Once this initialization is complete, the emWin thread processes touch events and window messages. If any of these inputs result in a change to the system state, the emWin invokes the AppWizard Slot routines, which are the callback routines, resulting in changes to the graphical HMI. The flowchart in Figure 21 gives the high-level view of the emWin Thread.

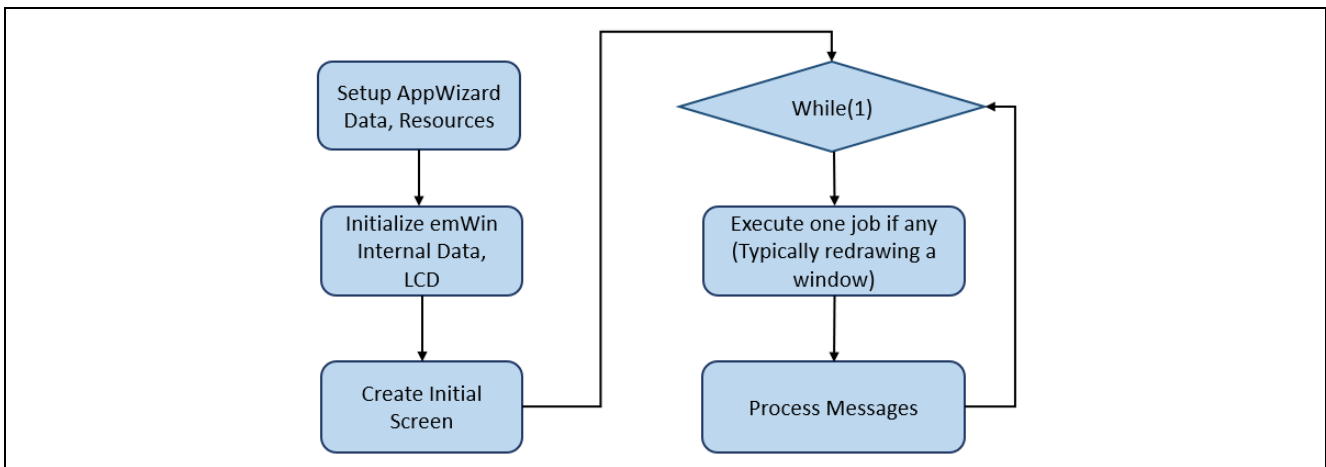

Figure 21. High-Level View of the emWin Thread

### 4.3.2 Touch Thread

A separate touch thread is created to read the touch sensor data. The touch sensor IC signals an event, such as a user interaction on the LCD screen, by toggling a pin connected to the MCU. In response, the touch thread reads the information from the touch sensor IC registers. Figure 21 shows the flowchart of the touch thread.

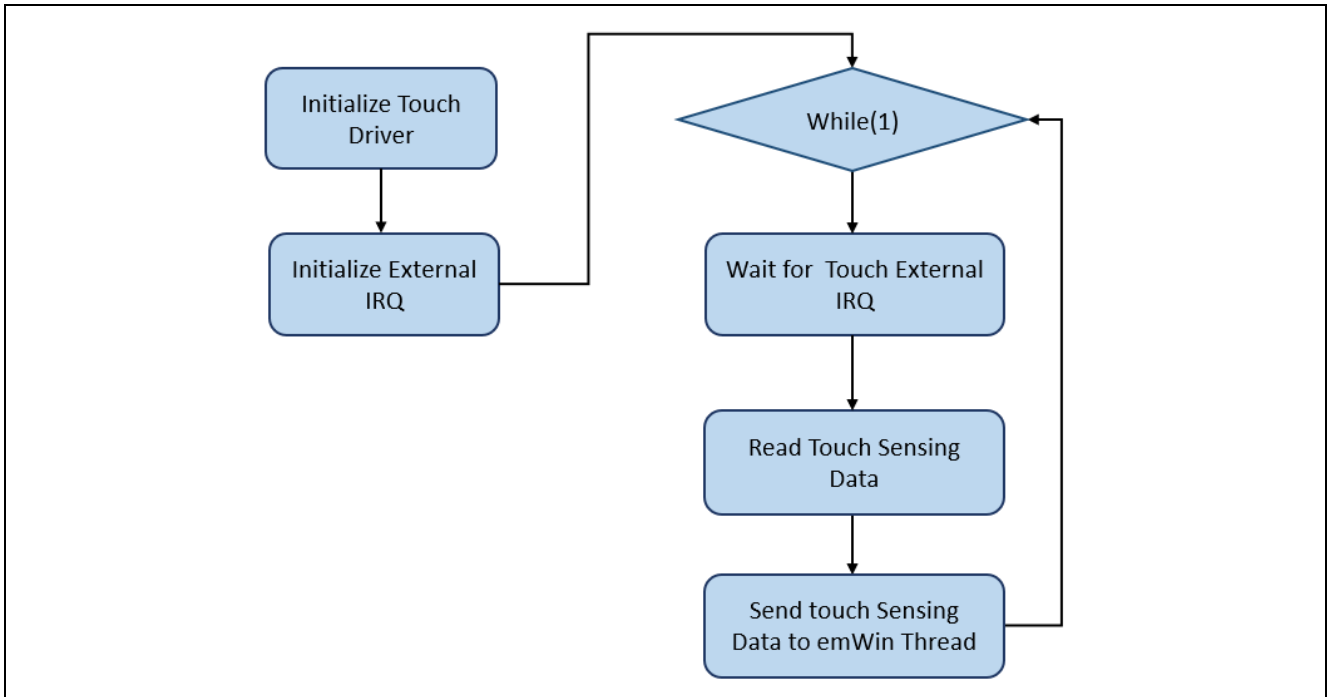

Figure 22. Touch Thread Flowchart

## 5. FSP Configuration

One of the first things you must do when writing an FSP application is to configure the FSP. To properly configure the FSP, you must have detailed knowledge of both the software design that you will be implementing along with the specific hardware it will be running on. For the hardware, this includes the types of peripherals to be used on the hardware, the pins they are mapped to, if they are internal or external to the MCU, and so on. From the software perspective, you need to decide how many threads will be used, which threads need access to what hardware components, and what additional software objects like semaphores and queues, that each thread will require. Once you have this information, you will be ready to successfully configure the FSP for your specific application needs.

In the graphics application, the FSP configuration is stored in a file named `configuration.xml`. Double-clicking on this file brings up the **RA Configuration** tab for the project.

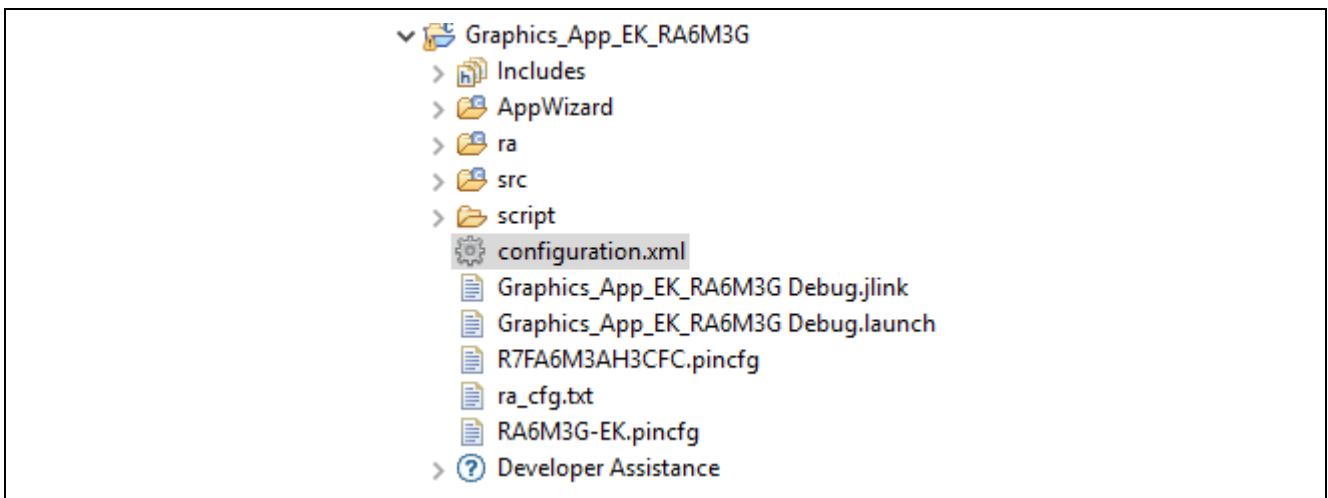

Figure 23. configuration.xml on the Project Plane



When a project is built from scratch, this configuration tab is where you will perform the initial configuration of the FSP. As you can see in Figure 24, the RA Configuration pane contains a **Summary** tab highlighting the items you may configure along with a scrolling window that lists all the software components currently selected for this project. Below this scrolling window are tabs that allow you to tailor the FSP to the needs of your specific application.

For the purposes of this application note, we will highlight a few of the details of the FSP configuration such as SEGGER emWin, the r\_glcdc driver, touch controller, and PWM timer as they pertain to the graphics application. For additional details, refer to the Renesas Flexible Software Package (FSP) User's Manual on how to configure the FSP.

When you have configured the project appropriately, click the **Generate Project Content**, the green arrow button above the summary screen, to build all the auto-generated files necessary to implement the components you defined.

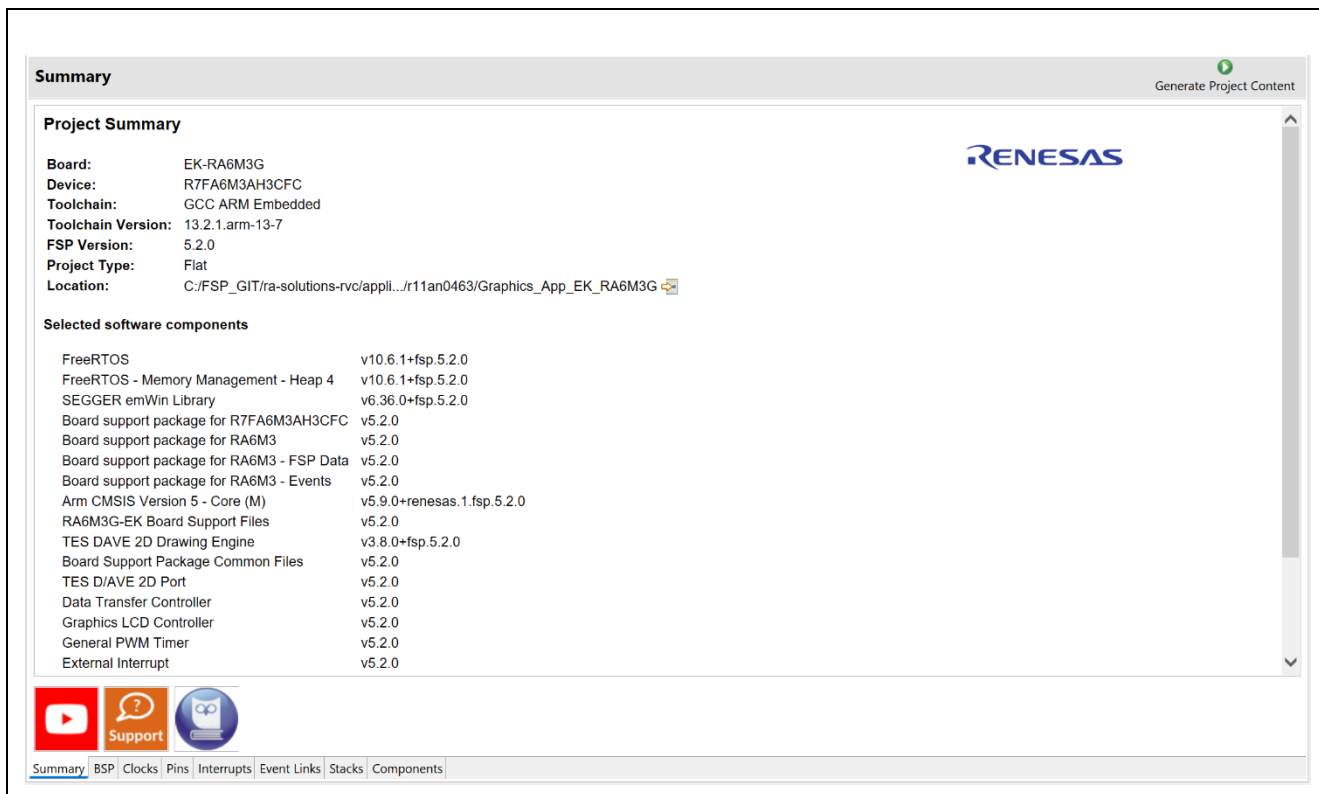
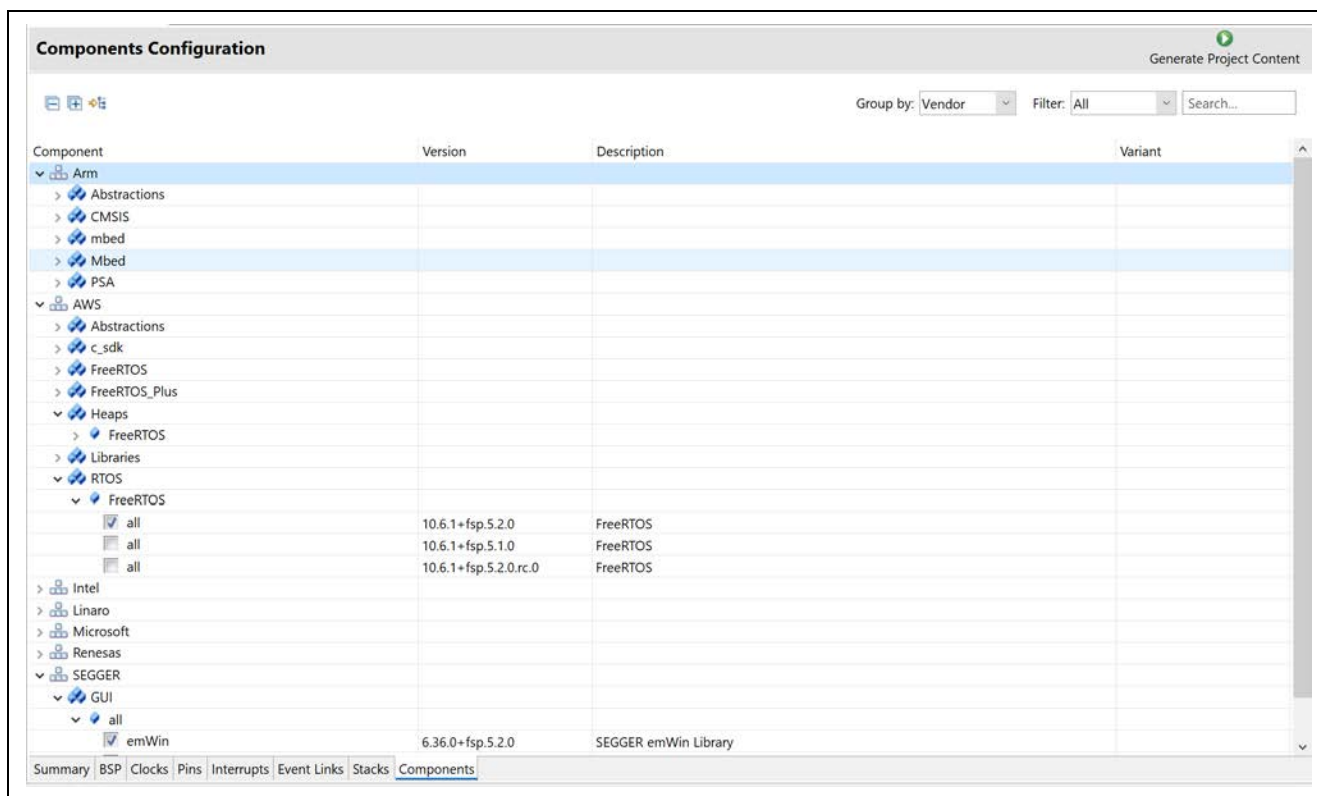

Figure 24. Summary of the Graphics Application Configuration

### 5.1 Components Tab

Even though the **Components** tab is the last tab showing, it is one of the first things you should configure. Selecting components first makes them available in subsequent operations such as mapping hardware resources to specific threads in the **Stacks** tab. One of the advantages of FSP is that it will only compile in the components you choose, thereby reducing the size of your overall application. As shown in Figure 25, components are broken down into several categories.



**Figure 25. Components Tab Categories**

You may expand any of the categories by clicking the arrow to the left of the category name.

The following table highlights the selections used for the graphics application.

**Table 2. Components Used in the Graphics Application**

| Category    | Component     | Version          | Description                           |
|-------------|---------------|------------------|---------------------------------------|
| BSP         | ra6m3g_ek     | 5.2.0            | RA6M3G-EK Board Support Package Files |
| CMSIS       | CoreM         | 5.9.0+fsp.5.2.0  | Arm CMSIS Version 5 - Core (M)        |
| Common      | fsp_common    | 5.2.0            | Board Support Package Common Files    |
| GUI         | emWin         | 6.36.0+fsp5.2.0  | SEGGER emWin Library                  |
| HAL Drivers | r_drw         | 5.2.0            | TES D/AVE 2D Port                     |
|             | r_dtc         | 5.2.0            | Data Transfer Controller              |
|             | r_glcdc       | 5.2.0            | Graphics LCD Controller               |
|             | r_icu         | 5.2.0            | External Interrupt                    |
|             | r_iic_master  | 5.2.0            | I2C Master Interface                  |
|             | r_ioport      | 5.2.0            | I/O Port                              |
|             | r_jpeg        | 5.2.0            | JPEG Codec                            |
|             | r_rtc         | 5.2.0            | Real Time Clock                       |
| Heaps       | heap_4        | 10.6.1+fsp.5.2.0 | FreeRTOS - Memory Management – Heap 4 |
| Middleware  | rm_emwin_port | 5.2.0            | SEGGER emWin RA Port                  |
| RTOS        | FreeRTOS      | 10.6.1+fsp.5.2.0 | FreeRTOS                              |
| TES         | dave2d        | 3.8.0+fsp.5.2.0  | TES DAVE 2D Drawing Engine            |

## 5.2 Stacks Tab

The **Stacks** tab is where you can add and configure the threads that the FSP automatically creates for your application. You define a new thread by clicking the  button and then entering a unique name for your new

thread. Once you add a new thread, you must define the modules that the thread will use along with any thread objects that will be used by your thread.

As an example, if you click the **Threads** panel and then single click on the **emWin Thread**, you should see something like the screen capture shown in Figure 26. This shows that the emWin thread requires multiple modules, for example, the GLCDC driver which is used to control the LCD screen on the Graphics expansion board of the EK-RA6M3G kit.

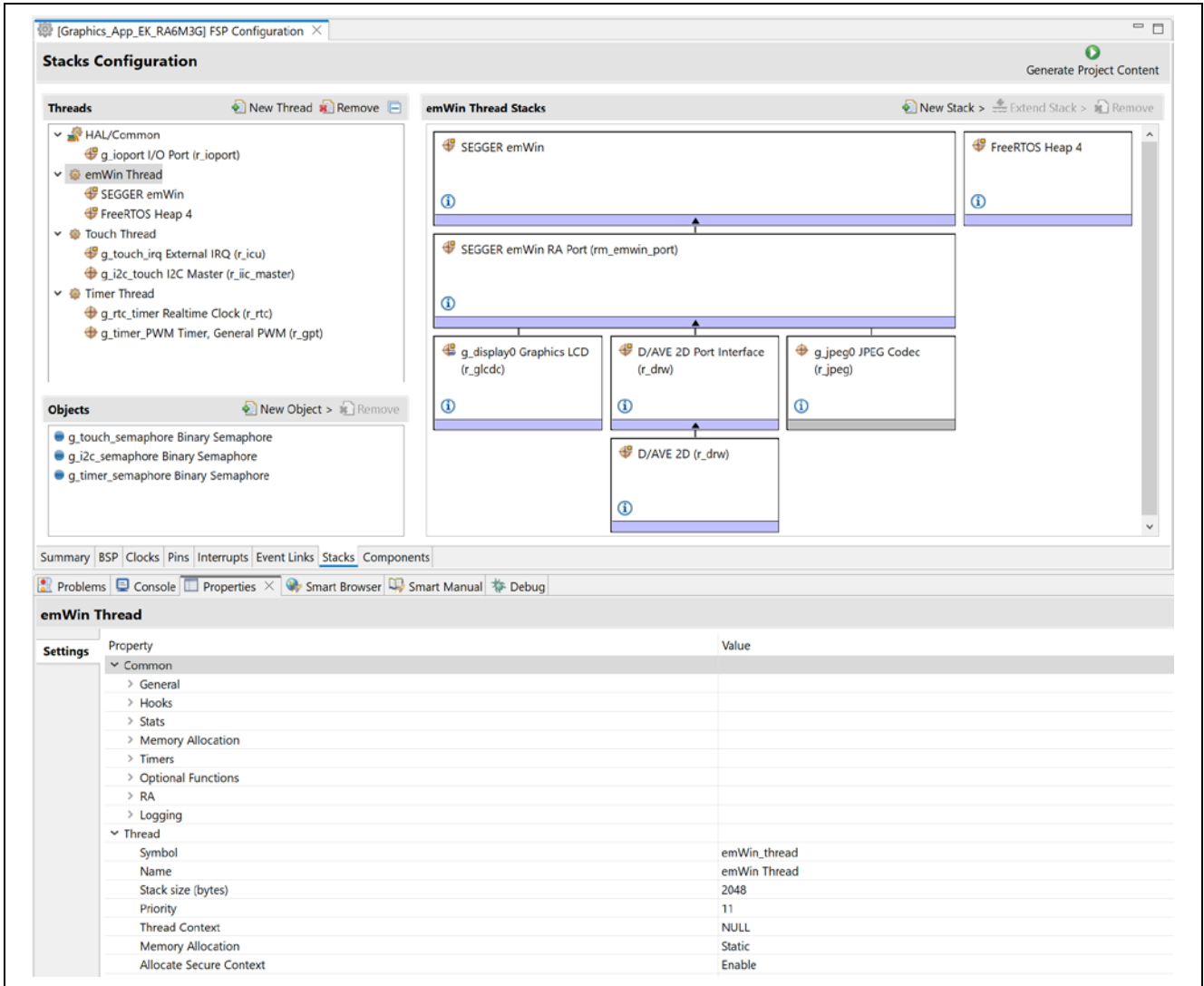

**Figure 26. emWin Thread Properties and Modules Used for the Graphics Application**

You can add additional modules to any thread by clicking the  button. If you have chosen the appropriate components prior to adding modules to your threads, you should not receive any errors. As an example, Figure 27 shows you how to add a GPT timer to the Timer Thread. The timer is added by choosing **(+) New Stack > Timers > Timer, General PWM (r\_gpt)**

If you have not preselected the appropriate component for a module that you select, the FSP automatically selects the component for you. If the FSP detects errors with the module addition, it prefaces the module with an error. You may examine the errors by hovering over the module name.

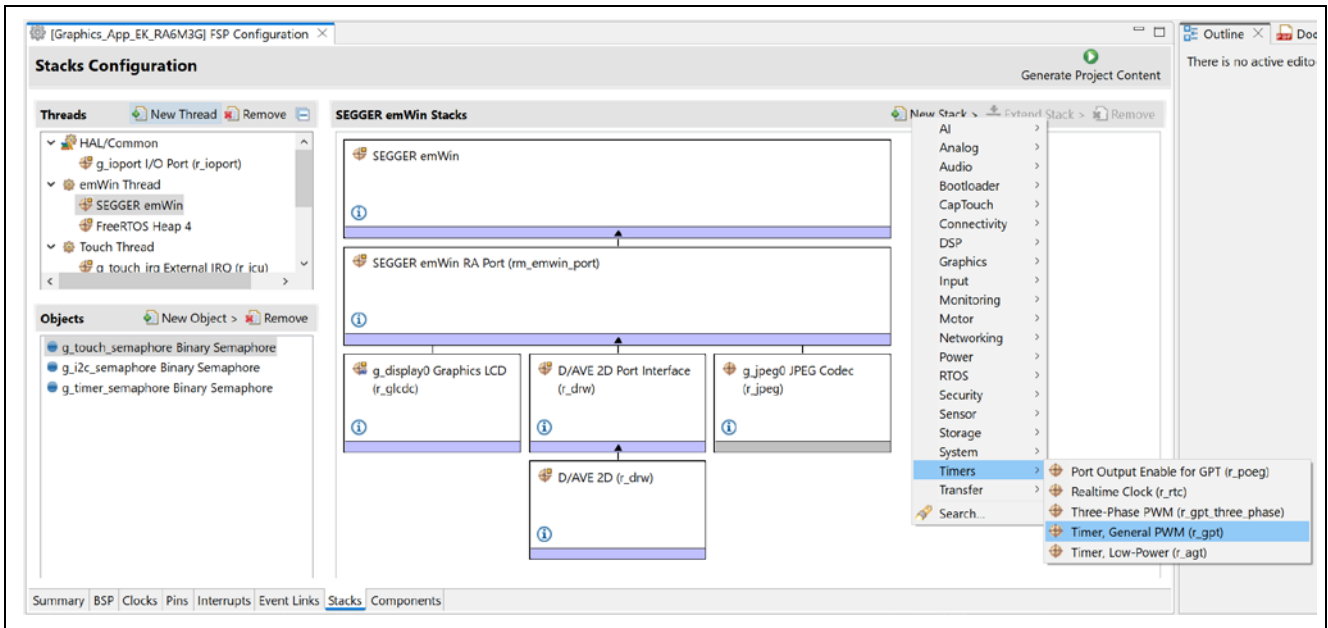



Figure 27. Adding r\_gpt driver

### 5.3 Thread Objects

FreeRTOS supports various objects such as mutexes, queues, semaphores, and timers. In the **Objects** window, you will see that there are three semaphore objects, **g\_touch\_semaphore**, **g\_i2c\_semaphore**, **g\_timer\_semaphore** created for this application.

You can allocate additional thread objects by clicking on the  button next to the **Objects** window. As you can see in Figure 28, after clicking the button  in the **Objects** window, you are presented with a drop-down list that allows you to add the standard thread objects supported by FreeRTOS.

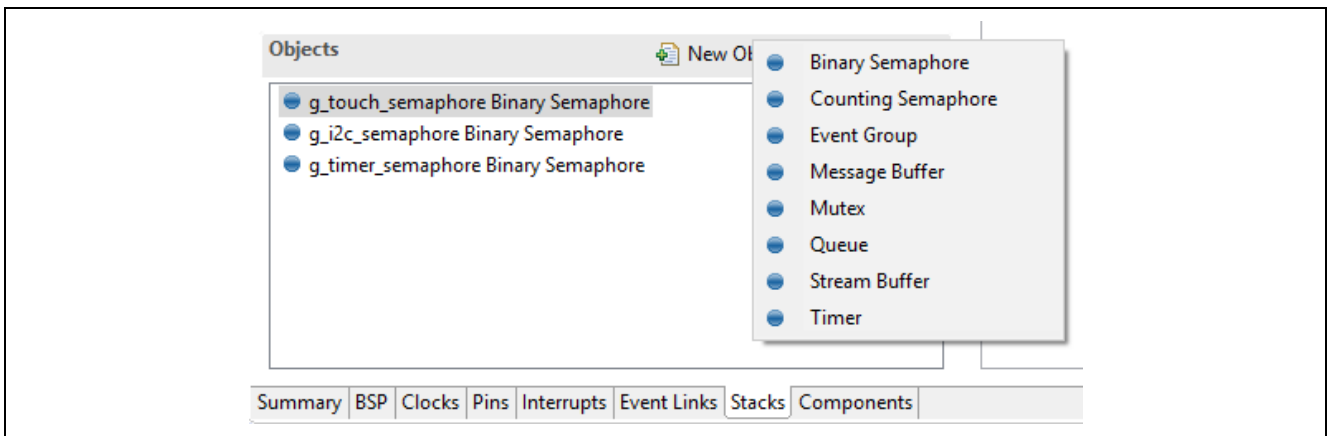

Figure 28. Objects window

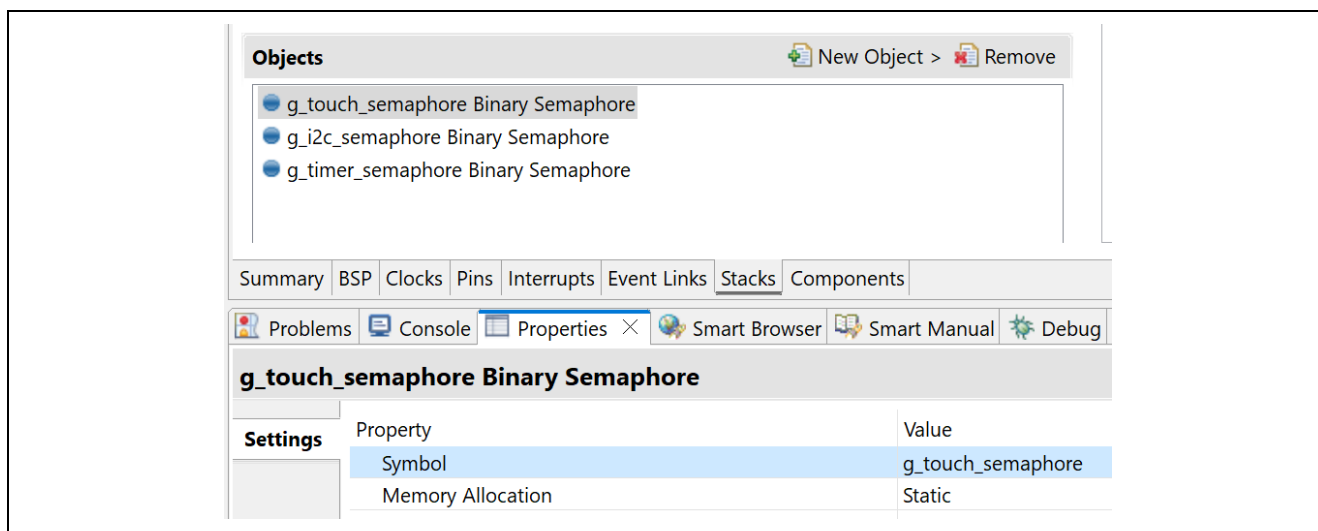

Figure 29. g\_touch\_semaphore Properties

## 5.4 Module Configuration

Once you have added a module to your project, you need to configure its properties. The properties are dependent on the module(s) that you have added. Use the **Properties** tab to configure them. The graphics application adds the `r_glcd` driver module as part of SEGGER emWin stack. This module is used to configure the GLCDC peripheral of the Renesas RA6M3 MCU.

### 5.4.1 GLCDC Configuration

As you can see in Figure 30, selecting the **g\_display0 Graphics LCD** on the **g\_glcdc** module under the **emWin Thread > Modules** tab brings up the associated properties under the **Properties** tab. The first thing you will notice is that it is a lengthy list of properties within the module group. The module group is where you configure the GLCDC controller. These properties can be a bit daunting at first but can be broken down. First, you will notice a few broad categories inside the module grouping.

- **Name:** The name given to this instance of the module **g\_display0** by default.
- **Interrupts:** You set the Line Detect interrupt and other interrupts here.
- **Input:** This block of module properties defines the input to the graphics controller, most notably, the framebuffer name and the number of the framebuffers, the memory address where the frame buffer is located, and others.
- **Output:** This is the area where you define the output properties of the GLCD. This includes properties such as the total horizontal and video cycles, the active video cycles, both horizontal and vertical, front and back porch duration, and so on.
- **TCON:** You use these lines in conjunction with the **Pins** tab, to map the Horizontal Sync (Hsync), Vertical Sync (Vsync), and Data Enable signals. You can specify the LCD Panel clock divisor that divides the clock input to the GCLD. This divisor ratio currently ranges from 1/1 to 1/32.
- **Color Correction:** This is where you can add various levels of color correction, for example, brightness, contrast, and gamma, to your display. Color, contrast, and gamma correction of LCD screens are outside the scope of this application note, but this is the area where you would do that type of adjustment.



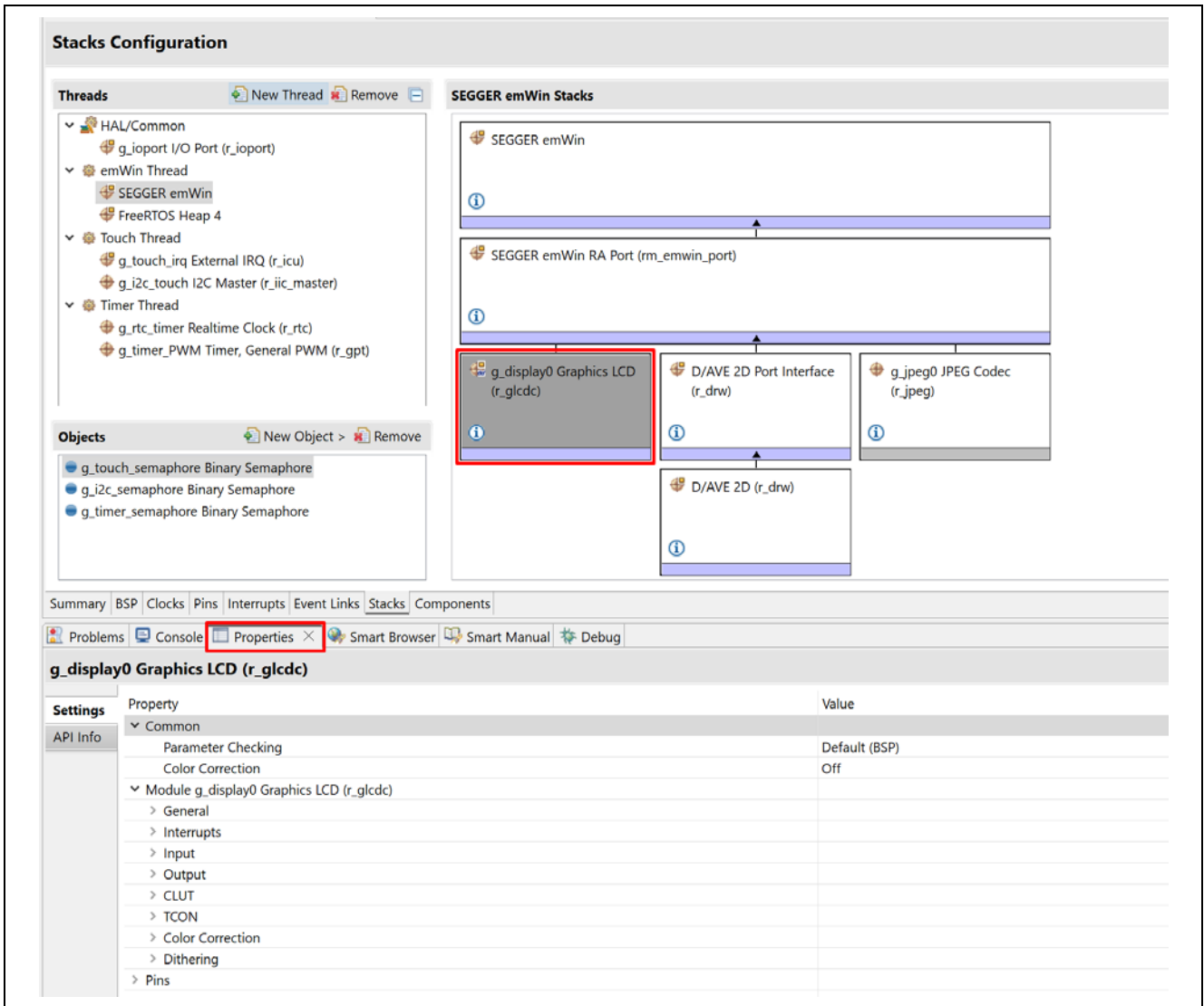

Figure 30. GLCD Properties Configuration using the Properties Tab

### 5.4.2 TCON Configuration

If you scroll down a little further in the **Properties** tab, you will see four TCON properties. One of these is associated with the **Panel clock division ratio**. This allows additional division of the pixel clock that is driven directly from the PLL0UT branch of the clock tree. The other three are associated with the LCD sync signals. These three signals can be confusing to new users, so how these signals map to the physical pins they are connected to, is discussed here.

|   |   |
|---|---|
| <ul style="list-style-type: none"> <li>TCON                             <ul style="list-style-type: none"> <li>Hsync pin select</li> <li>Vsync pin select</li> <li>Data enable (DE) pin select</li> <li>Panel clock source</li> <li>Panel clock division ratio</li> </ul> </li> </ul> | <ul style="list-style-type: none"> <li>LCD_TCON0</li> <li>LCD_TCON1</li> <li>LCD_TCON2</li> <li>Internal clock (GLCDCLK)</li> <li>1/24</li> </ul> |
|---|---|

Figure 31. TCON Configuration for EK-RA6M3G Kit

To provide flexibility, the GLCD controller of the RA6M3 MCU provides two pin grouping options. Each option uses different pins on the MCU to drive the data lines connected to the LCD display. It is up to the hardware designer to pick the group of pins they want to use. Picking one or the other may free up MCU pins that are necessary in some other part of the hardware design.

If you look at the schematics for the EK-RA6M3G kit, you can see the pins header for the LCD board. You will also notice the three pins connected to the sync signals that are highlighted in red. The data lines chosen by the hardware designer must match one of the two pin groupings available under the GLCD module.

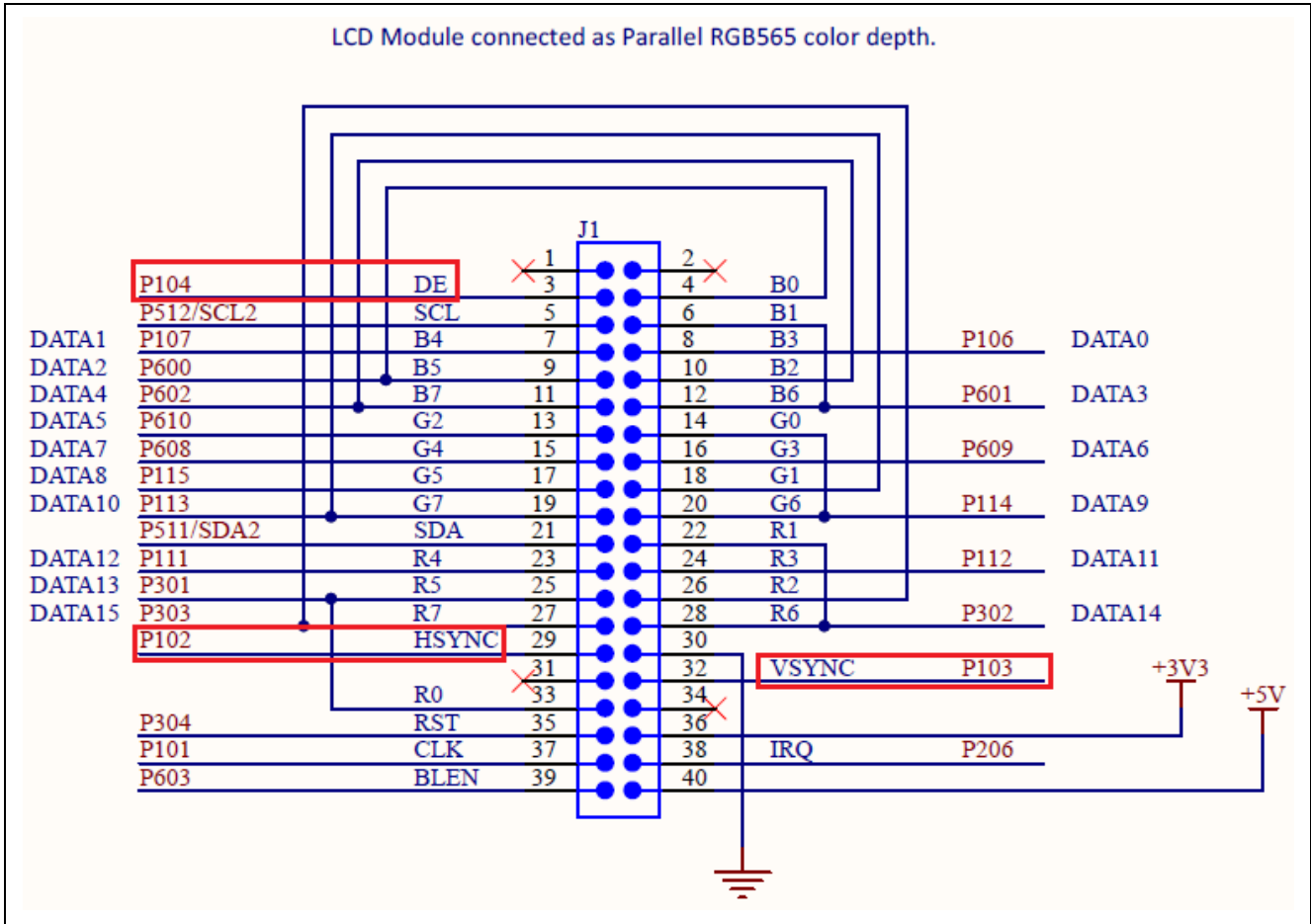

Figure 32. EK-RA6M3G LCD-Specific Signals from the Schematics

The easiest way to understand this is to go to the **Pins** tab in the RA Configuration. You will see selections for **Ports**, **Peripherals**, and **Other Pins**, as shown in Figure 33. If you expand the **Peripherals** dialog, you will see all the various MCU peripherals that can be configured from this screen.

If you scroll down to the **Graphics:GLCDC** entry and click to expand it, you will see two options **GLCD0 Pin Group Selection A** and **GLCD0 Pin Group Selection B**. For the EK-RA6M3G kit, the **GLCD0 Pin Group Selection A** selected to drive the LCD display.

Notice that TCON0 is associated with the Port 1 Pin 02 (P102). On the schematic (P102) we see that it is connected to HSYNC, which is the horizontal synchronization pin for this LCD screen. Referring to Figure 31, we see TCON0 has been selected to drive the HSYNC signal.

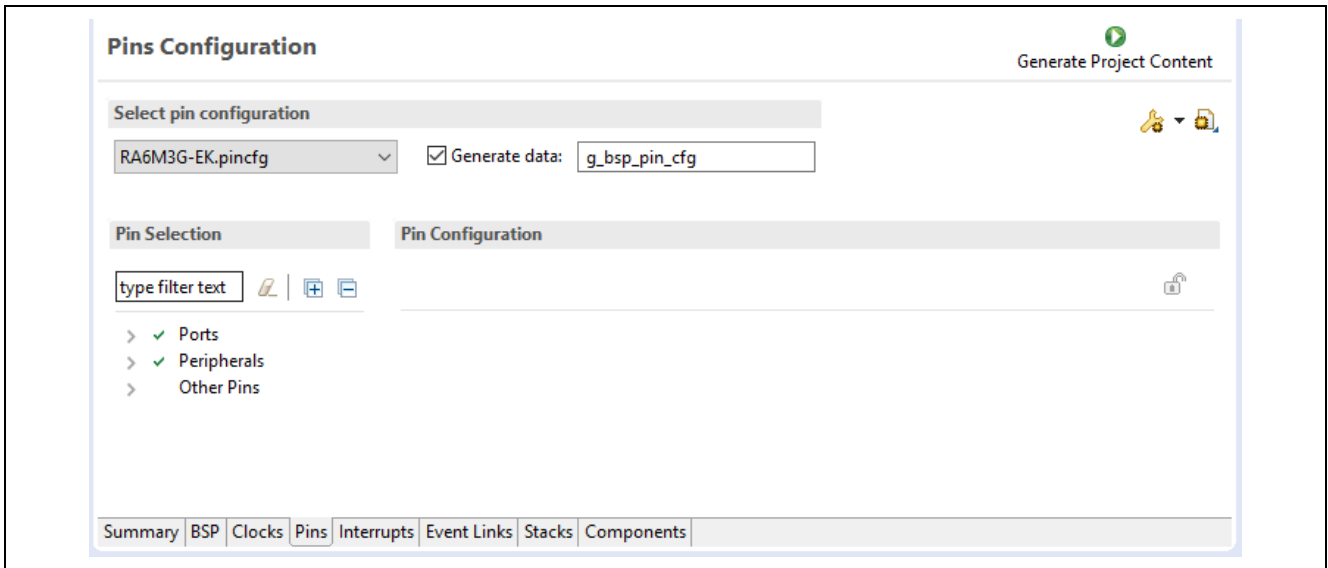

Figure 33. Pin Configuration Tab

If you look at all the LCD data lines such as LCD\_DATA\_DATA00, and the pins they are connected to, they should match the pins they are connected to on the schematic. Clicking on the arrow to the right of the pin brings you directly to the associated **Pin Configuration** dialog just as if you had selected the **Ports Group**, and then the specific port and pin that you are interested in.

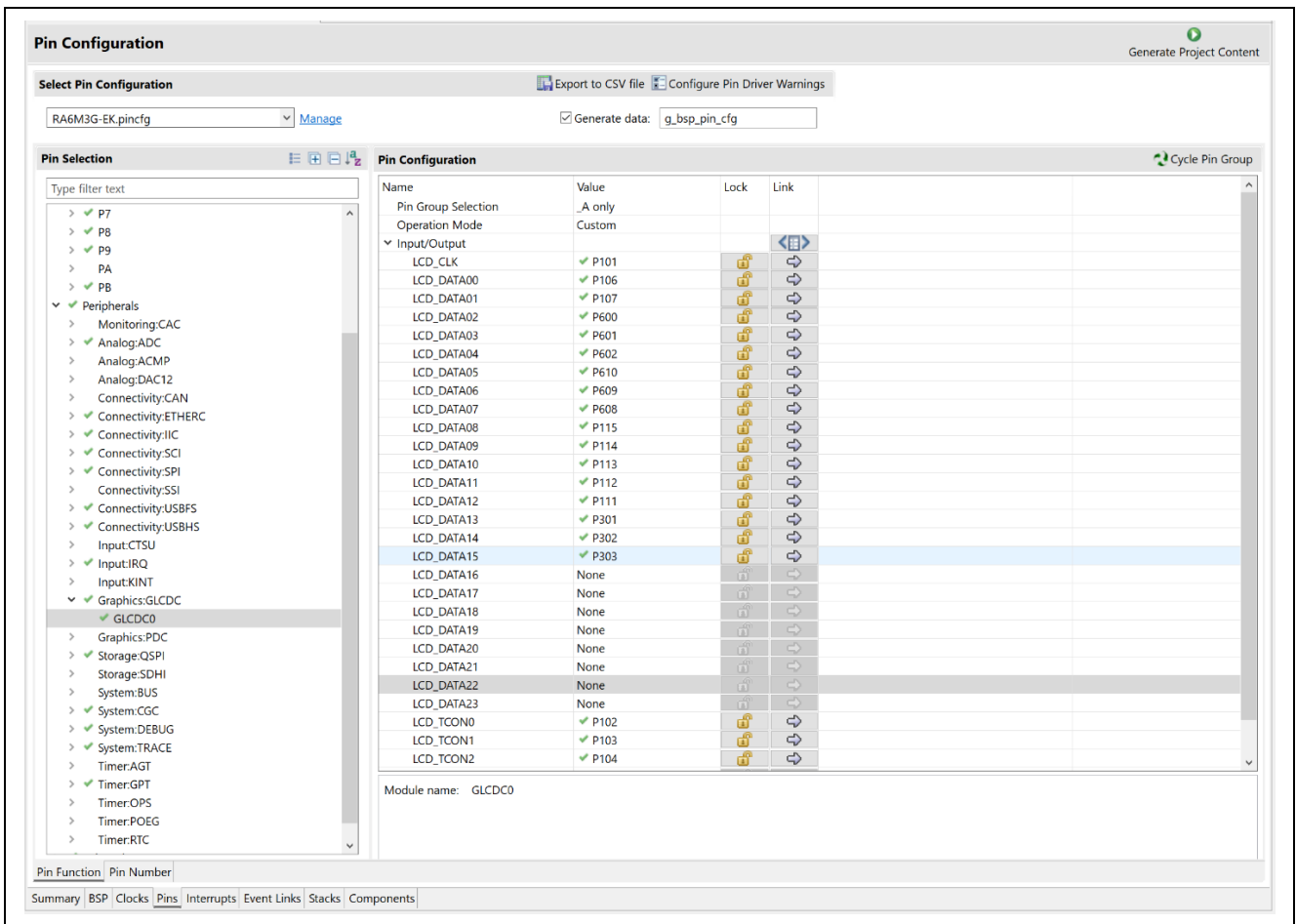

Figure 34. LCD Pin Configuration Using Configurator

For example, clicking on this arrow to the right of the LCD\_TCON0 pin should bring you to the **Pin Selection Screen** that looks like Figure 35. Notice that the pin is appropriately set to the **Peripheral mode**. At the time of writing this application note, the pins default to no pull up, high drive capacity, and CMOS output type. Clicking on the arrow button to the right of this screen brings you back to the associated peripheral screen.

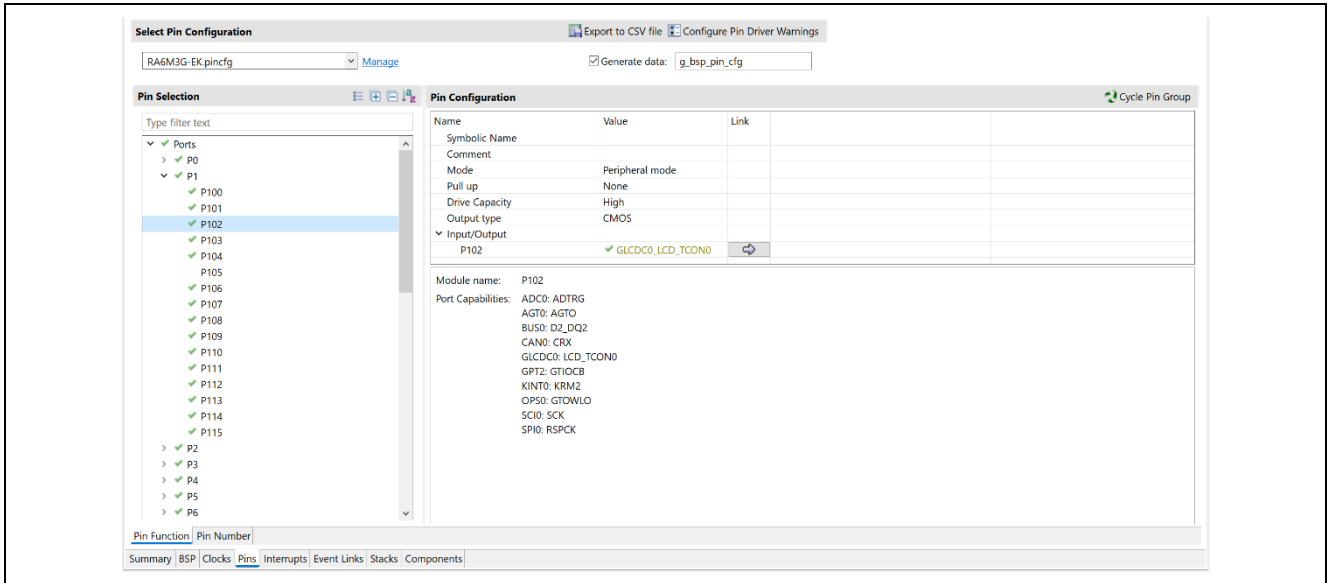

Figure 35. LCD\_TCON0 Settings in Pin Selection window

### 5.4.3 Touch Controller Configuration

The touch event on the LCD screen is sensed by the RA6M3 MCU external IRQ pin, and the touch sensor is read via I2C master.

As shown in Figure 38, the interrupt signal of the Touch Controller on the LCD screen connected to P206 on header J1 of the EK-RA6M3 board, which is MCU IRQ channel 0. The `r_icu` and `r_iic_master` drivers are added to a Touch Thread to handle the IRQ channel 0 and I2C Master Channel 2, respectively.

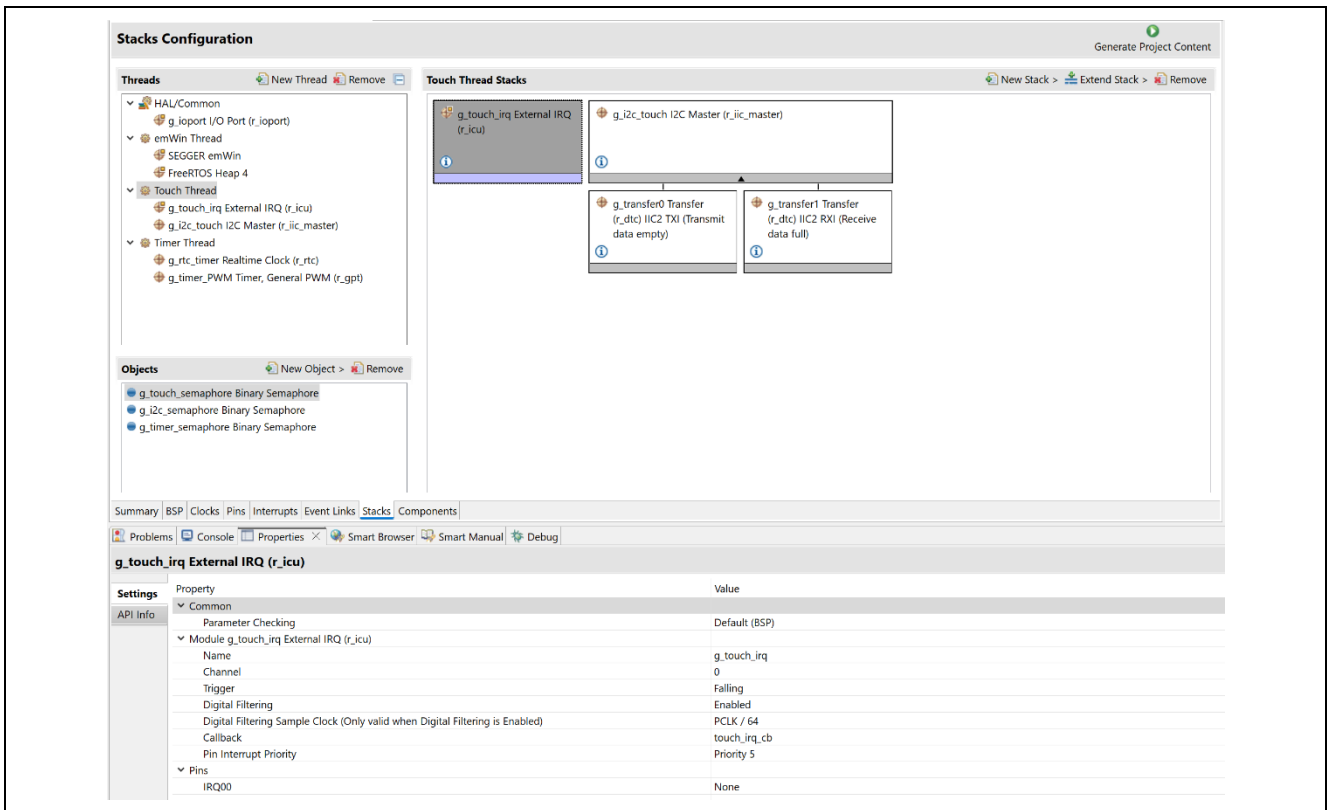

Figure 36. External Interrupt Configuration

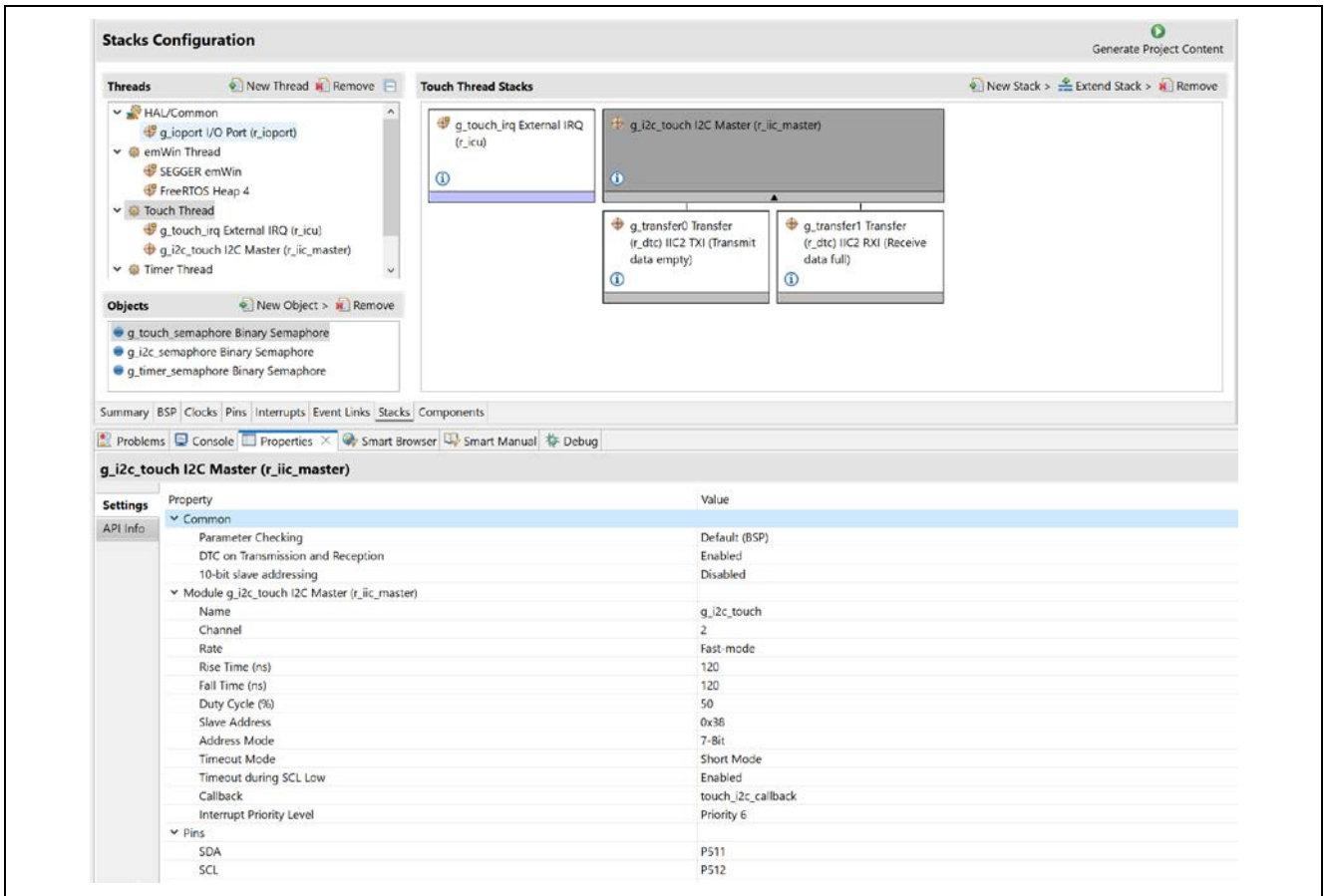

Figure 37. I2C Master Driver Configuration

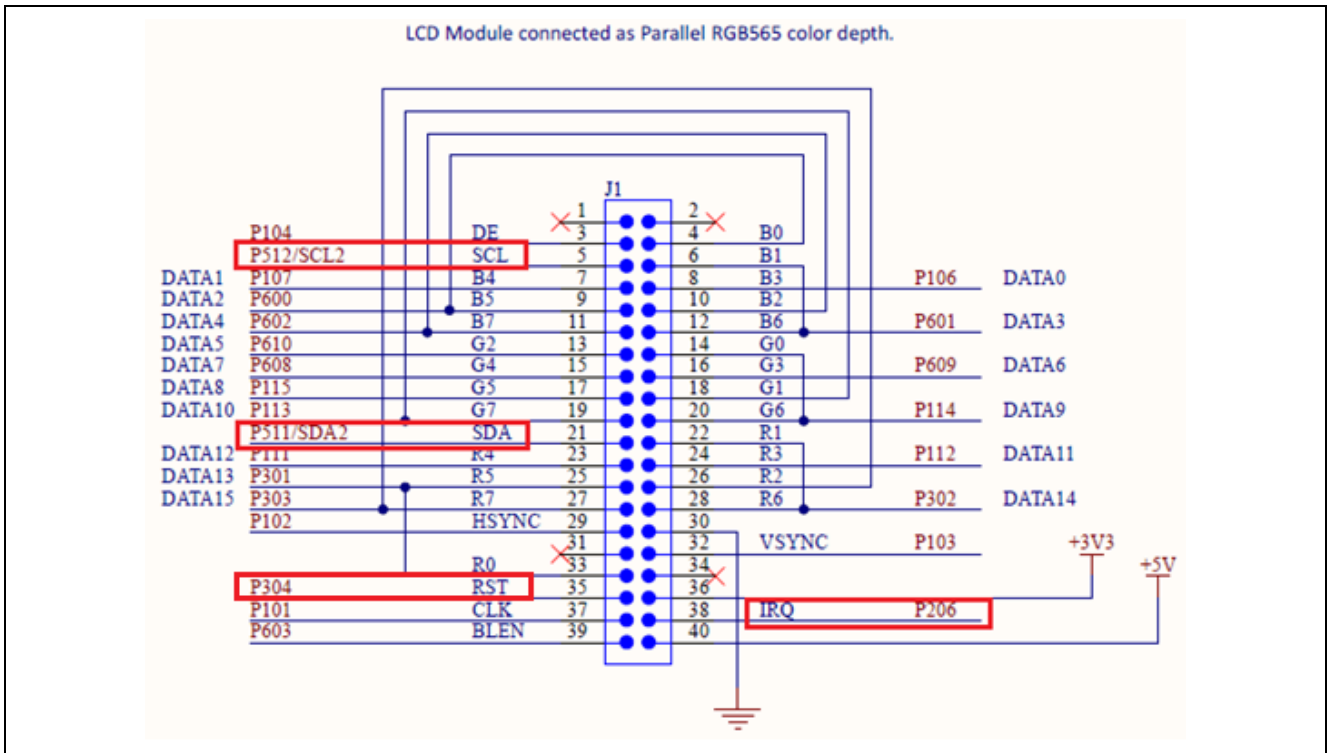

Figure 38. Touch Controller Signals

The EK-RA6M3G User Manual recommends the touch interrupt input must have the internal pull-up feature enabled. Use Ports Configuration for this setting instead of Peripherals Configuration.



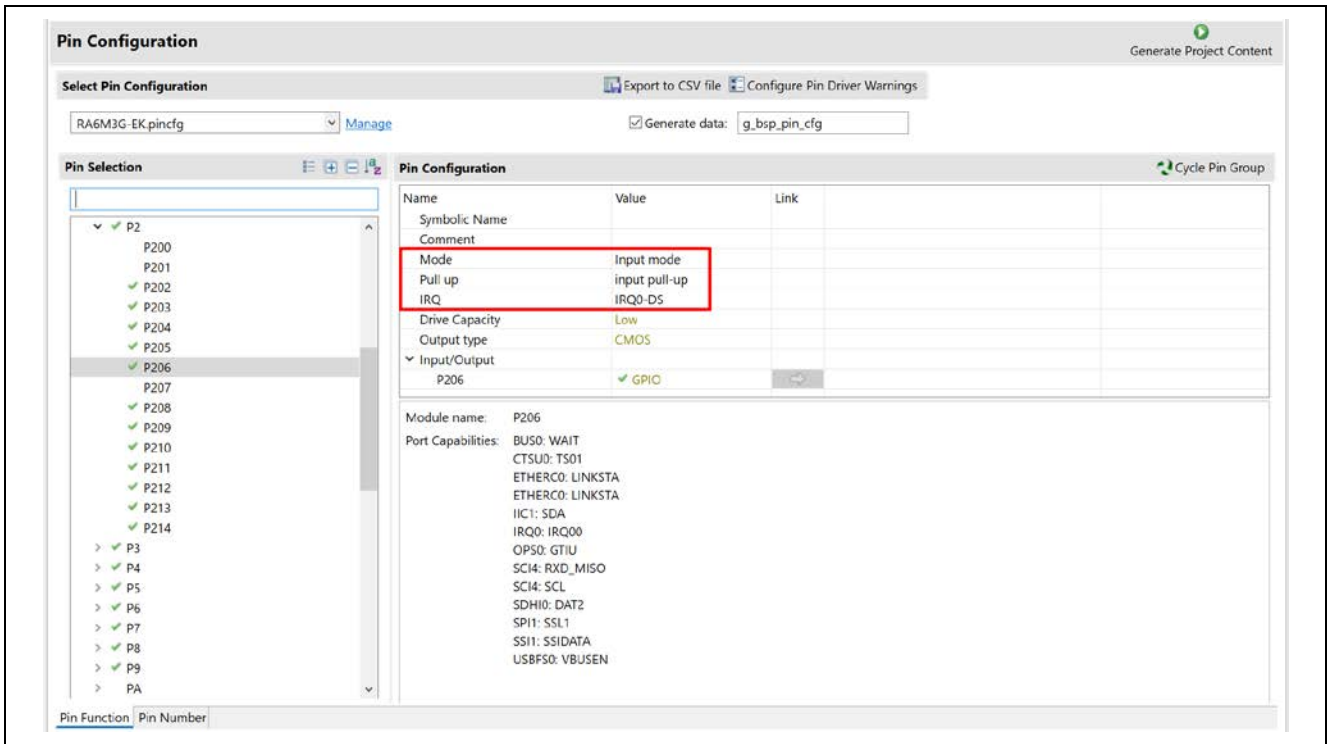

Figure 39. Touch Controller Interrupt Configuration

Note: When creating a project from scratch, you must add the touch driver to your project by copying the touch\_ft5x06 folder in this application note project to the new project. Go to **Project > Properties > C/C++ Build > Settings > GNU ARM Cross C Compiler > Includes** to add its include path.

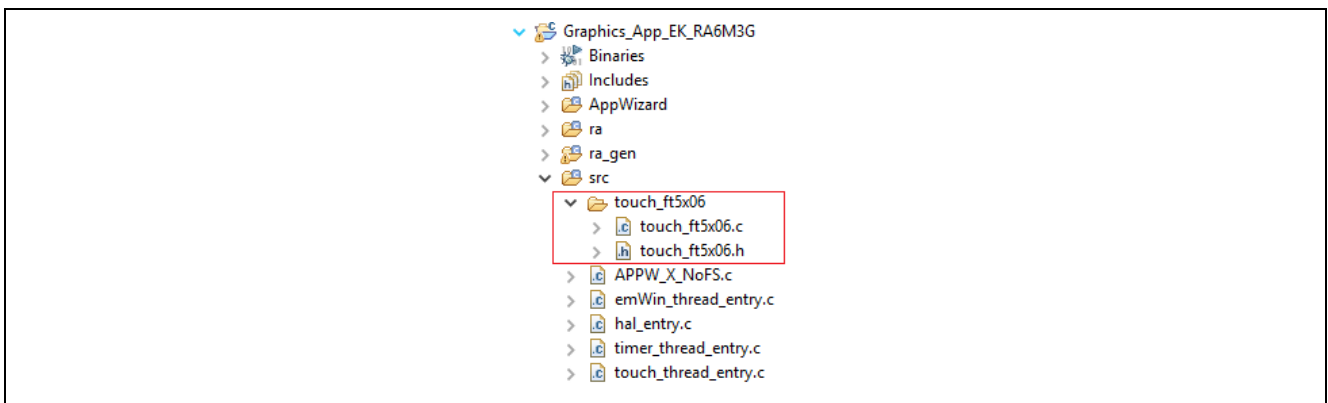

Figure 40. Backlight Control Pin on EK-RA6M3G

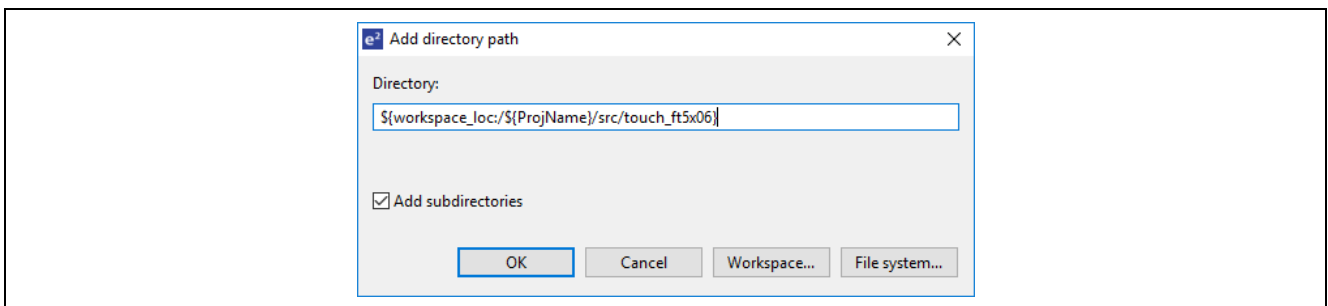

Figure 41. Add Touch Driver Folder to the List of Include Paths

### 5.4.4 PWM Configuration

The LCD\_BLEN signal (Blanking Enable), which is connected to the P603 on the RA6M3 MCU, is configuring in PWM mode to control the intensity of LCD backlight. Figure 42 shows an excerpt from the Graphics Expansion board schematic, which shows the LCD\_BLEN signal connected to the backlight controller.

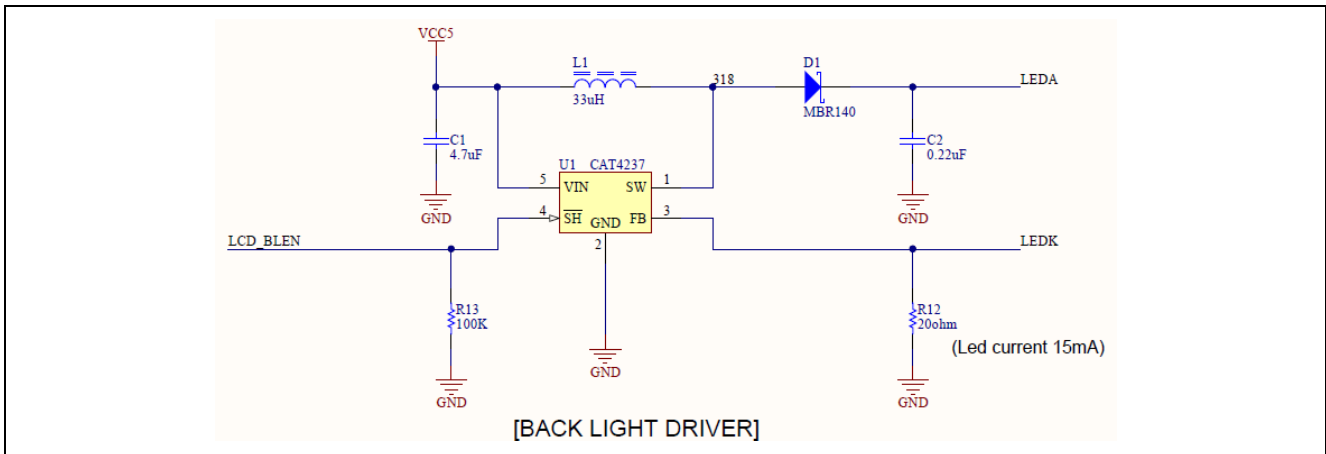

Figure 42. Backlight Control Pin on EK-RA6M3G

In **Pin Configuration**, set P603 as GTIOCA output of the GPT channel 7. The **Pin Group Selection** is set as mixed and the **Operation Mode** as GTIOCA or GTIOCB.

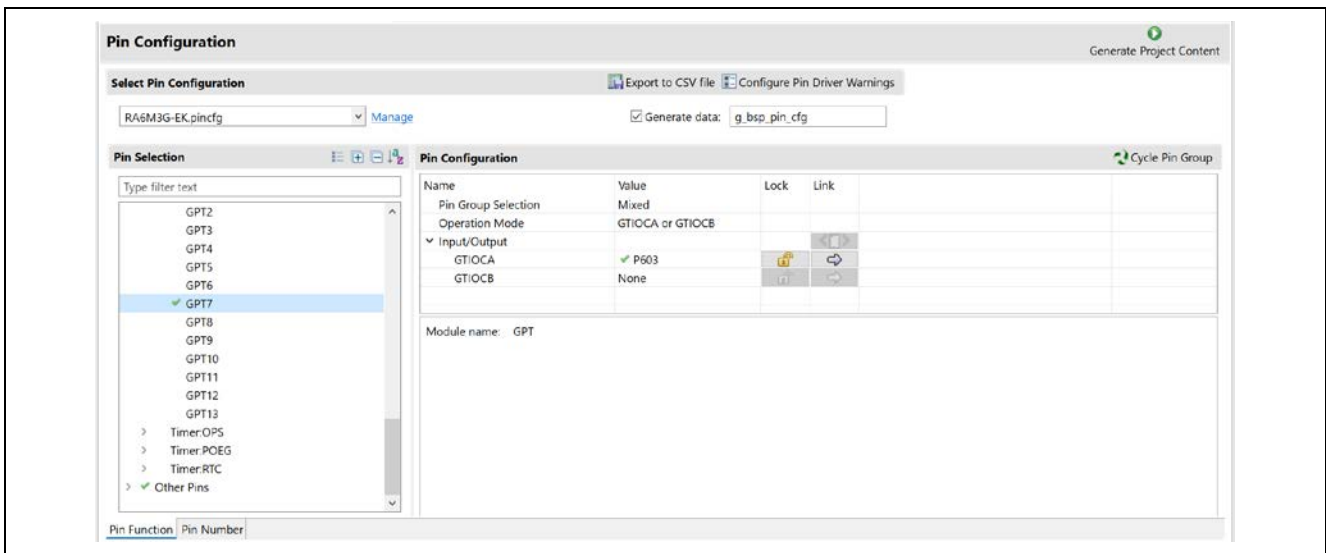

Figure 43. GPT PWM Channel 7 Pin Configuration

The `r_gpt` in the Timer thread is set in PWM mode to modulate LCD backlight intensity. In this graphics application, moving a slider in the **Logging Panel** will generate a duty cycle percentage that will be calculated into the GPT timer period and written to the counter register.

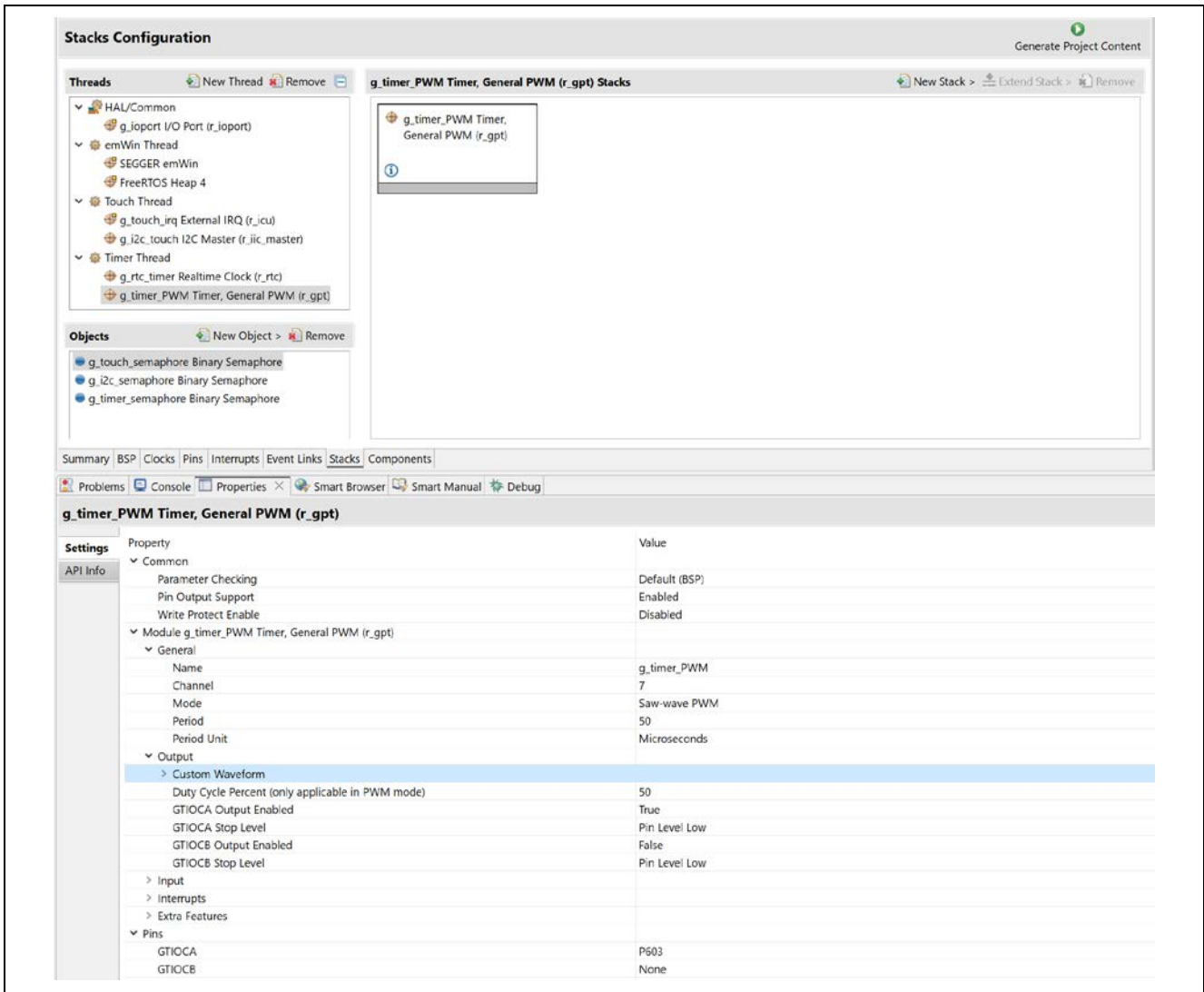

Figure 44. GPT Driver Configuration in PWM Mode

Figure 45 and Figure 46 show the AppWizard configuration for the backlight slider. Its range limits are from 5 to 100. Some interactions and custom code are needed to control the duty cycle of PWM output as well.



Figure 45. Slider Setup to Control LCD Backlight Intensity

```

246      /* Get the slider/ID_VAR_BACKLIGHT value*/
247      gDataApp.pwm_duty_cycle = (uint8_t)APPW_GetVarData(ID_VAR_BACKLIGHT, &gui_err);
248      if(gui_err)
249      {
250          APP_ERR_TRAP(gui_err);
251      }
252
253      current_period_count = info.period_counts;
254      /* Calculate the desired duty cycle based on the current period. Note that if the period could be larger than
255       * UINT32_MAX / 100, this calculation could overflow. A cast to uint64_t is used to prevent this. The cast is
256       * not required for 16-bit timers. */
257
258      duty_cycle_count = (uint32_t) (((uint64_t) current_period_count * gDataApp.pwm_duty_cycle)/GPT_PWM_MAX_PERCENT);
259      R_GPT_DutyCycleSet(&g_timer_PWM_ctrl, duty_cycle_count, GPT_IO_PIN_GTIOCA);
260

```

Figure 46. Custom Code Controls PWM Update GPT Timer Duty Cycle

## 6. Application Code Highlights

This section details the highlights of the graphics application. The goal of the graphics application is to show you how to develop more complex multi-threaded HMI applications using the FSP, AppWizard, and emWin library.

The key goal of the FSP is to abstract much of the complexity of interfacing with various Renesas peripherals and to quickly get you to the point where you can simply focus on constructing more complex applications as quickly as possible.

### 6.1 Threads and Main

In the FSP, main() is an auto-generated file which looks like the following code. The threads and objects specified during the FSP configuration are initialized in the main().

```

84      int main(void)
85      {
86          g_fsp_common_thread_count = 0;
87          g_fsp_common_initialized = false;
88
89          /* Create semaphore to make sure common init is done before threads start running. */
90          g_fsp_common_initialized_semaphore =
91          #if configSUPPORT_STATIC_ALLOCATION
92              xSemaphoreCreateCountingStatic(
93          #else
94              xSemaphoreCreateCounting (
95          #endif
96              256,
97              1
98          #if configSUPPORT_STATIC_ALLOCATION
99              , &g_fsp_common_initialized_semaphore_memory
100          #endif
101              );
102
103          if (NULL == g_fsp_common_initialized_semaphore)
104          {
105              rtos_startup_err_callback (g_fsp_common_initialized_semaphore, 0);
106          }
107
108          /* Init RTOS tasks. */
109          emWin_thread_create ();
110          touch_thread_create ();
111          timer_thread_create ();
112
113          /* Start the scheduler. */
114          vTaskStartScheduler ();
115          return 0;
116      }

```

Figure 47. The main () function in FSP with FreeRTOS Enabled

When you create a thread using the **New Threads** tab, the FSP creates several files. As an example, when the **emWin Thread** is added, the FSP created three files for you: emWin\_thread.h, emWin\_thread.c, and emWin\_thread\_entry.c, as shown in Figure 48.

The first two files are auto generated and therefore put into the ra\_gen folder. The emWin\_thread\_entry.c file is the entry point for the **emWin Thread**, and this is where you put your application code. Auto-generated files should not be updated by the user since they will be re-generated every time you build the project or click the **Generate Project Content** button. Auto-generated files always contain some form of **do not edit** message at the top of the file.

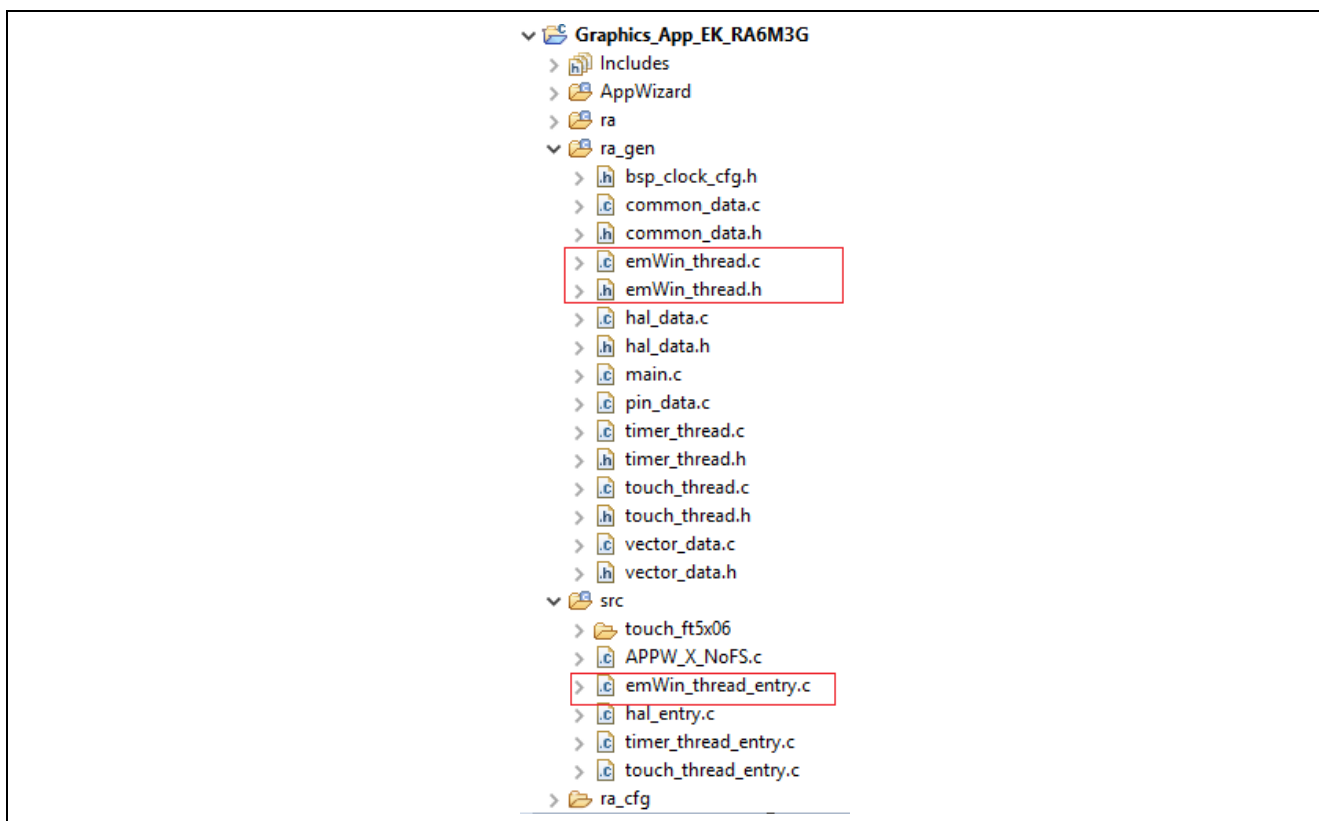

Figure 48. FSP Generated Source File Organization

### 6.1.1 AppWizard/emWin Initialization

The FSP does not automatically initialize the AppWizard system. To initialize it, simply include GUI.h and add the MainTask() API call to emWin\_thread\_entry() located in the emWin\_thread\_entry.c file.

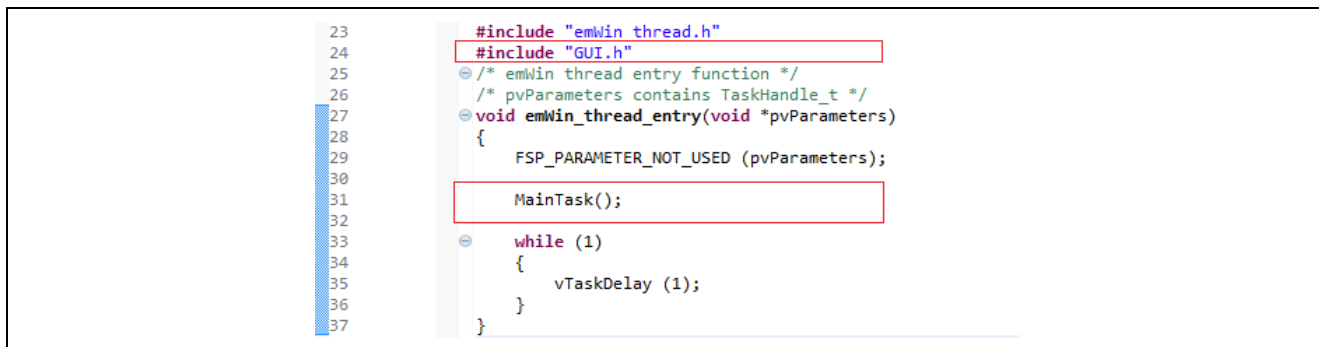

Figure 49. Backlight Control Pin on EK-RA6M3G

### 6.1.2 emWin Events and Messages

Touching the screen in the graphics application causes emWin to invoke the specific callback function generated for that screen in the AppWizard. AppWizard provides the callback function with specific information about the window that caused the event, and the actual event that occurred. These events are defined in WM.h.

You can add your code to slot routines in the file <ScreenID > \_Slots.c located in the \AppWizard\Source\CustomCode folder to handle window events. The slot routines are actual callback routines generated by AppWizard. Since the <ScreenID > \_Slots.c is updated whenever you add and generate new widgets or AppWizard interactions using AppWizard. Although custom code will be retained. It is a good practice to create your custom code in a separate file and call it in the appropriate slot routine.

```

362  * @brief      Custom code for cbID_SCREEN_MAIN in ID_SCREEN_MAIN_Slots.c
363  void cuscID_SCREEN_MAIN(WM_MESSAGE * pMsg) {
364      int wId          = 0;
365      int wMsg         = 0;
366
367      switch(pMsg->MsgId) {
368      case WM_INIT_DIALOG:
369          /* Get and store Images's handles */
370          if(ImageHandleGet(pMsg))
371          {
372              APP_ERR_TRAP(FSP_ERR_INVALID_POINTER);
373          }
374          /* Set default weather forecast */
375          if(WeatherForecastInit(pMsg))
376          {
377              APP_ERR_TRAP(FSP_ERR_INVALID_POINTER);
378          }
379          /* Set Thermostat target temperature */
380          APPW_SetVarData(ID_VAR_TARGET_TEMP, gDataApp.thermo_target_temp);
381          /* Save logging */
382          LogDataAppend(gDataLog, sizeof(gDataLog), "\n%s", "Init Dialog");
383          /* Create timer to control effects/animation*/
384          ghTimer = WM_CreateTimer(pMsg->hWin, 0, ANIM_TIMER_PERIOD, 0);
385          break;
386      case WM_TIMER:
387          /* Rainy effect*/
388          if(SYS_WEATHER_RAINY == gDataApp.sys_weather_type)
389          {
390              if(0 == AnimRainyState)
391              {
392                  /* Hide 1st animation image, show 2nd animation image */
393                  WM_HideWindow(hImageAnimBGRD[gDataApp.sys_weather_type]);
394                  WM_ShowWindow(hImageAnimBGRD[IMAGE_ANIM_RAINY_BGRD_2]);
395              }
396          }
397      }
398  }
    
```

Figure 50. Custom Code for The Slot Routine cb\_ID\_SCREEN\_MAIN

### 6.1.3 AppWizard Variables

Variables in the AppWizard can be used to store a value. They can be accessed and changed by the GUI or from outside of the GUI. The GUI can react to a change of a variable using interactions. One of typical uses is update the variables in a non-GUI thread to trigger data exchange between the AppWizard and non-GUI threads.

```

125  /* Timer Thread entry function */
126  /* pvParameters contains TaskHandle_t */
127  void timer_thread_entry(void *pvParameters)
128  {
129      FSP_PARAMETER_NOT_USED (pvParameters);
130
131      /* Set up GPT/PWM timer using for LCD back light control */
132      if(gpt_timer_PWM_setup())
133      {
134          APP_ERR_TRAP(FSP_ERR_ASSERTION);
135      }
136
137      /* Set up RTC timer */
138      if(rtc_timer_setup())
139      {
140          APP_ERR_TRAP(FSP_ERR_ASSERTION);
141      }
142
143      while (1)
144      {
145          /* Wait for interrupt from RTC timer */
146          xSemaphoreTake(g_timer_semaphore, portMAX_DELAY);
147
148          /* Get date, time */
149          R_RTC_CalendarTimeGet(&g_rtc_timer_ctrl, &RtcTimeCurrent);
150          /* Trigger GUI update*/
151          APPW_SetVarData(ID_VAR_TIME_UPDATE, 1);
152
153          vTaskDelay (1);
154      }
155  }
    
```

Figure 51. AppWizard Variable Update in Timer Thread

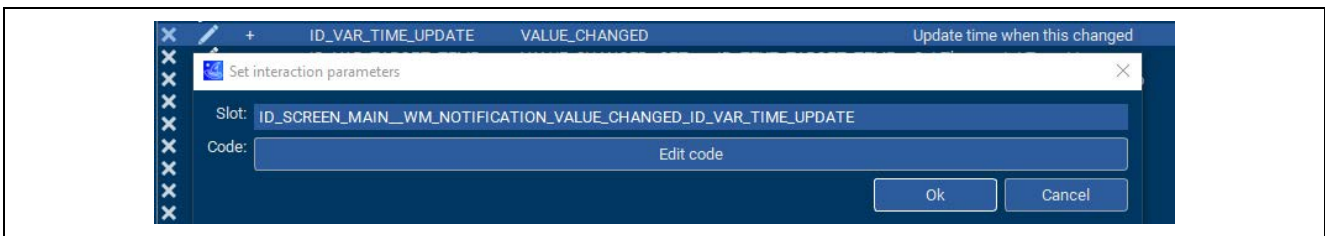

Figure 52. Setup Interaction to perform Date, Time Update when ID\_VAR\_TIME\_UPDATE is changed in AppWizard



## 7. Importing and Building the Project

To bring the graphics application into the e2studio, follow these steps:

1. Launch e<sup>2</sup> studio.
2. In the workspace launcher, browse to the workspace location of your choice.
3. Close the **Welcome** window.
4. In e<sup>2</sup> studio, go to **File > Import**.
5. In the **Import** dialog box pick **Existing Projects into Workspace**.
6. Select archive file.
7. Select the Graphics\_App\_EK\_RA6M3G project and click **Finish**.
8. Open **configuration.xml**.
9. Click on **Generate Project Content** on the FSP configurator window.
10. Now build the project.

## 8. Downloading the Executable to the EK-RA6M3G Kit

To connect and run the code, follow these steps:

1. Connect your PC to the USB port next to the Ethernet jack silkscreened DEBUG using a USB cable.
2. Go to **Run > Debug configurations**.
3. Click **Debug**. The program will break at the reset handler.
4. Click **Switch** to the **Debug perspective** when prompted by the e<sup>2</sup> studio.
5. Click **Run > Resume**.
6. The **Weather Panel** will show as in Figure 53. You can select forecast day or adjust the thermostat temperature. Touch the top right corner to move to the **Logging Panel**.



Figure 53. The Weather Panel

The **Logging Panel** allows you to adjust the LCD backlight using the slider or change **Logging Dialog** text color and background color using the rotary and the switch, respectively. The logging buffer resets when it reaches the limit of 256 bytes. Touch the Renesas logo to go back to the **Weather Panel**.

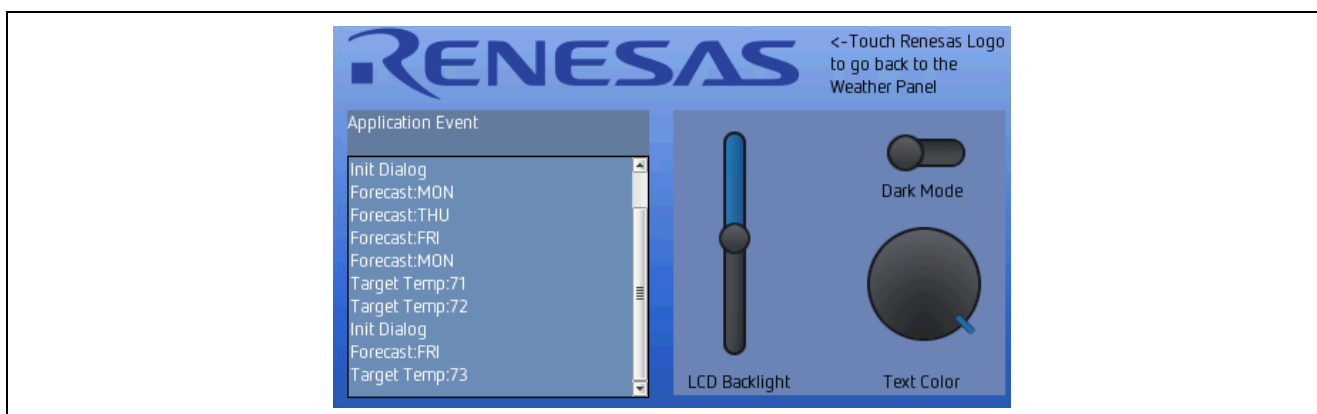
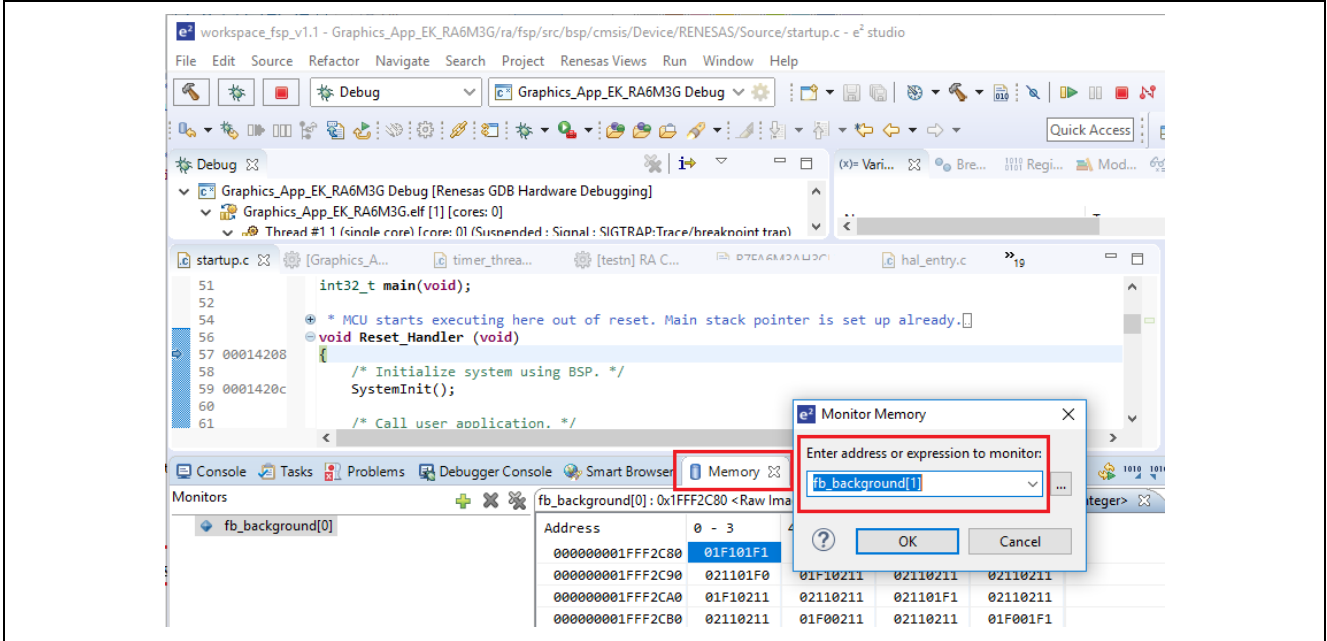

Figure 54. The Logging Panel

### 9. e<sup>2</sup> studio Tricks

The e<sup>2</sup> studio IDE has a handy feature that you can use to ensure that the images you are seeing on your LCD screen are coming from your framebuffer. To use this feature, make sure to connect the e<sup>2</sup> studio to your board and run the program under the debugger. Ensure that your **Memory** tab is open in the **Console** window, normally located to the bottom of the screen in **Debug** view. Click the small green plus (+) sign in the Monitors Pane to add a memory monitor. You should see a **Monitor Memory** dialog as shown in . Enter the Framebuffer **fb\_background[0]** or **fb\_background[1]** and click the **OK** key.

A new tab should now appear under the **Memory** tab that displays the contents of the memory area you specified for the memory monitor.



**Figure 55. Using the Memory Monitor to Display the Framebuffer Contents**

You should now see the contents of the selected framebuffer memory area displayed in the memory monitor you just created. If you know what the hex value of every pixel should be on your display, you would be able to use this memory monitor to definitively say that your image is being stored in the framebuffer. However, as most of us do not know the hex values associated with our pixels, we will let the memory monitor do the work for us.

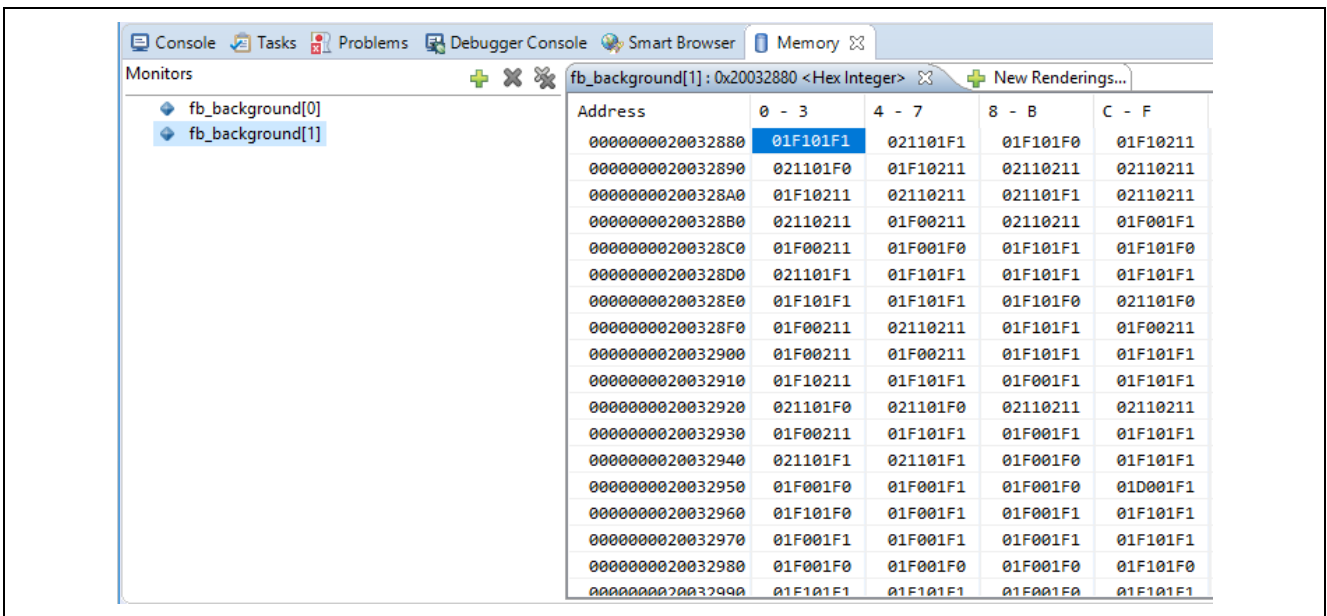

**Figure 56. Framebuffer 1 Contents**

Select the **New Renderings** tab next to the memory monitor you just created, select **Raw Image** type from the list of options, and press the **Add Rendering(s)** button off to the right side of the screen.

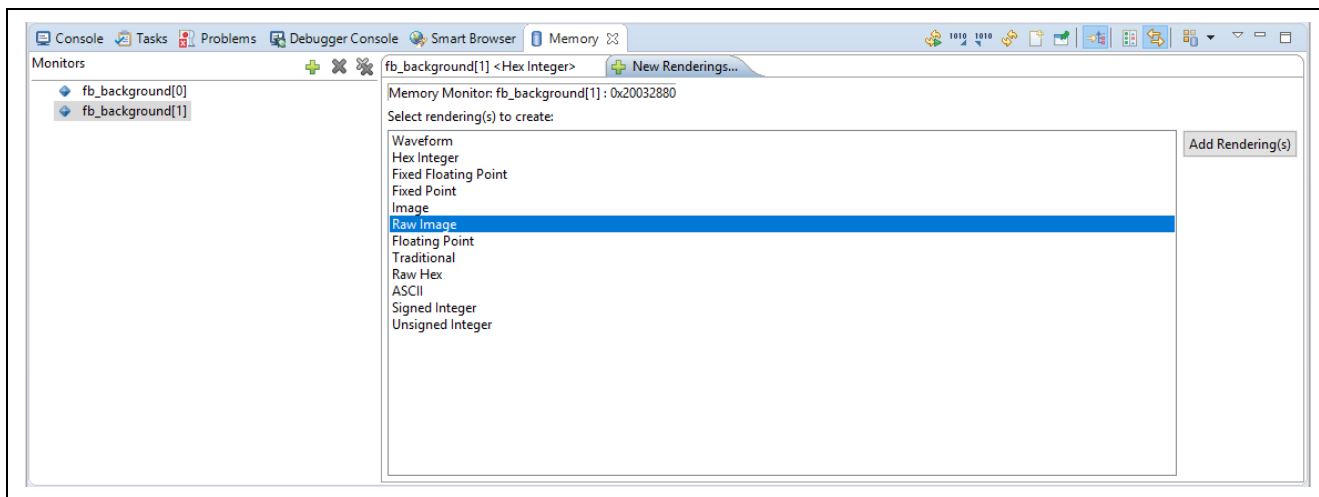

**Figure 57. Rendering Format Selection**

The **Raw Image Format** dialog box appears, that lets you enter the screen resolution Width and Height, along with the Encoding that is 16 bpp (5:6:5), in our case.

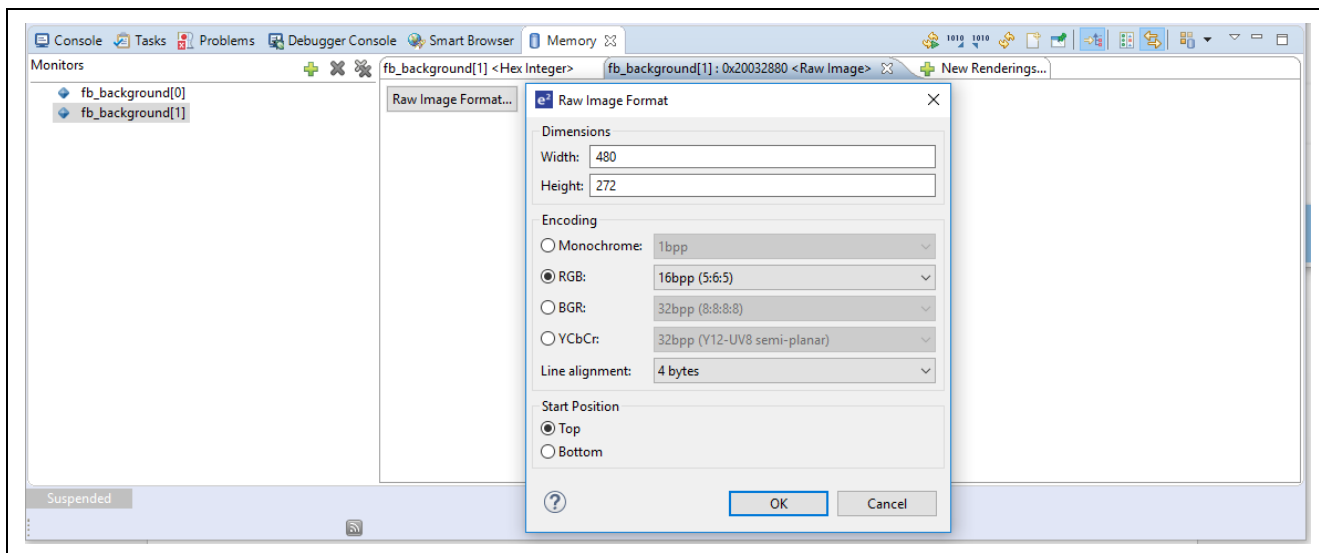

**Figure 58. Raw Image Format for Graphics Application on EK-RA6M3G**

Once you press the **OK** key, the memory monitor presents you with the image that would be displayed at that memory address, based on the parameters you entered.



**Figure 59. Image Rendering Using Seen Using e<sup>2</sup> studio Memory Monitor**

## 10. Website and Support

Visit the following URLs to learn about key elements of the RA family, download components and related documentation, and get support.

RA Product Information

[www.renesas.com/ra](http://www.renesas.com/ra)

RA Product Support Forum

[www.renesas.com/ra/forum](http://www.renesas.com/ra/forum)

RA Flexible Software Package

[www.renesas.com/FSP](http://www.renesas.com/FSP)

Renesas Support

[www.renesas.com/support](http://www.renesas.com/support)

**Revision History**

| Rev. | Date      | Description |   |
|------|-----------|-------------|---|
|      |           | Page        | Summary   |
| 1.00 | Jul.13.20 | -           | Initial version                                       |
| 2.00 | Nov.11.21 | -           | Major updates for AppWizard v1.24_6.20                |
| 2.10 | Jun.28.23 | -           | Minor updates for AppWizard v1.36a_6.32a + FSP v4.4.0 |
| 2.20 | May.20.24 | -           | Minor updates for AppWizard v1.42_6.36 + FSP v5.2.0   |

# General Precautions in the Handling of Microprocessing Unit and Microcontroller Unit Products

The following usage notes are applicable to all Microprocessing unit and Microcontroller unit products from Renesas. For detailed usage notes on the products covered by this document, refer to the relevant sections of the document as well as any technical updates that have been issued for the products.

## 1. Precaution against Electrostatic Discharge (ESD)

A strong electrical field, when exposed to a CMOS device, can cause destruction of the gate oxide and ultimately degrade the device operation. Steps must be taken to stop the generation of static electricity as much as possible, and quickly dissipate it when it occurs. Environmental control must be adequate. When it is dry, a humidifier should be used. This is recommended to avoid using insulators that can easily build up static electricity.

Semiconductor devices must be stored and transported in an anti-static container, static shielding bag or conductive material. All test and measurement tools including work benches and floors must be grounded. The operator must also be grounded using a wrist strap. Semiconductor devices must not be touched with bare hands. Similar precautions must be taken for printed circuit boards with mounted semiconductor devices.

## 2. Processing at power-on

The state of the product is undefined at the time when power is supplied. The states of internal circuits in the LSI are indeterminate and the states of register settings and pins are undefined at the time when power is supplied. In a finished product where the reset signal is applied to the external reset pin, the states of pins are not guaranteed from the time when power is supplied until the reset process is completed. In a similar way, the states of pins in a product that is reset by an on-chip power-on reset function are not guaranteed from the time when power is supplied until the power reaches the level at which resetting is specified.

## 3. Input of signal during power-off state

Do not input signals or an I/O pull-up power supply while the device is powered off. The current injection that results from input of such a signal or I/O pull-up power supply may cause malfunction and the abnormal current that passes in the device at this time may cause degradation of internal elements. Follow the guideline for input signal during power-off state as described in your product documentation.

## 4. Handling of unused pins

Handle unused pins in accordance with the directions given under handling of unused pins in the manual. The input pins of CMOS products are generally in the high-impedance state. In operation with an unused pin in the open-circuit state, extra electromagnetic noise is induced in the vicinity of the LSI, an associated shoot-through current flows internally, and malfunctions occur due to the false recognition of the pin state as an input signal become possible.

## 5. Clock signals

After applying a reset, only release the reset line after the operating clock signal becomes stable. When switching the clock signal during program execution, wait until the target clock signal is stabilized. When the clock signal is generated with an external resonator or from an external oscillator during a reset, ensure that the reset line is only released after full stabilization of the clock signal. Additionally, when switching to a clock signal produced with an external resonator or by an external oscillator while program execution is in progress, wait until the target clock signal is stable.

## 6. Voltage application waveform at input pin

Waveform distortion due to input noise or a reflected wave may cause malfunction. If the input of the CMOS device stays in the area between  $V_{IL}$  (Max.) and  $V_{IH}$  (Min.) due to noise, for example, the device may malfunction. Take care to prevent chattering noise from entering the device when the input level is fixed, and also in the transition period when the input level passes through the area between  $V_{IL}$  (Max.) and  $V_{IH}$  (Min.).

## 7. Prohibition of access to reserved addresses

Access to reserved addresses is prohibited. The reserved addresses are provided for possible future expansion of functions. Do not access these addresses as the correct operation of the LSI is not guaranteed.

## 8. Differences between products

Before changing from one product to another, for example to a product with a different part number, confirm that the change will not lead to problems. The characteristics of a microprocessing unit or microcontroller unit products in the same group but having a different part number might differ in terms of internal memory capacity, layout pattern, and other factors, which can affect the ranges of electrical characteristics, such as characteristic values, operating margins, immunity to noise, and amount of radiated noise. When changing to a product with a different part number, implement a system-evaluation test for the given product.



## Notice

Descriptions of circuits, software and other related information in this document are provided only to illustrate the operation of semiconductor products and application examples. You are fully responsible for the incorporation or any other use of the circuits, software, and information in the design of your product or system. Renesas Electronics disclaims any and all liability for any losses and damages incurred by you or third parties arising from the use of these circuits, software, or information.

2. Renesas Electronics hereby expressly disclaims any warranties against and liability for infringement or any other claims involving patents, copyrights, or other intellectual property rights of third parties, by or arising from the use of Renesas Electronics products or technical information described in this document, including but not limited to, the product data, drawings, charts, programs, algorithms, and application examples.
3. No license, express, implied or otherwise, is granted hereby under any patents, copyrights or other intellectual property rights of Renesas Electronics or others.
4. You shall be responsible for determining what licenses are required from any third parties, and obtaining such licenses for the lawful import, export, manufacture, sales, utilization, distribution or other disposal of any products incorporating Renesas Electronics products, if required.
5. You shall not alter, modify, copy, or reverse engineer any Renesas Electronics product, whether in whole or in part. Renesas Electronics disclaims any and all liability for any losses or damages incurred by you or third parties arising from such alteration, modification, copying or reverse engineering.
6. Renesas Electronics products are classified according to the following two quality grades: "Standard" and "High Quality". The intended applications for each Renesas Electronics product depends on the product's quality grade, as indicated below.

"Standard": Computers; office equipment; communications equipment; test and measurement equipment; audio and visual equipment; home electronic appliances; machine tools; personal electronic equipment; industrial robots; etc.

"High Quality": Transportation equipment (automobiles, trains, ships, etc.); traffic control (traffic lights); large-scale communication equipment; key financial terminal systems; safety control equipment; etc.

Unless expressly designated as a high reliability product or a product for harsh environments in a Renesas Electronics data sheet or other Renesas Electronics document, Renesas Electronics products are not intended or authorized for use in products or systems that may pose a direct threat to human life or bodily injury (artificial life support devices or systems; surgical implantations; etc.), or may cause serious property damage (space system; undersea repeaters; nuclear power control systems; aircraft control systems; key plant systems; military equipment; etc.). Renesas Electronics disclaims any and all liability for any damages or losses incurred by you or any third parties arising from the use of any Renesas Electronics product that is inconsistent with any Renesas Electronics data sheet, user's manual or other Renesas Electronics document.

7. No semiconductor product is absolutely secure. Notwithstanding any security measures or features that may be implemented in Renesas Electronics hardware or software products, Renesas Electronics shall have absolutely no liability arising out of any vulnerability or security breach, including but not limited to any unauthorized access to or use of a Renesas Electronics product or a system that uses a Renesas Electronics product. RENESAS ELECTRONICS DOES NOT WARRANT OR GUARANTEE THAT RENESAS ELECTRONICS PRODUCTS, OR ANY SYSTEMS CREATED USING RENESAS ELECTRONICS PRODUCTS WILL BE INVULNERABLE OR FREE FROM CORRUPTION, ATTACK, VIRUSES, INTERFERENCE, HACKING, DATA LOSS OR THEFT, OR OTHER SECURITY INTRUSION ("Vulnerability Issues"). RENESAS ELECTRONICS DISCLAIMS ANY AND ALL RESPONSIBILITY OR LIABILITY ARISING FROM OR RELATED TO ANY VULNERABILITY ISSUES. FURTHERMORE, TO THE EXTENT PERMITTED BY APPLICABLE LAW, RENESAS ELECTRONICS DISCLAIMS ANY AND ALL WARRANTIES, EXPRESS OR IMPLIED, WITH RESPECT TO THIS DOCUMENT AND ANY RELATED OR ACCOMPANYING SOFTWARE OR HARDWARE, INCLUDING BUT NOT LIMITED TO THE IMPLIED WARRANTIES OF MERCHANTABILITY, OR FITNESS FOR A PARTICULAR PURPOSE.
8. When using Renesas Electronics products, refer to the latest product information (data sheets, user's manuals, application notes, "General Notes for Handling and Using Semiconductor Devices" in the reliability handbook, etc.), and ensure that usage conditions are within the ranges specified by Renesas Electronics with respect to maximum ratings, operating power supply voltage range, heat dissipation characteristics, installation, etc. Renesas Electronics disclaims any and all liability for any malfunctions, failure or accident arising out of the use of Renesas Electronics products outside of such specified ranges.
9. Although Renesas Electronics endeavors to improve the quality and reliability of Renesas Electronics products, semiconductor products have specific characteristics, such as the occurrence of failure at a certain rate and malfunctions under certain use conditions. Unless designated as a high reliability product or a product for harsh environments in a Renesas Electronics data sheet or other Renesas Electronics document, Renesas Electronics products are not subject to radiation resistance design. You are responsible for implementing safety measures to guard against the possibility of bodily injury, injury or damage caused by fire, and/or danger to the public in the event of a failure or malfunction of Renesas Electronics products, such as safety design for hardware and software, including but not limited to redundancy, fire control and malfunction prevention, appropriate treatment for aging degradation or any other appropriate measures. Because the evaluation of microcomputer software alone is very difficult and impractical, you are responsible for evaluating the safety of the final products or systems manufactured by you.
10. Please contact a Renesas Electronics sales office for details as to environmental matters such as the environmental compatibility of each Renesas Electronics product. You are responsible for carefully and sufficiently investigating applicable laws and regulations that regulate the inclusion or use of controlled substances, including without limitation, the EU RoHS Directive, and using Renesas Electronics products in compliance with all these applicable laws and regulations. Renesas Electronics disclaims any and all liability for damages or losses occurring as a result of your noncompliance with applicable laws and regulations.
11. Renesas Electronics products and technologies shall not be used for or incorporated into any products or systems whose manufacture, use, or sale is prohibited under any applicable domestic or foreign laws or regulations. You shall comply with any applicable export control laws and regulations promulgated and administered by the governments of any countries asserting jurisdiction over the parties or transactions.
12. It is the responsibility of the buyer or distributor of Renesas Electronics products, or any other party who distributes, disposes of, or otherwise sells or transfers the product to a third party, to notify such third party in advance of the contents and conditions set forth in this document.
13. This document shall not be reprinted, reproduced or duplicated in any form, in whole or in part, without prior written consent of Renesas Electronics.
14. Please contact a Renesas Electronics sales office if you have any questions regarding the information contained in this document or Renesas Electronics products.

(Note1) "Renesas Electronics" as used in this document means Renesas Electronics Corporation and also includes its directly or indirectly controlled subsidiaries.

(Note2) "Renesas Electronics product(s)" means any product developed or manufactured by or for Renesas Electronics.

(Rev.5.0-1 October 2020)

## Corporate Headquarters

TOYOSU FORESIA, 3-2-24 Toyosu,  
Koto-ku, Tokyo 135-0061, Japan

[www.renesas.com](http://www.renesas.com)

## Trademarks

Renesas and the Renesas logo are trademarks of Renesas Electronics Corporation. All trademarks and registered trademarks are the property of their respective owners.

## Contact information

For further information on a product, technology, the most up-to-date version of a document, or your nearest sales office, please visit:

[www.renesas.com/contact/](http://www.renesas.com/contact/).