

HS-117RH, HS-117EH

Radiation Hardened Adjustable Positive Voltage Regulator

FN4560
Rev.11.00
Mar 28, 2019

The radiation hardened [HS-117RH](#) and [HS-117EH](#) are adjustable positive voltage linear regulators capable of operating with input voltages up to 40V_{DC}. The HS-117EH encompasses all of the production testing of the HS-117RH and additionally is tested in the Enhanced Low Dose Rate Sensitivity (ELDRS) product manufacturing flow. The output voltage is adjustable from 1.25V to 37V with two external resistors. The device is capable of sourcing from 5mA to 1.25A max (0.5A max for the TO-39 package). Current protection is provided by the on-chip thermal shutdown and output current limiting circuitry.

The HS-117xH's advantage over other industry types is its incorporated circuitry that minimizes the effects of radiation and temperature on device stability.

The HS-117RH and HS-117EH are constructed in the dielectrically isolated Rad Hard Silicon Gate (RSG) process and are immune to single event latch-up and are specifically designed to provide highly reliable performance in harsh radiation environments.

Applications

- Adjustable voltage regulators
- Adjustable current regulators

Features

- Electrically screened to DLA SMD # [5962-99547](#)
- Superior temperature stability
- Overcurrent and over-temperature protection
- Wide input voltage range 4.25V to 40V
- Operating temperature range. -55°C to +125°C
- QML qualified per MIL-PRF-38535 requirements
- Radiation environment
 - SEL/SEB LET_{TH} (V_S = 40V) 87.4 MeV • cm²/mg
 - Total Dose, High Dose Rate 300krad(Si)
 - Total Dose, Low Dose Rate 100krad(Si)*

* Product capability established by initial characterization. The EH version is acceptance tested on a wafer-by-wafer basis to 50krad(Si) at low dose rate.

Related Literature

For a full list of related documents, visit our website

- [HS-117RH, HS-117EH](#) device pages

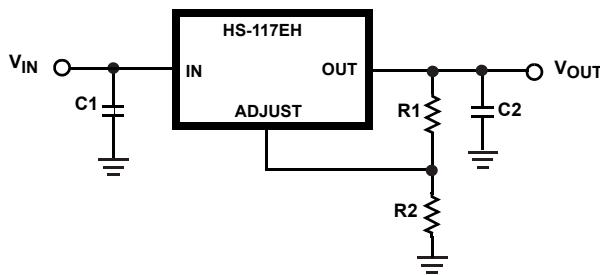

$V_{OUT} = V_{REF} (1+R2/R1) + I_{ADJ} R2$
FIGURE 1. TYPICAL APPLICATION

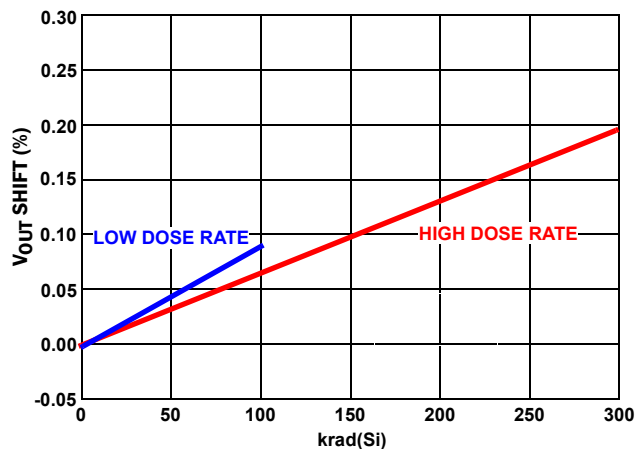
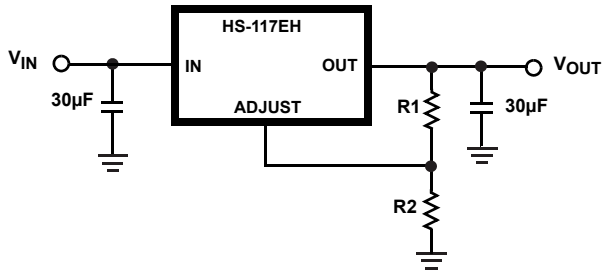

FIGURE 2. V_{OUT} SHIFT vs HIGH and LOW DOSE RATE RADIATION

Typical Applications



$$V_{OUT} = V_{REF} (1 + R2/R1) + I_{ADJ} * R2$$

FIGURE 3. RESISTOR ADJUSTED OUTPUT VOLTAGE

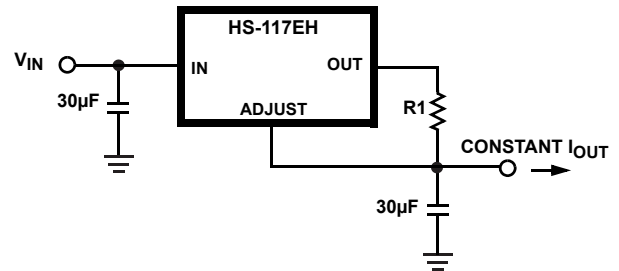

$$I_{OUT} = V_{REF} / R1$$

FIGURE 4. CONSTANT CURRENT REGULATOR

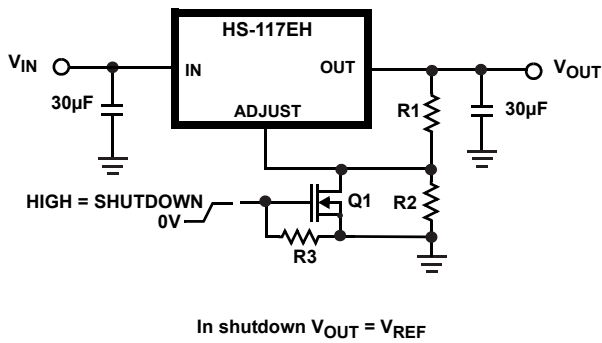

In shutdown $V_{OUT} = V_{REF}$

FIGURE 5. REGULATOR SHUTDOWN

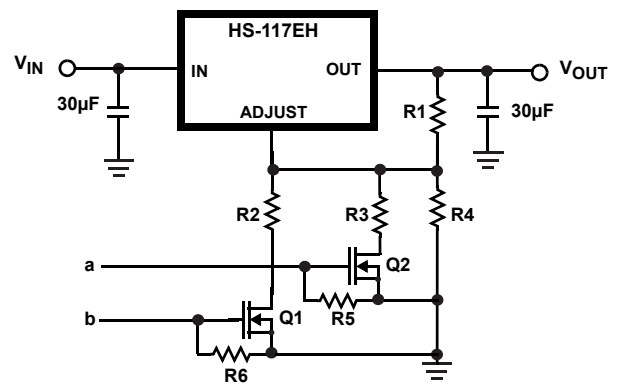
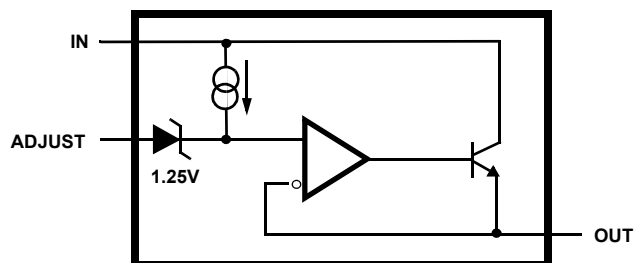

FIGURE 6. FOUR DIGITALLY PROGRAMMED OUTPUT VOLTAGES

Functional Block Diagram



Ordering Information

ORDERING SMD NUMBER (Note 2)	PART NUMBER (Note 1)	TEMPERATURE RANGE (°C)	PACKAGE (RoHS Compliant)	PKG. DWG. #
5962F9954702V9A	HS0-117EH-Q	-55 to +125	DIE	
5962F9954701V9A	HS0-117RH-Q	-55 to +125	DIE	
HS0-117RH/SAMPLE	HS0-117RH/SAMPLE (Note 3)	-55 to +125	DIE	
5962F9954702VUC	HS2-117EH-Q	-55 to +125	3 Ld METAL CAN	T3.C
5962F9954701VUC	HS2-117RH-Q	-55 to +125	3 Ld METAL CAN	T3.C
5962F9954701QUC	HS2-117RH-8	-55 to +125	3 Ld METAL CAN	T3.C
HS2-117RH/PROTO	HS2-117RH/PROTO (Note 3)	-55 to +125	3 Ld METAL CAN	T3.C
5962F9954702VYC	HSYE-117EH-Q	-55 to +125	3 PAD CLCC	J3.A
5962F9954701VYC	HSYE-117RH-Q	-55 to +125	3 PAD CLCC	J3.A
5962F9954701QYC	HSYE-117RH-8	-55 to +125	3 PAD CLCC	J3.A
HSYE-117RH/PROTO	HSYE-117RH/PROTO (Note 3)	-55 to +125	3 PAD CLCC	J3.A
5962F9954701VXC	HS9S-117RH-Q	-55 to +125	3 Ld TO-257	T3.D
5962F9954701QXC	HS9S-117RH-8	-55 to +125	3 Ld TO-257	T3.D
5962F9954702VXC	HS9S-117EH-Q	-55 to +125	3 Ld TO-257	T3.D
HS9S-117RH/PROTO	HS9S-117RH/PROTO (Note 3)	-55 to +125	3 Ld TO-257	T3.D

NOTES:

1. These Pb-free Hermetic packaged products employ 100% Au plate - e4 termination finish, which is RoHS compliant and compatible with both SnPb and Pb-free soldering operations.
2. Specifications for Rad Hard QML devices are controlled by the Defense Logistics Agency Land and Maritime (DLA). The SMD numbers listed must be used when ordering.
3. The /PROTO and /SAMPLE are not rated or certified for Total Ionizing Dose (TID) or Single Event Effect (SEE) immunity. These parts are intended for engineering evaluation purposes only. The /PROTO parts meet the electrical limits and conditions across temperature specified in the DLA SMD and are in the same form and fit as the qualified device. The /SAMPLE parts are capable of meeting the electrical limits and conditions specified in the DLA SMD at +25 °C only. The /SAMPLE parts do not receive 100% screening across temperature to the DLA SMD electrical limits. These part types do not come with a Certificate of Conformance because they are not DLA qualified devices.

Pin Configurations

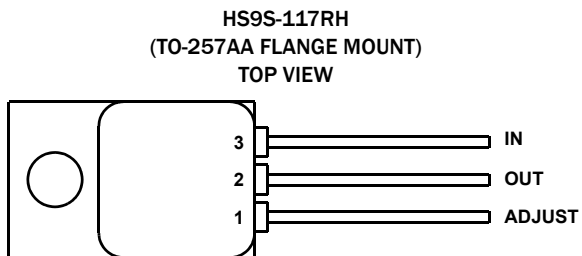
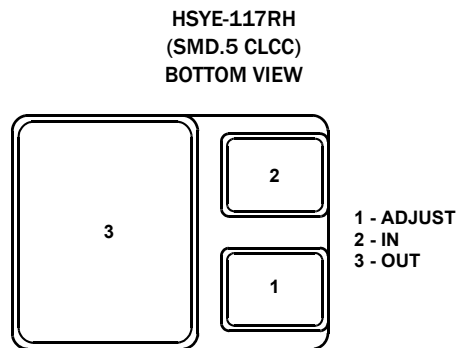
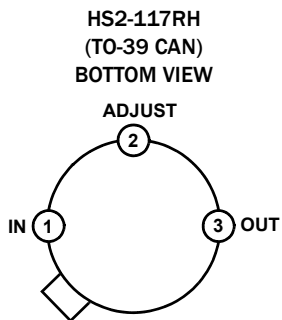

NOTE: No current JEDEC outline for the SMD.5 package. See SMD for package dimensions. The TO-257 is a totally isolated metal package.

Pin Descriptions

HS2-117RH (TO-39)	HS9S-117RH (TO-257AA)	HSYE-117RH (SMD.5 CLCC)	PIN NAME	DESCRIPTION
1	3	2	IN	Regulator Input
2	1	1	ADJUST	Voltage Adjust Feedback Input
3	2	3	OUT	Regulator Output

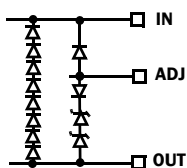

Absolute Maximum Ratings

Input to Output Voltage Differential	40V
Input to Output Voltage Differential (Note 6)	40V
Maximum Output Current	1.5A
Maximum Power Dissipation $T_C = +25^\circ\text{C}$	
HS2-117 (TO-39 Can)	.8W
HS9S-117 (TO-257AA Flange Mount)	50W
HSYE-117 (SMD.5 CLCC)	27.5W
Maximum Power Dissipation $T_C = +100^\circ\text{C}$ (Note 7)	
HS2-117 (TO-39 Can)	3.3W
HS9S-117 (TO-257AA Flange Mount)	20W
HSYE-117 (SMD.5 CLCC)	11W
ESD Rating	
Human Body Model (HBM) (Tested per MIL-PRF-883 3015.7)	1500V
Machine Model (MM) (Tested per EIA/JESD22-A115-A)	350V

Thermal Information

Thermal Resistance (Typical)	θ_{JA} ($^\circ\text{C}/\text{W}$)	θ_{JC} ($^\circ\text{C}/\text{W}$)
TO-39 (Notes 4, 5, 7)	125	15
TO-257AA (Notes 4, 5, 7)	26	2.5
SMD.5 (Notes 4, 5, 7)	42	4.5
Maximum Storage Temperature Range	-65 $^\circ\text{C}$ to +150 $^\circ\text{C}$	
Maximum Junction Temperature (T_{JMAX})	+175 $^\circ\text{C}$	

Recommended Operating Conditions

Ambient Operating Temperature Range	-55 $^\circ\text{C}$ to +125 $^\circ\text{C}$
Input Voltage Range	4.25V to 40V
Output Voltage Range	1.25V to 37V
Minimum Output Current	5mA

CAUTION: Do not operate at or near the maximum ratings listed for extended periods of time. Exposure to such conditions can adversely impact product reliability and result in failures not covered by warranty.

NOTES:

- θ_{JA} is measured with the component mounted on a high-effective thermal conductivity test board in free air. See TB379 for details.
- For θ_{JC} , the “case temp” location is the center of the exposed metal pad on the package underside.
- The maximum supply limit specified is for operation in a heavy ion environment at an LET = 87.4MeV • cm²/mg.
- The linear derating factor for TO-39 package is 0.067 W/ $^\circ\text{C}$, for TO-257AA package is 0.4 W/ $^\circ\text{C}$, for the SMD.5 package is 0.22 W/ $^\circ\text{C}$

Electrical Specifications $V_{DIFF} = 3V, T_A = 25^\circ\text{C}$, unless otherwise noted. Boldface limits apply across the operating temperature range, -55 $^\circ\text{C}$ to +125 $^\circ\text{C}$.

PARAMETER	SYMBOL	TEST CONDITIONS	MIN (Note 8)	TYP	MAX (Note 8)	UNIT
Reference Voltage	V_{REF}	$V_{DIFF} = 3V, V_{DIFF} = 40V,$ $5.0mA \leq I_{OUT} \leq 5.5mA$	1.20	1.255	1.30	V
Line Regulation	R_{LINE}	$V_{REF} = V_{OUT} - V_{ADJ}, 3V \leq V_{DIFF} \leq 40V,$ $5.0mA \leq I_{OUT} \leq 5.5mA$	-0.02	0.005	0.02	%
Load Regulation	R_{LOAD}	$V_{DIFF} = 3V, 5mA \leq I_{OUT} \leq 1.25A$ TO-257AA and SMD.5 packages only	-1.5	-0.1	1.5	%
		$V_{DIFF} = 3V, 5mA \leq I_{OUT} \leq 500mA$ TO-39 package	-1.5	-0.8	1.5	%
Adjust Pin Current	I_{ADJ}	$V_{DIFF} = 3V, V_{DIFF} = 40V,$ $5.0mA \leq I_{OUT} \leq 5.5mA$		64	100	μA
Adjust Pin Current Change	dI_{ADJ}	$3V I_{ADJ} - 40V I_{ADJ}$ $5.0mA \leq I_{OUT} \leq 5.5mA$	-6	2.36	6	μA
Maximum Output Current	I_{OUT}	TO-257AA and SMD.5 packages only	1.25			A
		TO-39 package	0.5			A
V_{IN} Applied to V_{OUT} Turn-On	T_{ON}			0.2		ms
Max. Output Short-Circuit Current Limit	I_{sc}	$V_{OUT} = 0V$		3		A
Over-Temperature Shutdown	OT			150	175	$^\circ\text{C}$
Over-Temperature Hysteresis	OT_HYS			20		$^\circ\text{C}$

Post Radiation Electrical Specifications $V_{DIFF} = 3V, T_A = +25^\circ C$, unless otherwise noted. **Boldface limits apply over a total ionizing dose of 300krad(Si) with exposure at a high dose rate of 50 to 300krad(Si)/s; or over a total ionizing dose of 50krad(Si) with exposure a low dose rate of <10mrad(Si)/s.**

PARAMETER	SYMBOL	CONDITIONS	MIN (Note 8)	MAX (Note 8)	UNIT
Reference Voltage	V_{REF}	$V_{DIFF} = 3V, V_{DIFF} = 40V, 5.0mA \leq I_{OUT} \leq 5.5mA$	1.20	1.30	V
Line Regulation	R_{LINE}	$V_{REF} = V_{OUT} - V_{ADJ}, 3V \leq V_{DIFF} \leq 40V, 5.0mA \leq I_{OUT} \leq 5.5mA$	-0.02	0.02	%
Load Regulation	R_{LOAD}	$V_{DIFF} = 3V, 5mA \leq I_{OUT} \leq 1.25A$ (TO-257AA and SMD.5 packages only)	-1.5	1.5	%
		$V_{DIFF} = 3V, 5mA \leq I_{OUT} \leq 500mA$ (TO-39 package)	-1.5	1.5	%
Adjust Pin Current	I_{ADJ}	$V_{DIFF} = 3V, V_{DIFF} = 40V, 5.0mA \leq I_{OUT} \leq 5.5mA$		100	μA
Adjust Pin Current Change	dI_{ADJ}	$3V I_{ADJ} - 40V I_{ADJ}, 5.0mA \leq I_{OUT} \leq 5.5mA$	-6	6	μA
Output Current	I_{OUT}	TO-257AA and SMD.5 packages only	1.25		A
		TO-39 package	0.5		A

NOTE:

8. Compliance to datasheet limits is assured by one or more methods: production test, characterization, and/or design.

Post Radiation Characteristics This data is a typical mean test data post total dose radiation exposure at both a low dose rate (LDR) of <10mrad(Si)/s to 100krad(Si) and at a high dose rate (HDR) of 50 to 300krad(Si)/s to 300krad(Si). This data is intended to show typical parameter shifts due to low dose rate radiation. These are not limits nor are they guaranteed.

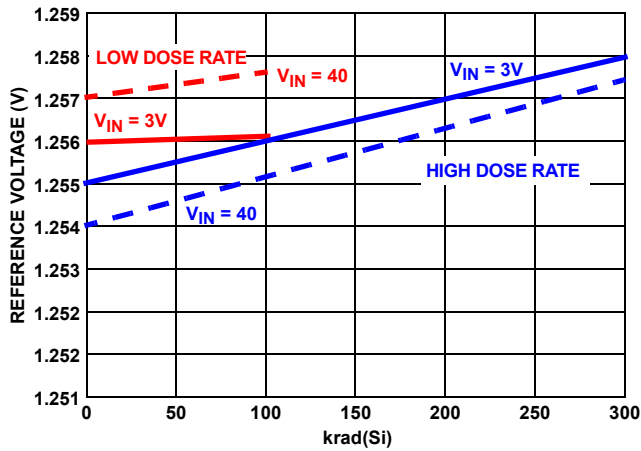

FIGURE 7. REFERENCE VOLTAGE vs RADIATION

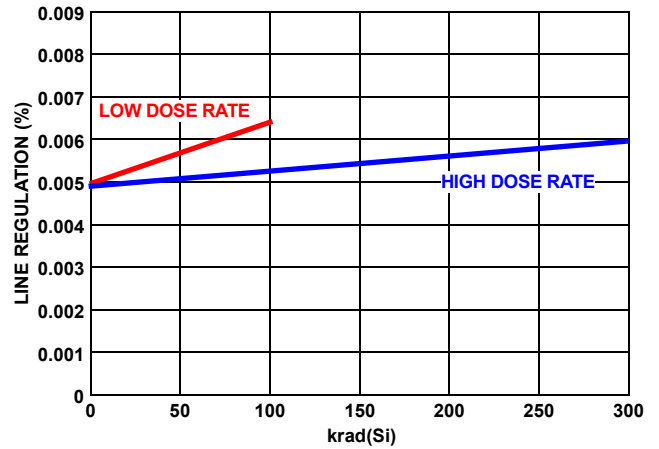

FIGURE 8. LINE REGULATION ($3V \leq V_{DIFF} \leq 40V$) vs RADIATION

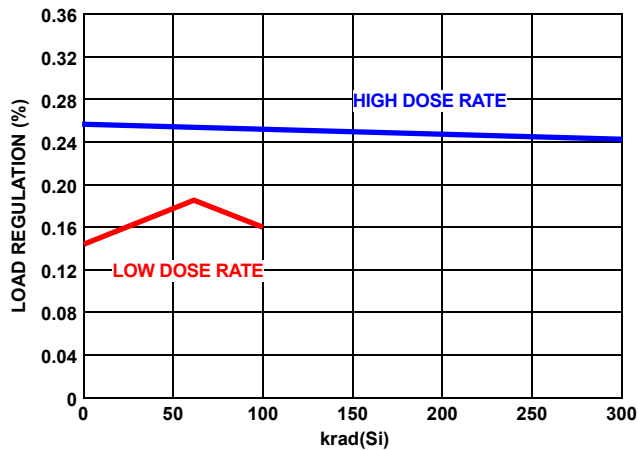

FIGURE 9. LOAD REGULATION ($I_{OUT} 5mA$ to $1.25A$) vs RADIATION

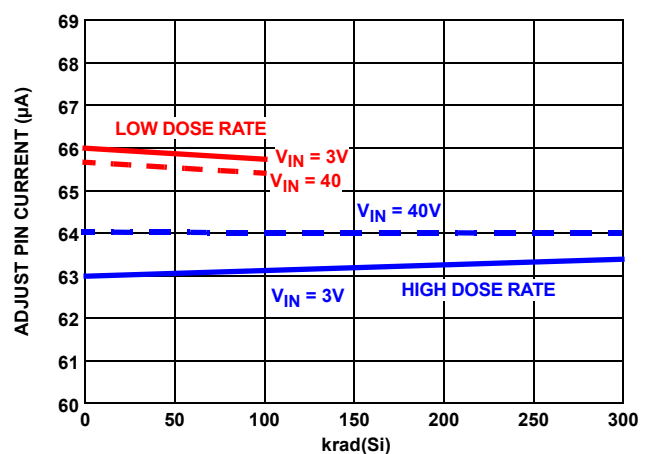

FIGURE 10. ADJUST PIN CURRENT vs RADIATION

Typical Performance Curves

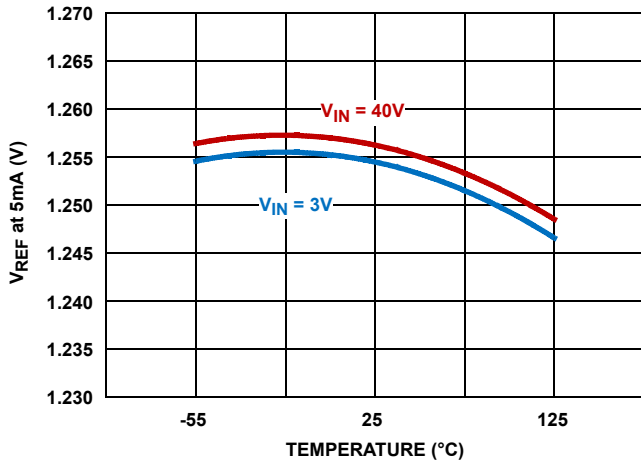

FIGURE 11. V_{REF} vs TEMPERATURE

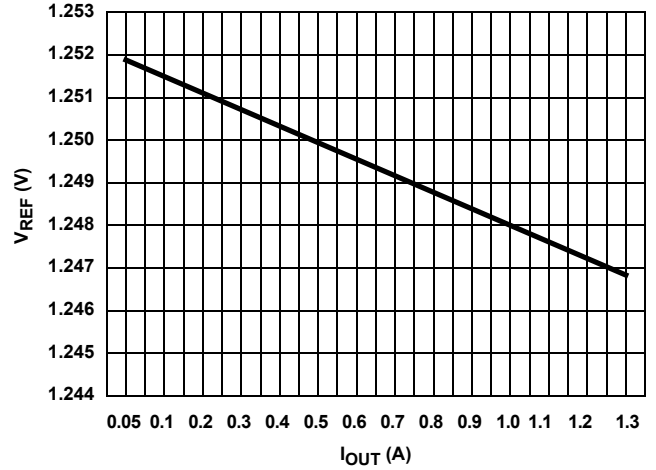

FIGURE 12. V_{REF} vs OUTPUT CURRENT at $T_A = +25^\circ\text{C}$

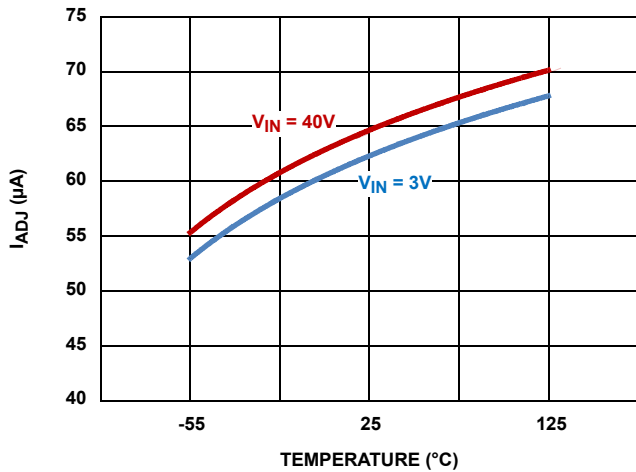

FIGURE 13. I_{ADJ} vs TEMPERATURE

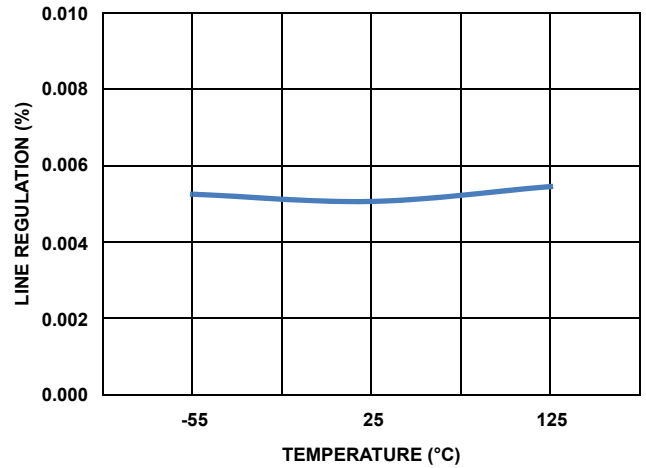

FIGURE 14. LINE REGULATION vs TEMPERATURE

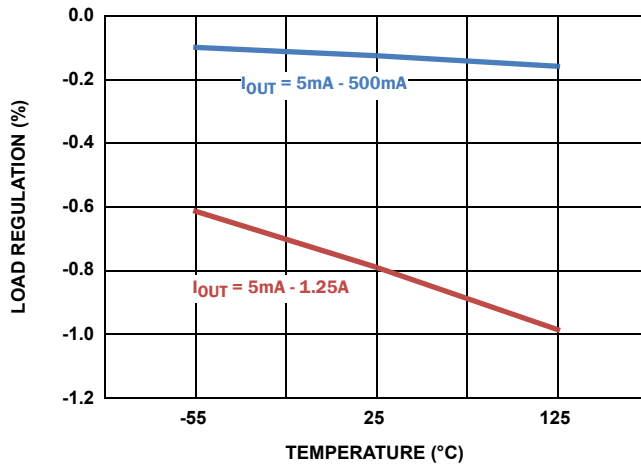

FIGURE 15. LOAD REGULATION vs TEMPERATURE

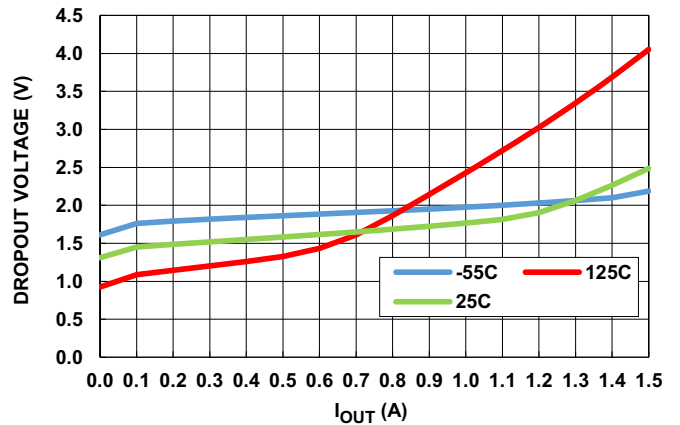

FIGURE 16. DROPOUT VOLTAGE vs OUTPUT CURRENT, $V_{IN} = 12\text{V}$

Typical Performance Curves (Continued)

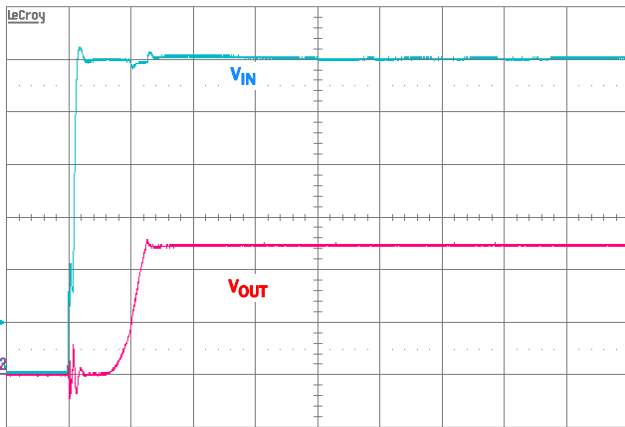

FIGURE 17. POWER-ON $V_{IN} = 12V$, $V_{OUT} = 5V$, $R_I = 10\Omega$

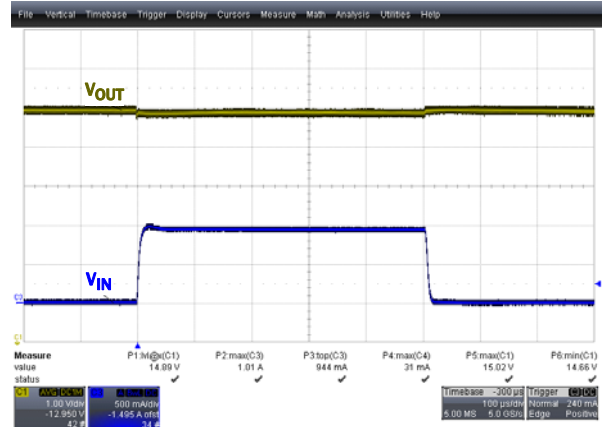

FIGURE 18. $V_{IN} = 30V$, $V_{OUT} = 15V$, I_{OUT} 0 -1A STEP

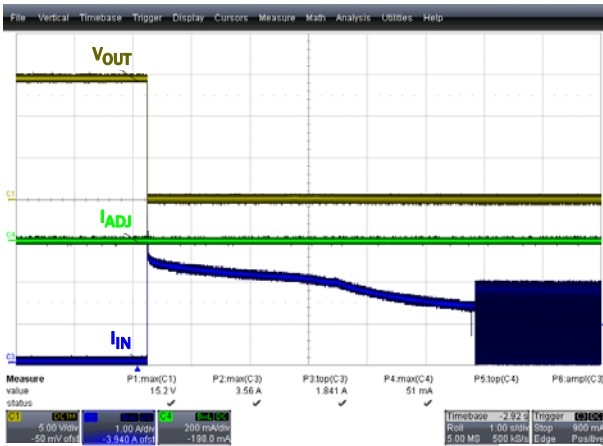

FIGURE 19. SHORT-CIRCUIT INTO OVER-TEMPERATURE PROTECTION

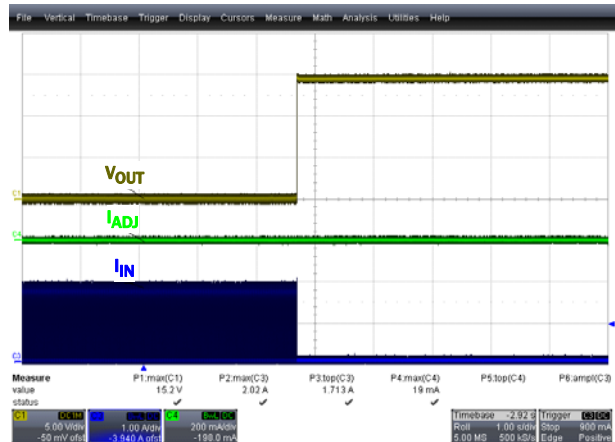

FIGURE 20. SHORT-CIRCUIT RECOVERY

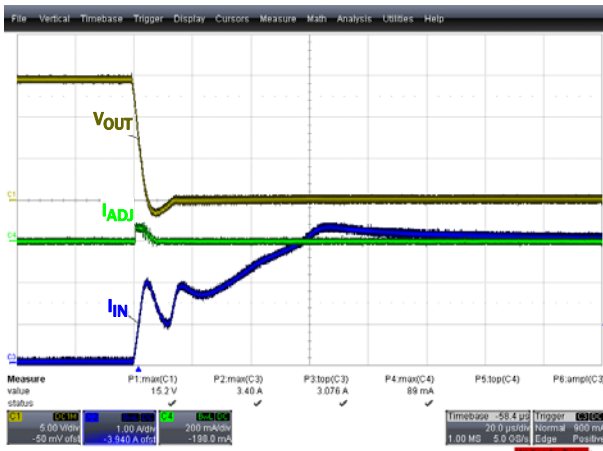

FIGURE 21. SHORT-CIRCUIT CURRENT LIMIT DETAIL

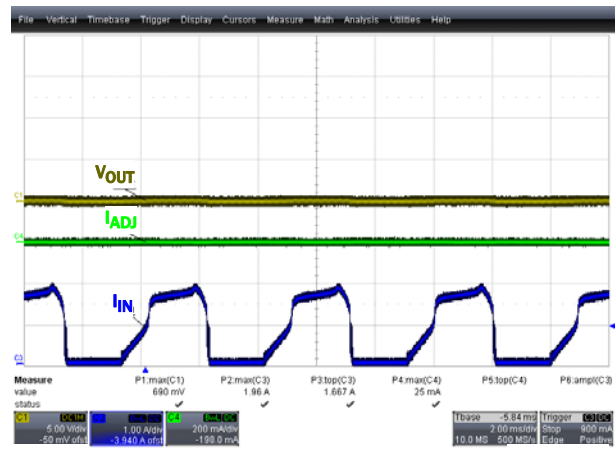

FIGURE 22. SHORT-CIRCUIT OVER-TEMPERATURE PROTECTION DETAIL

Functional Description

Functional Overview

The radiation hardened HS-117RH and HS-117EH are adjustable positive voltage linear regulators capable of operating with input voltages up to 40V_{DC}. The output voltage is adjustable from 1.25V (V_{REF}) to 37V with two external resistors. The device is capable of sourcing from 5mA to 1.25A_{PEAK} (0.5A_{PEAK} for the TO-39 can package). Dual mode protection is provided by the on-chip +175 °C thermal shutdown at output current limiting circuitry.

The HS-117xH's advantage over other industry types is its incorporated circuitry that minimizes the effects of radiation and temperature on device stability providing < 0.2% shifts in output voltage over 300krad(Si) of High Dose Rate (HDR) and 100krad(Si) of Low Dose Rate (LDR) gamma radiation.

The HS-117RH and HS-117EH are constructed in the dielectrically isolated Rad Hard Silicon Gate (RSG) process and are both immune to single event latch-up and are specifically designed to provide highly reliable performance providing power in harsh radiation environments.

Output Voltage Adjustment

The HS-117 is an adjustable output voltage regulator operating with a 1.25V reference voltage developed between the OUT and ADJUST pins. The ADJ current (I_{ADJ}) is typically 64µA at +25 °C and 100µA maximum over temperature.

The HS-117's minimum current load for the regulation amplifier feedback to maintain stability is 5mA. To ensure stability in all situations, the minimum resistor between the V_{OUT} and ADJ should be 120Ω.

Referring to [Figure 1 on page 1](#), the reference voltage is programmed to a constant current source by resistor R₁, and this current flows through R₂ to ground to set the output voltage. See [Equation 1](#).

$$V_{OUT} = 1.25(1 + R_2/R_1) + I_{ADJ}R_2 \quad (\text{EQ. 1})$$

In practical applications the R₂ value is in the range of a few kΩ, so that the I_{ADJ} x R₂ contribution can be ignored in the V_{OUT} calculation; simplifying the V_{OUT} calculation to [Equation 2](#):

$$V_{OUT} = 1.25(1 + R_2/R_1) \quad (\text{EQ. 2})$$

CURRENT LIMITING

The HS-117 has internal current limiting that is activated whenever the output current exceeds the lower limit of the Maximum Output Current parameter shown in the [“Electrical Specifications” on page 5](#), (typically limiting to ~1.5A) to a maximum limit of typically 3A in an output short-circuit condition.

During a short-circuit condition, if the regulator's differential voltage exceeds the Absolute Maximum Rating of 40V (for example, V_{IN} ≥ 40V, V_{OUT} = 0V), the device can be damaged.

Performance and PCB Layout Considerations

To optimize load regulation performance, implement Kelvin connections for the R₁ and R₂ resistors. In practice, the R₁ connection must be close to the OUT and ADJUST pins. This connection eliminates PCB trace resistance being included in the constant current determination. In contrast, place the R₂ to ground connection as close as possible to the negative load pin to ensure that the voltage being delivered to the load is as designed for by the choice of R₁ and R₂ values.

Ripple rejection can be improved by placing a 10µF capacitor across the R₂ resistor. At low output voltage, increasing this capacitor value further decreases output ripple.

External Bypass Capacitors

Input bypass capacitance is recommended to enhance regulator stability if the device is located more than a few inches from its power source. Mount the input bypass capacitor (C₁) with the shortest possible track length directly across the regulator's input and ground terminals. A 30µF tantalum capacitor should be adequate for most applications. Frequency compensation for the regulator is provided by the output capacitor (C₂) and is required to ensure output stability. A minimum (C₂) capacitance value of 30µF is recommended. Higher values of output capacitance can be used to enhance loop stability, transient response, and output noise.

Thermal Considerations

The HS-117 has a thermal limiting circuit that is designed to protect the regulator when the junction temperature is typically > +150 °C. The regulator output turns off and then on again as the die cools. If the device is continuously operated in an over-temperature condition, this feature provides protection from catastrophic device damage due to accidental or prolonged overheating.

The HS-117 is available in a TO-39 3 pin can, a TO-257AA flange mount, and a SMD.5 CLCC surface mount package. These packages represent a wide range of thermal resistance to the die and thus a wide range of power dissipation (P_D) capabilities. See [“Thermal Information” on page 5](#) for the relevant package thermal impedances. The [“Absolute Maximum Ratings” on page 5](#) lists the power dissipation limitations by package.

When developing circuits using the HS-117, test thermal performance and limitations to ensure acceptable performance. As with all tabbed packaged devices, flange mounting to a thermal heat-sink is recommended for the TO-257AA best practices.

T0-257AA Package Characteristics

Weight of Packaged Device

4.50g (Typical)

Case Characteristics

Finish: Gold
Potential: Unbiased

T0-39 Package Characteristics

Weight of Packaged Device

0.91g (Typical)

Case Characteristics

Finish: Steel, Gold
Potential: Unbiased

SMD.5 CLCC Package Characteristics

Weight of Packaged Device

0.91g (Typical)

Case Characteristics

Finish: Gold, Ceramic
Potential: Unbiased

Die Characteristics

Die Dimensions

2616 μ m x 2794 μ m (103 mils x 110 mils)
Thickness: 483 μ m \pm 25 μ m (19 mils \pm 1 mil)

Interface Materials

GLASSIVATION

Type: PSG
Thickness: 8k Å \pm 1k Å

TOP METALLIZATION

Type: Al/Cu/Si (98.75%/0.5%/0.75%)
Thickness: 16k Å

BACKSIDE FINISH

Gold

Assembly Related Information

SUBSTRATE POTENTIAL

Unbiased (DI)

Additional Information

WORST CASE CURRENT DENSITY

$< 2 \times 10^5$ A/cm²

PROCESS

Dielectrically Isolated RH - Si-GATE

TRANSISTOR COUNT:

96

Metallization Mask Layout

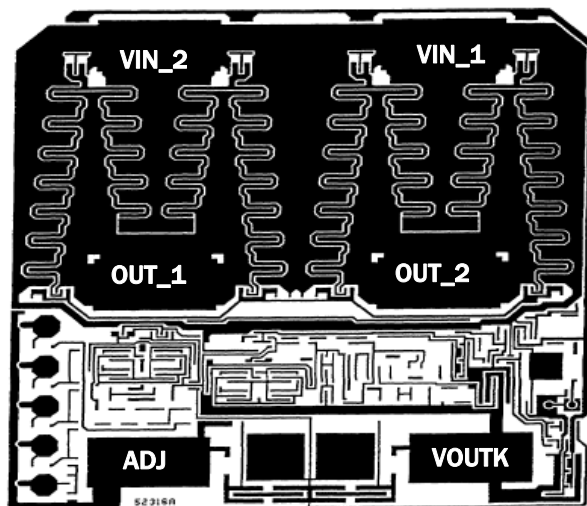

TABLE 1. DIE LAYOUT X-Y COORDINATES (Notes 9, 10)

PAD NAME	X (μm)	Y (μm)	dX (μm)	dY (μm)
VIN_1	1214	2191	514	257
VIN_2	14	2191	514	257
VOUT_1	14	934	514	257
ADJ	0	0	514	257
VOUTK	1361	14	514	257
VOUT_2	1214	934	514	257

NOTES:

- 9. Origin of coordinates is the centroid of pad ADJ.
- 10. Bond Pads sized for is 5mil diameter wire.

Revision History The revision history provided is for informational purposes only and is believed to be accurate, but not warranted. Please visit our website to make sure you have the latest revision.

DATE	REVISION	CHANGE
Mar 28, 2019	FN4560.11	Updated links throughout document. Updated Related Literature section. Updated SEL/SEB LET _{TH} information in Features section on page 1. Added Note 3. Updated Figure 16. Removed About Intersil section. Updated POD J3.A to the latest revision, changes are as follows: -Updated Max value for Symbol A from: 0.124inches/3.15mm to: 0.122inches/3.10mm Updated Disclaimer
Mar 25, 2014	FN4560.10	Updated "Ordering Information on page 3. Expanded content in datasheet from 3 to 15 pages.
Sep 4, 2012	FN4560.9	Added HS-117EH as Device # to datasheet (EH FGs already added to the Ordering Information table), making this a 2-part datasheet: HS-117RH, HS-117EH. Global search/change HS-117RH to HS-117RH, HS-117EH.
Dec 15, 2011	FN4560.8	Added parts to datasheet: HS2-117EH-Q, HS0-117EH-Q, HS9S-117EH-Q and HSYE-117EH-Q
Oct 10, 2003	FN4560.7	Revised datasheet includes a new date and file number.

Package Outline Drawings

For the most recent package outline drawing, see [J3.A](#).

J3.A
 3 Pad Hermetic SMD.5 Package
 Bottom Terminal Ceramic Leadless Chip Carrier (CLCC)

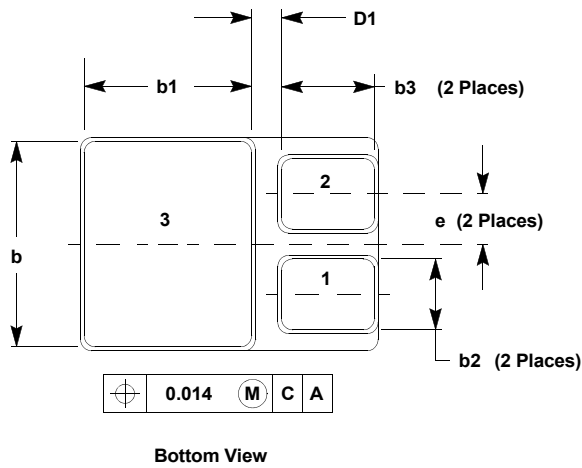
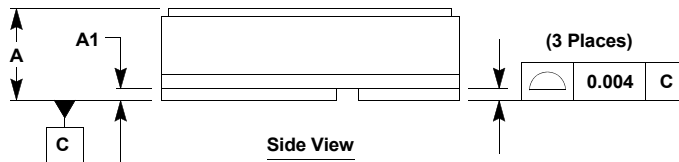
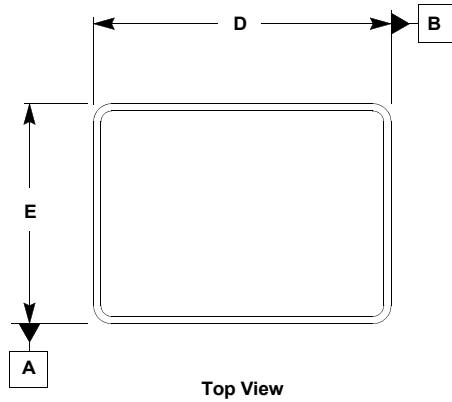

Symbol	Inches		Millimeters		Notes
	Min	Max	Min	Max	
A	0.110	0.122	2.79	3.10	3
A1	0.010	0.020	0.25	0.51	-
b	0.281	0.291	7.13	7.39	-
b1	0.220	0.230	5.58	5.84	-
b2	0.090	0.100	2.28	2.54	-
b3	0.115	0.125	2.92	3.18	-
D	0.395	0.405	10.03	10.28	-
D1	0.030	-	0.76	-	-
E	0.291	0.301	7.39	7.64	-
e	0.075 BSC		1.91 BSC		-

Rev. 3 11/18

Notes:

1. Controlling dimensions are in inches (mm for reference only).
2. Dimensioning and tolerance per ANSI Y14.5M - 1982.
3. The maximum "A" dimension is package height before being solder dipped.
4. Patterned after MIL-STD-1835 CBCC1-N3 (C-B1) Note: Not meeting the Mil-Std "A" minimum dimension of 0.112.

Metal Can Package

For the most recent package outline drawing, see [T3.C](#).

T3.C

3 LEAD TO-39 (TO-205) METAL CAN PACKAGE

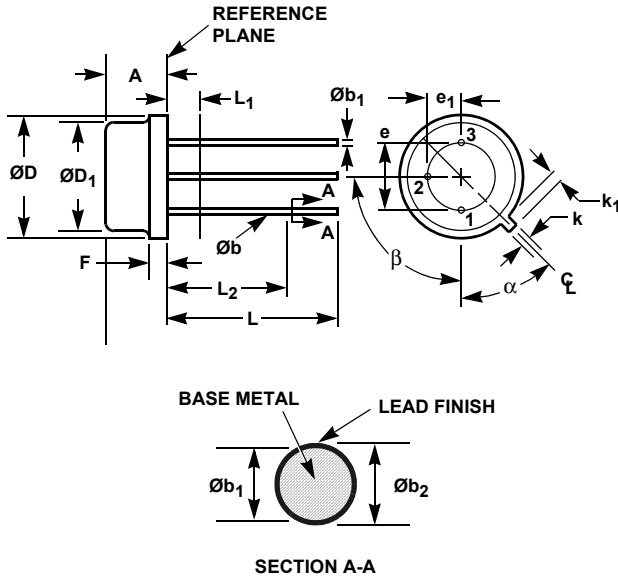

SYMBOL	INCHES		MILLIMETERS		NOTES
	MIN	MAX	MIN	MAX	
A	0.160	0.180	4.07	4.58	-
Øb	0.016	0.019	0.41	0.48	1
Øb ₁	0.016	0.021	0.41	0.53	1
Øb ₂	0.016	0.024	0.41	0.61	-
ØD	0.350	0.370	8.89	9.40	-
ØD ₁	0.315	0.335	8.00	8.51	-
e	0.200 BSC		5.08 BSC		-
e ₁	0.100 BSC		2.54 BSC		-
F	0.009	0.050	0.23	1.27	-
k	0.027	0.034	0.69	0.086	-
k ₁	0.027	0.045	0.69	1.14	2
L	0.500	0.750	12.70	19.05	1
L ₁	-	0.050	-	1.27	1
L ₂	0.250	-	6.35	-	1
α	45° BSC		45° BSC		3
β	90° BSC		90° BSC		-
N	3		3		4

Rev. 0 6/01

NOTES:

1. (All leads) Øb applies between L₁ and L₂. Øb₁ applies between L₂ and 0.500 from the reference plane. Diameter is uncontrolled in L₁ and beyond 0.500 from the reference plane.
2. Measured from maximum diameter of the product.
3. α is the basic spacing from the centerline of the tab to terminal 1 looking at the bottom of the package.
4. N is the maximum number of terminal positions.
5. Controlling dimension: Millimeter.

Hermetic Metal Package

For the most recent package outline drawing, see [T3.D](#).

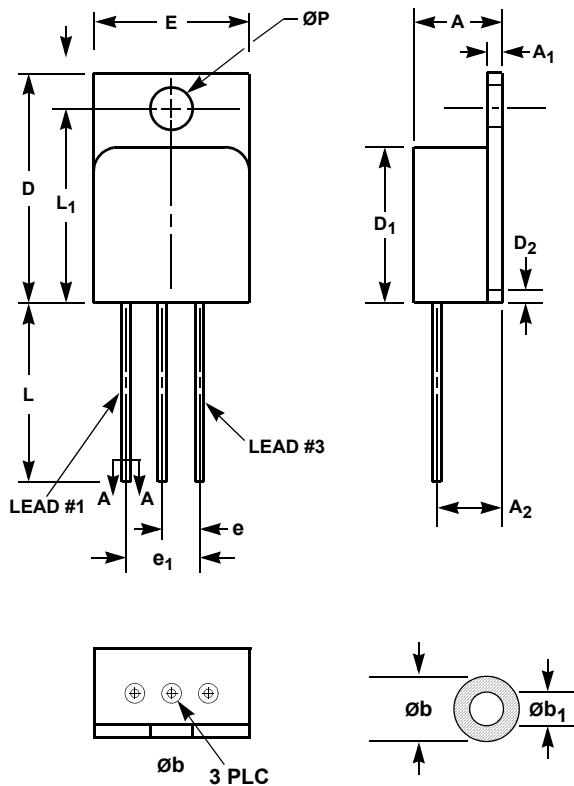

T3.D

3 LEAD JEDEC TO-257AA HERMETIC METAL PACKAGE

SYMBOL	INCHES		MILLIMETERS		NOTES
	MIN	MAX	MIN	MAX	
A	0.188	0.200	4.78	5.08	7
A ₁	0.035	0.045	0.89	1.14	-
A ₂	0.120 BSC		3.05 BSC		-
D	0.645	0.665	16.39	16.89	-
D ₁	0.410	0.430	10.41	10.92	-
D ₂	-	0.038	-	0.97	-
e	0.100 BSC		2.54 BSC		-
e ₁	0.200 BSC		5.08 BSC		-
E	0.410	0.420	10.41	10.67	-
$\varnothing b$	0.025	0.040	0.64	1.02	1, 2
$\varnothing b_1$	0.025	0.035	0.64	0.89	1, 2
L	0.500	0.750	12.70	19.05	-
L ₁	0.527	0.537	13.39	13.64	-
P	0.140	0.150	3.56	3.81	-
N	3		3		5

Rev. 2 3/09

NOTES:

1. Dimension $\varnothing b_1$ applies to base metal only. Dimension $\varnothing b$ applies to plated part.
2. Section A-A dimension apply between 0.100 inch (2.54mm) to 0.150 inch (3.81mm) from lead tip.
3. Die to base BeO isolated, terminals to case is plated.
4. Controlling dimensions are in inches (mm for reference only).
5. N is the maximum number of terminal positions.
6. Patterned after MIL-STD-1835 MSFM1-P3AA.
7. "A" minimum dimension not meeting the MIL-STD 0.190 minimum dimension.

Notice

1. Descriptions of circuits, software and other related information in this document are provided only to illustrate the operation of semiconductor products and application examples. You are fully responsible for the incorporation or any other use of the circuits, software, and information in the design of your product or system. Renesas Electronics disclaims any and all liability for any losses and damages incurred by you or third parties arising from the use of these circuits, software, or information.
 2. Renesas Electronics hereby expressly disclaims any warranties against and liability for infringement or any other claims involving patents, copyrights, or other intellectual property rights of third parties, by or arising from the use of Renesas Electronics products or technical information described in this document, including but not limited to, the product data, drawings, charts, programs, algorithms, and application examples.
 3. No license, express, implied or otherwise, is granted hereby under any patents, copyrights or other intellectual property rights of Renesas Electronics or others.
 4. You shall not alter, modify, copy, or reverse engineer any Renesas Electronics product, whether in whole or in part. Renesas Electronics disclaims any and all liability for any losses or damages incurred by you or third parties arising from such alteration, modification, copying or reverse engineering.
 5. Renesas Electronics products are classified according to the following two quality grades: "Standard" and "High Quality". The intended applications for each Renesas Electronics product depends on the product's quality grade, as indicated below.
 - "Standard": Computers; office equipment; communications equipment; test and measurement equipment; audio and visual equipment; home electronic appliances; machine tools; personal electronic equipment; industrial robots; etc.
 - "High Quality": Transportation equipment (automobiles, trains, ships, etc.); traffic control (traffic lights); large-scale communication equipment; key financial terminal systems; safety control equipment; etc.Unless expressly designated as a high reliability product or a product for harsh environments in a Renesas Electronics data sheet or other Renesas Electronics document, Renesas Electronics products are not intended or authorized for use in products or systems that may pose a direct threat to human life or bodily injury (artificial life support devices or systems; surgical implantations; etc.), or may cause serious property damage (space system; undersea repeaters; nuclear power control systems; aircraft control systems; key plant systems; military equipment; etc.). Renesas Electronics disclaims any and all liability for any damages or losses incurred by you or any third parties arising from the use of any Renesas Electronics product that is inconsistent with any Renesas Electronics data sheet, user's manual or other Renesas Electronics document.
 6. When using Renesas Electronics products, refer to the latest product information (data sheets, user's manuals, application notes, "General Notes for Handling and Using Semiconductor Devices" in the reliability handbook, etc.), and ensure that usage conditions are within the ranges specified by Renesas Electronics with respect to maximum ratings, operating power supply voltage range, heat dissipation characteristics, installation, etc. Renesas Electronics disclaims any and all liability for any malfunctions, failure or accident arising out of the use of Renesas Electronics products outside of such specified ranges.
 7. Although Renesas Electronics endeavors to improve the quality and reliability of Renesas Electronics products, semiconductor products have specific characteristics, such as the occurrence of failure at a certain rate and malfunctions under certain use conditions. Unless designated as a high reliability product or a product for harsh environments in a Renesas Electronics data sheet or other Renesas Electronics document, Renesas Electronics products are not subject to radiation resistance design. You are responsible for implementing safety measures to guard against the possibility of bodily injury, injury or damage caused by fire, and/or danger to the public in the event of a failure or malfunction of Renesas Electronics products, such as safety design for hardware and software, including but not limited to redundancy, fire control and malfunction prevention, appropriate treatment for aging degradation or any other appropriate measures. Because the evaluation of microcomputer software alone is very difficult and impractical, you are responsible for evaluating the safety of the final products or systems manufactured by you.
 8. Please contact a Renesas Electronics sales office for details as to environmental matters such as the environmental compatibility of each Renesas Electronics product. You are responsible for carefully and sufficiently investigating applicable laws and regulations that regulate the inclusion or use of controlled substances, including without limitation, the EU RoHS Directive, and using Renesas Electronics products in compliance with all these applicable laws and regulations. Renesas Electronics disclaims any and all liability for damages or losses occurring as a result of your noncompliance with applicable laws and regulations.
 9. Renesas Electronics products and technologies shall not be used for or incorporated into any products or systems whose manufacture, use, or sale is prohibited under any applicable domestic or foreign laws or regulations. You shall comply with any applicable export control laws and regulations promulgated and administered by the governments of any countries asserting jurisdiction over the parties or transactions.
 10. It is the responsibility of the buyer or distributor of Renesas Electronics products, or any other party who distributes, disposes of, or otherwise sells or transfers the product to a third party, to notify such third party in advance of the contents and conditions set forth in this document.
 11. This document shall not be reprinted, reproduced or duplicated in any form, in whole or in part, without prior written consent of Renesas Electronics.
 12. Please contact a Renesas Electronics sales office if you have any questions regarding the information contained in this document or Renesas Electronics products.
- (Note1) "Renesas Electronics" as used in this document means Renesas Electronics Corporation and also includes its directly or indirectly controlled subsidiaries.
- (Note2) "Renesas Electronics product(s)" means any product developed or manufactured by or for Renesas Electronics.

(Rev.4.0-1 November 2017)

Corporate Headquarters

TOYOSU FORESIA, 3-2-24 Toyosu,
Koto-ku, Tokyo 135-0061, Japan
www.renesas.com

Contact Information

For further information on a product, technology, the most up-to-date version of a document, or your nearest sales office, please visit:
www.renesas.com/contact/

Trademarks

Renesas and the Renesas logo are trademarks of Renesas Electronics Corporation. All trademarks and registered trademarks are the property of their respective owners.