

CPX4 AC-PLC Evaluation Kit M02D2

R30AN0394EJ0101

Rev.1.01

RTK0EE0009D02001BJ SCH, BOM, PCB layout

Apr 1, 2024

Introduction

This document describes the schematics, the bill of materials and the PCB layout of CPX4 AC-PLC Evaluation Kit M02D2.

Contents

1. Schematics	2
1.1 AC-PLC board.....	2
1.1.1 PLC modem LSI (R9A06G061:CPX4)	2
1.1.2 PLC output stage and AFE circuit.....	3
1.1.3 AC Coupling and Power supply circuit	4
1.1.4 Peripheral circuit (RESET and USB)	5
1.1.5 PMOD interface	6
1.2 RX651 MCU board	7
1.3 Filter board.....	8
1.4 PMOD conversion board	9
2. Bill of materials	10
2.1 AC-PLC board.....	10
2.2 RX651 MCU board	12
2.3 Filter board.....	13
2.4 PMOD conversion board	13
3. PCB layout	14
3.1 AC-PLC board.....	14
3.2 RX651 MCU board	17
3.3 Filter board.....	19
3.4 PMOD conversion board	22
4. Dimensions	23

1. Schematics

1.1 AC-PLC board

1.1.1 PLC modem LSI (R9A06G061:CPX4)

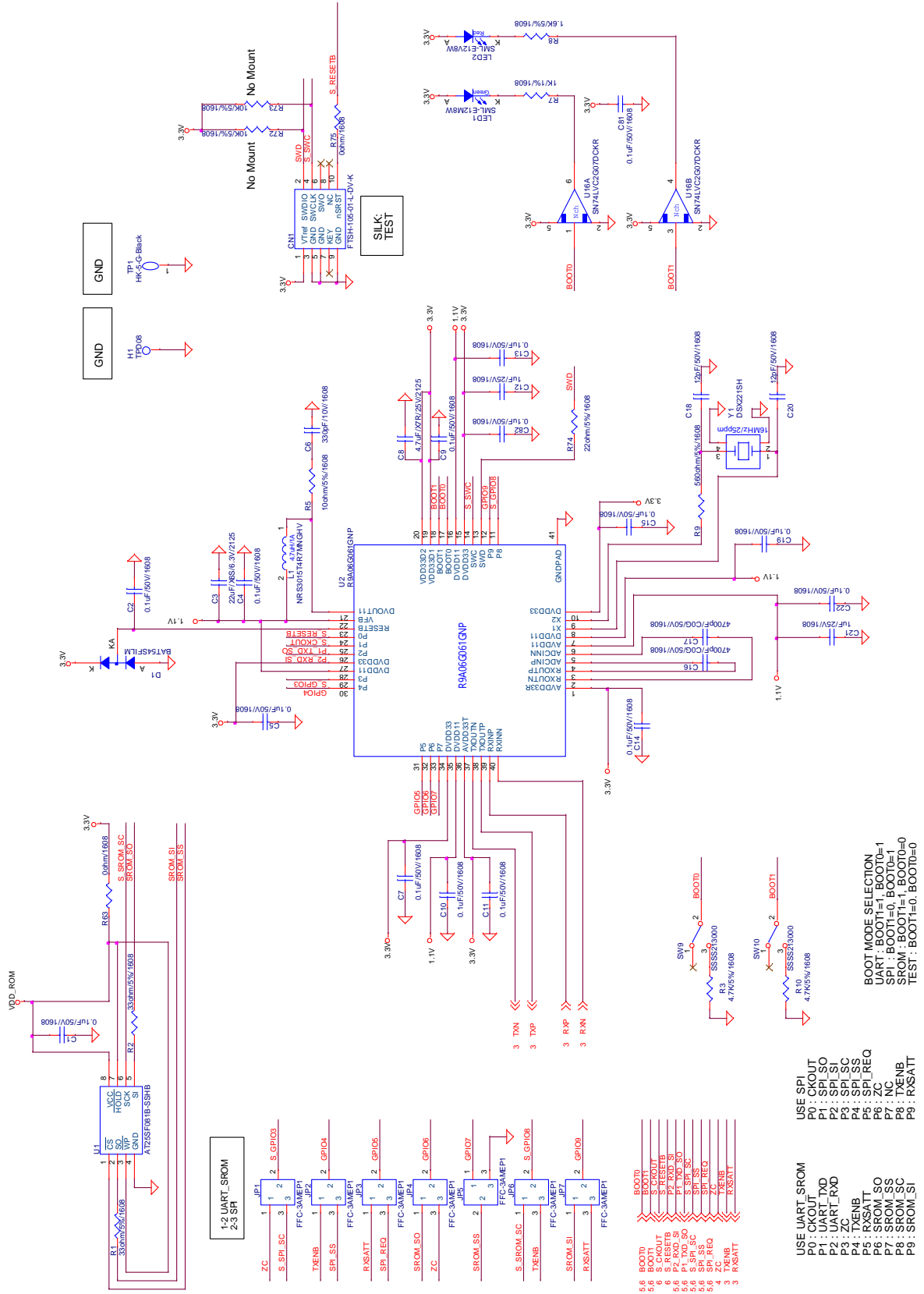

Figure 1-1 AC-PLC board (1/5)

1.1.2 PLC output stage and AFE circuit

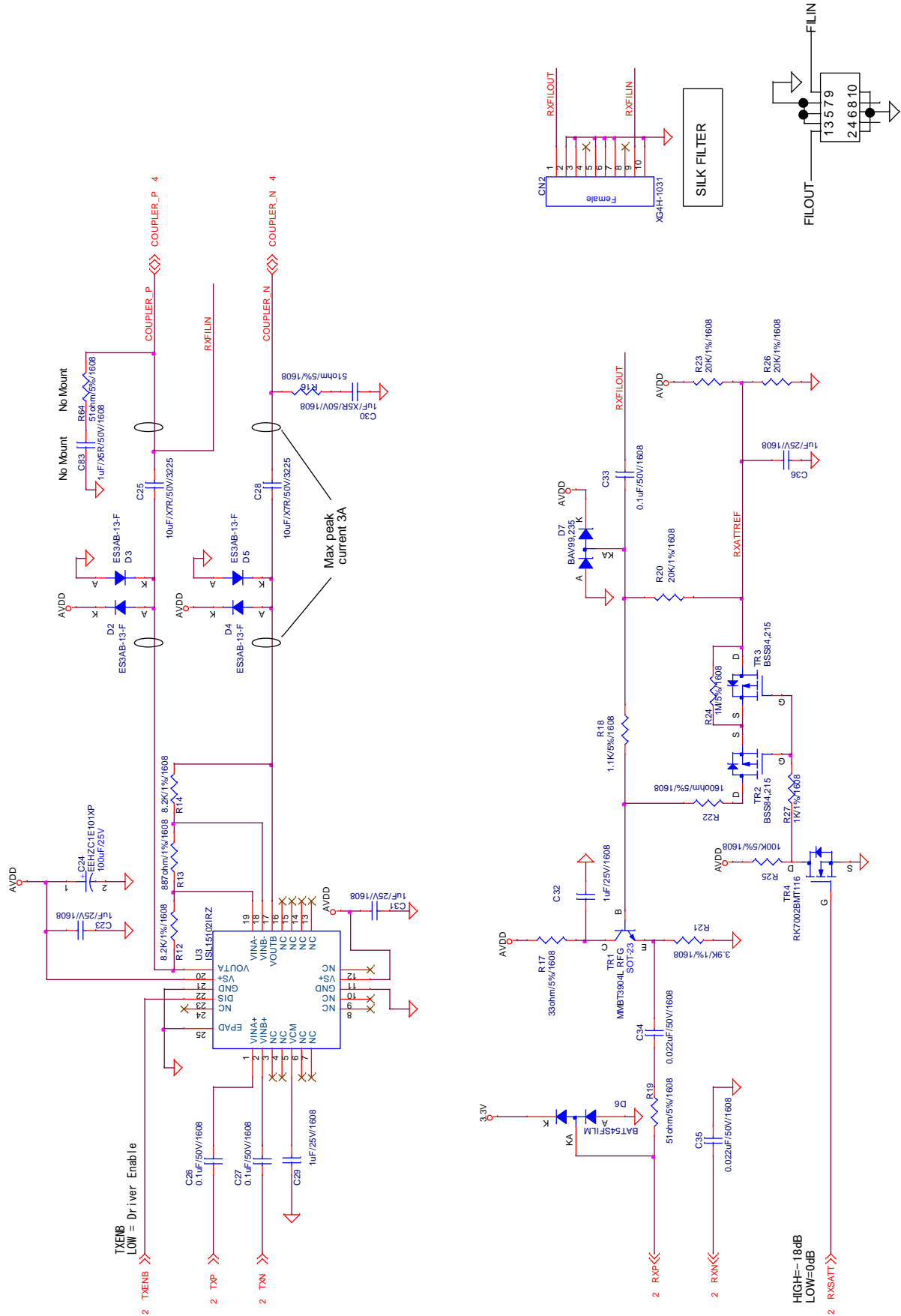

Figure 1-2 AC-PLC board (2/5)

1.1.3 AC Coupling and Power supply circuit

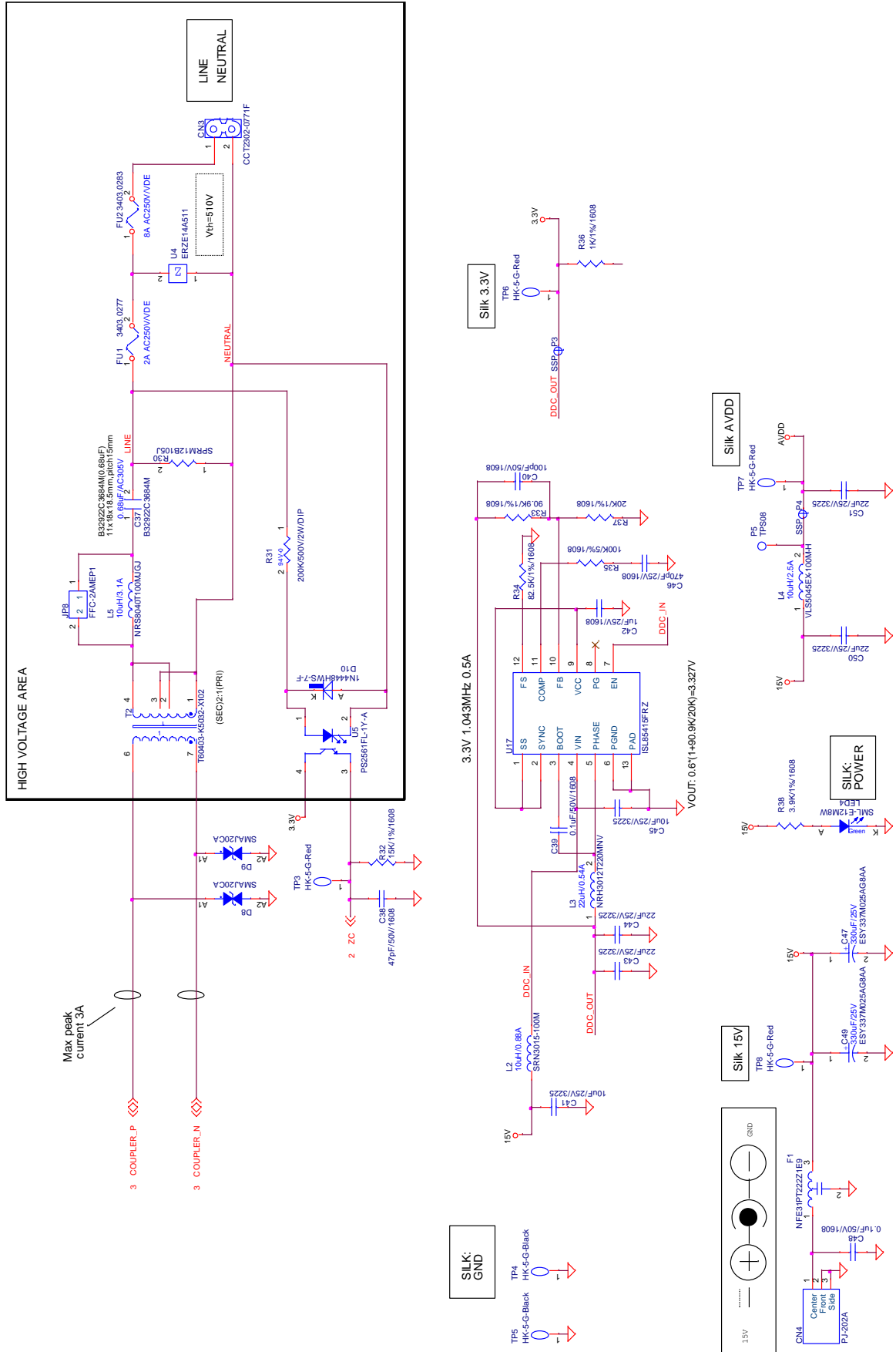

Figure 1-3 AC-PLC board (3/5)

1.1.4 Peripheral circuit (RESET and USB)

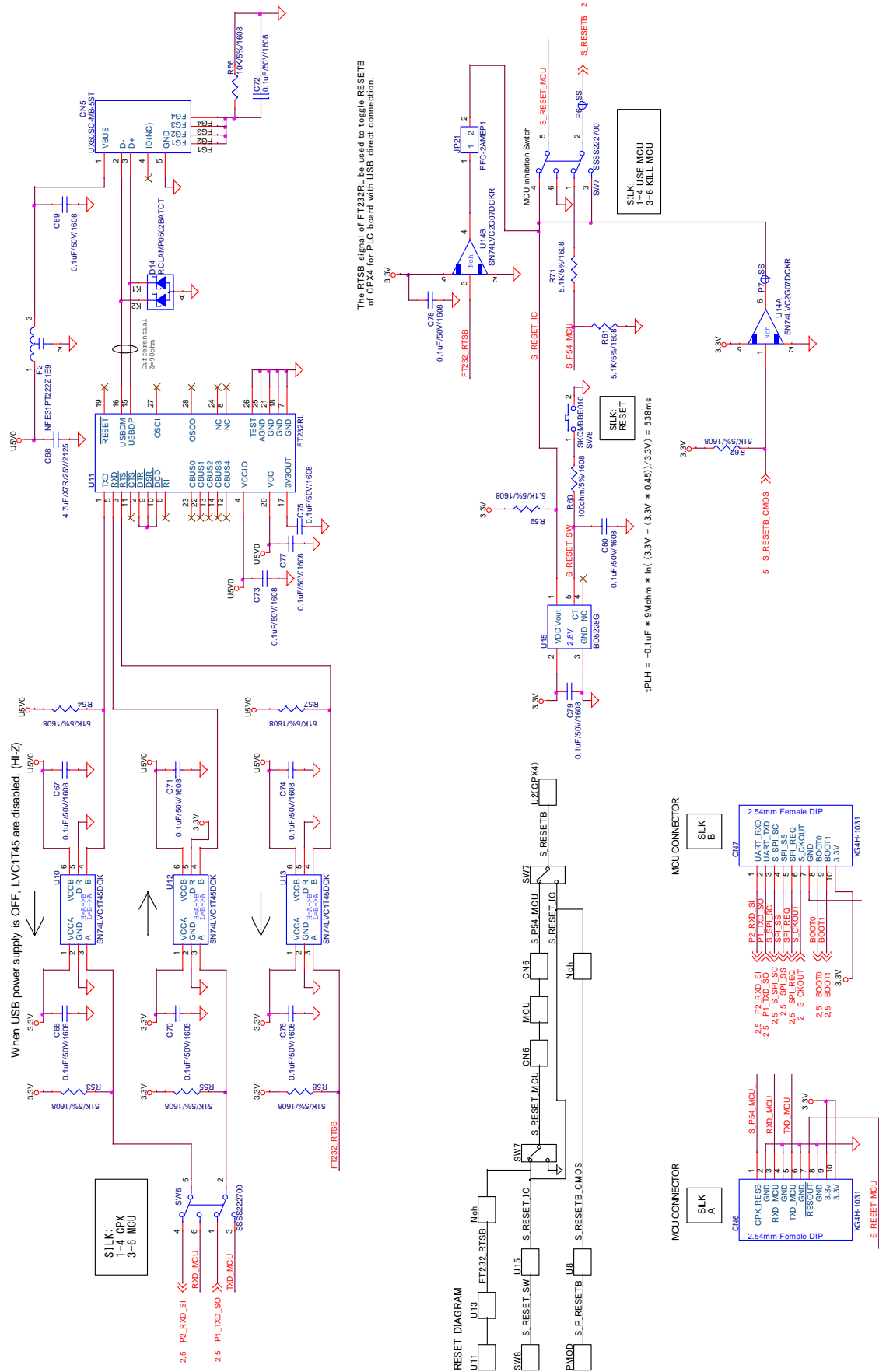

Figure 1-4 AC-PLC board (4/5)

1.1.5 PMOD interface

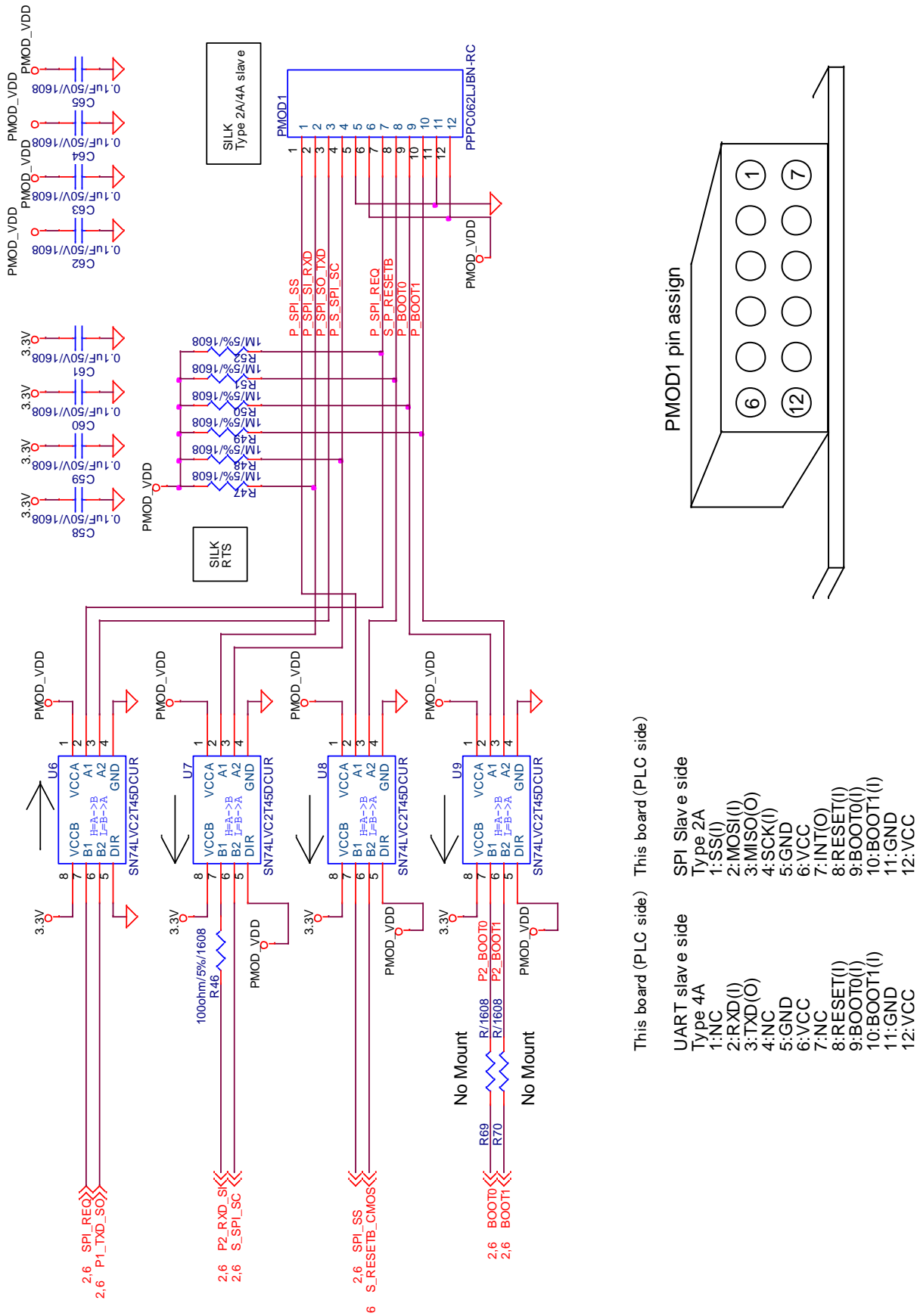

Figure 1-5 AC-PLC board (5/5)

1.2 RX651 MCU board

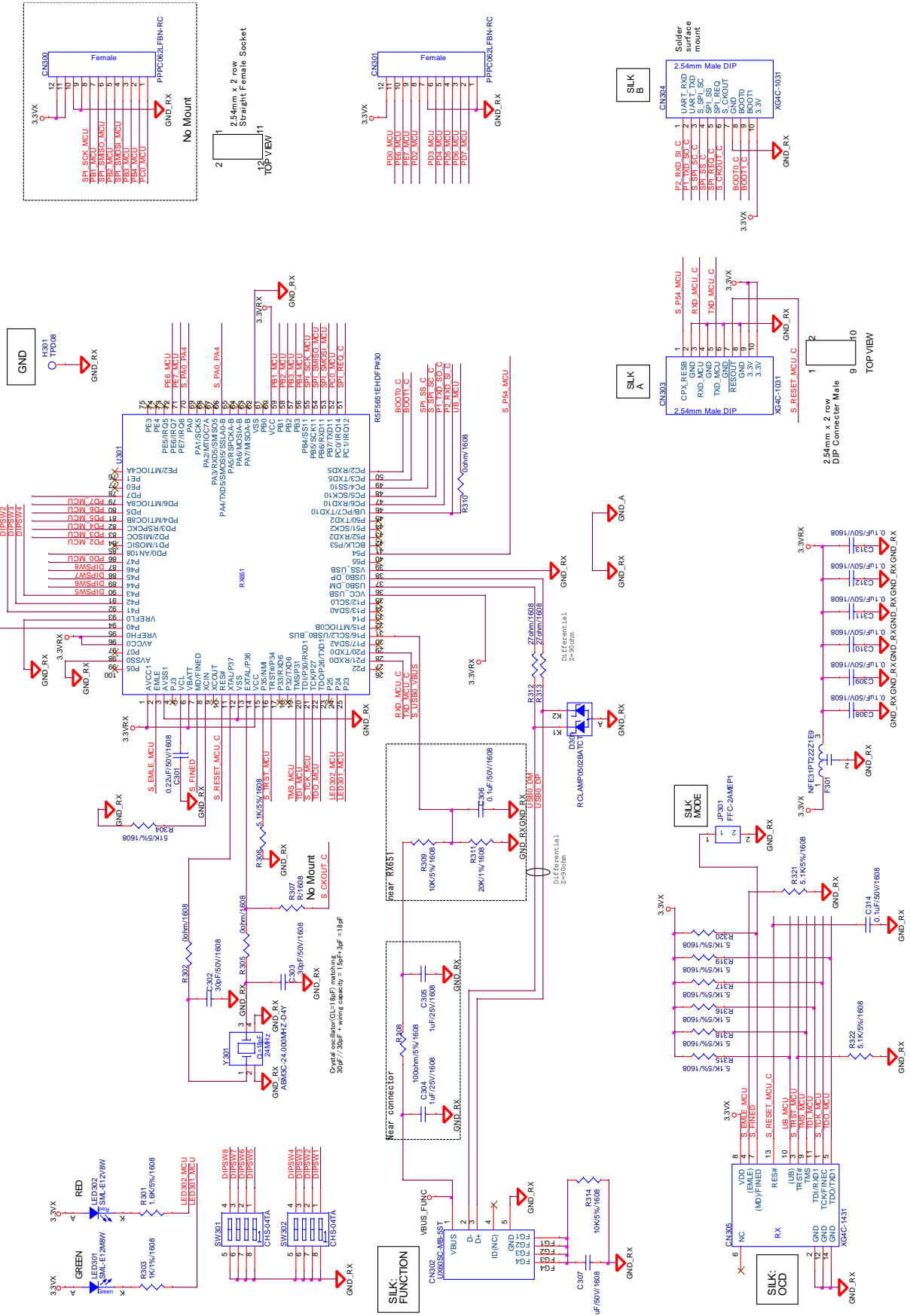

Figure 1-6 RX651 MCU board

1.3 Filter board

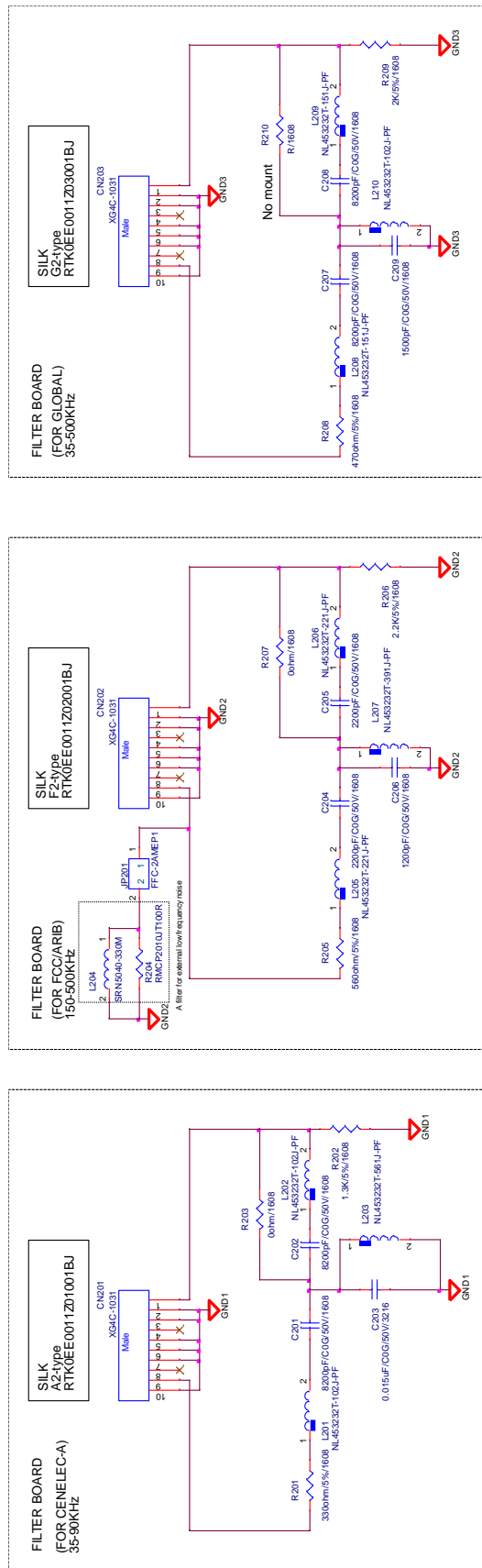
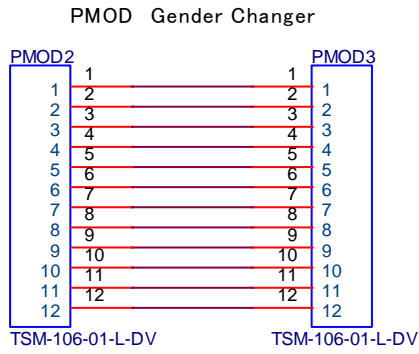

Figure 1-7 Power Filter board

1.4 PMOD conversion board



Circled 2 pins on both component side and solder side (pin number silk not required)

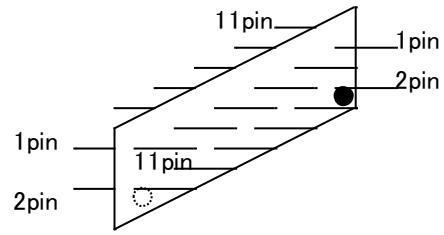

Figure 1-8 PMOD conversion board

2. Bill of materials

2.1 AC-PLC board

Table 2.1 AC-PLC board (1/3)

Quantity	Reference	KIND	Parts Name	Manufacturer	Remark
1	CN1	Connector	FTSH-105-01-L-DV-K	SAMTEC	
3	CN2,CN6,CN7	Connector	XG4H-1031	OMRON	
1	CN3	Connector	CCT2302-0771F	SMK	(2*) AC-M11PB73C(Echo Electric)
1	CN4	Connector	PJ-202A	CUI	
1	CN5	Connector	UX60SC-MB-5ST	HIROSE	
42	C1,C2,C4,C5,C7,C9,C10,C11,C13,C14,C15,C19,C22,C26,C27,C33,C39,C48,C58,C59,C60,C61,C62,C63,C64,C65,C66,C67,C69,C70,C71,C72,C73,C74,C75,C76,C77,C78,C79,C80,C81,C82	Ceramic Capacitor	CC0603KRX7R9BB104	Yageo	(1*) 0.1uF/X7R/50V/1608
8	C12,C21,C23,C29,C31,C32,C36,C42	Ceramic Capacitor	CGA3E1X7R1E105K080AC	TDK	(1*) 1uF/X7R/25V/1608
2	C16,C17	Ceramic Capacitor	CGA3E2C0G1H472J	TDK	(1*) 4700pF/C0G/50V/1608
2	C18,C20	Ceramic Capacitor	CGA3E2C0G1H120J080AA	TDK	(1*) 12pF/C0G/50V/1608
1	C24	ALUM CAP	EEHZC1E101XP	Panasonic	
2	C25,C28	Ceramic Capacitor	GRM32ER71H106KA12L	MURATA	
1	C3	Ceramic Capacitor	C2012X6S0J226M085AC	TDK	(1*) 22uF/X6S/6.3V/2125
1	C30	Ceramic Capacitor	CGA3E3X5R1H105K080AB	TDK	(1*) 1uF/X5R/50V/1608
2	C34,C35	Ceramic Capacitor	C1608X7R1H223K	TDK	(1*) 0.022uF/X7R/50V/1608
1	C37	Film Capacitor	B32922C3684M	EPCOS	
1	C38	Ceramic Capacitor	CGA3E2C0G1H470J080AA	TDK	(1*) 47pF/C0G/50V/1608
1	C40	Ceramic Capacitor	C1608C0G1H101J080AA	TDK	(1*) 100pF/C0G/50V/1608
2	C41,C45	Ceramic Capacitor	GRM32DR71E106KA12L	MURATA	(1*) 10uF/X7R/25V/3225
4	C43,C44,C50,C51	Ceramic Capacitor	TMK325B7226KMHT	Taiyo Yuden	(1*) 22uF/X7R/25V/3225
1	C46	Ceramic Capacitor	C0603C471J3GACAUTO	KEMET	(1*) 470pF/C0G/25V/1608
2	C47,C49	ELECTROLYTIC CAP	ESY337M025AG8AA	KEMET	
1	C6	Ceramic Capacitor	C0603C331J3GACTU	KEMET	(1*) 330pF/C0G/10V/1608
2	C8,C68	Ceramic Capacitor	TMK325B7226KMHP	Taiyo Yuden	(1*) 4.7uF/X7R/25V/2125
2	D1,D6	DIODE	BAT54SFILM	STMicroelectronics	
1	D10	DIODE	1N4448HWS-7-F	Diodes Inc	
1	D14	DIODE	RCLAMP0502BATCT	Semtech	
4	D2,D3,D4,D5	DIODE	ES3AB-13-F	Diodes Inc	
1	D7	DIODE	BAV99.235	NXP	
2	D8,D9	DIODE	SMAJ20CA	Bourns Inc.	
2	F1,F2	Filter	NFE31PT222Z1E9	Murata	
1	FU1	FUSE	3403.0277	Schurter Inc	
1	FU2	FUSE	3403.0283	Schurter Inc	
7	JP1,JP2,JP3,JP4,JP5,JP6,JP7	Connector	FFC-3AMEP1	HONDA	(1*)
2	JP8,JP21	Connector	FFC-2AMEP1	HONDA	(1*)
1	L1	Inductor	NRS3015T4R7MNGHV	Taiyo Yuden	(2*) VLS3015CX-4R7M(TDK)
1	L2	Inductor	SRN3015-100M	Bourns	(2*) VLS3015CX-100M (TDK)
1	L3	Inductor	NRH3012T220MNV	Taiyo Yuden	(2*) VLS3015ET-220M (TDK)
1	L4	Inductor	VLS5045EX-100M-H	TDK	(2*) SRN5040TA-100M (Bourns)

(1*)Equivalent product can be changed

(2*)Alternative product

Table 2.2 AC-PLC board (2/3)

1	L5	Inductor	NRS8040T100MJGJ	Taiyo Yuden	(2*) SRN8040-100M (Bourns)
3	LED1,LED3,LED4	LED	SML-E12M8W	Rohm	
1	LED2	LED	SML-E12V8W	Rohm	
1	PMOD1	Connector	PPPC062LJBN-RC	Sullins	
2	PMOD2,PMOD3	Connector	TSM-106-01-L-DV	SAMTEC	
3	R1,R2,R17	Reistor	RK73B1JTTD330J	KOA	(1*) 33ohm/5%/0.125W/1608
2	R12,R14	Reistor	RK73H1JTTD8201F	KOA	(1*) 8.2K/1%/0.125W/1608
1	R13	Reistor	RK73H1JTTD8870F	KOA	(1*) 887ohm/1%/0.125W/1608
2	R16,R19	Reistor	RK73B1JTTD510J	KOA	(1*) 51ohm/5%/0.125W/1608
1	R18	Reistor	RK73B1JTTD112J	KOA	(1*) 1.1K/5%/0.125W/1608
4	R20,R23,R26,R37	Reistor	RK73H1JTTD2002F	KOA	(1*) 20K/1%/0.125W/1608
2	R21,R38	Reistor	RK73H1JTTD3901F	KOA	(1*) 3.9K/1%/0.125W/1608
1	R22	Reistor	RK73B1JTTD161J	KOA	(1*) 160ohm/5%/0.125W/1608
7	R24,R47,R48,R49,R50,R51, R52	Reistor	RK73B1JTTD105J	KOA	(1*) 1M/5%/0.125W/1608
2	R25,R35	Reistor	RK73B1JTTD104J	KOA	(1*) 100K/5%/0.125W/1608
2	R3,R10	Reistor	RK73B1JTTD472J	KOA	(1*) 4.7K/5%/0.125W/1608
1	R30	Reistor	SPRM12B105J	Akane Dengu	(2*) RCR50-CTS2A105J, RCR50ENCT52A105J, RCR60CTS2A105J(KOA), VR37000001004J R500(Vishay)
1	R31	Reistor	FMP200JR-52-200K	Yageo	(1*) 200K/500V/2W/DIP
1	R311	Reistor	RK73H1JTTD2002F	KOA	(1*) 20K/1%/0.125W/1608
2	R312,R313	Reistor	RK73B1JTTD270J	KOA	(1*) 27ohm/5%/0.125W/1608
1	R32	Reistor	RK73H1JTTD1502F	KOA	(1*) 15K/1%/0.125W/1608
1	R33	Reistor	RK73H1JTTD9092F	KOA	(1*) 90.9K/1%/0.125W/1608
1	R34	Reistor	RK73H1JTTD8252F	KOA	(1*) 82.5K/1%/0.125W/1608
2	R46,R60	Reistor	RK73B1JTTD101J	KOA	(1*) 100ohm/5%/0.125W/1608
1	R5	Reistor	RK73B1JTTD100J	KOA	(1*) 10ohm/5%/0.125W/1608
6	R53,R54,R55,R57,R58,R62,	Reistor	RK73B1JTTD513J	KOA	(1*) 51K/5%/0.125W/1608
1	R56	Reistor	RK73B1JTTD103J	KOA	(1*) 10K/5%/0.125W/1608
3	R59,R61,R71	Reistor	RK73B1JTTD512J	KOA	(1*) 5.1K/5%/0.125W/1608
2	R63,R75	Reistor	RK73Z1JTTD	KOA	(1*) 0ohm/1608
3	R7,R27,R36	Reistor	RK73H1JTTD1001F	KOA	(1*) 1K/1%/0.125W/1608
1	R303	Reistor	RK73H1JTTD1001F	KOA	(1*) 1K/1%/0.125W/1608
1	R74	Reistor	RK73B1JTTD220J	KOA	(1*) 22ohm/5%/0.125W/1608
1	R8	Reistor	RK73B1JTTD162J	KOA	(1*) 1.6K/5%/0.125W/1608
1	R9	Reistor	RK73B1JTTD561J	KOA	(1*) 560ohm/5%/0.125W/1608
2	SW6,SW7	Switch	SSSS222700	ALPS	
1	SW8	Switch	SKQMBBE010	ALPS	
2	SW9,SW10	Switch	SSSS213000	ALPS	
1	T2	TRANS	T60403-K5032-X102	VAC Magnetic	
3	TP1,TP4,TP5	TEST PIN	HK-5-G-Black	MAC8	
5	TP2,TP3,TP6,TP7,TP8	TEST PIN	HK-5-G-Red	MAC8	
1	TR1	Transistor	MMBT3904L RFG	Taiwan Semiconductor	
2	TR2,TR3	Transistor	BSS84.215	Nexperia	
1	TR4	Transistor	RK7002BMT116	Rohm	
1	U1	IC	AT25SF081B-SSHB	Adesto	(2*) W25Q80DVSNIG(Winbond)
3	U10,U12,U13	IC	SN74LVC1T45DCK	TI	

(1*)Equivalent product can be changed

(2*)Alternative product

Table 2.3 AC-PLC board (3/3)

Quantity	Reference	Kind	Part name	Manufacture	Remark
2	U14,U16	IC	SN74LVC2G07DCKR	TI	
1	U15	IC	BD5228G-TR	Rohm	(2*) BD5228G, BD5228G-2MTR(Rohm)
1	U17	IC	ISL85415FRZ	INTERSIL	
1	U2	IC	R9A06G061GNP	Renesas	
1	U3	IC	ISL15102IRZ	INTERSIL	
1	U4	Surge Absorber	ERZE14A511	panasonic	(2*) ERZ-E14A471 (Panasonic)
1	U5	Photocoupler	PS2561FL-1Y-A	RENESAS/CEL	(2*) PS2561FL-1Y-K-A
4	U6,U7,U8,U9	IC	SN74LVC2T45DCUR	TI	
1	Y1	Crystal	DSX221SH	Daishinku	Specify the specifications (16MHz,CL:8pF, Frequency tolerance:±10ppm, Frequency characteristics over temperature:±15ppm) (2*)(3*)NX2520SA-16M-CHP-CSW-19(NDK) (4*)

(2*)Alternative product

(3*) For NX2520SA-16M-CHP-CSW-19, it is necessary to change the constants of the external circuit (R9=2.2kΩ, C20=12pF, C18=15pF).

(4*) CX2520DB16000D0FLJCC (Kyocera) has been discontinued.

2.2 RX651 MCU board

Table 2.4 RX651 MCU board

Quantity	Reference	KIND	Parts Name	Manufacturer	Remark
1	CN301	CONNECTOR	PPPC062LFBN-RC	SULLINS	
1	CN302	CONNECTOR	UX60SC-MB-5ST(82)	HIROSE	
2	CN303,CN304	CONNECTOR	XG4C-1031	OMRON	
1	CN305	CONNECTOR	XG4C-1431	OMRON	
1	C301	CERAMIC CAPACITOR	GCM188R71H224KA64	MURATA	(1*) 0.22uF/X7R/50V/1608
2	C302,C303	CERAMIC CAPACITOR	C0603C300J5GACTU	KEMET	(1*) 30pF/C0G/50V/1608
2	C304,C305	CERAMIC CAPACITOR	CGA3E1X7R1E105K080AC	TDK	(1*) 1uF/X7R/25V/1608
9	C306,C307,C308,C309,C310,C311,C312,C313,C314	CERAMIC CAPACITOR	CC0603KRX7R9BB104	Yageo	(1*) 0.1uF/X7R/50V/1608
1	D301	DIODE	RCLAMP0502BATCT	Semtech	
1	F301	FILTER	NFE31PT222Z1E9	Murata	
1	JP301	CONNECTOR	FFC-2AMEP1	HONDA	(1*)
1	LED301	LED	SML-E12M8W	Rohm	
1	LED302	LED	SML-E12V8W	Rohm	
3	R302,R305,R310	RESISTOR	RK73Z1JTTD	KOA	(1*) 0ohm/1608
1	R303	RESISTOR	RK73H1JTTD1001F	KOA	(1*) 1K/1%/1608
1	R304	RESISTOR	RK73B1JTTD513J	KOA	(1*) 51K/5%/1608
9	R306,R315,R316,R317,R318,R319,R320,R321,R322	RESISTOR	RK73B1JTTD512J	KOA	(1*) 5.1K/5%/1608
2	R309,R314	RESISTOR	RK73B1JTTD103J	KOA	(1*) 10K/5%/1608
2	R312,R313	RESISTOR	RK73B1JTTD270J	KOA	(1*) 27ohm/5%/1608
2	SW301,SW302	SWITCH	CHS-04TA	COPAL	
1	U301	IC	R5F5651EHDFF#30	Renesas	
1	Y301	CRYSTAL	ABM3C-24.000MHZ-D4Y	Abracon	

(1*)Equivalent product can be changed

2.3 Filter board

Table 2.5 Filter board

Quantity	Reference	KIND	Parts Name	Manufacturer	Remark
4	C201,C202,C207,C208	Ceramic Capacitor	GRM1885C1H822JA01D	Murata	(1*) 8200pF/C0G/50V/1608
1	C203	Ceramic Capacitor	GRM3195C1H153JA01D	Murata	(1*) 0.015uF/C0G/50V/3216
2	C204,C205	Ceramic Capacitor	CGA3E2C0G1H222J080AA	TDK	(1*) 2200pF/C0G/50V/1608
1	C206	Ceramic Capacitor	GRM1885C1H122JA01D	Murata	(1*) 1200pF/C0G/50V/1608
1	C209	Ceramic Capacitor	GRM1885C1H152JA01J	Murata	(1*) 1500pF/C0G/50V/1608
3	CN201,CN202,CN203	Connector	XG4C-1031	OMRON	
1	JP201	Connector	FFC-2AMEP1	HONDA	(1*)
3	L201,L202,L210	Inductor	NL453232T-102J-PF	TDK	(2*) PM1812-102J-RC (Bourns)
1	L203	Inductor	NL453232T-561J-PF	TDK	(2*) PM1812-561J-RC (Bourns)
1	L204	Inductor	SRN5040-330M	Bourns Inc.	(2*) NR5040T330M (Taiyo Yuden)
2	L205,L206	Inductor	NL453232T-221J-PF	TDK	(2*) PM1812-221J-RC (Bourns)
1	L207	Inductor	NL453232T-391J-PF	TDK	(2*) PM1812-391J-RC (Bourns)
2	L208,L209	Inductor	NL453232T-151J-PF	TDK	(2*) PM1812-151J-RC (Bourns)
1	R201	Reistor	RK73B1JTDD331J	KOA	(1*) 330ohm/5%/0.125W/1608
1	R202	Reistor	RK73B1JTDD132J	KOA	(1*) 1.3K/5%/0.125W/1608
2	R203,R207	Reistor	RK73Z1JTDD	KOA	(1*) 0ohm/1608
1	R204	Reistor	RMCP2010JT100R	STACKPOLE	(1*) 100ohm/5%/1W
1	R205	Reistor	RK73B1JTDD561J	KOA	(1*) 560ohm/5%/0.125W/1608
1	R206	Reistor	RK73B1JTDD222J	KOA	(1*) 2.2K/5%/0.125W/1608
1	R209	Reistor	RK73B1JTDD202J	KOA	(1*) 2K/5%/0.125W/1608

(1*)Equivalent product can be changed

(2*)Alternative product

2.4 PMOD conversion board

Table 2.6 PMOD conversion board

Quantity	Reference	KIND	Parts Name	Manufacturer	Remark
2	PMOD2,PMOD3	CONNECTOR	TSM-106-01-L-DV	SAMTEC	

3. PCB layout

3.1 AC-PLC board

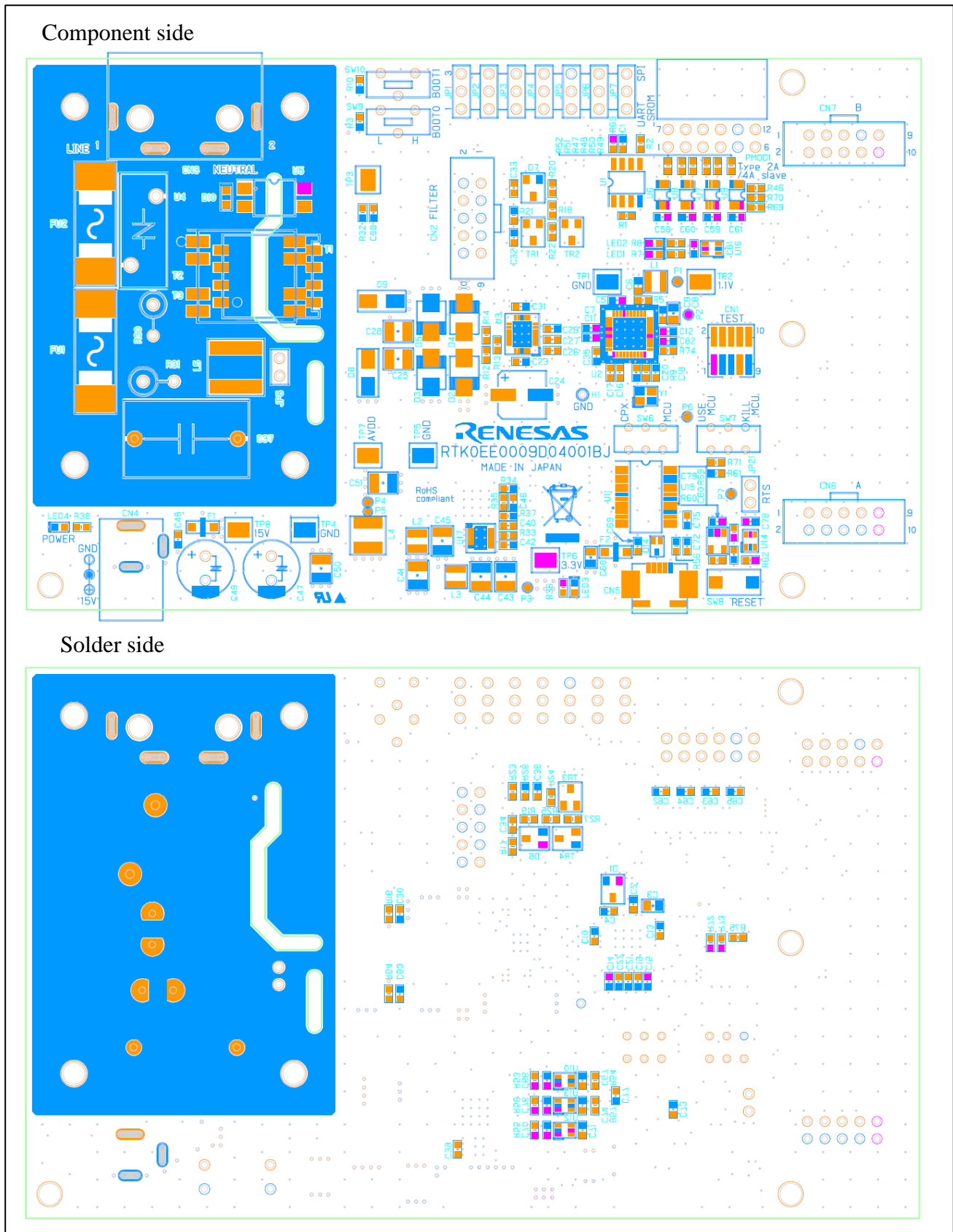

Figure 3-1 AC-PLC board parts layout and silkscreen

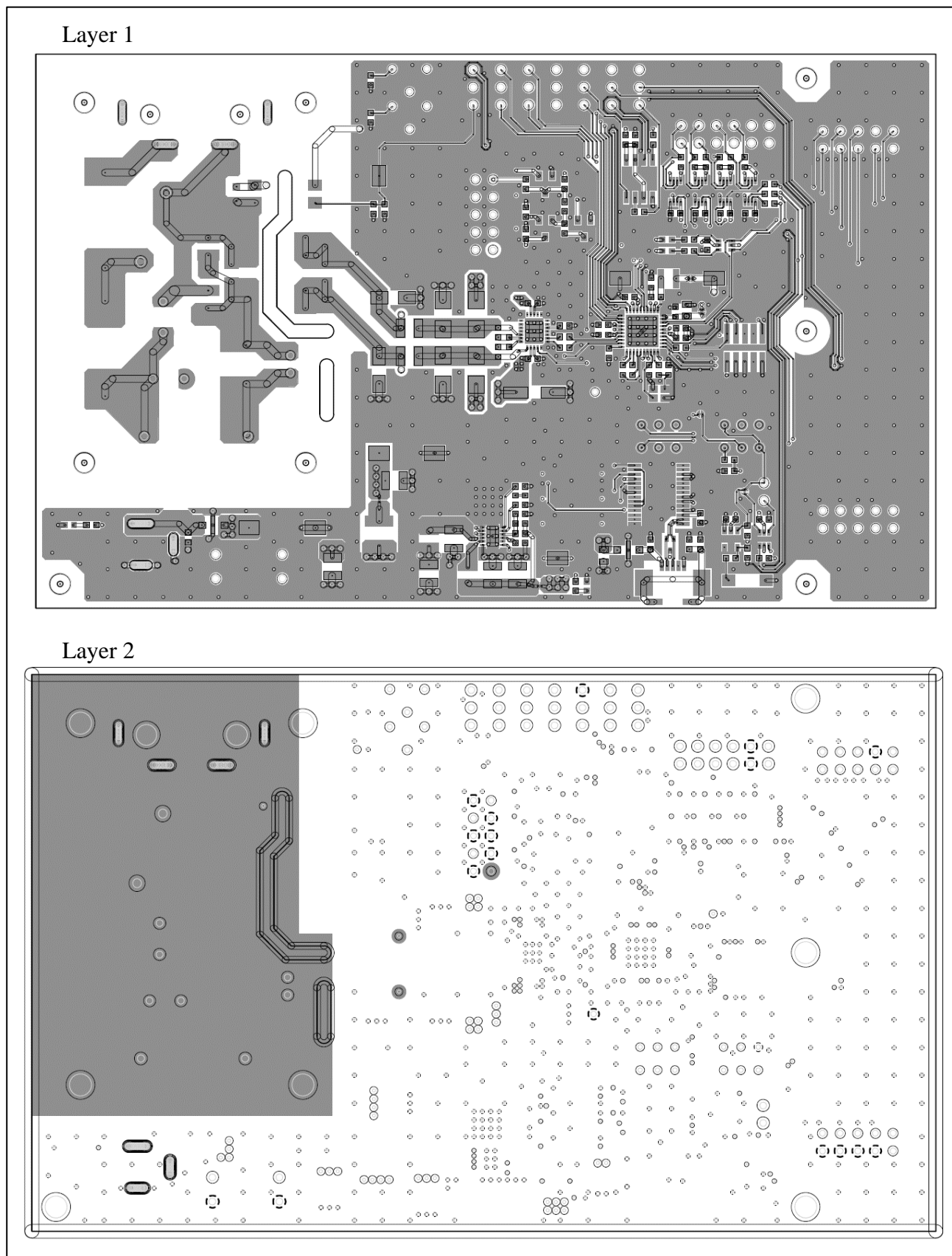

Figure 3-2 PCB layout of AC-PLC board Layer1, Layer2

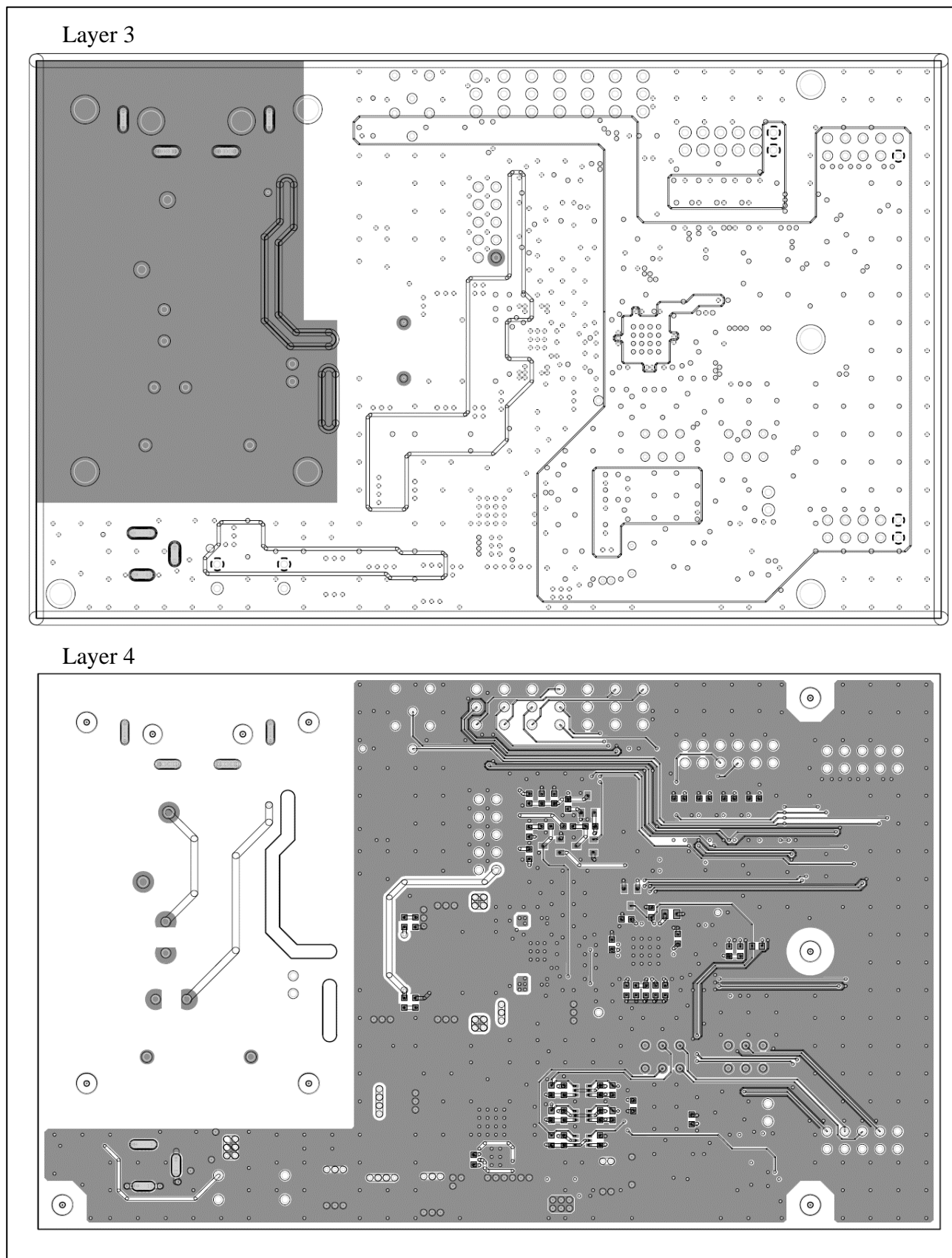

Figure 3-3 PCB layout of AC-PLC board Layer3, Layer4

3.2 RX651 MCU board

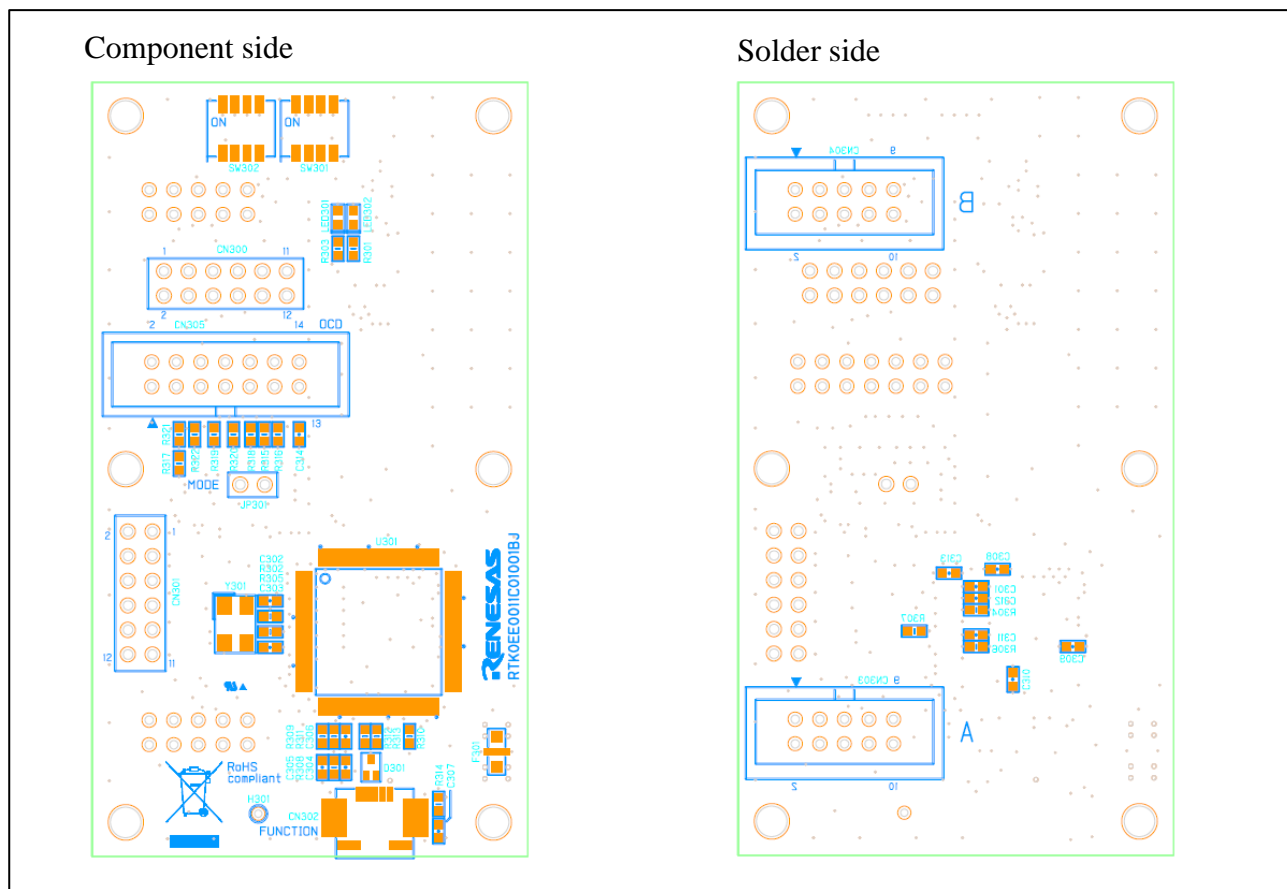

Figure 3-4 RX651 MCU board parts layout and silkscreen

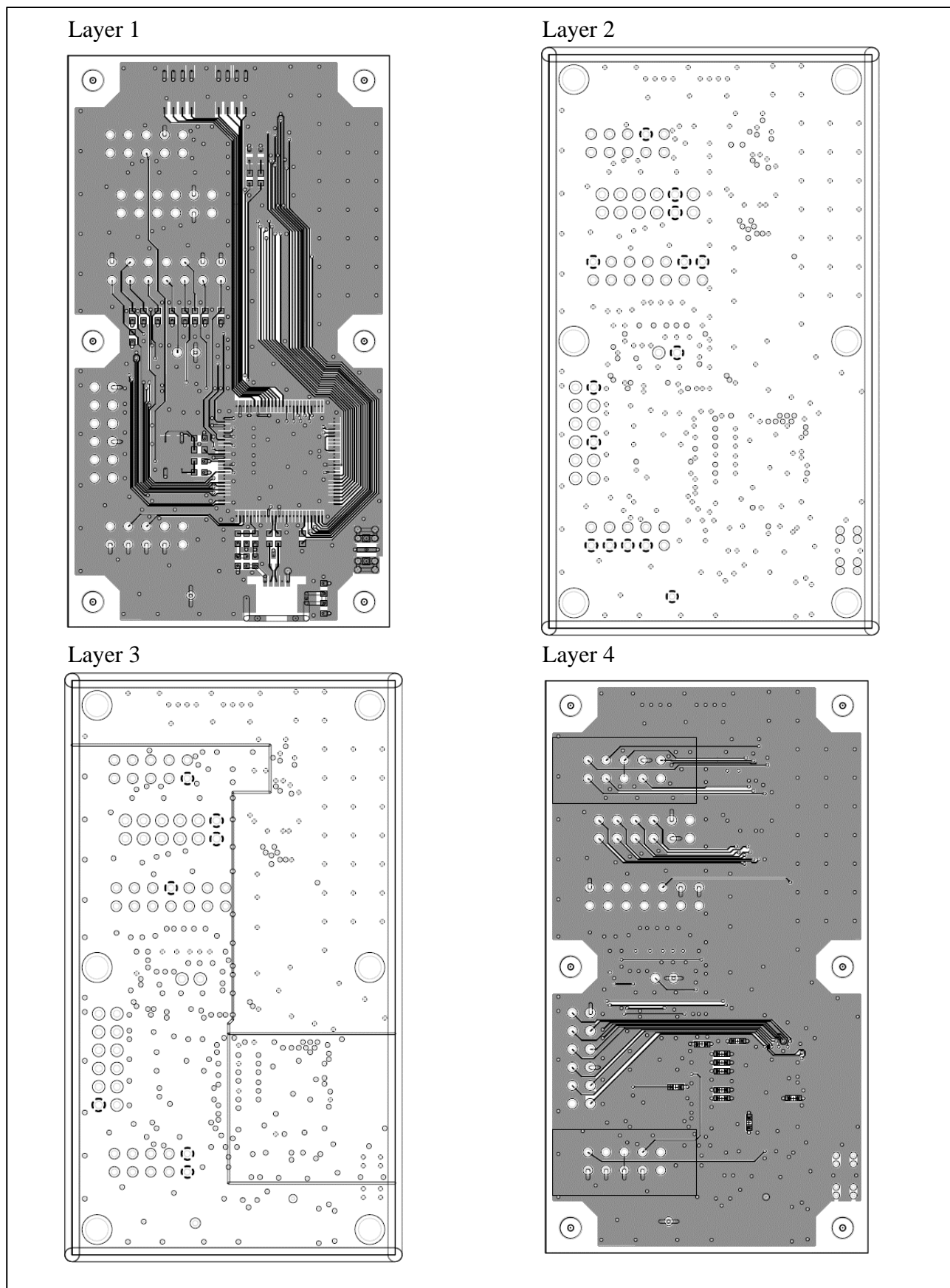

Figure 3-5 PCB layout of RX651 MCU board Layer1, Layer2, Layer3, Layer4

3.3 Filter board

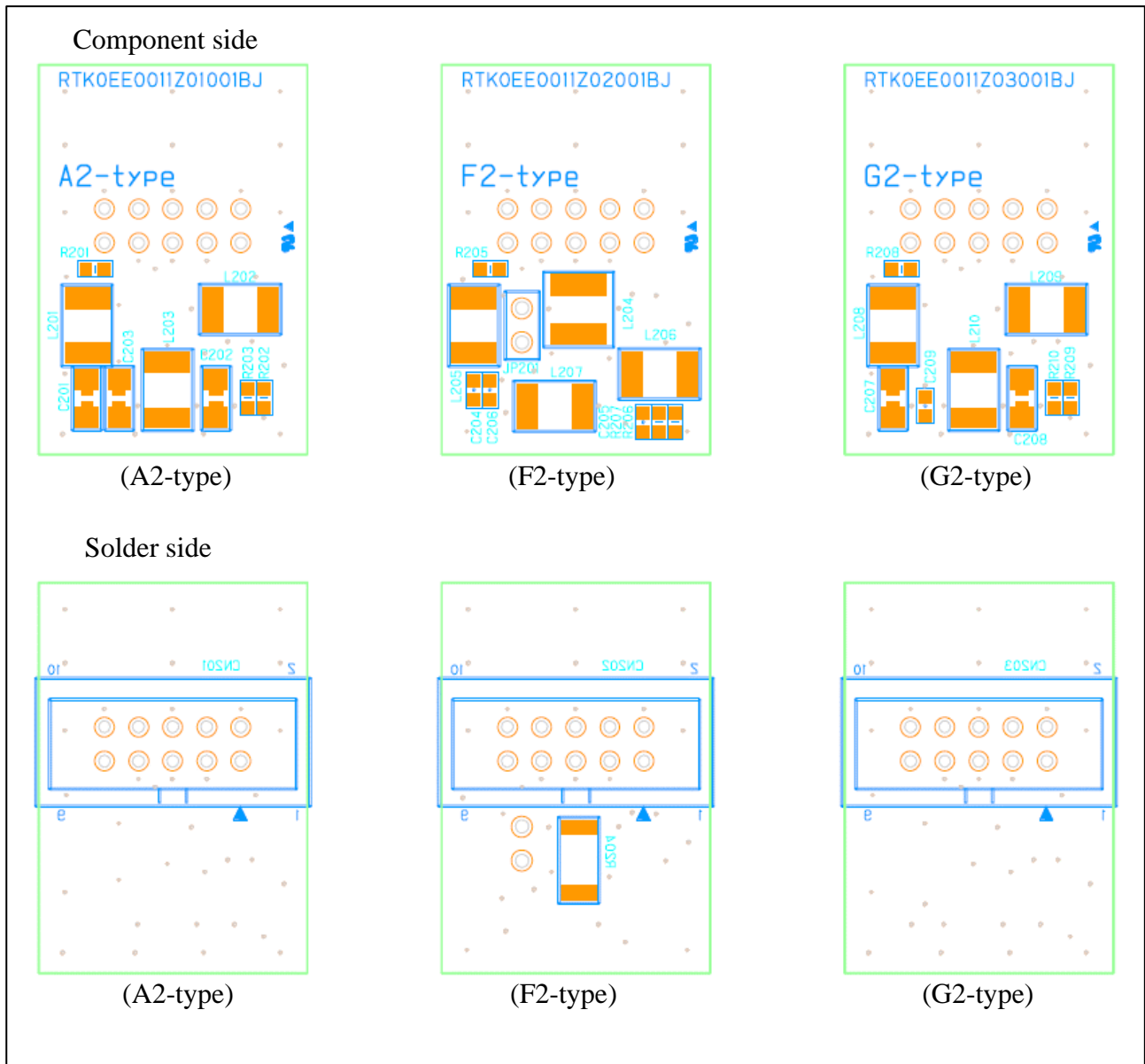

Figure 3-6 Filter board parts layout and silkscreen

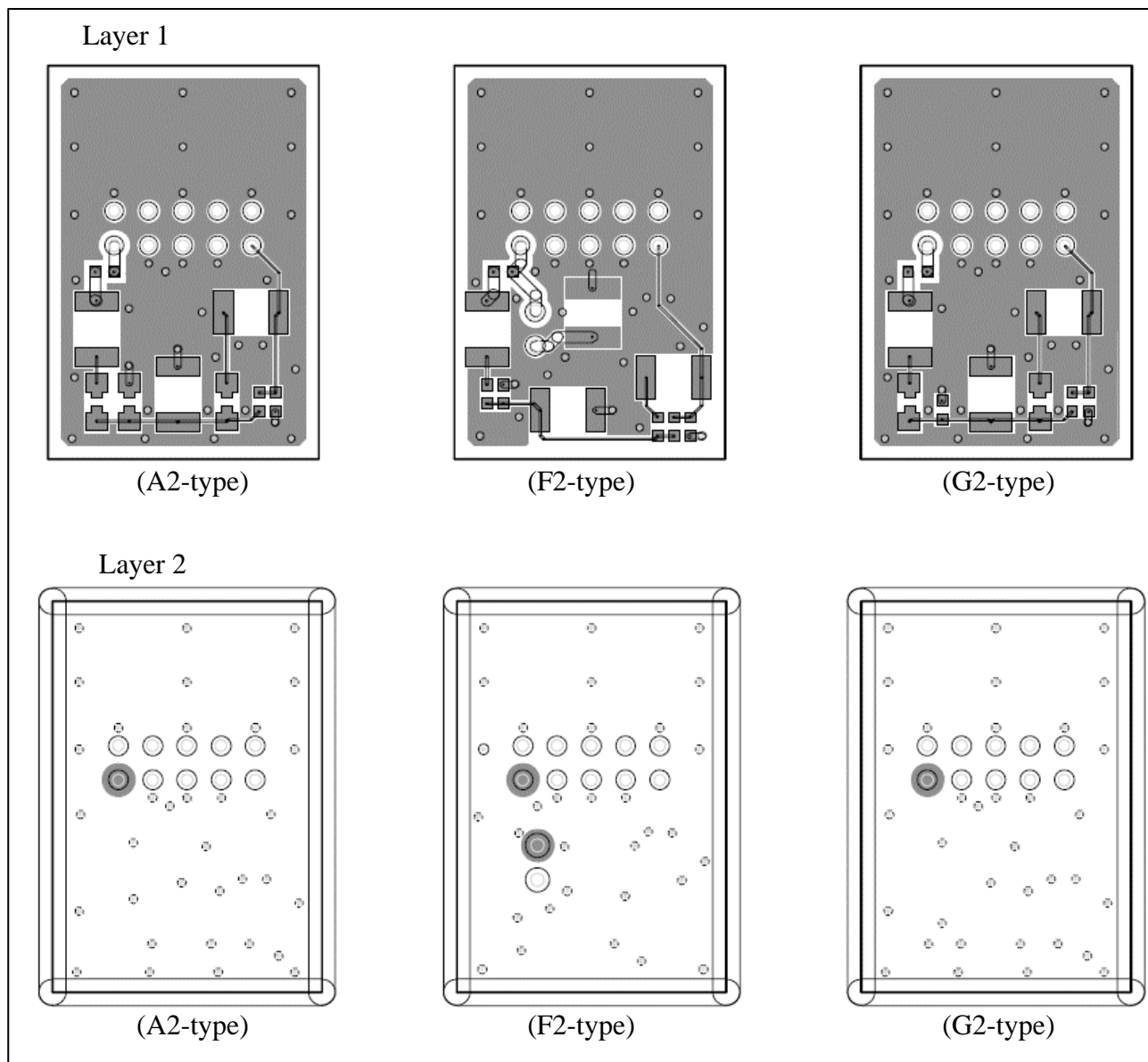

Figure 3-7 PCB layout of Filter board Layer1, Layer2

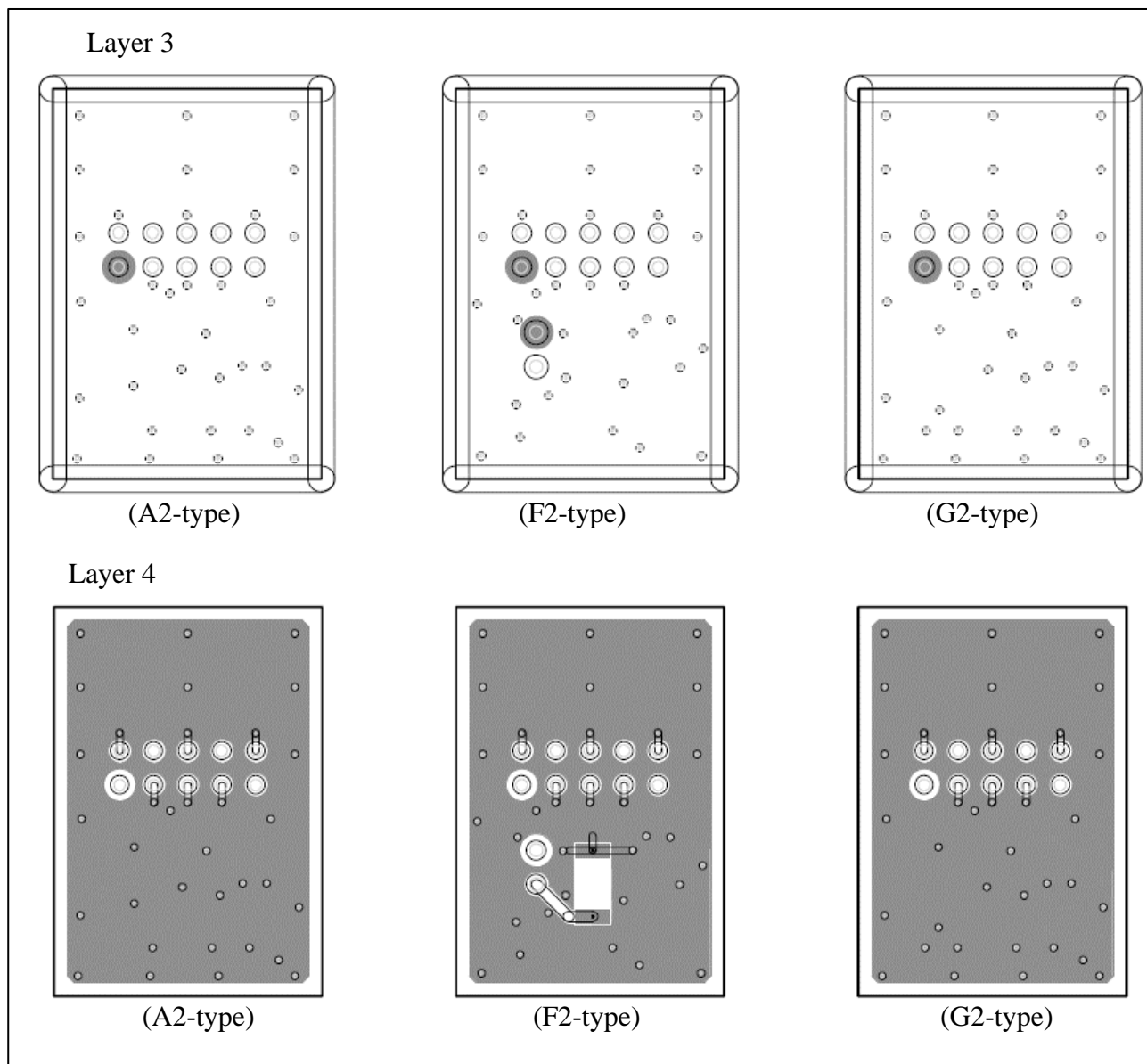

Figure 3-8 PCB layout of Filter board Layer3, Layer4

3.4 PMOD conversion board

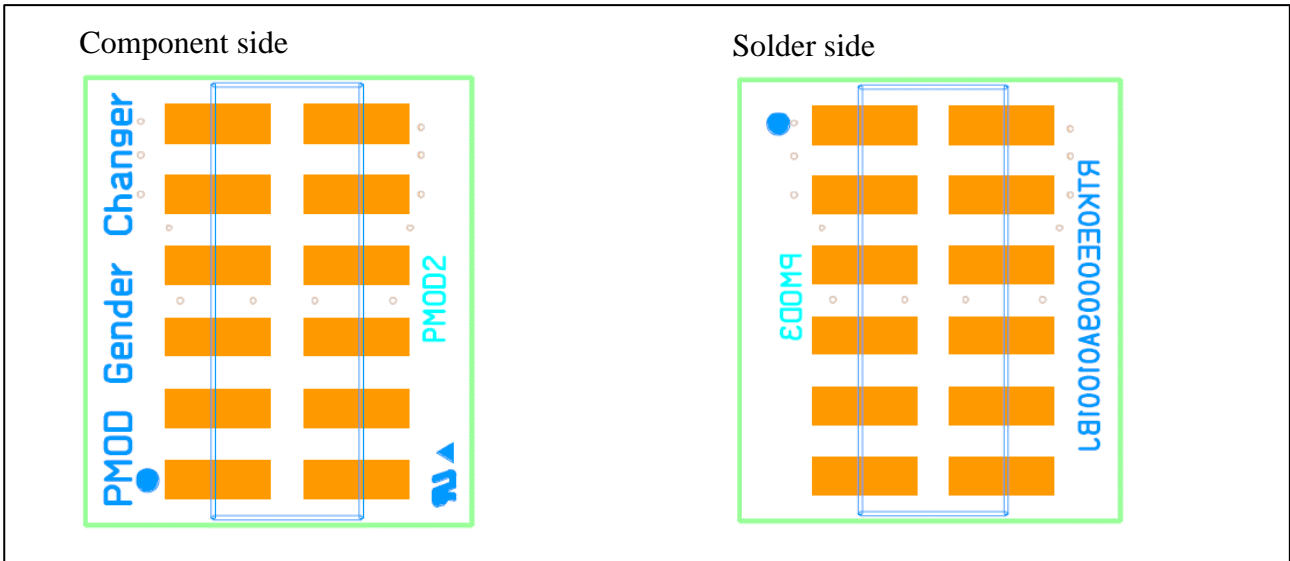

Figure 3-9 PMOD conversion board silkscreen

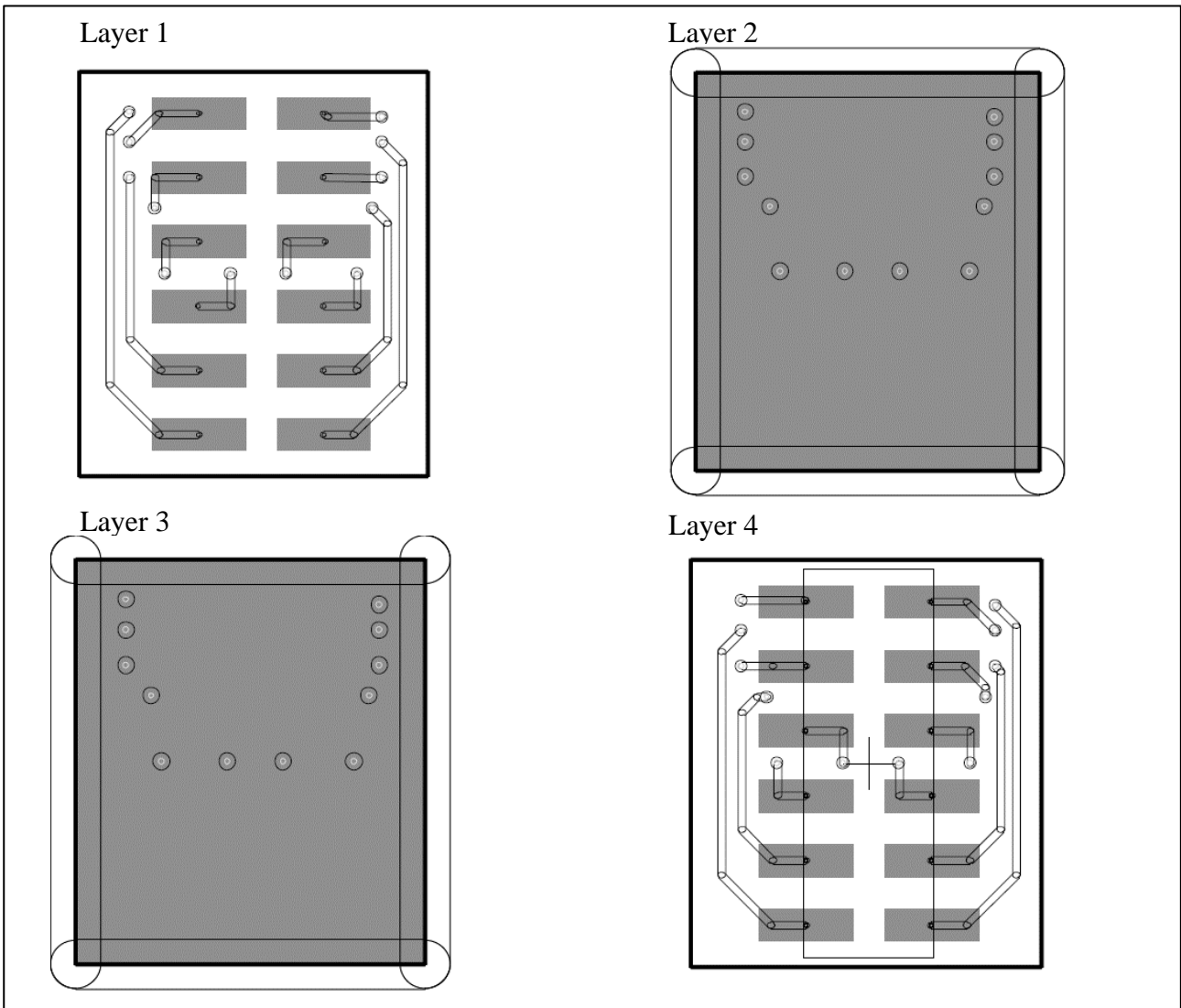

Figure 3-10 PCB layout of PMOD conversion board Layer1, Layer2, Layer3, Layer4

4. Dimensions

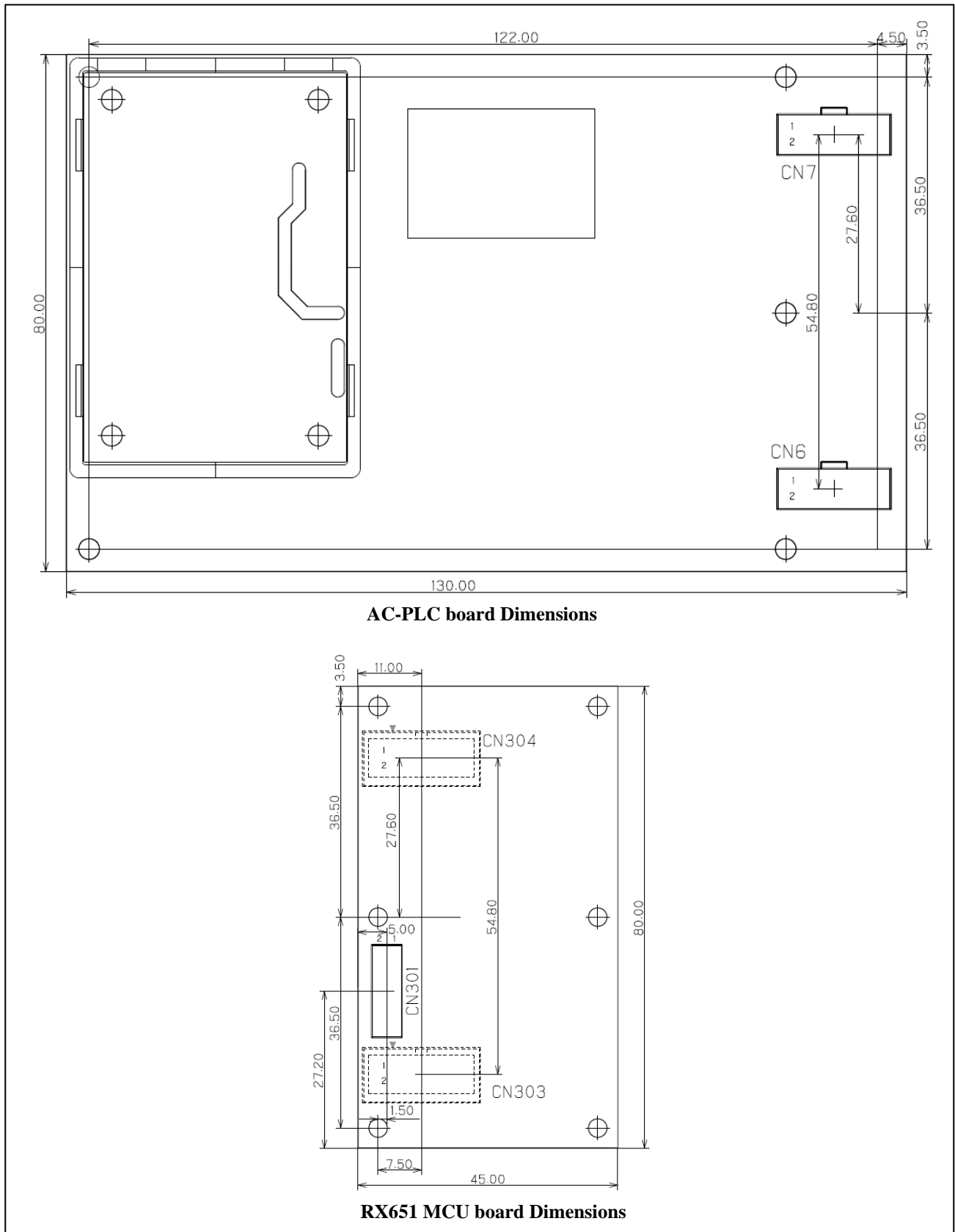

Figure 4-1 AC-PLC board and RX651 MCU board external dimensions

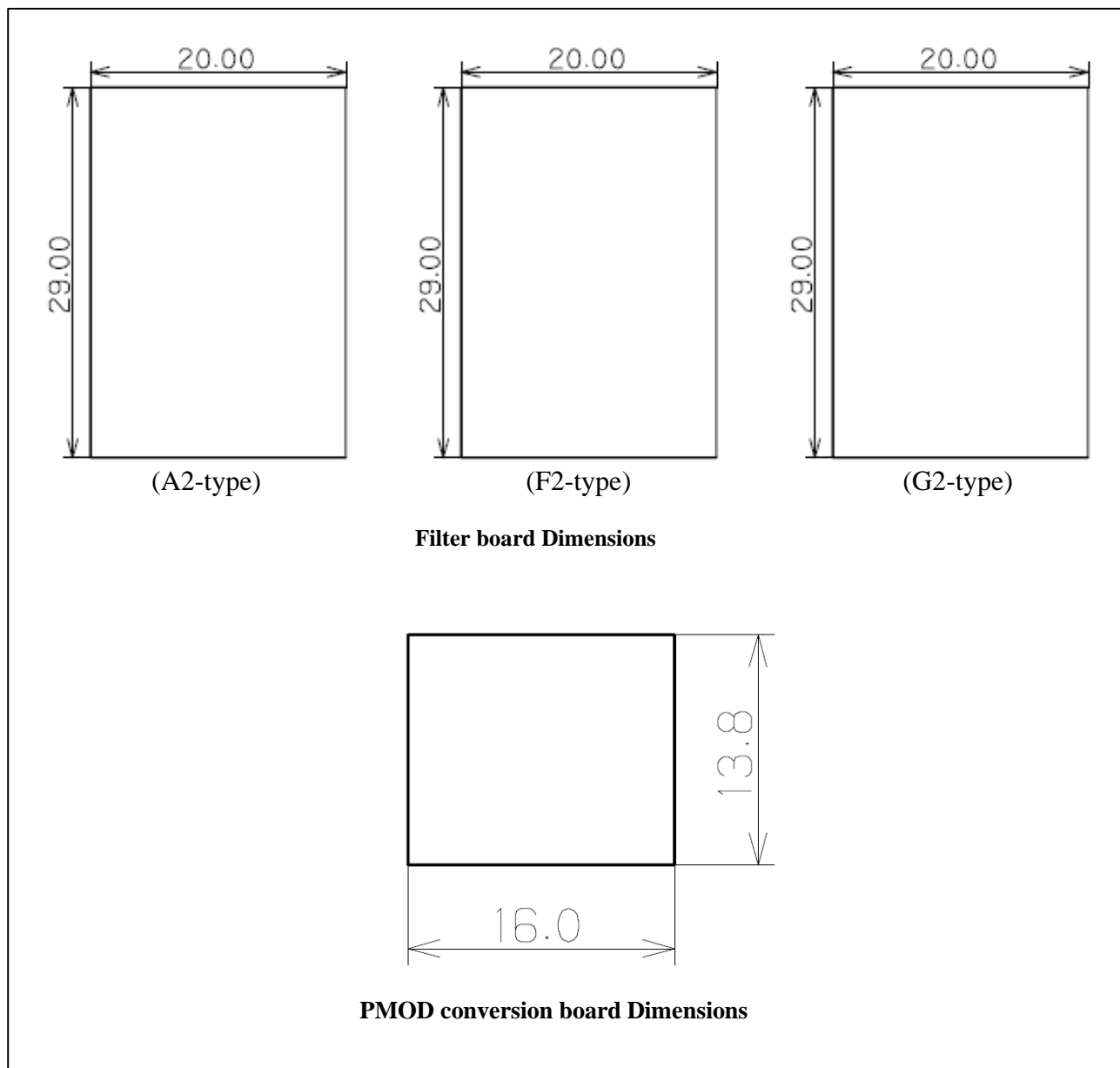

Figure 4-2 Filter board and PMOD conversion board external dimensions

Revision History

Rev.	Date	Description	
		Page	Summary
1.00	OCT 01, 2021		First Edition issued
1.01	APR 01, 2024	12	Added alternative product for Y1

General Precautions in the Handling of Microprocessing Unit and Microcontroller Unit Products

The following usage notes are applicable to all Microprocessing unit and Microcontroller unit products from Renesas. For detailed usage notes on the products covered by this document, refer to the relevant sections of the document as well as any technical updates that have been issued for the products.

1. Precaution against Electrostatic Discharge (ESD)

A strong electrical field, when exposed to a CMOS device, can cause destruction of the gate oxide and ultimately degrade the device operation. Steps must be taken to stop the generation of static electricity as much as possible, and quickly dissipate it when it occurs. Environmental control must be adequate. When it is dry, a humidifier should be used. This is recommended to avoid using insulators that can easily build up static electricity. Semiconductor devices must be stored and transported in an anti-static container, static shielding bag or conductive material. All test and measurement tools including work benches and floors must be grounded. The operator must also be grounded using a wrist strap. Semiconductor devices must not be touched with bare hands. Similar precautions must be taken for printed circuit boards with mounted semiconductor devices.

2. Processing at power-on

The state of the product is undefined at the time when power is supplied. The states of internal circuits in the LSI are indeterminate and the states of register settings and pins are undefined at the time when power is supplied. In a finished product where the reset signal is applied to the external reset pin, the states of pins are not guaranteed from the time when power is supplied until the reset process is completed. In a similar way, the states of pins in a product that is reset by an on-chip power-on reset function are not guaranteed from the time when power is supplied until the power reaches the level at which resetting is specified.

3. Input of signal during power-off state

Do not input signals or an I/O pull-up power supply while the device is powered off. The current injection that results from input of such a signal or I/O pull-up power supply may cause malfunction and the abnormal current that passes in the device at this time may cause degradation of internal elements. Follow the guideline for input signal during power-off state as described in your product documentation.

4. Handling of unused pins

Handle unused pins in accordance with the directions given under handling of unused pins in the manual. The input pins of CMOS products are generally in the high-impedance state. In operation with an unused pin in the open-circuit state, extra electromagnetic noise is induced in the vicinity of the LSI, an associated shoot-through current flows internally, and malfunctions occur due to the false recognition of the pin state as an input signal become possible.

5. Clock signals

After applying a reset, only release the reset line after the operating clock signal becomes stable. When switching the clock signal during program execution, wait until the target clock signal is stabilized. When the clock signal is generated with an external resonator or from an external oscillator during a reset, ensure that the reset line is only released after full stabilization of the clock signal. Additionally, when switching to a clock signal produced with an external resonator or by an external oscillator while program execution is in progress, wait until the target clock signal is stable.

6. Voltage application waveform at input pin

Waveform distortion due to input noise or a reflected wave may cause malfunction. If the input of the CMOS device stays in the area between V_{IL} (Max.) and V_{IH} (Min.) due to noise, for example, the device may malfunction. Take care to prevent chattering noise from entering the device when the input level is fixed, and also in the transition period when the input level passes through the area between V_{IL} (Max.) and V_{IH} (Min.).

7. Prohibition of access to reserved addresses

Access to reserved addresses is prohibited. The reserved addresses are provided for possible future expansion of functions. Do not access these addresses as the correct operation of the LSI is not guaranteed.

8. Differences between products

Before changing from one product to another, for example to a product with a different part number, confirm that the change will not lead to problems. The characteristics of a microprocessing unit or microcontroller unit products in the same group but having a different part number might differ in terms of internal memory capacity, layout pattern, and other factors, which can affect the ranges of electrical characteristics, such as characteristic values, operating margins, immunity to noise, and amount of radiated noise. When changing to a product with a different part number, implement a system-evaluation test for the given product.

Notice

1. Descriptions of circuits, software and other related information in this document are provided only to illustrate the operation of semiconductor products and application examples. You are fully responsible for the incorporation or any other use of the circuits, software, and information in the design of your product or system. Renesas Electronics disclaims any and all liability for any losses and damages incurred by you or third parties arising from the use of these circuits, software, or information.
2. Renesas Electronics hereby expressly disclaims any warranties against and liability for infringement or any other claims involving patents, copyrights, or other intellectual property rights of third parties, by or arising from the use of Renesas Electronics products or technical information described in this document, including but not limited to, the product data, drawings, charts, programs, algorithms, and application examples.
3. No license, express, implied or otherwise, is granted hereby under any patents, copyrights or other intellectual property rights of Renesas Electronics or others.
4. You shall be responsible for determining what licenses are required from any third parties, and obtaining such licenses for the lawful import, export, manufacture, sales, utilization, distribution or other disposal of any products incorporating Renesas Electronics products, if required.
5. You shall not alter, modify, copy, or reverse engineer any Renesas Electronics product, whether in whole or in part. Renesas Electronics disclaims any and all liability for any losses or damages incurred by you or third parties arising from such alteration, modification, copying or reverse engineering.
6. Renesas Electronics products are classified according to the following two quality grades: "Standard" and "High Quality". The intended applications for each Renesas Electronics product depends on the product's quality grade, as indicated below.
 - "Standard": Computers; office equipment; communications equipment; test and measurement equipment; audio and visual equipment; home electronic appliances; machine tools; personal electronic equipment; industrial robots; etc.
 - "High Quality": Transportation equipment (automobiles, trains, ships, etc.); traffic control (traffic lights); large-scale communication equipment; key financial terminal systems; safety control equipment; etc.Unless expressly designated as a high reliability product or a product for harsh environments in a Renesas Electronics data sheet or other Renesas Electronics document, Renesas Electronics products are not intended or authorized for use in products or systems that may pose a direct threat to human life or bodily injury (artificial life support devices or systems; surgical implantations; etc.), or may cause serious property damage (space system; undersea repeaters; nuclear power control systems; aircraft control systems; key plant systems; military equipment; etc.). Renesas Electronics disclaims any and all liability for any damages or losses incurred by you or any third parties arising from the use of any Renesas Electronics product that is inconsistent with any Renesas Electronics data sheet, user's manual or other Renesas Electronics document.
7. No semiconductor product is absolutely secure. Notwithstanding any security measures or features that may be implemented in Renesas Electronics hardware or software products, Renesas Electronics shall have absolutely no liability arising out of any vulnerability or security breach, including but not limited to any unauthorized access to or use of a Renesas Electronics product or a system that uses a Renesas Electronics product. RENESAS ELECTRONICS DOES NOT WARRANT OR GUARANTEE THAT RENESAS ELECTRONICS PRODUCTS, OR ANY SYSTEMS CREATED USING RENESAS ELECTRONICS PRODUCTS WILL BE INVULNERABLE OR FREE FROM CORRUPTION, ATTACK, VIRUSES, INTERFERENCE, HACKING, DATA LOSS OR THEFT, OR OTHER SECURITY INTRUSION ("Vulnerability Issues"). RENESAS ELECTRONICS DISCLAIMS ANY AND ALL RESPONSIBILITY OR LIABILITY ARISING FROM OR RELATED TO ANY VULNERABILITY ISSUES. FURTHERMORE, TO THE EXTENT PERMITTED BY APPLICABLE LAW, RENESAS ELECTRONICS DISCLAIMS ANY AND ALL WARRANTIES, EXPRESS OR IMPLIED, WITH RESPECT TO THIS DOCUMENT AND ANY RELATED OR ACCOMPANYING SOFTWARE OR HARDWARE, INCLUDING BUT NOT LIMITED TO THE IMPLIED WARRANTIES OF MERCHANTABILITY, OR FITNESS FOR A PARTICULAR PURPOSE.
8. When using Renesas Electronics products, refer to the latest product information (data sheets, user's manuals, application notes, "General Notes for Handling and Using Semiconductor Devices" in the reliability handbook, etc.), and ensure that usage conditions are within the ranges specified by Renesas Electronics with respect to maximum ratings, operating power supply voltage range, heat dissipation characteristics, installation, etc. Renesas Electronics disclaims any and all liability for any malfunctions, failure or accident arising out of the use of Renesas Electronics products outside of such specified ranges.
9. Although Renesas Electronics endeavors to improve the quality and reliability of Renesas Electronics products, semiconductor products have specific characteristics, such as the occurrence of failure at a certain rate and malfunctions under certain use conditions. Unless designated as a high reliability product or a product for harsh environments in a Renesas Electronics data sheet or other Renesas Electronics document, Renesas Electronics products are not subject to radiation resistance design. You are responsible for implementing safety measures to guard against the possibility of bodily injury, injury or damage caused by fire, and/or danger to the public in the event of a failure or malfunction of Renesas Electronics products, such as safety design for hardware and software, including but not limited to redundancy, fire control and malfunction prevention, appropriate treatment for aging degradation or any other appropriate measures. Because the evaluation of microcomputer software alone is very difficult and impractical, you are responsible for evaluating the safety of the final products or systems manufactured by you.
10. Please contact a Renesas Electronics sales office for details as to environmental matters such as the environmental compatibility of each Renesas Electronics product. You are responsible for carefully and sufficiently investigating applicable laws and regulations that regulate the inclusion or use of controlled substances, including without limitation, the EU RoHS Directive, and using Renesas Electronics products in compliance with all these applicable laws and regulations. Renesas Electronics disclaims any and all liability for damages or losses occurring as a result of your noncompliance with applicable laws and regulations.
11. Renesas Electronics products and technologies shall not be used for or incorporated into any products or systems whose manufacture, use, or sale is prohibited under any applicable domestic or foreign laws or regulations. You shall comply with any applicable export control laws and regulations promulgated and administered by the governments of any countries asserting jurisdiction over the parties or transactions.
12. It is the responsibility of the buyer or distributor of Renesas Electronics products, or any other party who distributes, disposes of, or otherwise sells or transfers the product to a third party, to notify such third party in advance of the contents and conditions set forth in this document.
13. This document shall not be reprinted, reproduced or duplicated in any form, in whole or in part, without prior written consent of Renesas Electronics.
14. Please contact a Renesas Electronics sales office if you have any questions regarding the information contained in this document or Renesas Electronics products.

(Note1) "Renesas Electronics" as used in this document means Renesas Electronics Corporation and also includes its directly or indirectly controlled subsidiaries.

(Note2) "Renesas Electronics product(s)" means any product developed or manufactured by or for Renesas Electronics.

(Rev.5.0-1 October 2020)

Corporate Headquarters

TOYOSU FORESIA, 3-2-24 Toyosu,
Koto-ku, Tokyo 135-0061, Japan
www.renesas.com

Trademarks

Renesas and the Renesas logo are trademarks of Renesas Electronics Corporation. All trademarks and registered trademarks are the property of their respective owners.

Contact information

For further information on a product, technology, the most up-to-date version of a document, or your nearest sales office, please visit:
www.renesas.com/contact/.