

RX66T CPU Card User's Manual

R12UZ0029EJ0120
Rev.1.20
2022.2.21

For Your Safety



Do not fail to read this manual before using the RX66T CPU card (RTK0EMX870C00000BJ) (the product).

- Follow the indications in this manual when using the product.
- This product is an option board for "Evaluation System for BLDC Motor (RTK0EMX270S00020BJ)" and "24V Motor Control Evaluation System for RX23T (RTK0EM0006S01212BJ)".
- Keep this manual near the product so you can refer to it whenever necessary.
- Transfer or sale of the product to third parties is prohibited without written approval.
- The purchaser or importer of the product is responsible for ensuring compliance with local regulations. In addition, the customer is responsible for ensuring that the product is handled correctly and safely, in accordance with the laws of the customer's country (region).
- All information contained in this manual represents information on products at the time of publication of this manual. Please note that the product data, specification, sales offices, contents of website, address, etc., are subject to change by Renesas Electronics Corporation without notice due to product improvements or other reasons. Please confirm the latest information on Renesas Electronics website.
- The manual for the product, and specification (the documents) are the tool that was developed for the function and performance evaluation of Renesas Electronics semiconductor device (Renesas Electronics device) mounted on the product, and not guarantee the same quality, function and performance.
- By purchasing the product or downloading the documents from Renesas Electronics website, the support services provided from Renesas Electronics is not guaranteed.

Meaning of Notations

In this manual items related to the safe use of the product are indicated as described below.

The degree of injury to persons or damage to property that could result if the designated content in this manual is not followed is indicated as follows.

 Danger	Indicates content that, if not followed, could result in death or serious injury* ¹ to the user, and which is highly urgent.
 Warning	Indicates content that, if not followed, could result in death or serious injury to the user.
 Caution	Indicates content that, if not followed, could result in injury* ² to persons or physical damage.* ³

Note 1. Serious injury refers to conditions resulting in persistent after-effects and for which treatment would necessitate hospitalization or regular hospital visits, such as loss or impairment of eyesight, burns (high- or low-temperature), electric shock, bone fracture, or poisoning.

Note 2. Injury refers to conditions for which treatment would necessitate hospitalization or regular hospital visits.

Note 3. Physical damage refers to damage affecting the wider surroundings, such as the user's home or property.

Requirements related to the handling of the product are classified into the following categories.



- Marks indicating that an action is prohibited.

	<p>General Prohibition The indicated action is prohibited.</p>		<p>Example: Do Not Touch! Touching the specified location could result in injury.</p>
---	---	---	---

- Marks indicating that an action is prohibited.





	<p>General Caution Indicates a general need for caution that is not specified.</p>		<p>Example: Caution – Hot! Indicates the possibility of injury due to high temperature.</p>
---	---	---	---

- Marks directing that the specified action is required.







	<p>General Instruction The specified action is required.</p>		<p>Example: Turn Off (Disconnect) Power Supply! Instructs the user to turn off (disconnect) the power supply to the product.</p>
---	---	---	--

Warnings Regarding Use of the Product





■ Danger Items

 Danger	
  	<ul style="list-style-type: none"> The product should be used only by persons (users) having a thorough knowledge of electrical and mechanical components and systems, a full knowledge of the risks associated with handling them, and training in inverter motor control and handling motors, or equivalent skills. Users should be limited to persons who have carefully read the Caution Items contained in this manual. Unlike typical equipment, the product has no protective case to ensure safety, and it contains moving parts and high-temperature components that could be dangerous. Do not touch the evaluation board or cables while power is being supplied. Carefully check to make sure that there are no pieces of conductive materials or dust adhering to the board, connectors, and cables. There are moving parts, driven by a motor. Do not touch the motor while power is being supplied. Ensure that the motor is insulated and placed in a stable location before supplying power.
	<p>Do Not Connect Load to Motor!</p> <ul style="list-style-type: none"> This could cause fire, burns, or injury.

■ Warning Items

 Warning	
	<p>Caution – Rotating Parts!</p> <ul style="list-style-type: none"> The system includes a motor. Touching the rotating shaft could cause high-temperature burns or injury.
	<p>Always insert plugs, connectors, and cables securely, and confirm that they are fully inserted.</p> <ul style="list-style-type: none"> Incomplete connections could cause fire, burns, electric shock, or injury.
	<p>Use the power supply apparatus specified in the manual.</p> <ul style="list-style-type: none"> Failure to do so could cause fire, burns, electric shock, injury, or malfunction.
	<p>Disconnect the power supply and unplug all cables when the system will not be used for a period of time or when moving the system.</p> <ul style="list-style-type: none"> Failure to do so could cause fire, burns, electric shock, or malfunction. This will protect the system against damage due to lightning.
	<p>Use a mechanism (switch, outlet, etc.) located within reach to turn off (disconnect) the power supply.</p> <ul style="list-style-type: none"> In case of emergency, it may be necessary to cut off the power supply quickly.
	<p>Turn off the power supply immediately if you notice abnormal odor, smoke, abnormal sound, or overheating.</p> <ul style="list-style-type: none"> Continuing to use the system in an abnormal condition could cause fire, burns, or electric shock.
	<p>Do Not Disassemble, Modify, or Repair!</p> <ul style="list-style-type: none"> Doing so could cause fire, burns, electric shock, injury, or malfunction.
	<p>Do not use the product for any purpose other than initial evaluation of motor control in a testing room or lab. Do not integrate the product or any part of it into other equipment. Do not insert or remove cables or connectors when the product is powered on.</p> <ul style="list-style-type: none"> The product has no safety case. Failure to observe the above could cause fire, electric shock, burns, or malfunction. The product may not perform as expected if used for other than its intended purpose.

■ Caution Items

 Caution	
	<p>Caution – Hot!</p> <ul style="list-style-type: none"> The motor gets hot. Touching it could cause high-temperature burns.
	<p>Follow the procedure specified in the manual when powering the system on or off.</p> <ul style="list-style-type: none"> Failure to do so could cause overheating or malfunction.
	<p>Caution – Static Electricity</p> <ul style="list-style-type: none"> Use the antistatic band. Failure to do so could cause malfunction or unstable motion.

Overview

The RX66T CPU card (RTK0EMX870C00000BJ) is an optional board for the Evaluation System for BLDC Motor (RTK0EMX270S00020BJ) and the 24V Motor Control Evaluation System for RX23T (RTK0EM0006S01212BJ). By connecting this product to an inverter board (the INV-BRD), motor evaluation using RX66T becomes possible.

An emulator, INV-BRD, and equipment must be provided by the customer.

This user's manual describes the proper handling of the product.

Target Device

RX66T microcontroller

Related Documents

- RX66T CPU Card Schematic : R12TU0049EJ
- RX66T CPU Card BOM List : R12TU0050EJ
- RX66T CPU Card PWB Pattern Drawing : R12TU0051EJ
- Evaluation System for BLDC Motor User's Manual: R12UZ0062
24V Motor Control Evaluation System for RX23T User's Manual: R20UT3697EJ

Package Contents

- RX66T CPU Card Information
- Caution regarding the Motor Control Evaluation Board - RX66T CPU Card -

Abbreviations

Abbreviations	Full Name	Remarks
INV-BRD	Inverter Board	Inverter board included in "Evaluation System for BLDC Motor" (Board P/N.: RTK0EM0000B10020BJ) or Inverter board included in "24V Motor Control Evaluation System for RX23T" (Board P/N.: RTK0EM0001B00012BJ)
E1	E1 emulator	on-chip debugging emulator and flash programmer Product No.: R0E000010KCE00
E2 Lite	E2 emulator Lite	on-chip debugging emulator and flash programmer Product No.: RTE0T0002LKCE00000R

Contents

1. Specifications	6
1.1 Specification.....	6
1.2 Regulatory Compliance Notices.....	7
1.2.1 European Union regulatory notices.....	7
2. Block Diagram	8
3. Layout	9
4. Usage	10
5. Functions	11
5.1 Power Supply.....	11
5.2 Connecting the Emulator	11
5.3 Connecting the Inverter Board	12
5.4 Connecting the Serial Communication.....	13
5.5 Hall Sensor Signal Input.....	13
5.6 Encoder Signal Input	14
5.7 Connecting the Extender Board	15
5.8 Extension of Unused Pins.....	16
5.9 Reset Circuit	17
5.10 Crystal Resonator	17
5.11 LEDs	17
5.12 JP1, JP2.....	17
6. Details of RX66T CPU Card	18
6.1 RX66T Features	18
6.2 RX66T Pin Assignments.....	19
6.3 List of RX66T Pin Functions	20
7. Caution Items	23
Revision History	25

1. Specifications

1.1 Specification

Table 1.1 Overview of RX66T CPU Card Specifications

Item	Specification	
Product name	RX66T CPU card	
Board product No.	RTK0EMX870C0000BJ	
Supported inverter board / product No.	Inverter board supplied with Evaluation System for BLDC Motor / RTK0EM0000B10020BJ Supplied with 24V Motor Control Evaluation System for RX23T 24V Inverter Board / RTK0EM0001B00012BJ	
Exterior view		
Note: Appearance of actual product may differ from photo.		
MCU *1	Product group	RX66T group
	Product No.	R5F566TEADFP
	CPU max. operating frequency	160 MHz
	Bit count	32 bits
	Package / Pin count	LFQFP / 100 pins
	ROM	512 KB
	RAM	64KB
MCU input clock	8MHz	
Input power supply voltage	DC 5 V ($\pm 5\%$) *2 Selectable among the following: <ul style="list-style-type: none"> • Power supply from supported inverter board • Power supply from supported emulator *3 	
Supported sensors	Hall sensor, encoder (through holes provided for signal monitoring test pins)	
Supported emulator	E1, E2 Lite	
Connectors	<ul style="list-style-type: none"> • Inverter board connectors x 2 • Serial communication connectors x 3 • Emulator connector x 1 • Hall sensor signal input connector x 1 • Encoder signal input connector x 1 • Extender board connector x 2 	
Switch	MCU external reset switch	
LEDs	User control LEDs x 2	
Operating temperature	Room temperature	
Operating humidity	No condensation	

Note 1. Refer the latest Technical update for the equipped MCU. When you use the temperature sensor of MCU, note that Temperature Sensor Calibration Data Register (TSCDR) of the MCU is not available for the lot No.18JN001~18JN050 of this product.

Note 2. Supply voltage is DC 3.3V from E2 Lite.

Note 3. Power supply from the supported emulator is only supported for standalone operation. Power supply from the supported emulator is not supported when the INV-BRD is connected.

1.2 Regulatory Compliance Notices

1.2.1 European Union regulatory notices

This product complies with the following EU Directives. (These directives are only valid in the European Union.)

CE Certifications:

- Electromagnetic Compatibility (EMC) Directive 2014/30/EU
EN61326-1 : 2013 Class A

WARNING: This is a Class A product. This equipment can cause radio frequency noise when used in the residential area. In such cases, the user/operator of the equipment may be required to take appropriate countermeasures under his responsibility.

- Information for traceability
 - Authorised representative
Name: Renesas Electronics Corporation
Address: Toyosu Foresia, 3-2-24, Toyosu, Koto-ku, Tokyo 135-0061, Japan
 - Manufacturer
Name: Renesas Electronics Corporation
Address: Toyosu Foresia, 3-2-24, Toyosu, Koto-ku, Tokyo 135-0061, Japan
 - Person responsible for placing on the market
Name: Renesas Electronics Europe GmbH
Address: Arcadiastrasse 10, 40472 Dusseldorf, Germany
 - Trademark and Type name
Trademark: Renesas
Product name: RX66T CPU Card for Motor Control
Type name: RTK0EMX870C00000BJ

Environmental Compliance and Certifications:

- Waste Electrical and Electronic Equipment (WEEE) Directive 2012/19/EU

2. Block Diagram

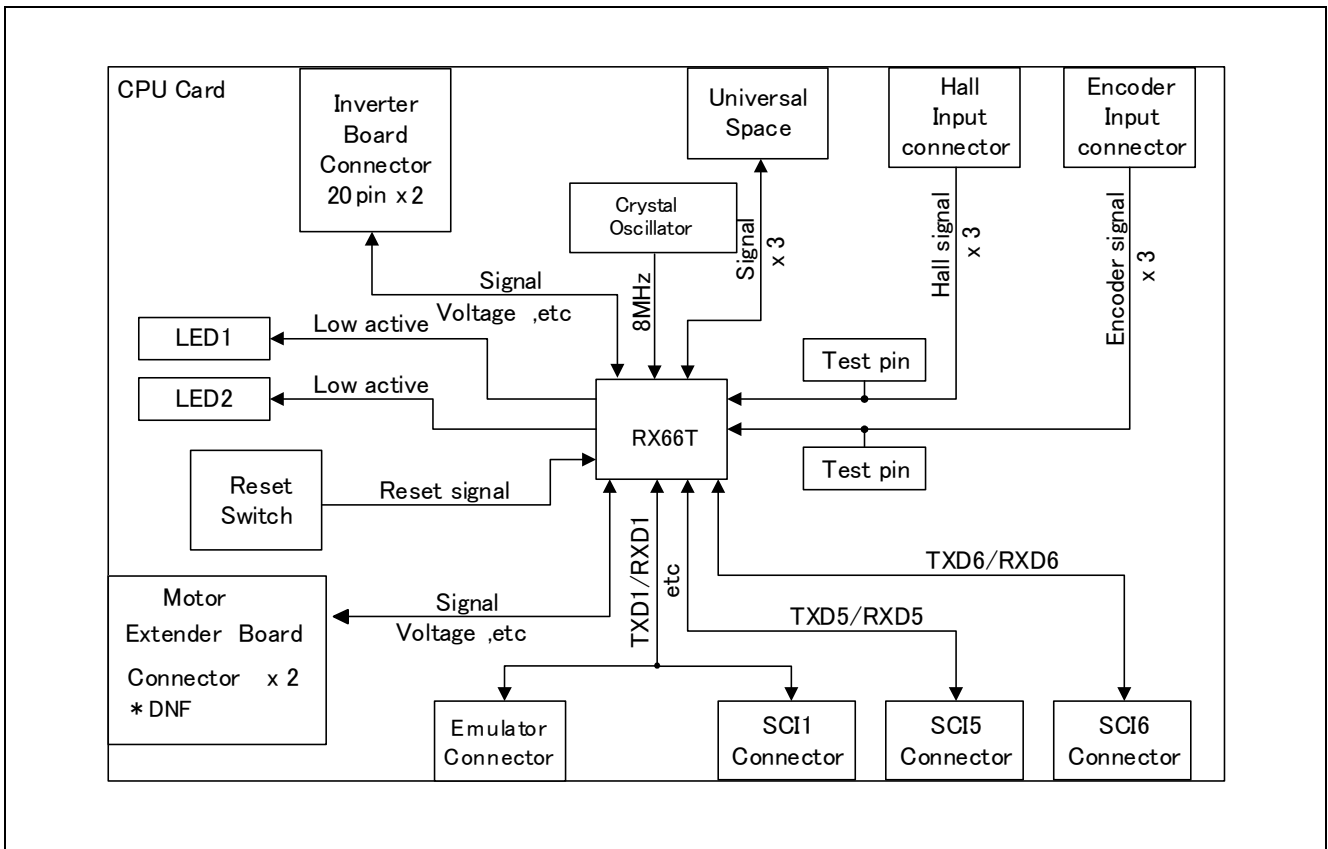

Figure 3.1 RX66T CPU Card Block Diagram

3. Layout

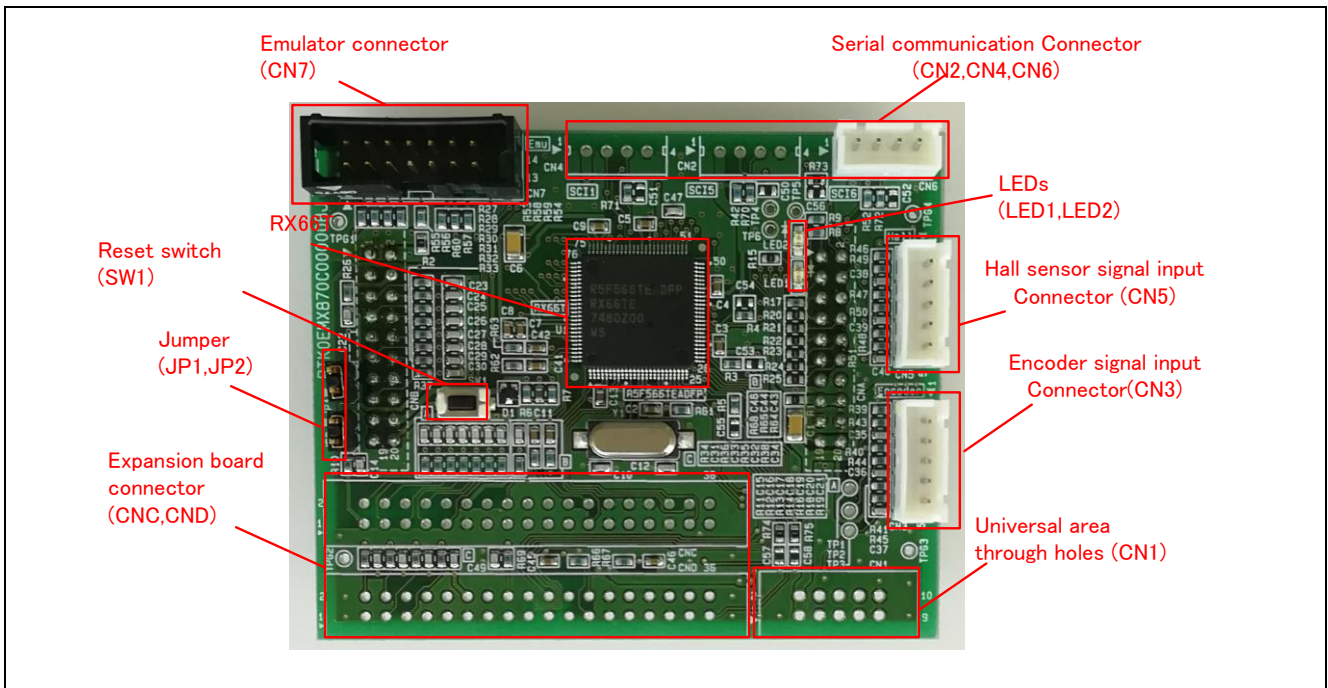

Figure 3.1 RX66T CPU Card Layout (Top View)

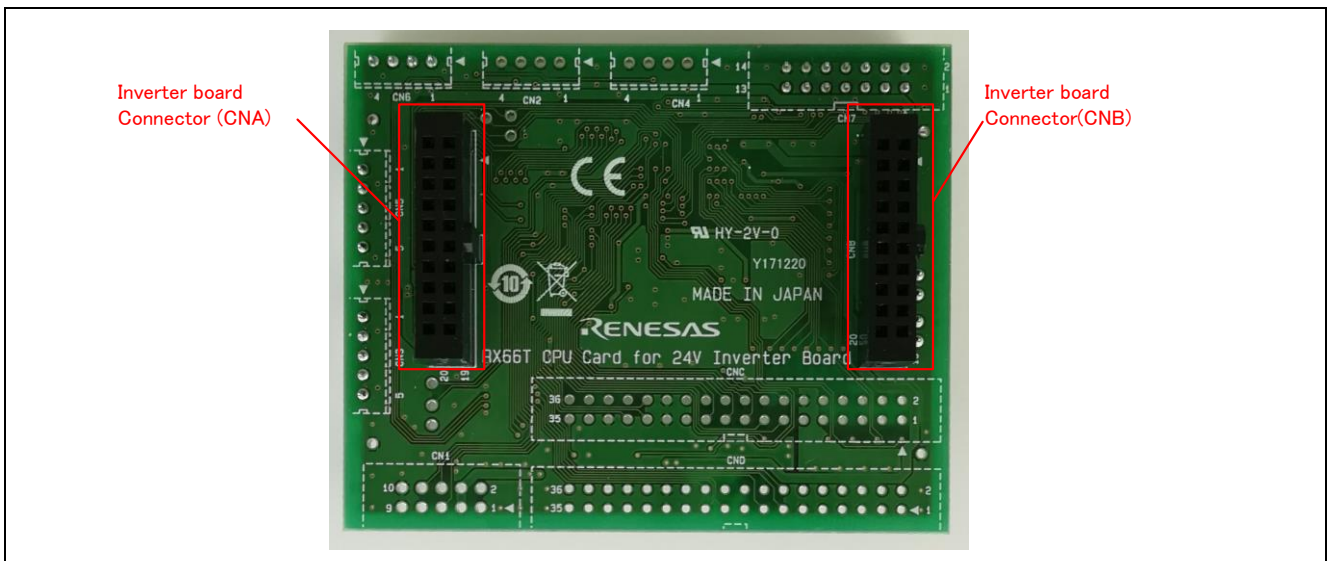

Figure 3.2 RX66T CPU Card Layout (Bottom View)

4. Usage

Before connecting to the INV-BRD, be sure to write the software corresponding to the INV-BRD to this product. The board may be damaged if it is connected to the INV-BRD with the factory default software or with software that is not compatible with the inverter board.

For details on writing software, please refer to 5.2. For the operation of the written software, refer to the application note of each software.

Please refer to the user's manual of each INV-BRD for the connection method with INV-BRD.

5. Functions

5.1 Power Supply

The product does not have a dedicated power supply connector. When connected to the INV-BRD it draws power via the connector. When not connected to the INV-BRD, it can draw power via the Emulator connector. The product is not allowed to draw power via the Emulator connector when it is connected to the INV-BRD.

5.2 Connecting the Emulator

The E1/E2 Lite on-chip debugging emulator from Renesas Electronics is used to write software (program) to the flash memory of the RX66T. Software will be downloaded into the product via E1 or E2 Lite. It is also necessary to make the settings shown in Table 5.1 in the integrated development environment or in the Renesas flash programmer to enable the emulator to supply power to the product. Table 5.2 lists the pin assignments of the Emulator connector.

Table 5.1 E1, E2 Lite Power Supply Settings

Connection to INV-BRD	Power Supply Setting of E1, E2 Emulator
Connected	Power supply is not allowed*1
Not connected	5.0V or 3.3V power supply

Note 1. When connected to the INV-BRD, the product must draw power from the INV-BRD.

Table 5.2 Pin Assignments of Emulator Connector (CN7)

Pin No.	Pin Function	RX66T Connection Pins	Pin No.	Pin Function	RX66T Connection Pins
1	TCK/FINEC	TCK	2	GND	VSS
3	TRST#	TRST#	4	EMLE	EMLE
5	TXD1/TDO	TXD1	6	NC	-
7	MD/FINED	MD/FINED	8	VCC	VCC
9	TMS	TMS	10	UB	UB
11	TDI/RXD1	RXD1	12	GND	VSS
13	RESET#	RES#	14	GND	VSS

Note: See a supplement to the E1/E20/E2 emulator, E2 emulator Lite user's manual.

5.3 Connecting the Inverter Board

The product connects to the INV-BRD via the inverter board connectors (CNA and CNB). Table 5.3 and Table 5.4 list the pin assignments of the inverter board connectors.

Table 5.3 Pin Assignments of Inverter Board Connector (CNA)

Pin No.	Pin Function	RX66T Connection Pins	Pin No.	Pin Function	RX66T Connection Pins
1	LED1#	PE3	2	LED2#	PB7
3	LED3#	PB3	4	NC	P24
5	FO#	P70/POE0#	6	NC	-
7	WN	P76/MTIOC4D	8	VN	P75/MTIOC4C
9	UN	P74/MTIOC3D	10	WP	P73/MTIOC4B
11	VP	P72/MTIOC4A	12	UP	P71/MTIOC3B
13	SW1#	P80	14	SW2#	P81
15	5V	VCC	16	5V	VCC
17	GND	VSS	18	GND	VSS
19	3.3V	-	20	3.3V	-

Table 5.4 Pin Assignments of Inverter Board Connector (CNB)

Pin No.	Pin Function	RX66T Connection Pins	Pin No.	Pin Function	RX66T Connection Pins
1	AVCC	AVCC	2	AVCC	AVCC
3	NC	-	4	PGAVSS1	PGAVSS0
5	IU	P40/AN000	6	IV	P41/AN001
7	IW	P42/AN002	8	VPN	P62/AN208
9	TEMP(VOT)	-	10	VU	P52/AN200
11	VV	P53/AN201	12	VW	P54/AN202
13	VAC	-	14	IPFC	-
15	VR1	P21/AN217	16	VN	-
17	VCCIO	VCC	18	VCCIO	VCC
19	GND	VSS	20	GND	VSS

5.4 Connecting the Serial Communication

The product communicates with the UART via the serial communication connectors. There are three serial communication connectors: CN2, CN4, and CN6. Table 5.5 lists their pin assignments. Use CN6 when using a tool such as waveform display in conjunction with the INV-BRD.

Table 5.5 Pin Assignments of Serial Communication Connectors (CN2, CN4, CN6)

Connector No.	Pin No.	Pin Function	RX66T Connection Pins
CN2 SCI5	1	5V	VCC
	2	RX66T transmit side	PB5/TXD5
	3	RX66T receive side	PB6/RXD5
	4	GND	VSS
CN4 SCI1	1	5V	VCC
	2	RX66T transmit side	PD3/TXD1*1
	3	RX66T receive side	PD5/RXD1*1
	4	GND	VSS
CN6 SCI6	1	5V	VCC
	2	RX66T transmit side	PB0/TXD6
	3	RX66T receive side	PB1/RXD6
	4	GND	VSS

Note 1. TXD / RXD of SCI1 is shared with E1, E2 Lite. Please do not use the SCI1 during E1 or E2 Lite connection.

5.5 Hall Sensor Signal Input

The product is equipped with a Hall sensor signal input connector. The signal input to the product is pulled up to 5 V and passed through an RC filter before being input to the RX66T. Table 5.6 lists the pin assignments of the Hall sensor signal input connector, and Table 5.7 lists connector information.

Table 5.6 Pin Assignments of Hall Sensor Signal Input Connector (CN5)

Pin No.	Pin Function	RX66T Connection Pins
1	5V	VCC
2	GND	VSS
3	HU	PE0/IRQ7
4	HV	PE1/IRQ15
5	HW	PE5/IRQ0

Table 5.7 Hall Sensor Signal Input Connector Information

Part	Product No.	Manufacturer
Connector (CN5)	B5B-XH-A	J.S.T. Mfg. Co. Ltd.

5.6 Encoder Signal Input

The product is equipped with an encoder signal input connector. This makes it possible to input the encoder signal to the RX66T. The signal input to the product is pulled up to 5 V and passed through an RC filter before being input to the RX66T. Table 5.8 lists the pin assignments of the signal input connector, and Table 5.9 lists connector information.

Table 5.8 Pin Assignments of Encoder Signal Input Connector (CN3)

Pin No.	Pin Function	RX66T Connection Pins
1	5V	VCC
2	GND	VSS
3	Phase A	P33
4	Phase B	P32
5	Phase Z	PA5

Table 5.9 Encoder Signal Input Connector Information

Part	Product No.	Manufacturer
Connector (CN3)	B5B-XH-A	J.S.T. Mfg. Co. Ltd.

5.7 Connecting the Extender Board

This product is equipped with two Extender board Connector. This connector can connect Extender Board (RTK0EM0000Z02000BJ) via the cable. This makes it possible to control three INV-BRDs. In other words, this product can drive three motors. Table 5. 10 lists the pin assignments of the 2nd Extender board Connector.

Table 5. 11 lists the pin assignments of the 3rd Extender board Connector. Note that the pin assignments of CND are different from those of CNC and that some pins of CND are pull-upped because of sharing the pins with CN7.

Table 5. 10 Pin Assignments of 2nd Extender boards Connector

CNC Pin No.	CNC Pin Function	RX66T Connection Pins	CNC Pin No.	CNC Pin Function	RX66T Connection Pins
1	PGAVSS_2	AVSS1	2	VPN_2	P63/AN209
3	IU_2	P44/AN100	4	IV_2	P45/AN101
5	IW_2	P46/AN102	6	TEMP_2	-
7	VU_2	P55/AN203	8	VV_2	P60/AN206
9	VW_2	P61/AN207	10	VR_2	-
11	GND	VSS	12	GND	AVSS
13	LED1#_2	PB2	14	-	PE2
15	LED3#_2	PA4	16	FO#_2	P96/POE4#
17	WN_2	P90/MTIOC7D	18	VN_2	P91/MTIOC7C
19	UN_2	P92/MTIOC6D	20	WP_2	P93/MTIOC7B
21	VP_2	P94/MTIOC7A	22	UP_2	P95/MTIOC6B
23	SW1#_2	P10	24	SW2#_2	P11
25	GND	VSS	26	GND	VSS
27	ENC_A_2	P31	28	ENC_B_2	P30
29	ENC_Z_2	PA3	30	GND	VSS
31	GND	VSS	32	HALL_U_2	P01/IRQ4
33	HALL_V_2	PE4/IRQ1	34	HALL_W_2	P00/IRQ2
35	VRL2	PD1	36	NC	-

Table 5. 11 Pin Assignments of 3rd Extender boards Connector

CND Pin No.	CND Pin Function	RX66T Connection Pins	CND Pin No.	CND Pin Function	RX66T Connection Pins
1	PGAVSS_3	-	2	VPN_3	P64/AN210
3	IU_3	P43/AN003	4	IV_3	P47/AN103
5	IW_3	P65/AN211	6	TEMP_3	-
7	VU_3	-	8	VV_3	-
9	VW_3	-	10	VR_3	-
11	GND	VSS	12	GND	AVSS
13	LED1#_3	PA0	14	LED2#_3	PA2
15	LED3#_3	PA1	16	FO#_3	PB4/POE8#
17	WN_3	PD2/GTIOC2B	18	WP_3	TXD1/GTIOC2A
19	VN_3	PD4/GTIOC1B	20	VP_3	RXD1/GTIOC1A
21	UN_3	TMS/GTIOC0B	22	UP_3	PD7/GTIOC0A
23	SW1#_3	P82	24	SW2#_3	P22
25	GND	VSS	26	GND	VSS
27	ENC_A_3	-	28	ENC_B_3	-
29	ENC_Z_3	-	30	GND	VSS
31	GND	VSS	32	HALL_U_3	-
33	HALL_V_3	-	34	HALL_W_3	-
36	VRL3	PD0	36	NC	-

5.8 Extension of Unused Pins

To facilitate general use of the product, the unused pins of the RX66T are extended through universal connector through holes in the board. Table 5.12 lists the pin assignments of the universal area through holes.

Table 5.12 Pin Assignments of Universal Area Through Holes (CN1)

Pin No.	RX66T Connection Pins	Pin No.	RX66T Connection Pins
1	UVCC	2	UVCC
3	AVCC	4	AVCC
5	P20	6	P23
7	-	8	P27
9	GND	10	GND

5.9 Reset Circuit

The product is equipped with a reset circuit for resetting the microcontroller at power-on reset and external reset. To apply an external reset to the microcontroller, press the pushbutton (SW1).

5.10 Crystal Resonator

This product is mounted crystal oscillator (Y1) on 8MHz.

5.11 LEDs

Two LEDs are mounted on the product for use in debugging programs and general system applications. Each turns on when the output on the corresponding port is low-level and turns off when the output is high-level. Table 5.13 lists the pin assignments corresponding to the LEDs.

Table 5.13 RX66T CPU Card LED Connection Pin Assignments

Corresponding RX66T Port		LED1	LED2
PE3	High-level output	Off	-
	Low-level output	On	-
PB7	High-level output	-	Off
	Low-level output	-	On

5.12 JP1, JP2

JP1 and JP2 should be short-circuited between 2-3Pin.

Table 5.14 Jumper JP1 and JP2 configuration

JP1, JP2 configuration	Function	
	JP1	JP2
Open	Connect MCU (PGAVSS0 pin) to CNC (1 pin)	Connect MCU (PGAVSS1 pin) to CNB (4 pin)
Short (At the time of shipment)	Connect MCU (PGAVSS0 pin) to GND	Connect MCU (PGAVSS1 pin) to GND

6. Details of RX66T CPU Card

6.1 RX66T Features

1. 32-bit microcontroller with RXv3 CPU core for motor control
2. On-chip 32-bit single-precision floating point unit (FPU)
3. Ability to output three-phase complementary PWM waveforms on three channels
4. Ability to set timer interrupt as A/D trigger
5. Three 12-bit A/D converter units with a total of 22 channels
6. Channel-dedicated sample and hold function
7. On-chip programmable gain amplifier and comparator
8. Timer output stop (Hi-Z) function
9. On-chip independent watchdog timer

6.2 RX66T Pin Assignments

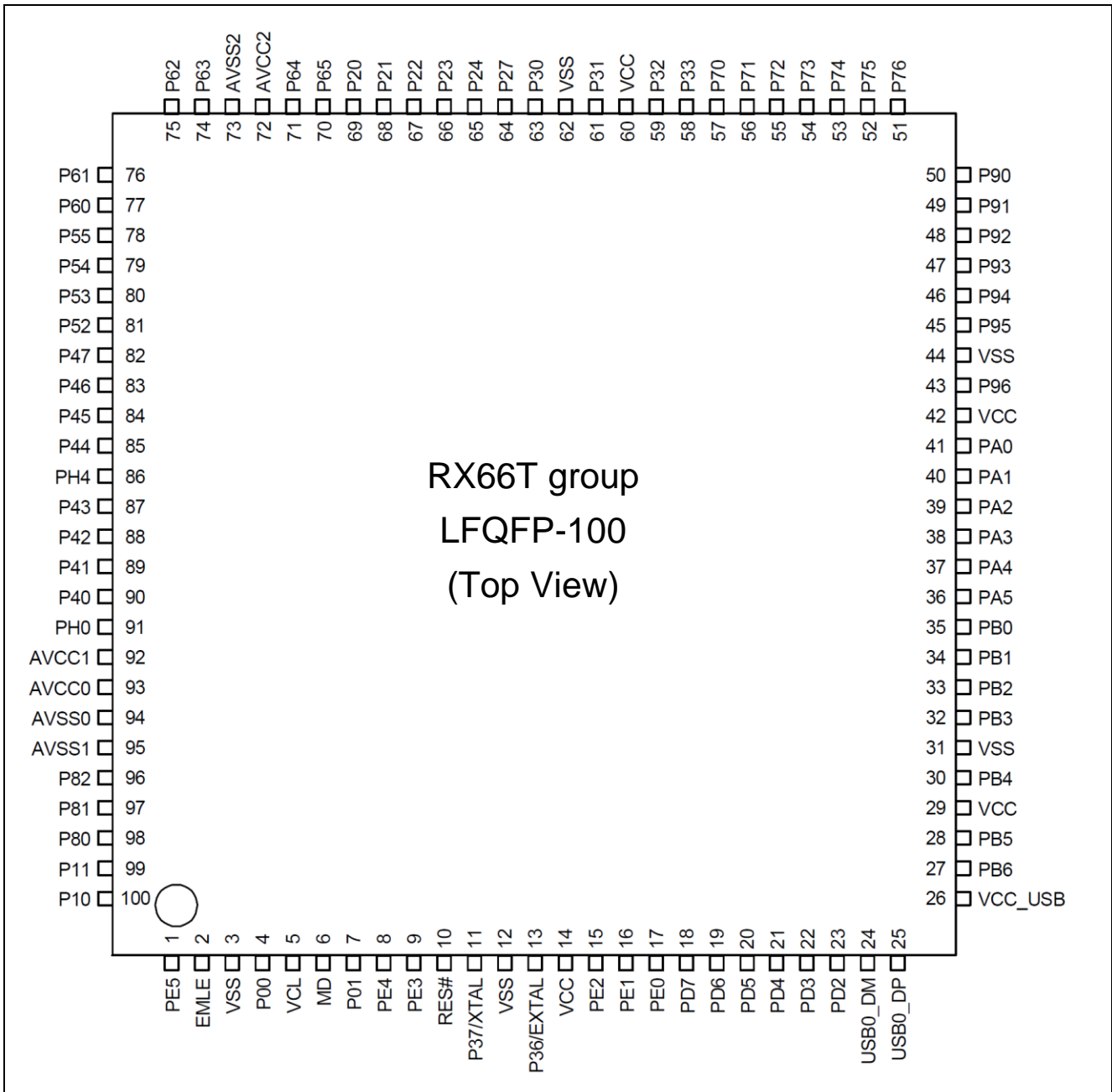

Figure 6.1 RX66T Pin Assignments

6.3 List of RX66T Pin Functions

Table 6.1 List of RX66T Pin Functions(1/3)

Pin No.	RX66T Pin Functions	CPU Card Connection	External Connection (N.C. : No connection)
1	PE5/BCLK/MTIOC9D/GTIOC3A/GTETRGB/GTETRGD /SCK9/CTS9#/RTS9#/SS9#/IRQ0/ADST0	CN5-5	HALL_W_1
2	EMLE	CN7-4	E1, E2 Lite
3	VSS	VSS	VSS
4	UB/P00/A11/MTIOC9A/CACREF/RXD9/SMISO9/SSCL9 /RXD12/SMISO12/SSCL12/RXDX12/IRQ2/ADST1/COMP0	CNC-34	HALL_W_2
5	VCL	Connect to capacitor	-
6	MD/FINED	CN7-7	E1, E2 Lite
7	P01/A10/MTIOC9C/GTETRGA/GTETRGB/GTETRGC /GTETRGD/POE12#/TXD9/SMOSI9/SSDA9/TXD12 /SMOSI12/SSDA12/TXDX12/SIOX12/IRQ4/ADST2/COMP1	CNC-32	HALL_U_2
8	PE4/A9/MTCLKC/GTETRGA/GTETRGB/GTETRGC /GTETRGD/POE10#/SCK9/IRQ1	CNC-33	HALL_V_2
9	PE3/A8/MTCLKD/GTETRGA/GTETRGB/GTETRGC /GTETRGD/POE11#/CTS9#/RTS9#/SS9#/IRQ2_DS	CNA-1	LED1#_1
10	RES#	RESET CN7-13	MCU RESET
11	XTAL/P37	Crystal oscillator (8MHz)	MCU oscillating
12	VSS	VSS	VSS
13	EXTAL/P36	Crystal oscillator (8MHz)	MCU oscillating
14	VCC	VCC	VCC
15	PE2/POE10#/NMI	CNC-14	-
16	PE1/WR0#/WR#/MTIOC9D/TMO5/CTS5#/RTS5#/SS5# /CTS12#/RTS12#/SS12#/SSLA3/IRQ15	CN5-4	HALL_V_1
17	PE0/WR1#/BC1#/WAIT#/MTIOC9B/TMCI1/TMCI5/RXD5 /SMISO5/SSCL5/SSLA2/CRX0/IRQ7	CN5-3	HALL_U_1
18	TRST#/PD7/MTIOC9A/GTIOC0A/GTIOC3A/TMRI1/TMRI5	CND-22	UP_3
19	TMS/PD6/MTIOC9C/GTIOC0B/GTIOC3B/TMO1/CTS1# /RTS1#/SS1#/CTS11#/RTS11#/SS11#/SSLA0/IRQ5/ADST0	CND-21	VP_3
20	TDI/PD5/GTIOC1A/GTETRGA/TMRI0/TMRI6/RXD1 /SMISO1/SSCL1/RXD11/SMISO11/SSCL11/IRQ6	CND-20	WP_3
21	TCK/FINEC/PD4/GTIOC1B/GTETRGB/TMCI0/TMCI6/SCK1 /SCK11/IRQ2	CND-19	UN_3
22	TDO/PD3/GTIOC2A/GTETRGC/TMO0/TXD1/SMOSI1 /SSDA1/TXD11/SMOSI11/SSDA11	CND-18	VN_3
23	TRCLK/PD2/A7/GTIOC2B/GTIOC0A/TMCI1/TMO4/SCK5 /SCK8/MOSIA	CND-17	WN_3
24	TRDATA3/PD1/A6/GTIOC3A/GTIOC0B/TMO2/RXD8 /SMISO8/SSCL8/MISOA	CNC-35	VRL_2
25	TRDATA2/PD0/A5/GTIOC3B/GTIOC1A/TMO6/TXD8 /SMOSI8/SSDA8/RSPCKA	CND-35	VRL_3
26	TRDATA1/PB7/A4/GTIOC1B/SCK5/SCK11/SCK12	CNA-2	LED2#_1
27	TRDATA0/PB6/A3/GTIOC2A/RXD5/SMISO5/SSCL5/RXD11 /SMISO11/SSCL11/RXD12/SMISO12/SSCL12/RXDX12 /CRX0/IRQ2	CN2-3	SCI5 communication (Combined with CAN communication)

Table 6.2 List of RX66T Pin Functions(2/3)

28	TRSYNC/PB5/A2/GTIOC2B/TXD5/SMOSI5/SSDA5/TXD11 /SMOSI11/SSDA11/TXD12/SMOSI12/SSDA12/TXD12 /SIOX12/CTX0	CN2-2	SCI5 communication (Combined with CAN communication)
29	VCC	VCC	VCC
30	PB4/A1/GTETRGA/GTETRGB/GTETRGC/GTETRGD /POE8#/CTS5#/RTS5#/SS5#/SCK11/CTS11#/RTS11# /SS11#/IRQ3_DS	CND-16	FO#_3
31	VSS	VSS	VSS
32	PB3/MTIOC0A/CACREF/SCK6/RSPCKA/IRQ9	CNA-3	LED3#_1
33	PB2/MTIOC0B/GTADSM0/TMRI0/TXD6/SMOSI6/SSDA6 /SDA/ADSM0	CNC-13	LED1#_2
34	PB1/MTIOC0C/GTADSM1/TMCI0/RXD6/SMISO6/SSCL6 /SCL/IRQ4/ADSM1	CN6-3	SCI6 communication
35	PB0/A0/BC0#/MTIOC0D/TMO0/TXD6/SMOSI6/SSDA6 /CTS11#/RTS11#/SS11#/MOSIA/IRQ8/ADTRG2#	CN6-2	SCI6 communication
36	PA5/MTIOC1A/TMCI3/RXD6/SMISO6/SSCL6/RXD8 /SMISO8/SSCL8/MISOA/IRQ1/ADTRG1#	CN3-5	ENC_Z_1
37	PA4/MTIOC1B/TMCI7/SCK6/TXD8/SMOSI8/SSDA8 /RSPCKA/ADTRG0#	CNC-15	LED3#_2
38	PA3/MTIOC2A/GTADSM0/TMRI7/TXD9/SMOSI9/SSDA9 /SCK8/SSLA0	CNC-29	ENC_Z_2
39	PA2/A0/BC0#/MTIOC2B/GTADSM1/TMO7/CTS6#/RTS6# /SS6#/RXD9/SMISO9/SSCL9/SSLA1	CND-14	LED2#_3
40	PA1/MTIOC6A/TMO4/TXD9/SMOSI9/SSDA9/RXD11 /SMISO11/SSCL11/SSLA2/CRX0/IRQ14_DS/ADTRG0#	CND-15	LED3#_3
41	PA0/MTIOC6C/TMO2/SCK9/TXD11/SMOSI11/SSDA11 /SSLA3/CTX0	CND-13	LED1#_3
42	VCC	VCC	VCC
43	P96/CS0#/WAIT#/GTETRGA/GTETRGB/GTETRGC /GTETRGD/POE4#/CTS8#/RTS8#/SS8#/IRQ4_DS	CNC-16	FO#_2
44	VSS	VSS	VSS
45	P95/MTIOC6B/GTIOC4A/GTIOC7A	CNC-22	UP_2
46	P94/MTIOC7A/GTIOC5A/GTIOC8A	CNC-21	VP_2
47	P93/MTIOC7B/GTIOC6A/GTIOC9A	CNC-20	WP_2
48	P92/MTIOC6D/GTIOC4B/GTIOC7B	CNC-19	UN_2
49	P91/MTIOC7C/GTIOC5B/GTIOC8B	CNC-18	VN_2
50	P90/MTIOC7D/GTIOC6B/GTIOC9B	CNC-17	WN_2
51	P76/D0/MTIOC4D/GTIOC2B/GTIOC6B	CNA-7	WN_1
52	P75/D1/MTIOC4C/GTIOC1B/GTIOC5B	CNA-8	VN_1
53	P74/D2/MTIOC3D/GTIOC0B/GTIOC4B	CNA-9	UN_1
54	P73/D3/MTIOC4B/GTIOC2A/GTIOC6A	CNA-10	WP_1
55	P72/D4/MTIOC4A/GTIOC1A/GTIOC5A/	CNA-11	VP_1
56	P71/D5/MTIOC3B/GTIOC0A/GTIOC4A/	CNA-12	UP_1
57	P70/D6/GTETRGA/GTETRGB/GTETRGC/GTETRGD /POE0#/CTS9#/RTS9#/SS9#/IRQ5_DS	CNA-5	FO#_1
58	P33/D7/MTIOC3A/MTCLKA/GTIOC3B/TMO0/SSLA3 /IRQ13_DS	CN3-3	ENC_A_1
59	P32/D8/MTIOC3C/MTCLKB/GTIOC3A/TMO6/SSLA2 /IRQ12_DS	CN3-4	ENC_B_1
60	VCC	VCC	VCC
61	P31/D9/MTIOC0A/MTCLKC/TMRI6/SSLA1/IRQ6	CNC-27	ENC_A_2
62	VSS	VSS	VSS

Table 6.3 List of RX66T Pin Functions(3/3)

63	P30/D10/MTIOC0B/MTCLKD/TMCI6/SCK8/CTS8#/RTS8# /SS8#/SSLA0/IRQ7/COMP3	CNC-28	ENC_B_2
64	P27/MTIOC1A/MTIOC0C//POE9#/IRQ15	CN1-10	N.C
65	P24/D11/MTIC5U/TMCI2/TMO6/CTS8#/RTS8#/SS8#/ SCK8/RSPCKA/IRQ4/COMP0	CNA-4	VRL_1
66	P23/D12/MTIC5V/TMO2/CACREF/TXD8/SMOSI8/SSDA8 /TXD12/SMOSI12/SSDA12/TXDX12/SIOX12/MOSIA/CTX0 /IRQ11/COMP1	CN1-8	N.C
67	P22/D13/MTIC5W/MTCLKD/MTIOC9B/TMRI2/TMO4/RXD8 /SMISO8/SSCL8/RXD12/SMISO12/SSCL12/RXDX12 /MISOA/CRX0/IRQ10/ADTRG2#/COMP2	CND-24	SW2#_3
68	P21/D14/MTIOC9A/MTCLKA/TMCI4/TXD8/SMOSI8/SSDA8 /TXD12/SMOSI12/SSDA12/TXDX12/SIOX12/MOSIA /IRQ6_DS/AN217/ADTRG1#/COMP5	CNB-15	VR_1
69	P20/D15/MTIOC9C/MTCLKB/TMRI4/CTS8#/RTS8#/SS8# /SCK8/RSPCKA/IRQ7_DS/AN216/ADTRG0#/COMP4	CN1-7	N.C
70	P65/A12/IRQ9/AN211/CMPC53/DA1	CND-5	IW_3
71	P64/A13/IRQ8/AN210/CMPC33/DA0	CND-2	VPN_3
72	AVCC2	AVCC	AVCC
73	AVSS2	AVCC	AVCC
74	P63/A14/IRQ7/AN209/CMPC23	CNC-2	VPN_2
75	P62/A15/IRQ6/AN208/CMPC43	CNB-8	VPN_1
76	P61/A16/IRQ5/AN207/CMPC13	CNC-9	VW_2
77	P60/A17/IRQ4/AN206/CMPC03	CNC-8	VV_2
78	P55/A18/IRQ3/AN203/CMPC32	CNC-7	VU_2
79	P54/A19/IRQ2/AN202/CMPC22	CNB-12	VW_1
80	P53/A20/IRQ1/AN201/CMPC12	CNB-11	VV_1
81	P52/IRQ0/AN200/CMPC02	CNB-10	VU_1
82	P47/AN103	CND-4	IV_3
83	P46/AN102/CMPC50/CMPC51	CNC-5	IW_2
84	P45/AN101/CMPC40/CMPC41	CNC-4	IV_2
85	P44/AN100/CMPC30/CMPC31	CNC-3	IU_2
86	PH4/AN107/PGAVSS1	CNC-1	PGAVSS_2
87	P43/AN003	CND-3	IU_3
88	P42/AN002/CMPC20/CMPC21	CNB-7	IW_1
89	P41/AN001/CMPC10/CMPC11	CNB-6	IV_1
90	P40/AN000/CMPC00/CMPC01	CNB-5	IU_1
91	PH0/AN007/PGAVSS0	CNB-4	PGAVSS_1
92	AVCC1	AVCC	AVCC
93	AVCC0	AVCC	AVCC
94	AVSS0	AVSS	AVSS
95	AVSS1	AVSS	AVSS
96	P82/ALE/WAIT#/MTIC5U/TMO4/SCK6/SCK12/IRQ3/COMP5	CND-23	SW1#_3
97	P81/CS2#/MTIC5V/TMCI4/TXD6/SMOSI6/SSDA6/TXD12 /SMOSI12/SSDA12/TXDX12/SIOX12/COMP4	CNA-14	SW2#_1
98	P80/CS1#/MTIC5W/TMRI4/RXD6/SMISO6/SSCL6/RXD12 /SMISO12/SSCL12/RXDX12/IRQ5/COMP3	CNA-13	SW1#_1
99	P11/RD#/MTIOC3A/MTCLKC/MTIOC9D/GTIOC3B /GTETRGA/GTETRGC/TMO3/POE9#/IRQ1_DS	CNC-24	SW2#_2
100	P10/MTIOC9B/MTCLKD/GTETRGB/GTETRGD/TMRI3 /POE12#	CNC-23	SW1#_2

7. Caution Items

The product includes some unused pins that have not been processed. For information on accurate pin processing, refer to the hardware manual of the microcontroller.

Website and Support

Renesas Electronics Website

<http://www.renesas.com/>

Inquiries

<http://www.renesas.com/contact/>

All trademarks and registered trademarks are the property of their respective owners.

Revision History

Rev.	Date	Description	
		Page	Summary
1.00	Oct. 30, 2018	-	First edition issued
1.10	Feb. 21, 2019	22	Correct Table 7.1
1.20	Feb. 21, 2022		Revised the description for the compatible inverter board Revised Section 4 (Usage)