

RX23T CPU Card User's Manual

R20UT3698EJ0140
Rev.1.40
2022.2.21

For Your Safety



Do not fail to read this manual before using the RX23T CPU card (RTK0EM0003C01202BJ) (the product).

- Follow the indications in this manual when using the product.
- This product is a board with the same specifications as the board included in the “24V Motor Control Evaluation System for RX23T (RTK0EM0006S01212BJ)”, and is an optional board for the “Evaluation System for BLDC Motor (RTK0EMX270S00020BJ)”.
- Keep this manual near the product so you can refer to it whenever necessary.
- Transfer or sale of the product to third parties is prohibited without written approval.
- The product does not meet the legal requirements for general product safety (including EMC requirements) for equipment as stipulated by various countries and regions. The purchaser or importer of the product is responsible for ensuring compliance with local regulations. In addition, the customer is responsible for ensuring that the product is handled correctly and safely, in accordance with the laws of the customer's country (region).
- All information contained in this manual represents information on products at the time of publication of this manual. Please note that the product data, specification, sales offices, contents of website, address, etc., are subject to change by Renesas Electronics Corporation without notice due to product improvements or other reasons. Please confirm the latest information on Renesas Electronics website.
- The manual for the product, and specification (the documents) are the tool that was developed for the function and performance evaluation of Renesas Electronics semiconductor device (Renesas Electronics device) mounted on the product, and not guarantee the same quality, function and performance.
- By purchasing the product or downloading the documents from Renesas Electronics website, the support services provided from Renesas Electronics is not guaranteed.

Meaning of Notations

In this manual items related to the safe use of the product are indicated as described below.

The degree of injury to persons or damage to property that could result if the designated content in this manual is not followed is indicated as follows.

 Danger	Indicates content that, if not followed, could result in death or serious injury* ¹ to the user, and which is highly urgent.
 Warning	Indicates content that, if not followed, could result in death or serious injury to the user.
 Caution	Indicates content that, if not followed, could result in injury* ² to persons or physical damage.* ³

Note 1. Serious injury refers to conditions resulting in persistent after-effects and for which treatment would necessitate hospitalization or regular hospital visits, such as loss or impairment of eyesight, burns (high- or low-temperature), electric shock, bone fracture, or poisoning.

Note 2. Injury refers to conditions for which treatment would necessitate hospitalization or regular hospital visits.

Note 3. Physical damage refers to damage affecting the wider surroundings, such as the user's home or property.

Requirements related to the handling of the product are classified into the following categories.



- Marks indicating that an action is prohibited.

	<p>General Prohibition The indicated action is prohibited.</p>		<p>Example: Do Not Touch! Touching the specified location could result in injury.</p>
---	---	---	---

- Marks indicating that an action is prohibited.





	<p>General Caution Indicates a general need for caution that is not specified.</p>		<p>Example: Caution – Hot! Indicates the possibility of injury due to high temperature.</p>
---	---	---	---

- Marks directing that the specified action is required.







	<p>General Instruction The specified action is required.</p>		<p>Example: Turn Off (Disconnect) Power Supply! Instructs the user to turn off (disconnect) the power supply to the product.</p>
---	---	---	--

Warnings Regarding Use of the Product





■ Danger Items

 Danger	
  	<ul style="list-style-type: none"> The product should be used only by persons (users) having a thorough knowledge of electrical and mechanical components and systems, a full knowledge of the risks associated with handling them, and training in inverter motor control and handling motors, or equivalent skills. Users should be limited to persons who have carefully read the Caution Items contained in this manual. Unlike typical equipment, the product has no protective case to ensure safety, and it contains moving parts and high-temperature components that could be dangerous. Do not touch the evaluation board or cables while power is being supplied. Carefully check to make sure that there are no pieces of conductive materials or dust adhering to the board, connectors, and cables. There are moving parts, driven by a motor. Do not touch the motor while power is being supplied. Ensure that the motor is insulated and placed in a stable location before supplying power.
	<p>Do Not Connect Load to Motor!</p> <ul style="list-style-type: none"> This could cause fire, burns, or injury.

■ Warning Items

 Warning	
	<p>Caution – Rotating Parts!</p> <ul style="list-style-type: none"> The system includes a motor. Touching the rotating shaft could cause high-temperature burns or injury.
	<p>Always insert plugs, connectors, and cables securely, and confirm that they are fully inserted.</p> <ul style="list-style-type: none"> Incomplete connections could cause fire, burns, electric shock, or injury.
	<p>Use the power supply apparatus specified in the manual.</p> <ul style="list-style-type: none"> Failure to do so could cause fire, burns, electric shock, injury, or malfunction.
	<p>Disconnect the power supply and unplug all cables when the system will not be used for a period of time or when moving the system.</p> <ul style="list-style-type: none"> Failure to do so could cause fire, burns, electric shock, or malfunction. This will protect the system against damage due to lightning.
	<p>Use a mechanism (switch, outlet, etc.) located within reach to turn off (disconnect) the power supply.</p> <ul style="list-style-type: none"> In case of emergency, it may be necessary to cut off the power supply quickly.
	<p>Turn off the power supply immediately if you notice abnormal odor, smoke, abnormal sound, or overheating.</p> <ul style="list-style-type: none"> Continuing to use the system in an abnormal condition could cause fire, burns, or electric shock.
	<p>Do Not Disassemble, Modify, or Repair!</p> <ul style="list-style-type: none"> Doing so could cause fire, burns, electric shock, injury, or malfunction.
	<p>Do not use the product for any purpose other than initial evaluation of motor control in a testing room or lab. Do not integrate the product or any part of it into other equipment. Do not insert or remove cables or connectors when the product is powered on.</p> <ul style="list-style-type: none"> The product has no safety case. Failure to observe the above could cause fire, electric shock, burns, or malfunction. The product may not perform as expected if used for other than its intended purpose.

■ Caution Items

 Caution	
	<p>Caution – Hot!</p> <ul style="list-style-type: none"> The motor gets hot. Touching it could cause high-temperature burns.
	<p>Follow the procedure specified in the manual when powering the system on or off.</p> <ul style="list-style-type: none"> Failure to do so could cause overheating or malfunction.
	<p>Caution – Static Electricity</p> <ul style="list-style-type: none"> Use the antistatic band. Failure to do so could cause malfunction or unstable motion.

Overview

The RX23T CPU card (RTK0EM0003C01202BJ) is a board with the same specifications as the RX23T CPU card (RTK0EM0013C01201BJ) (RX23T-CRD) included in the 24V Motor Control Evaluation System for RX23T (RTK0EM0006S01212BJ), and is an optional board for Evaluation System for BLDC Motor (RTK0EMX270S00020BJ). An emulator, INV-BRD, and equipment must be provided by the customer.

This user's manual describes the proper handling of the product.

Target Device

RX23T microcontroller

Related Documents

- RX23T CPU Card Schematic : R12TU0007EJ
- RX23T CPU Card BOM List : R12TU0008EJ
- RX23T CPU Card PWB Pattern Drawing : R12TU0006EJ
- Evaluation System for BLDC Motor User's Manual : R12UZ0062
- 24V Motor Control Evaluation System for RX23T User's Manual : R20UT3697EJ

Package Contents

Refer to "RX23T CPU Card Information" included with this document.

Abbreviations

Abbreviations	Full Name	Remarks
INV-BRD	Inverter Board	Inverter board included in "Evaluation System for BLDC Motor" (Board P/N.: RTK0EM0000B10020BJ) or Inverter board included in "24V Motor Control Evaluation System for RX23T" (Board P/N.: RTK0EM0001B00012BJ)
E1	E1 emulator	on-chip debugging emulator and flash programmer Product No.: R0E000010KCE00
E2 Lite	E2 emulator Lite	on-chip debugging emulator and flash programmer Product No.: RTE0T0002LKCE00000R

Contents

1. Specifications	6
1.1 Specification.....	6
1.2 Regulatory Compliance Notices.....	7
1.2.1 European Union regulatory notices.....	7
2. Block Diagram	8
3. Layout	9
4. Usage	10
5. Functions	11
5.1 Power Supply.....	11
5.2 Connecting the Emulator	11
5.3 Connecting the Inverter Board	12
5.4 Connecting the SCI.....	13
5.5 Hall Sensor Signal Input.....	13
5.6 Encoder Signal Input	14
5.7 Extension of Unused Pins.....	15
5.8 Reset Circuit	15
5.9 Crystal Resonator	15
5.10 LEDs	16
6. Details of RX23T CPU Card	17
6.1 RX23T Features	17
6.2 RX23T Pin Assignments.....	18
6.3 List of RX23T Pin Functions	20
7. Caution Items	21
Revision History	23

1. Specifications

1.1 Specification

Table 1.1 Overview of RX23T CPU Card Specifications

Item	Specification
Product name	RX23T CPU card
Board product No.	RTK0EM0003C01202BJ
Supported inverter board / product No.	Supplied with 24V Motor Control Evaluation System for RX23T 24V Inverter Board / RTK0EM0001B00012BJ Inverter board supplied with Evaluation System for BLDC Motor /RTK0EM0000B10020BJ

Exterior view

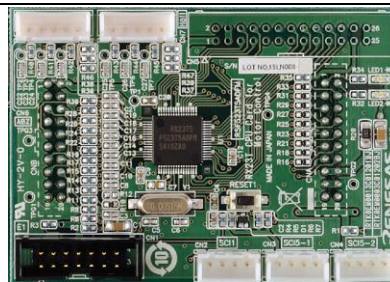

Note: Appearance of actual product may differ from photo.

MCU	Product group	RX23T group
	Product No.	R5F523T5ADFM
	CPU max. operating frequency	40 MHz
	Bit count	32 bits
	Package / Pin count	LFQFP / 64 pins
	ROM	128 KB
	RAM	12 KB
MCU input clock		Crystal resonator 10 MHz
Input power supply voltage		DC 5 V*1 Selectable among the following: <ul style="list-style-type: none"> • Power supply from supported inverter board • Power supply from supported emulator *2
Supported sensors		Hall sensor, encoder (through holes provided for signal monitoring test pins)
Supported emulator		E1, E2 Lite
Connectors		<ul style="list-style-type: none"> • Inverter board connectors × 2 • SCI connectors × 3 • E1 connector • Hall sensor signal input connector • Encoder signal input connector
Switch		MCU external reset switch
LEDs		User control LEDs × 2
Operating temperature		Room temperature
Operating humidity		No condensation

Note 1. Supply voltage is DC 3.3V from E2 Lite.

Note 2. Power supply from the supported emulator is only supported for standalone operation. Power supply from the supported emulator is not supported when the INV-BRD is connected.

1.2 Regulatory Compliance Notices

1.2.1 European Union regulatory notices

This product complies with the following EU Directives. (These directives are only valid in the European Union.)

CE Certifications:

- Electromagnetic Compatibility (EMC) Directive 2014/30/EU
EN61326-1 : 2013 Class A

WARNING: This is a Class A product. This equipment can cause radio frequency noise when used in the residential area. In such cases, the user/operator of the equipment may be required to take appropriate countermeasures under his responsibility.

- Information for traceability
 - Authorised representative
Name: Renesas Electronics Corporation
Address: Toyosu Foresia, 3-2-24, Toyosu, Koto-ku, Tokyo 135-0061, Japan
 - Manufacturer
Name: Renesas Electronics Corporation
Address: Toyosu Foresia, 3-2-24, Toyosu, Koto-ku, Tokyo 135-0061, Japan
 - Person responsible for placing on the market
Name: Renesas Electronics Europe GmbH
Address: Arcadiastrasse 10, 40472 Dusseldorf, Germany
 - Trademark and Type name
Trademark: Renesas
Product name: RX24T CPU Card for Motor Control
Type name: RTK0EM0009C03402BJ

Environmental Compliance and Certifications:

- Waste Electrical and Electronic Equipment (WEEE) Directive 2012/19/EU

2. Block Diagram

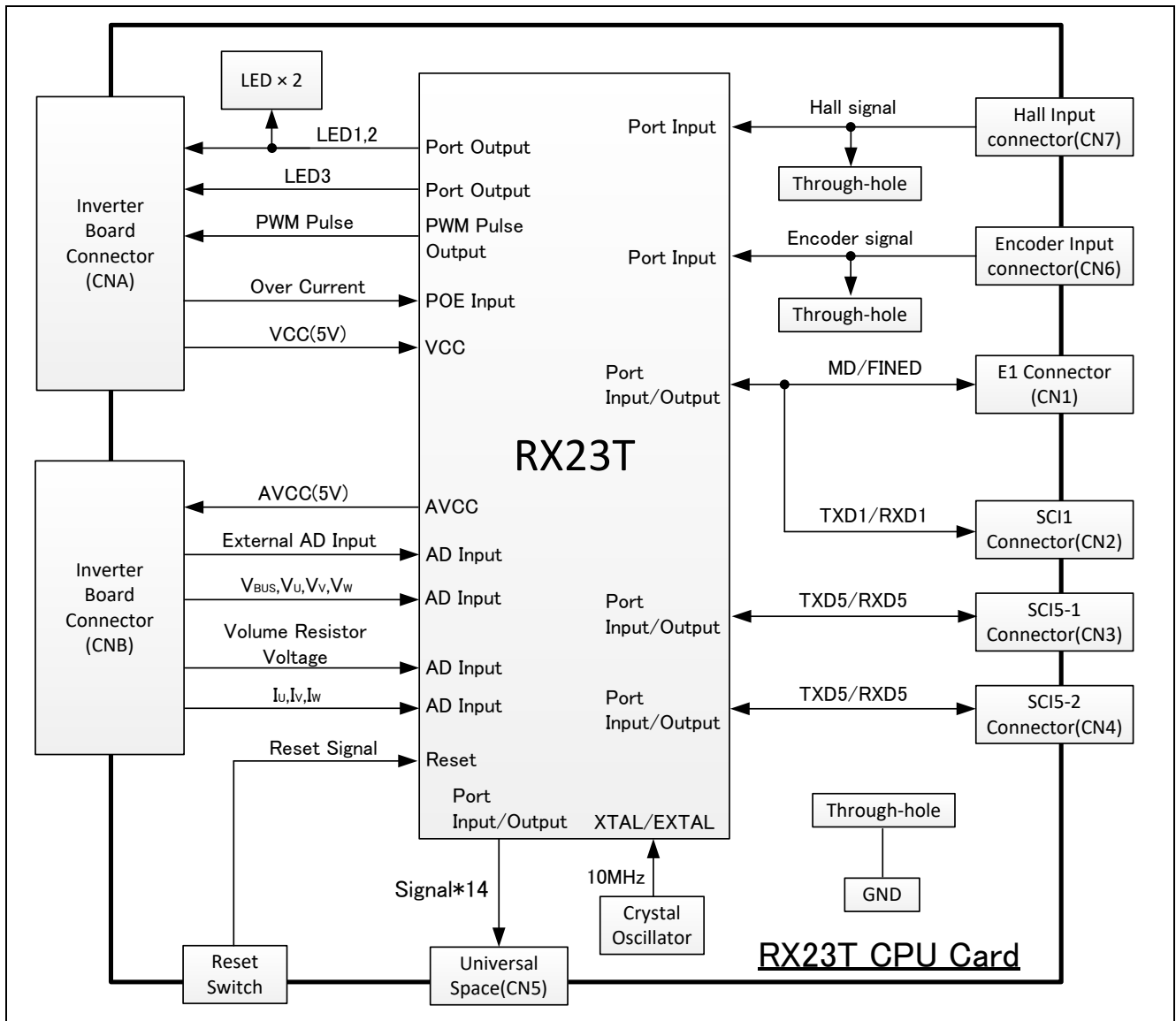

Figure 2.1 RX23T CPU Card Block Diagram

3. Layout

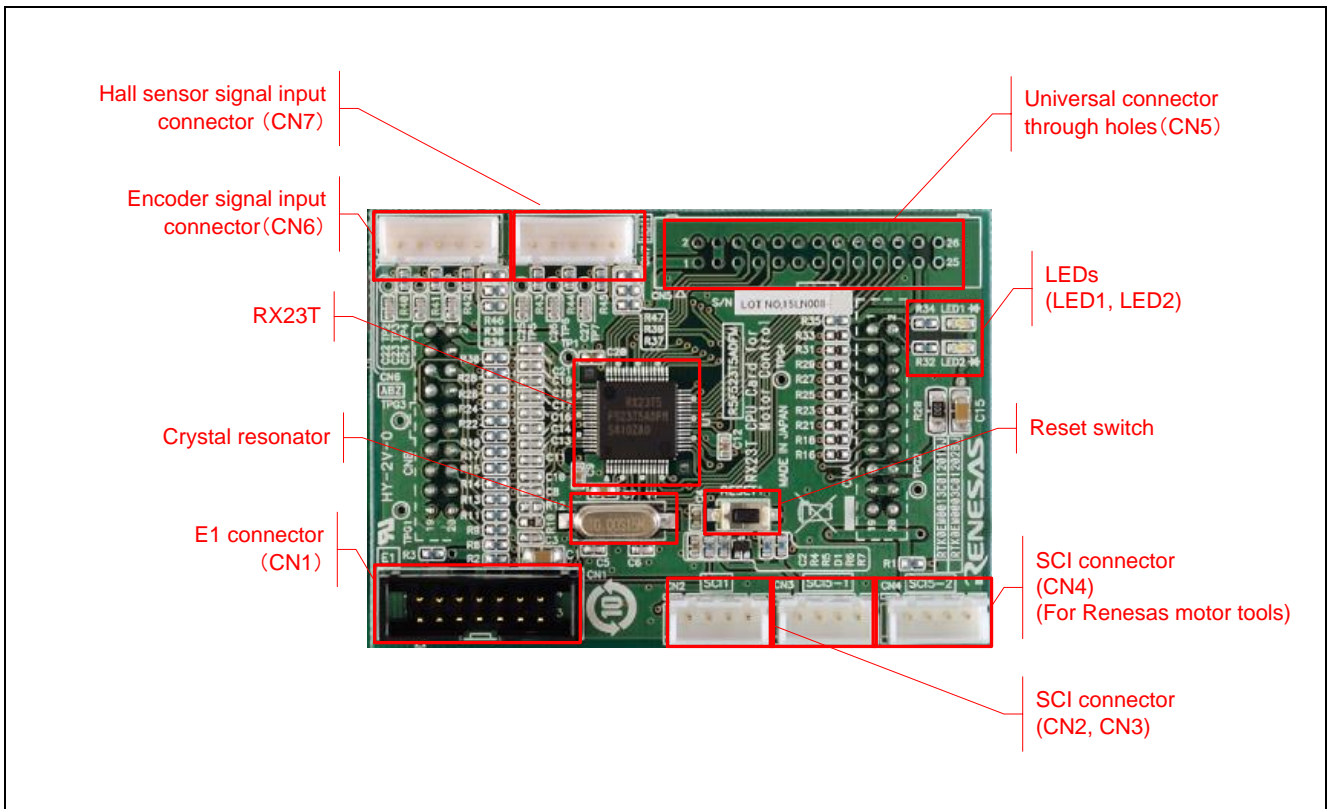

Figure 3.1 RX23T CPU Card Layout (Top View)

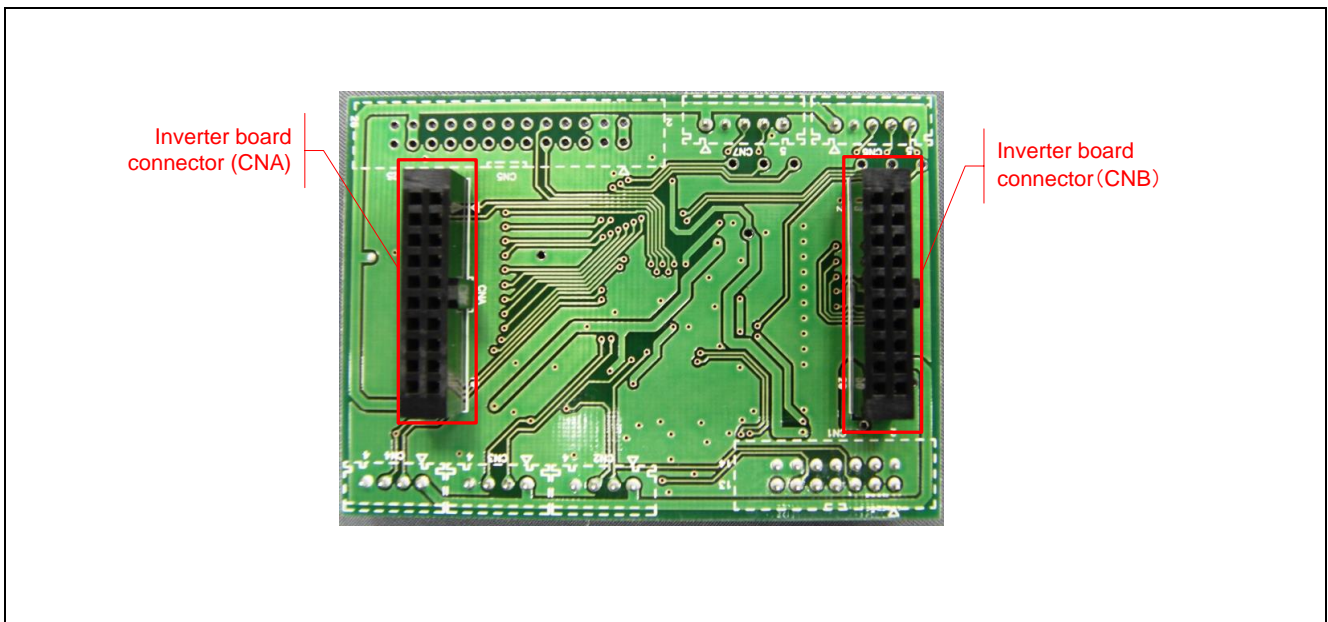

Figure 3.2 RX23T CPU Card Layout (Bottom View)

4. Usage

Before connecting to the INV-BRD, be sure to write the software corresponding to the INV-BRD to this product. The board may be damaged if it is connected to the INV-BRD with the factory default software or with software that is not compatible with the INV-BRD.

For details on writing software, please refer to 5.2. For the operation of the written software, refer to the application note of each software.

Please refer to the user's manual of each INV-BRD for the connection method with INV-BRD.

5. Functions

5.1 Power Supply

The product does not have a dedicated power supply connector. When connected to the INV-BRD it draws power via the connector. When not connected to the INV-BRD, it can draw power via the E1 connector. The product is not allowed to draw power via the E1 connector when it is connected to the INV-BRD.

5.2 Connecting the Emulator

The E1/E2 Lite on-chip debugging emulator from Renesas Electronics is used to write software (program) to the flash memory of the RX23T. Software will be downloaded into the product via E1 or E2 Lite. It is also necessary to make the settings shown in Table 5.1 in the integrated development environment or in the Renesas flash programmer to enable the emulator to supply power to the product. Table 5.2 lists the pin assignments of the E1 connector.

Table 5.1 E1, E2 Lite Power Supply Settings

Connection to INV-BRD	Power Supply Setting
Connected	Power supply not allowed*1
Not connected	5 V or 3.3V power supply

Note 1. When connected to the INV-BRD, the product must draw power from the INV-BRD.

Table 5.2 Pin Assignments of E1 Connector (CN1)

Pin No.	Pin Function	RX23T Connection Pins	Pin No.	Pin Function	RX23T Connection Pins
1	NC	—	2	GND	VSS
3	NC	—	4	NC	—
5	TXD	PD3/TXD1	6	NC	—
7	MD/FINED	MD/FINED	8	VCC	VCC
9	NC	—	10	NC	—
11	RXD	PD5/RXD1	12	GND	VSS
13	RESET	RES#	14	GND	VSS

Note: See a supplement to the E1/E20/E2 emulator, E2 emulator Lite user's manual.

5.3 Connecting the Inverter Board

The product connects to the INV-BRD supplied with the Motor RSSK via the inverter board connectors (CNA and CNB). Table 5.3 and Table 5.4 list the pin assignments of the inverter board connectors.

Table 5.3 Pin Assignments of Inverter Board Connector (CNA)

Pin No.	Pin Function	RX23T Connection Pins	Pin No.	Pin Function	RX23T Connection Pins
1	LED1#	P00	2	LED2#	P01
3	LED3#	P31	4	NC	PB4
5	FO#	P70/POE0#	6	NC	—
7	WN	P76/MTIOC4D	8	VN	P75/MTIOC4C
9	UN	P74/MTIOC3D	10	WP	P73/MTIOC4B
11	VP	P72/MTIOC4A	12	UP	P71/MTIOC3B
13	SW1#	P91	14	SW2#	P92
15	5V	VCC	16	5V	VCC
17	GND	VSS	18	GND	VSS
19	3.3V	—	20	3.3V	—

Table 5.4 Pin Assignments of Inverter Board Connector (CNB)

Pin No.	Pin Function	RX23T Connection Pins	Pin No.	Pin Function	RX23T Connection Pins
1	AVCC	AVCC	2	AVCC	AVCC
3	NC	—	4	NC	—
5	IU	P40/AN000	6	IV	P41/AN001
7	IW	P42/AN002	8	VPN	P43/AN003
9	TEMP	P47/AN007	10	VU	P44/AN004
11	VV	P45/AN005	12	VW	P46/AN006
13	VAC	P11/AN016	14	IPFC	P10/AN017*1
15	VR	P10/AN017*1	16	NV	—
17	VCCIO	VCC	18	VCCIO	VCC
19	GND	VSS	20	GND	VSS

Note 1. P10/AN017: Selectable between IPFC and VR1 (default: VR1).

5.4 Connecting the SCI

The product communicates with the SCI via the SCI connectors. There are three SCI connectors: CN2, CN3, and CN4. Table 5.5 lists their pin assignments. Use CN4 when using tools such as waveform display in combination with INV-BRD.

Table 5.5 Pin Assignments of SCI Connectors (CN2, CN3, CN4)

Connector No.	Pin No.	Pin Function	RX23T Connection Pins
CN2 SCI1*1	1	5V	VCC
	2	RX23T transmit side	PD3/TXD1
	3	RX23T receive side	PD5/RXD1
	4	GND	VSS
CN3 SCI5-1	1	5V	VCC
	2	RX23T transmit side	PB5/TXD5
	3	RX23T receive side	PB6/RXD5
	4	GND	VSS
CN4 SCI5-2	1	5V	VCC
	2	RX23T transmit side	PB2/TXD5
	3	RX23T receive side	PB1/RXD5
	4	GND	VSS

Note 1. The SCI1 TXD and RXD pins are also used by E1/E2 Lite, so it is not possible to use SCI1 when the product is connected to the E1/E2 Lite.

5.5 Hall Sensor Signal Input

The product is equipped with a Hall sensor signal input connector. The signal input to the product is pulled up to 5 V and passed through an RC filter before being input to the RX23T. Table 5.6 lists the pin assignments of the Hall sensor signal input connector, and Table 5.7 lists connector information.

Table 5.6 Pin Assignments of Hall Sensor Signal Input Connector (CN7)

Pin No.	Pin Function	RX23T Connection Pins
1	5V	VCC
2	GND	VSS
3	HU	P93/IRQ0
4	HV	P94/IRQ1
5	HW	PA2/IRQ4

Table 5.7 Hall Sensor Signal Input Connector Information

Part	Product No.	Manufacturer
Connector (CN7)	XHP-5	J.S.T. Mfg. Co. Ltd. (JST)

5.6 Encoder Signal Input

The product is equipped with an encoder signal input connector. This makes it possible to input the encoder signal to the RX23T. The signal input to the product is pulled up to 5 V and passed through an RC filter before being input to the RX23T. Table 5.8 lists the pin assignments of the signal input connector, and Table 5.9 lists connector information.

Table 5.8 Pin Assignments of Encoder Signal Input Connector (CN6)

Pin No.	Pin Function	RX23T Connection Pins
1	5V	VCC
2	GND	VSS
3	A-phase	P33/MTCLKA
4	B-phase	P32/MTCLKB
5	Z-phase	PA5

Table 5.9 Encoder Signal Input Connector Information

Part	Product No.	Manufacturer
Connector (CN6)	XHP-5	J.S.T. Mfg. Co. Ltd. (JST)

5.7 Extension of Unused Pins

To facilitate general use of the product, the unused pins of the RX23T are extended through universal connector through holes in the board. Table 5.10 lists the pin assignments of the universal connector through holes.

Table 5.10 Pin Assignments of Universal Connector Through Holes

Pin No.	RX23T Connection Pins	Pin No.	RX23T Connection Pins
1	AVCC	2	AVCC
3	GND	4	GND
5	P22	6	P23
7	P24	8	P30
9	PA4	10	P02
11	NC	12	NC
13	NC	14	PA3
15	PB0	16	PB3
17	PB7	18	PD4
19	PD6	20	PD7
21	PE2	22	NC
23	UVCC	24	UVCC
25	VSS	26	VSS

5.8 Reset Circuit

The product is equipped with a reset circuit for resetting the microcontroller at power-on reset and external reset. To apply an external reset to the microcontroller, press the pushbutton (RESET1).

5.9 Crystal Resonator

The microcontroller mounted on the product is connected to a 10 MHz crystal resonator.

5.10 LEDs

Two LEDs are mounted on the product for use in debugging programs and general system applications. Each turns on when the output on the corresponding port is low-level and turns off when the output is high-level. Table 5.11 lists the pin assignments corresponding to the LEDs.

Table 5.11 RX23T CPU Card LED Connection Pin Assignments

Corresponding RX23T Port		LED1	LED2
P00	High-level output	Off	—
	Low-level output	On	—
P01	High-level output	—	Off
	Low-level output	—	On

6. Details of RX23T CPU Card

6.1 RX23T Features

1. 32-bit microcontroller with RXv2 CPU core for motor control
2. On-chip 32-bit single-precision floating point unit (FPU)
3. Ability to output three-phase complementary PWM waveforms
4. Ability to set timer interrupt as A/D trigger
5. Three 12-bit A/D converter units with a total of 10 channels
6. Channel-dedicated sample and hold function
7. On-chip comparator
8. Timer output stop (Hi-Z) function
9. On-chip independent watchdog timer

6.2 RX23T Pin Assignments

48	1	P02/CTS1#/RTS1#/SS1#/ADST0/IRQ5	32	P91/SSLA3
47	2	P00/IRQ2	31	P92/TMC11/SSLA2
46	3	VCL	30	P93/MTIOC0B/TMRI1/SCK5/RSPCKA/IRQ0
45	4	P01/CACREF/IRQ4	29	P94/MTIOC0C/TMO1/MISOA/IRQ1
44	5	MD/FINED	28	PA2/MTIOC2B/CTS5#/RTS5#/SS5#/SSLA1/IRQ4
43	6	RES#	27	PA3/MTIOC2A/SSLA0
42	7	XTAL/P37	26	PB0/MTIOC0D/MOSIA
41	8	VSS	25	PB1/MTIOC0C/RXD5/SMISO5/SSCL5/SCL0/IRQ2
40	9	EXTAL/P36	24	PB2/MTIOC0B/ADSM0/TXD5/SMOSI5/SSDA5/SDA0
39	10	VCC	23	PB3/MTIOC0A/CACREF/SCK5/RSPCKA
38	11	PE2/POE10#/NMI	22	VSS
37	12	PD7/TMRI1/SSLA1	21	PB4/POE8#/IRQ3
36	13	PD6/TMO1/SSLA0/CTS1#/RTS1#/SS1#/ADST0/IRQ5	20	VCC
35	14	PD5/TMRI0/RXD1/SMISO1/SSCL1/IRQ3	19	PB5/TXD5/SMOSI5/SSDA5
34	15	PD4/TMC10/SCK1/IRQ2	18	PB6/RXD5/SMISO5/SSCL5/IRQ5
33	16	PD3/TMO0/TXD1/SMOSI1/SSDA1	17	PB7/SCK5

Figure 6.1 RX23T Pin Assignments (1/2)

6.3 List of RX23T Pin Functions

Table 6.1 List of RX23T Pin Functions

Pin No.	RX23T Pin Functions	CPU Card Connection	INV-BRD Connection
1	P02/CTS1#/RTS1#/SS1#/ADST0/IRQ5	CN5-10pin	Not connected
2	P00/IRQ2	CNA-1pin	LED1 cathode
3	VCL	Capacitor connection	Not connected
4	P01/CACREF/IRQ4	CAN-2pin	LED2 cathode
5	MD/FINED	CN1-7pin	Not connected
6	RES#	reset	Not connected
7	XTAL/P37	Crystal resonator (10MHz)	Not connected
8	VSS	GND	GND
9	EXTAL/P36	Crystal resonator (10MHz)	Not connected
10	VCC	VCC	VCC
11	PE2/POE10#/NMI	Pull-up/ CN5-21pin	Not connected
12	PD7/TMRI1/SSLA1	CN5-20pin	Not connected
13	PD6/TMO1/SSLA0/CTS1#/RTS1#/SS1#/ADST0/IRQ5	CN5-19pin	Not connected
14	PD5/TMRI0/RXD1/SMISO1/SSCL1/IRQ3	CN2-3pin/ CN1-11pin	Not connected
15	PD4/TMCI0/SCK1/IRQ2	CN5-18pin	Not connected
16	PD3/TMO0/TXD1/SMOSI1/SSDA1	CN1-5pin/ CN2-2pin	Not connected
17	PB7/SCK5	CN5-17pin	Not connected
18	PB6/RXD5/SMISO5/SSCL5/IRQ5	CN3-3pin	Not connected
19	PB5/TXD5/SMOSI5/SSDA5	CN3-2pin	Not connected
20	VCC	VCC	VCC
21	PB4/POE8#/IRQ3	CNA-4pin	Not connected
22	VSS	VSS	VSS
23	PB3/MTIOC0A/CACREF/SCK5/RSPCKA	CN5-16pin	Not connected
24	PB2/MTIOC0B/ADSM0/TXD5/SMOSI5/SSDA5/SDA0	CN4-2pin	Not connected
25	PB1/MTIOC0C/RXD5/SMISO5/SSCL5/SCL0/IRQ2	CN4-3pin	Not connected
26	PB0/MTIOC0D/MOSIA	CN5-15pin	Not connected
27	PA3/MTIOC2A/SSLA0	CN5-14pin	Not connected
28	PA2/MTIOC2B/CTS5#/RTS5#/SS5#/SSLA1/IRQ4	CN7-5pin	Not connected
29	P94/MTIOC0C/TMO1/MISOA/IRQ1	CN7-4pin	Not connected
30	P93/MTIOC0B/TMRI1/SCK5/RSPCKA/IRQ0	CN7-3pin	Not connected
31	P92/TMCI1/SSLA2	CNA-14pin	Toggle switch (SW2)
32	P91/SSLA3	CNA-13pin	Toggle switch (SW1)
33	P76/MTIOC4D	CNA-7pin	W-phase PWM output
34	P75/MTIOC4C	CNA-8pin	V-phase PWM output
35	P74/MTIOC3D	CNA-9pin	U-phase PWM output
36	P73/MTIOC4B	CNA-10pin	W+phase PWM output

Pin No.	RX23T Pin Functions	CPU Card Connection	INV-BRD Connection
37	P72/MTIOC4A	CNA-11pin	V+phase PWM output
38	P71/MTIOC3B	CNA-12pin	U+phase PWM output
39	P70/POE0#/IRQ5	CNA-5pin	Overcurrent detection
40	P33/MTIOC3A/MTCLKA/SSLA3	CN6-3pin	Not connected
41	P32/MTIOC3C/MTCLKB/SSLA2	CN6-4pin	Not connected
42	VCC	VCC	VCC
43	P31/MTIOC0A/MTCLKC/SSLA1	CNA-3pin	LED3 cathode
44	VSS	GND	GND
45	P30/MTIOC0B/MTCLKD/SSLA0	CN5-8pin	Not connected
46	P24/MTIC5U/TMCI2/RSPCKA/COMP0/IRQ3	CN5-7pin	Not connected
47	P23/MTIC5V/CACREF/TMO2/MOSIA/COMP1/IRQ4	CN5-6pin	Not connected
48	P22/MTIC5W/TMRI2/MISOA/COMP2/IRQ2	CN5-5pin	Not connected
49	P47/AN007/CMPC12/CMPC22	CNB-9pin	External A/D input
50	P46/AN006/CMPC02	CNB-12pin	W-phase voltage detection
51	P45/AN005/CMPC21	CNB-11pin	V-phase voltage detection
52	P44/AN004/CMPC11	CNB-10pin	U-phase voltage detection
53	P43/AN003/CMPC01	CNB-8pin	Bus line voltage detection
54	P42/AN002/CMPC20	CNB-7pin	W-phase current detection
55	P41/AN001/CMPC10	CNB-6pin	V-phase current detection
56	P40/AN000/CMPC00	CNB-5pin	U-phase current detection
57	AVCC0	AVCC	AVCC
58	VREFH0	AVCC	AVCC
59	VREFL0	GND	GND
60	AVSS0	GND	GND
61	P11/MTIOC3A/MTCLKC/TMO3/IRQ1/AN016/CVREFC0	CNB-13pin	Not connected
62	P10/MTCLKD/TMRI3/IRQ0/AN017/CVREFC1	CNB-15pin	VR/switch voltage detection
63	PA5/MTIOC1A/TMCI3/MISOA	CN6-5pin	Not connected
64	PA4/MTIOC1B/RSPCKA/ADTRG0#	CN5-9pin	Not connected

7. Caution Items

Caution items related to use of the product are as follows.

The product includes some unused pins that have not been processed. For information on accurate pin processing, refer to the hardware manual of the microcontroller.

Website and Support

Renesas Electronics Website

<http://www.renesas.com/>

Inquiries

<http://www.renesas.com/contact/>

All trademarks and registered trademarks are the property of their respective owners.

Revision History

Rev.	Date	Description	
		Page	Summary
1.00	Mar. 31, 2016	—	First edition issued
1.10	Apr. 5, 2017	3	Add the item about cautions (Static Electricity)
		8	Add the information about CE Certification
1.20	Sep. 19, 2018	14	Correct Table 6.4
1.30	Feb. 13, 2019	14	Correct Table 6.4
		15	Correct Table 6.5
		22	Correct Table 7.1
1.40	Feb. 21, 2022		Revised the description for the compatible inverter board Revised Section 4 (Usage)