

ISL95338EVAL1Z

User's Manual: Evaluation Board

Battery and Optical

1. Overview

The [ISL95338](#) is a bidirectional buck-boost voltage regulator, which provides bidirectional buck-boost voltage regulation and protection features. Intersil's advanced R3™ Technology is used to provide high light-load efficiency, fast transient response, and seamless DCM/CCM transitions.

The ISL95338 takes input power from a wide range of DC power sources (conventional AC/DC ADPs, USB PD ports, travel ADPs, etc.) and safely converts it to a regulated voltage up to 24V. The ISL95338 also can convert a wide range DC power source connected at its output (system side) to a regulated voltage to its input (ADP side). This bidirectional buck-boost regulation feature makes its application very flexible.

The ISL95338 includes various system operation functionalities such as Forward mode enable, Reverse mode enable, programmable soft-start time, and adjustable V_{OUT} in both forward direction and reverse direction. The protection functionalities include OCP, OVP, UVP, OTP, etc.

The ISL95338 has serial communication using SMBus/I²C that allows programming of many critical parameters to deliver a customized solution. These programming parameters include, but are not limited to: output current limit, input current limit, and output voltage setting.

1.1 Key Features

- Bidirectional buck, boost, and buck-boost operation
- Input voltage range 3.8V to 24V (no dead zone)
- Output voltage up to 20V
- Up to 1MHz switching frequency
- Programmable soft-start time
- LDO output for VDD and VDDP
- System status alert function
- Bidirectional internal discharge function
- Active switching for negative voltage transitions
- Bypass mode in both directions
- Forward mode enable, Reverse mode enable
- OCP, OVP, UVP, and OTP protection
- SMBus and auto-increment I²C compatible

1.2 Specifications

- V_{IN} = 3.8V to 24V (no dead zone)
- V_{OUT} = 2.4V to 20V
- f_{SW} = 1MHz maximum

1.3 Ordering Information

Part Number	Description
ISL95338EVAL1Z	ISL95338 buck-boost voltage regulator evaluation board

1.4 Related Literature

- For a full list of related documents, visit our website
 - [ISL95338](#) product page

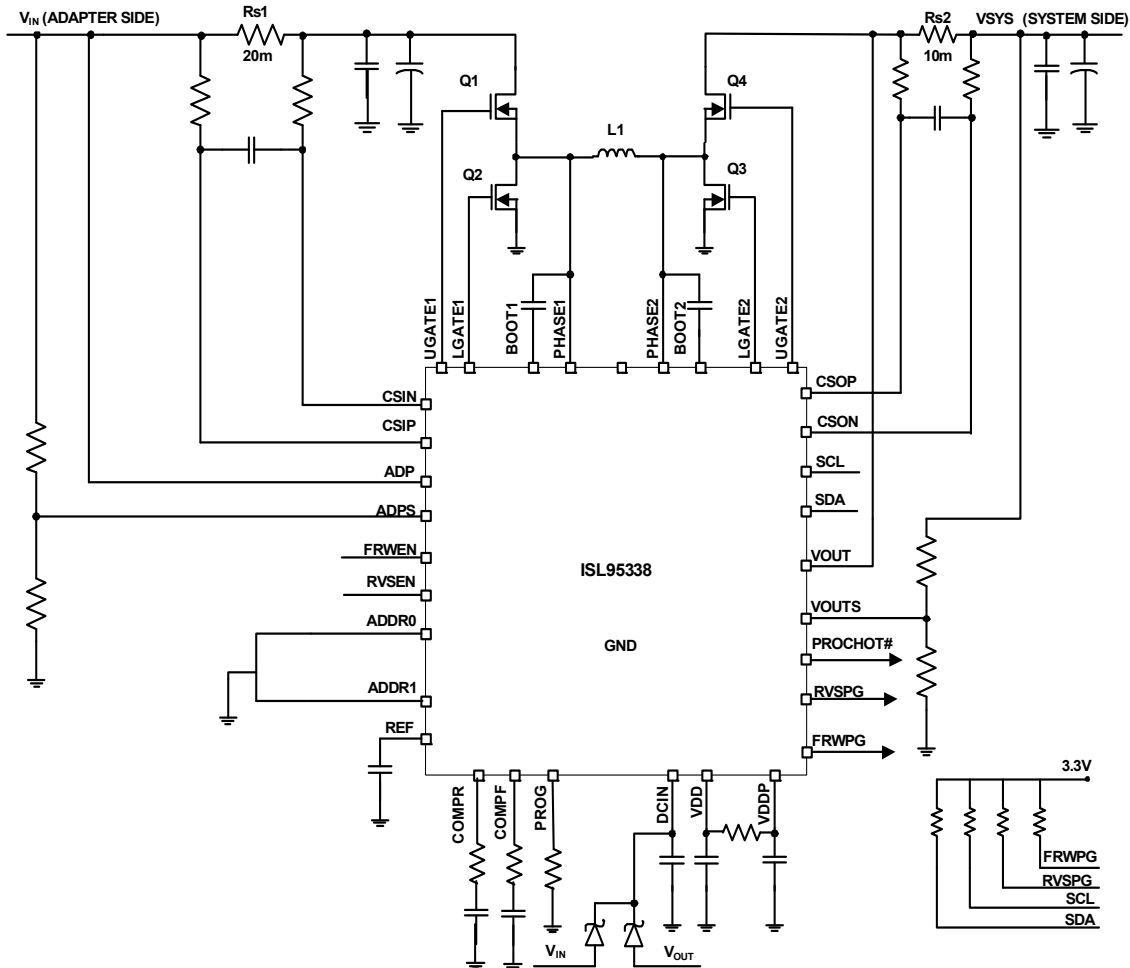

Figure 1. Block Diagram

1.5 Recommended Equipment

- 0V to 25V power supply with at least 6A source current capability
- Electronic load capable of sinking current up to 6A
- Digital Multimeters (DMMs)
- 100MHz quad-trace oscilloscope

2. Functional Description

The ISL95338EVAL1Z provides all circuits required to evaluate the features of the ISL95338. A majority of the features, such as adjustable output voltage in Forward mode and Reverse mode, programmable REF, fast VDAC changing at no load condition, at Buck, Boost and Buck-Boost modes, are available on this evaluation board.

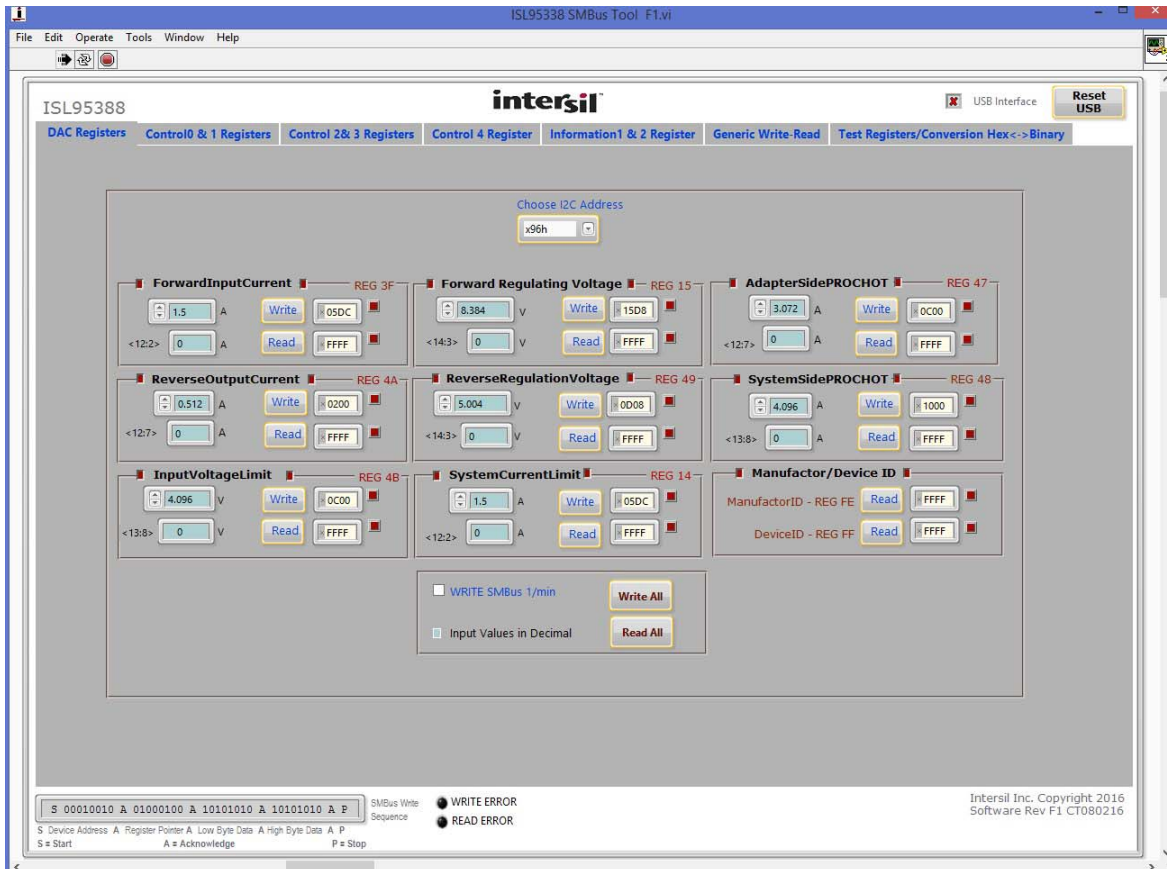

Figure 2. GUI Snapshot

2.1 Quick Start Guide

The ISL95338 can provide bidirectional output voltage up to 20V. The forward output voltage default values can be configured with a standard 1% 0603 resistor (R_{23}) from the PROG pin to GND. Table 21 in the [ISL95338](#) datasheet shows the programming options. After the default forward output voltage is set, this value can also be changed through the SMBus control register, ForwardRegulatingVoltage (0X15H). The reverse output voltage value can be set through the SMBus control register, ReverseRegulatingVoltage (0X49H). The protection values, including forward input current limit, reverse output current limit, input voltage limit, and system side current limit can be programmed through the SMBus control registers, 0X3FH, 0X4AH, 0X4BH, and 0X14H, respectively.

The ISL95338 also provides a programmable SMBus address to support multiple SMBus chips sharing common SMBus, through ADDR0 and ADDR1 pins. Details for programmable addresses are shown in Table 1 of the [ISL95338](#) datasheet.

Three LEDs indicate Forward Power-Good (FWRPG), Reverse Power-Good (RVSPG), and PROCHOT status for the ADP side and system side, respectively. Refer to [Figure 3](#) for the three LED positions. [Figure 3](#), which is the top view of the evaluation board, highlights the key testing points and connection terminals. Use the following steps to evaluate some key functions including Enable Forward mode and Enable Reverse mode. For other features, or more information about ISL95338, refer to [ISL95338](#) datasheet.

2.1.1 Enabling Forward Mode in Buck Mode

- (1) Set the 20V supply to 12V and, with SW1 in the low position, connect the (+) source to the ADP positive terminal and the (-) source to the ADP negative terminal.
- (2) Ensure that jumpers JP4, JP6, and JP7 are shorted. SW1 and SW2 should be in the low position.
- (3) Connect the USB cable to the USB port for SMBus. LED1, 2, and 3 light up.
- (4) Open the ISL95338 GUI. Ensure that SW3 and SW4 are in the low position, and that the ISL95338 address is 0x96H.
- (5) Turn on the power supply. LED2 and 3 go out. Note: A green check mark indicates that the GUI is ready to communicate with the evaluation board. A red X indicates that the GUI is not ready to communicate with the evaluation board. Click the USB reset button until the green check mark shows in the USB interface. If not, check the USB connection, VDD, and SMBus address settings.
- (6) Input 5V to forward regulating voltage register (0x15H), turn SW1 (FRWEN pin) to high to enable the forward output, monitor V_{OUT} and the REF pin waveform. When V_{REF} reaches 5V, LED2 (FWRPG) lights up.
- (7) Measure V_{OUT} using the DMM across the system positive “+” and system negative “-”. V_{OUT} should read 5V. The current meter on the supply should read <100mA. Monitor PH1 to observe Buck mode operation.

Note: If the load is added on the system side, ensure the current limit values in the system current limit and forward input current limit registers are not hit. The soft-start time can be set by changing the capacitor values connected on the REF pin. Refer to the [ISL95338](#) datasheet.

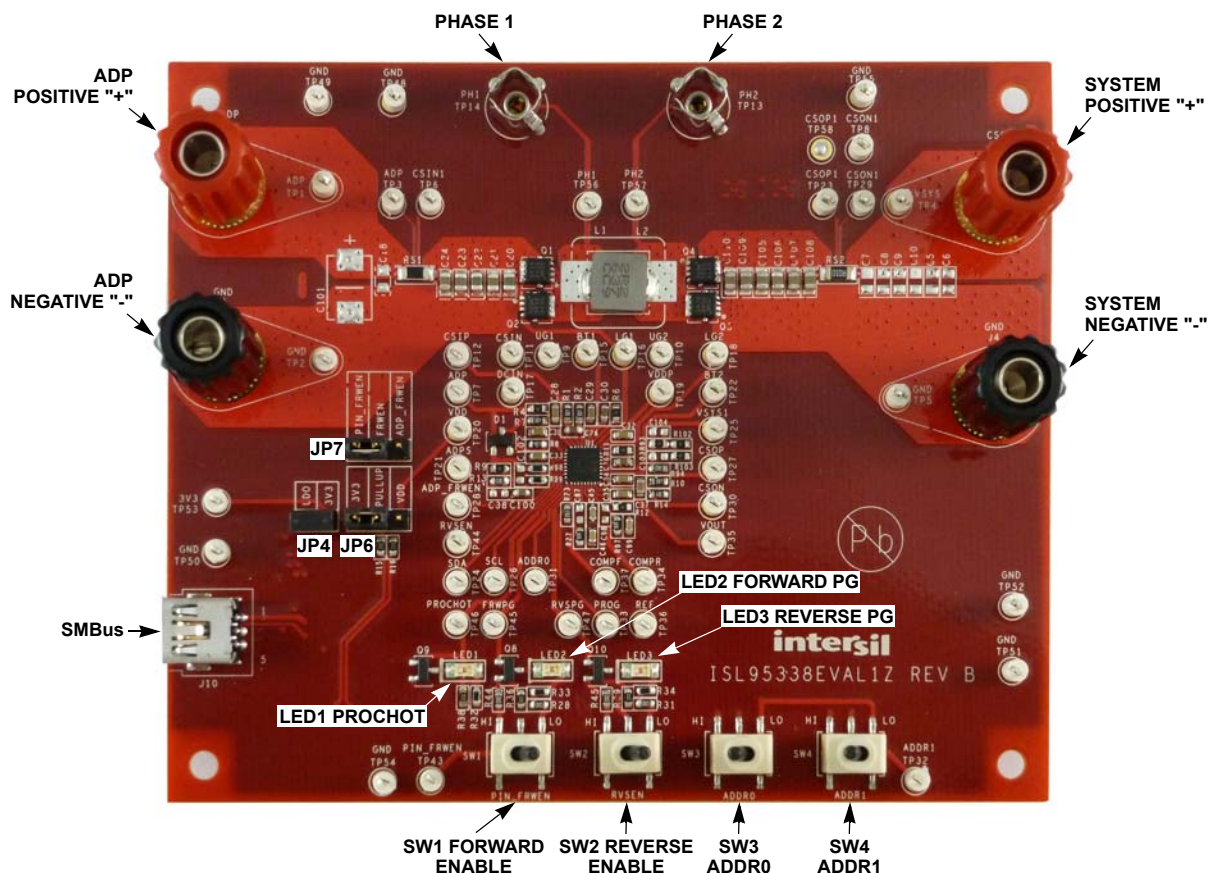

Figure 3. Evaluation Board Connection Guideline

2.1.2 Enabling Reverse Mode in Buck Mode

- (1) Set the 20V supply to 12V and, with SW1 in the low position, connect the (+) source to the system positive terminal and the (-) source to the system negative terminal.
- (2) Ensure that jumpers JP4, JP6, and JP7 are shorted. SW1 and SW2 should be in the low position.
- (3) Connect the USB cable to the USB port for SMBus. LED1, 2, and 3 light up.
- (4) Open ISL95338 GUI. Ensure that SW3 and SW4 are in the low position, and that the ISL95338 address is 0x96H.
- (5) Turn on the power supply. Note: A green check mark indicates that the GUI is ready to communicate with the evaluation board. A red X indicates that the GUI is not ready to communicate with the evaluation board. Click the USB reset button until the green check mark shows in the USB interface. If not, check the USB connection, VDD, and SMBus address settings.
- (6) Input 5V to reverse regulating voltage register (0x49H), turn SW2 (RVSEN pin) to high to enable reverse output, monitor V_{OUT} and the REF pin waveform. When V_{REF} reaches 5V, LED3 (RVSPG) lights up.
- (7) Measure V_{OUT} using the DMM across the ADP positive “+” and ADP negative “-”. V_{OUT} should read 5V. The current meter on the supply should read <100mA. Monitor PH2 to observe Buck mode operation.

Note: If the load is added on the ADP side, ensure the current limit value in the reverse output current register is not hit. The soft-start time can be set by changing capacitor values connecting on REF pin. Refer to [ISL95338](#) datasheet.

3. PCB Layout Guidelines

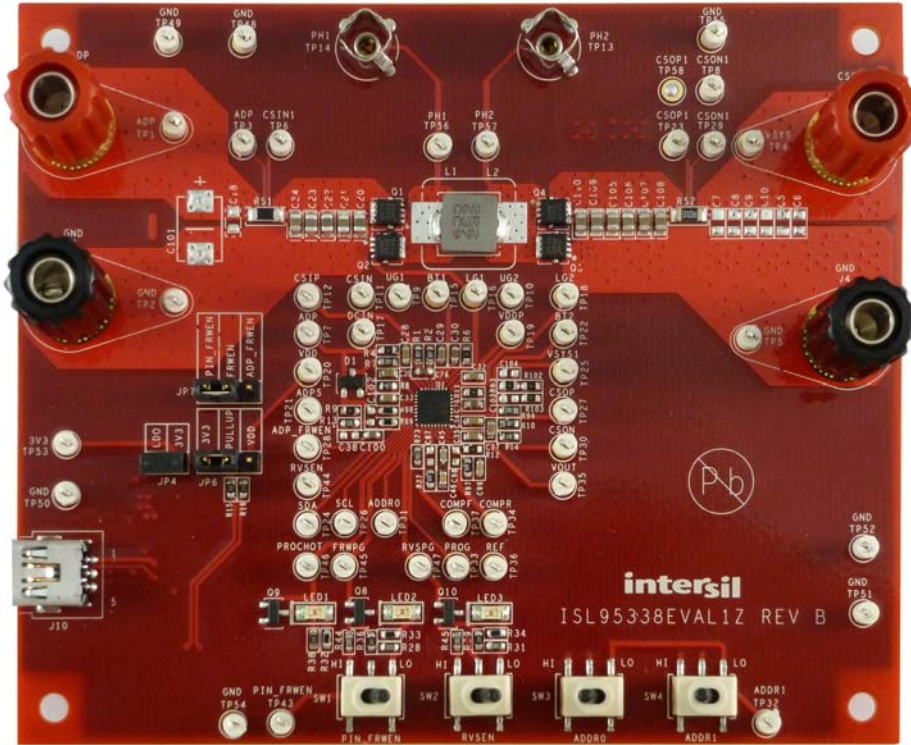

Figure 4. Evaluation Board Top View

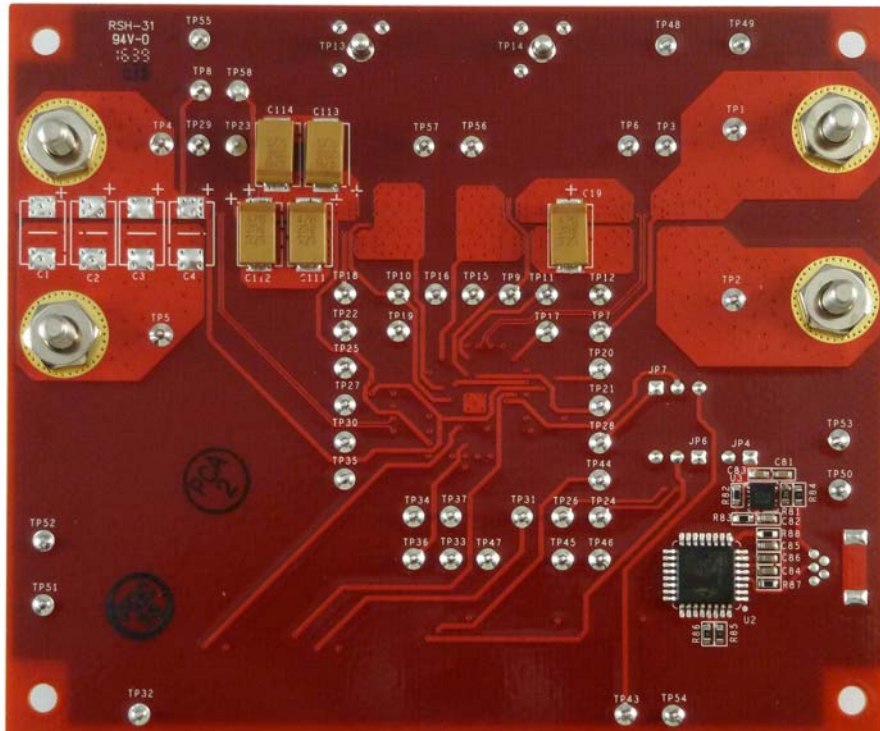
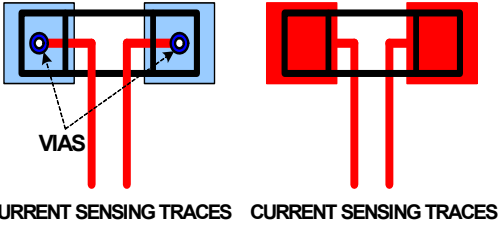
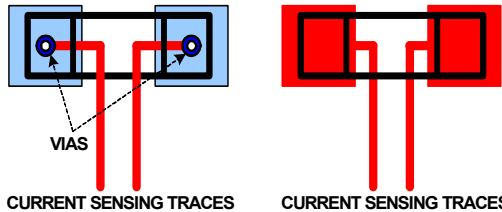

Figure 5. Evaluation Board Bottom View

3.1 Layout Guidelines

Pin #	Pin Name	Layout Guidelines
BOTTOM PAD 33	GND	Connect this ground pad to the ground plane through low impedance path. We recommend using at least five vias to connect to ground planes in the PCB to ensure there is sufficient thermal dissipation directly under the IC.
1	CSON	<p>Run two dedicated traces with decent width in parallel (close to each other to minimize the loop area) from the two terminals of the battery current sensing resistor to the IC. Place the differential mode and common-mode RC filter components in general proximity of the controller.</p> <p>Route the current sensing traces through vias to connect the center of the pads; or route the traces into the pads from the inside of the current sensing resistor. The following drawings show the two preferred ways of routing current sensing traces.</p>  <p style="text-align: center;">VIAS</p> <p style="text-align: center;">CURRENT SENSING TRACES CURRENT SENSING TRACES</p>
2	CSOP	
3	VOUTS	Signal pin. Provides feedback for the system bus voltage. Place the optional RC filter in the general proximity of the controller. Run a dedicated trace from the system bus to the pin and do not route near the switching traces. Do not share the same trace with the signal routing to the DCIN pin OR diodes.
4	BOOT2	Switching pin. Place the bootstrap capacitor in the general proximity of the controller. Use a decent wide trace. Avoid any sensitive analog signal trace from crossing over or getting close.
5	UGATE2	<p>Run these two traces in parallel fashion with decent width. Avoid any sensitive analog signal trace from crossing over or getting close. Recommend routing PHASE2 trace to high-side MOSFET source pin instead of general copper.</p> <p>The IC should be placed close to the switching MOSFETs gate terminals and keep the gate drive signal traces short for a clean MOSFET drive. The IC can be placed on the opposite side of the switching MOSFETs.</p> <p>Place the output capacitors as close as possible to the switching high-side MOSFET drain and the low-side MOSFET source; and use shortest PCB trace connection. Place these capacitors on the same PCB layer with the MOSFETs instead of on different layers and using vias to make the connection.</p> <p>Place the inductor terminal to the switching high-side MOSFET drain and low-side MOSFET source terminal as close as possible. Minimize this phase node area to lower the electrical and magnetic field radiation but make this phase node area big enough to carry the current. Place the inductor and the switching MOSFETs on the same layer of the PCB.</p>
6	PHASE2	
7	LGATE2	Switching pin. The run LGATE2 trace in parallel with the UGATE2 and PHASE2 traces on the same PCB layer. Use decent width. Avoid any sensitive analog signal trace from crossing over or getting close.
8	VDDP	Place the decoupling capacitor in general proximity of the controller. Run the trace connecting to VDD pin with decent width.
9	LGATE1	Switching pin. Run the LGATE1 trace in parallel with the UGATE1 and PHASE1 traces on the same PCB layer. Use decent width. Avoid any sensitive analog signal trace from crossing over or getting close.
10	PHASE1	<p>Run these two traces in parallel fashion with decent width. Avoid any sensitive analog signal trace from crossing over or getting close. We recommend routing the PHASE1 trace to the high-side MOSFET source pin instead of general copper.</p> <p>The IC should be placed close to the switching MOSFETs gate terminals and keep the gate drive signal traces short for a clean MOSFET drive. The IC can be placed on the opposite side of the switching MOSFETs.</p> <p>Place the input capacitors as close as possible to the switching high-side MOSFET drain and the low-side MOSFET source; and use shortest PCB trace connection. Place these capacitors on the same PCB layer with the MOSFETs instead of on different layers and using vias to make the connection.</p> <p>Place the inductor terminal to the switching high-side MOSFET drain and low-side MOSFET source terminal as close as possible. Minimize this phase node area to lower the electrical and magnetic field radiation but make this phase node area big enough to carry the current. Place the inductor and the switching MOSFETs on the same layer of the PCB.</p>
11	UGATE1	

Pin #	Pin Name	Layout Guidelines
12	BOOT1	Switching pin. Place the bootstrap capacitor in general proximity of the controller. Use decent wide trace. Avoid any sensitive analog signal trace from crossing over or getting close.
13	ADPS	Signal pin. Provides feedback for the system bus voltage. Place the optional RC filter in general proximity of the controller. Run a dedicated trace from system bus to the pin and do not route near the switching traces.
14	CSIN	<p>Run two dedicated traces with decent width in parallel (close to each other to minimize the loop area) from the two terminals of the adapter current sensing resistor to the IC. Place the Differential mode and common-mode RC filter components in general proximity of the controller.</p> <p>Route the current sensing traces through vias to connect the center of the pads; or route the traces into the pads from the inside of the current sensing resistor. The following drawings show the two preferred ways of routing current sensing traces.</p> 
15	CSIP	
16	ADP	Signal pin. Run a dedicated trace from the ADP side to the pin and do not route near the switching traces.
17	DCIN	Place the OR diodes and the RC filter in general proximity of the controller. Run the VADP trace and VSYS trace to the OR diodes with decent width.
18	VDD	Place the RC filter connecting with VDDP pin in general proximity of the controller. Run the trace connecting to VDDP pin with decent width.
19	FRWEN	Do not route near the switching traces.
20	RVSEN	No special consideration.
21	SDA	Digital pins. No special consideration. Run the SDA and SCL traces in parallel.
22	SCL	
23	PROCHOT#	Digital pin, open-drain output. No special consideration.
24	FRWPG	Digital pin, open-drain output. No special consideration.
25	ADDR0	Digital pin. No special consideration.
26	RVSPG	Digital pin, open-drain output. No special consideration.
27	PROG	Signal pin. Place the PROG programming resistor in general proximity of the controller.
28	COMPF	Place the compensation components in general proximity of the controller. Avoid any switching signal from crossing over or getting close.
29	REF	Do not route near the switching traces. Place the REF capacitor in general proximity of the controller.
30	COMPR	Place the compensation components in general proximity of the controller. Avoid any switching signal from crossing over or getting close.
31	VOUT	Signal pin. Run a dedicated trace from system side to the pin and do not route near the switching traces.
32	ADDR1	Digital pin. No special consideration.

3.2 ISL95338EVAL1Z Schematic

All NFETs and PFETs are 3x3 size

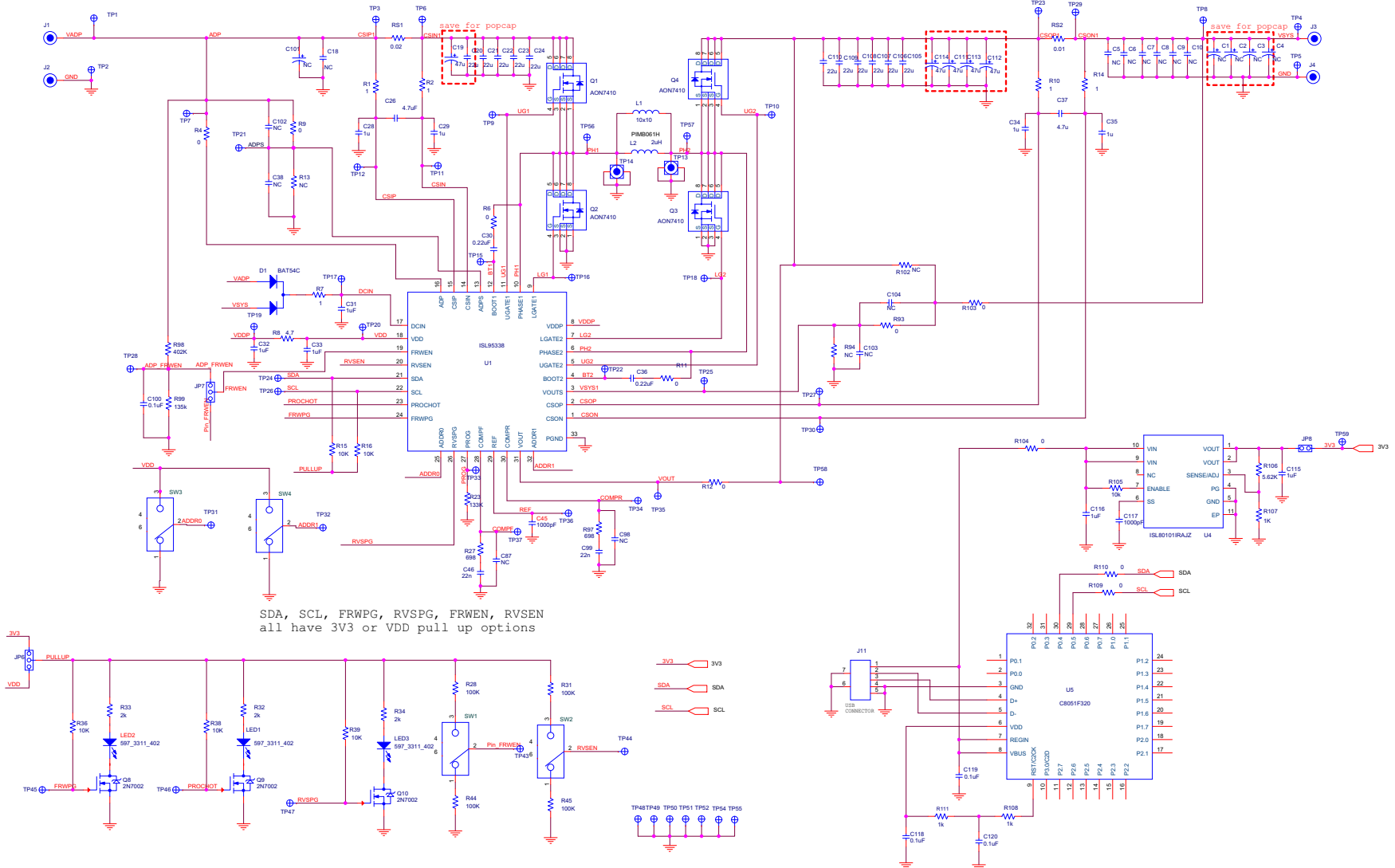

Figure 6. ISL95338EVAL1Z Evaluation Board Schematic

3.3 Bill of Materials

Reference Designator	Qty	Manufacturer	Part Number	Description
SEE LABEL- RENAME BOARD	1	IMAGINEERING INC	ISL95338EVAL1ZREVBPCB	PWB-PCB, ISL95338EVAL1Z, REVB, ROHS
C19, C111, C112, C113, C114	5	Kemet	399-3797-2-ND	CAP-POSCAP, SMD, 7.3x4.3x1.9, 47µF, 25V, 20%, 55mΩ, ROHS
C45, C82	2	VENKEL	H1045-00102-16V10-T	CAP, SMD, 0603, 1000pF, 16V, 10%, X7R, ROHS
C84, C85, C86, C100,	4	MURATA	H1045-00104-25V10-T	CAP, SMD, 0603, 0.1µF, 25V, 10%, X7R, ROHS
C31, C81, C83, C28, C29, C34, C35, C32, C33	9	MURATA	H1045-00105-25V10-T	CAP, SMD, 0603, 1µF, 25V, 10%, X5R, ROHS
C30, C36	2	TDK	H1045-00224-25V10-T	CAP, SMD, 0603, 0.22µF, 25V, 10%, X7R, ROHS
C46, C99	2	MURATA	H1045-00472-16V10-T	CAP, SMD, 0603, 0.022µF, 25V, 10%, X7R, ROHS
C26, C37	2	VENKEL	H1045-00475-10V10-T	CAP, SMD, 0603, 4.7µF, 10V, 10%, X5R, ROHS
C87, C98	2		H1045-DNP	CAP, SMD, 0603, DNP-PLACE HOLDER, ROHS
C20-24, C105-C110	9	TDK	1276-2908-2-ND	CAP, SMD, 0805, 22µF, 25V, 10%, X5R, ROHS
L1	1	CYNTEC CO., LTD.	PIMB063T-2R2MS-01	PWR CHOKE COIL, SMD, 6.95x6.6, 2.2µH, 10A, 20%, ROHS
J1, J3	2	JOHNSON COMPONENTS	111-0702-001	CONN-GEN, BIND.POST, INSUL-RED, THMBNUT-GND
J2, J4	2	JOHNSON COMPONENTS	111-0703-001	CONN-GEN, BIND.POST, INSUL-BLK, THMBNUT-GND
TP13, TP14	2	TEKTRONIX	131-4353-00	CONN-SCOPE PROBE TEST PT, COMPACT, PCB MNT, ROHS
TP1-TP12, TP15-TP37, TP43-TP57	50	KEYSTONE	5002	CONN-MINI TEST POINT, VERTICAL, WHITE, ROHS
J10	1	MOLEX	54819-0519	CONN-USB MINI-B RECEPTACLE, TH, 5CIRCUIT, R/A, ROHS
JP6, JP7	2	BERG/FCI	68000-236HLF-1X3	CONN-HEADER, 1x3, BREAKAWY 1x36, 2.54mm, ROHS
JP4	1	BERG/FCI	69190-202HLF	CONN-HEADER, 1x2, RETENTIVE, 2.54mm, 0.230x0.120, ROHS
JP4-Pins 1-2.	1	SULLINS	SPC02SYAN	CONN-JUMPER, SHORTING, 2PIN, BLACK, GOLD, ROHS
D1	1		BAT54C-7-F-T	DIODE-RECTIFIER, SMD, SOT23, 30V, 200mA, DUAL DIODE, ROHS
LED1, LED2, LED3	3	DIALIGHT	597-3311-407NF-T	LED, SMD, 1206, GREEN, 75mW, 3mcd, 567nm, ROHS
U2	1	SILICON LABORATORIES	C8051F320-GQ/PROG-REV.02	IC-USB MICROCONTROLLER, 32P, LQFP, PROGRAMMED, ROHS
U3	1	INTERSIL	ISL80101IRAJZ	IC-ADJ.V, 1A LDO REGULATOR, 10P, DFN, 3X3, ROHS
U1	1	INTERSIL	ISL95338HRZ	C-NOTEBOOK BATTERY CHARGER, 32P, QFN, 4x4, ROHS
Q8, Q9, Q10	3	DIODES, INC.	2N7002-7-F-T	TRANSISTOR, N-CHANNEL, 3LD, SOT-23, 60V, 115mA, ROHS

Reference Designator	Qty	Manufacturer	Part Number	Description
Q1, Q2, Q3, Q4	4	VISHAY	SISA14DN-T1-GE3-T	TRANSISTOR-MOS, N-CHANNEL, 8P, PWRPAK, 30V, 20A, ROHS
R1, R2, R7, R10, R14	5	YAGEO	H2511-00020-1/10W1-T	RES, SMD, 0603, 2Ω, 1/10W, 1%, TF, ROHS
R8	1	VENKEL	H2511-004R7-1/10W1-T	RES, SMD, 0603, 4.7Ω, 1/10W, 1%, TF, ROHS
R4, R6, R11, R12, R103, R84, R85, R86, R9, R9	11	VENKEL	H2511-00R00-1/10W-T	RES, SMD, 0603, 0Ω, 1/10W, TF, ROHS
R83, R87, R88	3	PANASONIC	H2511-01001-1/10W1-T	RES, SMD, 0603, 1k, 1/10W, 1%, TF, ROHS
R15, R16, R36, R38, R39, R81	6	VENKEL	H2511-01002-1/10W1-T	RES, SMD, 0603, 10k, 1/10W, 1%, TF, ROHS
R13	1	YAGEO	311-1.00MHRTR-ND	RES SMD 1MΩ 1% 1/10W 0603
R28, R31, R44, R45	4	VENKEL	H2511-01003-1/10W1-T	RES, SMD, 0603, 100k, 1/10W, 1%, TF, ROHS
R23	1	VENKEL	H2511-01333-1/10W1-T	RES, SMD, 0603, 133k, 1/10W, 1%, TF, ROHS
R27, R97	2	PANASONIC	H2511-06980-1/10W1-T	RES, SMD, 0603, 698, 1/10W, 1%, TF, ROHS
R32, R33, R34	3	YAGEO	H2511-02200-1/10W1-T	RES, SMD, 0603, 2kΩ, 1/10W, 1%, TF, ROHS
R98	1	PANASONIC	H2511-04023-1/10W1-T	RES, SMD, 0603, 402k, 1/16W, 1%, TF, ROHS
R82	1	PANASONIC	H2511-05621-1/10W1-T	RES, SMD, 0603, 5.62k, 1/10W, 1%, TF, ROHS
RS2	1	VISHAY/DALE	WSLP1206R0100FEA-T	RES-CURR.SENSE, SMD, 1206, 0.01Ω, 1W, 1%, 75ppm, ROHS
R99	1	PANASONIC	H2511-04023-1/10W1-T	RES SMD 135kΩ 0.1% 1/10W 0603
RS1	1	VISHAY/DALE	WSLP1206R0200FEA-T	RES-CURR.SENSE, SMD, 1206, 0.02Ω, 1W, 1%, 75ppm, ROHS
SW1, SW2, SW3, SW4	4	ITT INDUSTRIES/ C&K DIVISION	GT11MSCBE-T	SWITCH-TOGGLE, SMD, 6PIN, SPDT, 2POS, ON-NONE-ON, ROHS
C101 C18, C102 C38, C5-C10, C1-C4, C104, C103, C39	DNP			
R3, R94, R13, R102	DNP			
TP38-TP42	DNP			
C27	DNP			
AFFIX TO BACK OF PCB	1	INTERSIL	LABEL-DATE CODE	LABEL-DATE CODE_LINE 1: YRWK/REV#, LINE 2: BOM NAM
RENAME PCB TO: ISL95338EVAL1Z.		INTERSIL	LABEL-RENAME BOARD	LABEL, TO RENAME BOARD

3.4 Board Layout

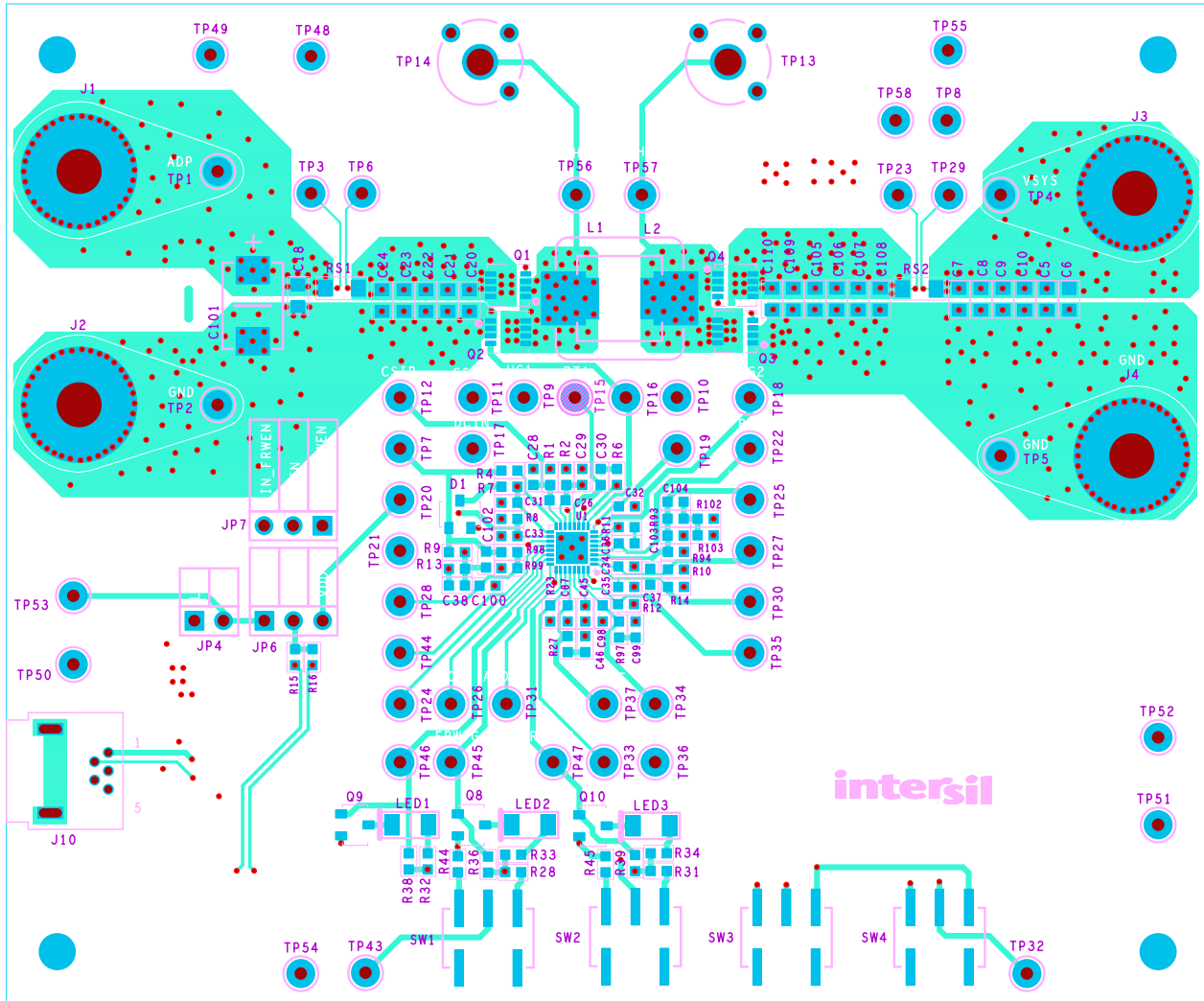

Figure 7. Top Layer

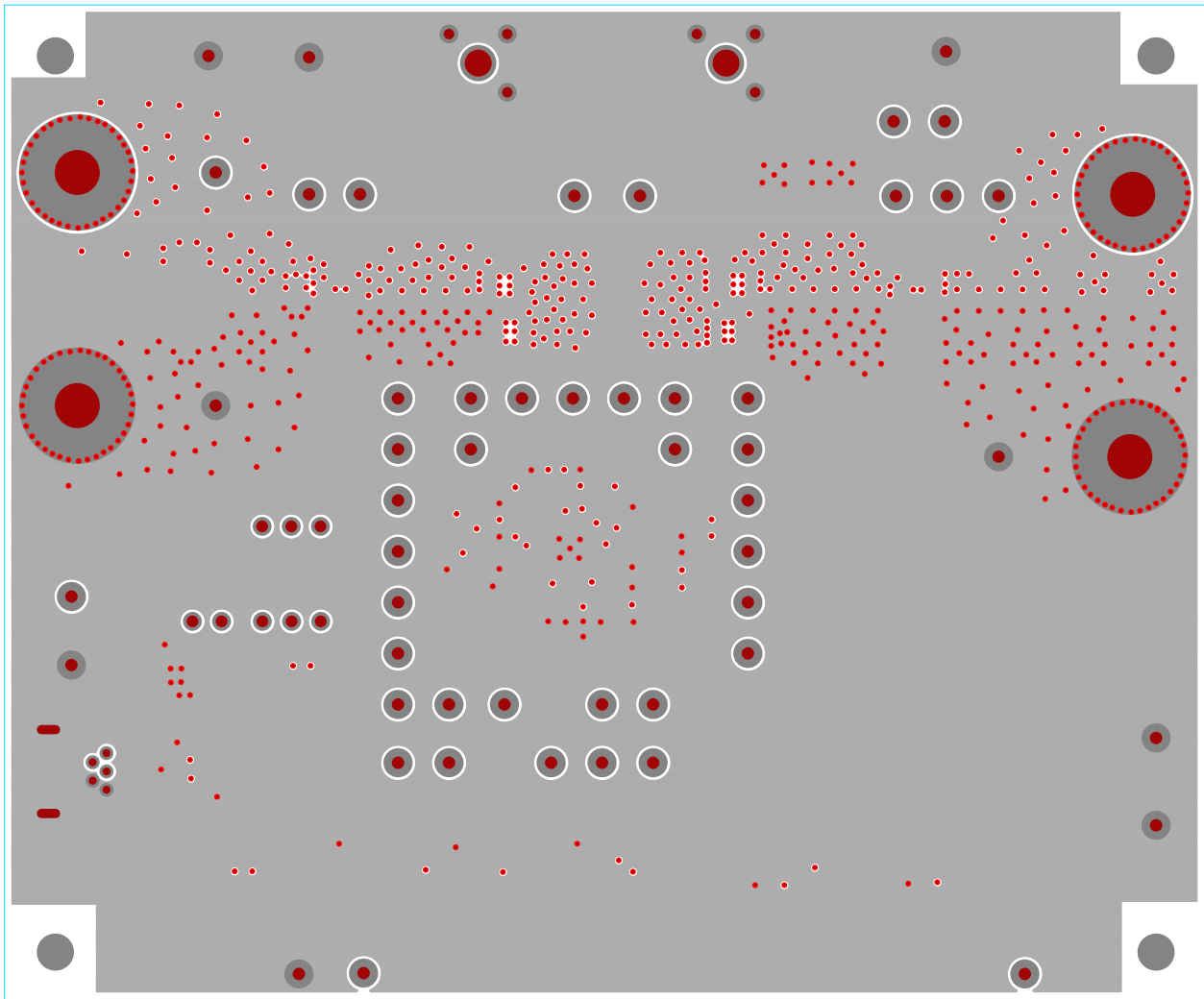

Figure 8. Inner Layer 1

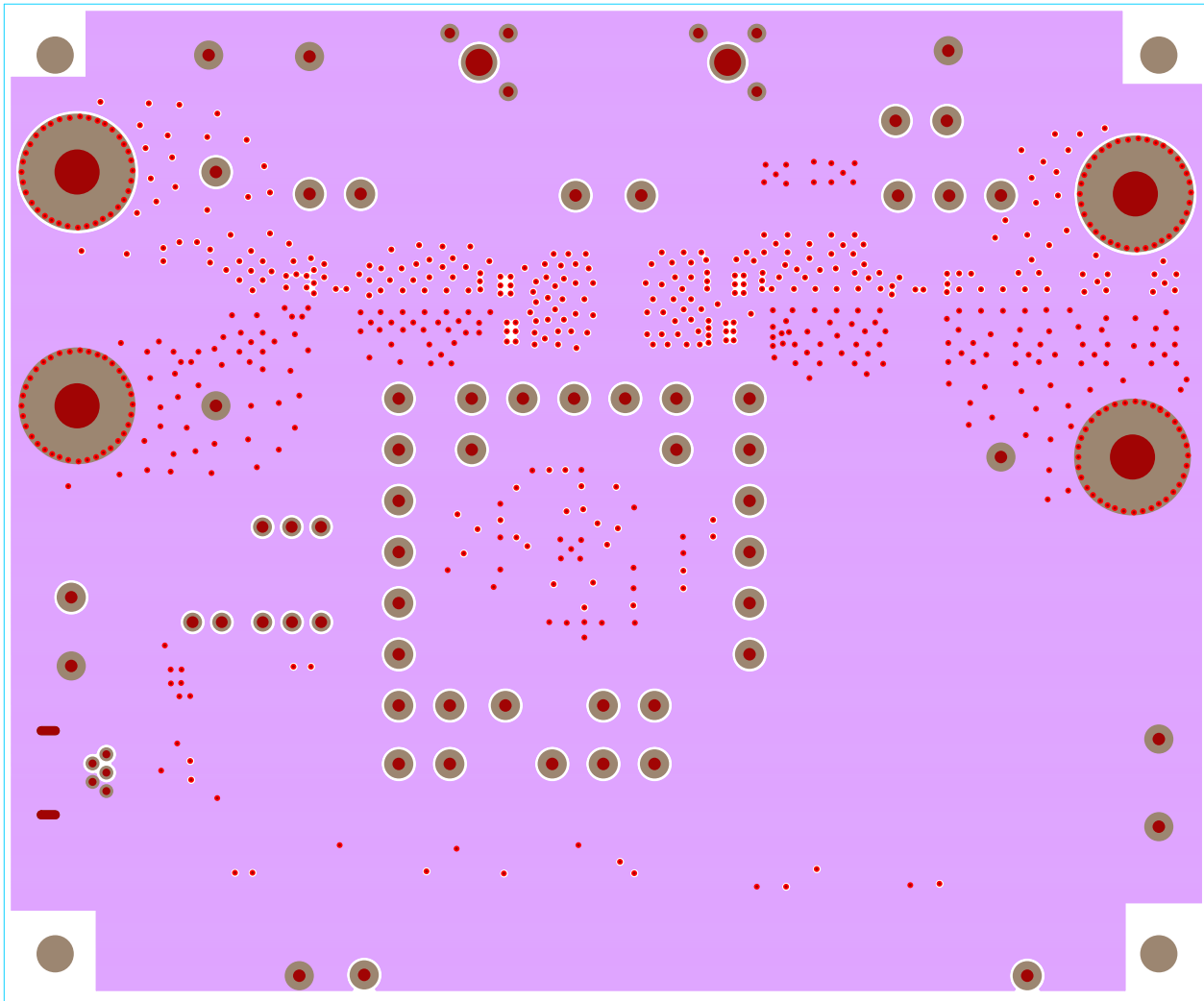

Figure 9. Inner Layer 2

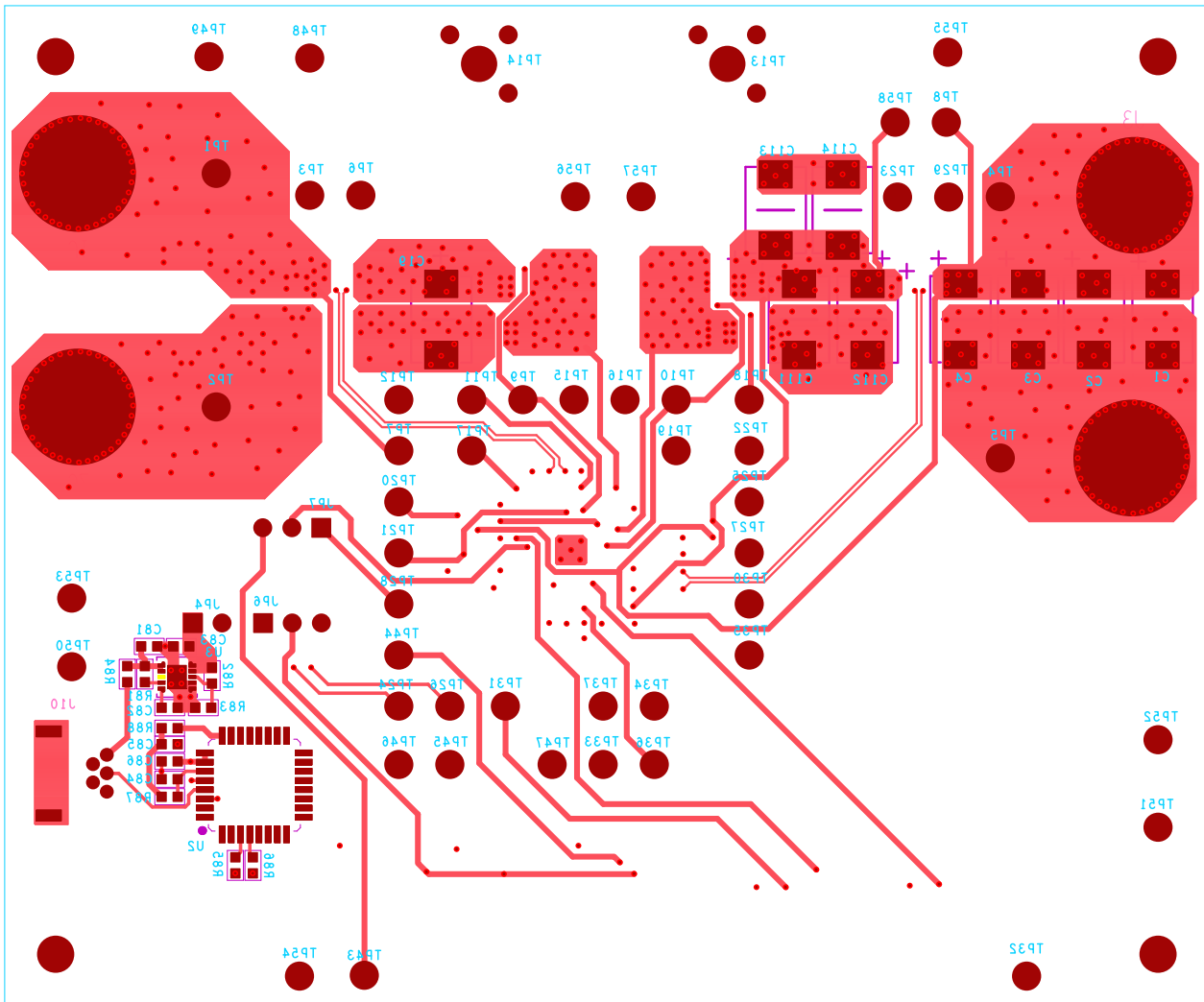

Figure 10. Bottom Layer

4. Typical Performance Curves

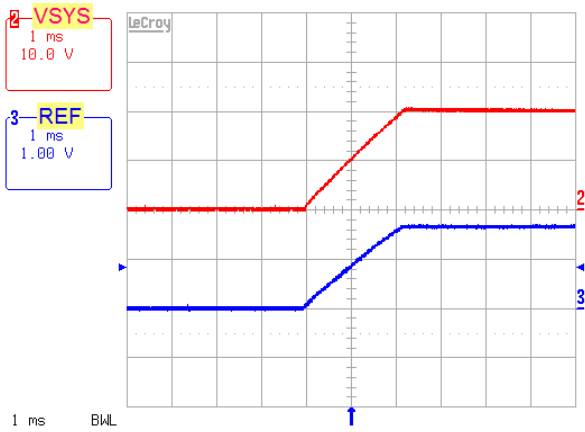

Figure 11. Forward Mode Soft-Start, 12V_{ADP}, 20V_{SYS}

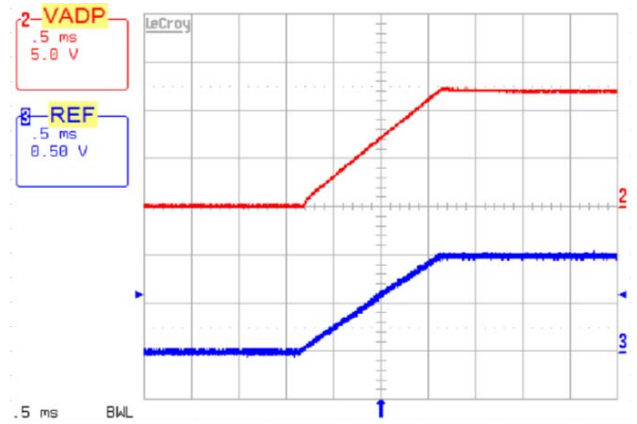

Figure 12. Reverse Mode, Soft-Start, 12V_{ADP}, 5V_{SYS}

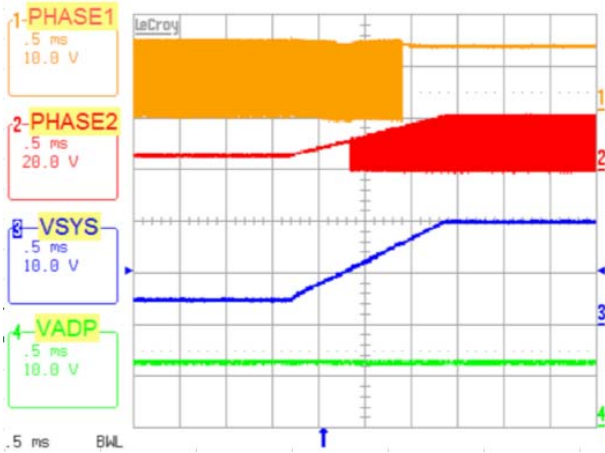

Figure 13. V_{SYS} Voltage Ramps Up in Forward Mode, Buck -> Buck-Boost -> Boost Operation Mode Transition

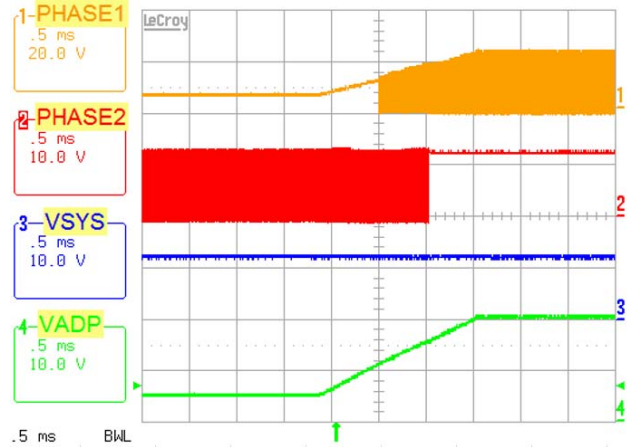

Figure 14. ADP Voltage Ramps Up in Reverse Mode, Buck -> Buck-Boost -> Boost Operation Mode Transition

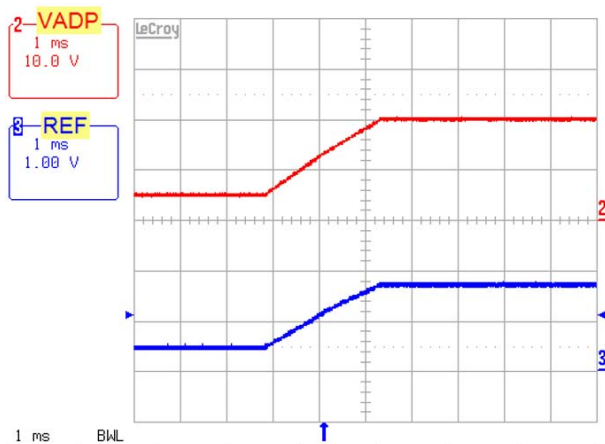

Figure 15. Reverse Mode, 5V_{ADP} to 20V_{ADP}

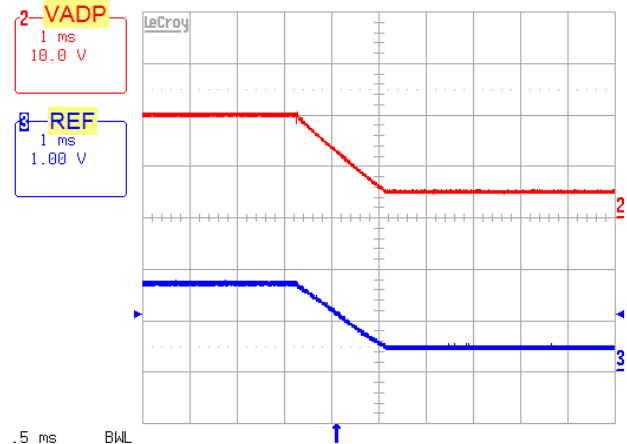

Figure 16. Reverse Mode, 20V_{ADP} to 5V_{ADP}

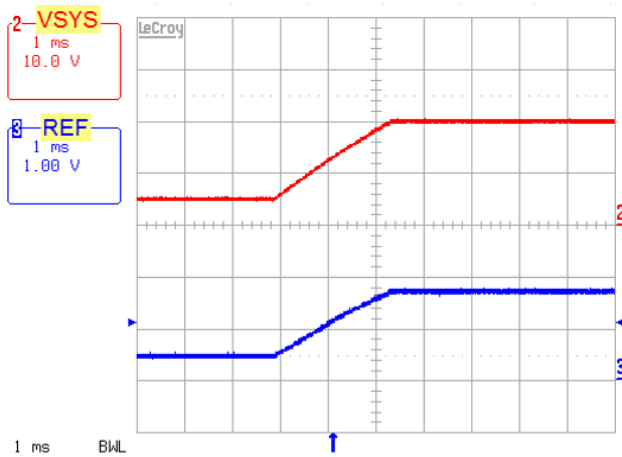

Figure 17. Forward Mode, 5V_{sys} to 20V_{sys}

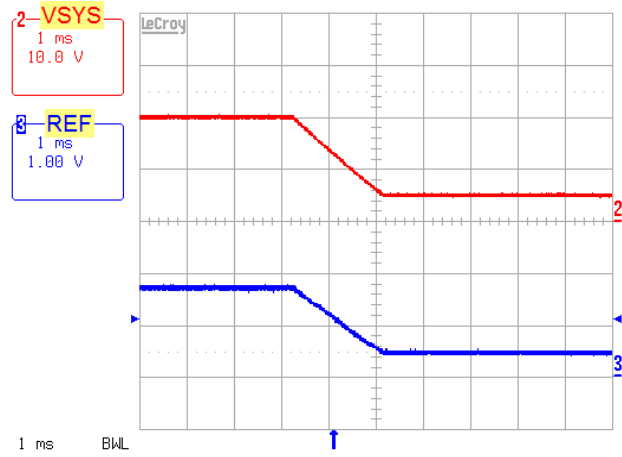

Figure 18. Forward Mode, 20V_{sys} to 5V_{sys}

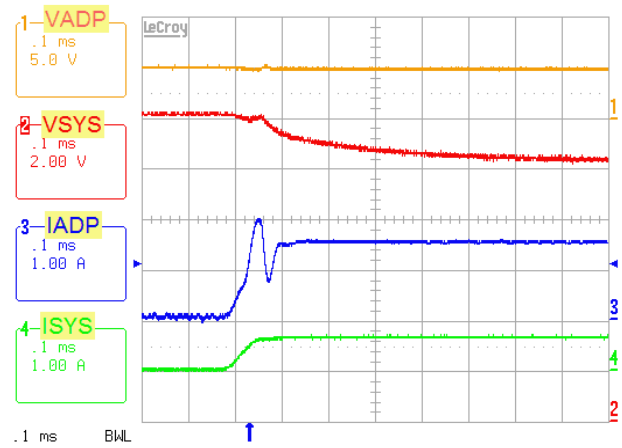

Figure 19. Forward Mode, Output Voltage Loop to ADP Current Loop Transition. 5V_{ADP}, 12V_{sys}, System Load 0A to 0.65A Step, ADP Current Limit = 1.5A

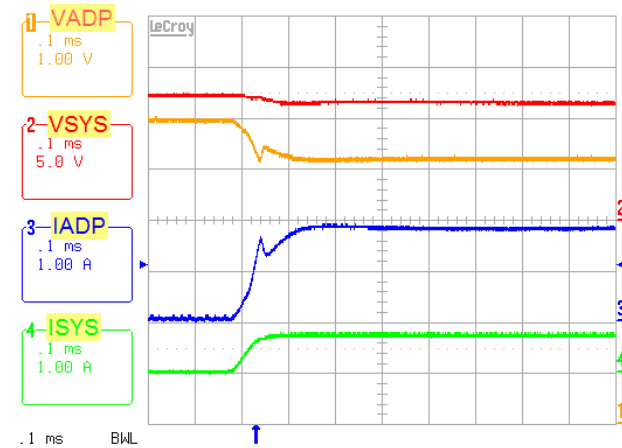

Figure 20. Forward Mode, Output Voltage Loop to Adapter Voltage Loop Transition. 6V_{ADP}, Input Voltage Limit = 5.12V, 12V_{sys}, System Load 0A to 0.78A Step, System Current Limit = 5A, Input Current Limit = 5 A

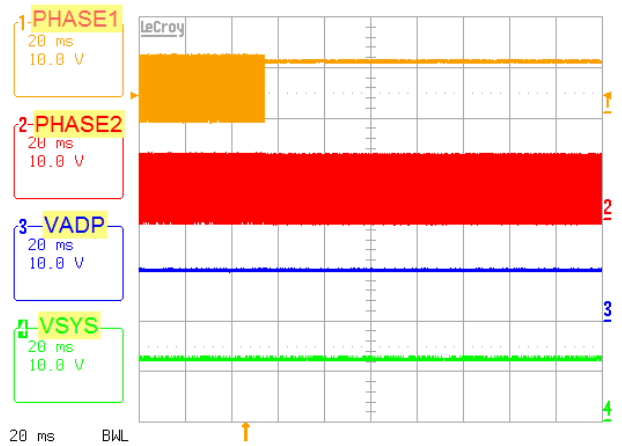

Figure 21. Forward Mode, Force Buck-Boost Mode to Boost Mode. 10V_{ADP}, 12V_{sys}

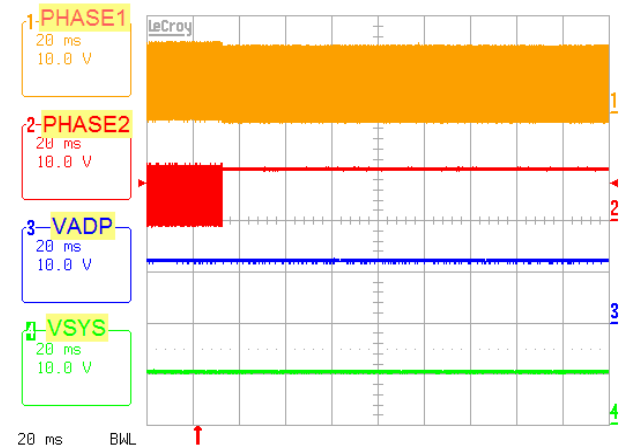

Figure 22. Reverse Mode, Force Buck-Boost Mode to Boost Mode. 12V_{ADP}, 10V_{sys}

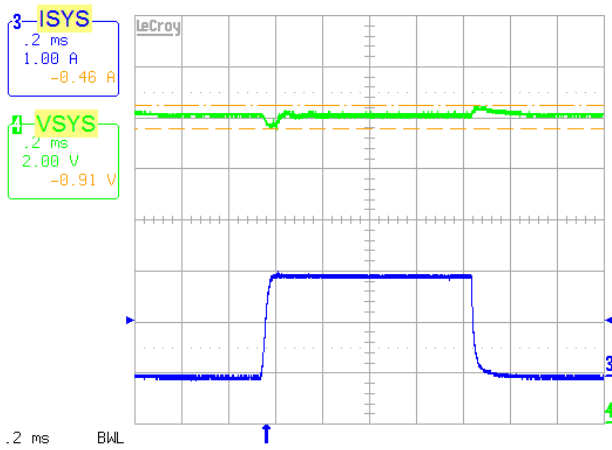

Figure 23. Forward Mode, 5V_{ADP}, 12V_{SYS}, 0-2A Transient Load

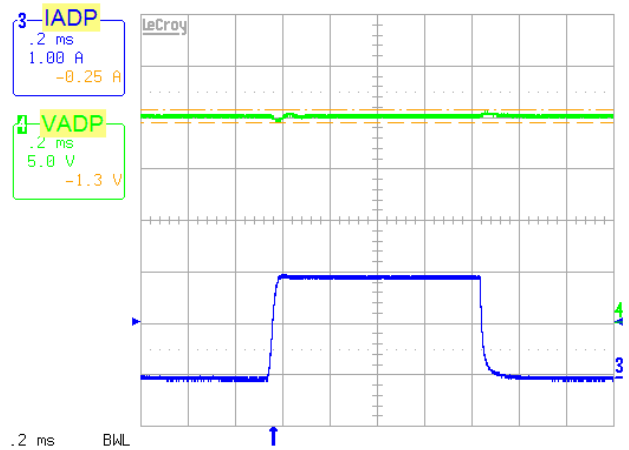

Figure 24. Reverse Mode, 20V_{ADP}, 12V_{SYS}, 0-2A Transient Load

5. Revision History

Rev.	Date	Description
0.00	Aug 17, 2017	Initial release

Notice

1. Descriptions of circuits, software and other related information in this document are provided only to illustrate the operation of semiconductor products and application examples. You are fully responsible for the incorporation or any other use of the circuits, software, and information in the design of your product or system. Renesas Electronics disclaims any and all liability for any losses and damages incurred by you or third parties arising from the use of these circuits, software, or information.
2. Renesas Electronics hereby expressly disclaims any warranties against and liability for infringement or any other claims involving patents, copyrights, or other intellectual property rights of third parties, by or arising from the use of Renesas Electronics products or technical information described in this document, including but not limited to, the product data, drawings, charts, programs, algorithms, and application examples.
3. No license, express, implied or otherwise, is granted hereby under any patents, copyrights or other intellectual property rights of Renesas Electronics or others.
4. You shall not alter, modify, copy, or reverse engineer any Renesas Electronics product, whether in whole or in part. Renesas Electronics disclaims any and all liability for any losses or damages incurred by you or third parties arising from such alteration, modification, copying or reverse engineering.
5. Renesas Electronics products are classified according to the following two quality grades: "Standard" and "High Quality". The intended applications for each Renesas Electronics product depends on the product's quality grade, as indicated below.
"Standard": Computers; office equipment; communications equipment; test and measurement equipment; audio and visual equipment; home electronic appliances; machine tools; personal electronic equipment; industrial robots; etc.
"High Quality": Transportation equipment (automobiles, trains, ships, etc.); traffic control (traffic lights); large-scale communication equipment; key financial terminal systems; safety control equipment; etc.
Unless expressly designated as a high reliability product or a product for harsh environments in a Renesas Electronics data sheet or other Renesas Electronics document, Renesas Electronics products are not intended or authorized for use in products or systems that may pose a direct threat to human life or bodily injury (artificial life support devices or systems; surgical implantations; etc.), or may cause serious property damage (space system; undersea repeaters; nuclear power control systems; aircraft control systems; key plant systems; military equipment; etc.). Renesas Electronics disclaims any and all liability for any damages or losses incurred by you or any third parties arising from the use of any Renesas Electronics product that is inconsistent with any Renesas Electronics data sheet, user's manual or other Renesas Electronics document.
6. When using Renesas Electronics products, refer to the latest product information (data sheets, user's manuals, application notes, "General Notes for Handling and Using Semiconductor Devices" in the reliability handbook, etc.), and ensure that usage conditions are within the ranges specified by Renesas Electronics with respect to maximum ratings, operating power supply voltage range, heat dissipation characteristics, installation, etc. Renesas Electronics disclaims any and all liability for any malfunctions, failure or accident arising out of the use of Renesas Electronics products outside of such specified ranges.
7. Although Renesas Electronics endeavors to improve the quality and reliability of Renesas Electronics products, semiconductor products have specific characteristics, such as the occurrence of failure at a certain rate and malfunctions under certain use conditions. Unless designated as a high reliability product or a product for harsh environments in a Renesas Electronics data sheet or other Renesas Electronics document, Renesas Electronics products are not subject to radiation resistance design. You are responsible for implementing safety measures to guard against the possibility of bodily injury, injury or damage caused by fire, and/or danger to the public in the event of a failure or malfunction of Renesas Electronics products, such as safety design for hardware and software, including but not limited to redundancy, fire control and malfunction prevention, appropriate treatment for aging degradation or any other appropriate measures. Because the evaluation of microcomputer software alone is very difficult and impractical, you are responsible for evaluating the safety of the final products or systems manufactured by you.
8. Please contact a Renesas Electronics sales office for details as to environmental matters such as the environmental compatibility of each Renesas Electronics product. You are responsible for carefully and sufficiently investigating applicable laws and regulations that regulate the inclusion or use of controlled substances, including without limitation, the EU RoHS Directive, and using Renesas Electronics products in compliance with all these applicable laws and regulations. Renesas Electronics disclaims any and all liability for damages or losses occurring as a result of your noncompliance with applicable laws and regulations.
9. Renesas Electronics products and technologies shall not be used for or incorporated into any products or systems whose manufacture, use, or sale is prohibited under any applicable domestic or foreign laws or regulations. You shall comply with any applicable export control laws and regulations promulgated and administered by the governments of any countries asserting jurisdiction over the parties or transactions.
10. It is the responsibility of the buyer or distributor of Renesas Electronics products, or any other party who distributes, disposes of, or otherwise sells or transfers the product to a third party, to notify such third party in advance of the contents and conditions set forth in this document.
11. This document shall not be reprinted, reproduced or duplicated in any form, in whole or in part, without prior written consent of Renesas Electronics.
12. Please contact a Renesas Electronics sales office if you have any questions regarding the information contained in this document or Renesas Electronics products.
(Note 1) "Renesas Electronics" as used in this document means Renesas Electronics Corporation and also includes its directly or indirectly controlled subsidiaries.
(Note 2) "Renesas Electronics product(s)" means any product developed or manufactured by or for Renesas Electronics.

(Rev.4.0-1 November 2017)



SALES OFFICES

Renesas Electronics Corporation

<http://www.renesas.com>

Refer to "<http://www.renesas.com/>" for the latest and detailed information.

California Eastern Laboratories, Inc.
4590 Patrick Henry Drive, Santa Clara, California 95054-1817, U.S.A.
Tel: +1-408-919-2500, Fax: +1-408-988-0279

Renesas Electronics Canada Limited
9251 Yonge Street, Suite 8309 Richmond Hill, Ontario Canada L4C 9T3
Tel: +1-905-237-2004

Renesas Electronics Europe Limited
Dukes Meadow, Millboard Road, Bourne End, Buckinghamshire, SL8 5FH, U.K
Tel: +44-1628-651-700

Renesas Electronics Europe GmbH
Arcadiastrasse 10, 40472 Düsseldorf, Germany
Tel: +49-211-6503-0, Fax: +49-211-6503-1327

Renesas Electronics (China) Co., Ltd.
Room 1709 Quantum Plaza, No.27 ZhichunLu, Haidian District, Beijing, 100191 P. R. China
Tel: +86-10-8235-1155, Fax: +86-10-8235-7679

Renesas Electronics (Shanghai) Co., Ltd.
Unit 301, Tower A, Central Towers, 555 Langao Road, Putuo District, Shanghai, 200333 P. R. China
Tel: +86-21-2226-0888, Fax: +86-21-2226-0999

Renesas Electronics Hong Kong Limited
Unit 1601-1611, 16/F., Tower 2, Grand Century Place, 193 Prince Edward Road West, Mongkok, Kowloon, Hong Kong
Tel: +852-2265-6688, Fax: +852 2886-9022

Renesas Electronics Taiwan Co., Ltd.
13F, No. 363, Fu Shing North Road, Taipei 10543, Taiwan
Tel: +886-2-8175-9600, Fax: +886 2-8175-9670

Renesas Electronics Singapore Pte. Ltd.
80 Bendemeer Road, Unit #06-02 Hyflux Innovation Centre, Singapore 339949
Tel: +65-6213-0200, Fax: +65-6213-0300

Renesas Electronics Malaysia Sdn.Bhd.
Unit 1207, Block B, Menara Amcorp, Amcorp Trade Centre, No. 18, Jln Persiaran Barat, 46050 Petaling Jaya, Selangor Darul Ehsan, Malaysia
Tel: +60-3-7955-9390, Fax: +60-3-7955-9510

Renesas Electronics India Pvt. Ltd.
No.77C, 100 Feet Road, HAL 2nd Stage, Indiranagar, Bangalore 560 038, India
Tel: +91-80-67208700, Fax: +91-80-67208777

Renesas Electronics Korea Co., Ltd.
17F, KAMCO Yangjae Tower, 262, Gangnam-daero, Gangnam-gu, Seoul, 06265 Korea
Tel: +82-2-558-3737, Fax: +82-2-558-5338

ISL95338EVAL1Z

