

RA6T1

Sensorless vector control for permanent magnetic synchronous motor

Abstract

This application note describes the sample program for a permanent magnetic synchronous motor drive with sensorless vector control based on Renesas RA6T1 microcontroller. This application note also describes how to use the motor control development support tool, 'Renesas Motor Workbench'.

The targeted software for this application is only to be used as reference purposes only and Renesas Electronics Corporation does not guarantee the operations. Please use this after carrying out a thorough evaluation in a suitable environment.

Operation checking device

Operations of the target software of this application note are checked by using the following device.

- RA6T1 (R7FA6T1AD3CFP)

Contents

1. Overview	3
1.1 Development environment	3
2. System overview	4
2.1 Hardware configuration	4
2.2 Hardware specifications	5
2.2.1 User interface	5
2.2.2 Peripheral functions.....	7
2.3 Software configuration.....	12
2.3.1 Software file configuration	12
2.3.2 Module configuration	13
2.4 Software specifications.....	14
2.5 Interrupt Priority	15
3. Descriptions of the control program	16
3.1 Contents of control	16
3.1.1 Motor start/stop.....	16
3.1.2 A/D Converter.....	16
3.1.3 Modulation	17
3.1.4 State transition.....	19
3.1.5 Start-up method.....	20
3.1.6 System protection function	21
3.1.7 AD triggers.....	22
3.2 Function specifications of sensorless vector control software	23

3.3	Contents of control	30
3.3.1	Configuration Options.....	30
3.3.2	Configuration Options for included modules	30
3.4	Control flowcharts.....	38
3.4.1	Main process	38
3.4.2	50[μ s] Period Interrupt (Carrier synchronized Interrupt) Process	39
3.4.3	500 [μ s] Period Interrupt Process.....	40
3.4.4	Over Current Detection Interrupt Process.....	41
4.	Evaluation environment explanation	42
4.1	Operating Environment	42
4.2	Importing the Demo Project.....	42
4.3	Building and Debugging	43
4.4	Motor Demonstration Project Overview.....	44
4.4.1	Quick Start.....	44
4.5	Motor Control Development Support Tool 'Renesas Motor Workbench'	45
4.5.1	Overview.....	45
4.5.2	Easy function operation example	46
4.5.3	List of variables for Analyzer function	48
4.5.4	Operation Example for Analyzer	49
4.5.5	Tuner function.....	50
5.	Reference Documents	51
	Revision History.....	52

1. Overview

This application note explains how to implement the sensorless vector control software that drives permanent magnetic synchronous motor (PMSM) using the RA6T1 microcontroller and how to use the motor control development support tool, 'Renesas Motor Workbench'.

Note that this software uses the algorithm described in the application note 'Sensorless vector control for permanent magnet synchronous motor (Algorithm)' (R01AN3786), so please refer to that for the details of the algorithm.

1.1 Development environment

Table 1-1 and Table 1-2 show development environment of the software explained in this application note.

Table 1-1 Hardware Development Environment

Microcontroller	Evaluation board ^(Note 1)	Motor ^(Note 2)
RA6T1 (R7FA6T1AD3CFP)	48V inverter board (2 unit) RA6T1 CPU Card	TG-55L-KA 24V

Table 1-2 Software Development Environment

e ² studio version	FSP version	Toolchain version
V2022-10	V4.1.0 and later	GCC ARM Embedded: V10.3.1.20210824

For purchase and technical support, contact Sales representatives and dealers of Renesas Electronics Corporation.

Notes:

1. 48V inverter board (RTK0EM0000B10020BJ) is included in the kit products RTK0EMA170S00020BJ and RTK0EMX270S00020BJ, and it is a product of Renesas Electronics Corporation.

RA6T1 CPU Card (RTK0EMA170C00000BJ) is a product of Renesas Electronics Corporation.

2. TG-55L KA,24V is a product of TSUKASA ELECTRIC.

TSUKASA ELECTRIC (<https://www.tsukasa-d.co.jp/en/>)

2. System overview

Overview of this system is explained below.

2.1 Hardware configuration

The hardware configuration is shown below.

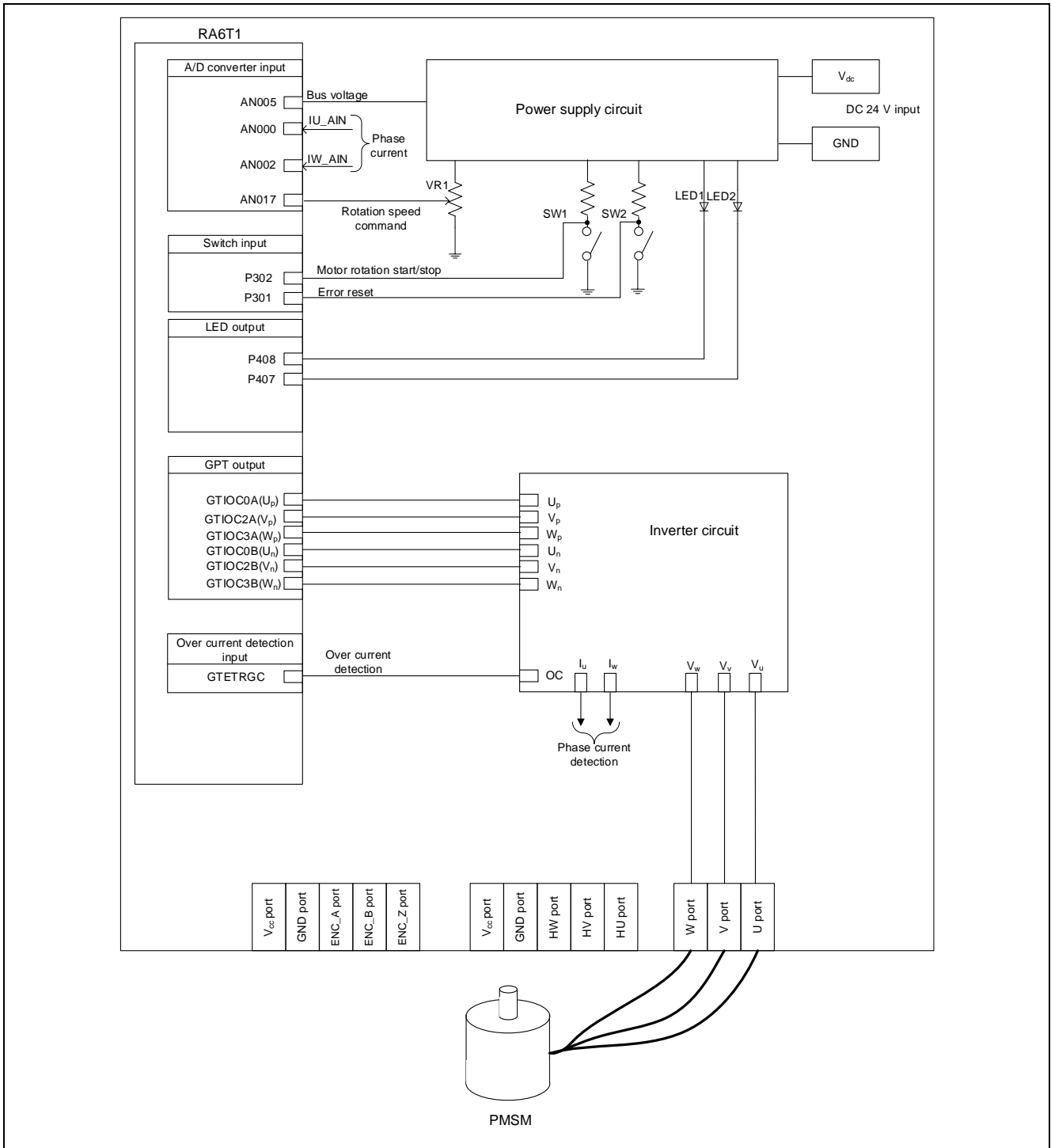

Figure 2-1 Hardware Configuration Diagram

2.2 Hardware specifications

2.2.1 User interface

Table 2-1 and Table 2-2 is lists of user interfaces of this system.

Table 2-1 User Interface

Item	Interface component	Function
Rotation speed command	Variable resistor (VR)	Reference value of rotation speed input (analog value)
START/STOP	Toggle switch (SW1)	Motor rotation start/stop command
ERROR RESET	Push switch (SW2)	Command of recovery from error status
LED1	Orange LED	- At the time of motor rotation: ON - At the time of stop: OFF
LED2	Orange LED	- At the time of error detection: ON - At the time of normal operation: OFF
LED3	Orange LED	Not used in this system

Table 2-2 CPU card user interface

Item	Interface component	Function
LED1	Yellow green LED	- At the time of motor rotation: ON - At the time of stop: OFF
LED2	Yellow green LED	- At the time of error detection: ON - At the time of normal operation: OFF
RESET	Push switch (RESET)	System reset

List of port interfaces of this system is given in Table 2-3.

Table 2-3 Port Interfaces

R7FA6T1AD3CFP port name	Function
P014 / AN005	Inverter bus voltage measurement
P502 / AN017	For inputting rotation speed command values (analog values)
P302	START/STOP toggle switch
P301	ERROR RESET push switch
P408	LED1 ON/OFF control
P407	LED2 ON/OFF control
P000 / AN000	U phase current measurement
P001 / AN001	V phase current measurement
P002 / AN002	W phase current measurement
P415 / GTIOC0A	PWM output (Up) / Low Active
P113 / GTIOC2A	PWM output (Vp) / Low Active
P111 / GTIOC3A	PWM output (Wp) / Low Active
P414 / GTIOC0B	PWM output (Un) / High Active
P114 / GTIOC2B	PWM output (Vn) / High Active
P112 / GTIOC3B	PWM output (Wn) / High Active
P503 / GTETRGC	PWM emergency stop input at the time of overcurrent detection

2.2.2 Peripheral functions

List of the peripheral functions used in this system is given in Table 2-4.

Table 2-4 List of the Peripheral Functions

Peripheral	Resource	Purpose
12-bit A/D Converter	AN000, AN001, AN002, AN005, AN017	<ul style="list-style-type: none"> • Measure electric current of each phase U, V, and W • Measure inverter bus voltage • Rotational speed or position command input
AGT	AGT0	500 [μ s] interval timer
GPT	CH0, CH2, CH3	Complementary PWM outputs
POEG	Group C	Sets ports executing PWM output to high impedance state when an overcurrent is detected by external circuit.

(1) 12-bit A/D Converter (12ADC)

U-phase current (I_u), V-phase current (I_v), W-phase current (I_w), inverter bus voltage1 (V_{dc}), and speed command (VR) are measured in "Single scan mode" (use a hardware trigger).

A/D conversion is implemented to be synchronized with carrier synchronized interrupt as GPT underflow (PWM valley).

g_adc0 ADC (r_adc)		
Settings	Property	Value
API Info	▼ Common	
	Parameter Checking	Default (BSP)
	▼ Module g_adc0 ADC (r_adc)	
	▼ General	
	Name	g_adc0
	Unit	0
	Resolution	🔒 12-Bit
	Alignment	🔒 Right
	Clear after read	On
	Mode	🔒 Single Scan
	Double-trigger	Disabled
	> Input	
	▼ Interrupts	
	Normal/Group A Trigger	GPT0 COUNTER UNDERFLOW (Underflow)
	Group B Trigger	Disabled
	Group Priority (Valid only in Group Scan Mode)	Group A cannot interrupt Group B
	Callback	rm_motor_driver_cyclic
	Scan End Interrupt Priority	Priority 5
	Scan End Group B Interrupt Priority	Disabled
	Window Compare A Interrupt Priority	Disabled
	Window Compare B Interrupt Priority	Disabled
	> Extra	
	> Pins	

Figure 2-2 FSP Configuration of ADC Driver (FSP 3.5.0)

(2) Low Power Asynchronous General-Purpose Timer (AGT)

The AGT is used as 500 [μs] interval timer.

g_timer0 Timer, Low-Power (r_agt)		
Settings	Property	Value
API Info	<ul style="list-style-type: none"> ▼ Common Parameter Checking Pin Output Support Pin Input Support ▼ Module g_timer0 Timer, Low-Power (r_agt) <ul style="list-style-type: none"> ▼ General <ul style="list-style-type: none"> Name Channel Mode Period Period Unit Count Source > Output > Input ▼ Interrupts <ul style="list-style-type: none"> Callback Underflow Interrupt Priority > Pins 	<ul style="list-style-type: none"> Default (BSP) Disabled Disabled g_timer0 0 🔒 Periodic 0x752f Raw Counts PCLKB 🔒 rm_motor_speed_cyclic Priority 10

Figure 2-3 FSP Configuration of AGT Driver (FSP 3.5.0)

(3) General PWM Timer (GPT)

On the channel 0, 2, and 3, output with dead time is performed by using the complementary PWM Output Operating Mode.

g_timer1 Timer, General PWM (r_gpt)		
Settings	Property	Value
API Info	▼ Common	
	Parameter Checking	Default (BSP)
	Pin Output Support	Enabled with Extra Features
	Write Protect Enable	Disabled
	Clock Source	PCLKD
	▼ Module g_timer1 Timer, General PWM (r_gpt)	
	▼ General	
	Name	g_timer1
	Channel	0
	Mode	Triangle-Wave Symmetric PWM
	Period	50
	Period Unit	Microseconds
	▼ Output	
	> Custom Waveform	
	Duty Cycle Percent (only applicable in PWM mode)	50
	GTIOCA Output Enabled	True
	GTIOCA Stop Level	Pin Level High
	GTIOCB Output Enabled	True
	GTIOCB Stop Level	Pin Level High
	> Input	
	> Interrupts	
	▼ Extra Features	
	▼ Output Disable	
	> Output Disable POEG Trigger	
	POEG Link	POEG Channel 2
	GTIOCA Disable Setting	Set Hi Z
	GTIOCB Disable Setting	Set Hi Z
	> ADC Trigger	
	▼ Dead Time	
	Dead Time Count Up (Raw Counts)	240
	Dead Time Count Down (Raw Counts) (GPTE/GPTEH)	240
	> ADC Trigger (GPTE/GPTEH only)	
	> Interrupt Skipping (GPTE/GPTEH only)	
	Extra Features	Enabled
	> Pins	

Figure 2-4 FSP Configuration of GPT Driver (FSP 3.5.0)

(4) Port Output Enable for GPT (POEG)

The port executing PWM output are set to high impedance state when an overcurrent is detected (when a low level of the GTETRGC port is detected)

g_poeg0 Port Output Enable for GPT (r_poeg)		
Settings	Property	Value
API Info	▼ Common	
	Parameter Checking	Default (BSP)
	▼ Module g_poeg0 Port Output Enable for GPT (r_poeg)	
	▼ General	
	▼ Trigger	
	GTETRGC Pin	<input checked="" type="checkbox"/>
	GPT Output Level	<input type="checkbox"/>
	Oscillation Stop	<input type="checkbox"/>
	ACMPHS0	<input type="checkbox"/>
	ACMPHS1	<input type="checkbox"/>
	ACMPHS2	<input type="checkbox"/>
	ACMPHS3	<input type="checkbox"/>
	ACMPHS4	<input type="checkbox"/>
	ACMPHS5	<input type="checkbox"/>
	Name	g_poeg0
	Channel	2
	▼ Input	
	GTETRGC Polarity	Active Low
	GTETRGC Noise Filter	Disabled
	▼ Interrupts	
	Callback	g_poe_overcurrent
	Interrupt Priority	Priority 0 (highest)
	> Pins	

Figure 2-5 FSP Configuration of POEG Driver (FSP 3.5.0)

2.3 Software configuration

2.3.1 Software file configuration

Folder and file configuration of the software is given below.

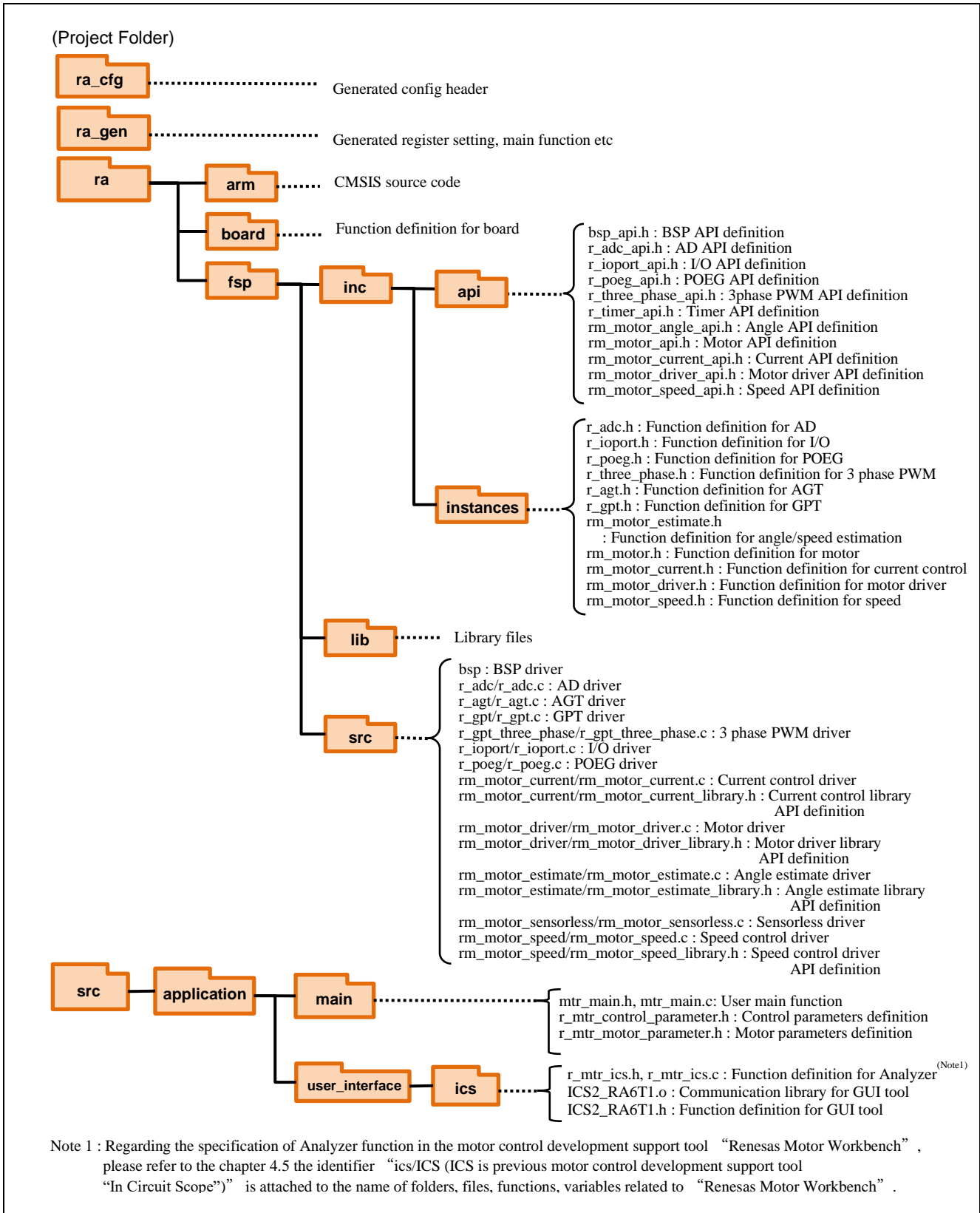

Note 1 : Regarding the specification of Analyzer function in the motor control development support tool “Renesas Motor Workbench” , please refer to the chapter 4.5 the identifier “ics/ICS (ICS is previous motor control development support tool “In Circuit Scope”)” is attached to the name of folders, files, functions, variables related to “Renesas Motor Workbench” .

Figure 2-6 Folder and file configuration

2.3.2 Module configuration

Module configuration of the software is described below.

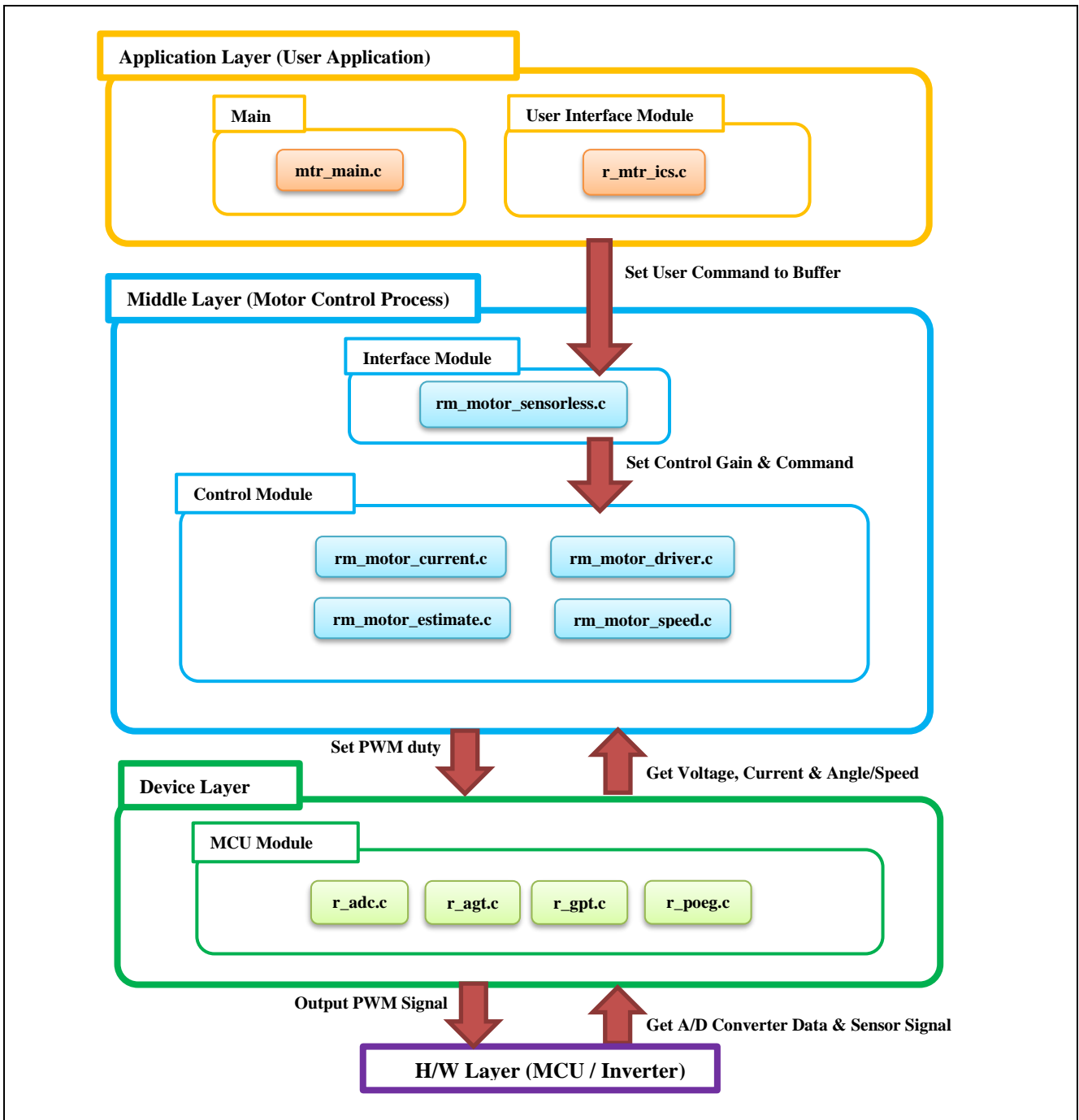

Figure 2-7 Module Configuration

2.4 Software specifications

Table 2-5 shows basic software specification of this system. For details of the sensorless vector control, refer to the application note 'Sensorless vector control for permanent magnet synchronous motor (Algorithm)' (R01AN3786).

Table 2-5 Basic Specifications of Sensorless Vector Control Software

Item	Content	
Control method	Vector control	
Position detection method	Sensorless	
Motor rotation start/stop	SW1 input or input from 'Renesas Motor Workbench'	
Input voltage	DC 24 [V]	
Main clock frequency	120 [MHz]	
Carrier frequency (PWM)	20 [kHz] (Carrier period: 50 [μs])	
Dead time	2 [μs]	
Control period	Current control / Position and speed estimation: 50 [μs] (the carrier period) Speed control: 500 [μs]	
Rotation speed control range	CW: 0 [rpm] to 2650 [rpm] CCW: 0 [rpm] to 2650 [rpm] However, 600 [rpm] or less is driven by a speed open loop.	
Natural frequency of each control system	Current control system : 300 [Hz] Speed control system : 5 [Hz] BEMF estimation system : 1000 [Hz] Position estimation system : 50 [Hz]	
Optimization setting of compiler	Optimization level	Optimize more(-O2) (default setting)
Processing stop for protection	Disables the motor control signal output (six outputs), under any of the following conditions. <ol style="list-style-type: none"> 1. Instantaneous value of current of any phase exceeds $0.89(=0.42 \times \sqrt{2}) \times 1.5$ [A] (monitored every 50 [μs]) 2. Inverter bus voltage exceeds 28 [V] (monitored every 50 [μs]) 3. Inverter bus voltage is less than 14 [V] (monitored every 50 [μs]) 4. Rotation speed exceeds 3000 [rpm] (monitored every 50 [μs]) <p>When an external over current signal is detected (when a low level of the GTETRGC port is detected), the PWM output ports are set to high impedance state.</p>	

2.5 Interrupt Priority

Table 2-6 shows the interrupt and priorities used in this system.

Table 2-6 Interrupt priority

Interrupt level	Priority	function
15	Min	
14		
13		
12		
11		
10		500 [usec] Interrupt handling
9		
8		
7		
6		
5		A/D conversion complete interrupt
4		
3		
2		
1		
0	Max	Over current error interrupt

Allocations		
Interrupt	Event	ISR
0	AGT0 INT (AGT interrupt)	agt_int_isr
1	ADC0 SCAN END (A/D scan end interrupt)	adc_scan_end_isr
2	POEG2 EVENT (Port Output disable interrupt C)	poeg_event_isr

Figure 2-8 FSP Interrupts Configuration (FSP 3.5.0)

3. Descriptions of the control program

The target software of this application note is explained here.

3.1 Contents of control

3.1.1 Motor start/stop

Starting and stopping of the motor are controlled by input from 'Renesas Motor Workbench' or SW1.

A general-purpose port is assigned to SW1 and based upon its level the motor operation is controlled.

"Low" level → Motor Start

"High" level → Motor Stop

3.1.2 A/D Converter

(1) Motor rotation speed reference

The rotation speed command value of the motor is determined from the input from 'Renesas Motor Workbench' or the output value (analog value) of VR1. Rotation speed command value from VR1 is measured as shown in the table below.

Table 3-1 Conversion Ratio of the Rotation Speed Reference

Item	Conversion ratio (reference: A/D conversion value)		Channel
Rotation speed reference	CW	0 rpm to 2650 rpm: 0800H to 0FFFH	AN017
	CCW	0 rpm to 2650 rpm: 07FFH to 0000H	

(2) Inverter bus voltage

Inverter bus voltage is measured as shown in the table below. It is used for calculation of modulation rate and detection of overvoltage and undervoltage (PWM stops in case of abnormality).

Table 3-2 Inverter Bus Voltage Conversion Ratio

Item	Conversion ratio (Inverter bus voltage: A/D conversion value)	Channel
Inverter bus voltage	0 [V] to 111 [V]: 0000H to 0FFFH	AN005

(3) U, W phase current

The U, V and W phase currents are measured as shown in Table 3-3 and used for vector control. User can select only U and W phase currents to use as 2shunt resistances detection.

Table 3-3 Conversion Ratio of U, V and W Phase Current

Item	Conversion ratio (U, V, W phase current: A/D conversion value)	Channel
U, W phase current	-12.5 [A] to 12.5 [A]: 0000H to 0E8BH ^(Note) $\text{Current} = (5.0\text{V} - 2.5\text{V}) / (0.01\text{Ohm} * 20) = 12.5\text{A}$ In this system, the current detection circuit shifts the level from 5V to 3V, so 0E8BH is the upper limit of A / D conversion.	Iu: AN000 Iv: AN001 Iw: AN002

Note: For more details of A/D conversion characteristics, refer to "RA6T1 Group User's Manual: Hardware".

3.1.3 Modulation

The target software of this application note uses pulse width modulation (hereinafter called PWM) to generate the input voltage to the motor. And the PWM waveform is generated by the triangular wave comparison method.

(1) Triangular wave comparison method

The triangular wave comparison method is used to output the voltage command value. By this method, the pulse width of the output voltage can be determined by comparing the carrier waveform (triangular wave) and voltage command value waveform. The voltage command value of the pseudo sinusoidal wave can be output by turning the switch on or off when the voltage command value is larger or smaller than the carrier wave respectively.

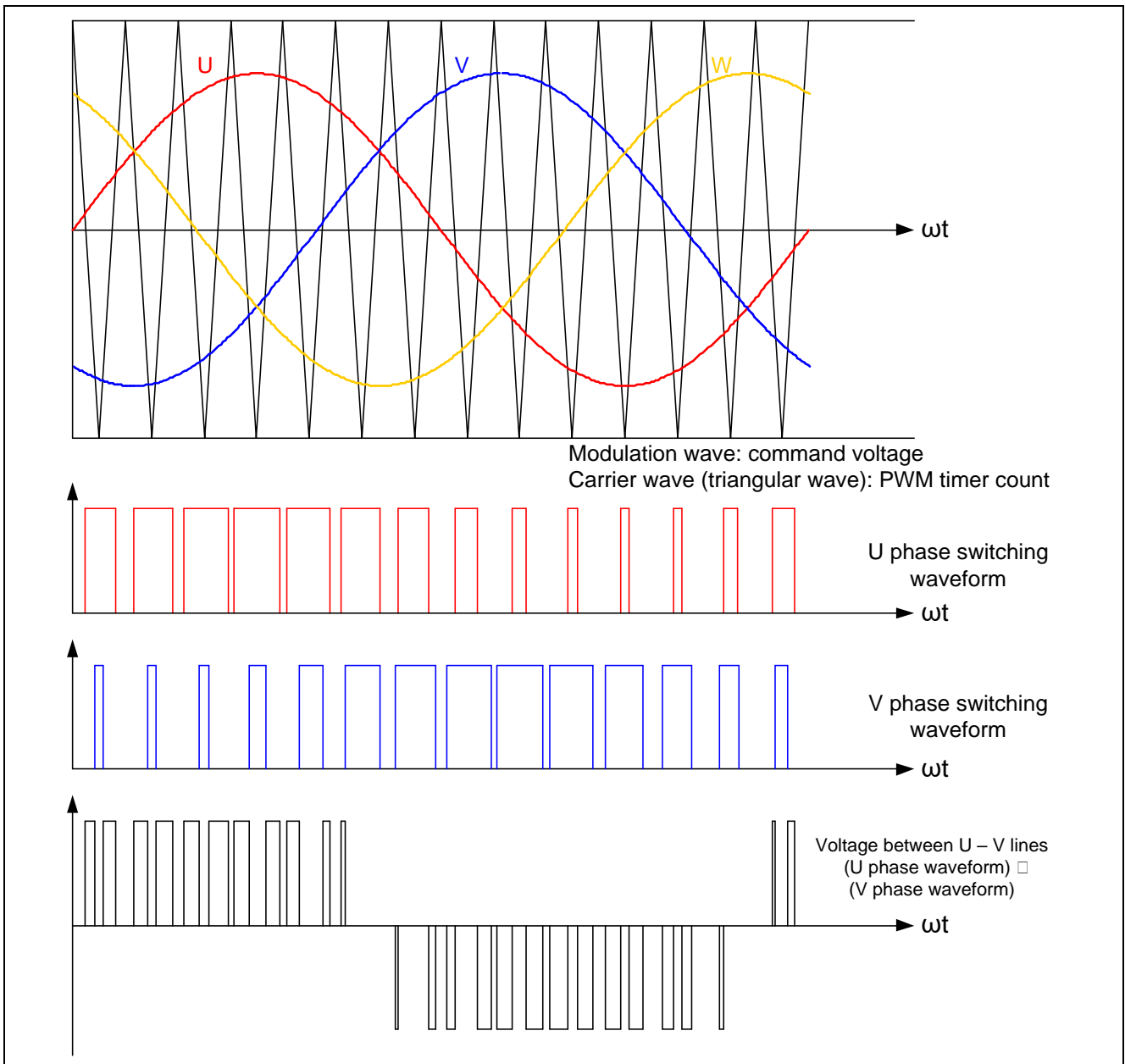

Figure 3-1 Conceptual Diagram of the Triangular Wave Comparison Method

As shown in the Figure 3-2, ratio of the output voltage pulse to the carrier wave is called duty.

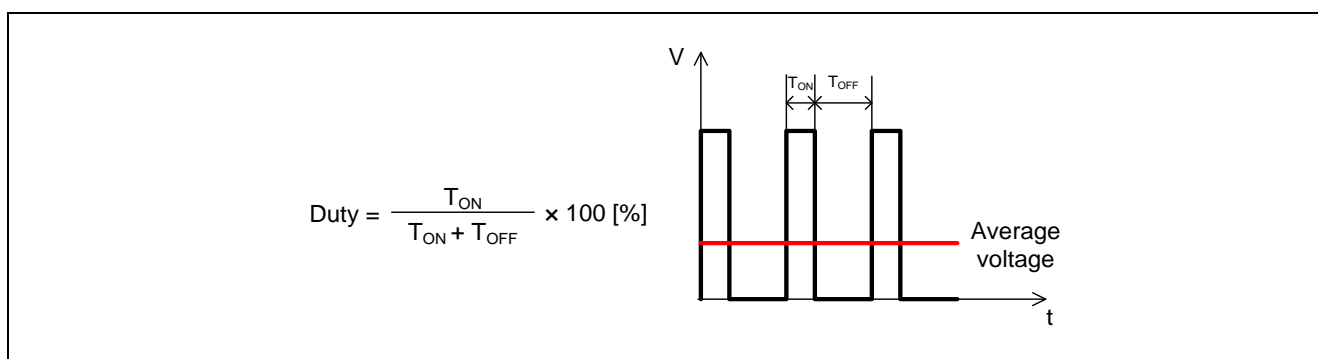

Figure 3-2 Definition of Duty

Modulation factor “m” is defined as follows.

$$m = \frac{V}{E}$$

m: Modulation factor V: Command value voltage E: Inverter bus voltage

A requested control can be performed by setting this modulation factor to the register which determines PWM duty.

3.1.4 State transition

Figure 3-3 is a state transition diagram of the sensorless vector control software. In the target software of this application note, the software state is managed by “SYSTEM MODE”.

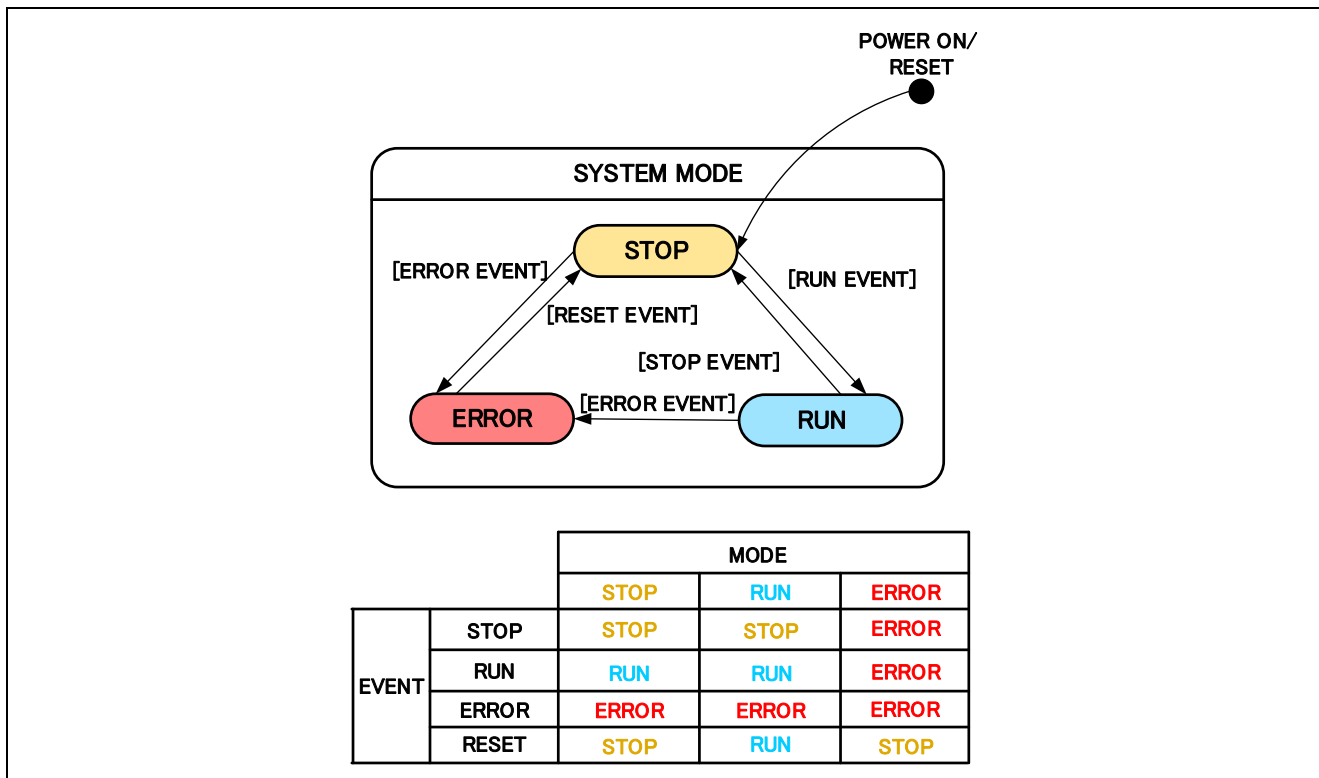

Figure 3-3 State Transition Diagram of Sensorless Vector Control Software

(1). SYSTEM MODE

“SYSTEM MODE” indicates the operating states of the system. The state transits on occurrence of each event (EVENT). “SYSTEM MODE” has 3 states that are motor drive stop (INACTIVE), motor drive (ACTIVE), and abnormal condition (ERROR).

(2). EVENT

When “EVENT” occurs in each “SYSTEM MODE”, “SYSTEM MODE” changes as shown the table in Figure 3-3, according to that “EVENT”. The occurrence factors of each event are shown below.

Table 3-4 List of EVENT

EVENT name	occurrence factor
STOP	by user operation
RUN	by user operation
ERROR	when the system detects an error
RESET	by user operation

3.1.5 Start-up method

Figure 3-4 shows startup control of sensorless vector control software. Each mode is controlled by flags managing each reference of the d-axis current, q-axis current, and speed.

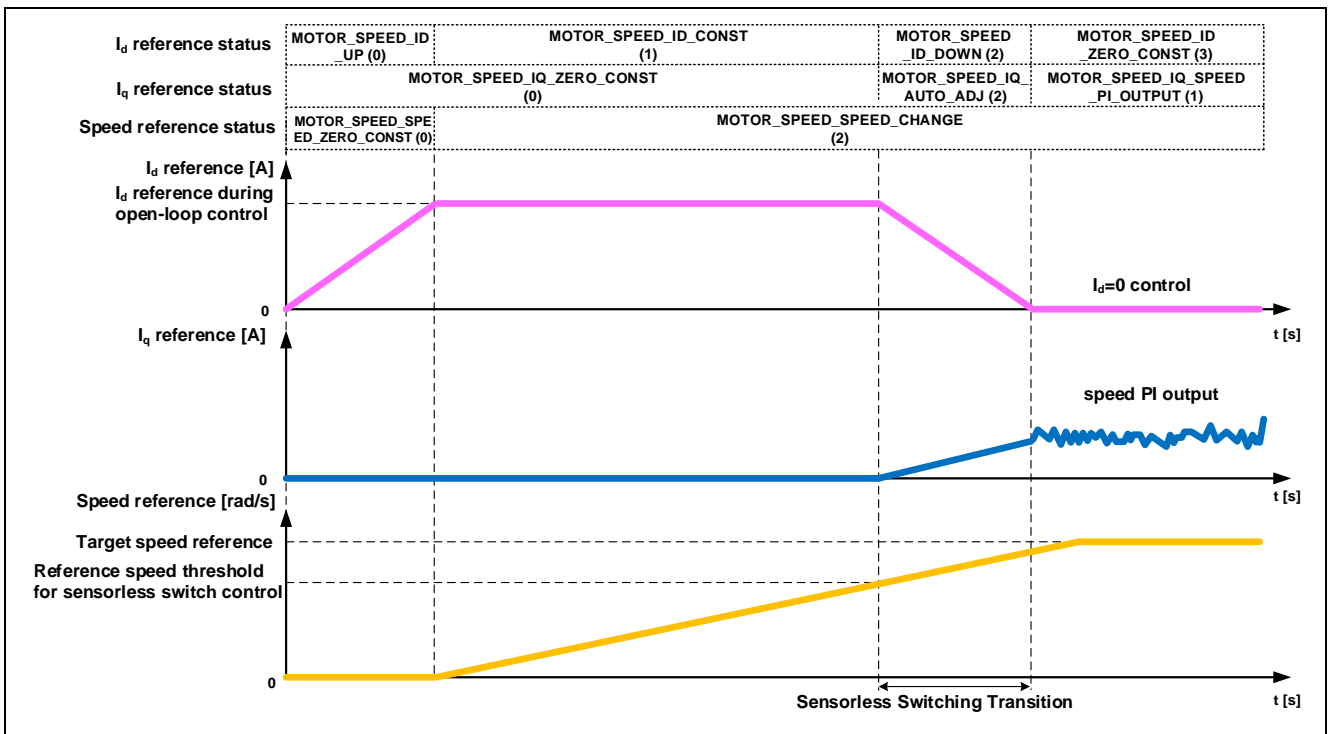

Figure 3-4 Startup Control of Sensorless Vector Control Software

3.1.6 System protection function

This control software has the following error status and executes emergency stop functions in case of occurrence of respective errors. Table 3-5 shows each software threshold for the system protection function.

- Over current error

There are two kind of overcurrent protection.

Hardware OCP: When emergency stop signal from the hardware is detected, PWM output ports are automatically set to high impedance output (without software intervention).

Software OCP: U, V, and W phase currents are monitored in over current monitoring cycle. When an over current is detected, the CPU executes emergency stop.

- Over voltage error

The inverter bus voltage is monitored in over voltage monitoring cycle. When an over voltage is detected (when the voltage exceeds the over voltage limit), the CPU performs emergency stop. Here, the over voltage limit is set in consideration of the error of resistance value of the detect circuit. When this error occurs, the CPU performs emergency stop in the side of the motor in which the error occurred.

- Low voltage error

The inverter bus voltage is monitored in low-voltage monitoring cycle. The CPU performs emergency stop when low voltage (when voltage falls below the limit) is detected. Here, the low voltage limit is set in consideration of the error of resistance value of the detect circuit. When this error occurs, the CPU performs emergency stop in the side of the motor in which the error occurred.

- Over speed error

The rotation speed is monitored in rotation speed monitoring cycle. The CPU performs emergency stop when the speed is over the limit. When this error occurs, the CPU performs emergency stop in the side of the motor in which the error occurred.

Table 3-5 Setting Values of the System Protection Function

Error name	Threshold	
Over current error	Over current limit [A]	0.89
	Monitoring cycle [μ s]	50
Over voltage error	Over voltage limit [V]	28
	Monitoring cycle [μ s]	50
Low voltage error	Low voltage limit [V]	14
	Monitoring cycle [μ s]	50
Over speed error	Speed limit [rpm]	3000
	Monitoring cycle [μ s]	50

3.1.7 AD triggers

Shows the timing of AD triggers and scan groups.

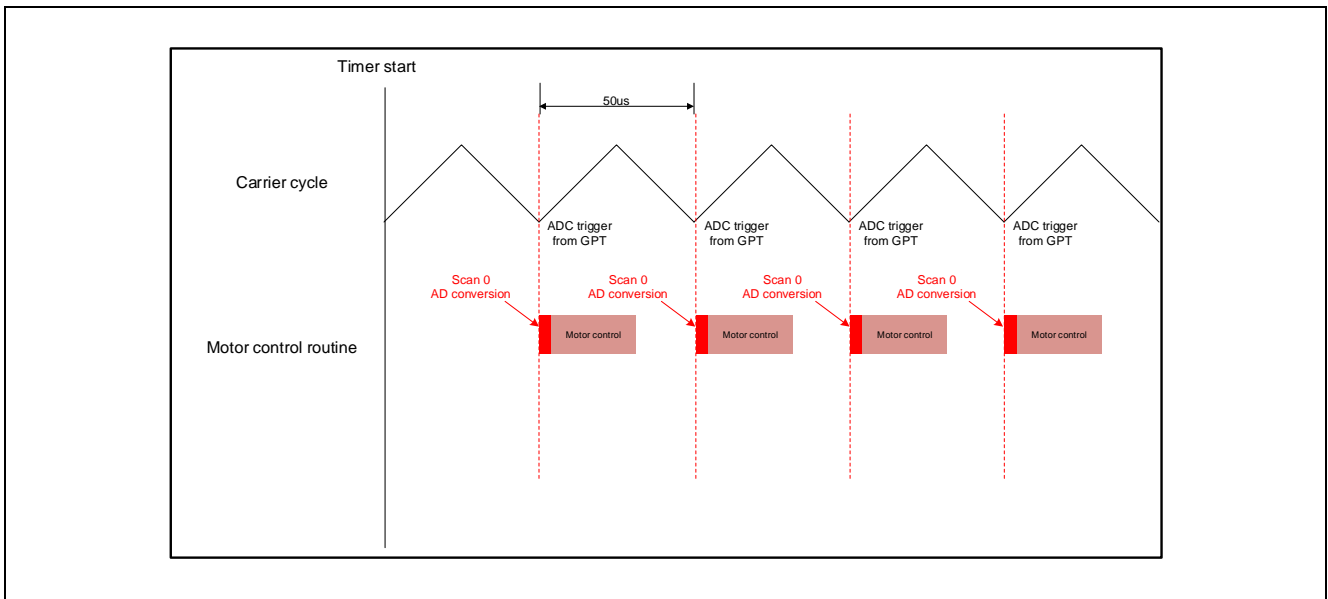

Figure 3-5 AD trigger timing

3.2 Function specifications of sensorless vector control software

The control process of the target software of this application note is mainly consisted of 50[μs] period interrupt (carrier interrupt) and 500[μs] period interrupt. As following Figure 3-6 and Figure 3-7, the control process in the red broken line part is executed every 50[μs] cycle, and the control process in the blue broken line part is executed every 500[μs] cycle.

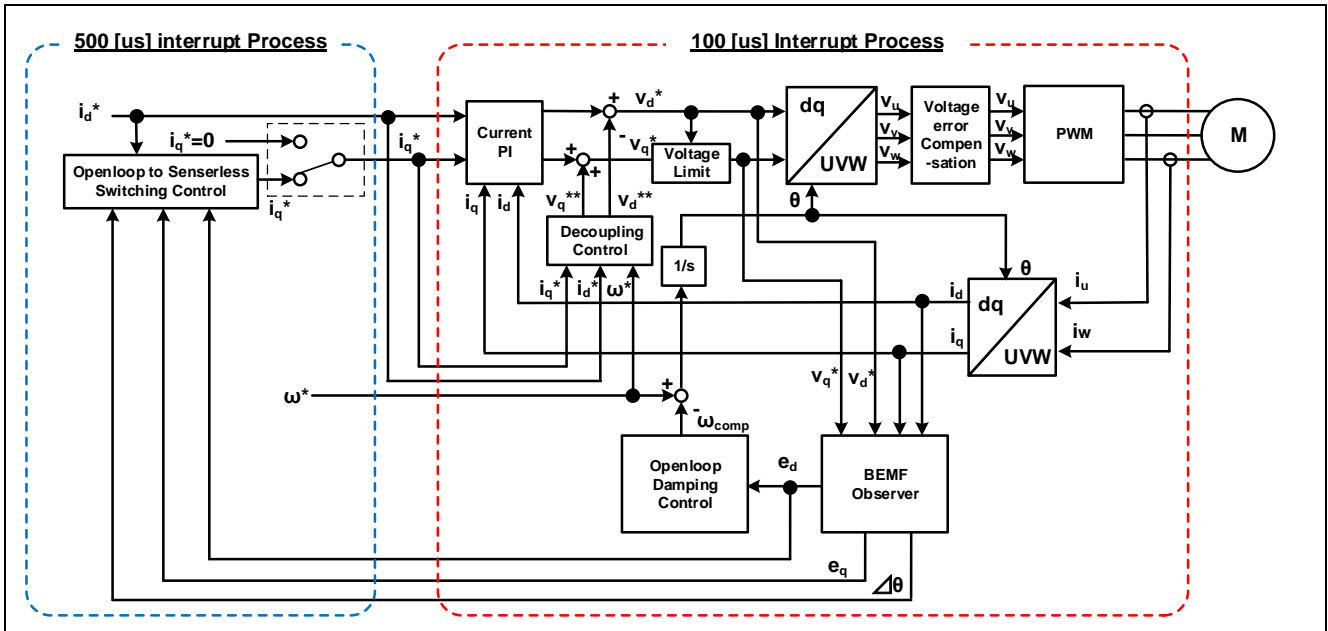

Figure 3-6 Block Diagram of Sensorless Vector Control (Openloop Control)

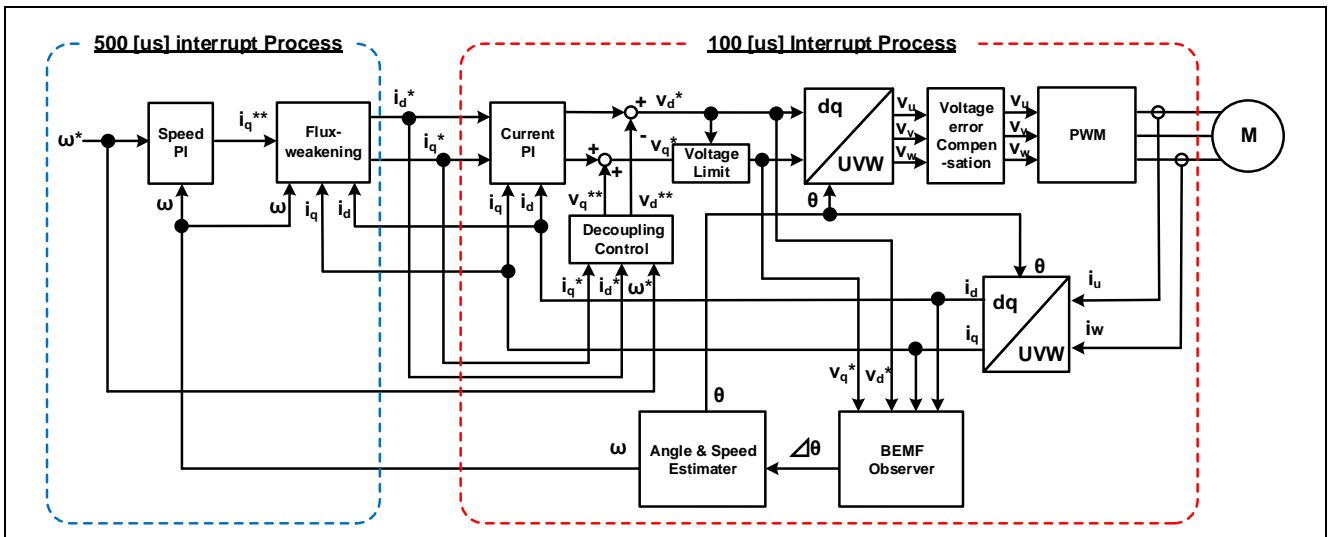

Figure 3-7 Block Diagram of Sensorless Vector Control (Sensorless Control)

This chapter shows the specification of 2 interrupt functions and functions executed in each interrupt cycle. In following tables, only primary functions of the sensorless vector control are listed. Regarding the specification of functions not listed in following tables, refer to source codes.

Table 3-6 List of Functions Executed in 50[μs] Period Interrupt (1/4)

File name	Function name	Process overview
mtr_main.c	mtr_callback_event0 Input : (motor_sensorless_callback_args_t *) p_args / Callback argument Output : None	Sensorless control callback function
	mtr_callback_event1 Input : (motor_sensorless_callback_args_t *) p_args / Callback argument Output :None	Sensorless control callback function
rm_motor_sensorless.c	rm_motor_sensorless_current_callback Input : (motor_current_callback_args_t *) p_args / Callback argument Output :None	Set the speed control output to the current control input
	RM_MOTOR_SENSORLESS_ErrorCheck Input : (motor_ctrl_t * const) p_ctrl / Pointer to control structure. (uint16_t * const) p_error / Pointer to get occurred error Output : fsp_err_t / Execution result	Check the occurrence of Error.
	rm_motor_sensorless_copy_speed_current Input : (motor_speed_output_t *) st_output / Pointer to the structure of Speed Control output (motor_current_input_t *) st_input / Pointer to the structure of Current Control input Output :None	Copy speed output data to current input data
rm_motor_driver.c	rm_motor_driver_cyclic Input : (adc_callback_args_t *) p_args / Callback argument Output :None	Motor driver callback function
	rm_motor_driver_current_get Input : (motor_driver_instance_ctrl_t *) p_ctrl / The pointer to the motor driver module instance Output :None	Get A/D converted data (Phase Current & Main Line Voltage)
	RM_MOTOR_DRIVER_FlagCurrentOffsetGet Input : (motor_driver_ctrl_t * const) p_ctrl / Pointer to control structure (uint8_t * const) p_flag_offset / Flag of finish current offset detection Output : fsp_err_t / Execution result	Measure current offset values
	RM_MOTOR_DRIVER_PhaseVoltageSet Input : (motor_driver_ctrl_t * const) p_ctrl / Pointer to control structure (float const) u_voltage / U phase voltage (float const) v_voltage / V phase voltage (float const) w_voltage / W phase voltage Output : fsp_err_t / Execution result	Set Phase Voltage Data to calculate PWM duty.
	rm_motor_driver_modulation Input : (motor_driver_instance_ctrl_t *) p_ctrl / The pointer to the motor driver module instance Output :None	Perform PWM modulation

Table 3-7 List of Functions Executed in 50[μs] Period Interrupt (2/4)

File name	Function name	Process overview
rm_motor_driver.c	rm_motor_driver_mod_run Input : (motor_driver_modulation_t *) p_mod / Pointer to the modulation data structure (const float *) p_f4_v_in / Pointer to the 3-phase input voltage (float *) p_f4_duty_out / Where to store the 3-phase output duty cycle Output :None	Calculates duty cycle from input 3-phase voltage (bipolar)
	rm_motor_driver_set_uvw_duty Input : (motor_driver_instance_ctrl_t *) p_ctrl / Pointer to Motor Driver instance (float) f_duty_u / The duty cycle of Phase-U (float) f_duty_v / The duty cycle of Phase-V (float) f_duty_w / The duty cycle of Phase-W Output : fsp_err_t / Execution result	PWM duty setting
	RM_MOTOR_DRIVER_CurrentGet Input : (motor_driver_ctrl_t * const) p_ctrl / Pointer to control structure (motor_driver_current_get_t * const) p_current_get / Pointer to get data structure Output : fsp_err_t / Execution result	Get calculated phase Current, Vdc & Va_max data
rm_motor_current.c	rm_motor_current_cyclic Input : (motor_driver_callback_args_t *) p_args / Callback argument Output :None	Current control cycle operation
	RM_MOTOR_CURRENT_ParameterSet Input : (motor_current_ctrl_t * const) p_ctrl / Pointer to control structure (motor_current_input_current_t const * const) p_st_input / Pointer to input data structure Output : fsp_err_t / Execution result	Set (Input) Parameter Data.
	RM_MOTOR_CURRENT_CurrentSet Input : (motor_current_ctrl_t * const) p_ctrl / Pointer to control structure (motor_current_input_current_t const * const) p_st_current / Pointer to input current structure (motor_current_input_voltage_t const * const) p_st_voltage / Pointer to input voltage structure Output : fsp_err_t / Execution result	Set d/q-axis Current & Voltage Data.
	RM_MOTOR_CURRENT_CurrentGet Input : (motor_current_ctrl_t * const) p_ctrl / Pointer to control structure (float * const) p_id / Pointer to get d-axis current (float * const) p_iq / Pointer to get q-axis current Output : fsp_err_t / Execution result	Get d/q-axis Current.
	motor_current_transform_uvw_dq_abs Input : (const float) f_angle / rotor angle (const float *) f_uvw / the pointer to the UVW-phase array in [U,V,W] format (float *) f_dq / where to store the [d,q] formatted array on dq coordinates Output :None	Coordinate transform UVW to dq (absolute transform)

Table 3-8 List of Functions Executed in 50[μs] Period Interrupt (3/4)

File name	Function name	Process overview
rm_motor_current.c	motor_current_angle_cyclic Input : (motor_current_instance_t *) p_instance / The pointer to current control module control instance Output :None	Angle/Speed Process in Cyclic Process of Current Control
	RM_MOTOR_CURRENT_SpeedPhaseSet Input : (motor_current_ctrl_t * const) p_ctrl / Pointer to control structure (float const) speed_rad / Rotational speed (float const) phase_rad / Rotor phase Output : fsp_err_t / Execution result	Set Current Speed & rotor phase Data.
	RM_MOTOR_CURRENT_CurrentReferenceSet Input : (motor_current_ctrl_t * const) p_ctrl / Pointer to control structure (float const) speed_rad / D-axis current Reference (float const) phase_rad / Q-axis current Reference Output : fsp_err_t / Execution result	Set Current Reference Data
	RM_MOTOR_CURRENT_PhaseVoltageGet Input : (motor_current_ctrl_t * const) p_ctrl / Pointer to control structure (motor_current_get_voltage_t * const) p_voltage / Pointer to get Voltages Output : fsp_err_t / Execution result	Gets the set phase voltage.
	motor_current_pi_calculation Input : (motor_current_instance_ctrl_t *) p_instance / The pointer to the FOC current control structure Output :None	Calculates the output voltage vector from current vector command and actual current vector
	motor_current_pi_control Input : (motor_current_pi_params_t *) pi_ctrl / The pointer to the PI control structure Output : float / PI control output value	PI control
	motor_current_limit_abs Input : (float) f4_value / Target value (float) f4_limit_value / Limit Output : float / Limited value	Limit with absolute value
	motor_current_decoupling Input : (motor_current_instance_ctrl_t *) p_ctrl / The pointer to the FOC current control instance (float) f_speed_rad / The electrical speed (const motor_current_motor_parameter_t *) p_mtr / The pointer to the motor parameter data structure Output :None	Decoupling control
	motor_current_voltage_limit Input : (motor_current_instance_ctrl_t *) p_ctrl / The pointer to the FOC current control structure Output :None	Limit voltage vector

Table 3-9 List of Functions Executed in 50[μs] Period Interrupt (4/4)

File name	Function name	Process overview
rm_motor_current.c	motor_current_transform_dq_uv_w_abs Input : (const float) f_angle / Rotor angle (const float *) f_dq / The pointer to the dq-axis value array in [D,Q] format (float *) f_uv_w / Where to store the [U,V,W] formatted 3-phase quantities array Output :None	Coordinate transform dq to UVW 3-phase (absolute transform)
librm_motor_current.a	rm_motor_voltage_error_compensation_main Input : (motor_currnt_voltage_compensation_t *) st_volt_comp / Voltage error compensation data (float *) p_f4_v_array / Reference voltage (float *) p_f4_i_array / Reference current (float) f4_vdc / Bus voltage Output :None	Voltage error compensation
rm_motor_estimate.c	RM_MOTOR_ESTIMATE_FlagPiCtrlSet Input : (motor_angle_ctrl_t * const) p_ctrl / Pointer to control structure (uint32_t const) flag_pi / The flag of PI control runs Output : fsp_err_t / Execution result	Set the flag of PI Control runs.
	RM_MOTOR_ESTIMATE_SpeedSet Input : (motor_angle_ctrl_t * const) p_ctrl / Pointer to control structure (float const) speed_ctrl / Control reference of rotational speed (float const) damp_speed / Damping rotational speed Output : fsp_err_t / Execution result	Set Speed Information
	RM_MOTOR_ESTIMATE_CurrentSet Input : (motor_angle_ctrl_t * const) p_ctrl / Pointer to control structure (motor_angle_current_t * const) p_st_current / Pointer to current structure (motor_angle_voltage_reference_t * const) p_st_voltage / Pointer to voltage Reference structure Output : fsp_err_t / Execution result	Set d/q-axis Current Data & Voltage Reference.
	RM_MOTOR_ESTIMATE_AngleSpeedGet Input : (motor_angle_ctrl_t * const) p_ctrl / Pointer to control structure (float * const) p_angle / Memory address to get rotor angle data (float * const) p_speed / Memory address to get rotational speed data (float * const) p_phase_err / Memory address to get phase(angle) error data Output : fsp_err_t / Execution result	Gets the current rotor's angle and rotation speed.
	RM_MOTOR_ESTIMATE_EstimatedComponentGet Input : (motor_angle_ctrl_t * const) p_ctrl / Pointer to control structure (float * const) p_ed / Memory address to get estimated d-axis component (float * const) p_eq / Memory address to get estimated q-axis component Output : fsp_err_t / Execution result	Gets estimated d/q-axis component.
r_gpt_three_phase.c	R_GPT_THREE_PHASE_DutyCycleSet Input : (three_phase_ctrl_t * const) p_ctrl / Control block set in @ref three_phase_api_t::open call for this timer (three_phase_duty_cycle_t * const) p_duty_cycle / Duty cycle values for all three timer channels Output : fsp_err_t / Execution result	Sets duty cycle for all three timers.

Table 3-10 List of Functions Executed in 500[μs] Interrupt (1/2)

File name	Function name	Process overview
mtr_main.c	mtr_callback_event0 Input : (motor_sensorless_callback_args_t *) p_args / Callback argument Output :None	Sensorless control callback function
	mtr_callback_event1 Input : (motor_sensorless_callback_args_t *) p_args / Callback argument Output :None	Sensorless control callback function
	get_vr1 Input :None Output : uint16_t / conversion value	Get VR1 A/D conversion value
rm_motor_current.c	RM_MOTOR_CURRENT_ParameterGet Input : (motor_current_ctrl_t * const) p_ctrl / Pointer to control structure (motor_current_input_current_t const * const) p_st_input / Pointer to output data structure Output : fsp_err_t / Execution result	Get speed control input data from current control
rm_motor_sensorless.c	rm_motor_sensorless_speed_callback Input : (motor_speed_callback_args_t *) p_args / Callback argument Output :None	Speed control callback function
	rm_motor_sensorless_copy_current_speed Input : (motor_current_output_t *) st_output / Pointer to the structure of Current Control output (motor_speed_input_t *) st_input / Pointer to the structure of Speed Control input Output :None	Copy current output data to speed input data
rm_motor_speed.c	rm_motor_speed_cyclic Input : (timer_callback_args_t *) p_args/ Callback argument Output :None	Cyclic process of Speed Control (Call at timer interrupt)
	RM_MOTOR_SPEED_ParameterSet Input : (motor_speed_ctrl_t * const) p_ctrl / Pointer to control structure (motor_speed_input_t const * const) p_st_input / Pointer to structure to input parameters Output : fsp_err_t / Execution result	Set speed Input parameters
	RM_MOTOR_SPEED_SpeedControl Input : (motor_speed_ctrl_t * const) p_ctrl / Pointer to control structure Output : fsp_err_t / Execution result	Calculates the d/q-axis current reference.(Main process of Speed Control)
	rm_motor_speed_set_speed_ref Input : (motor_speed_instance_ctrl_t *) p_ctrl / The pointer to the FOC data instance Output : float / Speed reference	Updates the speed reference
	rm_motor_speed_set_iq_ref Input : (motor_speed_instance_ctrl_t *) p_ctrl / The pointer to the ctrl instance Output : float / Iq reference	Updates the q-axis current reference
	rm_motor_speed_set_id_ref Input : (motor_speed_instance_ctrl_t *) p_ctrl / The pointer to the ctrl instance Output : float / Id reference	Updates the d-axis current reference
	RM_MOTOR_SPEED_ParameterGet Input : (motor_speed_ctrl_t * const) p_ctrl / The pointer to the ctrl instance (motor_speed_output_t * const) p_st_output / Pointer to get speed control parameters Output : fsp_err_t / Execution result	Get speed control output parameters

Table 3-11 List of Functions Executed in 500[μs] Interrupt (2/2)

File name	Function name	Process overview
librm_motor_speed.a	rm_motor_speed_first_order_lpf Input : (motor_speed_lpf_t *) p_lpf / First order LPF structure (float) f4_omega / Natural frequency (float) f4_ctrl_period / Control period Output : None	First Order LPF
	rm_motor_speed_fluxwkn_set_vamax Input : (motor_speed_flux_weakening_t *) p_fluxwkn / The pointer to flux weakening structure (float) f4_va_max / maximum magnitude of voltage vector Output :None	Sets the maximum magnitude of voltage vector
	rm_motor_speed_fluxwkn_run Input : (motor_speed_flux_weakening_t *) p_fluxwkn / The pointer to flux weakening structure (float) f4_speed_rad / The electrical speed of motor (const float *) p_f4_idq / The pointer to the measured current vector in format d/q (float *) p_f4_idq_ref / The pointer to the reference current vector in format d/q Output :None	Executes the flux-weakening module

3.3 Contents of control

3.3.1 Configuration Options

The configuration options of the sensorless vector control module for motor can be configured using the RA Configurator. The changed options are automatically reflected to the `rm_motor_sensorless_cfg.h` when generating code. The option names and setting values are listed in the Table 3-12 shown as follows.

Table 3-12 Configuration Options for sensorless module

Configuration Options (rm_motor_sensorless.h)	
Options	Description
Limit of over current (A) Initial: 0.42F	When a phase current exceeds this value, PWM output ports are set to off.
Limit of over voltage (V) Initial: 28.0F	When an inverter voltage exceeds this value, PWM output ports are set to off.
Limit of over speed (rpm) Initial: 3000.0F	When a rotation speed exceeds this value, PWM output ports are set to off.
Limit of over speed (rpm) Initial: 14.0F	When an inverter voltage becomes below this value, PWM output ports are set to off.

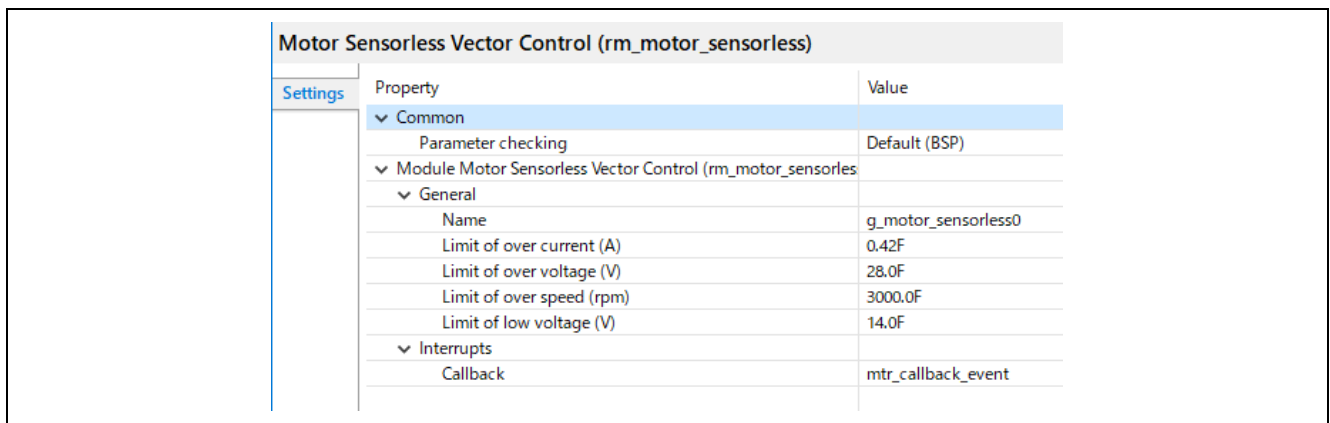

Motor Sensorless Vector Control (rm_motor_sensorless)	
Property	Value
▼ Common	
Parameter checking	Default (BSP)
▼ Module Motor Sensorless Vector Control (rm_motor_sensorless)	
▼ General	
Name	g_motor_sensorless0
Limit of over current (A)	0.42F
Limit of over voltage (V)	28.0F
Limit of over speed (rpm)	3000.0F
Limit of low voltage (V)	14.0F
▼ Interrupts	
Callback	mtr_callback_event

Figure 3-8 FSP Configuration of Motor sensorless vector control (FSP 3.5.0)

3.3.2 Configuration Options for included modules

The sensorless vector control module for motor includes below modules.

- Current Module
- Speed Module
- Angle Module
- Driver Module

And also these included modules have each configuration parameters as same as the sensorless vector control module. The option names and setting values are listed in the tables shown as follows.

Table 3-13 Configuration Options for Current Control

Configuration Options (rm_motor_current.h)	
Options	Description
Shunt type Initial: 2shunt	Selects how many shunt resistances to use current detection. Please set to "1shunt".
Input voltage (V) Initial: 24.0F	Input voltage [V]
Voltage error compensation Initial: Enable	Selects whether to "enable" or "disable" voltage error compensation.
Design Parameter Current PI loop omega Initial: 300.0F	Current PI control omega parameter [Hz].
Design Parameter Current PI loop zeta Initial: 1.0F	Current PI control zeta parameter.
Motor Parameter Pole pairs Initial: 2	Pole pairs of target motor.
Motor Parameter Resistance (ohm) Initial: 8.5F	Resistance of motor [ohm].
Motor Parameter Inductance of d-axis (H) Initial: 0.0045F	D-axis inductance [H].
Motor Parameter Inductance of d-axis (H) Initial: 0.0045F	Q-axis inductance [H].
Motor Parameter Permanent magnetic flux (Wb) Initial: 0.02159F	Magnetic flux [Wb].
Motor Parameter Rotor inertia (kgm^2) Initial: 0.0000028F	Rotor inertia [kgm^2].

Property	Value
Parameter Checking	Default (BSP)
Module: Motor Current Controller (rm_motor_current)	
General	
Name	g_motor_current0
Sensor type	🔒 Sensorless
Shunt type	2 shunt
Current control decimation	0
PWM carrier frequency (kHz)	20.0F
Input voltage (V)	24.0F
Sample delay compensation	Enable
Voltage error compensation	Enable
Voltage error compensation table of voltage 1	0.672F
Voltage error compensation table of voltage 2	0.945F
Voltage error compensation table of voltage 3	1.054F
Voltage error compensation table of voltage 4	1.109F
Voltage error compensation table of voltage 5	1.192F
Voltage error compensation table of current 1	0.013F
Voltage error compensation table of current 2	0.049F
Voltage error compensation table of current 3	0.080F
Voltage error compensation table of current 4	0.184F
Voltage error compensation table of current 5	0.751F
Interrupts	
Callback	🔒 rm_motor_sensorless_current_callback
Design Parameter	
Current PI loop omega (Hz)	300.0F
Current PI loop zeta	1.0F
Motor Parameter	
Pole pairs	2
Resistance (ohm)	8.5F
Inductance of d-axis (H)	0.0045F
Inductance of q-axis (H)	0.0045F
Permanent magnetic flux (Wb)	0.02159F
Rotor inertia (kgm^2)	0.0000028F

Figure 3-9 FSP Configuration of Motor Current Controller (FSP 3.5.0)

Table 3-14 Configuration Options for Speed Control [1/2]

Configuration Options (rm_motor_speed.h)	
Options	Description
Speed control period (sec) Initial: 0.0005F	The period of speed control process [sec].
Step of speed climbing (rpm) Initial: 0.5F	The step of speed fluctuation [rpm]. Program controls speed by this step at acceleration and deceleration.
Maximum rotational speed (rpm) Initial: 2650	Maximum rotational speed [rpm]
Speed LPF omega Initial: 10.0F	Speed LPF parameter omega [Hz].
Speed at Id climbing (rpm) Initial: 500.0F	The threshold speed to control d-axis current increase [rad/s]. Program increases d-axis current at start up the motor rotation until the speed reaches this value.
Limit of q-axis current (A) Initial: 0.42F	Limit of q-axis current [A].
Step of speed feedback at open-loop Initial: 0.20F	Rate of reference speed for feedback speed limiter at Open-Loop.
Open-loop damping Initial: Enable	Select enable/disable of damping control at Open-Loop.
Flux weakening Initial: Disable	Select enable/disable of flux weakening control at high speed.
Torque compensation for sensorless transition Initial: Enable	Select enable/disable of soft switching at the transition from Open-Loop to PI control.

Table 3-15 Configuration Options for Speed Control [2/2]

Configuration Options (rm_motor_speed.h)	
Options	Description
Open-Loop Step of d-axis current climbing Initial: 0.3F	The d-axis current reference ramping up rate [A/msec].
Open-Loop Step of d-axis current descending Initial: 0.3F	The d-axis current reference ramping down rate [A/msec].
Open-Loop Step of q-axis current descending ratio Initial: 1.0F	The q-axis current reference ramping down proportion to reference before open-loop [A/msec].
Open-Loop Reference of d-axis current Initial: 0.3F	The d-axis current reference in open-loop drive [A].
Open-Loop Threshold of speed control descending Initial: 600	The speed threshold [rad/s] to ramp down the d-axis current [rpm].
Open-Loop Threshold of speed control climbing Initial: 500	The speed threshold [rad/s] to ramp up the d-axis current [rpm].
Open-Loop Period between open-loop to BEMF (sec) Initial: 0.025F	Time to switch open-loop to sensor-less [sec].
Open-Loop Phase error(degree) to decide sensor-less switch timing Initial: 10.0F	Phase error to decide sensor-less switch timing (electrical angle) [degree].
Design parameter Speed PI loop omega Initial: 5.0F	Speed PI Control parameter omega.
Design parameter Speed PI loop zeta Initial: 1.0F	Speed PI Control parameter zeta.
Design parameter Estimated d-axis HPF omega Initial: 2.5F	Natural frequency [Hz] for HPF in open-loop damping gain design.
Design parameter Open-loop damping zeta Initial: 1.0F	Damping ratio for open-loop damping gain design.
Design parameter Cutoff frequency of phase error LPF Initial: 10.0F	The cut-off frequency [Hz] of phase error LPF gain design.
Design parameter Speed observer omega Initial: 200.0F	Speed observer omega.
Design parameter Speed observer zeta Initial: 1.0F	Speed observer zeta.
Motor Parameter Pole pairs Initial: 2	Pole pairs of target motor.
Motor Parameter Resistance (ohm) Initial: 8.5F	Resistance of motor [ohm].
Motor Parameter Inductance of d-axis (H) Initial: 0.0045F	D-axis inductance [H].
Motor Parameter Inductance of q-axis (H) Initial: 0.0045F	Q-axis inductance [H].
Motor Parameter Permanent magnetic flux (Wb) Initial: 0.02159F	Magnetic flux [Wb].
Motor Parameter Rotor inertia (kgm ²) Initial: 0.0000028F	Rotor inertia [kgm ²].

Motor Speed Controller (rm_motor_speed)	
Property	Value
Settings	
▼ Common	
Parameter Checking	Default (BSP)
Position Support	Disabled
▼ Module Motor Speed Controller (rm_motor_speed)	
▼ General	
Name	g_motor_speed0
Speed control period (sec)	0.0005F
Step of speed climbing (rpm)	0.5F
Maximum rotational speed (rpm)	2650
Speed LPF omega	10.0F
Speed at Id climbing (rpm)	500
Limit of q-axis current (A)	0.42F
Step of speed feedback at open-loop	0.20F
Open-loop damping	Enable
Flux weakening	Disable
Torque compensation for sensorless transition	Enable
Speed observer	Enable
Control method	PID
Control type	🔒 Sensorless
▼ Open-Loop	
Step of d-axis current climbing	0.3F
Step of d-axis current descending	0.3F
Step of q-axis current descending ratio	1.0F
Reference of d-axis current	0.3F
Threshold of speed control descending	600
Threshold of speed control climbing	500
Period between open-loop to BEMF (sec)	0.025F
Phase error(degree) to decide sensor-less switch timing	10
▼ Design parameter	
Speed PI loop omega	5.0F
Speed PI loop zeta	1.0F
Estimated d-axis HPF omega	2.5F
Open-loop damping zeta	1.0F
Cutoff frequency of phase error LPF	10.0F
Speed observer omega	200.0F
Speed observer zeta	1.0F
▼ Motor Parameter	
Pole pairs	2
Resistance (ohm)	8.5F
Inductance of d-axis (H)	0.0045F
Inductance of q-axis (H)	0.0045F
Permanent magnetic flux (Wb)	0.02159F
Rotor inertia (kgm ²)	0.0000028F
▼ Interrupts	
Callback	🔒 rm_motor_sensorless_speed_callback
Input data	🔒 (g_motor_sensorless0_ctrl.st_speed_input)
Output data	🔒 (g_motor_sensorless0_ctrl.st_speed_output)

Figure 3-10 FSP Configuration of Motor Speed Controller (FSP 3.5.0)

Table 3-16 Configuration Options for Angle and Speed Estimation

Configuration Options (rm_motor_estimate.h)	
Options	Description
Motor Parameter Pole pairs Initial: 2	Pole pairs of target motor.
Motor Parameter Resistance (ohm) Initial: 8.5F	Resistance of motor [ohm].
Motor Parameter Inductance of d-axis (H) Initial: 0.0045F	D-axis inductance [H].
Motor Parameter Inductance of q-axis (H) Initial: 0.0045F	Q-axis inductance [H].
Motor Parameter Permanent magnetic flux (Wb) Initial: 0.02159F	Magnetic flux [Wb].
Motor Parameter Rotor inertia (kgm ²) Initial: 0.0000028F	Rotor inertia [kgm ²].
Open-loop damping Initial: Enable	Select enable/disable of Open-Loop Damping Control
Natural frequency of BEMF observer Initial: 1000.0F	Natural frequency for BEMF observer [Hz].
Damping ratio of BEMF observer Initial: 1.0F	Damping ratio for BEMF observer.
Natural frequency of PLL Speed estimate loop Initial: 20.0F	Natural frequency for rotor position Phase-Locked Loop [Hz].
Damping ratio of PLL Speed estimate loop Initial: 1.0F	Damping ratio for rotor position Phase-Locked Loop.
Control period Initial: 0.0005F	Period of Speed Control [sec]

g_motor_angle0 Motor Angle (rm_motor_estimate)		
Settings	Property	Value
	▼ Common	
	Parameter Checking	Default (BSP)
	▼ Module g_motor_angle0 Motor Angle (rm_motor_estimate)	
	▼ Motor Parameter	
	Pole pairs	2
	Resistance[ohm]	8.5F
	Inductance of d-axis[H]	0.0045F
	Inductance of q-axis[H]	0.0045F
	Permanent magnetic flux[Wb]	0.02159F
	Rotor inertia[kgm ²]	0.0000028F
	Name	g_motor_angle0
	Openloop damping	Enable
	Natural frequency of BEMF observer	1000.0F
	Damping ratio of BEMF observer	1.0F
	Natural frequency of PLL Speed estimate loop	20.0F
	Damping ratio of PLL Speed estimate loop	1.0F
	Control period	0.00005F

Figure 3-11 FSP Configuration of Motor Angle Driver (FSP 3.5.0)

Table 3-17 Configuration Options for Driver Access

Configuration Options (rm_motor_driver.h)	
Options	Description
Shunt type Initial: 2shunt	Selects how many shunt resistances to use current detection.
PWM timer frequency (MHz) Initial: 120U	PWM Timer Clock Frequency [MHz]
PWM carrier period (micro seconds) Initial: 50U	PWM Carrier Period [micro seconds]
Dead time (raw counts) Initial: 240	PWM Dead time [raw counts]
Current range (A) Initial: 27.5F	Measurement Range of Electric current [A]
Voltage range (V) Initial: 111.0F	Measurement Range of Inverter Voltage [V]
Counts for current offset measurement Initial: 500	Counts of measurement the offset of A/D Conversion at electric current input.
A/D conversion channel for U phase current Initial: 0	A/D channel for U-phase current
A/D conversion channel for W phase current Initial: 2	A/D channel for W-phase current
A/D conversion channel for main line voltage Initial: 5	A/D channel for main line voltage
A/D conversion channel for V phase current Initial: 1	A/D channel for V-phase current It is invalid at 2shunt detection.
Input voltage Initial: 24.0F	Range of input for main line voltage
Resolution of A/D conversion Initial: 0xFFFF	Resolution of A/D conversion Please set same value with ADC module setting.
Offset of A/D conversion for current Initial: 0x745	Offset level of A/D conversion input for current Please set according to the circuit.
Conversion level of A/D conversion for voltage Initial: 0.66F	Conversion level of A/D conversion for voltage Please set when the CPU main voltage is different.
GTIOCA stop level Initial: Pin level High	Output level of upper arm at stop status
GTIOCB stop level Initial: Pin level High	Output level of lower arm at stop status
Maximum duty Initial: 0.9375F	Maximum duty of PWM Maximum duty except dead time.

ADC and PWM Modulation (rm_motor_driver)		
Settings	Property	Value
	▼ Common	
	Parameter Checking	Default (BSP)
	ADC_B Support	Disabled
	▼ Module ADC and PWM Modulation (rm_motor_driver)	
	▼ General	
	Name	g_motor_driver0
	Shunt type	2 shunt
	Modulation method	SVPWM
	PWM Timer Frequency (MHz)	120
	PWM Carrier Period (Microseconds)	50
	Dead Time (Raw Counts)	240
	Current Range (A)	27.5F
	Voltage Range (V)	111.0F
	Counts for current offset measurement	500
	A/D conversion channel for U Phase current	0
	A/D conversion channel for W Phase current	2
	A/D conversion channel for Main Line Voltage	5
	A/D conversion channel for V Phase current	1
	Adjustment value to current A/D	20.0
	Minimum difference of PWM duty	300
	Adjustment delay of A/D conversion	240
	Input Voltage (V)	24.0F
	Resolution of A/D conversion	0xFFF
	Offset of A/D conversion for current	0x745
	Conversion level of A/D conversion for voltage	0.66F
	GTIOCA Stop Level	Pin Level High
	GTIOCB Stop Level	Pin Level High
	▼ Modulation	
	Maximum Duty	0.9375F
	▼ Interrupts	
	Callback	 rm_motor_current_cyclic

Figure 3-12 FSP Configuration of ADC and PWM Modulation Driver (FSP 3.5.0)

3.4 Control flowcharts

3.4.1 Main process

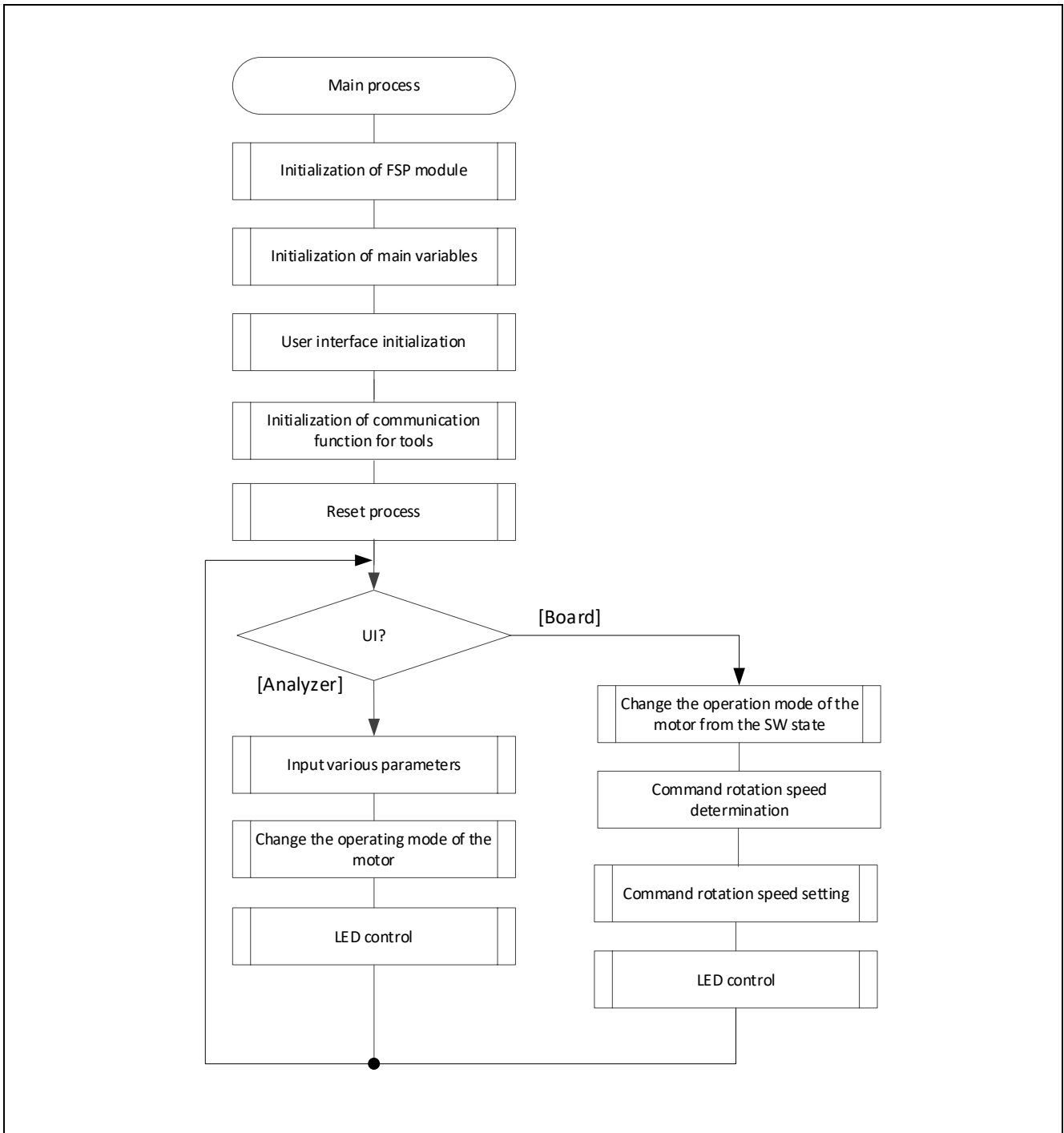

Figure 3-13 Main Process Flowchart

3.4.2 50[μs] Period Interrupt (Carrier synchronized Interrupt) Process

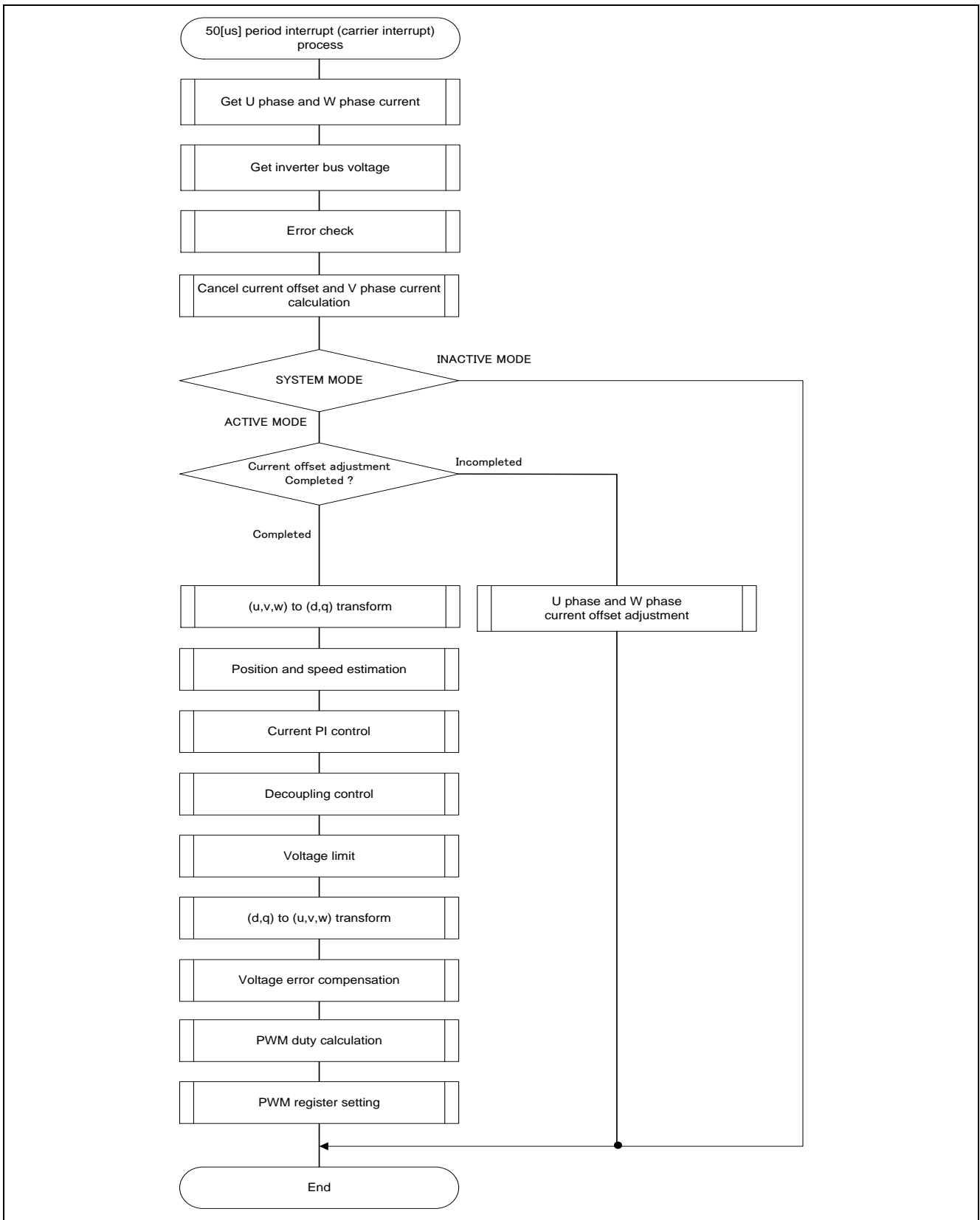

Figure 3-14 50[μs] Period Interrupt (Carrier Interrupt) Process Flowchart

3.4.3 500 [μs] Period Interrupt Process

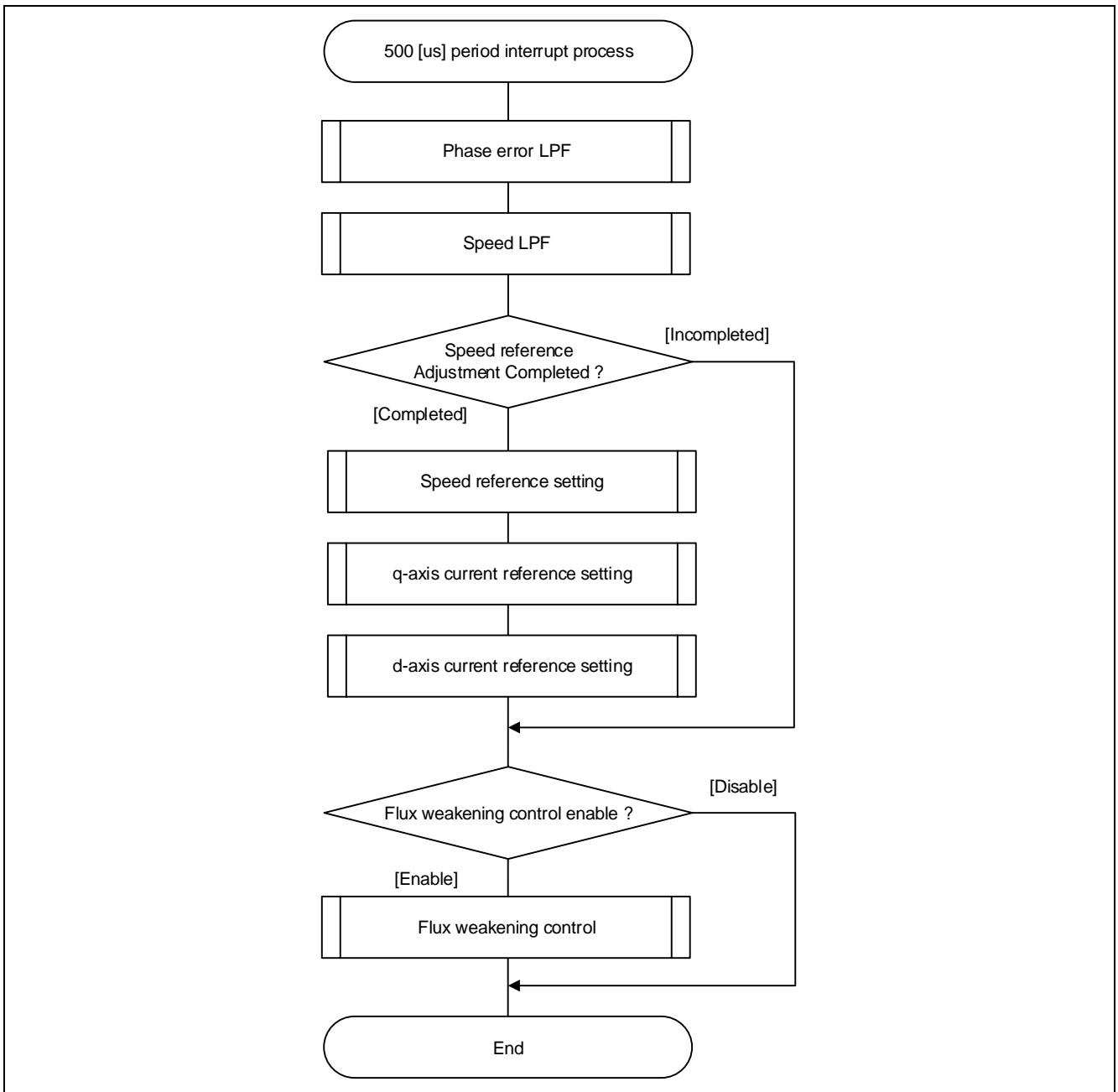

Figure 3-15 500[μs] Period Interrupt Process Flowchart

3.4.4 Over Current Detection Interrupt Process

The overcurrent detection interrupt is an interrupt that occurs when either an external overcurrent detection signal is input at POEG pin, or an output short circuit is detected by the GTETRGC output level comparison operation. In both cases, the PWM output terminal are put in the high impedance state. Therefore, at the start of execution of this interrupt processing, the PWM output terminal is already in the high impedance state and the output to the motor had been stopped.

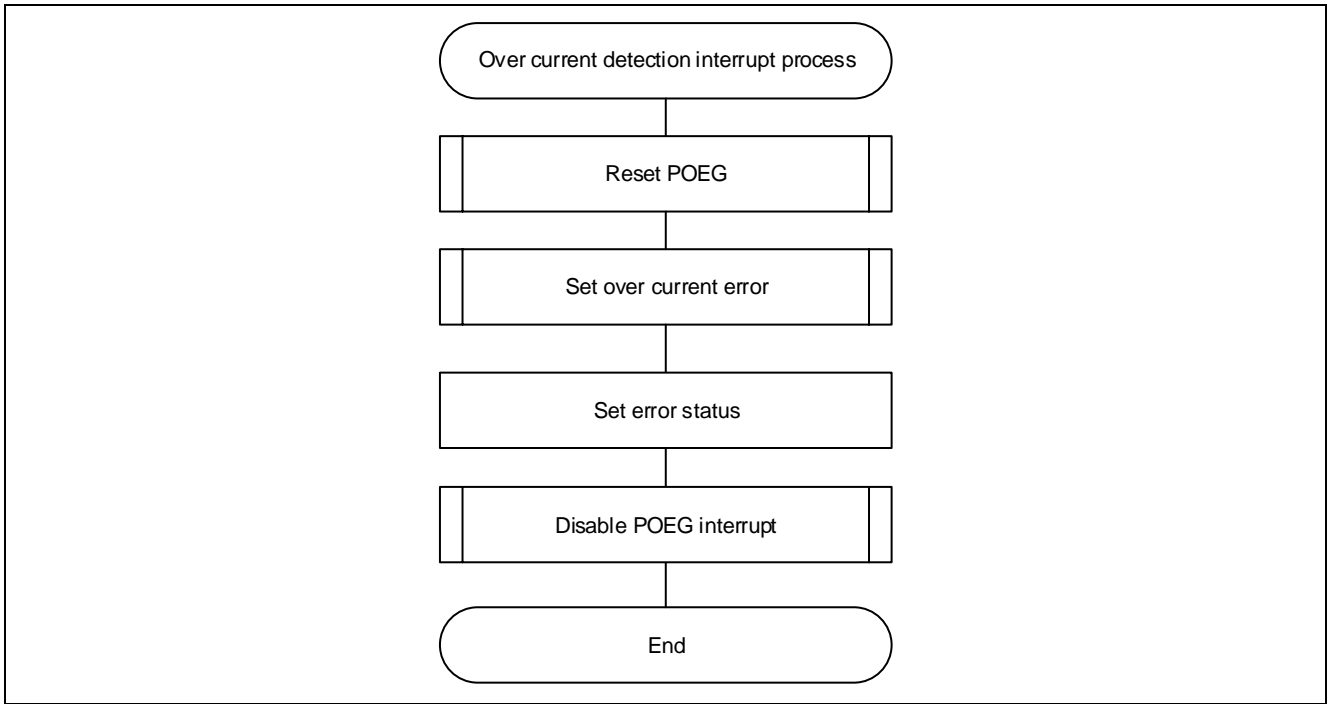

Figure 3-16 Over Current Detection Interrupt Process Flowchart

4. Evaluation environment explanation

4.1 Operating Environment

Table 4-1 shows the hardware requirements for building and debugging Motor control software.

Table 4-1 Hardware Requirements

Hardware	Description
Inverter Board	RA6T1-RSSK [RTK0EM0000B10020BJ]
CPU Card	RA6T1 CPU Card [RTK0EMA170C00000BJ]
Motor	Brushless DC Motor (TG-55L-KA 24V)
On-chip debugging Emulator	The RA6T1 CPU Card has an on-board debugger (J-Link OB), so there is no need to prepare an emulator.

Table 4-2 shows the software requirements for build and debug Motor control software.

Table 4-2 Software Requirements

Software		Version	Description
GCC environment	e ² studio	2021-10	Integrated development environment (IDE) for Renesas devices.
	GCC ARM Embedded	V10.3.1.20210824	C/C++ Compiler. (Download from e2studio installer)
	Renesas Flexible Software Package (FSP)	V3.5.0 (or later)	Software package for writing applications for the RA microcontroller series.

4.2 Importing the Demo Project

The sample application provided with this document may be imported into e²studio using the steps in this section.

1. Select File → Import.

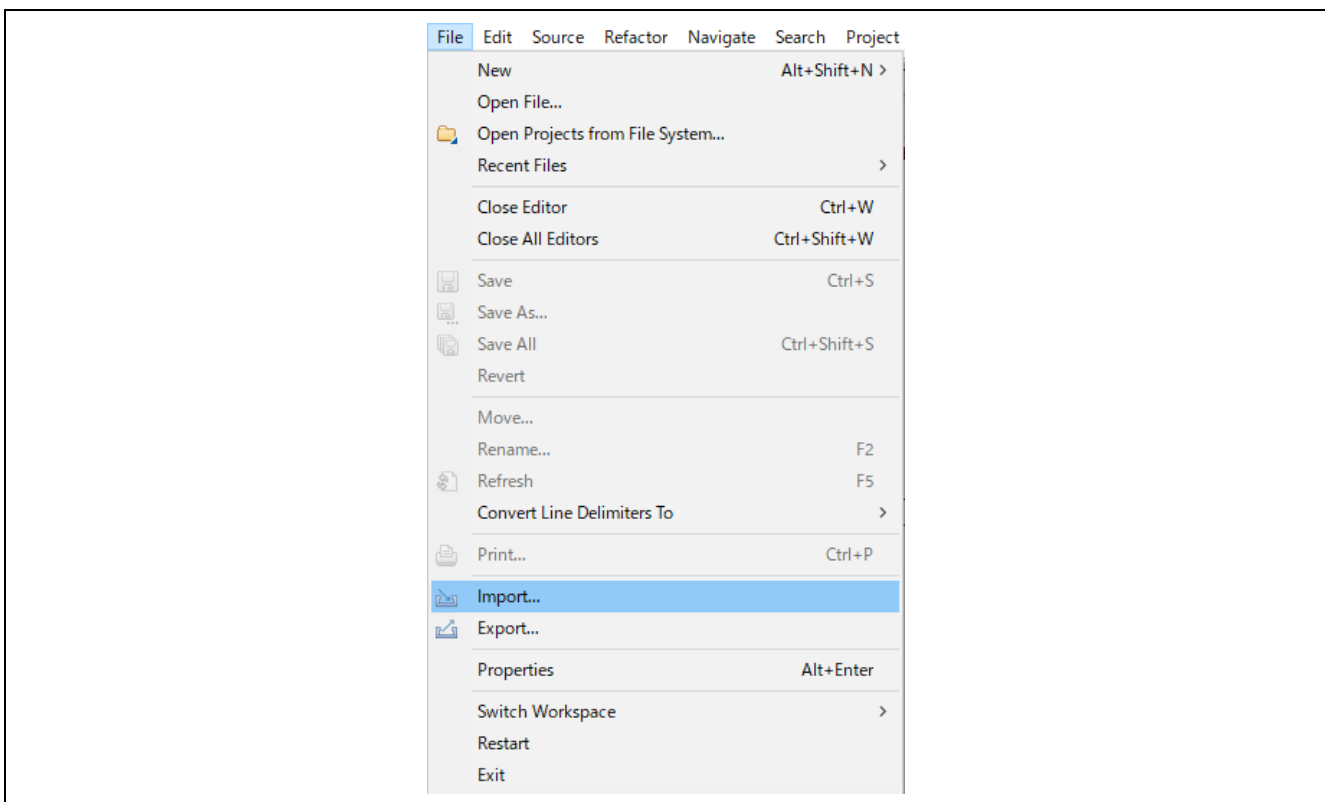

Figure 4-1 File Menu

2. Select “Existing Projects into Workspace”.

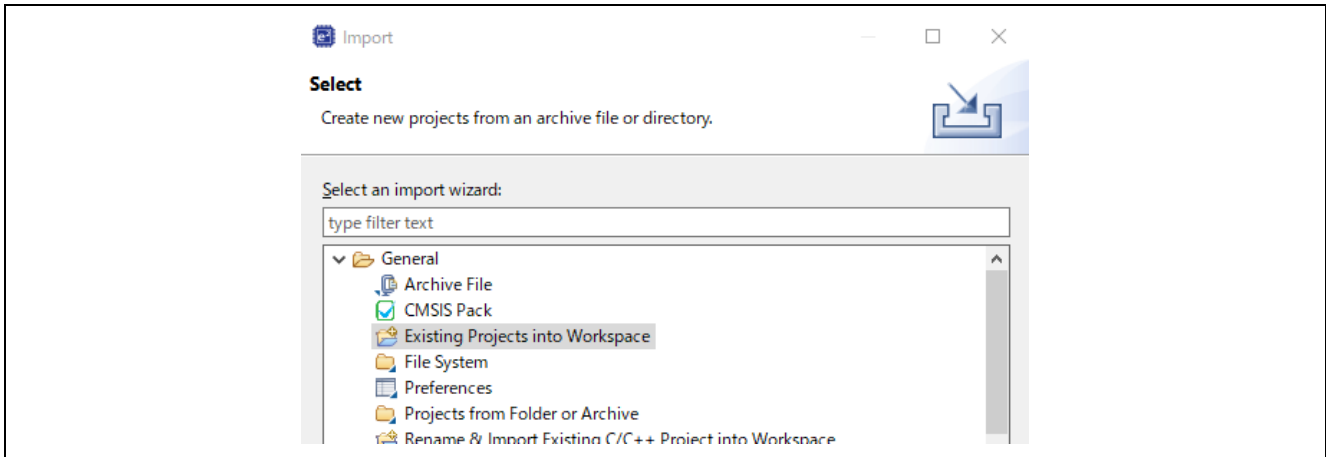

Figure 4-2 Import Wizard Selection

3. Click “Browse...” button and select the demo project. Click Finish button and the demo project is imported.

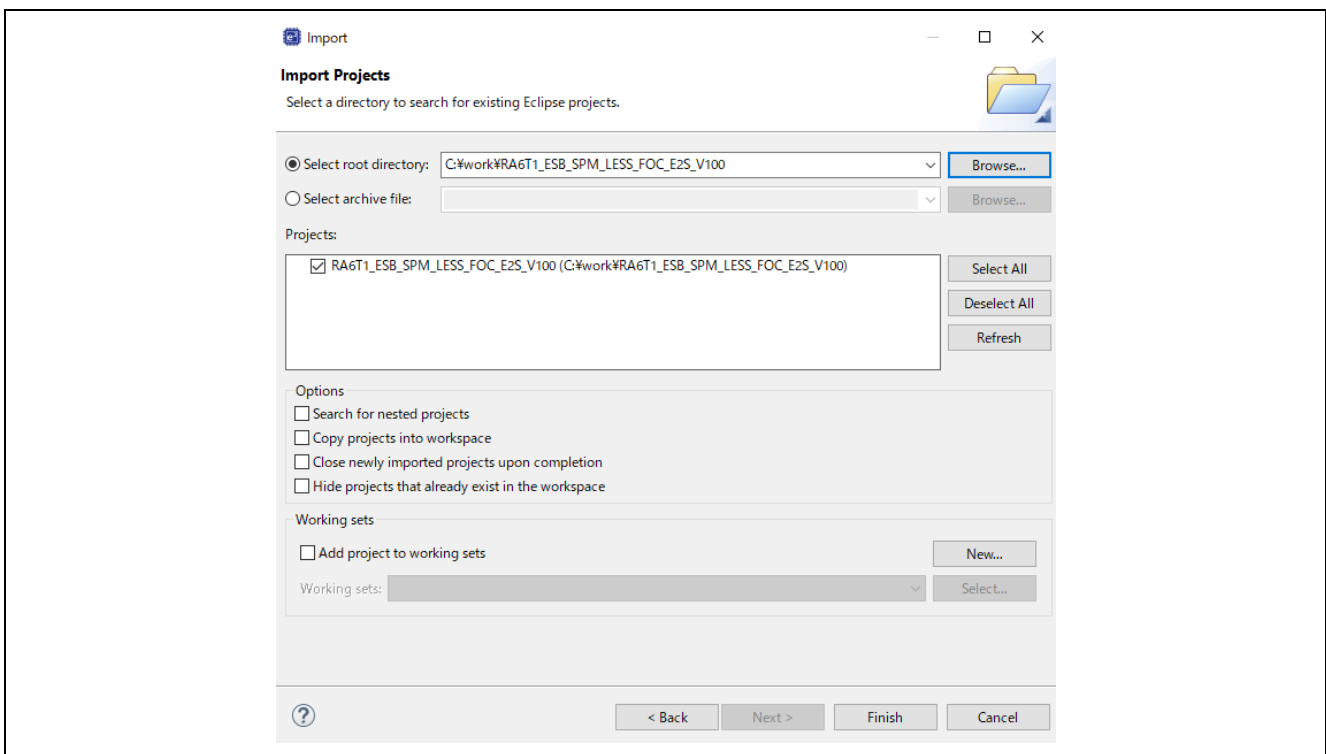

Figure 4-3 Import Projects

4.3 Building and Debugging

Refer to the "e²studio Getting Started Guide (R20UT4204)".

4.4 Motor Demonstration Project Overview

4.4.1 Quick Start

When executing the sample code only in the evaluation environment without using Renesas motor workbench, the Quick Start Sample Project can be executed with the following procedure.

- (1) After turning on stabilized power supply or executing reset, LED1, and LED2 on the inverter board are both off and the motor stops.
- (2) IF the toggle switch (SW1) on the inverter board is turned on, the motor starts to rotate. Every time the toggle switch (SW1) is changed, motor rotation starts/stops alternately. If the motor rotates normally, LED1 is on. However, if LED2 on the inverter board is also on, error is occurring.
- (3) In order to change the direction of the motor rotation, adjust it with the variable resistor (VR) on the inverter board.
 - Turn the variable resistor (VR) right: Motor rotates clockwise
 - Turn the variable resistor (VR) left: Motor rotates counterclockwise
- (4) If error occurs, LED2 on the inverter board lightens, and the motor rotation stops. To restore, the toggle switch (SW1) on the inverter board needs to be turned off, then the switch (SW2) to be pushed and released.
- (5) In order to stop the operation check, turn off the output of the stabilized power supply after making sure that the motor rotation has already stopped

4.5 Motor Control Development Support Tool ‘Renesas Motor Workbench’

4.5.1 Overview

In the target software of this application note, the motor control development support tool “Renesas Motor Workbench” is used as a user interface (rotating/stop motor, set rotation speed reference, etc). Please refer to ‘Renesas Motor Workbench User’s Manual’ for usage and more details.

You can find ‘Renesas Motor Workbench’ on Renesas Electronics Corporation website.

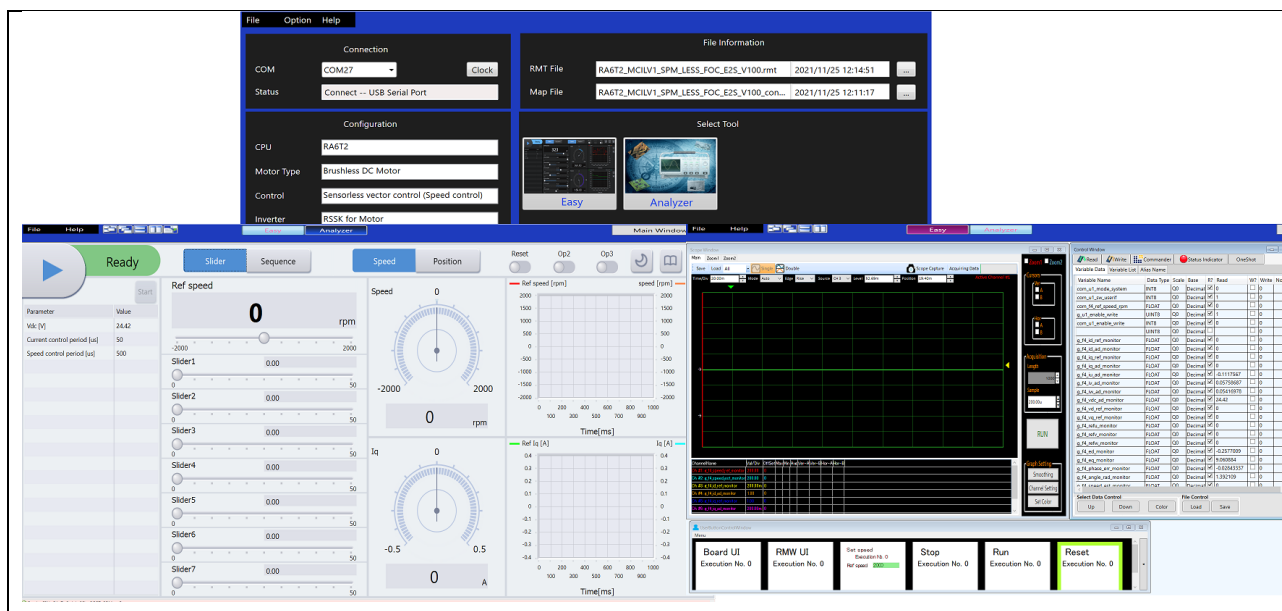
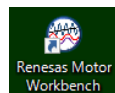

Figure 4-4 Renesas Motor Workbench – Appearance

Set up for “Renesas Motor Workbench”



- (1) Start ‘Renesas Motor Workbench’ by clicking this icon.
- (2) Drop down menu [File] → [Open RMT File(O)].
And select RMT file in ‘[Project Folder]/src/application/user_interface/ics/’.
- (3) Use the ‘Connection’ [COM] select menu to choose the COM port.
- (4) Click the Analyzer button of Select Tool to activate Analyzer function.
- (5) Please refer to ‘4.5.2 Easy function operation example’ or ‘4.5.4 Operation Example for Analyzer’ for motor driving operation.

4.5.2 Easy function operation example

The following is an example of operating the motor using the Easy function.

- Change the user interface to use Renesas Motor Workbench
 - (1) Turn on "RMW UI".

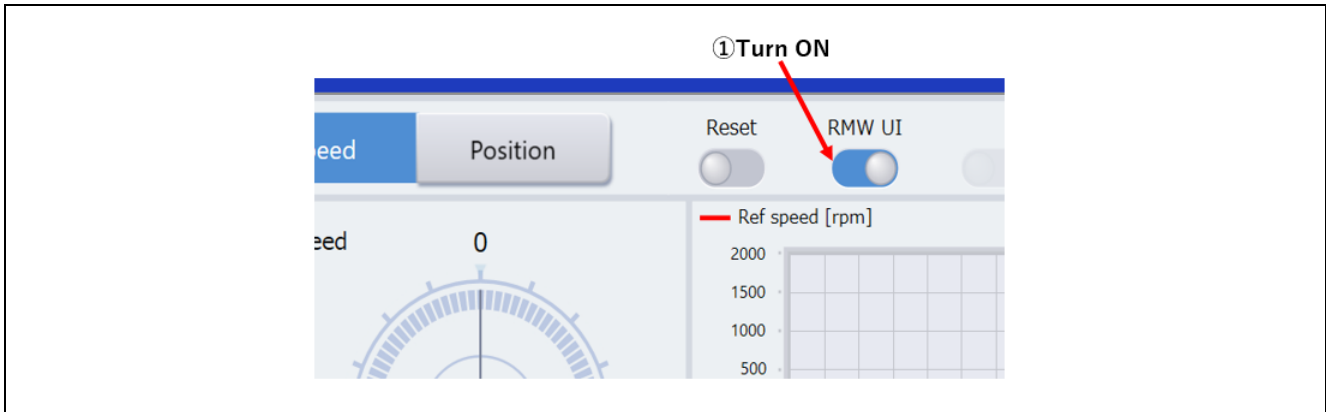

Figure 4-5 Procedure for changing to use Renesas Motor Workbench

- Change the user interface to use Renesas Motor Workbench
 - (1) Press the "Run" button

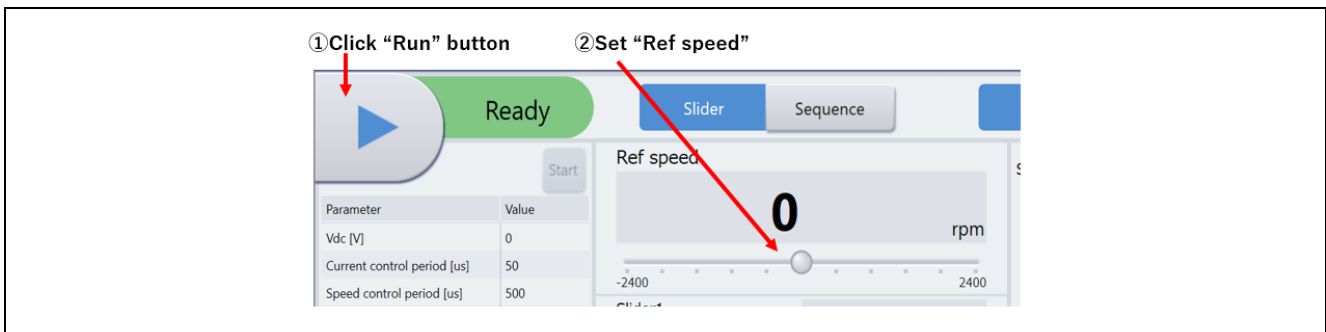

Figure 4-6 Motor rotation procedure

- Stop the motor
 - (1) Press the "Stop" button

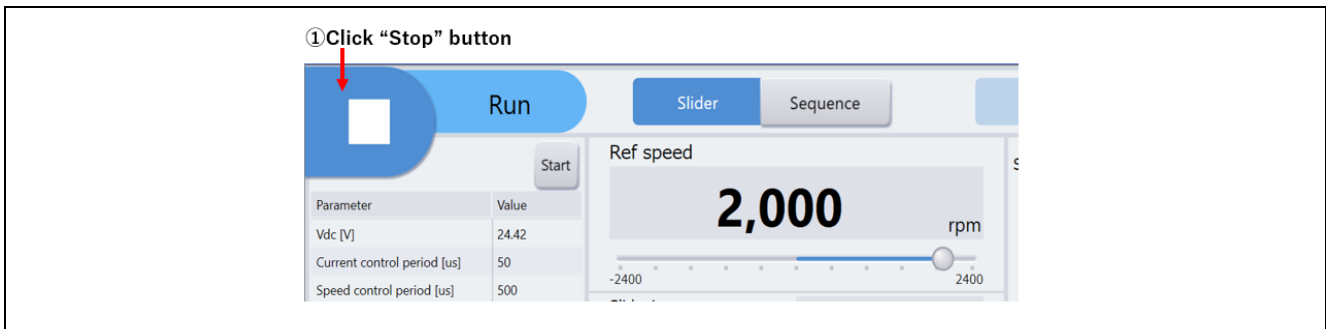

Figure 4-7 Motor rotation procedure

- Processing when it stops (error)
 - (1) Turn on "Reset" button.
 - (2) Turn off "Reset" button

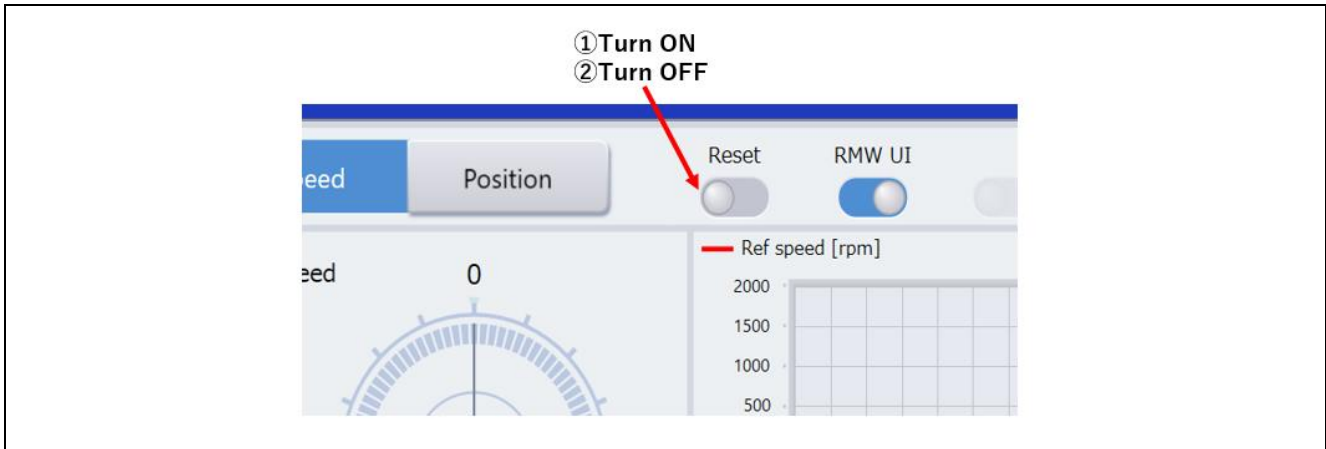

Figure 4-8 Error clearing procedure

4.5.3 List of variables for Analyzer function

Table 4-3 is a list of variables for Analyzer. These variables are reflected to the corresponding variables when the same values as `g_u1_enable_write` are written to `com_u1_enable_write`. However, note that variables with (*) do not depend on `com_u1_enable_write`.

Table 4-3 List of Variables for Analyzer

Variable name	Type	Content
<code>com_u1_sw_userif (*)</code>	<code>uint8_t</code>	User interface switch 0: Analyzer use 1: Board user interface use (default)
<code>com_u1_mode_system1(*)</code>	<code>uint8_t</code>	State management 0: Stop mode 1: Run mode 3: Reset
<code>com_f4_ref_speed_rpm</code>	<code>float</code>	Speed reference (mechanical angle) [rpm]
<code>com_u2_mtr_pp</code>	<code>uint16_t</code>	Number of pole pairs
<code>com_f4_mtr_r</code>	<code>float</code>	Resistance [Ω]
<code>com_f4_mtr_ld</code>	<code>float</code>	d-axis Inductance [H]
<code>com_f4_mtr_lq</code>	<code>float</code>	q-axis Inductance [H]
<code>com_f4_mtr_m</code>	<code>float</code>	Magnetic Flux [Wb]
<code>com_f4_mtr_j</code>	<code>float</code>	Inertia [kgm^2]
<code>com_f4_current_omega</code>	<code>float</code>	Natural frequency of current control system [Hz]
<code>com_f4_current_zeta</code>	<code>float</code>	Damping ratio of current control system
<code>com_f4_speed_omega</code>	<code>float</code>	Natural frequency of speed control system [Hz]
<code>com_f4_speed_zeta</code>	<code>float</code>	Damping ratio of speed control system
<code>com_f4_e_obs_omega</code>	<code>float</code>	Natural frequency of BEMF estimation system [Hz]
<code>com_f4_e_obs_zeta</code>	<code>float</code>	Damping ratio of BEMF estimation system
<code>com_f4_pll_est_omega</code>	<code>float</code>	Natural frequency of position estimation system [Hz]
<code>com_f4_pll_est_zeta</code>	<code>float</code>	Damping ratio of position estimation system
<code>com_f4_ref_id</code>	<code>float</code>	d-axis current reference in open loop mode [A]
<code>com_f4_ol_id_up_step</code>	<code>float</code>	d-axis current reference ramping up rate
<code>com_f4_ol_id_down_step</code>	<code>float</code>	d-axis current reference ramping down rate
<code>com_f4_id_down_speed_rpm</code>	<code>float</code>	Speed when start to subtract d-axis current reference (mechanical angle) [rpm]
<code>com_f4_id_up_speed_rpm</code>	<code>float</code>	Speed when start to add d-axis current reference (mechanical angle) [rpm]
<code>com_f4_max_speed_rpm</code>	<code>float</code>	Maximum speed value (mechanical angle) [rpm]
<code>com_f4_overspeed_limit_rpm</code>	<code>float</code>	Speed limit (mechanical angle) [rpm]
<code>com_f4_overcurrent_limit</code>	<code>float</code>	Over current limit [A]
<code>com_f4_iq_limit</code>	<code>float</code>	q-axis current limit [A]
<code>com_f4_limit_speed_change</code>	<code>float</code>	Change speed limit (electrical angle) [rad/s]
<code>com_u1_enable_write</code>	<code>uint8_t</code>	Enabled to rewriting variables (rewritten when the same values as <code>g_u1_enable_write</code> are written)

4.5.4 Operation Example for Analyzer

Following example shows motor driving operation using Analyzer. Operation is using “Control Window” as shown in Figure 4-4. Regarding specification of “Control Window”, refer to ‘Renesas Motor Workbench User’s Manual’.

- Change the user interface to Analyzer

- (1) Confirm the check-boxes of column [W?] for ‘com_u1_sw_userif’ marks.
- (2) Input ‘0’ in the [Write] box of ‘com_u1_sw_userif’.
- (3) Click the ‘Write’ button.

- Driving the motor

- (1) The [W?] check boxes contain checkmarks for “com_u1_mode_system1”, “com_f4_ref_speed_rpm”, “com_u1_enable_write”
- (2) Type a reference speed value in the [Write] box of “com_f4_ref_speed_rpm”.
- (3) Click the “Write” button.
- (4) Click the “Read” button. Confirm the [Read] box of “com_f4_ref_speed_rpm”, “g_u1_enable_write”.
- (5) Enter the value of “g_u1_enable_write” in the [Write] box of “com_u1_enable_write”.
- (6) Enter “1” in the [Write] box of “com_u1_mode_system”.
- (7) Click the “Write” button.

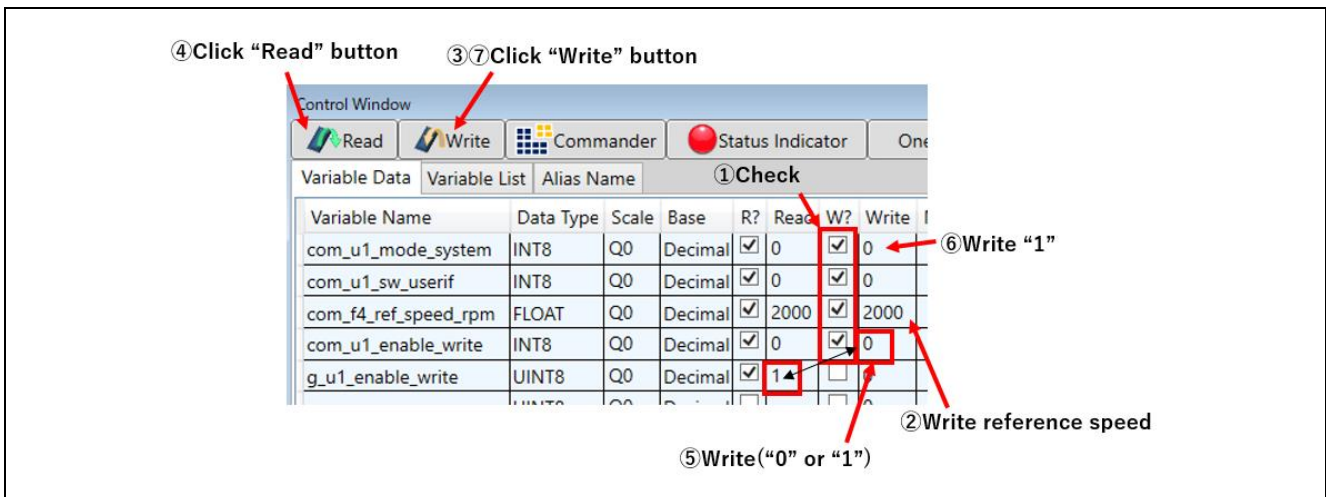

Figure 4-9 Procedure - Driving the motor

- Stop the motor

- (1) Enter “0” in the [Write] box of “com_u1_mode_system”.
- (2) Click the “Write” button.

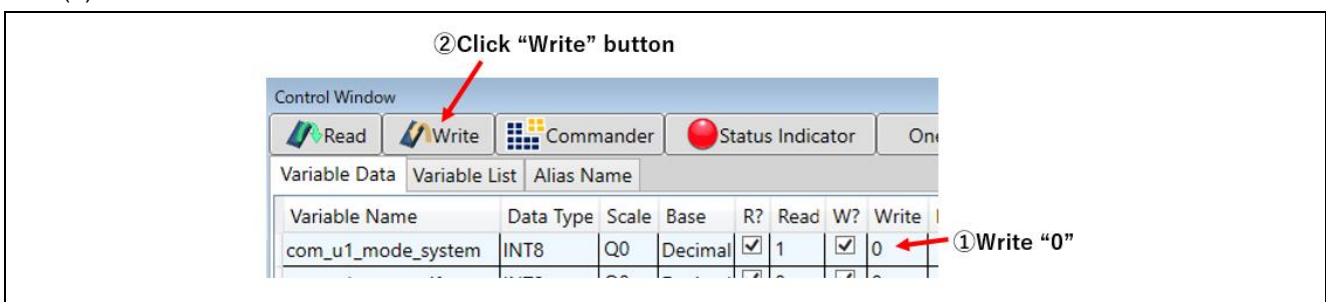

Figure 4-10 Procedure - Stop the motor

- Error cancel operation

- (1) Enter "3" in the [Write] box of "com_u1_mode_system".
- (2) Click the "Write" button.

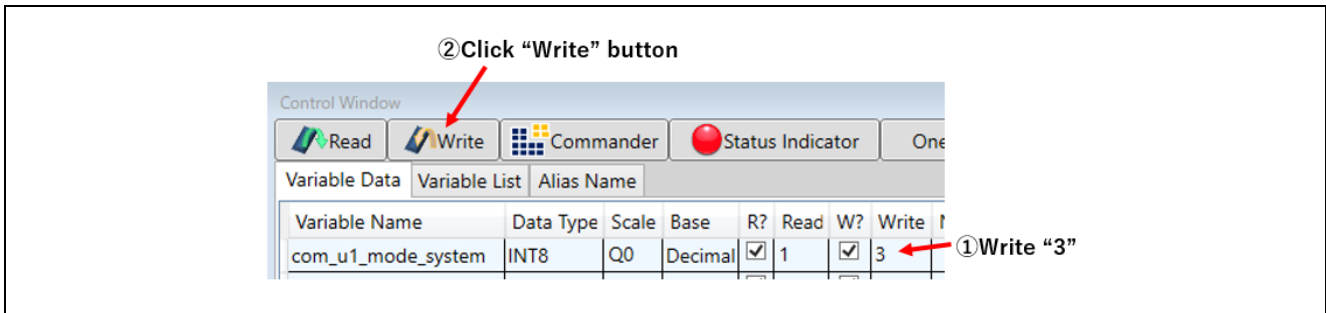

Figure 4-11 Procedure - Error cancel operation

4.5.5 Tuner function

To use the Tuner function, use the executable file provided by Renesas Motor Workbench.

For details on how to use the Tuner function, refer to the Tuner function manual (R20AN0528) included in the Renesas Motor Workbench download file.

5. Reference Documents

RA6T1 Group User's Manual: Hardware (R01UH0897)

RA Flexible Software Package Documentation

Application note: 'Sensorless vector control for permanent magnet synchronous motor (Algorithm)' (R01AN3786)

Renesas Motor Workbench User's Manual (R21UZ0004)

Evaluation System for BLDC Motor User's Manual (R12UZ0062)

Motor Control Evaluation System for RA Family (R12UZ0078)

RA6T1 CPU CARD User's Manual (R12UZ0077)

Revision History

Rev.	Date	Description	
		Page	Summary
1.00	Oct.28, 2020	-	First release document
1.10	Dec.17, 2021	-	For FSP V3.5.0
1.11	Oct.18, 2022	-	For FSP V4.1.0

General Precautions in the Handling of Microprocessing Unit and Microcontroller Unit Products

The following usage notes are applicable to all Microprocessing unit and Microcontroller unit products from Renesas. For detailed usage notes on the products covered by this document, refer to the relevant sections of the document as well as any technical updates that have been issued for the products.

1. Precaution against Electrostatic Discharge (ESD)

A strong electrical field, when exposed to a CMOS device, can cause destruction of the gate oxide and ultimately degrade the device operation. Steps must be taken to stop the generation of static electricity as much as possible, and quickly dissipate it when it occurs. Environmental control must be adequate. When it is dry, a humidifier should be used. This is recommended to avoid using insulators that can easily build up static electricity.

Semiconductor devices must be stored and transported in an anti-static container, static shielding bag or conductive material. All test and measurement tools including work benches and floors must be grounded. The operator must also be grounded using a wrist strap. Semiconductor devices must not be touched with bare hands. Similar precautions must be taken for printed circuit boards with mounted semiconductor devices.

2. Processing at power-on

The state of the product is undefined at the time when power is supplied. The states of internal circuits in the LSI are indeterminate and the states of register settings and pins are undefined at the time when power is supplied. In a finished product where the reset signal is applied to the external reset pin, the states of pins are not guaranteed from the time when power is supplied until the reset process is completed. In a similar way, the states of pins in a product that is reset by an on-chip power-on reset function are not guaranteed from the time when power is supplied until the power reaches the level at which resetting is specified.

3. Input of signal during power-off state

Do not input signals or an I/O pull-up power supply while the device is powered off. The current injection that results from input of such a signal or I/O pull-up power supply may cause malfunction and the abnormal current that passes in the device at this time may cause degradation of internal elements. Follow the guideline for input signal during power-off state as described in your product documentation.

4. Handling of unused pins

Handle unused pins in accordance with the directions given under handling of unused pins in the manual. The input pins of CMOS products are generally in the high-impedance state. In operation with an unused pin in the open-circuit state, extra electromagnetic noise is induced in the vicinity of the LSI, an associated shoot-through current flows internally, and malfunctions occur due to the false recognition of the pin state as an input signal become possible.

5. Clock signals

After applying a reset, only release the reset line after the operating clock signal becomes stable. When switching the clock signal during program execution, wait until the target clock signal is stabilized. When the clock signal is generated with an external resonator or from an external oscillator during a reset, ensure that the reset line is only released after full stabilization of the clock signal. Additionally, when switching to a clock signal produced with an external resonator or by an external oscillator while program execution is in progress, wait until the target clock signal is stable.

6. Voltage application waveform at input pin

Waveform distortion due to input noise or a reflected wave may cause malfunction. If the input of the CMOS device stays in the area between V_{IL} (Max.) and V_{IH} (Min.) due to noise, for example, the device may malfunction. Take care to prevent chattering noise from entering the device when the input level is fixed, and also in the transition period when the input level passes through the area between V_{IL} (Max.) and V_{IH} (Min.).

7. Prohibition of access to reserved addresses

Access to reserved addresses is prohibited. The reserved addresses are provided for possible future expansion of functions. Do not access these addresses as the correct operation of the LSI is not guaranteed.

8. Differences between products

Before changing from one product to another, for example to a product with a different part number, confirm that the change will not lead to problems. The characteristics of a microprocessing unit or microcontroller unit products in the same group but having a different part number might differ in terms of internal memory capacity, layout pattern, and other factors, which can affect the ranges of electrical characteristics, such as characteristic values, operating margins, immunity to noise, and amount of radiated noise. When changing to a product with a different part number, implement a system-evaluation test for the given product.

Notice

1. Descriptions of circuits, software and other related information in this document are provided only to illustrate the operation of semiconductor products and application examples. You are fully responsible for the incorporation or any other use of the circuits, software, and information in the design of your product or system. Renesas Electronics disclaims any and all liability for any losses and damages incurred by you or third parties arising from the use of these circuits, software, or information.
 2. Renesas Electronics hereby expressly disclaims any warranties against and liability for infringement or any other claims involving patents, copyrights, or other intellectual property rights of third parties, by or arising from the use of Renesas Electronics products or technical information described in this document, including but not limited to, the product data, drawings, charts, programs, algorithms, and application examples.
 3. No license, express, implied or otherwise, is granted hereby under any patents, copyrights or other intellectual property rights of Renesas Electronics or others.
 4. You shall not alter, modify, copy, or reverse engineer any Renesas Electronics product, whether in whole or in part. Renesas Electronics disclaims any and all liability for any losses or damages incurred by you or third parties arising from such alteration, modification, copying or reverse engineering.
 5. Renesas Electronics products are classified according to the following two quality grades: "Standard" and "High Quality". The intended applications for each Renesas Electronics product depends on the product's quality grade, as indicated below.
 - "Standard": Computers; office equipment; communications equipment; test and measurement equipment; audio and visual equipment; home electronic appliances; machine tools; personal electronic equipment; industrial robots; etc.
 - "High Quality": Transportation equipment (automobiles, trains, ships, etc.); traffic control (traffic lights); large-scale communication equipment; key financial terminal systems; safety control equipment; etc.
- Unless expressly designated as a high reliability product or a product for harsh environments in a Renesas Electronics data sheet or other Renesas Electronics document, Renesas Electronics products are not intended or authorized for use in products or systems that may pose a direct threat to human life or bodily injury (artificial life support devices or systems; surgical implantations; etc.), or may cause serious property damage (space system; undersea repeaters; nuclear power control systems; aircraft control systems; key plant systems; military equipment; etc.). Renesas Electronics disclaims any and all liability for any damages or losses incurred by you or any third parties arising from the use of any Renesas Electronics product that is inconsistent with any Renesas Electronics data sheet, user's manual or other Renesas Electronics document.
6. When using Renesas Electronics products, refer to the latest product information (data sheets, user's manuals, application notes, "General Notes for Handling and Using Semiconductor Devices" in the reliability handbook, etc.), and ensure that usage conditions are within the ranges specified by Renesas Electronics with respect to maximum ratings, operating power supply voltage range, heat dissipation characteristics, installation, etc. Renesas Electronics disclaims any and all liability for any malfunctions, failure or accident arising out of the use of Renesas Electronics products outside of such specified ranges.
 7. Although Renesas Electronics endeavors to improve the quality and reliability of Renesas Electronics products, semiconductor products have specific characteristics, such as the occurrence of failure at a certain rate and malfunctions under certain use conditions. Unless designated as a high reliability product or a product for harsh environments in a Renesas Electronics data sheet or other Renesas Electronics document, Renesas Electronics products are not subject to radiation resistance design. You are responsible for implementing safety measures to guard against the possibility of bodily injury, injury or damage caused by fire, and/or danger to the public in the event of a failure or malfunction of Renesas Electronics products, such as safety design for hardware and software, including but not limited to redundancy, fire control and malfunction prevention, appropriate treatment for aging degradation or any other appropriate measures. Because the evaluation of microcomputer software alone is very difficult and impractical, you are responsible for evaluating the safety of the final products or systems manufactured by you.
 8. Please contact a Renesas Electronics sales office for details as to environmental matters such as the environmental compatibility of each Renesas Electronics product. You are responsible for carefully and sufficiently investigating applicable laws and regulations that regulate the inclusion or use of controlled substances, including without limitation, the EU RoHS Directive, and using Renesas Electronics products in compliance with all these applicable laws and regulations. Renesas Electronics disclaims any and all liability for damages or losses occurring as a result of your noncompliance with applicable laws and regulations.
 9. Renesas Electronics products and technologies shall not be used for or incorporated into any products or systems whose manufacture, use, or sale is prohibited under any applicable domestic or foreign laws or regulations. You shall comply with any applicable export control laws and regulations promulgated and administered by the governments of any countries asserting jurisdiction over the parties or transactions.
 10. It is the responsibility of the buyer or distributor of Renesas Electronics products, or any other party who distributes, disposes of, or otherwise sells or transfers the product to a third party, to notify such third party in advance of the contents and conditions set forth in this document.
 11. This document shall not be reprinted, reproduced or duplicated in any form, in whole or in part, without prior written consent of Renesas Electronics.
 12. Please contact a Renesas Electronics sales office if you have any questions regarding the information contained in this document or Renesas Electronics products.

(Note1) "Renesas Electronics" as used in this document means Renesas Electronics Corporation and also includes its directly or indirectly controlled subsidiaries.

(Note2) "Renesas Electronics product(s)" means any product developed or manufactured by or for Renesas Electronics.

(Rev.4.0-1 November 2017)

Corporate Headquarters

TOYOSU FORESIA, 3-2-24 Toyosu,
Koto-ku, Tokyo 135-0061, Japan
www.renesas.com

Trademarks

Renesas and the Renesas logo are trademarks of Renesas Electronics Corporation. All trademarks and registered trademarks are the property of their respective owners.

Contact information

For further information on a product, technology, the most up-to-date version of a document, or your nearest sales office, please visit:
www.renesas.com/contact/.