

Application Note

Digital Distance Measurement with Ultrasonic Sensor Interface

AN-CM-227

Abstract

This application note describes how to implement a digital ultrasonic distance sensor using the GreenPAK module.

This application note comes complete with design files which can be found in the References section.

Digital Distance Measurement with Ultrasonic Sensor Interface

Contents

Abstract	1
Contents	2
Figures	2
Tables	2
1 Terms and Definitions	3
2 References	3
3 Introduction	4
4 Interface with Digital Ultrasonic Sensor	4
4.1 Ultrasonic Distance Sensor.....	4
4.2 Realization with GreenPAK Designer	5
5 Results	8
5.1 Possible Additions.....	13
6 Conclusion	14
Revision History	15

Figures

Figure 1: Ultrasonic Sensor Used on The Project.....	4
Figure 2: Interface System Design and Connections.....	5
Figure 3: GreenPAK ASM Used as a Synchronous FSM	6
Figure 4: Output RAM Connections	6
Figure 5: Full Circuit Diagram Designed as Interface for The Ultrasonic Distance Sensor	7
Figure 6: Emulation Tool Configuration for Testing in GreenPAK Designer Software.....	8
Figure 7: External Voltage Source Used.....	10
Figure 8: Circuit Test Measuring on Turned Off.....	10
Figure 9: Circuit Test Measuring Distance D Within the Range 8: $D < 25$ cm	11
Figure 10: Circuit Test Measuring Distance D Within the Range 7: $25 \text{ cm} < D < 50$ cm	11
Figure 11: Circuit Test Measuring Distance D Within the Range 6: $50 \text{ cm} < D < 75$ cm	11
Figure 12: Circuit Test Measuring Distance D Within the Range 5: $75 \text{ cm} < D < 100$ cm	12
Figure 13: Circuit Test Measuring Distance D Within the Range 4: $100 \text{ cm} < D < 125$ cm	12
Figure 14: Circuit Test Measuring Distance D Within the Range 3: $125 \text{ cm} < D < 150$ cm	12
Figure 15: Circuit Test Measuring Distance D Within the Range 2: $150 \text{ cm} < D < 175$ cm	13
Figure 16: Circuit Test Measuring Distance D Within the Range 1: $D > 175$ cm	13

Tables

Table 1: Classification of Distances Measured on Output LEDs.....	8
Table 2: Connection of GreenPAK Pins and Design Signals.....	9

Digital Distance Measurement with Ultrasonic Sensor Interface

1 Terms and Definitions

ASM	asynchronous state machine
IC	integrated circuit
FSM	finite-state machine
RAM	random access memory
LED	light-emitting diode
LCD	liquid-crystal display
BCD	binary-coded decimal
GPIO	general-purpose input/output

2 References

For related documents and software, please visit:

[GreenPAK™ Programmable Mixed-Signal Products | Renesas](#)

Download our free [GreenPAK Designer](#) software [1] to open the .gp files [2] and view the proposed circuit design. Use the [GreenPAK development tools](#) [3] to freeze the design into your own customized IC in a matter of minutes. Renesas Electronics provides a complete library of application notes [4] featuring design examples as well as explanations of features and blocks within the IC.

- [1] [GreenPAK Designer Software](#), Software Download and User Guide, Renesas Electronics
- [2] [AN-CM-227 Digital Distance Measurement with Ultrasonic Sensor.gp](#), [GreenPAK Design File](#), Renesas Electronics
- [3] [GreenPAK Development Tools](#), [GreenPAK Development Tools Webpage](#), Renesas Electronics
- [4] [GreenPAK Application Notes](#), [GreenPAK Application Notes Webpage](#), Renesas Electronics

Digital Distance Measurement with Ultrasonic Sensor Interface

3 Introduction

The goal of this application is to design a digital distance sensor with the help of a GreenPAK IC. The system is designed using the ASM and other components within the GreenPAK to interact with an ultrasonic sensor.

The system is designed to control a one-shot block, which will generate the trigger pulse with the necessary width for the ultrasonic sensor and classify the returning echo signal (proportional to the distance measured) into 8 distance categories.

The interface designed can be used to drive a digital distance sensor to be used in wide variety of applications, such as parking assist systems, robotics, warning systems, etc.

4 Interface with Digital Ultrasonic Sensor

The system designed sends trigger pulses to the ultrasonic sensor every 100 ms. The GreenPAK internal components, together with the ASM, oversee the classification of the returning echo signal from the sensor. The ASM designed uses 8 states (states 0 to 7) to classify the echo from the ultrasonic sensor using the technique of iteratively transitioning through the states as the system waits for the echoed signal. In this way, the further the ASM goes through the states, the fewer LEDs light up.

As the system keeps measuring every 100 ms (10 times per second) it becomes easy to see the increase or decrease on the distances measured with the sensor.

4.1 Ultrasonic Distance Sensor

The sensor to be used on this application is the HC-SR04, which is illustrated with the following Figure 1.

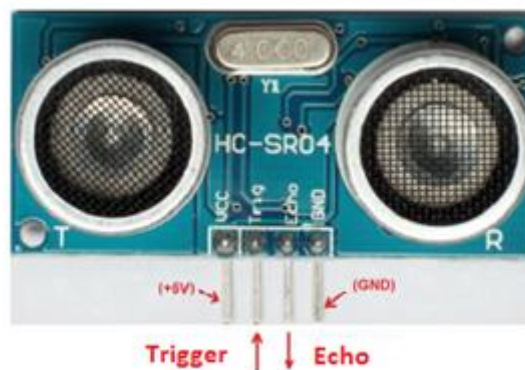

Figure 1: Ultrasonic Sensor Used on The Project

The sensor uses a 5 V source on the leftmost pin and the GND connection on the rightmost pin. It has one input, which is the trigger signal, and one output, which is the echo signal. The GreenPAK generates an appropriate trigger pulse for the sensor (10 μ s according to the datasheet of the sensor) and measures the corresponding echo pulse signal (proportional to the distance measured) provided by the sensor.

All the logic is set within the GreenPAK using the ASM, delay blocks, counters, oscillators, D flip-flops and one-shot components. The components are used to generate the required input trigger

Digital Distance Measurement with Ultrasonic Sensor Interface

pulse for the ultrasonic sensor and classify the returning echo pulse proportional to the distance measured into distance zones as detailed in the following sections.

The connections needed for the project are shown in [Figure 2](#).

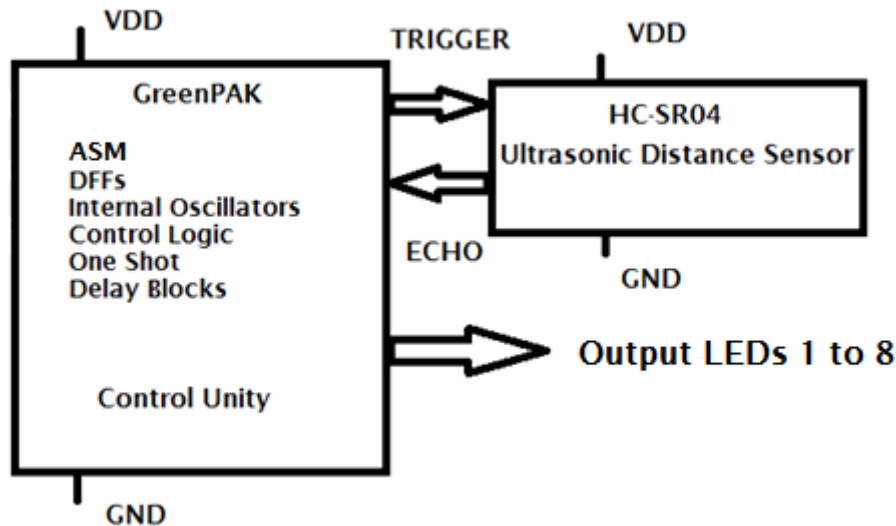

Figure 2: Interface System Design and Connections

The input trigger requested by the sensor is an output generated by the GreenPAK, and the echo output of the sensor is used to measure the distance by the GreenPAK. The internal signals of the system will drive a one-shot component to generate the required pulse to trigger the sensor and the returning echo will be classified, using D flip-flops, logic blocks (LUT and inverter), and a counter block, into the 8 distance zones. The D flip-flops at the end will hold the classification on the output LEDs until the next measure is done (10 measures per second).

4.2 Realization with GreenPAK Designer

This design will demonstrate the state machine functionality of the GreenPAK. Since there are eight states within the proposed state machine, the GreenPAK SLG46537 is appropriate for the application. The machine was designed on the GreenPAK Designer software as shown in [Figure 3](#), and the outputs definitions are set on the RAM diagram of [Figure 4](#).

Digital Distance Measurement with Ultrasonic Sensor Interface

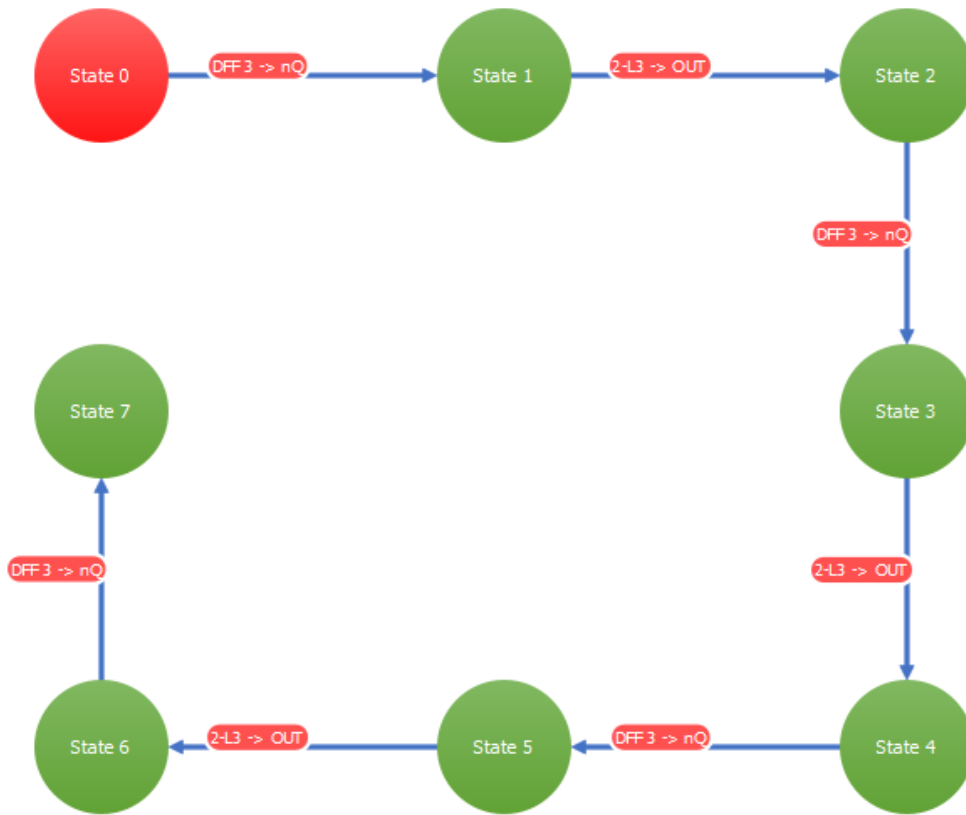

Figure 3: GreenPAK ASM Used as a Synchronous FSM

State name	Connection Matrix Output RAM							
	OUT7	OUT6	OUT5	OUT4	OUT3	OUT2	OUT1	OUT0
State 0	1	1	1	1	1	1	1	1
State 1	1	1	1	1	1	1	1	0
State 2	1	1	1	1	1	1	0	0
State 3	1	1	1	1	1	0	0	0
State 4	1	1	1	1	0	0	0	0
State 5	1	1	1	0	0	0	0	0
State 6	1	1	0	0	0	0	0	0
State 7	1	0	0	0	0	0	0	0

Figure 4: Output RAM Connections

The full diagram of the circuit designed for the application can be seen in [Figure 5](#). The blocks and their functionalities are described after the [Figure 5](#).

Digital Distance Measurement with Ultrasonic Sensor Interface

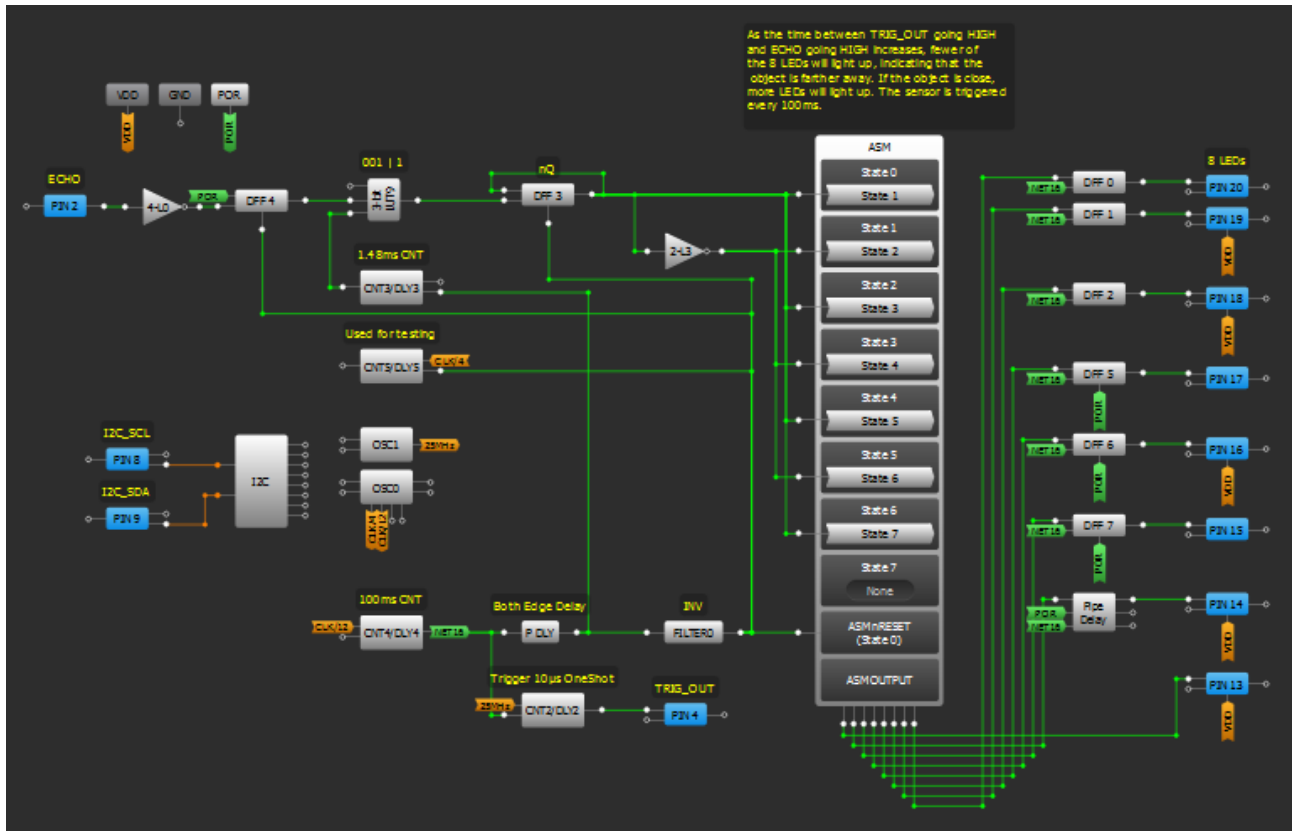

Figure 5: Full Circuit Diagram Designed as Interface for The Ultrasonic Distance Sensor

As can be seen in [Figure 3](#), [Figure 4](#) and [Figure 5](#), the system is designed to work in sequential-state order to generate a 10 us trigger pulse for the ultrasonic distance sensor, using CNT2/DLY2 block as a one-shot component together with the 25 MHz clock from OSC1 CLK, to generate the signal on PIN4 TRIG_OUT output. This one-shot component is triggered by the CNT4/DLY4 counter block (OSC0 CLK/12 = 2kHz clock) every 100 ms, triggering the sensor 10 times per second.

The echo signal, whose latency is proportional to the distance measured, comes from the PIN2 ECHO input. The set of components DFF4 and DFF4, CNT3/DLY3, LUT9 create the lag to follow through the states of the ASM. As can be seen in [Figure 3](#) and [Figure 4](#), the further the system traverses through the states, the fewer outputs are triggered.

The steps of the distance zones are of 1.48 ms (echo signal), which is proportional to 0.25 cm increments, as shown on the following equation. That way we have 8 distance zones, from 0 to 2 m in 25 cm steps, as shown on [Table 1](#).

$$v = \frac{\Delta S}{\Delta t} \rightarrow \frac{2 * 0.25m}{echo_{25cm}(s)} = 340 \frac{m}{s} \rightarrow echo_{25cm} \cong 1.48ms$$

Digital Distance Measurement with Ultrasonic Sensor Interface

Table 1: Classification of Distances Measured on Output LEDs

Distance Zone	Distance Measured “D”	Number LEDs ON
1	$D > 175\text{cm}$	1
2	$150\text{cm} < D < 175\text{cm}$	2
3	$125\text{cm} < D < 150\text{cm}$	3
4	$100\text{cm} < D < 125\text{cm}$	4
5	$75\text{cm} < D < 100\text{cm}$	5
6	$50\text{cm} < D < 75\text{cm}$	6
7	$25\text{cm} < D < 50\text{cm}$	7
8	$D < 25\text{cm}$	8

5 Results

To test the design, the configuration used on the emulation tool provided by the software can be seen in Figure 6. The connections on the pins of the emulation software can be seen after it on Table 2.

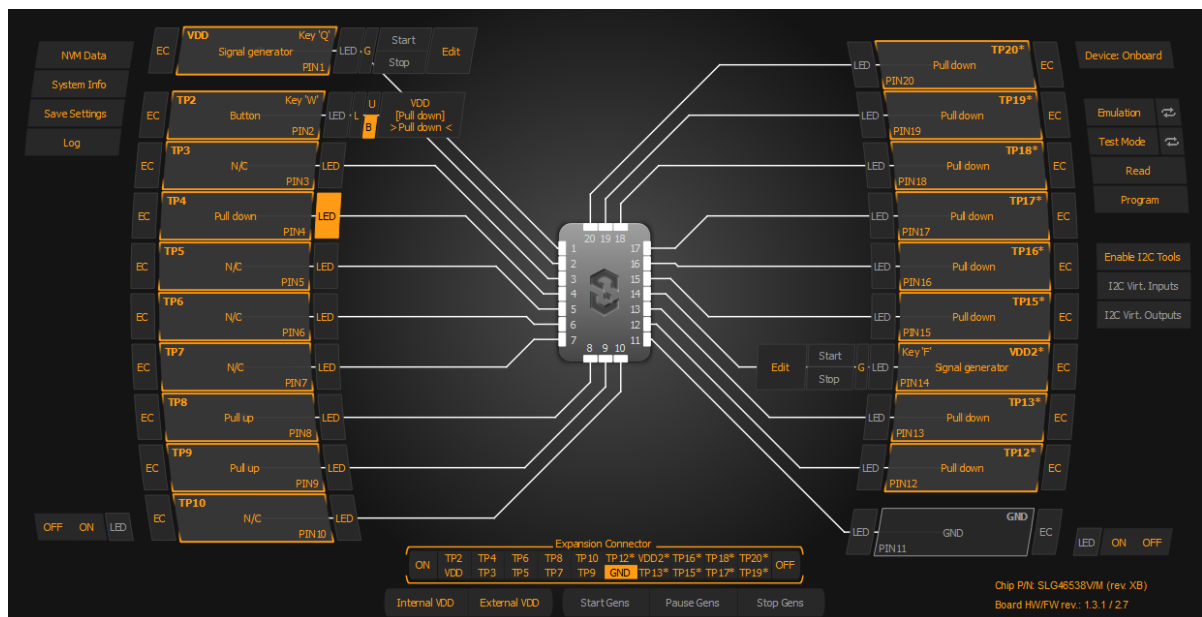

Figure 6: Emulation Tool Configuration for Testing in GreenPAK Designer Software

Digital Distance Measurement with Ultrasonic Sensor Interface

Table 2: Connection of GreenPAK Pins and Design Signals

Pin Number	Test Point Number	Connection Description
1	TP1	VDD
2	TP2	ECHO
3	TP3	N/C
4	TP4	TRIG_OUT
5	TP5	N/C
6	TP6	N/C
7	TP7	N/C
8	TP8	I2C
9	TP9	I2C
10	TP10	N/C
11	TP11	GND
12	TP12	NC
13	TP13	LED1
14	TP14	LED2
15	TP15	LED3
16	TP16	LED4
17	TP17	LED5
18	TP18	LED6
19	TP19	LED7
20	TP20	LED8

The emulation tests show that the design works as expected by providing an interface system to interact with the ultrasonic sensor. The emulation tool provided by GreenPAK proved itself a great simulation tool to test the design logic without programming the chip and a good environment to integrate the development process.

The circuit tests were made using an external 5 V source (also designed and developed by the author) in order to provide the nominal sensor voltage. [Figure 7](#) shows the external source used (0-20 V external source).

Digital Distance Measurement with Ultrasonic Sensor Interface



Figure 7: External Voltage Source Used

To test the circuit, the echo output from the sensor was connected on the input of PIN2 and the trigger input was connected on PIN4. With that connection, we could test the circuit for each one of the ranges of distance specified on [Table 1](#) and the results were as follows in [Figure 8](#), [Figure 9](#), [Figure 10](#), [Figure 11](#), [Figure 12](#), [Figure 13](#), [Figure 14](#), [Figure 15](#) and [Figure 16](#).

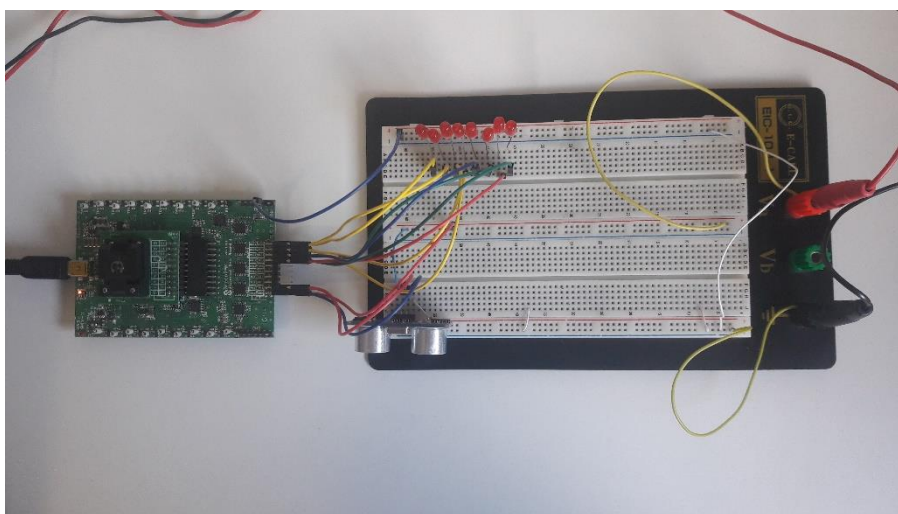

Figure 8: Circuit Test Measuring on Turned Off

Digital Distance Measurement with Ultrasonic Sensor Interface

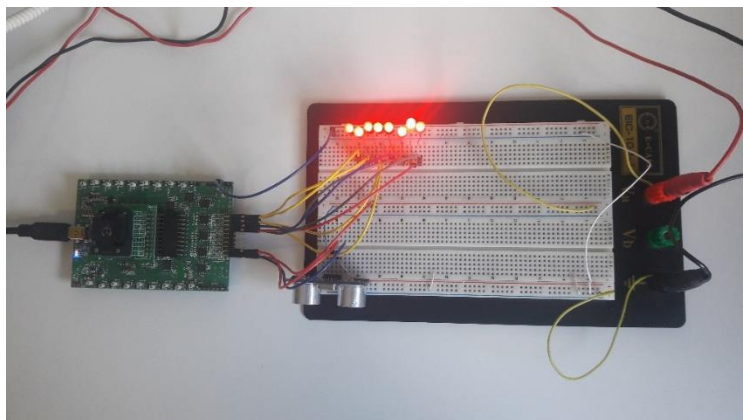

Figure 9: Circuit Test Measuring Distance D Within the Range 8: $D < 25$ cm

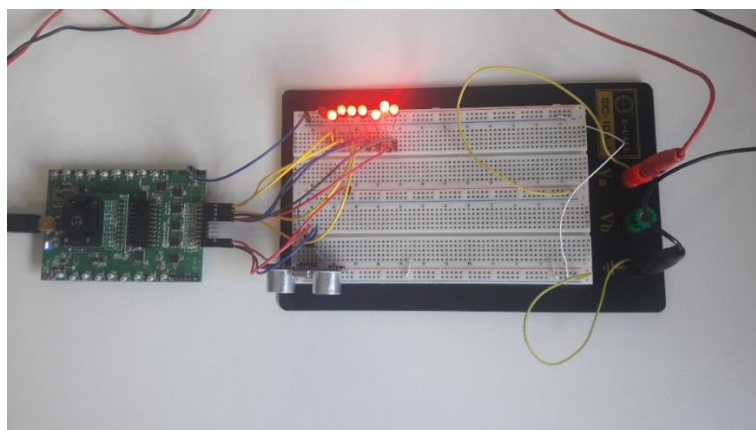

Figure 10: Circuit Test Measuring Distance D Within the Range 7: $25 \text{ cm} < D < 50$ cm

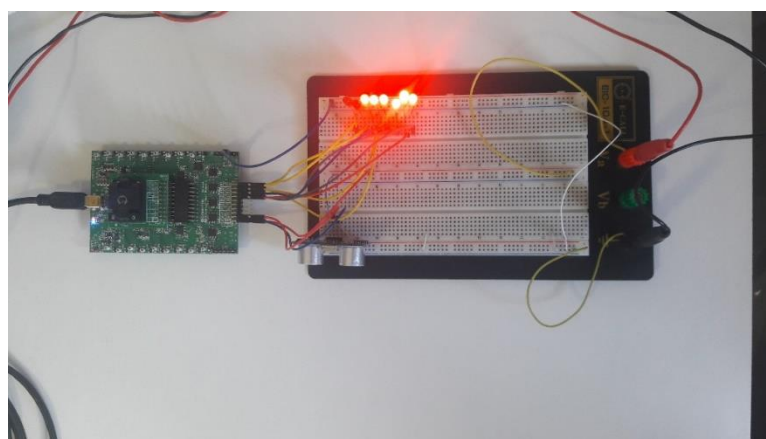

Figure 11: Circuit Test Measuring Distance D Within the Range 6: $50 \text{ cm} < D < 75$ cm

Digital Distance Measurement with Ultrasonic Sensor Interface

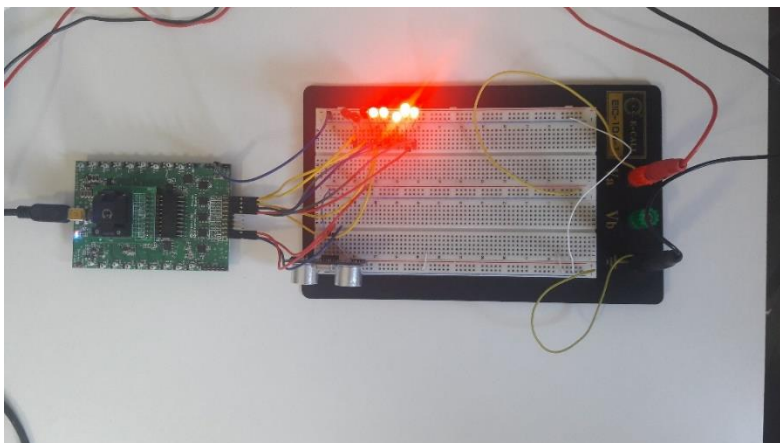

Figure 12: Circuit Test Measuring Distance D Within the Range 5: $75\text{ cm} < D < 100\text{ cm}$

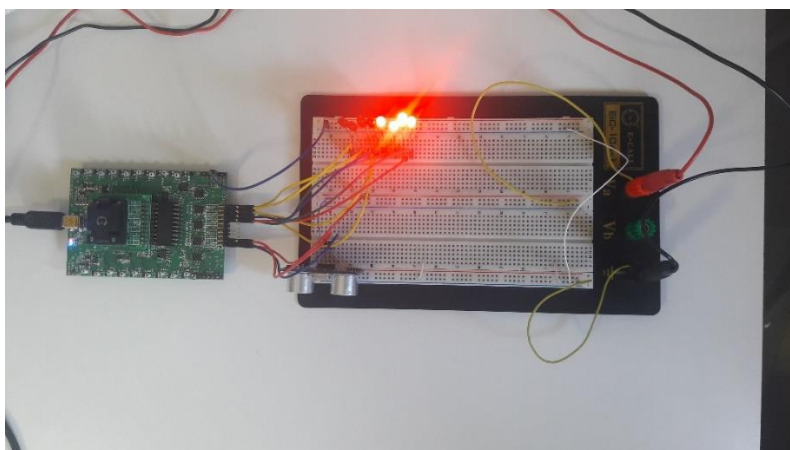

Figure 13: Circuit Test Measuring Distance D Within the Range 4: $100\text{ cm} < D < 125\text{ cm}$

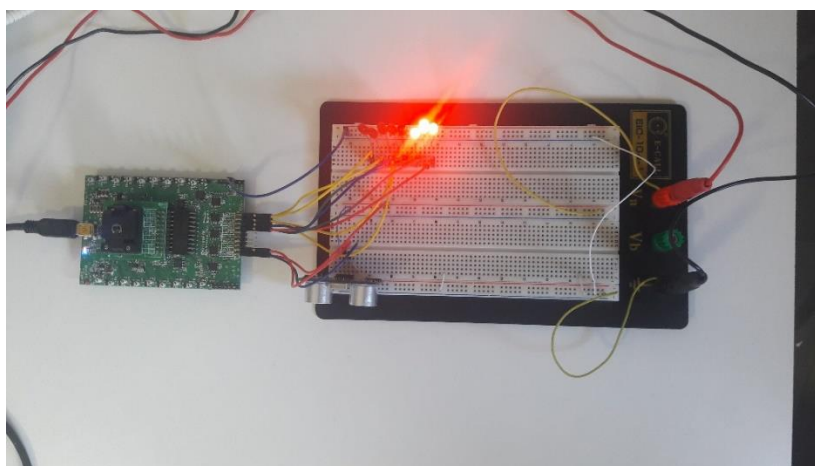

Figure 14: Circuit Test Measuring Distance D Within the Range 3: $125\text{ cm} < D < 150\text{ cm}$

Digital Distance Measurement with Ultrasonic Sensor Interface

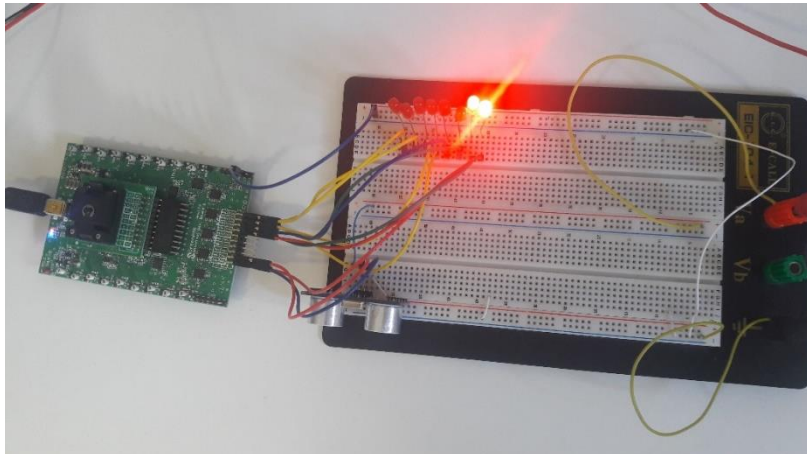

Figure 15: Circuit Test Measuring Distance D Within the Range 2: $150\text{ cm} < D < 175\text{ cm}$

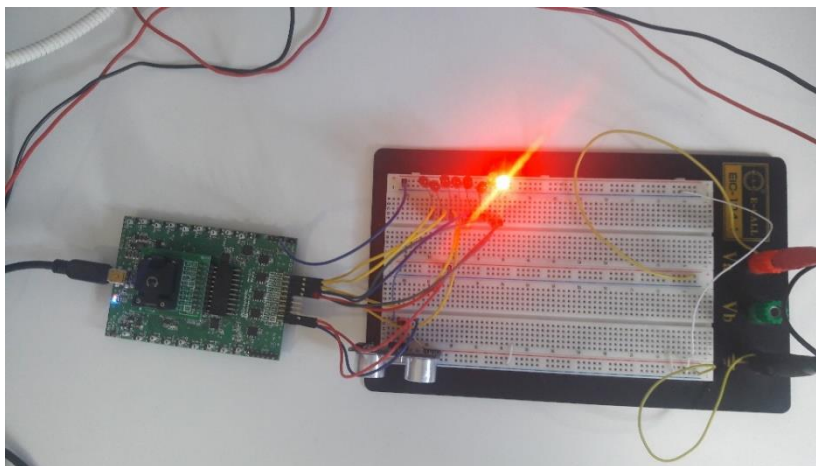

Figure 16: Circuit Test Measuring Distance D Within the Range 1: $D > 175\text{ cm}$

The results prove that the circuit works as expected, and the GreenPAK module is capable of acting as the interface for the ultrasonic distance sensor. From the tests, the circuit designed could use the state machine and the internal components to generate the required trigger pulse and classify the returning echo lag into the categories specified (with 25 cm steps). These measurements were made with the system online, measuring every 100 ms (10 times per second), showing that the circuit works well for continuous distance measuring applications, such as car parking assisting devices and so on.

5.1 Possible Additions

To implement further improvements on the project, the designer could increase the distance to encapsulate the entire ultrasonic sensor range (we are currently capable of classifying half of the range from 0 m to 2 m, and the complete range is from 0 m to 4 m). Another possible improvement would be to convert the distance measured echo pulse to be displayed in BCD displays or LCD displays.

Digital Distance Measurement with Ultrasonic Sensor Interface

6 Conclusion

In this app note a digital ultrasonic distance sensor was implemented using the GreenPAK module as a control unit to drive the sensor and interpret its echo pulse output. The GreenPAK implements an ASM along with several other internal components to drive the system.

The GreenPAK development software and development board proved to be excellent tools for fast prototyping and simulation during the development process. The GreenPAK's internal resources, including the ASM, oscillators, logic, and GPIOs were easy to configure to implement the desired functionality for this design.

**Digital Distance Measurement with Ultrasonic
Sensor Interface****Revision History**

Revision	Date	Description
1.0	06-Mar-2018	Initial version

IMPORTANT NOTICE AND DISCLAIMER

RENESAS ELECTRONICS CORPORATION AND ITS SUBSIDIARIES (“RENESAS”) PROVIDES TECHNICAL SPECIFICATIONS AND RELIABILITY DATA (INCLUDING DATASHEETS), DESIGN RESOURCES (INCLUDING REFERENCE DESIGNS), APPLICATION OR OTHER DESIGN ADVICE, WEB TOOLS, SAFETY INFORMATION, AND OTHER RESOURCES “AS IS” AND WITH ALL FAULTS, AND DISCLAIMS ALL WARRANTIES, EXPRESS OR IMPLIED, INCLUDING, WITHOUT LIMITATION, ANY IMPLIED WARRANTIES OF MERCHANTABILITY, FITNESS FOR A PARTICULAR PURPOSE, OR NON-INFRINGEMENT OF THIRD-PARTY INTELLECTUAL PROPERTY RIGHTS.

These resources are intended for developers who are designing with Renesas products. You are solely responsible for (1) selecting the appropriate products for your application, (2) designing, validating, and testing your application, and (3) ensuring your application meets applicable standards, and any other safety, security, or other requirements. These resources are subject to change without notice. Renesas grants you permission to use these resources only to develop an application that uses Renesas products. Other reproduction or use of these resources is strictly prohibited. No license is granted to any other Renesas intellectual property or to any third-party intellectual property. Renesas disclaims responsibility for, and you will fully indemnify Renesas and its representatives against, any claims, damages, costs, losses, or liabilities arising from your use of these resources. Renesas' products are provided only subject to Renesas' Terms and Conditions of Sale or other applicable terms agreed to in writing. No use of any Renesas resources expands or otherwise alters any applicable warranties or warranty disclaimers for these products.

(Disclaimer Rev.1.01 Jan 2024)

Corporate Headquarters

TOYOSU FORESIA, 3-2-24 Toyosu,
Koto-ku, Tokyo 135-0061, Japan
www.renesas.com

Trademarks

Renesas and the Renesas logo are trademarks of Renesas Electronics Corporation. All trademarks and registered trademarks are the property of their respective owners.

Contact Information

For further information on a product, technology, the most up-to-date version of a document, or your nearest sales office, please visit www.renesas.com/contact-us/.